

*Matrix III*

*The Psycho-Social, Chemical, Biological  
and Electromagnetic Manipulation  
of Human Consciousness  
Volume One*

By  
Valdamar Valerian

First Edition Printing  
*May 1992*

Cover Art © 1992 by Valdamar Valerian. Reproduction of the cover in any form is prohibited without consent from *Leading Edge Research*. All Rights Reserved.

*MATRIX III Volume One*

Copyright 1992 by Valdamar Valerian, in association with *Leading Edge Research*.

All Rights Reserved. No part of this work may be reproduced or transmitted in any form by any means, electronic or mechanical, including photocopying and recording, or by any information storage or retrieval system, except by written permission of the author and *Leading Edge Research Group*. Published by *Leading Edge Research Group*, P.O. Box 7530, Yelm, Washington State, C.F. 98597 C.F.









M A T R I X I I I

TABLE OF CONTENTS

<i>Description</i>	<i>Page</i>
Introduction by Michael Topper .....	i
Forward .....	1
<b>CHAPTER 1: BASIC SCIENTIFIC CONCEPTS AND KNOWLEDGE ...</b>	<b>7</b>
Standing Waves and Oscillators .....	7
Resonant Systems .....	7
Rhythm Entrainment and Coherency .....	8
Capacitance and Attenuation .....	8
Free Radicals .....	9
Chart: Physics of Frequency and Vibration .	10
Chart: Coherence and Incoherence .....	11
Chart: Resonance Response Rate .....	11
Human Etheric Structures .....	12
Chart: Human Auric Band Structures .....	13
Telepathic Activity .....	15
Mental Telepathy .....	16
Intuitional Telepathy .....	17
Group Telepathic Work .....	17
Induction of Telepathic States by Substance	18
Telepathic Sensitivity .....	18
Telepathic Receiving States .....	19
Telepathic Reception .....	19
Factors For Successful Telepathic Work ....	21
Physical Theories of Telepathy .....	22
<b>CHAPTER 2: NATURAL FIELDS AND PHYSICS .....</b>	<b>24</b>
Holographic Field Aspects of the Universe .	24
A Look at Human Memory .....	25
Fourier Transformation of Brain Waveforms .	28
The Visual System of the Brain .....	28
Fourier Transformation Equations .....	29
Other Physical Senses and Fourier Trans ...	38
Holographic Aspects of Particles and Waves.	38
Quantum Level Connectedness .....	39
The Concept of Non-Locality .....	39
The Concept of Order .....	40
Holographic Aspects of Consciousness .....	40
Holographic Aspects of Perception .....	41
Range of Body Frequencies .....	41
Other Aspects of the Human Energy Field ...	42
Multiple Personalities and Holograms .....	44
Concept of Holographic Inserts .....	44
Morphological Field Dynamics .....	45
Ionospheric Cavity Resonance Frequencies ..	47
Geomagnetic Field Characteristics .....	48
Natural Electric Fields and Micropulsation.	50
Geomagnetic Field Variations .....	50
Geomagnetic Polarity Reversals .....	51
Magnetic Symmetry of Organic Life Forms ...	52
Circadian Rhythms .....	53
Biological Enzymes and Magnetic Fields ....	53
Magnetic Field Shielding .....	55
Human Brain EEG Signals .....	55

M A T R I X I I I

TABLE OF CONTENTS

<u>Description</u>	<u>Page</u>
Unusual Characteristics of Water .....	55
Database on Frequencies .....	56B
 CHAPTER 3: NEUROLOGICAL BRAIN CIRCUITRY, EVOLUTION, AND STATES OF CONSCIOUSNESS .....	 57
Diagram: Brain and Spinal Nerves .....	58
White and Grey Neural Matter .....	59
Diagram: Neural Architecture .....	60
The First Brain Structure and Operation ...	62
Diagram: Structural Areas of the Brain ....	63
Imprints .....	64
Opiate Drugs and Population Management ....	65
Reimprinting the First Circuit .....	65
First Circuit Dualities .....	67
The 2nd Brain Structure and Operation .....	67
Second Circuit Imprints.....	72
Second Circuit Dualities .....	72
The 3rd Brain Structure and Operation .....	72
3rd Circuit Dualities .....	75
The 4th Brain Structure and Operation .....	75
4th Circuit Dualities .....	79
The 5th Brain Structure and Operation .....	79
The 6th Brain Structure and Operation .....	82
The 7th Brain Structure and Operation .....	86
A Model of Dimensional Consciousness .....	87
Diagram: Hyperspatial Acceleration of Mass. 90	90
Circuitry Charts.....	91
Related Notations .....	96
 CHAPTER 4: PSYCHO-SOCIAL ASPECTS OF POPULATION .....	 100
Level 1 .....	100
Belief Systems and Perception .....	100
The Aspect of Is-ness .....	102
The Concept of Premature Certainty .....	103
Multiple Personalities .....	104
Security, Sensation and Power Functions ...	104
Addiction to Security, Sensation and Power. 105	105
Projection and Responsibility .....	105
Perspectives in Projection .....	105
Media Encouragement of Projection .....	106
Bio-social Filters of Consciousness .....	106
The Triple Dualisms Within Society .....	107
Behavior Modification and Education Systems 108	108
Culturally Conditioned Human "Learning" ...	110
Level 2 .....	111
Level 3 .....	116
Level 4 .....	119
Multi-Density Electronic Manipulation .....	119
Devices .....	120
Embedded Entities .....	121
Directive Electronic Ridge Implants .....	122

# M A T R I X I I I

## TABLE OF CONTENTS

<i>Description</i>	<i>Page</i>
<b>CHAPTER 5: POPULATION MANAGEMENT THROUGH THE USE OF</b>	
<b>CHEMICAL AND METALLIC SUBSTANCES .....</b>	<b>124</b>
The Use of Fluoride Compounds.....	124
Environmental Pollution By Fluorides .....	124
The Fluoride Gambit .....	126
The Use of Fluorides for Mind Control .....	129
Fluoride Compounds and Young Children .....	129
Fluorides Outside The United States .....	134
A Congressional Statement on Fluorides ....	135
The Use of Chlorine Gas in Water Supplies .	135
The Use of Nitrates in the Food Supply ....	136
Exportation of Dangerous Pesticides & Drugs	137
Direct Addition of Chemicals to the Food ..	137
Bombardment of the Food With Radiation ....	140
Environmental Chemicals .....	141
The Use of Aluminum as a Psychological Control Over Behavior and Consciousness ...	142
Irradiated Food Products .....	142B
Alternative Fluoride-Free Products .....	142C
Pharmaceutical Products and Aluminum .....	144
Neurological Effects of Aluminum Poisoning	144
Major Sources of Fluoride and Aluminum ....	146
Remedies for Harmful Metals .....	147
Drugs and Societal Manipulation & Control .	148
The CIA and Drug Trafficking .....	148
Tobacco: What's Really in Your Cigarettes .	150
Other Culturally Promoted Drugs .....	153
Drugs and Mind Control Applications .....	154
Sociological Trends .....	156
Nitrates in Soil and Water .....	158
Mercury Poisoning and Dental Use .....	162
 <b>CHAPTER 6: POPULATION MANAGEMENT THROUGH THE USE</b>	
<b>OF BIOLOGICAL ORGANISMS .....</b>	<b>163</b>
The Concept of "Infectious Disease" .....	163
Pleomorphic Life Forms .....	163
The Immunization Gambit .....	165
Judicial Awards for Vaccine-Caused Injury .	165
The Smallpox Gambit .....	166
Polio Vaccine .....	167
Influenza Vaccine .....	168
The Great Swine Flu Massacre of 1976 .....	169
Smallpox Vaccine and Cancer .....	170
Covert Research in Biological Weapons for Population Management .....	171
Population Control, Condom Use and AIDS ...	177
Drug "Testing" on Prison Populations .....	177
Tactical Weapons of Biological Warfare used for Population Management .....	179
 <b>SUPPLEMENTARY MATERIAL FOR CHAPTER 6</b>	
World War II Plans for Biological Warfare .	182
Bacteria and Self-Directed Evolution .....	183

M A T R I X I I I

TABLE OF CONTENTS

<u>Description</u>	<u>Page</u>
US Recommendations on Immunization .....	184
Vaccines, Availability and Type in the US .	185
US Health Service Letter to Physicians ....	186
Reportable Events Following Vaccination ...	187
Altered Immunocompetence .....	188
Guidelines for Immune Globulin Vaccines ...	188
Febrile Illnesses and Vaccination .....	189
Immunization and HIV-infected Children ....	189
Adverse Events and DPT Immunizations .....	190
Side Effects and Adverse Reactions .....	191
The Creation of Flu Vaccines: A Gamble ....	192
Influenza Epidemic of 1918 & Military Base	193
Official Recommendations for Flu Control ..	194
Target Groups for Special Vaccination Pgms	196
Anti-viral Agents for Influenza Type A ....	197
Development of Drug Resistant Viruses .....	197
Information Sources on Influenza Control ..	197
Influenza Vaccine: Side Effects/Reactions .	198
Smallpox Vaccine Only for Military .....	199
An Examination of Retroviruses .....	200A
The Politics of Cancer .....	201
How the State Got Involved With Cancer ....	202
Failure of Orthodox Cancer Treatments .....	203
Drug Companies, AZT and DDI & Effects .....	203A
Polio Vaccine and AIDS .....	203B
The Return of Tuberculosis .....	204
Anti-Biotics and Electromagnetic Fields ...	205
The Super TB Bug and Its Spread .....	205
The Neural Fungus .....	205
Tuberculosis Epidemic Surges .....	205A
U.S. Army Plans for 3rd World AIDS Tests ..	206
The Return of Measles .....	206
The US Flu Epidemic of 1991 .....	206
The WHO and New AIDS Vaccine Tests .....	207
Altering the AIDS Virus .....	207
AIDS in the United States: The Numbers ....	208
The New Wave: AIDS, Women and Children ....	208
Dolphins and AIDS .....	208
AIDS Papers Kept Secret by Judge .....	208
Radar: A New Model for Curing AIDS .....	208A
Studies Show AIDS Spreads in Air .....	209
Recent HIV and Heterosexual Intercourse ...	209
The Strecker Memorandum .....	210
Romania Halts Experimental AIDS Drug Use ..	210
The Flu Vaccine and AIDS .....	211
Swine Flu and Guillain-Barre Syndrome .....	212
Desert Stormers and Anthrax: March 1992 ...	213
Viral Causes of Multiple Sclerosis .....	214
Viral Causes of Leukemia .....	214
HIV and Links With African Parasites .....	215
Genetic Causes and Osetoarthritis .....	215
Mass Production of Polio Viruses .....	216
The New Polio Outbreak in Jordon, Feb 1992	216

M A T R I X I I I

TABLE OF CONTENTS

<u>Description</u>	<u>Page</u>
Man Contracts Polio from Childs Diaper . . . .	216
Weapons Lab Salmonella Tests . . . . .	216
AIDS Plague Update . . . . .	217
Congress Slams Misconduct in Med Research .	221
Fungal Warfare in the Medicine Chest . . . . .	222
The Secret of Fungal Poisons . . . . .	223
Airborne Spread of Fungal Disease . . . . .	224
Insect Anti-bodies and Fungal Infection . . .	225
Bush Administration Relaxes Biotec Regs . . .	226
The Pharmaceutical Industry: Profits . . . . .	227
Patient Records as a Profit Source . . . . .	231
Table: Deaths and Selected Causes 1970-1989	233
Table: Death Rates From Cancer 1970-1988	234
Table: AIDS Deaths By Age/Race/Sex 1982-89	235
Table: Heart Disease Deaths 1970-1988	235
Table: Death Rates By Cause, US, 1988	236
VETERINARY BATERIOLOGY . . . . .	237
Mycobacterium Paratuberculosis . . . . .	237
Bacillus Anthracis . . . . .	238
Pasteurella Tularensis . . . . .	241
Clostridium Septicum . . . . .	242
Brucella Group . . . . .	244
Rickettsiae . . . . .	247
Typhus Fevers . . . . .	247
Spotted Fevers . . . . .	249
Tsutsugamushi Fevers . . . . .	249
Trench Fever / Q Fever / Heartwater . . . . .	250
THE VIRUSES . . . . .	251
The Nature of Viruses . . . . .	254
Virus Diseases of Man . . . . .	254
Smallpox / Cowpox . . . . .	254
Alastrim . . . . .	257
Chickenpox . . . . .	257
Herpes Zoster / Herpes Simplex . . . . .	257
Molluscum . . . . .	257
Verruca / Warts . . . . .	258
Rubeola / Measles . . . . .	258
Rubella / German Measles . . . . .	258
Epidemic Influenza . . . . .	258
Lymphogranuloma Venereum . . . . .	260
Rabies or Hydrophobia . . . . .	260
Anterior Poliomyelitis / Infantile Paraly.	261
Epidemic Encephalitis . . . . .	263
Von Economo's Disease . . . . .	263
St. Louis Encephalitis . . . . .	263
Japanese Encephalitis . . . . .	264
Postinfection Encephalitis . . . . .	263
Australian X Disease . . . . .	263
Equine Encephalomyelitis . . . . .	263
Lymphocytic Choriomeningitis . . . . .	264
Yellow Fever . . . . .	264

M A T R I X I I I

TABLE OF CONTENTS

<u>Description</u>	<u>Page</u>
Pappataci Fever, Sandfly Fever .....	264
Phlebotomus Fever .....	264
Dengue / Breakbone Fever .....	265
Rift Valley Fever .....	265
Trachoma .....	265
 EXTRA-HUMAN VIRUS DISEASES .....	 265
Foot-and-Mouth Disease .....	265
Swine Influenza .....	266
Cattle Plague .....	266
Contagious Epithelioma / Fowl Pox .....	267
Hog Cholera .....	267
Myxomatosis .....	267
 Table: Important Virus Diseases of Man ...	 268
Database on the Immune System .....	268B
Types of Immunity / Natural & Acquired ...	269
Immunological Reactions .....	270
Toxins and Antitoxins .....	271
Table: Important Toxins .....	271
Table: Antitoxins and Antisera .....	272
Agglutinogens and Agglutinins .....	272
Precipitinogens and Precipitins .....	273
Cytolysins and Various Phenomena .....	274
Opsonins and Phagocytosis .....	275
Other Antibodies .....	276
Mechanism of Antigen-Antibody Reaction ....	276
Data on Major Chemical and Drug Companies .	278
Glaxo Pharmaceuticals and R & D .....	284
 CHAPTER 7: THE ELECTRONIC MANIPULATION OF POPULATIONS	 285
 Man-made Electromagnetic Fields and Effects	 285
Chart: EM Spectrum and Scales .....	286
Creation of "Safety Standards" .....	287
The University of Washington Study .....	289
Microwaves and Genetic Effects .....	290
Microwaves and Brain Tumors .....	291
ELF Radiation From Powerlines .....	291
Cases of Hazards and No Action .....	294
Modulation is the Secret .....	294
Chart: Information Transfer - Modulation ..	296
Chart: Phase Relationships and Modulation .	297
Chart: Beat Frequencies and Feedback .....	298
Report on Time-Varying Electromagnetics ...	299
References Available to the Public .....	299
Effects of ELF/ULF on Biosystems .....	300
Effects on Humans of ELF/ULF .....	300
U.S.Navy Results of ELF Tests .....	301
Additional ELF Capabilities .....	302
Funding for Military Research into DNA	
Absorption of Microwaves .....	302
Areas of Existing ELF Usage .....	303



M A T R I X I I I

TABLE OF CONTENTS

<i>Description</i>	<i>Page</i>
Natural, Artificial and Tactical ELF .....	303
The Military, the Standard and the Coverup	304
The Ground-Wave Emergency Network (GWEN) ..	305
Chart: The National Microwave Gridwork ....	306
Application of Military Frequency Weaponry.	307
Frequency Weapons of the British in 1982 ..	307
Deliberate Experimentation by Military ....	308
ADVANCED MIND-CONTROL APPLICATIONS .....	308
Internal Cross-Referencing Guide .....	308
Psychology Behind Mind Control and Psi-War	308
Chart: Schools of Thought Behind Mind Cont.	309
Suppression of Vital Data in Physics .....	309
The Hertzian Conspiracy .....	310
Definitions Within Relativistic Physics....	312
Chart: Significance of Pi and Phi: Pyramids	315
Chart: Non-Linear 2-D Tensor Field Grid ...	315
Chart: Non-Linear 3-D Tensor Field Grid ...	315
The Maxwell Equations and Relativistic Math	316
The Three Orders of Electromagnetics .....	316
Orthodox Science and Tachyons .....	317
Three Electromagnetic Waveforms .....	317
Lesser-known ELF Characteristics .....	317
Chart: Real and Hyperspatial Axes .....	318
Chart: Access To Hyperspatial Domains .....	318
Chart: The Public EM Spectrum .....	318
Chart: The Functional Electromagnetic Spect	319
Chart: The Human Auric Bands and Frequency	320
CONVERSATIONS ON MIND CONTROL- DEC 1991 ...	321
Chart: Loading of the Earth Grid.....	323
Picture: The Delta-T Antenna Setup .....	325
Chart: Earths Power Grid Vortex Matrix ..	332
Chart: Earths Power Grid Vortex Cycles ..	333
Chart: Earths Power Grid Vortex Connection.	334
Chart: Unified Field Grid Vortex Aspects ..	335
Chart: Antematter - Matter Time Spiral ....	335
What is a Unified Field? .....	335
Chart: Fourier Analysis of Enfolded Info ..	336
Chart: Biologically Produced ULF Pulse ....	336
Chart: Electronically Produced ULF Pulse ..	336
Chart: Electromagnetic MKDELTA: Bedsprings.	337
The Secret Electromagnetic Grid.....	337
Chart: Major Frequencies Used In EMC .....	338
Chart: Stages of EMC Programning .....	338
The Crystalline Structure of the Brain ....	339
Chart: Synchronicity and Psychic Phenomena	341
Chart: Synchronicity and Connections .....	341
Chart: Involution - Tachyons to Mass .....	342
Chart: Detail- Tachyons to Mass .....	343
Chart: Unified Field Transformations .....	344
Chart: Physics of the Triad .....	345
The Mechanism of Thought Reception .....	346

M A T R I X I I I

TABLE OF CONTENTS

<u>Description</u>	<u>Page</u>
Mind-Cranium Thought Transduction .....	346
Chart: Sacred Geometry of the Human Skull .	346
Chart: Various Views of the Cranial Cavity	347
Chart: Ionic Crystalline Cranial Structure	348
Chart: Consciousness to Mass Transduction	349
Chart: The Unified Field Triad .....	350
Chart: Hyperspace and Ultraspace Fields ...	351
Chart: Physics of Unified Field Devices ...	351B
Chart: Consciousness and Energy Spectrum ..	352
 SUPPLEMENTARY MATERIAL FOR CHAPTER 7	
Cellular Telephone Networks Plan Increase .	353
Voices on TV Cause Seizures in Person .....	353
Pulsed Magnetic Fields and Protein Synth ..	353
Cellular Networks Upgrading to Digital .....	354
The Biological Connection to Non-Hertzian	
Scalar Energy .....	355
Interview With Alfred Bielek .....	366
Electromagnetic Fields and Epidemiology ...	372
Electronic Stimulation of the Brain .....	373
Electromagnetic Radiation Effect Extracts .	375
Electromagnetic Interaction With the CNS ..	386
DNA Transcription and ELF Radiation .....	393
Growing Hazards of EM Radiation .....	394
Dept of Health EM Information Sheet .....	396
Table: Non-ionizing EM Radiation Standards	397
Research Needs for EM Field Reduction .....	398
Project Scanate .....	419A
Mind Control and the White House.....	419A
Project River Styx .....	419B
Chart: Electronic Mind Control Projects ...	420
Chart: Electronic Mind Control Projects ...	421
CIA Mind Control Research Projects .....	421B
Orion Technology and Other Secret Projects	423
Chart: Spherical Biological Implant Device	446
Interview With Duncan Cameron and	
Preston Nichols .....	472
Second Interview With Alfred Bielek 1991 .	478
Radiosondes : Background and Operations ..	482
 CHAPTER 8: A FRAMEWORK IN WHICH TO VIEW ALL THIS ....	 487
 UFOs and the Positive and Negative Realms	 488
Precis on the Good and the Bad .....	514
What is "Christ Consciousness"? .....	538B
Universal Truth Maps Governing Positive	
and Negative Evolution .....	538G
 CHAPTER 9: THE "FINAL SCENARIO" : AN OVERVIEW .....	 539
Warning and Advisory for Chapter 9 .....	539B
Forms of Government & Planetary Situation.	539C
The Thousand Year Reich - First 50 Years .	540
The Secret History of George Bush .....	563

M A T R I X I I I

TABLE OF CONTENTS

<u>Description</u>	<u>Page</u>
The Empire of Prescott Bush .....	563
Chart: The Bush Family Tree .....	564
Bert Walker and Harriman .....	566
The Bush Family and the Hitler Project ...	569
Hitlers Ladder To Power .....	572
Control of Nazi Commerce .....	573
Race Hygiene: The Bush Family Alliances ..	576
George Bush and William Farish .....	576
The Congress on Eugenics .....	578
George Bush and General William Draper ...	579
George Bush and Boyden Grey .....	581
The Worldwide Sterilization Movement .....	582
Insert: Rapist Chooses Castration .....	585
Insert: Scientists for Sterilization 1991	586
Jupiter Island: Reorganizing the Government	588
Forrestal's Murder .....	592
George Bush and the Silver Spoon .....	597
George Bush and Secret Societies .....	599
Falsification of CIA History .....	602
The Real George Bush in World War II .....	605
Skull and Bones: Racist Nightmare at Yale .	610
Skull and Bones and the Opium Empire .....	611
Leading Bonesmen Through History .....	612
George Bush , Oil Tycoon .....	617
The Kennedy Assassination .....	627
The De Mohrenschildt Connection .....	628
Bush, the CIA and Kennedy .....	630
Diagram Showing Theory of Planetary Control	631A
William Clinton Caught in Cocaine Network .	631A5
Assassinations in Europe - March 1992 .....	631A7
The Virginia Death Law: Involuntary Killing.	631A8
The Plan of the New World Order .....	631B
The Noahide Laws: Basis for New Religion? .	631C2
A Chronology of Significant Events .....	631D
Excerpt: Brzezinski's Technotronic Era ....	631N
Approximation of Planetary Drug Movements .	631O
Planetary Control: The Upper Hierarchy ....	631P
British Corporate Influence: A Chart .....	631Q
Interface Companies & Interests .....	631R
Focus: Manuel Noriega .....	631S
Interview With Bo Gritz: Doping of America.	631T
Charts: Derivation of the New World Order ..	632
The Conspiracy: Updated .....	637A
Silent Weapons for Quiet Wars .....	637M
Charts: The CFR/Trilateral Connection .....	638
 SUPPLEMENTARY MATERIAL TO CHAPTER 9	
Skull and Bones Society Coverup .....	640
CIA Chief George Bush Supresses News .....	641
CIA Links To The S&L Scandal .....	641
CIA Guidelines on Contact With Journalists	641
CIA Links With Mexican Drugs : DEA Report	642
The Iran-Contra Hearing: An Excerpt .....	642

M A T R I X I I I

TABLE OF CONTENTS

<u>Description</u>	<u>Page</u>
CIA Funded University Programs .....	643
Anti-Gun Ownership Propaganda .....	644
Coleman Tapes: Genealogy of Tyrants .....	648
Neil Bush and the S&L Scandal .....	648
The October Surprise: Reagan and Bush ....	649
US Rules Death Penalty for Incompetents ..	650
The Pentagons Goal: World Policeman .....	651
George W. Bush and the Stock Deal .....	651
CIA Connections to the BCCI Scandal .....	652
Warnings About BCCI Ignored by US Justice	652
BCCI and International Terrorism and Drugs	652
US Building Concentration Camps in Oregon	653
The National Reconnaissance Office .....	653B1
MIT, Cold Fusion and Suppression .....	653B2
Secret Alliances of the CIA .....	654
The Fascist Agenda For the 1990's .....	673
The Bombing of Pan Am 103 .....	674
Syrian Drug Dealers, CIA and Pan Am 103 ..	677A
Extract from the Cyclopedia of Fraternity.	679
The Sovereign Military Order of Malta ....	680
New Europe in the New World Order .....	682
Cloning and the New World Order .....	683
The Earth Grid and the New World Order ...	684
Connections Between the Vatican and Masonry	685
The Order: Connections to Phi Beta Kappa	686
Order of St. John of Jerusalem: A Denial	689
 CHAPTER 10: PATHWAYS TO HIGHER CONSCIOUSNESS .....	 691
Disciplines Producing Non-Dual Consciousness	691
Truth .....	692
Realizations .....	692
How It Works: A Transitional Chart .....	697
 Recommendations For Further Reading .....	 698
MATRIX II: A Description .....	699
About Leading Edge Research Group .....	700
MASTER INDEX TO MATRIX III .....	701

Special Note: The pagination of this book is similar to that in Matrix II in that "alpha" pages are used; throughout the book you will see alpha pages (ex: 102-A, 102-B) in addition to the regularly labeled pages. The result of this is that the actual number of pages in the book (897) exceeds the number of pages indicated by the regular page numbers.

REPRODUCTION PROHIBITED

*I would imagine if you spent 1000 hours working on a project, you would want a fair return on your energy; you are asked to honor that principle; if someone asks you for a copy of your Matrix III, you can politely decline; they can save their money too...buy one, and make an investment in themselves and their future.*

## INTRODUCTION BY MT:

# In the Presence of The Elusive Paradigm

Presently we hear the call from many fronts; the synchronous conclusion emanating from all the basic fields of human endeavor seems to proclaim with unanimous Voice: what is needed, what is absolutely *essential*, is that nothing short of a *New Paradigm* be achieved.

In the exigent face of worldwide poverty, exploitation and widespread brutalism, in confrontation with the clutching need to effect a halt and even reversal of the fateful damage done the earth-lungs of the rainforest and the atmospheric epidermis of the ozone layer, what can be so “hold-the-presses” *pressing* about the requirements of an abstract consideration such as that of the *paradigm*?

After all, what is a “paradigm”? Isn’t it merely the remote requirement of updated *theory*, sufficiently all-purpose to loan itself to the obscure broodings of a variety of academic disciplines about which the public couldn’t be less concerned, except where it incidentally shows in some consumer good or service?

Indeed when such an “academic” subject does manage to bleed into the peripheries of public perception it tends to be interpreted, by “New Age” popularization, as a kind of Big Theory mystically granting grand overviews and magic-carpet rides to the outskirts of the Possible. At the same time it takes on a *mythic* cast, by virtue of that very flow-line whereby the public acquires the notion obliquely from the academic cloister; “paradigm” is *always* something that seems to be *needed*, a goal of aspiration like the grael-cup, and is never something which is conveniently present and accounted for (i.e. as “theory” it retains an aura of remote abstraction, eternally over-the-horizon of those shared fields of refractory experience).

Interestingly enough, it would seem that in the Strange Case of the Paradigm the dim and dissolving lines actually obtaining between highbrow, lowbrow and *lumpen* have seen this popularized interpretation (equating “paradigm” with “theory”) *leak right back* into the academic and scientific community thereby appreciably affecting the very grasp of those traditionally expected to be pollinators of the paradigm.

Tap an academic on the shoulder these days, and he’s quite liable to give the New Age “definition” in response to the query “what is a paradigm?” “Why it’s the Big Theory, the Grand Viewpoint, the New Worldview—you know, like Darwinism, like relativity, like Freudianism. In the one case the theory’s ‘survival of the fittest’, in the other ‘ $E=MC^2$ ’, and ‘the Oedipal Complex’. It’s a great Idea in which facts that didn’t fit well in the former context are made to feel at home, indeed may be cordially considered essential.” So our academic, our member-in-good-standing of the priesthood of particle physicists or molecular biologists, takes up the torch of Paradigm with noblesse oblige on behalf of the public scarcely noticing the flambeau has been returned to him considerably modified from its short public loan. In falling absent-mindedly into conformance with the aggregate public (i.e. New Age) notion, however, our academic is inadvertently committing a very fateful *petitio principii*. He is *assuming* precisely what has to be proved; he’s putting the proverbial cart before the proverbial horse. How so?

## **Watch That Middle Step: It’s a Whopper**

As with all good professionals in any field, the professionals of the life- and political- and technical sciences (once sensing some rewardable premium has been placed upon the production of a

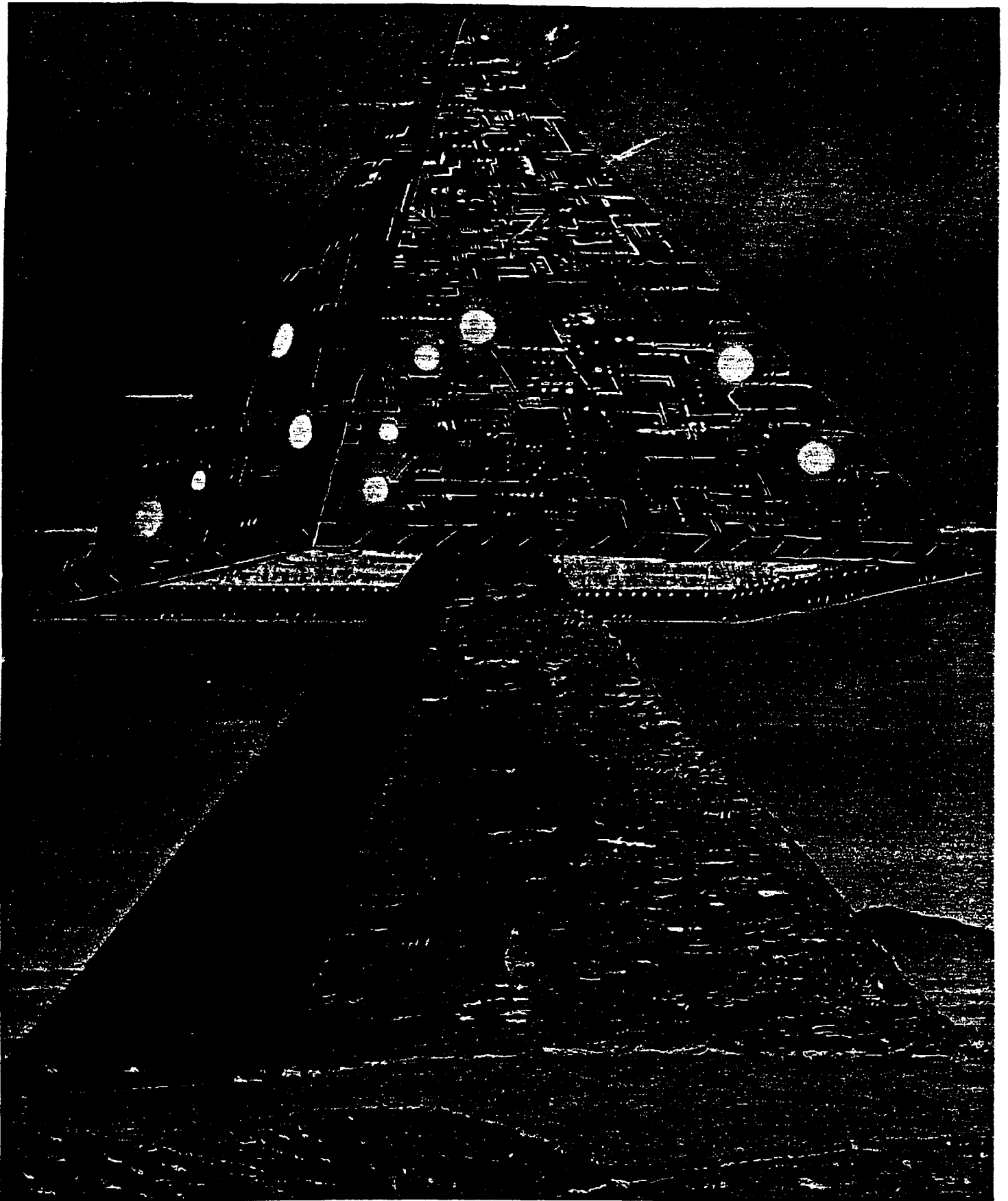

targeted value) erupt in an intramural frenzy of competition sending every self-qualified aspirant to the boards to ink-in that definitive Paradigm. Sliding right along on the lubricating feed-back distortion of the popularizing Psyche, the concept of Paradigm merges seamlessly into the standard notion of Theory, even for those specialists from whose fields the term was first appropriated.

**The trouble is, Paradigm is *not* the equivalent of Theory.**

To take “theory” for “paradigm” is, as we shall see, the same as deleting the most important step in a linear equation. To derive a *theory* one must first have a pattern or *Model* to which the theory is to apply. The *theory* must solve for the *model*. Yet such a pattern is the *Paradigm*. Paradigm indicates the sufficient *Model*; it gives the indispensable *example* in the first place.

Why is this so important? Let’s go back to our competitive academicians, our *professional* theorists. Each wishes to produce that Great Theory, the one-piece key that will command all the tumblers of the Lock at once so that apparently-refractory areas of existence may be related to a common term solving for them all, and indeed which allows their actual *relationships* to catalyze the Resolution. Implicit in this driving desire (whether for “inner” or “outer” reward, we need not say) is the taken-for-granted assumption that the current in-use theories *are* indeed inadequate. Darwinism, relativity, quantum mechanics, the Will-to-power or Oedipal Complex are all in themselves too narrow and specialized to fit the inflationary picture of proliferating complexities, the stretched canvas of creaking contradictions progressively painting a moribund portraiture from real-life consequences of those separate shortcomings.

On the basis of this taken-for-granted inadequacy of all present theories, however, our Ivy-league rowing teams are preoccupiedly busy hard-stroking toward the golden shore of *new* theories; their whole endeavor is based on the business of drawing alongside and boarding that great replacement-theory, all the while chanting the cadence of “Paradigm”. In so doing, of course, they’re calling upon the very name of that which they’ve unceremoniously thrown overboard, to popular plaudits. The reason for this is that, by failing to honor the “separate reality” of Paradigm as catalyzing Model, they continue to draw up theories against the implicit background of the *old patterns* on which those *confessedly inadequate* theories were originally based. In the field of Superstrings, for example, the antfarm of theoretical physicists continues to interpret its equations against the conventional background of “spacetime”, rather than rechecking the *overall pattern* implicitly rotated a notch by the introduction of “strings” so as to *account for* the emergence of spacetime by the theory.

An important factor in the whole *equation* of delivering a full-term *Weltanschauung* to the impatiently-awaiting world is therefore chronically skipped-over, indeed not even noticed due to so convenient yet critical a truncation whereby the “intelligentsia” rushes to register a conclusion before it has satisfactorily considered the *premise*.

For what is essential to a *theory* is that it fit the “present” facts no matter how *refractory*, as well as “facts” which may be generated on the *implications* of the theory. This symmetry between theory and facts is blithely ignored, by improperly compassing the whole process through the unwarranted equivalency between “Theory” and what was *originally* meant by “Paradigm” (indeed what *gave* “paradigm” its distinguishing definition in the first place).

**Involved in the question of “theory”, then, are the *facts* to which it must fit; but this necessarily involves a working typology of “*reality*” in order to determine what *qualifies* for a “*fact*” in the first place—i.e. what is indeed *real* so that it must be accounted for by the Theory.**

All hustling little competitors in the field rush to squeeze “paradigm” into the conceptual Bottle of *theory* where the Genie of refractory reality may be satisfactorily captured. “*Paradigm*” tends therefore to be the *eliminated* (yet no-less-necessary) step in the process, displacing the difficult matter of “*reality*” onto the outcome of the ultimate “*theory*” that would *define* it. By calling the *theory* the Paradigm, we seem to evade the requirement sticking out like a sore thumb in the true definition of “paradigm”.

The term, after all, was originated to mean something very specific—it emerged into the vocabulary for a *purpose*. Avoiding *its* specific implications by capitulating to the “popular” (i.e. New Age) lead of marrying it through synonym to “theory”, accounts in large part for the manifest *inadequacy* of every Grand Theory feverishly brought forward in the closing decades of this century so as to effectively unite the world’s myriad problem-zones to a resolving Common Denominator. **But one can’t “kill two birds with one stone” in this way, when all that’s in one’s slingshot is a clump of loose dirt.**

When we turn to ask *why* all the king’s horses and all the king’s men can only put together (so far) a clump of loose dirt, all we need do is refer back to the missing term, the essential *mediate step* that constitutes *all the creative ground* in the production of any true theory, which has stood and always will stand beneath the pinnacle of any Resolving Worldview as the magnificent Mountain on which the ultimate Perspective of that view was laboriously and creatively raised.

*Here* is the beginning of our recovery of that all-but-lost *Meaning* of “paradigm”; this proverbial Lost Word is *indeed* first of all a linguistic term.

## Conjugating the Lost Word

Resorting to the expedient everyone seems to have forgotten along the way, we may recover its “misty root-origin” by the esoteric means of consulting a dictionary—at which enlightening point we’ll come to find that “paradigm” is actually a term indicating grammatical *inflection*: it refers to the *declension* of nouns, pronouns and adjectives, and to the *conjugation* of verbs. It establishes the grammatical and syntactical relations of case, tense, gender, number and person.

“Paradigm” suggests the *modeling* of a term in all its inflectional forms; it expresses and defines the ways in which we may accept a term as “real”. It *conjugates all the modes of reality of any given term*.

We may immediately see then by contrast, that “theory” would be concerned with establishing a consistent set of *rules* whereby the acceptable variations in the reality of the given term might be understood and extrapolated. When we ask how the workaday world approaches the parallel relations between “paradigm” (inflection) and “theory” (formulaic rules), we begin to get a clearer picture of the way in which the *de facto* approach has effectively *sidestepped* the issue of inflection altogether (i.e. the determination as to the number of dimensional rotations through which a term may be continued to be regarded as “existing” or *real*), placing the burden of that determination upon the upshot of theory *as-if a rule could actually be given* which definitively formulated and resolved the question of what was “real” in the first place.

It is no wonder that, on the basis of this backward approach, such pronouncements of the New Age issue to the effect that “you create your own reality”. Apparently so! if we can give a rule that in itself *determines* the “real” (i.e. the number and quality of dimensions in which a term may be conjugated) rather than *accounts for* and resolves the variant manifestations in the declension of the real.

Manifestly, however, we *haven’t* been able to give such a rule as in the first case; and this is the reason behind the reasons *why* we haven’t been able to make that anticipated, collective *move* into a greater Density or internal richness of our own Reality.

**The fact of the matter is, the theory can’t emerge by natural Birth, until the sufficient Paradigm (the Example or operative Pattern) is given; and the Paradigm can’t be given when its popularly-accepted sense has crushed it into a flattened conformance with the profile of Theory.**

If the world seems desperately to need a new and resolving Theory to implement a totalizing approach to its problems, it has to have a transformatively-critical sense of the *required numbers of dimensions, states and values* into which such an ultimate Theory must go evenly. It has to be furnished an adequate intimation of the actual scope and proportion to which such a resolving “theory” must apply.



## What Items Belong in This Picture?

For instance, in formulating our sufficient Worldview, do we or do we not take into consideration—that is, loan any official credence to—the field of alternative and “free” energies? do we or do we *not* make allowances in our pattern for the possible presence of types of consciousness, or kinds of lifeform, that must be granted the full dimension of *alien* (whether that ultimately means “alien” from the stars, other-dimensional doorways or from the “inner Earth” itself)? Even taking a glance at the Index or Table of Contents of this present work, sliding down such subheadings as those of “Electronic Mind Control Projects”, “Population management through the use of Chemical and Metallic Substances”, “The CIA and Drug Trafficking”, “Covert Research in Biological Weapons for Population Management” etc. **it becomes increasingly evident we *must be willing to ask whether our “sufficient pattern” should be expected to integrate to itself some adequate idea of the monstrous***—for the conventional psychologies, long-based on old proportions and prior perceptions of the limits of human behavior, are manifestly inadequate to interpreting the typology of that emergent-outline insistently bucking at the grinding plate-seams between Old and New Worlds of manipulative Order. It becomes increasingly apparent that the provision of a proper model is never simply a matter of rotating all the given pins already stuck in the map; it requires a profound rethinking of terms. After all, the *requirement* for a “paradigm” (bringing some such usage back into the vocabulary altogether) doesn’t arise until the growing inadequacy of all former models has manifestly left the field in shambles, and the fires of unquenchable crises are roaring up all around.

If therefore the *true* outcome of Theory depends on the preliminary Model (i.e. paradigm) characterizing the terms to be *resolved and unified* by the theory, any such theory would be expected to *account for and conjugate in* all the actual dimensions through which the factors of the World-problem arise and occur.

**But this requires an intelligence able to *identify those dimensions and those factors.***

It’s for this reason we can’t say the ideal-resolving Theory only need account for those powers and properties that “make physical sense”, as with the field of physics alone; we can’t say the satisfactory theory would simply have to achieve an understanding of the perceptual or cognitive means by which meaningful “data” arise to begin with, or solve for the epistemological dilemma solely. We can’t assume that such theory would only be ultimately meaningful if its application satisfied the “sociological field equations”, or accounted for human presence in terms of “Topos”.

**The conditions of the current “dilemma” cut through *all the categories in which the terms of existence are conventionally conjugated, and now overlap borders so manifestly co-involved but unconventional that any arbitrary drawing-of-the-line simply to suit the “manageable” becomes a progressively-less tolerable practice in producing the comprehensive Overview, the authentic Weltanschauung.***

After all, consider: *what is it* makes a Theory worthwhile in the first place? Isn’t it the *applicability* of the theory to *all the relevant factors*, previously identified or not, which rules on its worthiness? What finally justifies the rarefied abstraction of theory to the concreteness of practice, is certainly the degree to which any such theory furnishes a *workable key* conforming to the contours of all component tumblers of the particular Lock constituting a restrictive shackle upon the world.

## Is *Fiat* in the Imperative Mood, Or Indicative Mood?

Therefore we must ask again: who can truly identify the *terms*? It’s only in the proper identification of terms—and a qualified approximation to the allowable elasticity in the “dimensional” conjugations of those terms—that the ultimate Ship of a sufficient Theory may be considered Christened, and launched upon its Way.

We’re culturally conditioned to embrace the acceptable Theory, the guideline rule upon which a basic *Worldview* may be stretched (even though the functional significance of that view is far

from the place where we routinely perceive). The rule of the Medieval churchmen gave the acceptable Worldview of the dark ages, though the operators of that rule resided in the arcanum of illuminated texts in an era of illiteracy so that the effective distances between culturally conditioned (religious) Theory and feudal *praxis* accounted for the particular “grain” of the general perception upsurging in the Discrepancy. Similarly, we “perceive” reality presently according to the (sociopolitical and cultural) tensions arising in the general relations of indentured “consumerism”, to the technological clergy and empowered priestcraft in possession of that Rulebook we’re conditioned to worship as relativistic Gospel in a state of effective quantum illiteracy.

We know of the Gospel of Einstein; we accept the practical validity of His Great Theory. Yet even members-in-good-standing of the relativistic Hierophancy tend to be insufficiently aware of the Process whereby such a Great Theory (or any great theory) originally came about. It’s for that reason “we” (and “they”) tend now to worship the Theory, call it by its progenitor-name Paradigm and seek to force it into giving birth again to *Itself!* Thus the continuing state of barrenness under a Thundercloud of Expectation—the ongoing fallowness where we expect the relieving Crop.

**It’s too-little-noted or understood that before the Einsteinian Theory, there’s the Einsteinian Paradigm. Before any Great concluding Reason, there’s the Great underlying Creative.**

Ordinarily when such epoch-making formulae are produced as with the celebrated “Einsteinian field equations”, they’re treated as though their titan character is ascribable to the fact that they manage—in whatever manner—to make sense of a group of “established facts” already laying around in a suggestive though apparently unrelated way. It’s insufficiently appreciated that we *value* the outcome of the Michelson-Morley experiment, the Machian model of motion, the topologies of Riemannian space and Maxwell’s unification of electricity and magnetism owing to their initial *identification* in the formative phases of Einsteinian theory. There was, in fact, nothing “inevitable” about them until their values were *defined* by the beauty and success of the theory in which they were incorporated.

**Thus the generation of the theory depended upon a *foundational work*; and that foundational work involved a faculty of discrimination or power of imaginative perception entering the overall picture as a critical—and indispensable—variable of surpassing Creativity.**

The parts ultimately participating in the workable pattern aren’t given, *gratis*; they must be *determined*—as an examination of the general state of physics just prior to the Einsteinian epoch will show; they must be *creatively identified* and *integrated* in a frankly-ticklish process that approximates toward Wholeness in delineating dimensions grand-enough to give true measure of the arable ground while sufficiently frugal to act as praetorian valve filtering anything unnecessary to a fit description of that Ground.

This *Pattern*, composed of just such selectively identified and creatively-integrated components, gives us the true sense of *Paradigm* and shows why Theory doesn’t *decide* upon the “declensions” in which Reality is to be cast but rather *rises up* out of an initial Vision, sufficiently monumental in scope and secure in its creative courage to declare—in swift bold strokes like an astonishing, deft Picasso—the general outline of the minimum Starmap on which the would-be Magellans of the New Reality must thereafter navigate.

## **Magi Bearing Gifts of the Paradigm, To the Manger of the Millennial Worldview**

The very reason then, that virtually *every* theory generated on the basis of the minimum criteria for “theories” alone (i.e. beauty and fitness of form, applicability to defined sets of circumstances etc.) doesn’t break a decisive barrier and bring the general attention to a New World of awaiting productivity, is given in this consideration of the *Epochal* Theory—for only the *Epochal* Theory has sprung full blown in a state of “critical mass” from the forehead of an adequate *Paradigm*. The

*Paradigm* is always the key, that decisive Creative Ground constituting the initiatory Pattern declaring a *revolution* in the inflection of terms, insisting with *persuasive psychic* and *rational Force* upon the inclusion of just so challenging a dimensional range in the full conjugation of working elements as is *impermissible* in the standard context (yet produced nevertheless at the extremes of that context) without waiting upon due legitimation by the appointed Hierophancy of the present Order.

Only where the ground-breaking creative work of that sufficient Paradigm already exists and has given sign of its activity, may the Epochal Theory be brought forward full term. This fact being critically *underappreciated* owing to the aforesaid glib equation of *paradigm* with *theory*, we have no reason to wonder any longer why “theory” so often fails to *serve* the field of tangible concerns but instead elicits contemptuous reaction in the frequent functional gap between abstract Pronouncement and refractory, *existential detail*.

Any such Paradigm, any such bold Creative pattern may be identified—in the given case—as having been generated by a source or sources *distinct* from the ultimate theory-bearer, or the *same as* the ultimate theory-bearer. Sometimes there’s a more obvious one-to-one identity between heroic Paradigm-maker and great cultural Formula-bringer as in the case of Einstein himself, or of Darwin who delineated the pattern by an irreducible act of creative selection before distilling from it a single, Survivalist Theory. Sometimes the determinant of Paradigm-relevance will issue as a more collective outline from many, sedulous sources before a single focus crystallizes it to common view—as happened in quantum physics just prior to the posting of Heisenberg’s heterodox billet on the churchdoor of scientific mechanism.

**However it occurs it may be uniformly affirmed that, at the juncture of any great Reality-shift it’s always in the creative matrix of an underlying Paradigm that the actual leaps are initially taken, all the deeds of cognitive valor enacted and the taboos tackled as down some dark passage in the Dream-time rite of the Symbolizing Psyche. It’s always in that chthonic stream, that subterranean current crackling with creative fires over the sheet of its surface like a psychic Styx that all the pioneering is actually done, all caves and verboten tunnels (opening tesseract routes under drawn-out tradelanes above) are explored by persistent assault-waves of solitary spelunking without benefit of miner’s cap or acetylene torch (since No Man has passed this Way before).**

Therefore it may be that the white-smocked Theoretician basks in bracing daylight of the general approval, when once he raises high the particular Excalibur of his steely Formula from the Stone-matrix wherein it was complexly embedded; yet all the terse abstraction of his formulaic marks are hewn upon the peak of an incalculable Mountain that few may take the measure of—often including himself. That *mountain* is the Matrix, the Magical Mountain indeed, upthrust in a seeming moment from the flat plain of the demoted worldview where most still lingeringly stand.

## **The Slithering Serpent of the Slinky-toy Paradigm**

Of course we’re used to the term “paradigm” in its relation to the field of physics, since it issues modernly as a scientific pointer—and that’s why we’ve taken such examples here. However, because a true paradigm serves to *determine* the scope of elements ultimately factored into the Resolving Formula, we may say that the greater the emergent Worldview of focused *theory* the greater the underlying *Paradigm*—therefore the less restricted *a priori* to any particular field in the derivation of terms it comes to consider relevant.

Considering how *great* is the requirement for such a Paradigm now, able somehow to resolve the full *panoply* of crises appearing on every single front whether approached categorically in terms of the hard or soft sciences, the “psychic”, “spiritual” or “artistic” sensibility etc., we’re hardly justified in relying on the *scientific hierophancy* itself to save the day (as with the Einsteinian model of our century’s earlier “epoch”) since that field is precisely in question as a total orientation along with all the others.

Indeed we must at this point lift our collective head to review the March of Paradigms (excuse your compulsive punster) over the greater span of history; in so doing we find everything settling into

Perspective so that, for example, underlying the emergent Religious Worldview of the Middle Ages we find the paradigmatic substructure of *feudal hierarchy*; beneath the humanistic Worldview we find the foundational paradigm of *fluid capital*, floated toward a *vanishing-point* horizon by the Hanseatic League mediating a mercantile middle-class; and beneath the Scientific Worldview we find an informing paradigm of complex considerations greatly beyond the question of science in itself, rooted in the religious and humanistic crises finding deeply *epistemological* expression in the *cogito* etc.

We may therefore, along with Hegel and his back-masked understudy Marx, look upon that “march of history” itself in terms of the *dialectic* paradigm (since it moves in obvious Sine upon successive arcs of a spiral—or we should say it’s rather more like a Slinky toy undulating along an Escher staircase where, the deeper it descends from the Divine paradigm of theology to the magical paradigm of myth, from myth to religion, from religion to humanism, the higher it simultaneously ascends toward the theological extreme once more only this time in good dialectic fashion having come to the crisis of Divinity again in terms of Consciousness Itself).

From mythic to scientific worldview, then, we trace the saga of consciousness as it seeks to determine the proper field of its study. Therefore just as old Karl came to proclaim that the proper study of Mankind is Man so we are in the advantageous “dialectical” position to proclaim (at this *millennial juncture of historical crisis*) that the proper study of *Consciousness* is the field of *Consciousness* itself!

We find a unique implication in the inexorable character of this conclusion: at this stage, *any resultant theory* able to do justice to the required phase of an epochal Paradigm patterning a *Whole reorientation* with respect to Consciousness itself, must necessarily be a *Living Theory* (in the same way *VGER* of *Star Trek*, *The Movie* refused the conventional denouement of a merely mathematical bite, insisting on *plugging in* directly the anode and cathode of “conscious” and “autonomic” systems thus generating a Transcendental Fireworks where a dry equation was programmed to take place). Any such Theory must be a Living Theory and thus inseparable from *Practice*. The proper response to any *present* Paradigm of the proper magnitude, then, is necessarily that of *Consciousness in Theory and Practice*.

## Buddy, Can You Paradigm?

This brings us to the very *practical* question, then, as to who is in the position to *recognize* the real term of the problem to begin with? who is *factually* capable of understanding that behind each “separate” crisis (in the inequitable distribution of world resources, suppressed and privately arrogated preserves of “alternative energies”, the ubiquitous breakdown of traditional structures, the natural and manmade interplay of ecological catastrophes) there is the critical Common Denominator of *One* unresolved Question: that very question of Consciousness. Who can generate the only *adequate* matrix for a full-term Paradigm commensurate with this moment? Who is capable of *recognizing* the real point, and of *sustaining* that recognition through a thorough and consistent review without succumbing along the way to the universal agitation for provisional (and inadequate) poultices—as if a greater totality could be constructed on the basis of some sham cohomology of myriad, stop-gap patches.

Of course we know so many of instant self-presumption willing to come to the Call; yet one large Type excludes itself on principle, though it would never recognize itself as such, by slamming shut any apparently-material door when the glaring halation of the “psychic” seeps around its opening edges. Another Type excludes itself just as unerringly when in its eclectic eagerness (not to say egregious, New Age “openness”) it pitchforks absolutely everything together in one piled recitation without the slightest idea how—or even whether—anything actually fits.

No, in this case of our potential new Paradigm it won’t necessarily be the formal physicist who fashions it, so locked in specialization that his grandest concept of “paradigm” tends to focus down on isolating the proper gauge-group for an unambiguous String Theory...for, even as he mixes and matches the tables of comparative matrices (entranced in his sanctioned redoubt), shadow researchers in electricians’ smock move tables and mattresses of their own into government labs setting up

permanent shop in the Alternative Energies wing right across the hall, the door to which is simply marked Maintenance Engineer.

Nor will it be our typical New Ager, sad to say, who for all his openness to alternative theories, his “unhippie-like” willingness—if not compulsion—to embrace technologies of all types no matter how mortally ridiculous, is still by-and-large that prototypical Fool who rushes right in where angels have long since learned to *hover over* the tarp-covered construction pit.

When however the purveyor of any such sufficient Paradigm appears, whether stepping out from the nominal door of any of the conventional categories or emerging from “no expected quarter”—we may recognize him by a manifest transcendence of every categorial limit, by demonstrable surpassing of the professional commitment to one field of expertise or even combinations of fields defined by their specializations.

He’ll appear with wings of intuitive inspiration affixed to the sturdy back of rational inquiry. And we’ll note as well that the sensitivity of the *Artist* isn’t optional in this case, but must show as a visible appointment. Neither shall the will-to-Good be a dispensable feature in identification of the Paradigm-maker; rather shall it be the *sine qua non*.

Nor is it *enough* that he possess *intuition* to spare; the *discriminative faculty* to a superlative degree; the prodigious power of a *subtle rationality* able to hopscotch over tiles inlaid to a Fearful Symmetry, as well as tread the tricky angles of ideal Ratio. He’ll be identifiable owing to the *unerringness* of his intuition even in the face of massed, conventional wisdom or “established fact”; by the paradoxical toughness of his subtle/discriminative faculty; by the unshakable character of his imagination, reason and intuition combined so that, when the inevitable objection issues from Zone of the common Myopia or Vesture of Specialization to the effect that “you can’t say that! you can’t include that! this is unproved! there aren’t instruments to measure it! you’ve gone too far!” he’ll be every-bit able to take the measure of aptness according to a Muse unborn as well as rule upon the ripeness of any term he’d add or subtract so that nothing in Established Heaven or Consensual Earth can dissuade him from an imminent approach to that sufficient *grael*, the comprehensive pattern and viable Model without which *no* transformative Theory or Millennial Worldview could ever come about at all.

## Time’s Up, Folks! The Correct Answer Is...

Given such characterization of the minimally-suitable candidate, the comparative rarity of the required qualities should become evident. Not only are they rare qualities when considering the potential Paradigm-maker; the capacity even to *identify* such qualities in another implies a sufficiency of corresponding substance in the observer. In addition to the question as to *who* might ultimately appear as most-likely candidate to produce the Full-term Model, the sufficient Paradigm, we must also ask the complementary question *who* is going to be up to identifying him should he step forward?

*Val Valerian* and the *Matrix* material have been around for awhile now, a handful of very high-profile years. A sufficient amount of time has elapsed, a great enough Grace period has been given, as it were, so that if in the interim there were someone qualified to identify What’s There he should certainly have done so by now. In all the many words and references read in relation to Valerian, *Matrix* and the periodical *Leading Edge*, whether positive or negative in character, precious few have accorded a recognition really commensurate with the ongoing quality of the Work; and none, absolutely *none* that one has read, have correctly identified that Work for what it is at all.

Thus in illustration of the apparently-indispensable principle “it takes one to know one”, the writer of this Introduction himself steps forward at the lapse of the general Timer taking the measure of humanity’s furthest capacity for response, so that the presence of a Paradigm-key may be properly announced.

Whether a future Theory-triumphant along with its infeeding paradigm are ever ultimately identified as issuing from one and the same source, or are eventually recognized as belonging to a convergent work on several coordinated Fronts, we may confidently state that the Day of the adequate

paradigm in all its imaginative bridges and bold leaps is already upon us. Along with the parallel Initiatory Work of Southern Crown and Its winged messenger-*Thunderbird*, the principal labor of hewing the paradigm-pattern from a large-enough Block of Existence has been accomplished, in the form of the first two *Matrix* volumes (i.e. *Matrix I and II*) and now in this completely new edition comprising a decisive point of departure into the field of Consciousness itself. In the first *Matrix* volumes the verboten *spacealien* subject was unprecedentedly aired and fused to themes of alternative technologies, hidden government agendas etc. No self-respecting particle physicist would touch such themes with a ten foot pole—which is exactly why it isn't the self-respecting particle physicist who comes forward now, with a prodigious Proposition basically identifiable in the true measure of its value only *from* the framework of that Whole-being Consciousness toward which it points.

As the *I Ching* says, when in the course of a difficult situation the messenger of importance appears at the Court and there is no one of sufficient station or accomplishment to identify or sponsor him, he may under such extraordinary circumstances introduce himself. In this case there are two such messengers at the Court, so that—at least—one may introduce the other.

Here then is Val Valerian and *Matrix III*. Seekers of the Paradigm may quit seeking. This is what you need to know, and what you need *in order to know*. If you're *for real* in this critical Time and Place and you truly *mean business*, you'll keep this book by your side, you won't put it down; and by your conscientious study you'll demonstrate the degree to which *you* possess progressive power to recognize the Real, as well as to follow out its implication to the End—even to the end of Consciousness Itself.

MT  
(Michael Topper)

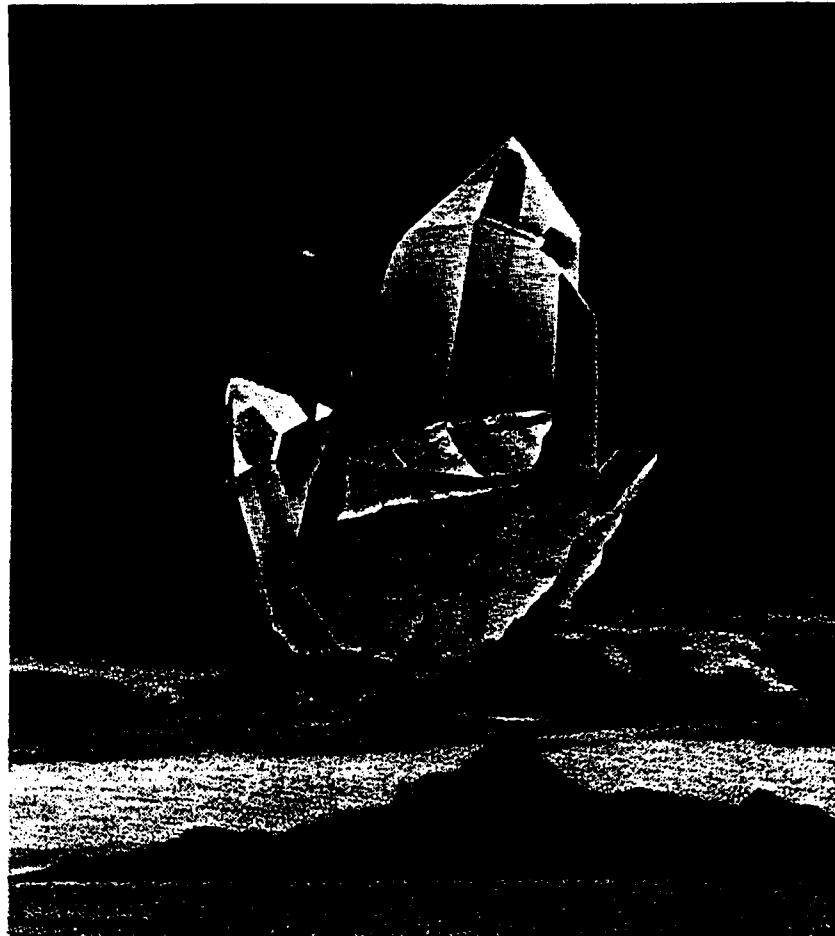

# M A T R I X I I I

## FORWARD

Every human being basically desires a certain quality of life for themselves and their children, and most human beings spend their entire life in the pursuit of this goal. During this lifelong process, most people look around and note that things more or less stay the same; nothing seems to really improve - things appear to be in a constant process of deterioration. The oft-promised factors of life, liberty, and health are never realized.

The public perception of the reasons behind this dark trend are somewhat limited; like sheep in the pasture, they cannot realize the depth and influence of what is around them - what it really means and what is really going on that maintains their lives in such a miserable state of existence.

In the previous book, we examined the apparent factors that are behind the world power structures, as well as a plethora of events that appear to be happening in the interaction between humans and some alien species, with particular attention to the abduction area and government and alien underground operational sites.

In this work, we will be examining areas that appear to be "closer to home", with particular attention to the sociological parameters of social control - areas that comprise the final manifestation of control, both overtly and covertly, for the human planetary power structures known as the "New World Order". We will also be examining updated information since the last book was published in areas such as mind control and alien interaction, as well as a completely new area of approach - that of personal evolution of consciousness in the face of social drama.

There comes a time in many peoples lives when they start working on themselves and their own consciousness; who you are and what you can do in consciousness is, for most people, a greater mystery than the subject of alien interaction. Since "consciousness is the name of the game" everywhere in the universe, it makes sense to start with the discussion of higher levels of manipulation, as in Matrix II, move to levels of manipulation that directly affect people, and then provide people with an understanding of who they are and what they can become; this understanding will provide them with the tools in their consciousness to resolve the dualities in their lives and hopefully to rise above the planetary interactions that impact their lives in an undesirable manner.

Consciousness is the key to it all. An elevated human consciousness will not be affected by anything that occurs

## M A T R I X I I I

in the surrounding environment. Along with the development of knowledge and understanding in this area, the physical body is also changed. This whole matter is, admittedly quite an undertaking, but ultimately it must be done by someone, so why not just do it?

In summary, the process involves:

1. Achieving an understanding of what is purposely being done to the human species by the world power structures on a physiological, mental and spiritual level.
2. Acquiring increased knowledge in many different areas relating to the physiological, mental and spiritual aspects of the human being.
3. Using this acquired knowledge to promote ones own self-development, self-empowerment and ones consciousness.

Even after all this material is presented, it is a fact that only a small percentage of you will actually make use of the information to change your lives and your consciousness. As humans have a lot of internal programming that resists change of any kind, it will be an uphill battle for most of you - most of you will not succeed. The fact that you are predisposed to have this book in the first place is a plus - it is an indication that you are open to change and open to contemplation of new information.

Human beings on this planet live in a reality that is conditioned by the culture they live in. Cultures on this planet, with few exceptions, manifest themselves in such a way that there exist at least five major groups within a culture that reflect an individuals position in society:

1. Those who have a limited awareness and yield their personal power to others without question.
2. Those who have a limited awareness, and seek/use their position to acquire power to manipulate other human beings.
3. Those who have a growing awareness that there is more to life but they are unable to penetrate the cultural veil and still give up their personal power.
4. Those who are able to penetrate the cultural veil to a significant degree, but lack the knowledge to prevent reactive depression and giving up of personal power.



## M A T R I X I I I

5. Those who have penetrated the cultural veil, acquired knowledge, conscious awareness, and self-empowerment.

There are more divisions possible in a culture, but let us leave it at that for purposes of this discussion. The above groups are listed in such a way that they represent a growing order of consciousness. After consultation with others and a little contemplation, a relative estimate of the percentages of the above groups in the United States might be:

Group 1: 65%    Group 2: 5 %    Group 3: 25 %    Group 4: 12 %  
Group 5: 3 %

Here in 1992, we are faced with a situation where more and more people are joining Groups 3 and 4, since the self-limiting nature of social operations conducted in the conscious states of Groups 1 and 2 become more obvious as time marches on. The old cultural adage "You can fool some of the people some of the time, but not all of the people all the time" seems to describe the process.

Here, in this book, we'll begin by examining areas of manipulation that have been and continue to be used by Group 2 to manipulate individuals physiological, mental and spiritual states of being. When it's all over and you finish the book, you'll hopefully be moving rapidly toward joining Group 5.

Let's take a look at some recent developments in the United States that have occurred between Matrix II and Matrix III, many of which have been detailed in various Leading Edge publications - some have not:

### Recent Developments

1. In 1992, all the major intelligence agencies (CIA, NSA, DIA, NSC, etc) will be combined into one agency, the National Center for Intelligence (NCI), which will be near Mount Weather in Virginia. Supposedly, this oxymoronic agency will be headed by one man who is not supposed to have ties to any of the agencies within it. The effect of this will be that the CIA, DIA, and NSA will disappear as separate operating agencies (externally), so any wrongdoing that has been associated with these agencies will be that much harder to follow up on in terms of prosecution.

2. In Sweden, a new implant, designed by a Dr. McDaniels and a Dr. Paul Hod, called the Proto-32, has been approved for use as a brain implant in humans. It has now been FDA

## M A T R I X I I I

approved, and is a microchip implant that will be able to affect DNA and growth of the human being, as well as other capabilities which we have not discovered. It is a 32-bit device. With that much computing power implanted in a human brain in the era of electronic mind control, we can only wonder what they really are doing. The two doctors who developed the Proto-32 are supposedly dead. How convenient.

3. Presidential candidate William Clinton, apart from all the scandalous activity his is associated with, is found to have attended the 1986 Bilderberger Meeting and to have had knowledge, like George Bush, of drugs being shuttled out of Mena airport in Arkansas on military aircraft; the story was reported on "A Current Affair" in April 1992; the gov't drug trafficking in Clinton's home state continues.

4. During the period between January and February 1992, an interesting development occurred in Florida which was passed on to us; it was not publicized outside the state of Florida. During a train derailment, two boxcars broke open, revealing that they (and in fact the whole train) were loaded with shackles. A trainload of shackles? The train was bound for the area of Oregon and Washington.

5. In 1990, several bikers in Oregon chanced upon a six-lane dirt highway in central Oregon that was in the middle of nowhere. They followed the road until they were confronted with three 260-pound individuals that told them to leave or they would be killed. All three individuals were exactlt alike. I can see twins, but three? Reports are coming from Oregon which indicate that large 40-acre plots are being carved out of the woods through the auspices of the U.S. Forest Service, cleared and grubbed and surrounded with an eight-foot barbed wire fence that also penetrates some four feet under the ground. According to the U.S. Forest Service, the areas are for growing seedlings. A large hazardous waste incineration facility (50 acres) was built somewhere in central Oregon by the U.S. Government, according to an ex-military fellow we encountered at Preparedness Expo 1991 in Tacoma. It was brand new a couple of years ago and has never been used. It is similar to a facility built in Onoway, Canada some years ago - also a facility that just sits there. Onoway is a town that is built around a prison. The fellow at the Expo was quite nervous, and said he was only interested in finding ways to buy large quantities of food for survival purposes.

As you will learn in this book, there are many ways available to you to handle anything that occurs; basic states of fear and survival have their origin in the play

## M A T R I X I I I

of consciousness through specific areas in the brain - areas that are constantly and purposely stimulated by the society we live in; it is a society run by those who do not want people to grow in consciousness and become empowered beings. In Matrix III, we will show you how different neurological areas relate to different behavior and states of consciousness - the knowledge will allow you to expand beyond the states of consciousness that society wishes you to be in, in effect to become a more empowered and knowledgeable member of the human species, more able to move into greater areas of human experience.

Knowledge is power, and it is vital that you become informed and grow in consciousness so that you may view the surrounding drama from a more self-empowered perspective.

There are indications that the larger the human population, the more rapidly the population as a whole will evolve. You will understand why as you delve into this book. This may also explain the drive by certain factions to limit and control population, much in the way the Nefilim may have done 200,000 to 350,000 years ago when it was discovered that the human "experiment" had more genetic potential than was suspected. Genetic changes (there may have been as many as 64) in human beings were made in order to limit the human being. The state of consciousness that sought to limit the human being is still impinging on this planet, filtering down into planetary control procedures that are documented in this book.

The understanding of polarities and dualities is very important to your growth in consciousness. Take what is presented here and discuss it with as many people as possible. The more people that grow in consciousness, the easier it will be for others to grow. This is a period where the planet is rapidly moving into a state of more rapid vibration; according to some sources, the planet will be the site for the final conflict between dualities, a conflict that you will eventually recognize in more expansive terms. This recognition will allow you the realization that what are apparently separate polarities in "conflict" is actually the same thing viewed from two different perspectives.

You will recognize that "consciousness is the name of the game" everywhere in the universe. Is it no wonder that people with expanded consciousness are never approached by alien factions that derive their existence from fear and manipulation? Why do the Greys "respect" those who have greater will and focus, in consciousness, than they do? Why do "negative" factions rely on technology to

M A T R I X I I I

manipulate those who have a lesser degree of conscious awareness? These questions, and more, will be answered in your awareness as you read this book.

Peace Be With You



# M A T R I X I I I

## Chapter 1

### *Basic Scientific Concepts and Knowledge*

There are many basic concepts that you will need to understand in order to fully evaluate the data contained in this book. Understanding these concepts will also allow you to more effectively reach your conclusions after the book has been completed. We'll build on concepts as we go.

#### Standing Waves

If you stretch a string between two points and pluck the string in the middle of its length, we see for a short time the outline of the string in the extreme positions of its movement which form two symmetric arcs:



If you pluck the string at the one-quarter mark of its length, you will see the following shape:

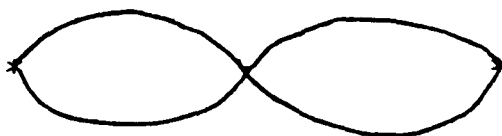

The areas between the arcs represent *standing waves*. We get such waves by plucking the string at distances that will divide the string into integral numbers. In the first figure above, the distance between the two ends of the string corresponds to half a wave; in the second figure, the distance between the two ends of the string accomodates a full wavelength. In the second figure, the string has a point in the middle which is at rest. Such points of rests are called *nodes*. When the nodes along the string appear stationary while the rest of the string is vibrating, we call such behavior a "standing wave".

#### Oscillators and Resonant Systems

An *oscillator* can be described as anything which moves in a regular periodic manner, such as a vibrating string, a clock pendulum, or a weight hanging on a spring. Oscillators produce a sound as long as they alter their environment in a *periodic* manner. Suppose we tune two violins, then put one of them on a table and play the other one, If we watch carefully, we will see that the same string we are playing on the violin is the same string that vibrates in the violin on the table. This illustrates the concept of *sympathetic resonance* between the two vibrating strings (oscillators). Such a system, made up of

## M A T R I X I I I

two tuned oscillators, is called a *resonant system*.

### Rhythm Entrainment

Nature finds it more economical in terms of energy to have periodic events that are close enough in frequency to occur in phase or in step with each other. Such a phenomenon can be seen to occur if we have two pendulum clocks on a wall. If we start one clock and then start the other, after a while the two pendulums will fall into step with each other. This phenomenon is called *rhythm entrainment*.

### Coherency

When two sets of periodic functions or waves get in step with each other or become in phase with each other, we can say that they are *coherent*. The concept of coherence is important in understanding how living systems make use of electromagnetic signals. Nature uses highly coherent electromagnetic signals between and within living systems. The range of frequencies involved extends downwards from the ultra-violet, where radiation becomes ionizing, through to the sub-Hertz ranges of seconds-per-cycle. The lowest frequency meaningful to the living organism is the frequency corresponding to the reciprocal of its life-span; such fine tuning of frequency through the life span of a living system carries with it the risk of sensitivity to and disruption by (purposeful or otherwise) environmental coherent electromagnetic fields or, as we shall see later on in the book, disruption by virtue of higher order fields which lie outside the electromagnetic spectrum.

Oscillations and resonances happen in any structure. They become useful when they are interrupted in a coherent manner to convey information. This process is called modulation. Highly coherent oscillations can act as carriers for modulation representing a control function for the regulation maintenance of homeostasis (control or regulation) in living systems.

### Capacitor

A *capacitor* is a device that stores an electrical potential or charge. The ability to store an electrical charge is capacitance.

### Attenuation

*Attenuation* refers to energy loss in an electromagnetic impulse. The farther you get away from a radio station, for example, the more the signal is attenuated.

## M A T R I X I I I

### Free Radicals

Free Radicals are not "unconfined political activists". They are uncharged groups of atoms containing an unpaired electron that are very reactive chemically. Living systems need them to be able to use oxygen to get energy but have devised ways of eliminating them when no longer required, since they may be produced in the organism by chemical and electrical processes. An excess of free radicals can give rise to unwanted chemical reactions in the body which can lead to disease conditions. Stress, physical trauma, chemical toxicity and infection can cause an increase in free radical production in the body and very often can overwhelm the antioxidant defenses of the body. The long term consequences may include any inflammatory degenerative disease states which are often associated with immune system suppression or immune dysregulation, and carcinogenesis.

Free radicals are particular atomic or molecular units having a single unpaired electron in an outer energy level; the total of the electrons an odd numbers. The presence of free radicals are interactive with electromagnetic fields. Free radicals are only destructive to the organism when they get out of control.

# Physics of Sound, Music, Frequency & Vibration Wave Mechanics & Wave Motion: Mathematics & Geometry

Fig 8-1

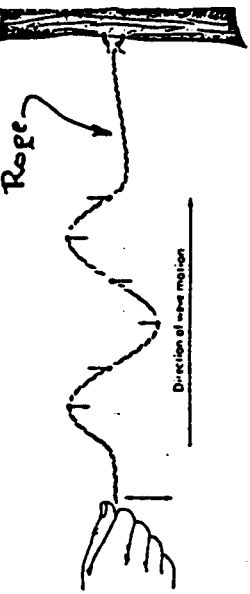

TRANSVERSE WAVE

Electromagnetic & Light waves travel in this manner.

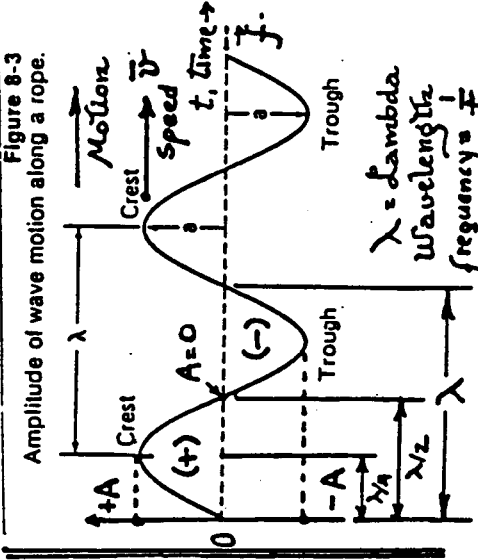
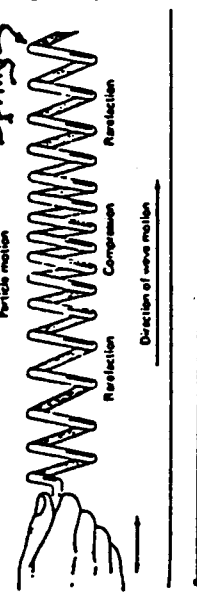

Figure 8-3  
Amplitude of wave motion along a rope.

Fig 8-2



LONGITUDINAL WAVE

Sound waves travel in this manner. (Also SCALAR waves)

Fig 8-4



STANDING WAVE(S)  
Pipe-Organ Tube

Notice that  $L = \lambda$

- $\lambda =$  Fundamental
- $\frac{\lambda}{2} =$  1st Harmonic
- $\frac{\lambda}{4} =$  2nd Harmonic
- $\frac{\lambda}{8} =$  3rd Harmonic

HARMONIC VIBRATION:  $\frac{\lambda}{2^n}$

$$H_0 = \frac{\lambda}{2^0} = \lambda \quad (\text{Fundamental}) \quad 2^0$$

$$H_1 = \frac{\lambda}{2^1} = \frac{\lambda}{2} \quad 2^1$$

$$H_2 = \frac{\lambda}{2^2} = \frac{\lambda}{4} \quad 2^2$$

$$H_3 = \frac{\lambda}{2^3} = \frac{\lambda}{8} \quad 2^3$$

( $H_5 = \lambda/32$ )

Fig. 8-5

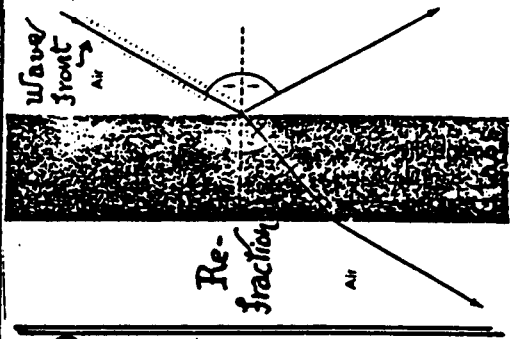

REFLECTION & REFRACTION OF a Wave front of Sound or Light Speed of Wave changes inside Medium.

Reflection



# MATRIX III

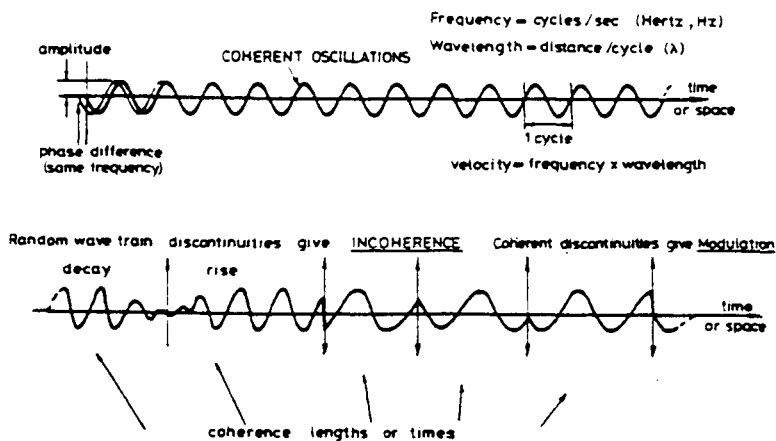

**Coherence and Incoherence** Oscillations must start and stop. The shorter a burst of oscillation, the less coherent it is. Even if the frequency of two oscillations is the same, they may not be in phase. For any wave, its frequency multiplied by its wavelength gives the constant velocity with which it travels. The velocity only depends on the medium through which the wave is travelling. An exception is within highly coherent systems where the wavelength is constant and the velocity is proportional to the frequency.

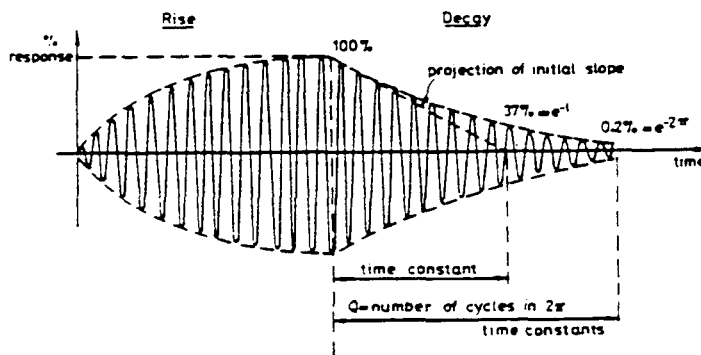

The quality (Q) of a resonant system is the ratio of the energy stored/energy lost per cycle. It expresses the sharpness of resonance and response rate.

**Resonance Response Rate** The more precise an oscillator is in frequency (the 'sharper' its resonance) the longer it takes the oscillation to build up and decay. The sharpness of a resonance is called its 'Quality' or 'Q', and is the reciprocal of the fractional 'bandwidth' or 'selectivity' obtained.

## M A T R I X I I I

### Human Etheric Structures

There is nothing in the manifested universe which does not possess an energy form, subtle and intangible yet substantial, which controls, governs, and conditions the physical. With reference to the physical body, it is termed the etheric body. This energy form is itself conditioned and governed by the dominant solar or planetary energy which ceaselessly creates it, changes and qualifies it. The etheric body, in the vast majority of humans, is the vehicle or the instrument of astral energy. The mass of humanity are still Atlantean or astral in their nature. The etheric body is composed of interlocking and circulating lines of force emanating from the many levels of consciousness of our planetary life. These lines of energy and this closely interlocking system of streams of force are related to seven focal points or centers to be found within the etheric body. Each of these centers are related to certain types of incoming energy. When the energy reaching the etheric body is not related to a particular center, that center remains passive; when it is related and the center is sensitive to its impact, then that center becomes vibrant and receptive and develops as a controlling factor in the life of the man on the physical plane. The dense physical body is held together by and is expressive of the energies which compose the etheric body. These energies appear to be of two types: the energies which form, through interlocked lines, the underlying etheric body, as whole and in relation to all physical forms. This form is qualified then by the general life and vitality of the plane on which the Dweller in the body functions, and therefore where his consciousness is normally focussed. Another type of energy is the particular energies by which the individual consciously chooses to govern his daily activities. As attitude, attainment and comprehension shift to higher levels, the etheric body will be constantly changing and responding to newer energies. The etheric body interpenetrates, underlies, and occupies the entire physical organism. It extends beyond the physical form and surrounds it like an aura. According to the point in evolution will be the area which the etheric body covers beyond the outside of the physical body. It may extend for a few or many inches.

Within the physical body, the network of the etheric body is to be found permeating every single part. It is particularly associated at this time with the nervous system, which is fed, nourished, controlled and galvanized by its etheric counterpart. This counterpart is present in millions of tiny streams or lines of energy, to which the Eastern occultist has given the name "nadis". These nadis are the carriers of energy. They are in fact the energy itself and carry the quality of energy from some area of consciousness in which the Dweller in the body may happen to be focussed. According to the state of consciousness and the psychic state of awareness, so will be the type of energy carried by the nadis, passing

MATRIX III

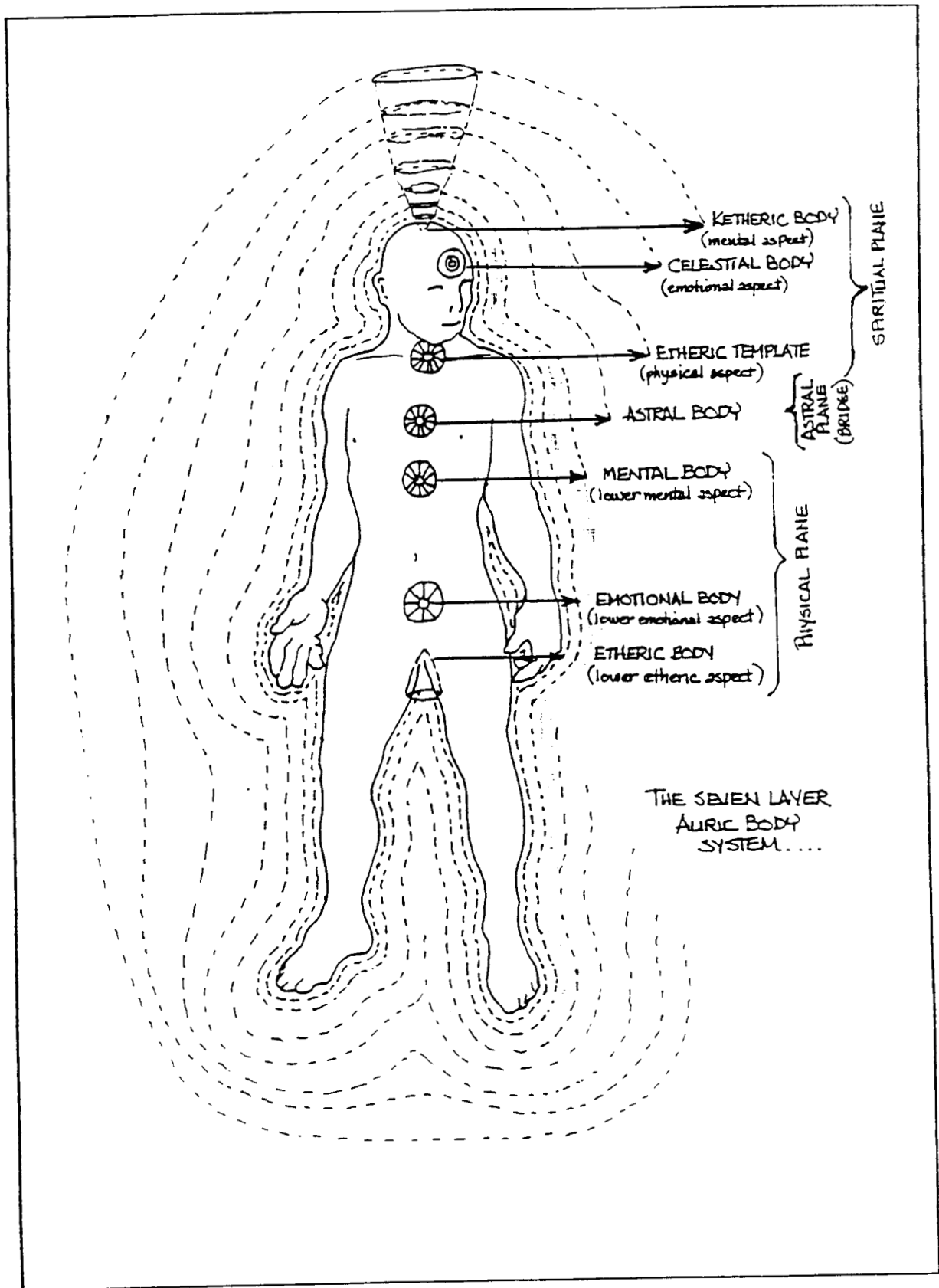

## M A T R I X I I I

from them to the outer nervous system.

It must always be remembered that the seven energy centers are not within the dense physical body. They exist only in etheric matter and in the etheric so-called aura, outside the physical body. They are closely related to the dense physical body by the network of nadis. Five of the centers are to be found in the etheric counterpart of the spinal column, and the energy passes through the spinal vertebrae and circulates then throughout the etheric body as it is interiorly active within the physical vehicle. Three head centers exist, one just above the top of the head, another just in front of the eyes and forehead, and the third at the back of the head, just above where the spinal column ends. In practice, the center at the back of the head is not counted in the initiation process, any more than is the spleen, so we have then seven centers to examine.

The powerful effect of the inflow of energy, via the energy body, has itself automatically created these centers or reservoirs of force; the effect of these seven centers upon the physical body in due time produces condensation or a state of what is called "attracted response" from dense matter, and thus the seven major sets of endocrine glands slowly came into functioning activity.

The whole development of the etheric body falls into two historical stages. The first stage is that in which the etheric energy, flowing thorough responsive centers and creating endocrine glands as a consequence, gradually begin to have a definite effect upon the blood stream; the energy worked through that medium solely for a very long time. This still remains true, for the life aspect of energy animates the blood, through the medium of the centers and their agents, the glands. Hence the words in the Bible that "the blood is the life". Secondly, as the race of men developed, and consciousness grew greater and certain great expansions took place, the centers began to extend their usefulness and to use the nadis, and thus to work upon and through the nervous system; this produced conscious and planned activity upon the physical plane.

The energy tubules, or nadis, pass to certain areas of the body in three ways:

Through the seven major centers  
Through the twenty-one minor centers  
Through 49 focal points scattered all over the  
body

The physical body, therefore, is triple in design. There is the etheric body, the nadi system and the dense physical body.

## M A T R I X I I I

### Telepathic Activity

Telepathic activity appears to be present in three modes in developing human beings. Instinctual telepathy is based upon those impacts of energy which come from one etheric body and make an impression upon another. The medium of communication employed is the etheric substance of all bodies, which is necessarily one with the etheric substance of the planet. The areas around the Solar Plexus (SP) are sensitive to the impact of etheric energy, for this area in the etheric body is in direct "touch", as it were, with the astral body, the feeling body. Also, close to the solar plexus is found that center near the spleen which is the direct instrument for the entrance of prana into the human mechanism. Prana might be defined as the life-essence. This instinctual response to etheric contact is said to be the mode of communication in Lemurian times, and largely took the place of thought and speech. It concerned itself primarily with two types of impression: that which had to do with the instinct of self-preservation, and that which had to do with self-reproduction. A higher form of this instinctual telepathy has been preserved for us in the expression we so frequently use, "I have a feeling that..." and allied phrases. These are more definitely astral in their implications and work through the astral substance, using the solar plexus area as a sensitive plate for impact and impression. This astral (not etheric) sensitivity, or "feeling telepathy" also basically the Atlantean mode of communication, and involved finally the use of the solar plexus center itself as the receiving agent; the emitting agent worked, however, through the entire area of the diaphragm. It was as though there appeared a gathering of outgoing waveforms in that part of the human vehicle. The relatively wide area from which the information was sent out acted as a large general distributor; the area which received the impression was more localized, involving only the solar plexus. The reason for this can be found in the fact that in Atlantean days the human being was still unable to think, as we understand thinking. The whole lower part of the body, in sense difficult for us to grasp, was given up to feeling; the communicator's one thought-contribution was the name of the recipient, plus the name or noun form of that which was the idea to be conveyed. This embryonic thought winged its way to its goal, and the powerful "feeling" apparatus of the solar plexus received it and drew the "feeling impression" there, drawing on the communicator. It is this process which is pursued when, for instance, some mother "feels" that some danger threatens her child, or that something is taking place in connection with her child.

Instinctual telepathy will often manifest in two ways. It will be from solar plexus to solar plexus between two people who are ordinary, emotional, governed by desire and primarily centered in the astral and animal bodies. In addition, it will

## M A T R I X I I I

be between such a "solar plexus" person and another whose solar plexus center is functioning actively but whose throat center is also alive. This type of person registers in two places - provided that the thought sensed and sent out by the solar plexus person has in it something of mental substance or energy. Pure feeling and entirely emotional emanations between people necessitate only solar plexus contact. Instinctual telepathy has also been referred to as Sympathetic Telepathy, which involves a sense of immediate understanding, awareness of events, apprehensions of happenings, and identification with personality reactions. The entire process involves the lower aspects of the Universal Mind as an agent.

### Mental Telepathy

Today, instinctual telepathic communication is still the major expression, but at the same time, Mental Telepathy is becoming increasingly prevalent. The throat center is primarily involved where mental telepathy is concerned; there is also sometimes a little heart center activity and always a measure of solar plexus reaction. Hence our problem. Frequently the communicator will send a message via the throat center, and the recipient will still use the solar plexus. Mental telepathy is the rapport established between minds; it also includes the telepathic response to current thoughtforms and thought conditions in the world today. Mental telepathy could also be termed the interplay of transmitted thought. It is related to the higher aspect of the Universal Mind, to the intelligent Will. Straight mental telepathy is one of the highest demonstrations of the personality; it is in the nature of a bridging faculty, for it is one of the major steps towards the higher impression; it always presupposes a relatively high stage of mental development.

The strong desire to achieve success in telepathic work, and the fear of failure, are the surest ways to offset fruitful effort. In all such work as this, an attitude of non-attachment and a spirit of "don't care" are of real assistance. Emotion, and the desire for anything on the part of the receiver create streams of energy which rebuff or repulse that which seeks to make contact, such as the directed thought of someone seeking rapport. When these streams are adequately strong, they act like a boomerang and return to the emanating center, being attracted back there by the power of the vibration which sent them forth. In other words, intense desire to make a satisfactory impression will attract the outgoing back again to the transmitter. You can see, therefore, how a cultivation of detachment is a necessary qualification for success in telepathic work.

## M A T R I X I I I

### Intuitional Telepathy

Intuitional telepathy is one of the developments upon the path of the Initiate. The area involved is the head and throat, and the three centers which will be rendered active in the process are the head center, which is receptive to impression from higher sources, and what is called the Ajna Center, which is receptive to intuitional impressions; this Ajna Center (between the eyebrows) can then "broadcast" what which is received and recognized, using the throat center as the creative formulator of thought, and the factor which embodies the sensed or intuited idea. The truly telepathic individual is one who is responsive to impressions coming to him from all forms of life.

Intuitional telepathy begins to manifest increasingly among advanced human beings. This indicates soul contact and the consequent awakening of group consciousness, for sensitivity to intuitional impressions has to do only with group concerns.

### Group Telepathic Work

The course of evolution is taking the human species toward eventual work together as a group where telepathic work is concerned. There are several factors which appear to govern united group telepathic work. First, it is essential as a member of a group that is evolving in consciousness and working on telepathic levels that you acquire facility in tuning in on each other with deepest love and understanding; that you develop impersonality so that when a brother tunes in on what he perceives is a weakness or a strength, it evokes from you no reaction that could upset the harmony of the group. The discovery of what is perceived as a weakness should produce only the evocation of a deeper love. If individuals cannot tune in on each other with ease after long periods of close relationship, how can they, as a group, tune in on some individual or some group of individuals unknown to them in their personalities?

Secondly, constant effort must be carried forth to bring about a group love of such strength that nothing can break it and no barriers rise up between you; to cultivate a group sensitivity of such a quality that your diagnosis of conditions will be relatively accurate; to develop and unfold a group ability to work as a unit, so that there will be nothing in the inner attitudes of group member which could break into their carefully established rhythm.

Thirdly, any group work along telepathic lines must be carefully controlled; any group effort which seeks to impress the mind of any subject (whether an individual or a group) must be guarded as to motive and method; any group endeavor

## M A T R I X I I I

which involves a united applied effort to effect changes in the point of view, an outlook on life, or a technique of living must be utterly selfless, most wisely and cautiously undertaken, and must be kept free from any personality emphasis, any personality pressure and any mental pressure which is formulated in terms of mental belief, prejudice, dogmatism or ideas.

The result of all true telepathic work and rightly directed effort to "impress" a subject will be to leave him with a strengthened will to right action, an intensified interior light, as astral body freer from the idea of glamour, and a physical body more vital and purer.

The potency of a united group activity is powerful. The occult aphorism that "energy follows thought" is either a statement of truth or else a meaningless phrase.

### Induction of Telepathic States by Ingestion of Substances

Several years ago, it was rumored that some company in Canada had produced a substance which, if ingested, gave individuals telepathic abilities. This was reported in 1990 in The Leading Edge in some detail. Obviously, the Canadian government stopped the company from continuing business. There are, however, natural substances that are reported to enhance telepathic ability. One of those substances comes from a woody vine known as Ayahuasca, which is found in Brazil. The vine contains a number of alkaloids with psychoactive properties - one of which has been called "telepatin", because it seems to turn those around you to glass, so that you can see through their bodies and read their minds. Lyall Watson, author of Beyond Supernature, tried it and vouches for this apparent effect. The most interesting thing about Ayahuasca is that it appears to have chameleon qualities. It is a door which opens on a variety of landscapes, connecting an individual to information sources in the animal kingdom .

### Telepathic Sensitivity

Telepathic sensitivity should be and always is a normal unfoldment when the individual is correctly oriented and completely dedicated. If it is a forced process, then development does not occur correctly. Where the individual on a path of conscious initiation is concerned, release from the constant consideration of personal circumstances and problems leads inevitably to a clear mental release; this then provides areas of free mental perception which make the higher sensitivity possible. Sensitivity to impression involves the engendering of a magnetic aura upon which the highest impressions can play and come into the mind. This magnetic aura, as it were, begins to form from the first moment a



## M A T R I X I I I

contact with the soul is made. It deepens and grows as those contacts increase in frequency and become eventually a habitual state of consciousness.

Areas of sensitivity appear to pass through three stages. First, sensitivity to impression from other human beings. Secondly, sensitivity to group impression - the passage of ideas from group to group. The individual can become a receptive agent within any group of which he is a part, and this ability indicates progress on his part. Thirdly, sensitivity to hierarchical impressions from consciousness on higher levels.

The mental aura develops rapidly once an individual takes his own development consciously in hand, or once the polarization of the personality is upon the mental plane. The time will come when the mental energy will obscure the emotional or astral energy, and then the soul quality of love will create a substitute.

### Scientific Data About Telepathic Receiving States

Activation of the parasympathetic nervous system is associated with an increased degree of sensitivity for telepathy. When the para-sympathetic nervous system is activated, an increased amount of acetylcholine is released. A sense of traveling clairvoyance is also apparent, as well as relaxation, well-being, and pleasure. The para-sympathetic nervous system is mildly activated by an excess of negative ions in the atmosphere. It was found that an excess of negative ions significantly increased telepathy scores over control-level scores. It can also be mildly activated by use of the skeletal muscle system.

Scientific data has also be gained relative to telepathic scores and breathing. The highest scores in laboratory trials were associated with respiration through the left nostril. Charged ions collect on the roof of the nasal passage and exert a paramagnetic effect on the brain, or on the expansion of psi-plasma.

### Telepathic Reception

The first stage of correct telepathic reception is the registering of an impression; it is generally vague at the beginning, but as a thought, idea, purpose or intention becomes more concrete, it slips into the second stage which appears as a definite thoughtform; finally, that thoughtform makes its impact on the consciousness of the brain in the location lying just behind the area between the eyes and consequently in the area of the pituitary body. It can appear also in the region of the solar plexus center. For those who are conditioned by the elements of the personality, the

### M A T R I X I I I

impression is the factor of importance; their consciousness is impressed, and so sensitive is their response to the higher impression that they absorb the impression so that it becomes a part of their own energy.

Telepathic sending states are characterized by sympathetic nervous system activity. The sympathetic nervous system is activated by adrenalin-like compounds and is antagonistic to the parasympathetic nervous system. The sympathetic nervous system is associated with the fight or flight action or emotional conditions that embody a threat.

Telepathic sending states which are characterized by the use of the sympathetic nervous system are sometimes referred to as "crisis telepathy", which involves an sending individual who is under stress, prompted by need and carrying a message of biological significance. The literature and folklore of most people include such events. Reports of "crisis telepathy" are common enough in our own culture - many people claim to have direct knowledge of the sinking of the Titanic. Most of the best evidence comes from less technical, less skeptical cultures, and much of the evidence suggests that crisis calls are not so much broadcast as finely focused.

One interesting example concerns a Cajun from New Orleans, a tough 32 year old Creole who joined the crew of a fishing boat working deep waters at the north-west end of the Hawaiian islands. On the evening in question, they had been trawling and, in a quiet moment the man decided to go to the crew quarters. As he grabbed the hatch rail, he slipped and fell flat on his back on the deck below. Nobody saw the accident, and the man lay there, paralyzed and in pain. He was convinced that he was about to die, and wondered what would become of his young American friend Milly. He noticed that the time was 9:12 and then passed out.

On the main island 600 miles away, Milly was visiting the home of the boat's captain, passing the evening in a little social embroidery. The wife of the skipper was a full-blooded Samoan, who was intent on her needlework, chatting away cheerfully, until she felt what she later described as "a blow at the back of the head". She slipped semi-conscious to the floor and when she could speak, said "something very bad has happened on the boat". And then she added, "It isn't Bill" - her husband. When Milly looked at the clock on the wall, the time was 9:14. It was not until the early hours of the following morning that the Coast Guard called to tell her that the Creole had been landed on Kauai with a broken back and was being flown home.

One aspect of this case is that the sender was a man from a culture which, at least unconsciously, allows such things as this "crisis telepathy" to happen. The message was intended

## M A T R I X I I I

for a woman whose upbringing made her less receptive and, when she proved unresponsive, it appears to have been re-routed to another person nearby who was only indirectly involved, but whose cultural background and perceptual set made her more sympathetic. Once again, it seems that these things are goal-oriented and not only independent of distance, but also indifferent to route and means. It is only results that matter.

There have been cases where several species have worked together in a telepathic manner. J.B. Rhine at Duke University noticed such a case and called it a "team effect". In a series of tests on a California beach, Rhine buried a number of small wooden target boxes at random under four inches of sand that was flooded with twelve inches of water as the tide came in. Raking of the sand and subsequent disturbance by water and wind made it impossible to detect the sites visually and unlikely that the targets left olfactory or any other clues to their precise location. Two German shepherd dogs were able, in a series of 203 trials, to locate the hidden boxes underwater with a success rate of 38.9%. The odds against them doing so purely by chance were a billion to one. They were able to do this, provided that they were accompanied by their trainer and were being observed, from a distance and out of sight and hearing, by the person who had buried the boxes.

The book *Kinship With All Life* also relates cases where there is functional interaction between humans and other species.

### Factors For Successful Telepathic Work

Successful telepathic work is dependent upon the following factors: First, that there are no barriers existing between the receiver and the broadcaster. Such barriers would be lack of love or of sympathy, criticism and suspicion. Secondly, that the broadcaster is mainly occupied with the clarity of his symbol, with the word or thought, and not with the receiver. A quick glance toward the receiver, a momentary sending forth of love and understanding is sufficient to set up the rapport, and then attention must be paid to the clarity of the symbol. Thirdly, let the receivers think with love and affection of the broadcaster for a minute or two. Then let them forget the personality. A thread of energy, linking receiver and broadcaster, has been established and exists. Fourth, let the receivers work with detachment. Much interference and blockage to thoughtforms is caused by the receiver producing thoughtforms and ill-regulated mental energy.

## M A T R I X I I I

### Physical Theories of How Telepathy Works

1. Psi-Plasma Theory: One interesting theory that was put forth about telepathic interaction was that the flow of information needed something to flow on. The theory of a psychic plasma, or psi-plasma, was put forth in the early 1960's by Andrija Puharich. He reasoned that the body, through the behavior of the high potentials contained within the nervous system on a miniature scale, some as high as 3.6 million volts, generates a change in the gravitational constant in the field surrounding the body. A low field in a sending party and a higher than normal field in a receiving party permitted, within the direction vector created by intent and thought, a flow of information between the two people. It was a very interesting presentation of data that had a lot of scientific and mathematical basis.

2. Holographic Theory: Telepathy is a Function of the Holographic Nature of the Structure of the Universe

Charles Tart, a professor of psychology at the Davis Campus of the University of California, did some experiments with hypnosis which indicate a deep holographic interconnectedness between lifeforms. Tart found two graduate students hypnotize each other, in turn, and found that they both went into an altered state in which they both found themselves in the same hallucinated reality; the reality consisted of a beach of unearthly beauty. The sand sparkled like diamonds and the sea was filled with enormous frothing bubbles. The shoreline was dotted with translucent crystalline rocks pulsing with internal light.

The two graduate students set about exploring their newfound world, swimming in the ocean, talking between themselves, and studying the glowing rocks. When Tart questioned them about their apparent silence, they told him that in their shared world they *were* talking, a phenomenon Tart feels involved some kind of paranormal communication between them. In session after session, these two students continued to construct various realities, and all were as real, available to the senses and dimensionally realized as anything they had experienced in their normal waking state.

The various worlds constructed in these cases are perfect examples of holographic realities: three-dimensional constructs created out of interconnectedness, sustained by the flow of consciousness, and ultimately as plastic as the thought processes that generated it. The realities were three-dimensional, but the space was reportedly more flexible than the space of what people ordinarily experience and sometimes took on an elasticity the two students had no words to describe.

## M A T R I X I I I

Human consciousness may not be the only thing that participates in the creation of "reality fields" Remote viewing experiments have shown that people can accurately describe distant locations even when there are no human observers present at the locations. Similarly, subjects can identify the contents of a sealed box randomly selected from a group of sealed boxes and whose contents are therefore completely unknown.

This means that we can tap into reality itself to gain information. Consciousness pervades all matter, and "meaning" has an active presence in both mental and physical worlds. Remote viewing can be looked at as resonance of meaning conveyed from an object to mind. In this view, consciousness comprises and includes anything that can generate, receive, or use information. Thus, animals, viruses, DNA, machines, and so-called non-living objects may have all the prerequisite properties to take part in the creation of reality.

What must be grasped is that all that IS is ever present. What we are concerned with is the constant awakening to that which eternally IS, and to what is ever present in the environment. The aim must be to overcome the undue concentration upon the foreground of daily life which characterizes most people, the intense preoccupation with interior states or moods and the lack of sensitivity which characterizes the mass of humanity.

Many great teachers have spoken of the time when nothing secret would remain hidden and when all secrets would be shouted aloud from the rooftops. The growth of telepathic and psychic abilities will eventually tend to strip humanity of the ability to transgress against each other without being known for their transgressions.

As the race achieves increasingly a mental polarization through the developing attractive power of the mental principle, the use of language for the conveying of thoughts and communication will fall into disuse. According to some sources, it will take about 500 more years for the race to become consciously telepathic; telepathy, then, could be viewed as the seed of future racial potency and ability. It is a process which proceeds through the medium of telepathic groups and telepathic people, and through the medium of scientific investigation. This also involves the building of the thoughtform which will accustom the race to the idea of telepathic work. It is, in the last analysis, the seed of Masterhood.



# M A T R I X I I I

## Chapter 2

### NATURAL FIELDS AND PHYSICS

The material in this chapter is being related to you in order to provide you will some background on the natural fields which interact with the human organism, so that you will be better prepared to deal with material in subsequent chapters.

#### I. The Holographic Field Aspects of the Universe

A phenomena called a hologram is produced when a single beam of laser light is split into two separate beams. The first beam is bounced off the object to be photographed. The second beam is allowed to collide with the light of the first beam. When this happens, an interference pattern is created and is recorded on film. To the naked eye, the interference pattern recorded on the film looks nothing like the original object - it looks like a series of concentric rings like those formed when a handful of pebbles is thrown into a pool of water. As soon as another laser beam or another bright light source is focused on the film, the image of the original object appears - in 3-D. You can actually walk around a holographic projection and view it from different angles.

Over the years many theories have been put forth to take into account all the phenomena observed in physics, psychic states and the various aspects of memory and perception. No theory has been able to explain all of them with the exception of one - that the universe, which includes our consciousness, is holographic in nature.

There are two scientists in particular who have also reached this conclusion, both independently of each other.

One of them is David Bohm, a protege of Albert Einstein, and the other is Carl Pribram, a neurophysiologist at Stanford University. David Bohm became convinced of the holographic nature of the universe only after years of dissatisfaction with the inability of existing theories to explain all of the phenomenon encountered in quantum physics. Carl Pribram became convinced because of the failure of standard theories about the brain to explain various puzzling neurological phenomena.

Another nagging problem on the theoretical side was the inability of any one theory about the nature of reality to explain or account for various phenomena encountered in nature. The holographic model does this, and a whole lot more.

The most staggering thing about the holographic model is that it makes sense out of other phenomena that are usually outside the realm of scientific understanding, like telepathy, pre-cognition, remote viewing, and psycho-kinesis.

## M A T R I X I I I

Numerous studies have corroborated the holographic model in studies of memory and perception. In 1982, landmark experiment performed by physicist Elaine Aspect demonstrated that the sub-atomic particles that compose the physical universe possesses what appears to be an undeniable holographic property.

### A Look At Human Memory

The human brain is estimated to be able to store information in the quantity between  $1 \times 10^{11}$  (one hundred trillion) and  $2.8 \times 10^{20}$  (280 quintillion) bits of information.

Research into the concept of memory indicates that there appear to be several different aspects of memory :

Short Term Memory: The average capacity of short-term memory is about seven bits of data, which are linked together in "chunks" so that longer assemblies of them can be remembered - short-term memory can by definition last from several seconds to several minutes. The part of the brain called the hippocampus is a critical structure in the transfer of short-term memory into long-term storage. Short-term memory typically consists of images, thoughts, or "bits" of data persisting for a short period of time.

Long Term Memory: Long-term memory consists of those elements that are transferred from short-term memory into long-term storage. In order to do this, the memory must be "encoded" or "marked"; the encoding of a memory involves a process of continued attention, as well as a certain amount of emotional input.

Semantic Memory: The capacity to remember words as opposed to numbers or pictures.

Eidetic Memory: Eidetic memory is a very specific memory function in which, after one has viewed an object or scene, an intensely strong visual image persists when the object or scene is removed. The image remains very vivid at the spot where the object was located, and the location may even be scanned with eye movements, as if the object were still there. To be "classified" as eidetic, the image must persist for at least 40 seconds. Interestingly, children possess more capability in this area than adults. It is thought that the phasing in of language offsets this ability or capacity of the brain.

Iconic Memory: Iconic memory is also referred to as "intermediate memory"; the duration is between STM and LTM. It is



## M A T R I X I I I

sometimes used to describe visual memory that lasts only a tenth of a second or so.

Habit Memory: A non-cognitive type of memory that has been also referred to as "procedural" memory. It is an automatic memory process that encompasses conditioned reflexes. Information is entered into this type of memory through the sub-cortical basal ganglia structures in the brain. Neural representations are not stored, but rather probabilities existing in relationships between stimulus and response. It could also be termed "memory without consciousness", and is often associated with the memory traits of savants.

Savant Memory: Memory functions that are manifested in a way that is devoid of emotion, automatic and non-volitional, and not reflective or associational.

Visual Image Memory: Visual image memory involves the ability to scan quickly and store, for later recall, vast amounts of extremely detailed and minute information. It is popularly referred to as "photographic memory". Compared to eidetic imagery, the image is retained "in the head".

Figural Memory: Memory involved with recall of pictures.

Cognitive/Associative Memory: Involves the three elements of recognition, retention, and recall. It uses circuits within a "cortico-limbic" system, relying heavily on the hippocampus and amygdala linkage to the cortex where the processed images are stored for later recall. The content of the storage is information or knowledge, and the process for which the system is responsible is termed cognition. Contained within the scope of cognitive/associative memory are "episodic memory", "vertical associative memory", and "declarative knowledge and processing."

Ancestral Memory: Ancestral memory is looked at as being genetically inherited memory, which is manifested in various instinctual behaviors. It can also include, by virtue of genetics, memory traits or abilities.

Numerous studies have corroborated the holographic model in studies of memory and perception. The question of how and where memories are stored was what led Carl Pribram on the road to formulating his holographic model. In the 1940's it was thought that memories were stored at specific locations in the brain. There had been research conducted in the 1920's which seemed to support this view. Researcher Wilder Penfield had offered convincing evidence that specific memories had specific locations in the brain. In a series of experiments, Penfield stimulated parts of the brain of patients and noticed that specific areas evoked certain specific memories.

## M A T R I X I I I

In 1946, Pribram went to work for physiologist Carl Lashley at the Yerkes Institute of Primate Biology. Lashley had trained rats to perform complicated tasks which involved working their way through mazes. He then removed portions of their brain in an effort to try and remove the area that had the memory of the maze. No matter how much brain tissue he removed, the rats still retained the memory of how to run the maze. This indicated that memory itself was not localized but was somehow spread throughout the brain as a whole. No process existed at the time that would explain this. Around 1965, Pribram read an article describing the creation of the hologram and the answer became quite clear.

Holograms depend on the interference patterns that occur when the patterns of two or more waves ripple through each other. It was discovered that electrical impulses travel through the brain in waveforms that cause interference patterns, further substantiating the holographic nature of the brain.

Another aspect of holograms is that if you take a piece of the hologram and remove it, the piece contains the complete picture of what the total hologram contained. The ability of the brain to preserve memory functions evidently works the same way. Memory is not the only aspect that the brain processes in a holographic way. It was discovered that vision is processed in the same manner.

The apparent ability of the brain to create an internal hologram explains the lack of any one-to-one correspondence between the external world and the activity of the brain. The only question that remained was, what wavelike phenomenon was the brain using to create internal holograms? It was known that electrical impulses travel in waves throughout the brain. This turned out to be part of the process that creates internal holograms.

Holography also explains how the brain can store so many memories in so little space. Mathematician John Von Neumann, who has achieved some notoriety because of his alledged involvement with the Philadelphia Experiment (Project Rainbow) and the subsequent Phoenix Projects, calculated that over the course of a human lifetime, the brain stores  $2.8 \times 10^{20}$  bits of information (2,800,000,000,000,000,000 bits), as mentioned.

Another interesting aspect of the hologram is that by changing the angle with which the light from the laser strikes the photographic film, it was discovered that many 3-D images could be stored on the same piece of film. It has been suggested that our ability to recall data is equivalent to changing the wavefront angle that passes through the brain. When we are unable to recall data, it may be equivalent to failing to find the right angle.

## M A T R I X I I I

The holographic aspect offers additional understanding about the associative aspects of memory. There is another type of holographic recording technique in which the light of a single laser beam is bounced off two objects simultaneously. The light bounced off each object is allowed to collide and the interference pattern is captured on film. Whenever one of the objects is illuminated with laser light, and this light is passed through the photographic plate, the image of the other object will appear. If the human brain function is holographic in nature, a similar process might explain why certain things evoke memories of other things. Other types of holography, such as recognition holography and interference holography, may explain how we can recognize familiar things and also recognize the face of someone we have not seen for years.

### Conversion of Waveform Patterns in the Brain By the Use of Fourier Transformations

Research seems to indicate that in the brain, complex patterns are converted into simple waveforms. During the last century, a mathematician named Fourier evolved what later became known as Fourier Transforms which accomplish the same task - conversion of complex waveforms (interference patterns) into simple waveforms or conversion of images to waveforms and back again. The "whole-in-every-part" aspect of holograms is one of the by-products that occur when interference patterns are translated into the Fourier language of waveforms.

### The Visual Systems of the Brain

In the early 1970's researchers discovered that the visual systems in the brain functioned as a kind of frequency analyzer. Since frequency is a measure of the number of oscillations per unit of time, it suggests again that the brain functions in the same way that a hologram does. Later, in 1979, Berkeley physicists Russell and Karen DeValois discovered that in vision, the brain responds not to the patterns of what a person sees, but to the Fourier translations of the patterns. Thus, the brain definitely is making use of Fourier mathematics to convert images into waveforms. This discovery was subsequently confirmed by other labs around the world.

Another aspect of the visual system of the brain is that the brain is actually what "sees". The eyes only conduct specific frequencies into the brain. Since there is considerable evidence to support the practice of "eyeless sight", seeing what is around you, including colors, without the use of the eyes, the brain can be seen as a receiver, translating frequencies impacting it from the exterior into waveforms or images that are perceived by consciousness.

FOURIER TRANSFORMATION EQUATIONS

The following set of pages illustrates the usage of Fourier Transformations in the conversion of waveforms, and is fairly technical. If you have no engineering background, just lightly examine the pages and proceed to the text following this section .

FOURIER SERIES

(Also see Index for Cosine and Sine Transforms)

1. If  $f(x)$  is a bounded periodic function of period  $2L$  (i.e.  $f(x + 2L) = f(x)$ ), and satisfies the *Dirichlet conditions*:

- a) In any period  $f(x)$  is continuous, except possibly for a finite number of jump discontinuities.
- b) In any period  $f(x)$  has only a finite number of maxima and minima.

then  $f(x)$  may be represented by the *Fourier series*

$$\frac{a_0}{2} + \sum_{n=1}^{\infty} \left( a_n \cos \frac{n\pi x}{L} + b_n \sin \frac{n\pi x}{L} \right),$$

where  $a_n$  and  $b_n$  are as determined below. This series will converge to  $f(x)$  at every point where  $f(x)$  is continuous, and to

$$\frac{f(x^+) + f(x^-)}{2}$$

(i.e. the average of the left-hand and right-hand limits) at every point where  $f(x)$  has a jump discontinuity.

$$a_n = \frac{1}{L} \int_{-L}^L f(x) \cos \frac{n\pi x}{L} dx, n = 0, 1, 2, 3, \dots ;$$

$$b_n = \frac{1}{L} \int_{-L}^L f(x) \sin \frac{n\pi x}{L} dx, n = 1, 2, 3, \dots$$

**FOURIER SERIES (Continued)**

we may also write

$$a_n = \frac{1}{L} \int_{\alpha}^{\alpha+2L} f(x) \cos \frac{n\pi x}{L} dx \text{ and } b_n = \frac{1}{L} \int_{\alpha}^{\alpha+2L} f(x) \sin \frac{n\pi x}{L} dx,$$

where  $\alpha$  is any real number. Thus if  $\alpha = 0$ ,

$$a_n = \frac{1}{L} \int_0^{2L} f(x) \cos \frac{n\pi x}{L} dx, \quad n = 0, 1, 2, 3, \dots ;$$

$$b_n = \frac{1}{L} \int_0^{2L} f(x) \sin \frac{n\pi x}{L} dx, \quad n = 1, 2, 3, \dots$$

2. If in addition to the above restrictions,  $f(x)$  is even (i.e.  $f(-x) = f(x)$ ), the Fourier series reduces to

$$\frac{a_0}{2} + \sum_{n=1}^{\infty} a_n \cos \frac{n\pi x}{L}.$$

That is,  $b_n = 0$ . In this case, a simpler formula for  $a_n$  is

$$a_n = \frac{2}{L} \int_0^L f(x) \cos \frac{n\pi x}{L} dx, \quad n = 0, 1, 2, 3, \dots$$

3. If in addition to the restrictions in (1),  $f(x)$  is an odd function (i.e.  $f(-x) = -f(x)$ ), then the Fourier series reduces to

$$\sum_{n=1}^{\infty} b_n \sin \frac{n\pi x}{L}.$$

That is,  $a_n = 0$ . In this case, a simpler formula for the  $b_n$  is

$$b_n = \frac{2}{L} \int_0^L f(x) \sin \frac{n\pi x}{L} dx, \quad n = 1, 2, 3, \dots$$

4. If in addition to the restrictions in (2) above,  $f(x) = -f(L - x)$ , then  $a_n$  will be 0 for all even values of  $n$ , including  $n = 0$ . Thus in

FOURIER SERIES (Continued)

this case, the expansion reduces to

$$\sum_{m=1}^{\infty} a_{2m-1} \cos \frac{(2m-1)\pi x}{L}$$

5. If in addition to the restrictions in (3) above,  $f(x) = f(L - x)$ , then  $b_n$  will be 0 for all even values of  $n$ . Thus in this case, the expansion reduces to

$$\sum_{m=1}^{\infty} b_{2m-1} \sin \frac{(2m-1)\pi x}{L}$$

(The series in (4) and (5) are known as *odd-harmonic series*, since only the odd harmonics appear. Similar rules may be stated for even-harmonic series, but when a series appears in the even-harmonic form, it means that  $2L$  has not been taken as the smallest period of  $f(x)$ . Since any integral multiple of a period is also a period, series obtained in this way will also work, but in general computation is simplified if  $2L$  is taken to be the smallest period.)

6. If we write the Euler definitions for  $\cos \theta$  and  $\sin \theta$ , we obtain the complex form of the Fourier Series known either as the "Complex Fourier Series" or the "Exponential Fourier Series" of  $f(x)$ . It is represented as

$$f(x) = \frac{1}{2} \sum_{n=-\infty}^{n=+\infty} c_n e^{i\omega_n x}, \text{ where}$$

$$c_n = \frac{1}{L} \int_{-L}^L f(x) e^{-i\omega_n x} dx, n = 0, \pm 1, \pm 2, \pm 3, \dots$$

with  $\omega_n = \frac{n\pi}{L}, n = 0, \pm 1, \pm 2, \dots$

The set of coefficients  $\{c_n\}$  is often referred to as the Fourier spectrum.

7. If both sine and cosine terms are present and if  $f(x)$  is of period  $2L$  and expandable by a Fourier series, it can be represented as

$$f(x) = \frac{a_0}{2} + \sum_{n=1}^{\infty} c_n \sin \left( \frac{n\pi x}{L} + \phi_n \right), \text{ where } a_n = c_n \sin \phi_n,$$

$$b_n = c_n \cos \phi_n, c_n = \sqrt{a_n^2 + b_n^2}, \phi_n = \arctan \left( \frac{a_n}{b_n} \right)$$

FOURIER SERIES (Continued)

It can also be represented as

$$f(x) = \frac{a_0}{2} + \sum_{n=1}^{\infty} c_n \cos\left(\frac{n\pi x}{L} + \phi_n\right), \text{ where } a_n = c_n \cos \phi_n,$$

$$b_n = -c_n \sin \phi_n, c_n = \sqrt{a_n^2 + b_n^2}, \phi_n = \arctan\left(-\frac{b_n}{a_n}\right)$$

where  $\phi_n$  is chosen so as to make  $a_n$ ,  $b_n$ , and  $c_n$  hold.

8. The following table of trigonometric identities should be helpful for developing Fourier Series.

	$n$	$n$ even	$n$ odd	$n/2$ odd	$n/2$ even
$\sin \frac{n\pi}{2}$	0	0	0	0	0
$\cos \frac{n\pi}{2}$	$(-1)^n$	+1	-1	+1	+1
$\sin \frac{n\pi}{4}$		0	$(-1)^{(n-1)/2}$	0	0
* $\cos \frac{n\pi}{4}$		$(-1)^{n/2}$	0	-1	+1
* $\sin \frac{n\pi}{4}$			$\frac{\sqrt{2}}{2} (-1)^{(n^2+4n+11)/8}$	$(-1)^{(n-2)/4}$	0

\* A useful formula for  $\sin \frac{n\pi}{2}$  and  $\cos \frac{n\pi}{2}$  is given by

$$\sin \frac{n\pi}{2} = \frac{(i)^{n+1}}{2} [(-1)^n - 1] \text{ and } \cos \frac{n\pi}{2} = \frac{(i)^n}{2} [(-1)^n + 1], \text{ where } i^2 = -1.$$

(See index for Cosine and Sine Transforms)

AUXILIARY FORMULAS FOR FOURIER SERIES

$$1 = \frac{1}{\pi} \left[ \sin \frac{\pi x}{k} + \frac{1}{3} \sin \frac{3\pi x}{k} + \frac{1}{5} \sin \frac{5\pi x}{k} + \dots \right] \quad [0 < x < k]$$

$$x = \frac{2k}{\pi} \left[ \sin \frac{\pi x}{k} - \frac{1}{2} \sin \frac{2\pi x}{k} + \frac{1}{3} \sin \frac{3\pi x}{k} - \dots \right] \quad [-k < x < k]$$

$$x = \frac{k}{2} - \frac{4k}{\pi^2} \left[ \cos \frac{\pi x}{k} + \frac{1}{3^2} \cos \frac{3\pi x}{k} + \frac{1}{5^2} \cos \frac{5\pi x}{k} + \dots \right] \quad [0 < x < k]$$

$$x^2 = \frac{2k^2}{\pi^3} \left[ \left(\frac{\pi^2}{1} - \frac{1}{1}\right) \sin \frac{\pi x}{k} - \frac{\pi^2}{2} \sin \frac{2\pi x}{k} + \left(\frac{\pi^2}{3} - \frac{1}{3^3}\right) \sin \frac{3\pi x}{k} - \frac{\pi^2}{4} \sin \frac{4\pi x}{k} + \left(\frac{\pi^2}{5} - \frac{1}{5^3}\right) \sin \frac{5\pi x}{k} + \dots \right] \quad [0 < x < k]$$

# M A T R I X I I I

## FOURIER EXPANSIONS FOR BASIC PERIODIC FUNCTIONS

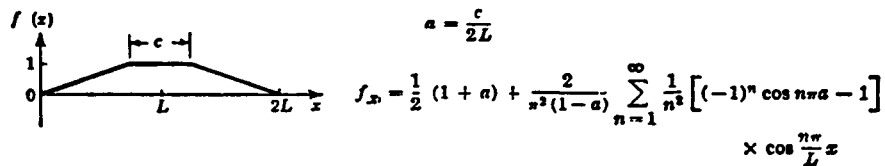
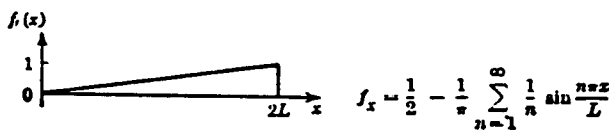
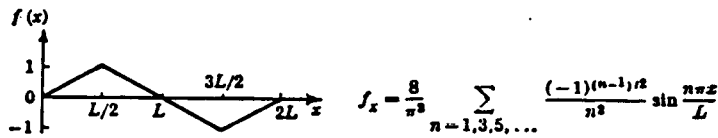
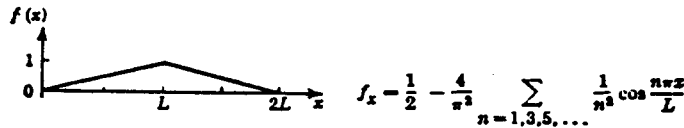
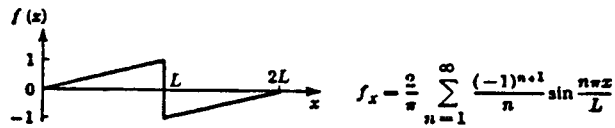
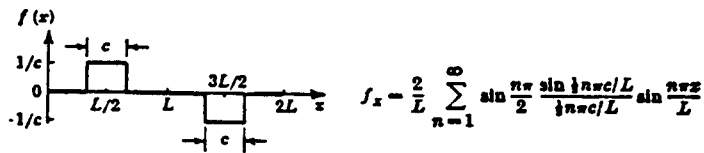
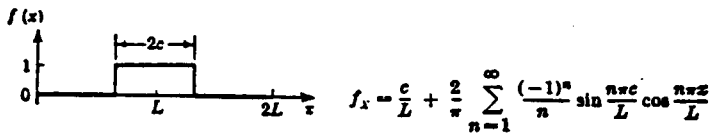
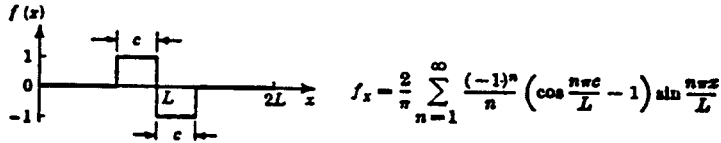
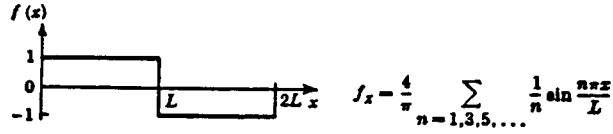



# M A T R I X I I I

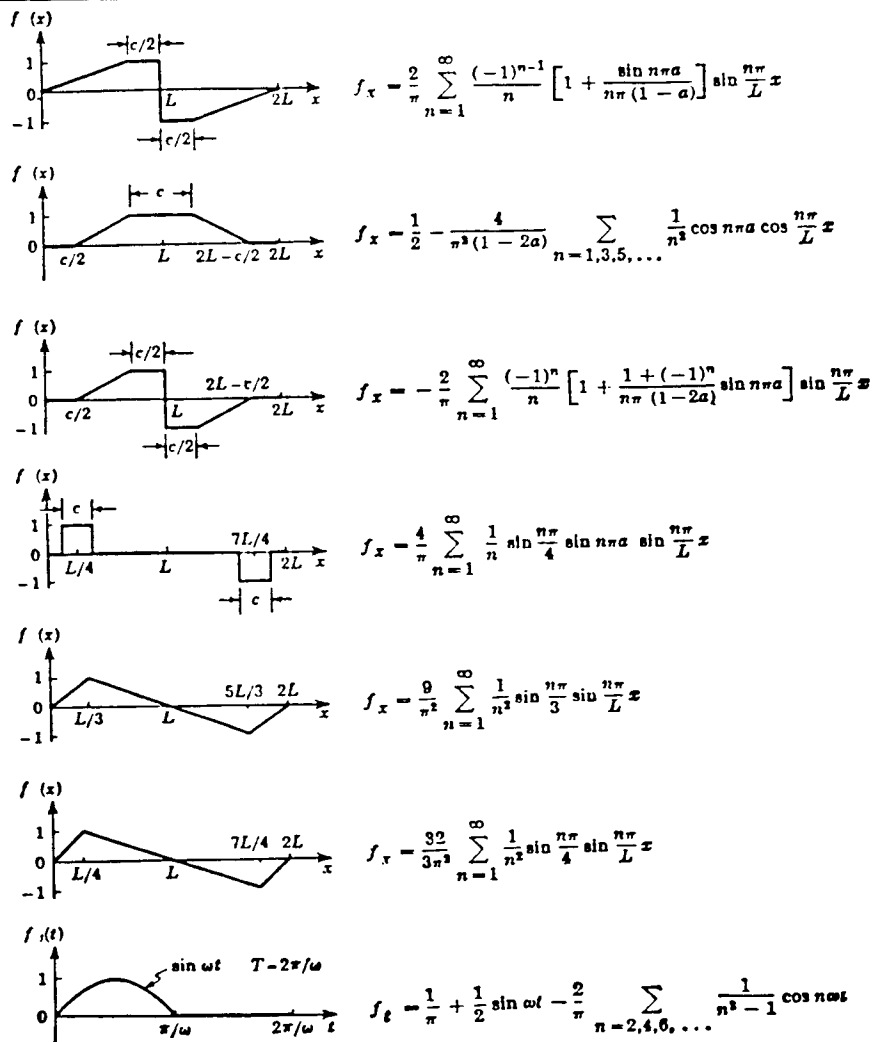

**19. Expansion of Functions in Fourier Series.** This section contains some illustrative examples of expansion of functions, satisfying the Dirichlet conditions in the interval  $(-\pi, \pi)$ , in the series

$$(19-1) \quad \frac{a_0}{2} + \sum_{n=1}^{\infty} (a_n \cos nx + b_n \sin nx),$$

where the coefficients  $a_n$  and  $b_n$  are given by the formulas

$$(19-2) \quad a_n = \frac{1}{\pi} \int_{-\pi}^{\pi} f(x) \cos nx \, dx$$

and

$$(19-3) \quad b_n = \frac{1}{\pi} \int_{-\pi}^{\pi} f(x) \sin nx \, dx.$$

*Illustrative Example 1.* Expand  $f(x) = x$  in Fourier series in the interval  $-\pi \leq x \leq \pi$ . Calculating the coefficients  $a_n$  and  $b_n$  gives

$$a_n = \frac{1}{\pi} \int_{-\pi}^{\pi} x \cos nx \, dx = 0,$$

and

$$b_n = \frac{1}{\pi} \int_{-\pi}^{\pi} x \sin nx \, dx = -\frac{2}{n} \cos n\pi.$$

Hence,

$$x = 2[(-1)^1 \cos \pi \sin x + (-\frac{1}{2} \cos 2\pi) \sin 2x + (-\frac{1}{3} \cos 3\pi) \sin 3x + \dots]$$

or

$$x = 2 \left( \sin x - \frac{\sin 2x}{2} + \frac{\sin 3x}{3} - \dots \right).$$

In this particular case, only the sine terms remain. It may be noted that whenever the function  $f(x)$  is an odd function, that is, when  $f(-x) = -f(x)$ , then  $a_n = 0$ , for  $n = 0, 1, 2, \dots$ , since, for such a function,

$$\int_{-\pi}^0 f(x) \cos nx \, dx = -\int_0^{\pi} f(x) \cos nx \, dx.$$

Similarly, if  $f(x)$  is an even function, that is, when  $f(-x) = f(x)$ , then  $b_n = 0$ , for  $n = 1, 2, 3, \dots$ , since

$$\int_{-\pi}^0 f(x) \sin nx \, dx = -\int_0^{\pi} f(x) \sin nx \, dx,$$

so that the function would be represented by a series of cosine terms.

If in the foregoing illustration the first four terms be plotted by composition of

$$y = 2 \sin x, \quad y = -\sin 2x, \quad y = \frac{2}{3} \sin 3x, \quad y = -\frac{1}{2} \sin 4x,$$

the curve

$$y = 2 \sin x - \sin 2x + \frac{2}{3} \sin 3x - \frac{1}{2} \sin 4x$$

is obtained. It is represented on Fig. 10. As the number of terms is increased, the approximating curves approach  $y = x$  as a limit for all values of  $x$ ,  $-\pi < x < \pi$ , but not for  $x = \pm\pi$ . Since the series has period  $2\pi$ , it represents the discontinuous function shown in Fig. 11 by a series of parallel lines. It should be noted that each term of the series is continuous and the function from which the series was derived is continuous, but the function represented by the series has finite discontinuities at

FOURIER SERIES

$x = \pm(2k + 1)\pi$ . At such points the series converges to zero, which is one-half the value of the sum of the right- and left-hand limits.

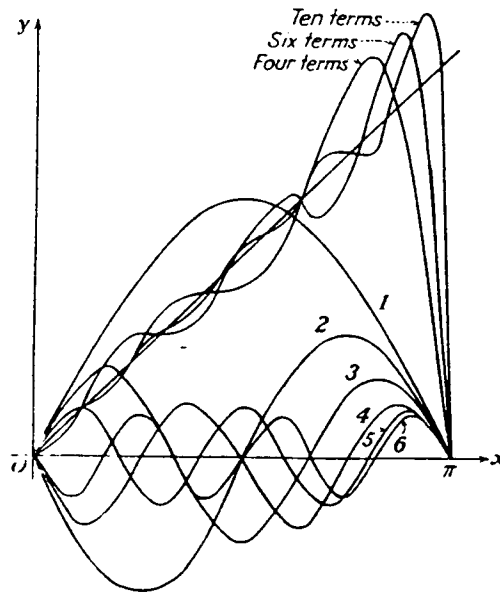

FIG. 10.

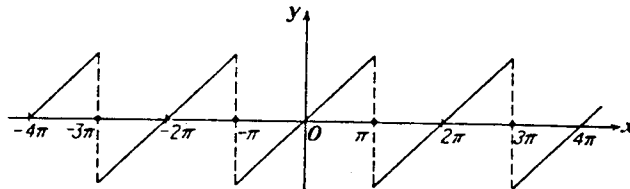

FIG. 11.

*Illustrative Example 2.* Develop  $f(x)$  in Fourier series in the interval  $(-\pi, \pi)$ , if

$$f(x) = \begin{cases} 0, & \text{for } -\pi < x < 0, \\ \pi, & \text{for } 0 < x < \pi. \end{cases}$$

Now

$$a_0 = \frac{1}{\pi} \left( \int_{-\pi}^0 0 \cdot dx + \int_0^{\pi} \pi dx \right) = \pi,$$

$$a_n = \frac{1}{\pi} \int_0^{\pi} \pi \cos nx dx = 0,$$

$$b_n = \frac{1}{\pi} \int_0^\pi \pi \sin nx \, dx = \frac{1}{n} (1 - \cos n\pi).$$

The series is then

$$\frac{\pi}{2} + 2 \left( \frac{\sin x}{1} + \frac{\sin 3x}{3} + \frac{\sin 5x}{5} + \dots \right).$$

The graph of  $f(x)$  from  $-\pi$  to  $\pi$  consists of the  $x$ -axis from  $-\pi$  to  $0$ , and the line  $AB$  from  $0$  to  $\pi$  (see Fig. 12). There is a finite discontinuity for  $x = 0$ . For  $x = 0$  the series reduces

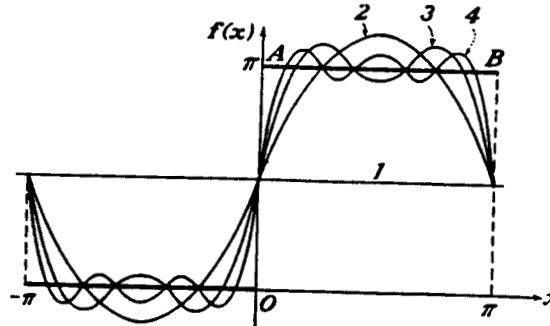

FIG. 12.

to  $\pi/2$ , which is equal to half the sum of  $\lim_{\epsilon \rightarrow 0} f(0 - \epsilon)$  and  $\lim_{\epsilon \rightarrow 0} f(0 + \epsilon)$ . It may be observed from the series that every approximation curve will pass through the point  $(0, \pi/2)$ . The figure shows the first, second, third, and fourth approximation curves, whose equations are

$$y = \frac{\pi}{2}, \quad y = \frac{\pi}{2} + 2 \sin x, \quad y = \frac{\pi}{2} + 2 \left( \sin x + \frac{\sin 3x}{3} \right),$$

$$y = \frac{\pi}{2} + 2 \left( \sin x + \frac{\sin 3x}{3} + \frac{\sin 5x}{5} \right),$$

as well as the graph of  $f(x)$ .

At  $x = \pm\pi$  the series reduces to  $\pi/2$ , and again every approximation curve gives this same value for the ordinate at  $\pm\pi$ . This value is one-half the sum of  $f(-\pi+)$  and  $f(\pi-)$ .

## M A T R I X I I I

### Other Senses and Frequency Analysis Using Fourier Transformations

It was eventually discovered that all the senses involved analysis of frequency; the sense of smell, for instance, involves what are termed "osmic frequencies". Work done by the scientist Bekesy and others has demonstrated that the skin is sensitive to frequencies and vibrations. Interestingly, Bekesy also discovered that the mathematical equations that predicted how his subjects would respond to various frequencies were Fourier Translations. Russian physicist Nickoli Bernstein made the discovery that even our physical movements were encoded in the brain in the language of Fourier Transforms. If the brain analyzes movements by breaking them down into their frequency components, it explains the rapid rate at which we learn many complex tasks. In effect, the brain is Fourier analyzing various aspects of complex tasks and absorbing them as a whole. In th 1970's Pribram discovered that selected neurons in the motor cortex respond to a limited bandwidth of frequencies.

In Matrix II we discussed the use of the process of "inculcation" that is performed on various species, including humans, to impart vast amounts of knowledge - especially task related knowledge. Fourier Transforms no doubt play a significant part in this process, as well as in processes that implant "screen memories" in those who are abducted. Processes that electronically manipulate consciousness and the brain can easily incorporate Fourier processes to impart a stream of images and other data while areas in the brain, like the hippocampus, can be influenced to affect memory processes.

### Holographic Aspects of Particles and Waves

If the holographic model of the brain is taken to its logical conclusion, it opens the door on the possibility that even "objective reality", the world of objects around us, might not exist in the way we believe it exists. It seems likely that what is really "out there" is a vast resonating symphony of waveforms that comprise a frequency domain that is transformed into what is perceived only after it enters the brain.

Work done by Bohm at Pennsylvania State College indicates that if you break matter down far enough, the "pieces" no longer have the traits normally considered to be possessed by "objects". Although an electron can sometimes behave as if it were a compact little particle, it was found that it literally possesses no dimension. An electron is simply not an "object" as usually define an "object". An electron can sometimes behave as a "particle" or behave as a "wave". This ability is common to all "sub-atomic particles". Physicists believe that

## M A T R I X I I I

sub-atomic phenomena should be viewed as a single category of something that is somehow both a "particle" and a "wave"; the "something" is called a quanta.

There is compelling evidence that the only time quanta manifest as particles is *when we are looking at them*, which indicates that consciousness plays an important part in the transformation of matter. When an electron is not being looked at, experimental findings suggest that it is always a "wave".

### Connections between Sub-Atomic Events Indicating Quanta Possess Consciousness

An aspect of quantum reality that is especially interesting is the state of inter-connectedness that is seen to exist between apparently unrelated sub-atomic events. At the Berkeley Radiation Laboratory, David Bohm did some vital work with plasmas. A plasma is a gas containing a high density of electrons and positive ions (atoms that have a positive charge).

Bohm found that once electrons were in a plasma, they stopped "behaving" like individuals and started "behaving" as if they were part of a larger inter-connected whole. Like some amoeboid creature, the plasma constantly regenerated itself and enclosed impurities within a wall, in the same way that a biological organism might encase a foreign substance. The collective movement of electrons in this manner was given the expression "plasmons", and their discovery established Bohm's reputation as a physicist.

During this same period, it was discovered that the idea of "wholeness" had importance. Classical science looks at the idea of wholeness as the "sum of the reaction of its parts". What was indicated was that the behavior of the "parts" was actually organized by the whole. This suggests that the idea of wholeness is the primary aspect of reality.

### The Concept of Non-Locality

Many interesting things have been discovered in quantum physics. One of the findings involves the idea of *location*. At the level of our everyday lives, things appear to have specific locations. However, when one examines all the data that has come from investigations at the quantum level, location ceases to exist. All points in space become equal to all other points in space. Physicists have termed this property as *non-locality*.

## M A T R I X I I I

### The Concept of Order

Classical science generally appears to divide things into ideas of ordered and disordered states of arrangement. As physicists delved more deeply, it was realized that there was no end to the hierarchies of order, and that there is no such thing as disorder. Orders of an ultr-high degree appear as random from a lower perspective. Interestingly, mathematicians are unable to prove the existence of randomness. What we perceive to be a tangible reality is really kind of an illusion. Underlying it is a deeper order of existence that gives birth to all objects and the appearances of objective reality in the same way that a piece of holographic film gives birth to a hologram. There is overwhelming evidence that this deeper order of existence has one source: consciousness.

Physicists terms this deeper level of reality the *implicate* or *enfolded* order, and the perceived level of existence as the *explicate* or *unfolded* order. The manifestation of all forms in the universe are increasingly seen as stages of countless enfoldings and unfoldings between these two types of order. When a "particle" appears to be destroyed, for instance, it is not lost. It is merely enfolded back into the deeper order from which it came.

Because everything in the universe appears to be made out of the fabric of the implicate order, which is from one perspective the potential of everything within the void, it becomes meaningless to view the universe as being composed of separate parts. Everything in the universe becomes part of a continuum. Everything is an extension of everything else, and ultimately even the implicate and explicate orders blend into each other.

### The Holographic Aspect of Consciousness

We have seen that there is an apparent relationship between the various state of quanta and consciousness; when it is examined it takes on the attributes of a waveform. When it is unexamined it seems to behave as a particle. There is evidence that consciousness and matter are subtle forms of each other. The relationship between the two lies in the implicate order. Consciousness is present in varying degrees of enfoldment and unfoldment in all matter, which is perhaps why plasmas possess some of the traits of living things.

It is because of the relationship between consciousness and matter and the holographic nature of both that every portion of the universe contains the whole; all the "past" and all the "future" also is enfolded in every point in the universe. Every cell in the body enfolds the universe.

## M A T R I X I I I

### The Holographic Aspects of Perception

Numerous studies have shown that less than 50% of what we see is actually based on information entering the eyes. The remaining 50%+ is pieced together out of our expectations of what everything should look like. This is why we don't notice when a friend shaves off a moustache and why the house looks a little different when we return from a trip.

Taking into account what we have previously discussed, what we call "reality" is really a large frequency domain, and our brain is a kind of "lens" that converts these frequencies into the "objective world of appearances". Thus, the term "frequency domain" could be used to describe the interference patterns that compose the implicate order.

When people are able to see the energy bands which surround a human being, those bands normally referred to as the "aura", they are seeing some of the frequency aspects of reality. The ability to see these "bands" is common. In their book "Future Science", writer John White and parapsychologist Stan Krippner describe 97 different cultures, each of which have their own designations for these bands. These bands have qualities unlike the kinds of energy with which we are normally familiar. These bands together compose a type of field - this field has characteristics which demonstrate a type of non-locality - they can manifest as an amorphous blur of energy and have, on occasion, been observed to form into three dimensional images which usually reflect thoughts of objects or ideas that occupy a prominent position in the thoughts of the person around whom they are seen.

The images that have been seen in the "bands" around the human being are not always static. They are very often moving and sometimes manifest color. Sometimes, after subsequent checking with the individual around whom they exist, it has been found that they have portrayed a string of images that depict a "story" about the person; this process has sometimes gone on for a period lasting over an hour. Some of these images may be representations from the "unconscious" areas in the mind.

### Range of Body Frequencies

Valerie Hunt, a professor at UCLA for the last twenty years, encountered a dancer who stated that she used her own energy field to help her dance. Intrigued, Hunt was inspired to make electromyograms (EMG) of the woman's muscle activity while she danced. She was also moved to study the effect healers had on the people being healed and also people who could see the human energy field, and it was here that she made some of her most significant discoveries.



## M A T R I X I I I

The normal frequencies of the electrical activity in the human brain lie between 0 cps and 100 cps, with most of the activity occurring between 0 cps and 30 cps. Muscle frequencies appear to go up to about 250 cps, and the heart goes up to about 250 cps. Beyond this, electrical activity which is normally associated with biological type functions appears to drop off. Other researchers have produced more data. Andrija Puharich indicates that the resonant frequency of a normal nerve is approximately 360 cps.

Hunt discovered that the EMG could pick up another field of energy radiating from the body, much subtler and smaller in amplitude than "traditionally" recognized body currents, but with frequencies that averaged between 100 cps and 1600 cps. Some went even higher. Field strength seemed to be strongest in the area of the body associated with the chakras.

Hunt pointed out that the energy field surrounding the body, and indeed all the body's electrical systems, is holographic in another way. Like the information in a hologram, these systems are distributed globally throughout the body. For instance, the kind of electrical activity measured by an EEG is strongest in the brain, but it can also be measured anywhere else in the body. This is also true of EKG type readings. Typically, the amplitude varies from location to location, but the frequency and patterns remain the same.

One of Hunt's most startling findings was that when the focus of a person's consciousness was on the material world, the frequencies of their energy field tended to be in the lower range and not too far removed from the 250 cps of the body's biological frequencies. People who demonstrated strong psychic and healing abilities have frequencies of 400 to 800 cps in their field. People who can go into trance and apparently channel other information sources through them, skip these "psychic" frequencies entirely and operate in a narrow band between 800 and 900 cps.

According to Hunt, there are people who exhibit frequencies far above these. She has encountered people who exhibit frequencies as high as 200,000 cps.

### Other Aspects of the Human Energy Field

Frequency is not the only thing that is distributed holographically throughout the field. The information the field contains can be found in every portion of the field. The energy "bands" not only represent, but also contain, the whole.

There are a number of people who possess the ability called *internal vision*, in which they can see into the body as

### M A T R I X I I I

if it were made of glass. Australian shamans refer to this ability as "the strong eye" or "seeing with the heart". The implications of this are that the body is in actuality an energy construct and ultimately may be no more substantive than the energy field in which it is embedded.

There are, however, natural substances that are reported to create this effect, as well as enhance telepathic ability. One of those substances comes from a woody vine known as Ayahuasca, which is found in Brazil. The vine contains a number of alkaloids with psychoactive properties - one of which has been called "telepatin", because it seems to turn those around you to glass, so that you can see through their bodies and read their minds. Lyall Watson, author of *Beyond Supernature*, tried it and vouches for this apparent effect.

The idea that the physical body is just one more level of density in the human energy field and is itself a kind of hologram that has coalesced out of the interference patterns of the human energy field may explain both the extraordinary healing powers of the mind and the enormous control it has over the body in general. Because an illness can appear in the energy field before it manifests in the physical body, it would appear that the impetus for illness comes from non-physical levels.

All this suggests that the field around the body is more primary than the body and functions as a kind of blueprint from which the body gets its structural cues. Rupert Sheldrake brought this point out quite well in his book on morphological fields entitled *The Presence of the Past: Morphic Resonance and the Habits of Nature* (1988, Vintage Books). Put another way, the energy field may be the body's version of an implicate order. We are essentially programming the state of health of the body. This also means that the state of health of the body can be influenced through electronic means, which we will examine in the chapter about advanced mind control applications.

Hunt discovered that the human energy field responds to stimuli even before the brain does, which implies what many of us have known for a long time - that the mind is not in the brain - it is embedded in the energy bands surrounding the human body and its' field interpenetrates the body and brain structures.

If the mind is present in the energy bands, this supports another fact that many have known and some people have suspected - that the thinking, feeling part of ourselves is not confined just to the physical body.

It is probable that even time itself is not absolute, but unfolds out of the implicate order, and this suggests that the linear division of time into past, present and future is

## M A T R I X I I I

also another construct of the mind. All experiences are ultimately tied to neurological processes taking place in the brain, unless the individual's consciousness is functioning outside of a focus on the physical body. According to this holographic model, the reason we experience some things as external realities and other things as internal realities is due to *where the brain localizes them* when it creates the internal hologram that we experience as reality. Very often, the remembered image of a thing can have as much impact as the thing itself. Ask any abductee. It can have an equally powerful effect on the physiology of the body, as can the idea and process of *belief*, which can be critical to a person's health. The mind can even override our genetic structure - the body responds to what the mind is defining as reality.

### Multiple Personalities as Multiple Image Holograms

Another interesting aspect of the holographic nature of the universe might involve the phenomenon of multiple personalities. There have been many scientific studies that have focussed on the physiological and neurological aspects of individuals with apparent multiple personalities. These studies have yielded some interesting data. In addition to possessing different brain-wave patterns, the sub-personalities of a "multiple" have a strong psychological separation from each other, each with their own name, age, memories and abilities. Mutiples can switch body conditions on and off. The different personalities respond physically to different drugs. In one case, a person with multiple personalities was admitted to a hospital with diabetes and baffled her doctors by showing no symptoms when one of her non-diabetic personalities was in control.

There is evidence to suggest that even when alternate personalities are not in control, they still maintain a sense of awareness. This essentially enables a "multiple" to perform "parallel processing", which may involve thought patterns on "multiple channels" simultaneously or cases where some personalities sleep while other ones perform tasks.

If the "psyche" of a "multiple" is a kind of multiple image holgram, it appears that the body is one as well, and can switch from one biological state to another as rapidly as the flutter of a deck of cards.

### The Concept of "Holographic Inserts"

There could be aspects of technology that are alien-based that involve advanced holographic engineering. According to information put forth by Barbara Marciniak, there exist holographic "streams" called "holographic inserts" which are essentially three-dimensional events that are inserted into

## M A T R I X I I I

the common "reality stream" perceived by human beings. These streams, which are the equivalent (from another perspective) of a "holographic dream" are used to manipulate the human race by induction of fear states which function to maintain the operative human frequency of consciousness at a level of exterior "controllability".

There have, in addition, been numerous references to holographic projections being used as camouflage to screen alien and/or government facilities and operations from view; it would appear that this technology is quite developed; for the "common civilian" intruding where he is not supposed to go it would be perceived as a concrete "reality" and is very effective.

### II. MORPHOLOGICAL FIELDS

At the beginning of the 1920's, at least three biologists independently proposed that the structure, and perhaps additional aspects of living organisms and non-living forms, is organized by exterior fields: Hans Spemann (1921), Alex Gurwitsch (1922) and Paul Weiss (1923). During the 1930's, C.H. Waddington attempted to clarify the field concept with the idea of "individuation fields" associated with the formation of definite organisms with characteristic individual shapes. In the 1950's, he extended the field idea to the concept of developmental pathways. Today, we have compiled an overall body of information what morphic fields are:

A morphic field is a non-material hyperspatial field containing potential patterns of organization that are specific to every kind of living and non-living form. They extend through and interpenetrate the "space-time" continuum and are resonantly interactive on a continuous basis with the forms to which they give rise during the process of morphogenesis. Morphic fields retain and maintain a continuous species/form-specific cumulative memory which contributes to the organization, activities, and characteristics of subsequently generated forms. Each species and form has its own morphic field; fields of related species are similar. Within each overall field there exist subsidiary fields which form a nested hierarchy of fields. Through genetic mutation or through influence of the environment, organisms of one species may "tune in" on another, enabling parallel patterns of development between similar forms. Knowledge acquired through experience by members of a specific species or influences imprinted on non-living forms can resonantly diffuse to others through the field. Because of morphic resonance, successful patterns of activity, through repetition, show a tendency to reappear.



## M A T R I X I I I

There are several examples of events which indicate the existence of morphic fields. The first example is that sometime several years ago, two incidents took place (among many incidents) in England which go a long way to illustrate the existence of these fields:

- (1) Farmers ususally maintain metal gridworks across roadways that prevent the passage of animals, because the animals appear to perceive the six-inch drop under the metal bars as infinite. One day, a specific species of sheep rolled across the grid to get to the other side. Within days, sheep of the same species all over the country began to do the same thing.
- (2) A bird called the Blue Tit was observed in a few isolated but widely separated locations pulling the aluminum caps off milk bottles to get at the milk. A short period of time went by and birds of the same species all over England began using this method.

The second example involves what we commonly consider to be non-living (but probably conscious on some level) matter. A laboratory was engaged in the growing of specific types of crystals. Other labs were also engaged growing the same type of crystals made of the same substance. In this laboratory, a single crystal mutated, producing a hybrid structure never seen before. In the other labs, their crystals also began to mutate to this same structure. The labs were widely separated geographically.

Probably thousands of examples exist which support the morphic field hypothesis. Morphic fields appear to exist for planetary bodies, entire species, racial groups, family groups, and individual entities. Since morphic fields are hyperspatial in nature, higher order fields above the electromagnetic spectrum are able to influence them. It is theoretically possible for the morphic field of an entire race or the entire human species to be affected technologically, producing physical or genetic changes. This principle, also supported by the functional science of radionics and psychotronics, could be used to manipulate and control a species on several levels.

### III. NATURAL ELECTROMAGNETIC FIELDS

#### Ionospheric Cavity Resonance Frequencies

The planet is surrounded by a layer of electrically charged particles, called the ionosphere. The lower layer of the ionosphere starts at about 80km from the surface of the earth. It is a charged layer and is known to reflect radio

### M A T R I X I I I

waves. Since it is a charged layer, it forms a capacitor with the earth, with the earth being negatively charged and the ionosphere positively charged. This potential difference is evenly distributed and comes to about 130 volts per meter. The field is fairly rigid, and when our body moves, these movements are transmitted to the environment, which includes all other bodies on the planet. How? The resonant frequency of the ionospheric cavity around the earth is about 7.5 cps; this is also called the Schumann resonance, which covers the 1Hz - 30Hz range. The human body is vibrating between 6.8 to 7.5 Hz. The skeleton and all the internal organs of the body move coherently at about 7 cps. This suggests a tuned resonant system between the body and the ionospheric cavity around the earth. The Schumann resonance coincides with brain alpha frequencies at 8Hz.

The human being and the planet system can resonate with each other and transfer energy between each other. This occurs at a very long wavelength of 40,000 km, or just about the perimeter of the planet. In other words the signal generated from the movement of our bodies will travel around the planet in about one seventh of a second through the electromagnetic field in which we are embedded. Such a long wavelength does not attenuate much over large distances.

When a human body is standing on the ground under normal conditions, it is electrically grounded and acts like a sink for the electrostatic field and will distort the lines of force to some degree.

#### Overall Geomagnetic Field Characteristics

The naturally existing fields on the Earth appear to be a combination of field interactions, some with origins in space and some having origins within the Earth. The Earth is constantly in the path of high-energy particles which emanate from the Sun, known as the "solar wind". These particles travel through space and impact with the outer layers of the magnetic field of the planet, producing enormous electrical currents with power ranges in the billions of watts. It also results in the production of ionizing radiation (radiation that produces charged particles from the atomic structure of matter) and various electromagnetic waves in the extremely low frequency (ELF) range between 0 and 100 cycles per second (cps) and the very low frequency (VLF) range between 100 and 1,000 cps. The Earth rotates within this complex field.

MATRIX III

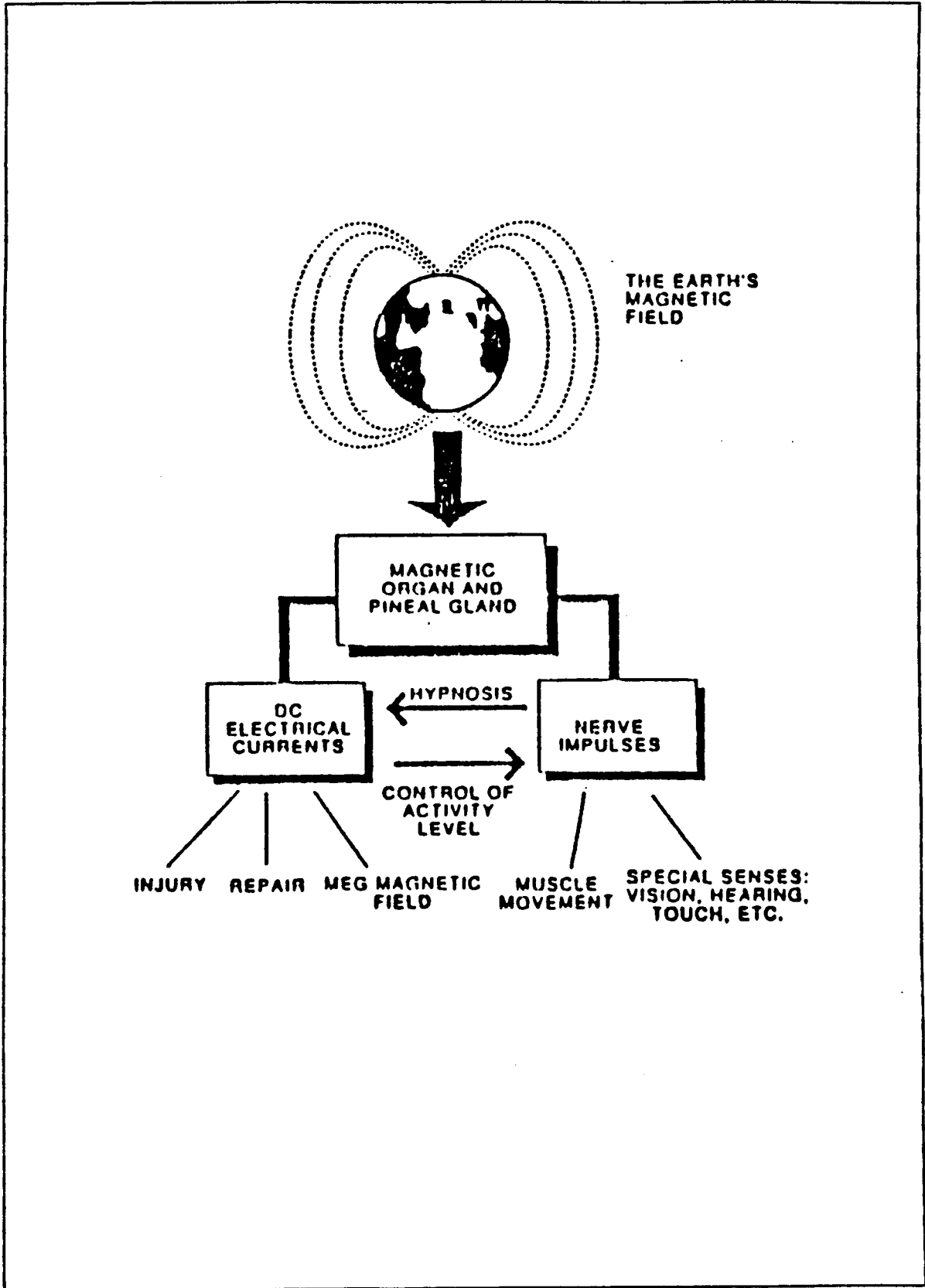



## M A T R I X I I I

### Natural Electric Fields and Micropulsations

Besides those field characteristics discussed in the section on Ionospheric Fields, there are alternating fields that are related to thunderstorm activity and magnetic pulsations that produce telluric currents within the Earth. The strength of Earth's electric field varies in time and over the frequency range of 0.001 to 5 Hz. These are shory duration pulses of magnetohydrodynamic origin, with a field strength of from 0.2 to 1000 V/m. The second electrical micropulsation group consists of two sets, one is in the 7.5 to 8.4 Hz range and the second is in the 26 Hz to 27 Hz range, both pulsing in a group of 3 to 6 sinusoidal pulses with an interval of 0.04 to 1 second. The field strength of this second group os 0.15 to 0.6 V/m. The third electrical micropulsation group is in the frequency of 5 to 1000 Hz, and is related to atmospheric changes that occur continuously. Field strength for the third group ranges between a low of 0.0004 and a high of 0.5 V/m.

### Natural Magnetic Fields and Micropulsations

There are two main groups of natural magnetic pulsations which appear on the surface of the Earth. The first group is at pulsation frequencies ranging from 0.002 to 0.1 Hz, with amplitudes ranging from 0.004 to 0.08 A/m. The second group of magnetic pulsations range from 0 Hz to 5 Hz and have a frequency of several minutes to several hours. The amplitude of the general combined field decreases with increasing frequency from 0.0008 A/m at 5 to 7 Hz to 0.000000001 at 3 kHz.

### The Variant Geomagnetic Field

The particle output of the Sun is not constant, but rises and falls in an 11-year cycle. During periods of high activity, commonly called solar storm periods, the strength of the magnetic field of the Earth fluctuates wildly enough to cause extraneous currents to flow in power and telephone lines and disturb radio and television signals. It wasn't until 1958 during the International Geophysical Year that the magnetic envelope surrounding the planet was really investigated.

Magnetic storms are generally classified according to their magnetic field strength. The average magnetic field strength on Earth tends to about 0.5 Gauss, although the actual value ranges between 0.35 and 0.70 Gauss. 1 Gauss equals 100 nanotesla (nt), which equals 100,000 gammas; all different units measuring the same thing. Strong magnetic storms are classified as those over 200 gammas; weak storms approximate 50 gammas.

## M A T R I X I I I

There are relationships between some of the surges in magnetic intensity from the sun and changes that have been observed in human behavior. It was found in 1963 that the admissions to mental hospitals increased significantly during any week in which a major magnetic storm occurred. Even the day-to-day behavior of psychiatric patients was correlated to small variations in the geomagnetic field.

### Periodic Geomagnetic Polarity Reversals

The concept of reversals in polarity of the Earth's magnetic field has been researched adequately over the last 20 years, and geological analysis has shown that magnetic reversals also parallel extinction of various species on the Earth. Each reversal is a slow process that may take more than 10,000 years and often as long as 100,000 years. Smaller variations exist over a period of 100 to 1,000 years. The extinction of various species occurred right after the magnetic-field reversal. If the reversal occurs following an exceptionally long period of a stable field, the species extinction is much more extensive.

Research indicates that during a field reversal, the field strength does not drop to zero, but merely declines to about 50% before building back up again. In 1971, a conference was held on this subject at Columbia University, under the direction of Dr. James Hays. Hays found that six out of eight extinctions of radiolaria, a primitive organism, had occurred concurrently with magnetic field reversals. Additional work linked other extinctions to the reversals.

Theories about the cause for the field reversals take into account that reversals could have been accompanied by major changes in the 1-10cps micropulsations that normally exist within the field - micropulsations that have the ability to radically affect biological organisms - changes in these could reduce the biological efficiency of organisms. Other theories propose that the frequency changes could influence cellular reproduction and produce defective offspring. There is some evidence, according to work done at Oakland University by Abraham Liboff, that both of these theories may be valid, since present evidence from studies on the bioeffects of abnormal electromagnetic fields indicates that such long-term alterations in the frequency spectrum of the micropulsations could have major deleterious effects. It appears that biological evolution is not a random event but is in part driven by changes in the Earth's natural magnetic field.

## M A T R I X I I I

### IV. BIO-ELECTRICAL SYSTEM CHARACTERISTICS

#### Magnetically Driven Symmetry of Organic Lifeforms

Work at the University of Bremen in Germany on magnetic fields indicated that the form of organic molecules could be generated in right-hand or left-handed modes simply by changing the characteristics of the ambient magnetic field, which is interesting because all organic chemicals only exist in these two mirror-image structural forms. When living organisms create amino acids and other substances, they made only one kind, either right or left-handed, but not both. The effects of each of these mirror-image forms on living systems are quite different. In Matrix II we discussed the alledged sensitivity of some alien species to left-handed molecular structures - this has not been verified, nor has anyone come forth to challenge this allegation. We have theorized that some of the biological reactions that humans experience when encountering some alien lifeforms results from the variance at the boundary interface between two radically different biological fields - fields which may incorporate a different spin-vector. No doubt magnetic field alterations a play an important part in the construction of synthetic lifeforms and clones. It has been stated in some literature that the sites for these cloning laboratories are chosen very carefully, based on the characteristics of the local geomagnetic field.

Living systems appear to have a general facility for being able to sense small changes in their electromagnetic environment without being overwhelmed by the large change. Honeybees and birds are reported to be sensitive to magnetic changes less than 1nT (10uG). In pigeons the pineal gland weighs about 1.5 grams - in humans about 2-grams. According to the research done by M.L.Barr in 1979 (*The Human Nervous System*), for an organ the size of a human pineal gland to be able to respond co-operatively to changes in magnetic field, the coherent energy of the magnetic field within the volume of the pineal gland must not be less than the random thermal energy, which means that the minimum detectable magnetic field for the pineal gland is 0.24nT (2.4uG). The human head appears to be the part of the anatomy that is most sensitive to changes in the surrounding field characteristics. This is very important when it comes to mind control applications, especially the ones that are currently being conducted - we'll review those in a later chapter.

The fundamental nature of a magnetic field is that it can affect living systems on quantum levels. The Russian scientist Trinchler discovered that water inside the living cell is in a state of maximum order, which is a state attainable in non-living systems only at absolute zero. Thus, biological superconductivity and quantum-level responses to variations in field characteristics are typical of living

## M A T R I X I I I

systems. The Josephson Effect, which can occur in superconducting systems, but which does not depend on the presence of superconductivity (only the ability of the system to respond to the quantum of magnetic flux) does offer a possible physical connection between living systems and the weak electromagnetic fields which surround them.

### Circadian Rhythms

Human circadian rhythms have been found to be extremely sensitive to weak ELF fields. Animals are also very sensitive in the same way. Specially trained birds in experiments done by Wever were able to tell the difference between a 10Hz field and a 9Hz field. The key to biological changes using magnetic fields is that they must be pulsed, or modulated. However, living systems appear to be non-linear in their responses to electromagnetic fields - great changes in the field do not always produce great changes in the organism. Changes appear to occur relative to specific frequencies and modulations that exceed a particular threshold specific to the effect.

### Biological Enzymes and Magnetic Fields

The substance melatonin is linked with the generation of circadian rhythms. It also regulates the level of activity in the brain, as a whole, and is produced by the action of pineal enzymes on serotonin, one of the vital neuro-chemicals. One of the enzymes (biological catalysts) responsible for the synthesis of melatonin was shown in experiments in 1983 to be sensitive to changes in weak magnetic fields.

The rate at which biological reactions proceed depends on concentrations of the various enzyme and the molecule whose chemical reactions the enzyme very specifically controls, known as the "substrate". There are typically 3,000 enzyme systems in a living cell. The human body has more than  $10^{13}$  cells; the number of enzymes in the body is of the order of  $3 \times 10^{16}$ ; if their detailed reactions were simulated on a computer at the rate of one every three seconds, this would need computer time equal to the number of seconds that have elapsed since the beginning of the Universe,  $10^{17}$ .

Detailed analysis of the chemical structure of enzymes reveals that all enzymes are proteins. Proteins are made up from strings of amino acids, short chains of which are referred to as polypeptides; when the chains have a length exceeding 50 to 100 amino acids, giving them molecular weights greater than 500 to 10,000, they are called proteins. The chains take on a three-dimensional arrangement. Oddly, there is nothing in the chemical structure of enzymes to explain

## M A T R I X I I I

their enormous catalytic power, and there is no simple connection between molecular structure and enzyme activity. The specificity of enzyme action is also not confined to living systems.

In electronic terms, an enzyme-substrate system could be considered an "amplifier", if one regards the signal input as the amount of enzyme present and the output as the amount of reaction product formed per minute. Such an amplifying system might have a gain of  $10^{10}$ . It was the search for a physical characteristic common to most biological materials that led Frohlich in 1975 to examine their dielectric properties. A simple definition of a dielectric would be to say that it is anything that is not a metal.

The relevance of dielectrics to biological cells and tissues will be clear as soon as it is realized that there is a very high electric field across live biological membranes. This field is of the order of  $10^7$  volts/meter, far greater than anything likely to be experienced holistically by a human being. This field is strong enough to align all the macromolecules within a biological membrane, which increases their non-linear responses to external electromagnetic fields. A better model for the situation might be in terms of oscillating dielectric dipoles. A dipole is the combination of a positive charge and a negative charge separated spatially, such as might occur on the surface of a macromolecule.

Research indicates that non-linear, coherent excitations of these dielectric dipoles is possible and that this could lead to long-range interactions on a very frequency-selective basis, essential if one is to have a mechanism for the selective remote control of the chemistry going on in a particular cell of the body by a distant organ which has an overseeing function for the activities, or provides the organism with sensors for external electromagnetic fields.

We can see by now that electromagnetic phenomena are important for regulation at the basic level of cell biochemistry. It is likely that all the electromagnetic frequencies from the ultra-violet to that which characterizes the lifetime of the cell are involved in a very coherent manner. Because many of the biomolecules are themselves electrically charged, acoustic vibrations and electrical vibrations are equivalent and interchangeable, the only difference being in their velocity of propagation. It seems that just as living systems are able to make use of single photons, they are able to make use of single quanta of a magnetic field. If this applies, then they also have the ability to interconvert between frequency and voltage at the rate of 500MHz per microvolt; they are able to make use of the Josephson Effect. Any cell will behave like a dielectric resonator and will have an electromagnetic field in the space around it. This field is capable of interacting with and being

## M A T R I X I I I

influenced by fields external to it.

### Magnetic Field Shielding

Experiments involving the shielding of living systems from the geomagnetic field (GMF) were carried out by Dubrov in 1978, but they are difficult and involve expensive shielding materials and techniques. Magnetic fields are very difficult to screen. A 1mm piece of high-permeability magnetic alloy will only reduce the steady field within the enclosure to about 50nT, which is the average strength for the GMF. The shielding of ELF magnetic fields presents an even greater problem; a 150mm piece of aluminum provides some minimal degree of shielding.

### Human Brain EEG Signals

The EEG signals which are recorded in the human brain are thought to be due to current flow in the cortex where synchronous interactions yield oscillations in the frequency band from 0.5 Hz to 30 Hz. These frequency oscillations are similar to the geo-electrical Schumann Waves generated in the ionosphere, to which all organisms have been exposed throughout their period of evolution. For the purpose of EEG analysis and clinical description, the frequency band has been divided into a number of so-called rhythms. The majority of normal adults can produce the Alpha rhythm, which was first described by Berger in 1929. This is within the range of 8 Hz to 13 Hz and is the normal basic rhythm for a relaxed person with the eyes closed. The Beta frequencies are considered to be those from 14 Hz to 22 Hz. The amplitude of the beta waves is generally less than 20uV. Delta waves range from 0.5 Hz to 4 Hz and replace Alpha waves during deep sleep, anesthesia, and are also present during various meditative states involving willful conscious focus of attention in the absence of other sensory stimuli. Theta waves range from 4 Hz to 8Hz. They appear to be prominent in the EEGs of normal children.

### The Unusual Characteristics of Water as a Cellular Component

One of the most interesting discoveries in the last ten years that has profound implications of a biological nature is that water appears to have a memory for past exposures to highly coherent frequencies. Dr. Cyril Smith in 1985 proposed that water might have a helical structure that enables it to "remember" frequencies. This capacity of water would explain how clinical responses in homeopathy can occur within seconds. Watterson in 1982 considered the effects of structure waves in water. In order to account for magnetic field effects and a

memory for frequency, Smith proposed that such structure waves would occupy electromagnetic and acoustical modes of propagation appropriate to a helix. These must be capable of being set up in water by the spectrum of coherent oscillations either by electromagnetic components or tincture molecules in the case of homeopathic preparations. There have been frequency associations with homeopathic preparations. For example, Dr. Wolfgang Ludwig in 1986 found that the frequency of Arnica 1000x was 9.725 kHz. All this also might explain why people that are sensitive to certain electromagnetic frequencies respond when in the presence of water that has been exposed to that same frequency.

**Brain waves**

As millions of brain cells fire repeatedly many of them are combined in one EEG wave trace. There are four types of brain wave classified according to frequency and given the names of Greek letters.  
 δ delta waves (1-3 cycles per second)  
 θ theta waves (4-7 cycles per second)  
 α alpha waves (8-13 cycles per second)  
 β beta waves (13+ cycles per second)

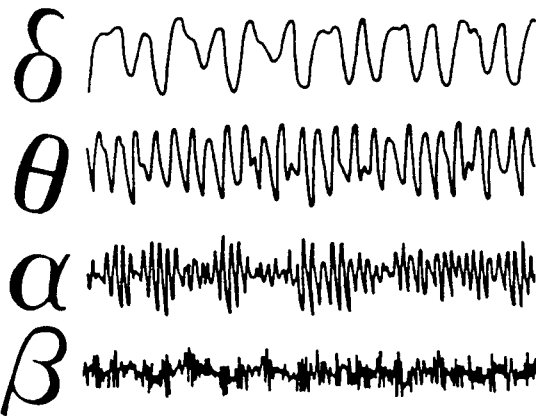

Since the brain and its extension into the spinal cord are connected directly to all parts of the body by the nerves, are the nerve impulses also part of this etheric life force, and is it the electrical charge from all parts of the body that produces the body aura? (Refer to: *How far outside our skins* (pp. 104-105) for details about the body aura.) To explore these questions, some information about the nervous system is necessary.

**THE NERVOUS SYSTEM**

There are two parts to the human nervous system, the central and the peripheral as shown in the diagram (below).

**THE NERVOUS SYSTEM OF THE PHYSICAL BODY**

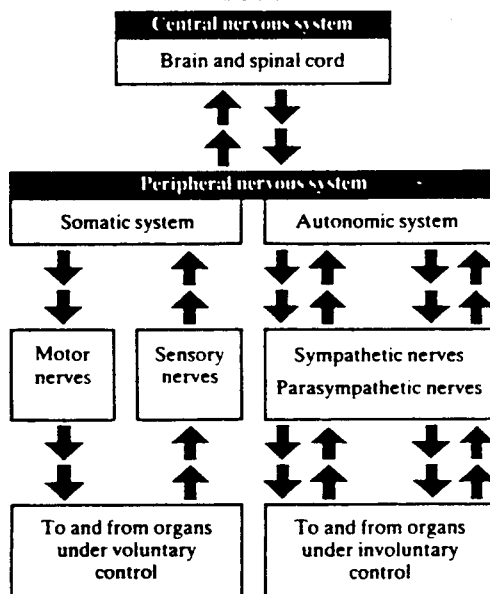

The central system consists of the brain, together with its extension the spinal cord, which receives and sends messages, interprets, stores and coordinates those messages and makes decisions.

Communication between the central nervous system and all organs of the body is via the peripheral nervous system, which consists of nerve pathways specialized for different purposes.

The somatic peripheral (body) system sends and receives messages of which we are conscious. For example, we can notice the position of the players and of ourselves in relation to the ball in a game. Sensory nerves in the somatic system connected with our eyes, ears and muscles send this information through to the brain in the central nervous system and motor nerves carry instant decisions back to our eyes, ears and muscles enabling us to kick the ball in the chosen direction. Reflexes are messages that pass directly through the spinal cord without need for a decision from the brain.

The autonomic peripheral (self-regulating) system sends and receives messages of which we are not aware, for example the regulation of heartbeat, emotions, digestion etc. The autonomic system contains two nerve systems which balance each other: the sympathetic system is concerned with readiness for action, and the parasympathetic is concerned with readiness for relaxation. Too many messages passing to and fro along sympathetic nerves will automatically alert the parasympathetic system and vice versa.

- 1 The central nervous system
- 2A The somatic peripheral system
- 2B The autonomic peripheral system

# M A T R I X I I I

## DATABASE: FREQUENCIES

Atmospheric EM Pulses	Also called Spherics. Have a determining effect on the weather. Spectral maxima were found in narrow bands(HZ): 4150.84, 6226.26, 8301.26, 10377.10, 12452.52, 28018.17, 49810.08
Bio-electrical Coherence	Nature uses highly coherent electromagnetic signals between living systems. The range of freq extends down from the UV, where radiation becomes 'ionizing', through to the sub-Hz, (sec per cycle)
Bio-electrical Coherence	Most electromagnetic frequencies in the nature are coherent only over time intervals of less than about $10^{-8}$ s (spectral bandwidths of 100MHz) due to the physical properties of emitting atoms
Bio-sensitivity to ELF Fields	According to studies done by Jacobi in 1979, it was found that 10kHz modulated with ELF of 10Hz effected thrombocytes in the blood; a cover of copper gauze over the head stopped the effect.
Bioeffects of Microwaves	Microwaves can act as a carrier able to deposit the nuclear magnetic resonance (NMR) frequency as the microwave modulation signal within the tissue, where non-linearities demodulate it.
Biosensitivity to ELF Fields	The Schumann resonance covers the 1Hz to 30Hz region (Konig, 1979). The 8Hz region is important and generally beneficial
Brain Activity	to living systems, and coincides with the brains alpha (8-12Hz) The brain "talks" to itself constantly, with various oscillating domains inducing vibrations in one another (entraining)
Brain Entrainment	or remaining isolated in complex fluctuating patterns of activity Externally Oscillating fields can resonantly entrain oscillating living tissue.
Brain Entrainment	External wave systems can "talk" to internal ones.
Brain Frequencies	ELF fields can induce in the brain patterns of vibration similar to their own
Brain Frequencies	If you go below 1cps in brain activity, you go into the infinite, above the speed of light, into higher dimensionality
Brain Frequencies	In the near 0 cps frequency, spontaneous expression can take place involving the "paraconscious" of transpersonal activity in interaction with unknown energy fields
Brain Frequencies	Delta wave frequency 0-4 cps may involve interaction with high frequency domains at high amplitude, measured in millivolts
Brain Frequency	Brainwave synchrony between people correlates with intense, non-verbal feeling states.
Brain Frequency	The average frequency of brain waves during channeling type activity was found by Dr James Brown, a Fairfax California research
Brain Frequency	psychologist, to be around 10Hz
Brain Frequency	Elizabeth Rauscher, a Berkeley California research physicist, speculates that currently unmeasureable EEG frequencies may exceed 1000Hz
Brain Frequency	Increasing the energy while lengthening the wavelength of the brain waves can act as both a magnifying lens and an amplifier, which
Brain Frequency	causes a narrowing of focus on high frequency info.
Brain Frequency	A shift in brain frequency involving the presence of EEG synchrony
Brain Frequency	between hemispheres precedes or accompanies non-ordinary states of consciousness associated with meditation or trance channeling experience.
Brain Frequency	When an individual shifts focus of attention, the entire frequency pattern of the brain shifts to different frequencies. This
Brain Frequency	shift is of interest when it involves synchrony between hemispheres
Brain Frequency	The abilities to focus attention and to achieve flashes of insight have been correlated with increased phase synchrony between
Brain Frequency	hemispheres



# M A T R I X I I I

## DATABASE: FREQUENCIES

Carbon Dioxide, Neural Effects	Co2 increases the frequency and decreases the amplitude of cortical potentials as noted in the human EEG and direct recordings from the cortex of animals. There is an increase in cortical strychnine spikes and subcortical discharge in the posterior hypothalamus.
Electromagnetic Coherence	Coherence: the existence of definite fixed relationships between the phases of otherwise separate waves. Coherence makes interference effects between waves possible
Human Body Internal Coherence	The skeleton and all the inner organs move coherently at about 7 cps. The natural frequency of the normal body seems to lie in this range.
Immune system and Brain Struct	French investigators have been able to demonstrate an involvement of the left cortical hemisphere of the brain in immune function.
Immune system and Brain Struct.	The structure and organization of the brain itself may influence immunity. Clinicians have made the observation that left-handed people appear to have more developmental difficulties. Left handed people have higher rates of immune disorders and migraine headaches. In one London study of 253 lefties, the frequency of immune disorders was found to be 2.7 times higher, especially thyroid and bowel disorders.
Nuclear Vibratory Rate	The nucleus of an atom will vibrate at 10(22) HZ
Ocular Registration Frequency	The lowest frequencies that the eye will react to lie in the region of 375 trillion Hz (red) and highest at 750 trillion Hz (blue)
Physio-Kundalini Sequence	stimulus loop. The pleasure centers of the brain are stimulated. When people are exposed to frequencies of about 4 or 7Hz for prolonged periods of time, the cumulative effect may be able to trigger a spontaneoud physio-kundalini sequence in susceptible people who have a particularly sensitive nervous system. Pg 179 Diagram
Protein reaction to frequency	Research work carried out by Fritz Popp in West Germany and by Wilfried Kruger confirmed the observations of Hans Baumer that protein compounds react to certain frequencies
Pulse Manifestation	We have a twin stream of consciousness on the anti-matter side of the cycle. The frequency of manifestation of both streams of consciousness would position our awareness of the illusion of reality at a particular point in space-time.
REM Sleep, Dreams and Brain Function	REM sleep occurs for about 1 to 1.5 hours of the sleep cycle, alternating with non-REM sleep, which takes place in four stages of increasing depth. Almost all dreaming is done during REM sleep. During REM sleep, outside sensory input is largely excluded and the cortex and other forebrain areas are periodically and widely stimulated by brain stem impulses that work as what has been called a "Dream state generator".
REM Sleep, Dreams and Brain Function	Crick and his associate Mitchison, of Cambridge, England, postulate that if it were not for the clearing function of REM sleep, the cortex would have to be tremendously larger, or would become inoperative with clutter and unwanted connections. Most mammals, including man, demonstrate REM sleep. The curious exception is the spiny anteater found in Australia which has a disproportionately huge, almost unwieldy, cortex.

# M A T R I X I I I

## DATABASE: FREQUENCIES

REM Sleep, Dreams and Brain Function At the onset of REM sleep, cells in the lower brain stem, specifically the Pons, begin sending signals to the higher brain centers which are ultimately widely distributed over the cortex. According to Crick, these brain stem impulses are random, unconscious, and non-specific networks. In some unknown manner there is a clearing -reverse learning- and weakening of these more random, "noisy" or static cell connections, strengthening more used assemblies.

REM Sleep, Dreams and Brain Function REM activity is more frequent in the fetus and the newborn than in the older child and the adult. In calculating Savants, REM sleep is at levels above normal. REM activity is generally lower in mentally defective persons. Savant memory may be due to a failure to forget, rather than a unique ability to store and retrieve.

REM Sleep, Dreams and Brain Function Francis Crick, Nobel laureate for his work on DNA, now with the Salk Institute, propose that the function of REM/Dream sleep is "reverse learning" in which some cell assemblies, the networks of memory, are strengthened (and thus saved) and some are weakened (and thus erased). They propose that this is the brains method of consolidating some daytime impressions for retention, and fragmenting others so they can be discarded.

Rhythm Entrainment The resonant frequency of the earth- ionosphere cavity- is about 7.5 cps and the micro-motion of the body is from 6.8 to 7.5Hz  
This suggests a tuned resonant system. In deep meditation, a human being and the planet start resonating and transferring energy at the very long wavelength of 40,000 km, the perimeter of the planet

Rhythm entrainment Nature finds it more economical in terms of energy to have periodic events that are close enough in frequency to occur in phase or in step with each other. Vibratory events that are close in freq will entrain themselves to each other when in proximity.

Sound Interference Properties (1) Constructive and Destructive Intereference  
Builds up the Amplitude and Cancels Amplitude  
(2) Beat Frequencies-convert high frequencies to low frequency  
If F1=10HZ and F2=12HZ, then Beat Freq= 2HZ superimposed on the other mixed frequencies.

# M A T R I X I I I

## Chapter 3

### Neurological Brain Circuitry, Evolution, and States of Consciousness

If every person were looked at as a single cell in a worldwide brain in which the whole of life were reflected as a hologram, then the brain itself could be seen as a pattern of crystallized evolutionary intelligence which is gradually building social systems over vast periods of time. The human brain has taken about 5 billion years to develop on this 10 billion year old planet. Besides natural evolution, the human brain and physiological structure might have been affected by as many as 64 separate genetic modifications imposed on the developing human neurological structure. Some of these modifications might have been performed to deliberately limit the functional ability of the human being.

The behavior of all organisms and especially the social organization of the different species of vertebrates corresponds to a progressive increase in the development of the cerebral hemispheres and cerebellum. Consciousness has developed, by virtue of different areas in the structure of the brain, into seven distinct areas; each area is said to resonate with a particular vibrational frequency of the color spectrum - red, orange, yellow, green, blue, indigo and violet. Our own consciousness itself could be composed of the same light having the same seven colors within it and seven different vibrational frequencies which shape the quality of our awareness.

The human brain is also a prism and a receiver, filtering cosmic light into an octave through its vehicle of expression, the human body, and resonating with the seven basic colors, while the 8th level resonates with pure consciousness itself. The brain can be likened to a seed which unfolds on seven different vibratory levels. Our direct knowledge of our own brain consciousness determines our own level of evolution. The brain as a physical manifestation of these stages of development is an effect, not a cause, of the evolving levels of consciousness. These levels pre-exist within the brain. Every person's levels of consciousness are mixed, yet they separate when passing through different densities and intensities to produce the thresholds within the total experience of what our brain normally experiences as consciousness.

At each stage of evolution the growth of organisms has not come from the differences in gene products but from the complex regulatory circuits which have unleashed or restrained certain activities of the organism, thus leading to the specific genetic program which selects the quantities of bio-chemical products from its immediate environment. This means if you discipline yourself, you regulate the secretion of brain hormones which create the chemical changes which

# BRAIN AND SPINAL NERVES

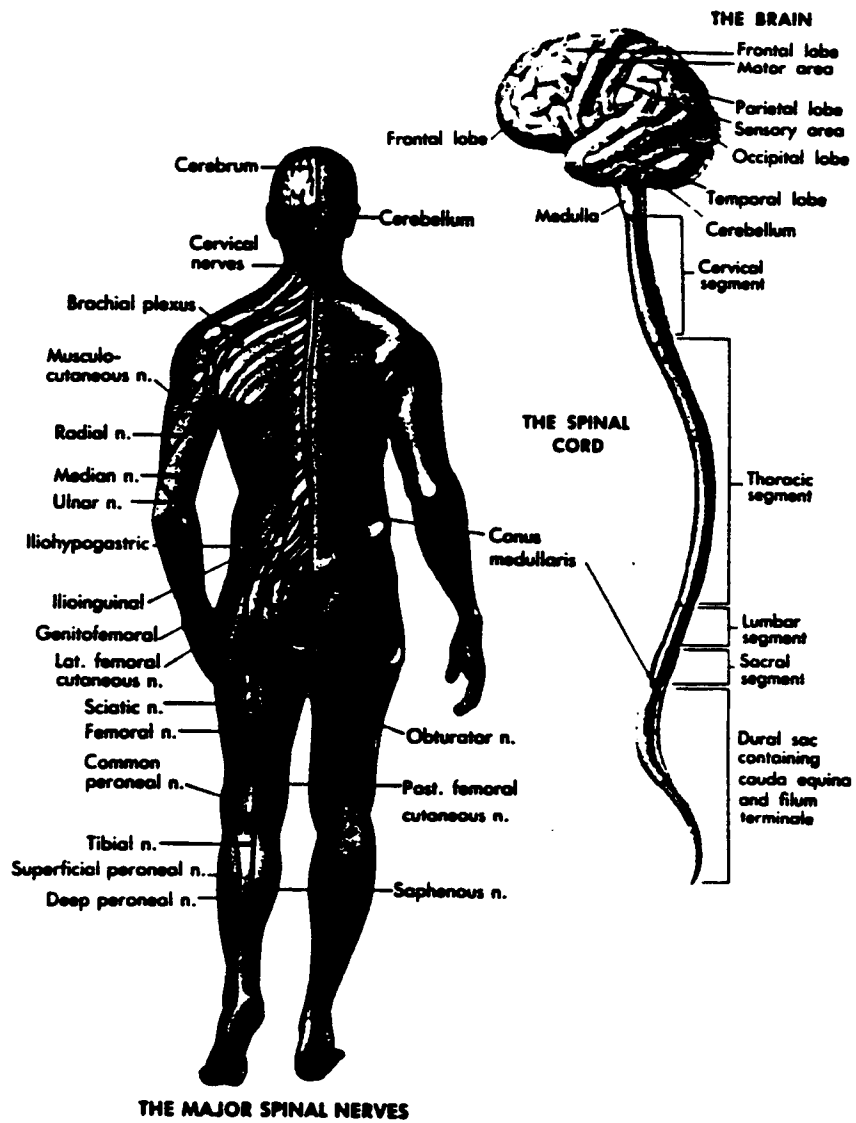

## M A T R I X I I I

allow certain aspects of consciousness.

### White and Grey Neural Matter

The alteration of white and grey matter in the brain and the spinal cord create an alteration of positive and negative electricity. The two kinds of matter appear in layers, and the layers work much like a capacitor in electronics. Brain signals are emitted along certain paths which extend out from the central mid-brain area through a large nucleus of fibers. The signals are modulated and tuned, not to individual cells but to the whole brain's activity, which results in a selection among hundreds of thousands of paths, so that the signals will travel along specifically chosen pathways to certain areas. The preferred circuits are often habitual and are formed through the embryonic development of the nervous system and the subsequent conscious discipline of the channels. It is possible to shut off parts of the brain or to amplify other parts and create large charges. The electrical potentials can be consciously changed in the brain pathways. There is no habitual thought pattern or emotional response or typical action which we cannot change.

The tuning of the brain circuits is converted into learning and memory by setting up stored patterns of potential energy in the cells of the brain through choosing specific circuits. We often function by habitual responses which are stored as an energy in the brain, and we call this a type of memory. This kind of memory is like an unconscious choosing process that is happening automatically. The higher conscious selection is made through the use of conscious will. Any unconscious choosing can become conscious choosing once we are aware that choices are happening and we begin to deliberately interfere with them.

People who can store large amounts of electricity by raising their vital forces to higher layers also increase their thinking capacity, since the electrical charge in the brain ionizes more brain fluids. The ionization of membranes and fluids in the brain is equivalent to exciting the atoms of our brain cells to a higher threshold.

The body can be changed by an act of consciousness. The secretion of brain chemicals can be controlled at will to affect our emotions and levels of consciousness simply by raising these electrical potentials and awakening millions more cells than is normally possible and getting them to switch on. In most people they are switched off and lie unused throughout an entire lifetime.

# STRUCTURAL HIGHLIGHTS OF THE NERVOUS SYSTEM

## GENERAL ARCHITECTURE AND PHYSIOLOGY

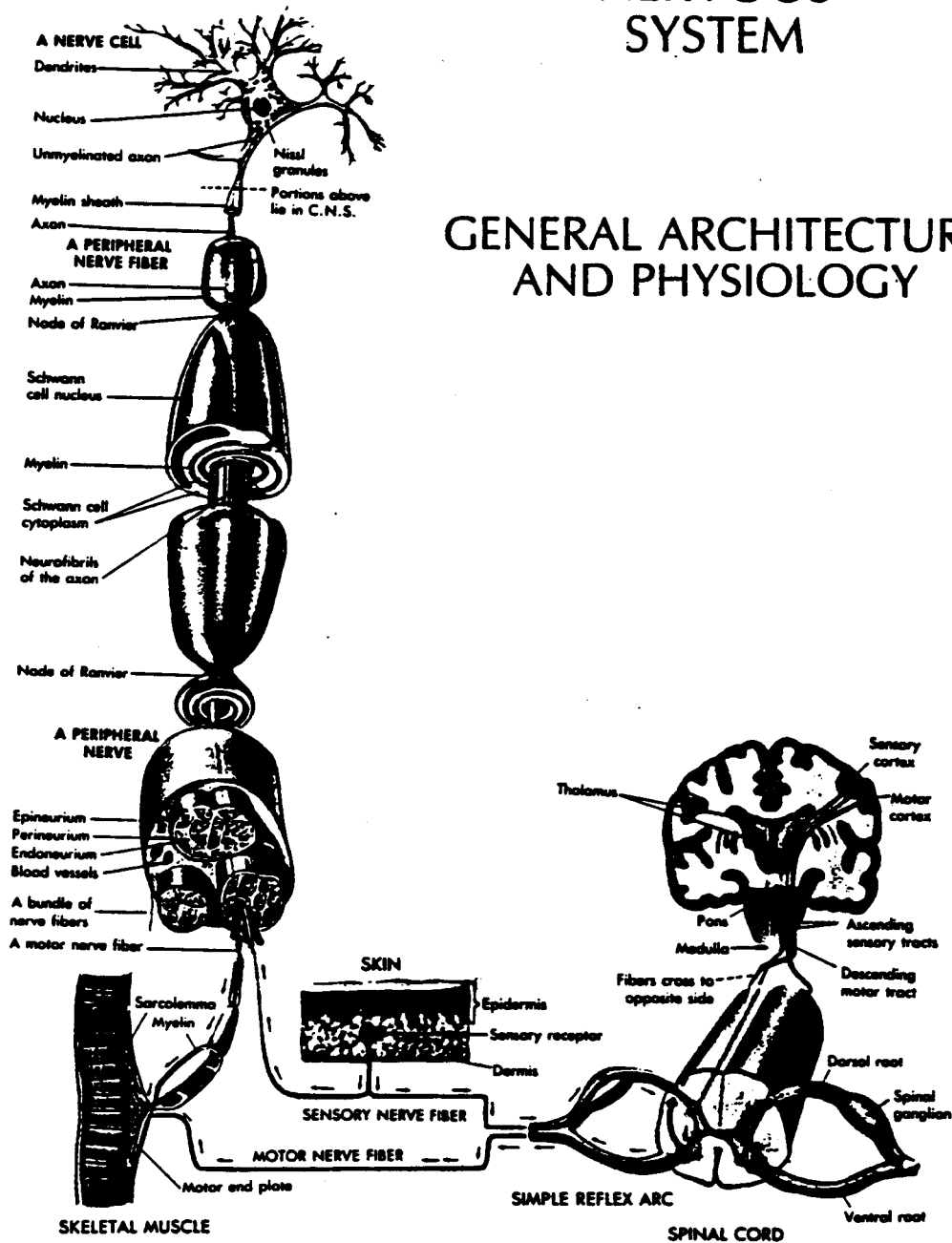

## M A T R I X I I I

Each of the seven brain areas act like a ladder; each brain area has its own method of jacking up the brain electricity between the alternating layers of grey and white matter. The body of a human being has one main function: to hold an electrical ionizing charge so that consciousness can express through it. The capacitance effect of the neurological structures not only accumulate electrical potential but also function in an aspect that features tuning. The frequency of the whole brain rhythm depends on the tuning of the neural circuits as a whole. Meditation and other exercises open channels for more energy from higher levels of consciousness; it fine-tunes the brain cells to higher frequencies so that they become more able to receive and store subtle energies. The capacitance effect is increased and the brain cells hold a higher level of awareness. In this way, we enlarge our capacity, and then it is there for us to use and draw upon.

The nervous system is an extended part of the amplifying circuitry of the brain. Though the nerve trunks are interpenetrating the whole body, there is no contact made between the nerves and the body, because the nervous system is completely contained within its own "body". In effect, we have a body within a body. Why is it important that there are two separate body systems: one body sensing the universe directly and communicating that sensation to the rest of the body which is quite separate from it and only connected by chemical reactions? The outer body acts as a huge sensitive skin, communicating with the inner body consisting of the nerves floating within it, and the nerves then communicate with the physical level of consciousness by chemical hormone transmitters. Humans take feelings produced by these chemicals as reality, without understanding that it is only one level of consciousness communicating with another.

Darwin only tuned into the 1st brain in his theory of the survival of the fittest. The behavioral psychologists have tuned into the 2nd brain in the study of learned social behavior. Medical science has divided the brain strictly by lobes, rather than by function, and their pictures reflect this physiological orientation, which does not acknowledge seven brain functions not raise the question of what kind of consciousness has shaped the brain in seven parts.

Timothy Leary and others have researched circuits in the brain and have arrived at conclusions which indicate seven circuits that parallel the seven brain areas; these circuits are influenced by imprinting. There are indications that this knowledge is one of the reasons why Leary was imprisoned, as intimate knowledge of the imprinting process, how to change the imprints, and knowledge of brain circuitry itself could interfere with the effort to subjugate the mass of humanity under a domination-control based system. This knowledge is considered to be "dangerous" by those who structure the

## M A T R I X I I I

society we live in. The benefits of the knowledge, however, contribute to the overall evolution of the society when viewed from a higher state of consciousness - that is precisely why this material is being presented to you now.

### The First Brain Area and Its Functioning

The reptilian brain was first a sensitive piece of skin, a primitive kind of eye not sensitive to light alone but to all vibrations in nature, across all octaves, and this sensitivity can be traced in some lizards as a rudimentary pineal gland which reaches through the brain like a bulb on a stalk just under the skin. The human pineal gland also acts like an antenna, though it is buried inside the skull. The lizard experiences a pineal effect of 360 degree physical sensation which human beings have lost, although we can feel that link through our consciousness provided we have awakened and activated it at the higher levels of brain activity. In the reptile, the pineal gland is a PHYSICAL sensor, whereas in man it has become a faculty of EXTRA-SENSORY perception and has gone deep inside the skull and taken on an entirely new role.

We have also inherited from this most primitive area in our brain development, the automatic reflex of stimulus-response reactions. This area of the brain represents only 6% of our brain intelligence. The reptilian brain has gradually reseeded into the protection of the skull and became differentiated into the innate human responses common to the reptilian living habits, that is, walking, swimming, crawling, swallowing, vomiting,, breathing, speech or tongue control and basic voice box (croaking), digestion, metabolism and beating of the heart, all of which are controlled by the MEDULLA and its associated cranial nerves and the total nervous system.

All higher animals have emotions which they store in the 2nd level of the brain, but the reptilian brain is that part which determines what part of our body will respond to direct sensory stimuli. In other words, we have to get hit before we feel it. The memory latent in the nerve cell in this part of our cerebrospinal system of sensations is fully automatic, with its own built-in primitive intelligence which is highly reactive to sensory inputs.

Cells, nerves leading through the MEDULLA into the brain, and the brain dendrites generally, are all part of this system and are all sensitive to this primordial reptilian level of consciousness.

Most people are more developed in this part of their brain than in any other part. They respond to life as reptiles. They are at the mercy of each new stimulus so that soon the day is shattered into a thousand fragments and they don't know where the time has gone. Any long-term project, requiring commitment



M A T R I X I I I

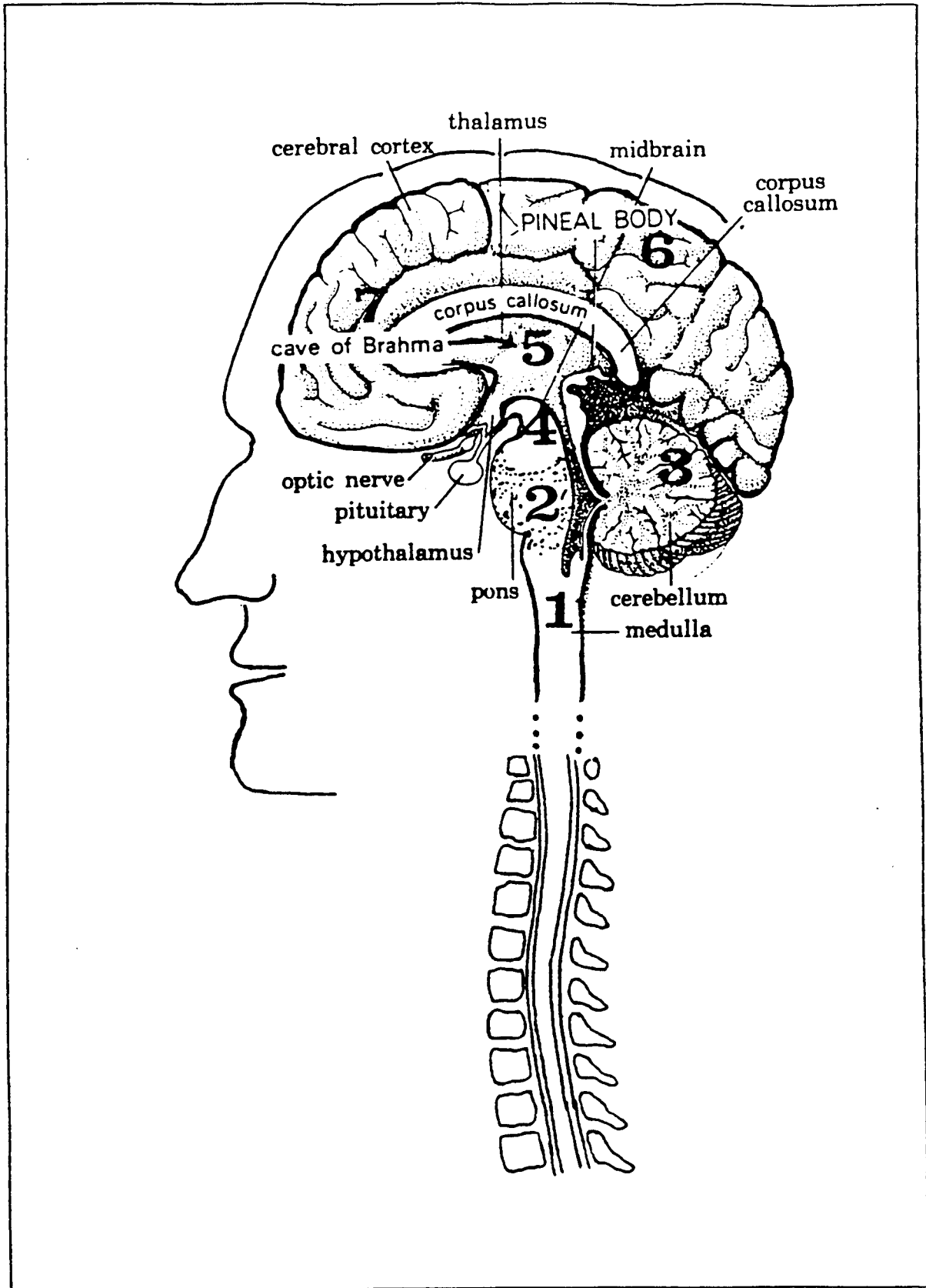

## M A T R I X I I I

to slow steady work, is difficult for them. Like the powerful response to sound, which is preserved in the primitive functioning of the brain, so too our emotional response to any stimulus that comes through our senses has a power that completely swamps the clarity and logic of the head. The 1st brain is the source of our most powerful negative destructive energy, but it is also the positive source of our vitality.

### IMPRINTS

Let's talk about brain programming. One main aspects of brain programming, as we mentioned earlier, is the idea of the IMPRINT. Lack of understanding of the changes these circuit imprints can induce and the knowledge about their persistence is responsible for most failures in communication. That is precisely why this information is suppressed, because knowledge of it represents a potential evolution in society - an evolution that is not desired by many who control our society. IMPRINTS can be looked at as "software frozen on hardware" in terms of the brain, which is genetically designed to accept imprint conditioning on its circuits at certain points in neurological development. These critical periods are sometimes referred to as times of IMPRINT VULNERABILITY. The IMPRINT establishes the limits or perimeter within which all subsequent conditioning and learning will occur. Imprinting creates the structure which emerges out of the Void.

Each successive IMPRINT complicates the software which programs our experience and what we tend to experience as reality.

The structures of the brain which are reptilian in nature also represent the 1st circuit, which has been referred to as the Oral Bio-Survival Circuit. It is imprinted by what is perceived to be the mother or first mothering object. It is conditioned by subsequent nourishment or threat, and is concerned with sucking, feeding, cuddling, and body security. It causes an unconsciously motivated mechanical retreat from anything noxious or predatory, or from any associated by imprinting or by conditioning with anything noxious or predatory. The circuit is estimated to be 3 to 4 million years old.

The structure of the 1st circuit remains in the Brain Stem and the autonomic nervous system, although it is connected with the endocrine and other life-support systems of the body. Interestingly, 85% of the population have symptoms of a bad 1st circuit imprint.

The basic consciousness of the 1st circuit is one-dimensional, and is concerned with "what is safe" and "what is not safe". In human society, MONEY is tied purposely to survival and bio-security. Welfare systems, socialism, and

## M A T R I X I I I

totalitarianism represent attempts to re-create the tribal bond by attempting to make the concept of the "state" stand in for the gene pool. Money represents a bio-survival bind for most people.

People whose reality-tunnel is governed by this circuit seem to be "action-oriented" people who view other people out there as numbers in an abstract thing called "society". They react to the pressures of the moment.

People who take their heaviest imprint on the 1st circuit tend to be overweight, because this imprint determines lifelong endocrine and glandular processes. They tend to be easily threatened by disapproval of any sort, because in the "baby-circuit" of the brain, disapproval suggests the idea of extinction by loss of the food supply.

Initial negative imprint on this area is characterized by the "respiratory block" noted by Wilhelm Reich. It is a chronic muscular armoring that prevents proper, relaxed breathing. Popular speech recognizes this state as "being up tight".

### Introduction of Opiate Drugs as a Forced First-Circuit Reality-Tunnel for Population Management

In current society, especially in the United States, different elements within the shadow government, together with the CIA, NSA, US Army Delta Forces, and other agencies, have seen fit to keep pumping heroin and opiates into the society. The rationale for this is to eliminate weaker elements of society, acquire additional funds to support covert operations, and to induce a tunnel-reality adherence to the 1st circuit level of consciousness - essentially to keep the people in a fear-based survival mode. These chemicals trigger the production of neurochemical hormones characteristic of the 1st circuit.

### Re-imprinting the First Neurological Circuit

One characteristic of the 1st circuit is that when this circuit senses the concept of "danger", all other mental activity tends to come to a halt. This fact of crucial importance in mind-washing and brain programming.

Successful re-imprinting techniques for the 1st circuit work on the body first and then the mind. Rolfing is an example. This is also why all schools of Yoga place such emphasis on restoring natural breathing before trying to move the initiate toward higher states of consciousness. All martial arts are 1st circuit re-imprinting techniques.

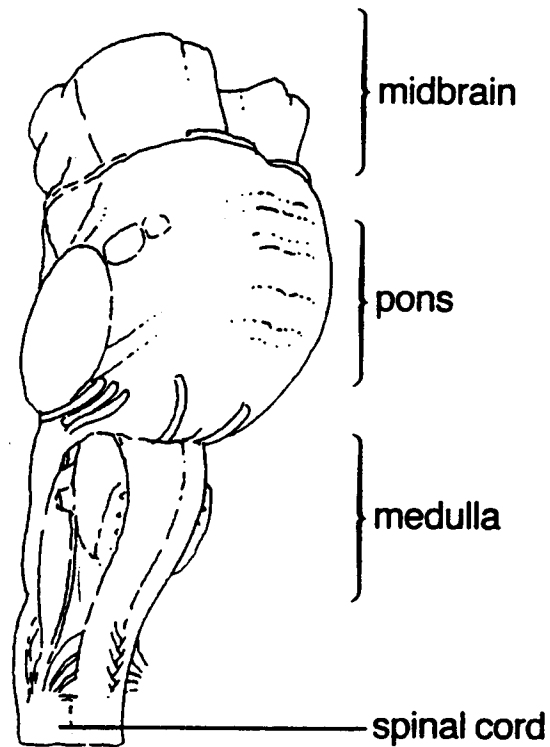

## The Brainstem

The brainstem is the oldest part of the brain. It evolved more than five hundred million years ago. Because it resembles the entire brain of a reptile, it is often referred to as the reptilian brain. It determines the general level of alertness and warns the organism of important incoming information, as well as handling basic bodily functions necessary for survival—breathing and heart rate.

## M A T R I X I I I

In Transactional Analysis, commonly referred to by the popular book, "I'm OK - You're OK", this state of consciousness is known as that of the "natural child".

Very often, since the circuitry operation in the 1st circuit is unconscious, people who have experiences involving apparent danger where they have performed more or less automatic actions come out of it stating "I don't know what happened - I just found myself doing it!"

### First Circuit Dualities

Functionally, the first circuit causes the evolvment of the following dualities in human behavior:

Anxiety or Self-Confidence  
Rootedness or Explorativeness  
Dependency or Independence  
Refusal or Anger when confronted with a problem.

Usually, 1st circuit problems take the form of body symptoms. The experience of message tranquilizes the 1st circuit.

### *The Second Brain Area and Its Functioning*

The 2nd brain area consists of the PONS and the FOURTH VENTRICLE in the brain system, and is typified by the early mammal or paleo-mammalian brain of birds and animals. It is tuned to the storage of experiences which extend beyond the immediate skin sensations of the 1st brain into the social dimension of our physical environment. In other words, the self-sense or identity is expanded beyond the skin to include others.

The PONS is that part of the brain which began to infold and become protected as the next most primitive part of the structure of the base of the skull, immediately above the MEDULLA OBLONGATA above the spinal column at the end of the spinal cord. It is the part of our brain which gives us a more refined memory than the immediate physical sensation and makes us act together with a response similar to the herd instinct of moist animals and the seeking of group protection.

Each level of brain structure have positive and negative expressions, so it is inappropriate to compare them and to criticize others for lower brain functions which in their right context are positive. Yet the limits of each level are only visible from the other levels and, in this sense, comparisons are helpful. For example, the time framework of the 1st brain consciousness, reacting to the pressure of the

M A T R I X I I I

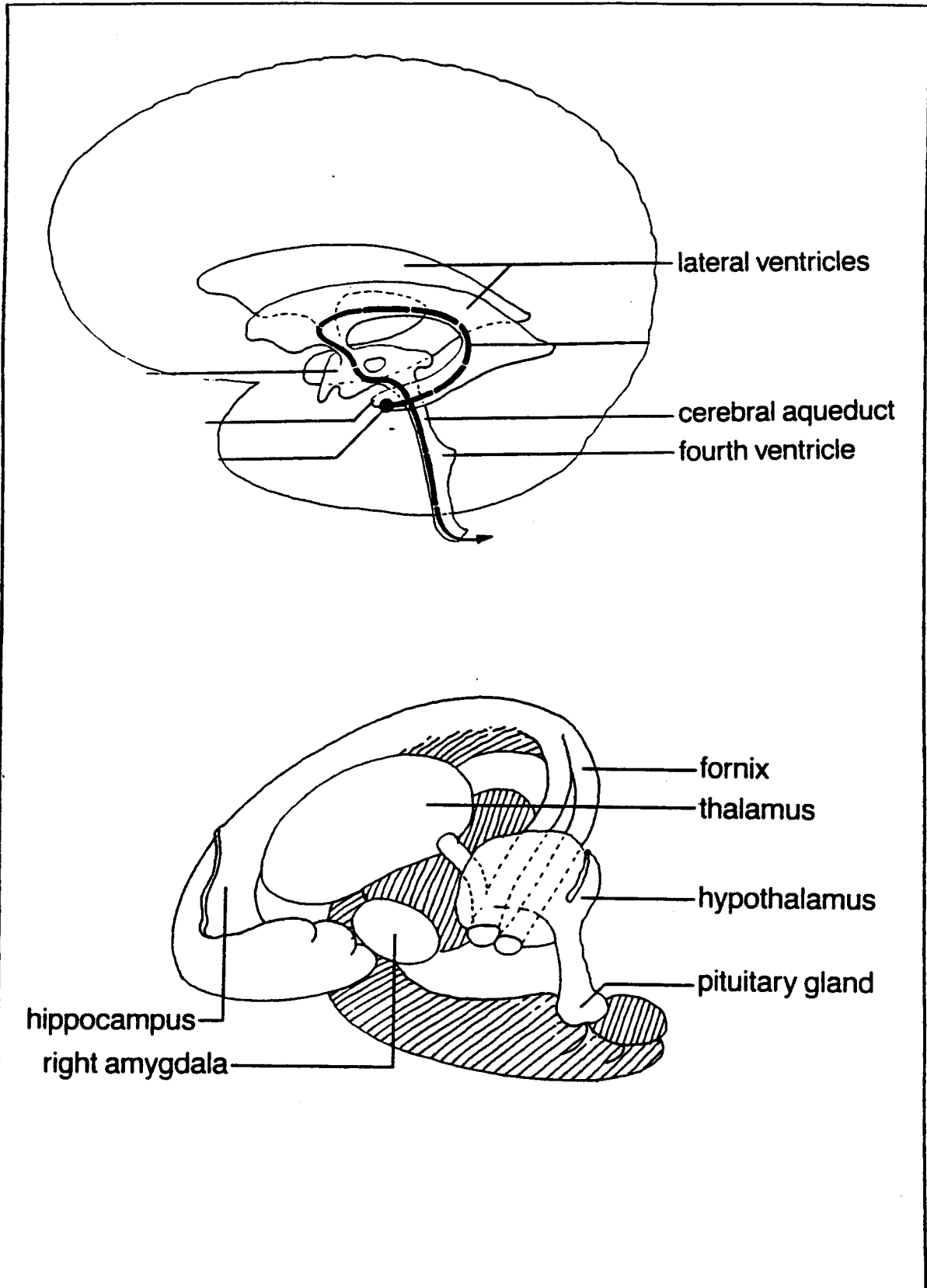

## M A T R I X I I I

moment, becomes very clear to someone acting in the 2nd brain. The time frame of the 2nd brain is the action of the immediate now put off to the future time of all interspecies interaction in the environment - the "future-oriented now". The reason action is put off and cannot happen "now", as in the previous 1st circuit level, is because in social contact, decisions to act are all held up pending the decisions and actions of others who all have independent wills, minds and sensations. This is the well-known delay in politics and in all social action which is put off until tomorrow.

Lacking the drive of the 2nd level of brain structure, humans would not congregate in groups. The modern version of primitive 2nd circuit emotion is a paranoid response to anyone who is different from ourselves. This is why war propaganda is so successful in uniting a society into some feeling of oneness, and why the New World Order considers itself to have a chance of being successful. This is the strategy that the Bush administration uses to manipulate the bulk of the U.S. population.

It is estimated that 50% of the human race has not evolved beyond a 2nd circuit controlled reality tunnel.

This circuit is also responsible for the manifestation of the fear of not being in the "in-crowd". There is the fear that others are getting something you are not getting., the feeling of missing out, the need for confirmation and approval from others, the need to be accepted and to belong. Acceptance gratifies pride, which a basic psychological attribute of the individual stuck in a reality tunnel centered around the 2nd structure of the brain.

This level of consciousness, when under-developed, is responsible for the lack of social feeling, exploitation of fellowman, enslaving of others, and cruelty, both to humans and other species.

Those who have conscious access to the 6th and 7th levels of brain structure are able to get inside other people and feel what they are experiencing or to project what is going to happen to people in the future, whereas people in the 1st circuit and structure of the brain must wait until the events are actually happening, and then they are not likely to feel what anyone but themselves must be feeling. The 2nd level "feel" for others is not this quality of empathy or identification as though the other were oneself, but rather is a sense of concern for "another". It is more of an identity by association. People functioning on the 2nd level can be selfish and uncaring, just as any people can, but the 1st level consciousness is more prone to think of people unfeelingly because they relate to people as sensory objects and they have not developed the 2nd level concern that is

## M A T R I X I I I

willing to reach out and acknowledge the being of another.

The 2nd stage of brain evolution was necessary as a foundation for that ultimate transcendence of the physical world in which we enter into oneness with the entire universe. It also is responsible for the "instinct to survive through posterity", and it is a major influence on the urge to procreate.

Functionally, the 2nd circuit could be called the Anal based Emotional Territorial circuit. It is imprinted in the "toddling" stage when the infant rises up, walks around and begins to struggle for power within the family structure. This mostly mammalian circuit processes territorial rules, emotional cons and games, pecking order, and rituals of domination or submission. The 2nd circuit is concerned with power politics, and is triggered chemically by alcohol, which is why alcohol is promoted in human society. It causes further division which promotes control of the human population.

The 2nd circuit is 500 million to 1 billion years old and is centralized in the THALAMUS. It is linked with the muscles and the voluntary nervous system. The circuit is chiefly imprinted by the perception of the nearest alpha male, which means the first perceived dominant male figure. Sometimes, the circuit is referred to as the EGO, which is a brain circuit that often mistakes itself for the whole SELF. The EGO is the imprint for the toddling and toilet training period. When you hear someone described as "acting like a 2 year-old", they are talking about someone who is firmly rooted in a reality tunnel of the 2nd brain and under the control of the circuit therein.

The 2nd circuit has an Anal orientation. People who are stuck in the 2nd brain circuits prefer to use anal-oriented words in their vocabulary. Expressions of this level of consciousness can be seen everywhere, including in the military, and especially in boot-camp, where everyone except the training instructors is referred to as an "ass-hole".

The activities which are centered around the 2nd circuit are based on the concept of positive feedback - and attempts to maintain a balance. This is why there is an overwhelming desire to please and pacify the training instructor in boot camp. The same reality structure is used in prisons and is generally spread in a thin layer over the structure of society in the United States. For a person stuck in the 2nd circuit, confronting a problem brings out both bullying and cowardliness.



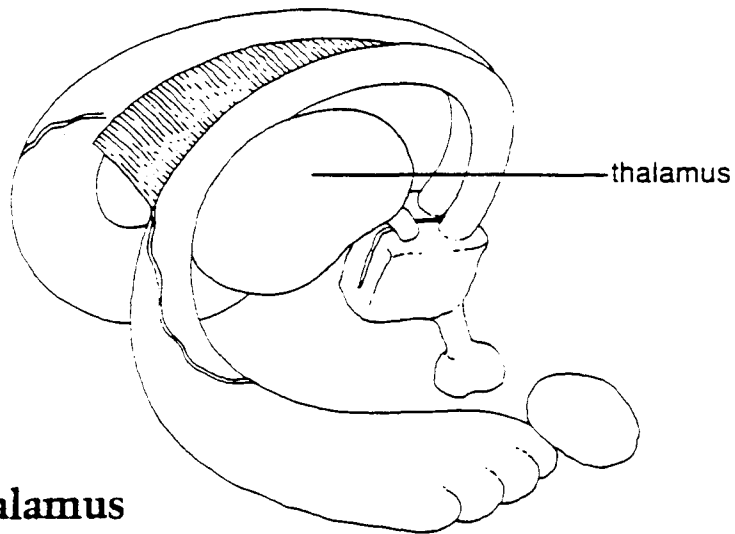

## The Thalamus

The thalamus, located more or less in the center of the forebrain, helps initiate consciousness and make preliminary classifications of external information. Certain areas of the thalamus are specialized to receive particular kinds of information, which they then relay to various areas of the cortex.

Located on both sides of the limbic system, in each hemisphere, are the basal ganglia. Like the cerebellum, they are concerned with movement control, particularly with starting or initiating movements. In the human brain, these exquisite networks of cells are large and well developed. Although they are functionally rather different, the basal ganglia and the major structures of the limbic system are next to one another because they are both closely interconnected with the highest level of the brain—the cerebral cortex.

## M A T R I X I I I

### Second Circuit Imprints

A person who has a heavy imprint on the 2nd circuit tends to be very muscular. Think of how many people you know that are in this psychological mode based on the 2nd circuit. People functioning within this circuit fear the idea of reason, and many times their answer to a problem is an attempt to frighten it away.

Dualities concerned with operations in the 2nd level of brain activity are:

Dominance or Submission  
Self-Confidence or Self-Doubt  
Strong Ego or Weak Ego  
High Pack Status or Low Pack Status  
Giving Orders or Taking Orders

### The Third Brain Circuit and Its Functioning

The next level of organization leading to the development of the 3rd brain structure is found in the ability of organisms, insects, animals and man to adapt to change. To adapt, we must have an organ of comparison. An organism must be able to weigh choices and make decisions. Something in our consciousness is able to gauge the differences and to discriminate similarities.

The Neo-mammalian memory is represented by the Cerebellum area and contains all our lower emotional responses situated below the mid-brain. Rich in cells and with complex connections with the brain above and the spinal cord below, the Cerebellum governs the coordination of all lower functions, including special acts concerned with range, direction, rate of force of movement, and the synchronization of physical organs. This part of the brain has the capacity for analysis and comparison so that whenever we have an experience which it is able to compare, it can randomly scan the lower brain structures and pick out sensory information and emotional responses, because this structure is situated in such a way that it can use the lower two brains at the same time.

This 3rd brain structure is what makes an intellectual. It makes us able to use all the logical and comparative sequential methods of analysis and to compare, contrast, differentiate and organize. It is linear in its functions and operates like a computer, and can scan, categorize and select because this part of the brain is cross-referenced and coded with all the signals entering into the first two brains. It can be used in the service of the brain's higher faculties,

## M A T R I X I I I

which were added at a later time in evolution, or it can remain cut off from them as nothing more than a hunting mechanism, used to rationalize any number of random actions and experiences from the lower two brain structures. Without imagination, this intellectual function is terribly dull. In an evolved person, the intellect becomes very sharp because it links with superior reasoning. Hence it was quite possible for the dull-minded scholars of the Inquisition to torture people in the name of Christ. It is also one impetus for the New World Order to destroy populations. Millions have been tortured by ruthless intellectuals who have no feelings and sensibilities above this level. Without the operation of the higher brain centers, there is a cut-off feeling of separation from the environment.

This may be the origin of schizophrenia, which occurs when the Mid-Brain and the Interbrain situated above the lower three brains cannot secrete the peptides or endorphins- the chemicals which relate the self-sense to our basic sensory experience. It is this part of the brain and brain circuitry which makes us feel separate from the universe and is therefore the seat of the ego or the sense of self and the beginning of that simple self-consciousness which separates itself from the whole.

Only when we see how these different levels of the brain, each rooted in a unique portion of evolutionary history, shape our perceptual reality, can we stop identifying with the lower levels of our inner third world and begin to create from the center of our being.

Functionally, the 3rd level of brain circuitry could be called the Time-Binding Semantic Circuit. It is imprinted and conditioned by human artifacts and symbol systems. It "handles" and "packages" the environment, classifying everything according to the Local Reality Tunnel. This is what Carl Sagan views as the "human Brain". This circuit, unlike the 2nd circuit based on positive feedback, is based on negative feedback, and seeks a higher level of equilibrium. It is very vulnerable to the imprint and conditions in the lower two brains.

It is in the 3rd circuit where time becomes conceptualized and experienced. The imprint sites for the third circuit are in the left cortex and are linked with the larynx. This is where one finds the emergence of scientific semantic rationality as a concept.

Since this circuit essentially breaks up the cycles in circuits 1 and 2, it is heavily sanctioned with taboos, rules, laws and prohibitions. If unleashed it leads to an upward spiral, or "progress", and open societies that are relatively free of taboos and dogmatism. Many taboos are unconscious and pass themselves off as the ideas of "common sense" or "common

M A T R I X I I I

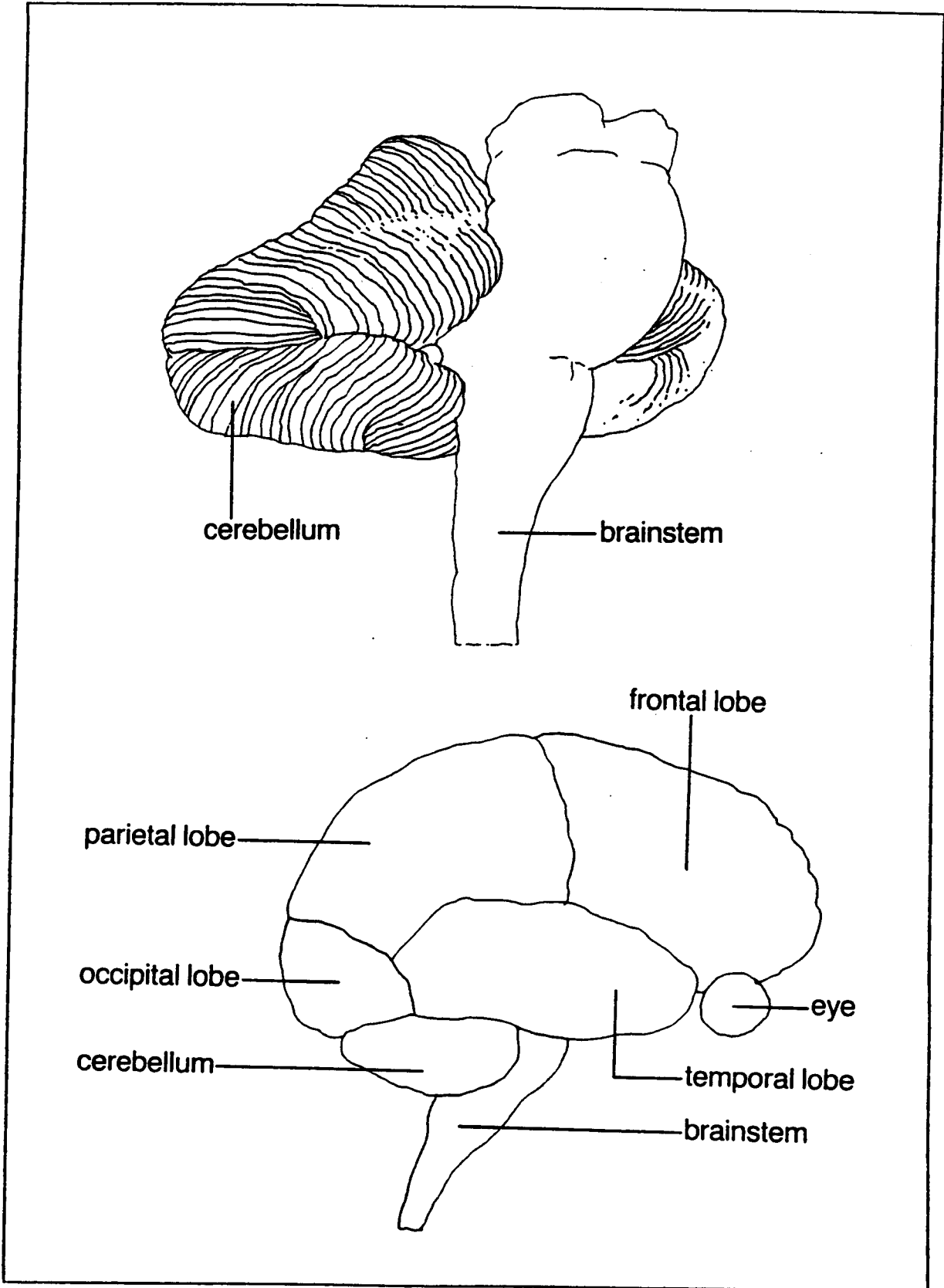

## M A T R I X I I I

decency". Anyone who challenges them is by definition a "heretic", a "traitor", or an "irresponsible nut".

Dualities arising from this level of brain structure and circuitry are:

Fluency or Inarticulateness  
Dexterity or Clumsiness  
"Good Mind" or "Dumb Mind"

The response to a problem, when viewed by someone who has dominance in this circuit, is to "reason it out". It is the reality tunnel of the rationalist, what could be called the "Third Circuit Robot". For people stuck in this circuit, the rest of the nervous system has, for all intents and purposes, stopped growing. Third circuit problems often take the form of perplexity.

People in the 3rd circuit often try to prove that much of human experience is "delusion", "hallucination", "group hallucination", "mere coincidence", "sheer coincidence", or "sloppy research". It would appear that CSISOP and many of the "UFO experts" fall neatly into this frame of consciousness.

The third circuit-based rationalist fears people who are demonstrating intuition.

All these circuits have evolved from the beginning to the point in present society. Other circuits have evolved in their use only to a small extent, and the higher circuits appear to pre-capitulate future evolution.

### The Fourth Brain Circuit and Its Functioning

The fourth brain structure is composed of the Mid-Brain, the hypothalamus, the thalamus and the floor structure of the inter-brain.

It is in the 4th brain structure that we can best see the close correlation between consciousness and matter, because the secretion of hormones in this brain creates the emotions we most identify with as the idea of "me". Just above the Mid-brain there are important nuclei concerned with the regulation of body temperature, metabolism, sexual development, sleep, endocrine secretions and their effect on the nervous system and personality. Our whole character can be changed by hormone exchange. Our evolution or stagnation hinges very strongly upon this area of the Mid-Brain and its control over our fluctuating identity.

Expressed in terms of the chakrá energies, you could say that the 4th brain structure regulates the energy or life-force which can only express in the chakras when they are

MATRIX III

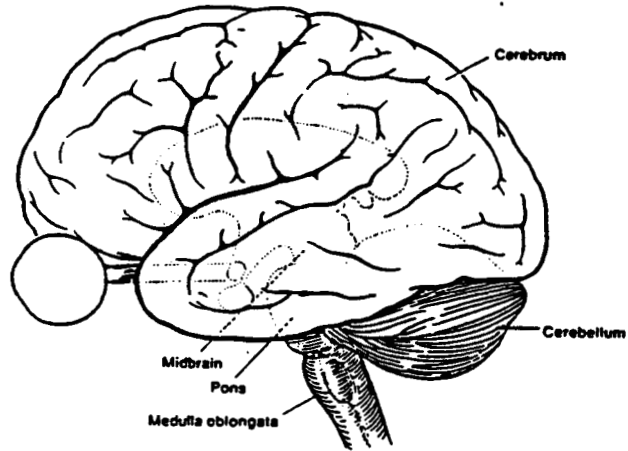

**FIG. 1.** Lateral view of brain showing its three major divisions: cerebrum, cerebellum, and brain stem. The brain stem is comprised of the midbrain, pons, and medulla.

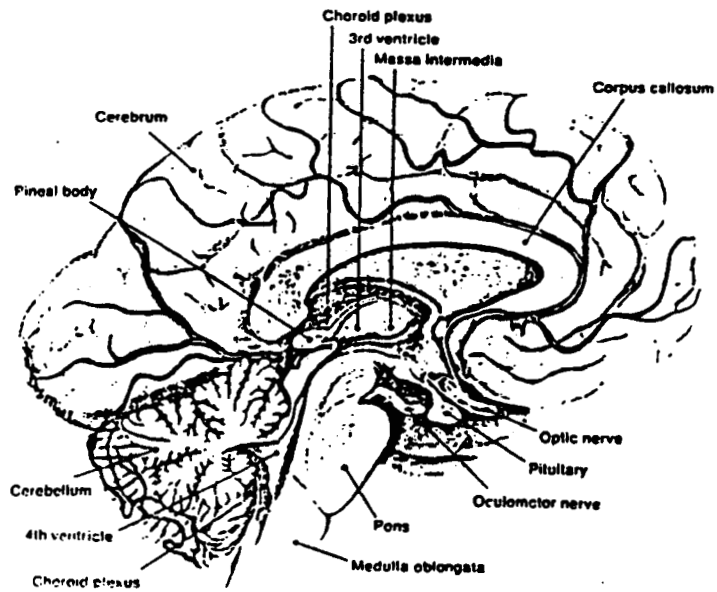

**FIG. 2.** Sagittal section through the midline of the brain showing detail of the medial surface of the left half of the brain.

## M A T R I X I I I

"open". In an intellectual, for example, the energy may be directed almost entirely through the 3rd brain structure, and only if something happened to prevent the intellect from its usual habits could it be re-directed down into the 1st chakra and be experienced as physical vitality or sexual feeling or the energy to manifest something. It might be directed upward into intuition and imagination, which would greatly enrich the intellect.

The 4th brain structures control the gateway to the higher functions of the brain which can supply power to the higher centers or shut them off at will. The maintenance of consciousness in the waking state is dependent on brain level 2, sometimes called the reticular formation. Without this basic power of life-force switched on, the powerful computers of the upper levels can only go into a coma and unconsciousness. Stimulation of the top part of this area of our brain in level 4 can rudely waken us from sleep, just as inactivity in this area puts us into a hypnogogic state we call a trance. Stimulation of its lower parts in level 2 will put us to sleep and unconscious activity of the Cerebrum while we begin to dream. Sleep is triggered by the secretions of peptides and enkephalins which build up on the 5th level above and act downwards upon the 4th level below to trigger this unconscious gateway to the mind. In states of hypnosis or the twilight drowsiness that comes before sleep, these peptides act upon the Mid-Brain 4th level to shut out our conscious mind and transfer our activity to the higher regions of the brain.

What makes the 4th brain structure a control center for the rest of the brain? Its central location between the three lower and the three higher levels makes the Mid-Brain a kind of crossroads where our consciousness can choose whether to cling to the stability of its oldest and time-proven brain circuits or to push forward in the direction of its future evolution.

The Mid-Brain connects the PONS on Level 2 with the Inter-brain above it on Level 5, which links Level 4 with the hemispheres. The Mid-Brain of Level 4 is continuous with the underside of the Inter-Brain and is joined with the optic thalamus, which forms the floor of the 3rd ventricle in the center of the Inter-brain. The ceiling of the Mid-Brain is the floor of the 3rd ventricle in the Interbrain in Level 5, is sometimes referred to as the Cave of Brahma by various Sanskrit texts.

The Mid-Brain is an important relay center for sensory impulses passing to the various computers surrounding the walls of the 3rd ventricle. Because the Mid-brain is located exactly in between the higher and lower brain structures, we feel it as the center of our being.

## M A T R I X I I I

In Yoga, the 4th level of consciousness is called the "heart center" and is a central focus for feelings coming from all other parts of the brain as well as the corresponding plexi in the lower nervous system where we feel our "isness". Because of this, the heart center is also the area where we feel threatened or confirmed in our being. Our feeling of possessiveness and our sense of lack, which are related to the storing up of vital forces in our body, all the feelings that have to do with insecurity and security, are controlled by this part of our brain.

This part of the brain, also called the hypothalamus and thalamus, also controls our use of fat and water. Fats stores the body's surplus oxygen, and water is the liquid crystal in which all the chemical reactions of the body take place.

The time framework for our 4th level feelings is past, present, and future since our feelings of insecurity respond to all three lower brain structures and go back and forth in time in a linear fashion much like the 3rd brain hunting for a slot. The 3rd brain, arranging things in the logic of past, present and future appears more mechanical, but really the 4th brain structure is just as much a computer even though it may not seem so because it is shifting in the realm of FEELINGS.

The 4th brain transfers its feelings of insecurity to the entire body and all other parts of the brain because the 4th level at the center of the brain is cross-referenced and wired to all other levels of our brain, both old and new parts which are all in a state of expectancy whenever we fall in love or become attached to anything.

The action of the hypothalamus on personality changes in humans can be seen by its power to control the pituitary gland at the front end of the Cave of Brahma. The hypothalamus, sitting on the floor of the Cave is connected by a fine network of capillaries which pass polypeptides which command the unconscious centers of the nervous system which regulate temperature, emotions, sleep, fear, rage and bliss.

Our feelings do not staircase neatly from high to low but affect each other by overlapping positive and negative vibration, cascading from level to level, by virtue of the central relay station called the "heart".

The process is not a linear one but a circular one ( a feedback loop) which comes through the filter of the thalamus in the roof of the midbrain that forms the floor of the Cave of Brahma. The control of our feelings of security and well-being in the thalamus center are polarized with our emotional fear and anger in the hypothalamus. This control at the level of the 4th brain is determined by our thought life and the choices we make on the next level, Level 5, where higher ideals overwhelm the primitive threat to our emotional



## M A T R I X I I I

security and cause us to choose the outwardly less hostile response to threat even though inwardly we are feeling like murder.

Each level has its own type of feeling. One can feel insecure at any level, yet the 4th brain structures feeling of insecurity is unique to itself. This is why when a person thinks that they are feeling this or that, it is hard to unravel the complexity of feelings. The heart center is the central focus of our feeling of BEING, rather than our thinking or sensing or socializing which occur on the lower three levels.

Functionally, the 4th structure circuit could be termed the "Socio-Sexual Circuit". It is imprinted by the first orgasm and mating experiences at puberty and is conditioned by taboos. It processes sexual pleasure, local reality tunnel definitions of "right and wrong", reproduction, adult-paternal roles and sex roles, and nurturing of the young. In this society, the circuit contains a lot of inherent "guilt" concepts embedded in the emotional matrix. There is an acute consciousness of Time, and the circuit loops back into Tribal Linear Time of the 2nd circuit. The location of the circuit is in the left Neo-cortex.

Dualities present as concepts in the circuit are:

Obedient or Disobedient  
Solid Citizen or Sexual Outlaw  
Parent or Anarchist

When people firmly rooted in a 4th circuit reality tunnel confront a problem, the problems often transmute into guilt associations and their solutions to problems often will involve a "moral" solution. This also reflects a part of the psychology of the U.S. political system.

Having seen the inter-connections and overlapping of the chemical emotions, social emotions, intellectual emotions and the emotions of our being at the 4th level, we can now proceed to discuss the 5th, 6th and 7th Levels.

### The Fifth Brain Circuit and Its Functioning

The 5th brain structure is composed of the Inter-Brain, The Third Ventricle and the hollow area known as the Cave of Brahma.

The region of the third ventricle in the 5th level of functioning is the very important concept-making and idea-producing development of the brain, and everything from here on is built around it. It is connected with the cerebral hemispheres of the Cerebrum above, in front, and behind, and

M A T R I X I I I

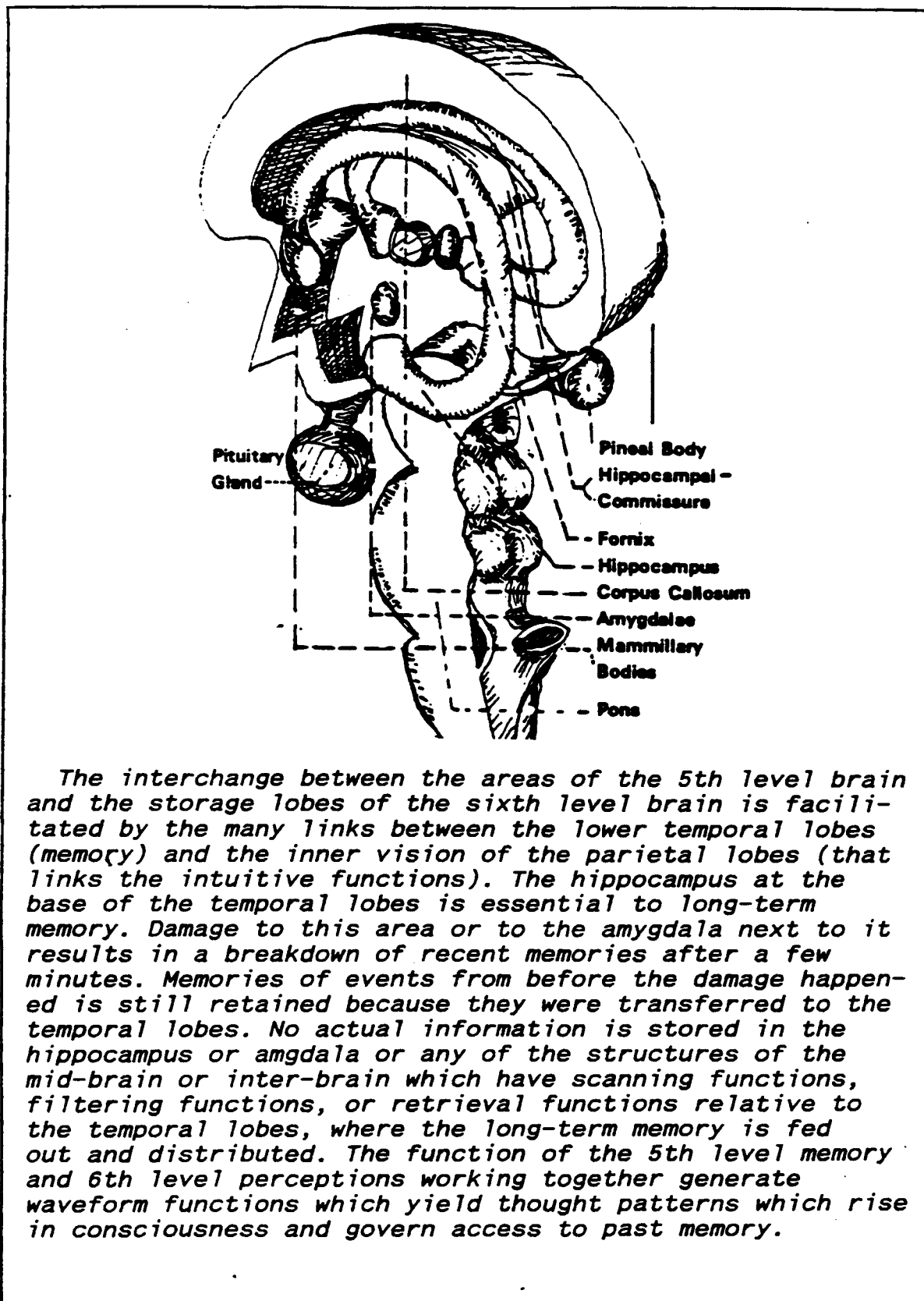

### M A T R I X I I I

with the Mid-Brain below it. The third ventricle is the cavity of the Inter-brain which has been called the Cave of Brahma. It passes between the two optic thalami which make up the floor and walls of the Inter-brain. Its roof is formed by the choroid plexus. At the front of the cavity is the pituitary gland and at the rear is the pineal gland, both very important to our perception. The third ventricle communicates with the two lateral ventricles which extend into the frontal lobes of the right and left hemispheres, and the rear end of the lateral ventricles extends into the occipital lobes of the cortex at the back of the hemispheres.

It is this central part of the brain evolution which enables us to store up higher abstractions and thoughts in our memory and to process new experiences, revive old emotional scars, recall deep fears and dreams. These higher centers of control on the 5th level of function determine how we shall respond to the signals, feelings, pains, and pleasures coming to us from the lower four levels of the brain.

Without this conceptual machinery to process our thoughts and primitive emotions, our organism would be like any other animal, only aware of the emotional chemical hormone releasing its response to stimuli. We would know pain but not the meaning of it. We would be able to communicate but we would not use any words or remember any thoughts and our internal life would be conditioned by the environment. Idealism as we know it would be absent from life. Without the 5th brain structure we would not be able to experience devotion or higher types of love nor analyze our emotions. We would not be able to compare them with previous experiences and memories recorded in the lower brains.

The comparing mechanism of the 5th brain structure is exactly opposite to that of the 3rd brain. The conceptual faculty of the 5th brain structure sees in terms of whole concepts. This is why the higher kinds of spiritual love can only be experienced through the later developed portions of the brain.

The time framework for this brain structure is the PAST because to have an experience and begin to reflect on it and think about it is already time past. The moment you begin to think about it, it is already in your memory.

The 5th level is an integrative function, capable of bringing together and comparing many concepts and patterns of higher emotions, capable of forming judgments of how life ought to be and making models and estimates of reality. Whereas the 4th brain is concerned with eating to obtain vital force, the function of the 5th level is the digestion of emotional "food". We take meaningful experiences of patterns from the external situation and compare them with what we have already internally stored in memory. This is the level of the

## M A T R I X I I I

brain which integrates ideas.

In the Third Ventricle, the Cave of Brahma, lies the potential to become that Cosmic Consciousness which this level of functioning is able to glimpse and worship. The only way to do it is wipe out the genetic memory inherited not only from this lifetime but from many incarnations and biological successes and failures in the evolvement of the world of flesh and matter. You must wipe the mind clear so that it frees it up and it becomes new-born, a new vehicle, able to perceive things as they really are, without the constant checking against the storehouse of memory. The kind of mind that has been freed of options also has been freed of memory and can put new memories in.

Functionally, the 5th structure circuit can be called the "Holistic Neuro-Somatic Circuit". It is imprinted by ecstatic experience. It processes feedback loops, somatic sensory bliss, feeling "high", etc. Tantra yoga is concerned with shifting consciousness entirely into this circuit.

The circuitry does not manifest in all human beings. It began to appear about 30,000 years ago. It is in this circuit where the nervous system begins to direct the body. Structurally, it is bound to the right cortex and is connected to the limbic elements of the 1st circuit and the genitalia.

Some 5th circuit consciousness is triggered by prolonged sex play, pranayama breathing, and cannabis. Fifth circuit bliss includes the ability to heal disease. The fact that this circuit is chemically triggered by marijuana is the main reason its use is discouraged in our culture.

Some 5th circuit experience is produced when a person undergoes voluntary isolation in a flotation tank.

It is estimated that there will be major changes involved on the planet on a social level when 51% of the population reaches the ability to achieve consciousness in this level. The 5th level and the levels above are preparing us for extra-terrestrial migration.

### The Sixth Brain Circuit and Its Functioning

The 6th brain process which controls and overshadows the 5th level storing of memory and unconsciously decides how we shall respond and identify in any given situation is loosely called "intuition". When we use our intuitive threshold of consciousness our brain responds to situations from subtle inner feelings and perceptions which get filtered through our gridwork of previous knowledge and experiences stored in the lower brains. There are several kinds of intuition, but the

M A T R I X I I I

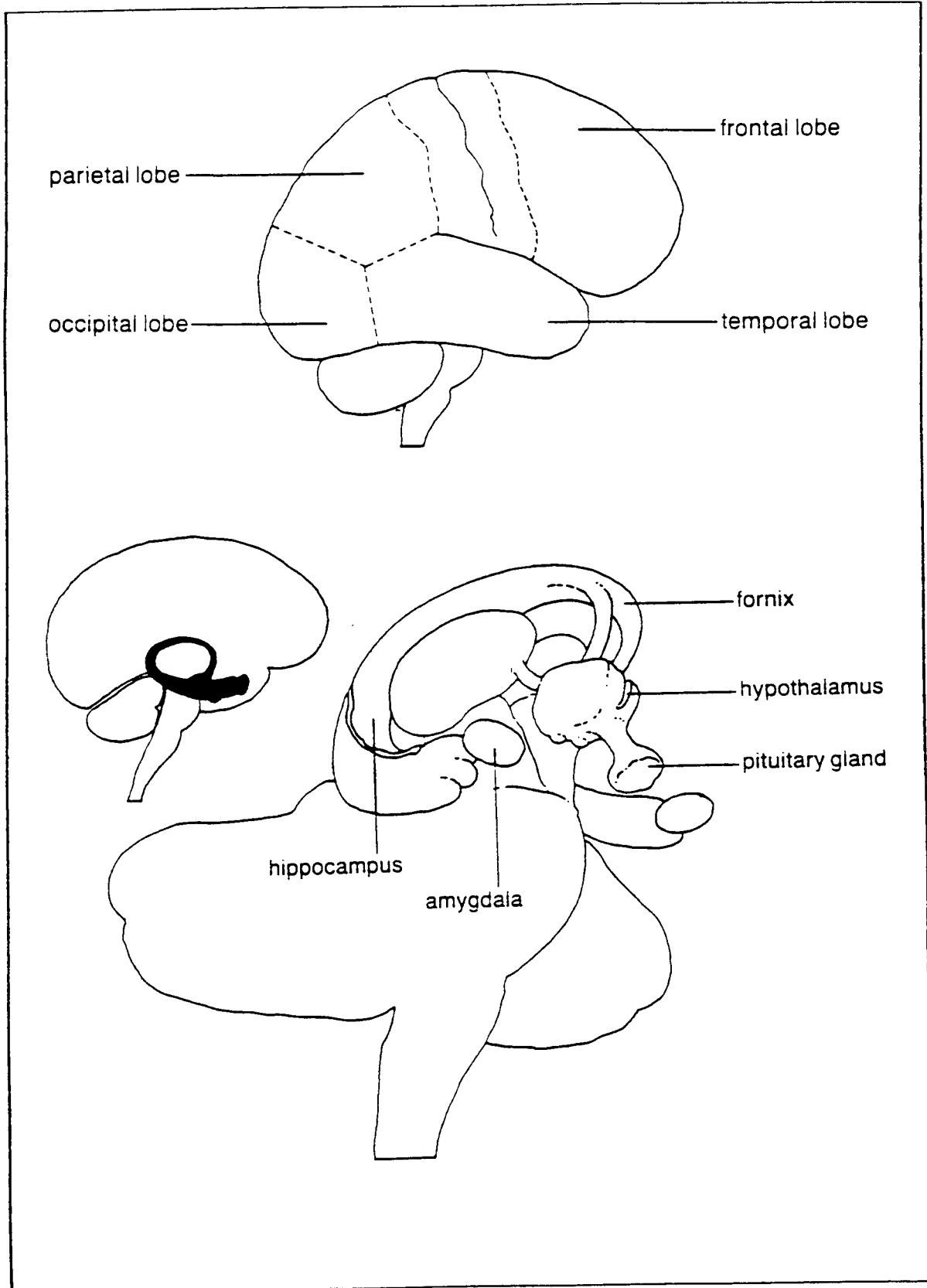

## M A T R I X I I I

kind everyone has is "knowing without forming concepts". Hunches or premonitions that later manifest in apparent coincidences are common ways that people awaken to this level of perception which not only governs ESP but places each of us on the threshold of higher consciousness. Most people do not know what "higher consciousness" is; they only know what lower consciousness is and called it "normal".

Level 6 evolves a wider kind of consciousness that is capable of transforming the quality of awareness on all the five levels below it. In most people, the 6th level is only an inner sense that keeps us in balance physically, recognizes what we see and hear, and puts our knowing into some form. In others, this 6th structure of the brain can open to a marvelous and wondrous kind of psychic knowing which goes on at a far deeper level than thoughts or concepts - a level where our receptivity attracts an insight, like a revelation which can surprise us as much as anyone else. Most people do not know that this psychic faculty must be trained as any other physical faculty if it is to work correctly.

One aspect of 6th level "knowing" is perception of the future. Level 6 and Level 7 are closely linked in the kind of power they give us to shape our consciousness, since the future is the unfolding of events which are being programmed in the "total mind" of the 7th level above. The power we have to receive information through images is the power of 6th level intuition to receive a non-sensory sensation or impression from the 7th level and then store it in our 5th level memory. That is, we can have information about an event that from a lower level of consciousness hasn't happened yet and store it in our memory so that when it happened we'd say "Yes, I know that already".

The cerebral hemispheres of Level 6 are each divided into three lobes in the left hemisphere and three lobes in the right hemisphere and the 7th brain structure is another pair of lobes which we call the frontal lobes, which are situated above the lobes of level 6. Level 7 governs our higher abstractions and imagination.

Each lobe of the cerebral brain has a different function. The frontmost lobes are the Parietals, which are for our use of inner vision. The back lobes, the occipitals, govern our sense of sight and the focussing of sighted objects. The middle two lobes are the temporals, which govern and arrange our conceptual speech, our listening and our physical balance. Concepts have to be joined together holistically from all of our sensations from the separate senses acting together. It is this part of our brain surrounding the inner vision of the parietals that raises our sensory perceptions of the environment around us to a higher level of abstract ideas and gives us the feeling of knowing.

## M A T R I X I I I

The 6th evolutionary stage of the brain makes possible two distinct methods of visualizing, both of which are quite different from the imaging of the imagination on level 7. The occipital lobes make possible our sense of sight in the external environment, whereas the parietals make possible the inner "seeing" of the intuition. Together they make the process of seeing an entirely different experience from the animals. The underdeveloped person who has not yet switched on the capacity of the 6th level brain structures sees only with the outer vision, just like the animals.

It is the pituitary, contained within the 6th brain, triggered by the parietals, that switches on a supply of endocrine chemical hormones to the areas in the frontal lobes, rear lobes, throughout the brain, and to the blood stream constantly bathing the brain cells, which triggers the 6th level perception throughout the brain as a whole. These hormones activate the intuitive awareness that can transform our brain function.

The peptides which trigger the intuitive awareness, called enkephalins, become psychologically active when they are released into the Cave of Brahma from the pituitary and hypothalamus. Only when this occurs do we become aware that we are aware., the significant achievement of the 6th level of consciousness.

The visual cortex at the back of the brain allows us to focus on objects and draws the sensations from the eye back into the head to the area of the occipitals, where we experience shape and color. The sense of seeing light, its shapes and forms, is also processed simultaneously by the various thalami situated around the walls of the Cave of Brahma acted upon by the pituitary and parietal functions. The external and internal visual systems interact normally unless you close your eyes or have blinders on and shut them off. When this happens, the inner vision system operates independently from the visual cortex which focuses light.

The most important way we can use our "inner eye" visual system is to realize that it is fed out of the periphery of the retina and literally sees out of the corner of our eyes. We can practice looking out the corners of the eyes to stretch this visual system. This inner sight can be developed where you can see for 360 degrees around you.

With the inner vision you see with your entire being, with every cell and atom of your body. Your inner vision is even coupled to your ears, which take over to locate your position unconsciously in the environment.

The purpose of various disciplines is the withdrawal of consciousness from the lower brains into the higher to stimulate the functioning of the pituitary and the

## M A T R I X I I I

hypothalamus. When this fore-brain area is activated, the inner seeing develops and takes control over the rest of the brain. The seer becomes master of himself and all the lower functions render service to the seer who is receiving direction and guidance from the 7th level above. When the internal functions of the brain fulfill their purpose and become linked with the whole, a harmonious resonance sets in between all the levels and between the inner and outer environment. This 6th brain structure is the seat of the higher non-sensory pleasure center. It has been found experimentally that stimulation of the fore-brain bundle of nerves near the pituitary gland, which pass through the hypothalamus, gives animals the highest rate of self-stimulation rewards. The same area is stimulated in humans during meditation or the fixation of consciousness on this part of the brain, and brings blissful states which exert a powerful influence on human behavior.

If you dream in color or can close your eyes and see distinct images or colors, it is indicative that your 6th level has begun to function and become sensitized to the impressions from the level of imagination above.

Functionally, the 6th brain structure circuit could be called the collective neurogenetic circuit. It is imprinted by bio-electrical stresses. It is concerned with processing DNA-RNA feedback systems and is "collective" in that it contains access to the whole evolutionary script, past and future. The operation of the 6th circuit indicates that it is receiving signals from the neurons themselves. The Chinese know this area as the Great Tao. In Theosophy, it is the access point to what they term the Akashic Records.

If you are noticing more synchronicity and apparent coincidences in your life, it is also an indication that you are tapping into 6th circuit potentials, since synchronicity demonstrates that everything is part of one thing. The 6th circuit is a collective DNA circuit.

### The Seventh Brain Circuit and Its Functioning

The 7th system of the brain is centered in the frontal lobes on a physiological level. It involves the imagination and also involves the brain becoming aware of itself. It can functionally be described as the "Metaprogramming Circuit", which is imprinted by advanced disciplines. In Tibetan Buddhism, it is called the White Light of the Void. From a viewpoint of the 7th circuit, 3rd circuit reality maps become comic and relativistic. There is perception of infinite realities. It is a creative Void which represents cybernetic consciousness, in which the programmer begins to program himself.



## M A T R I X I I I

The fact that our consciousness can operate on seven distinct levels without our consciously knowing that all images and thoughts are ultimately annihilated after they pass the 7th level, is a humiliating thought for most people who think they have this whole communication thing pretty well wrapped up. To accept that each individual in reality passes into a black hole would be considered by most people a figment of the imagination. Yet if we think about it, that is what happens to all of our thoughts - they pass into the black hole of consciousness in which all things in the material world and all their patterns and images are ultimately experienced and then disappear, leaving only a memory. You become the path. The center of your being becomes the nucleus, the Source itself, radiating to itself its own light. Once you joint with the Source in that kind of feedback, then you become the source; there is no separation between the Source, the signal, the receiver, and the sender. The only way to get to that space is to tune to that Source and wait for the answering blessing. The Source is looking for the conscious response from the creation, a response inward to the nucleus, in order to establish a clear line of communication.

### A Model of Conscious and the Seven Dimensional Planes According to William Tiller

According to William Tiller, a physicist at Stanford University, there exists model of consciousness which takes into account the knowledge obtained through various Yogic disciplines, as well as the holographic aspects inherent in the structure of reality. It is a different, perhaps a transitional, way of illustrating the multidimensional aspects of the universe as related to human beings.

In Tiller's view, humans are essentially the elements of Spirit that are multiplexed to aspects that he refers to as Divine. His model of consciousness has been called the Lattice Model of Consciousness. In this model the Spirit, in order to have a mechanism for experiencing, has Mind embedded within it. Mind is seen as the builder, and in order to have a learning experience, Mind imbedded within itself two interpenetrating conjugate frames of reference in the universe which he calls the positive and negative space/time frames. Springing from these is substance, which takes on various structural forms which have function. Sheldrakes work on morphogenetic fields seems to apply to this model in a holistic way.

From this kind of modeling, we can see what is meant by the statement that the brain "is in" the mind but the mind does not have its origin in the brain. The mind is everywhere (frequency rather than distance is localized) and in every-

## M A T R I X I I I

thing to some degree or another depending on the dimensional nature of the interaction. The brain, in this view, is a spacially localized object that overlaps certain aspects of the mind. How does the brain function when we do things like remote viewing? Certainly the holographic nature of reality explains a lot; at the same time our consciousness is certain position coordinates within the brain, it is also in interactive communication at the negative space/time level with something at another set of coordinates. Everyone has this capacity. It is just a grid correlation between frequency information and distance information. It is not unreasonable because of the Fourier Transform relationship.

Take a look at the illustration below:

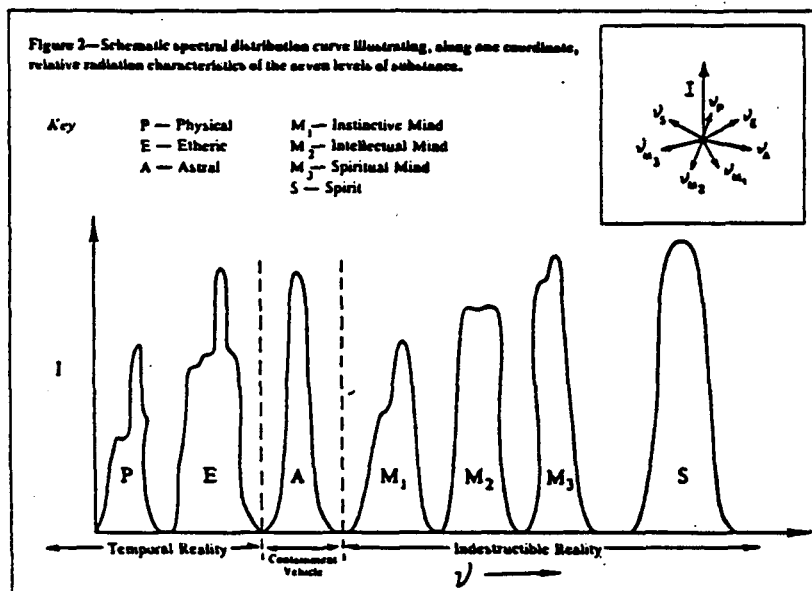

The above illustration is the kind of picture that would arise if we expressed a representation of seven dimensions of radiation according to Tiller's viewpoint. In his view, there is a temporal aspect, presumably bound to a time-track, and an indestructible aspect to the human being. In this model, there is the Spirit, three levels of mind (instinctual, intellectual and spiritual) which relate loosely to three sections of the brain (the root brain, the right and left cortex, and the frontal lobes), etheric substance, physical substance, and the astral level, which he views as a transitional domain in which our Being is contained between periods of physicality, which is usually known as "reincarnation". In this system, there can be energy interactions between these different levels so that if one level is perturbed, a ratchet effect can cause energy trains to travel to different dimensions and one can experience phenomena developing at different locations.

According to Tiller, at the three-dimensional level we think primarily in terms of electrical and magnetic energies,

## M A T R I X I I I

although there are many types of energies which function in a sort of spacial lattice. These energies, according to this model, function much like the electrons within a crystal lattice in that they form into energy bands. The higher the level of consciousness, the more energy band correlations there are and the higher the dimensional functioning is.

In reference to the diagram on this page, the physical body functions in positive and negative space/time. Within this framework, there are various contrasts between matter in its physical form and matter in a slightly higher vibrational rate in the etheric form. A chart will help you see the relationship according to this model. Note that there is a mirror-like relationship between physical and etheric matter according to this model:

<u>Physical Matter</u>	<u>Etheric Matter</u>
Electric Monopole	Magnetic Monopole
Positive Mass	Negative Mass
Slower than light	Superluminal speeds
Positive Energy States	Negative Energy States
Positive Time Flow	Negative Time Flow
Screened by Faraday Cage	Not Screened
Space I	Space II
Positive Space/Time	Negative Space/Time

As matter (particles) are accelerated and approach the speed of light, the energy approaches positive infinity. It then tunnels thru hyperspace and approaches negative infinity. When  $v = c_0$  then it is in negative space/time, i.e., it moves with negative energy (mass becomes negative). Its potential energy becomes very high and its kinetic energy negative; it can exceed the speed of light. When this occurs, matter has become etheric and no longer physical. A diagram might help you visualize this, and it's shown on the next page.

MATRIX III

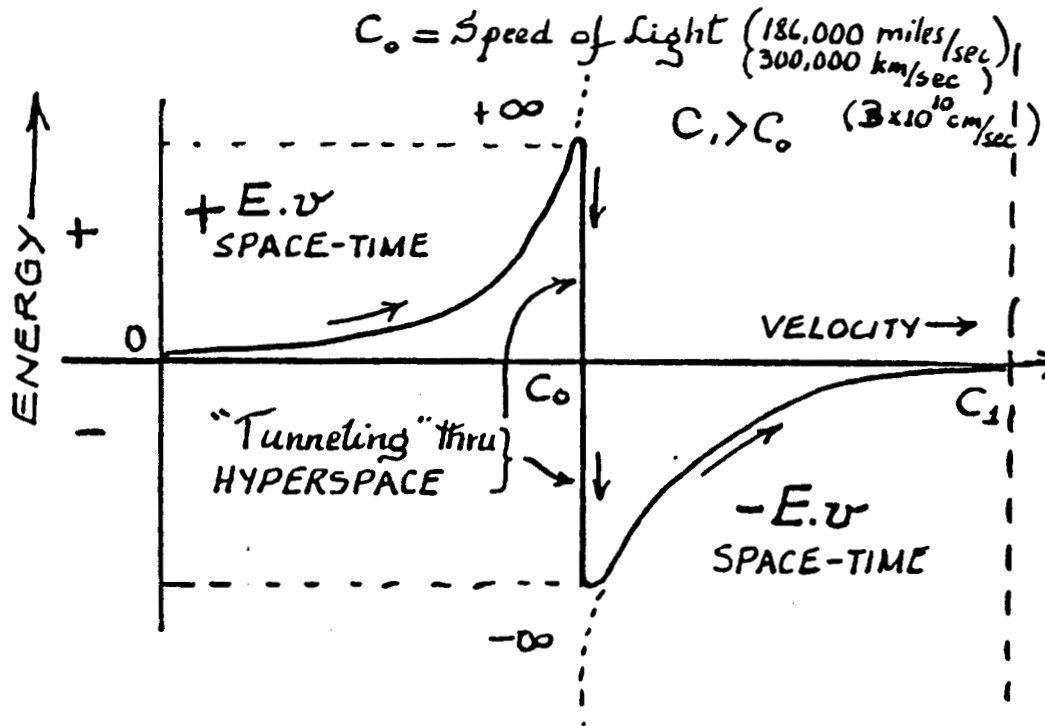

In the diagram above, it is seen that as matter in the form of particles are accelerated and approach the speed of light, the energy approaches positive infinity. Then, it "tunnels" through hyperspace and approaches negative infinity. When  $v=C_0$  then it is in "negative" space-time - it moves with negative energy (the mass becomes negative). Its potential energy also becomes very high and the kinetic energy becomes negative. Hence, it can travel faster than light. When this occurs, matter has become etheric and is no longer in third density - physical.

M A T R I X I I I

Circuit Designation	Imprinting	Neuro Areas
Oral Bio-Survival	Imprinted by first mothering object  Sucking, Feeding, Cuddling and Body Security	Brain Stem Autonomic System  Connected with Endocrine and Life Support
Anal Emotional Territorial	Toddling stage Territorial Rules Emotional Games Pecking Order Domination/ Submiss	Thalamus  Connected with muscles and voluntary N.S.
Time-Binding Semantic	Human artifacts & Symbol Systems Invention Calculation Classifying	Left Cortex  Linked with Larynx - Voice
"Moral" Socio-Sexual	Orgasm-Mating Exp Taboo Conditioning Sexual Pleasure Right and Wrong Sex Roles Reproduction	Left Neo-Cortex  Linked with Genitals and Breasts
Holistic Neurosomatic	Ecstatic experience Sensory Bliss Feeling "High"  Processes a feed-back to circuit 1.	Right Cortex  Linked to Limbic in 1st circuit and genitals
Collective Neurogenetic	Bio-chemical stress Electrical stress	Right Hemisphere  Collective DNA Circuit
Metaprogramming	Advanced Yoga	Frontal Lobes  Control over all lower circuits
Non-Local Quantum	Shock, Near-death experiences, OOB, Precognition. R.V.	Awareness Outside of Nervous System

M A T R I X I I I

Circuit Designation	Chemical Triggers	Density Trend
Oral Bio-Survival	Opiates, Heroin	Second Density
Anal Emotional Territorial	Alcohol	2nd -3rd Density
Time-Binding Semantic	Coffee, Speed High-Protein Diet Cocaine	Third Density
"Moral" Socio-Sexual	Various Botanicals	3rd to 4th Stimulus
Holistic Neurosomatic	Cannibis THC Marijuana	3rd to 4th Acceleration
Collective Neurogenetic	Mescaline Psiocybin Peyote LSD	3rd to 4th Stabilization
Metaprogramming	LSD Peyote Psilocybin	4th Density Transfer
Non-Local Quantum	Katamine- Dissociative Anesthetic	4th ++ Acceleration

M A T R I X I I I

Circuit Designation	Social Acceptance	Geometry
Oral Bio-Survival	Promoted	Euclidian Focus on Outer Technology
Anal Emotional Territorial	Promoted	Euclidian Focus on Outer Technology
Time-Binding Semantic	Promoted	Euclidian Focus on Outer Technology
"Moral" Socio-Sexual	Promoted	Euclidian Focus on Outer Technology
Holistic Neurosomatic	Discouraged	Multi-Dimensional Inner Technology
Collective Neurogenetic	Forbidden	Multi-Dimensional Inner Technology
Metaprogramming	Forbidden	Multi-Dimensional Inner Technology
Non-Local Quantum	Forbidden	Multi-Dimensional Inner Technology

M A T R I X I I I

Circuit Designation	STAR TREK EXAMPLES	Comparative A
Oral Bio-Survival	" SCOTTY " " TROY "	Bio-Survival Passivity  Substrate of Cellular Intelligence
Anal Emotional Territorial	" DR McCOY " " WOLF "	Identifies Ext Stimuli for Dominant/Aggressive Personal Space Submissive/Cooper.
Time-Binding Semantic	" DR SPOCK "	Dexterity Right/Left Dull /Bright Trust Ego Status
"Moral" Socio-Sexual	" CAPT KIRK "	Transmission of Culture across Generations  Adult Personality
Holistic Neurosomatic	" CAPT PICARD "	Detachment from Compulsives in Circuits 1-4
Collective Neurogenetic	ALIEN INTELLIGENCE  " DATA "	Conscious choice To Share Others Reality Experience Telepathics Multiple Choices Relativity
Metaprogramming	ALIEN INTELLIGENCE  " GUYNAN "	Interspecies Symbiosis becomes Conscious Genetic Archives Activated by Anti-Histone Prot
Non-Local Quantum	ALIEN INTELLIGENCE " NANNITES "	Quantum Communications Without Body Need



M A T R I X I I I

Circuit Designation	Gurdjieff	Carl Sagan
Oral Bio-Survival 1st Brain Circuit	Movement Center	Reptile Brain
Anal Emotional Territorial 2nd Brain Circuit	False Emotion Center	Mammal Brain
Time-Binding Semantic 3rd Brain Circuit	False Intellect Center	Human Brain
"Moral" Socio-Sexual 4th Brain Circuit	False Personality Center	Ignored
	— Level 48 —	
Holistic Neurosomatic 5th Brain Circuit	Vibrational Level 24	Ignored
Collective Neurogenetic 6th Brain Circuit	Vibration Level 12	Ignored
Metaprogramming 7th Brain Circuit	Vibration Level 6	Ignored
Non-Local Quantum	Vibration Level 3	Ignored

# M A T R I X I I I

## NOTES

1. Whenever two or more oscillators in the same field are pulsing at nearly the same time, they tend to "lock-in", because nature seeks the most efficient energy state. Living organisms are oscillators. There is also a "lock-in" of body movements when two people are talking with each other; body movement patterns were broken down by Dr. William Condon of Boston University Medical School - the smallest unit of movement occurs in 1/48th of a second.

2.Nothing in the fundamental laws of physics forbids the transmission of information from the "future" to the present. A field can theoretically be observed before it has been generated by its source.

3.A hypothesis by the Soviets holds that ELF waves carry the information necessary for remote viewing. Schumann waves of 7.8 cps might be "locked-in" to the pulsing of human brains, connecting them at a distance. The connection would be one of resonance rather than radiation.

4.In the words of Princeton physicist John Wheeler, "I think that through out own act of consciously choosing and posing questions about the universe, we bring about in some measure what we see taking place before us."

5.In 1964, physicist J.S.Bell emphasized that "no theory of reality compatible with quantum theory can require spatially separated events to be independent."

6.Whenever two or more sets of waves intersect, holographic effects are possible. Since everything warmer than absolute zero is constantly producing wave fields, and every organized combination of particles is also broadcasting its own unique fields, the number of intersecting sets of waves approaches infinity. Theoretically, some sort of super hologram could be made at any spot in the universe that would contain information about the whole universe from that vantage point.

7. Dr Carl Pribram of Stanford University: "A hologram arises in any system, whether optical, computer, or neural."

8.A "probability wave" is a mathematical formulation that exists in n-dimensional space. Probability waves are continuously being used in real experiments that yield real results; x particles can be described in 6x dimensions in n-dimensional space.

9.Definitions: Holonomic - in the nature of a hologram.  
Holoïd - entity that is holonomic  
Holonomy - quality of being holonomic

## M A T R I X I I I

10. A persons structure is made up of information from the probability wave holoïd. The information is not sensory in the usual sense. It is structural.

11. We could expect each increase in organized complexity to result in successively brighter and sharper pictures of "the all".

12. Relationships between things and things themselves are mutually dependent and complementary.

13. EGO can be seen as a specific unequivocal constraint against the experience of holonomy. It allows perceptions of separateness and disallows perceptions of oneness with the universe.

14. From early childhood, humans are taught that GOALS are more important than EXPERIENCE. Because of this, humans are encouraged to distrust their deepest feelings and to endeavor to override their natural rhythms.

15. Sometimes, the most complex, difficult, and dangerous tasks are done with apparent effortlessness, without much thought on the part of the doer. These experiences demonstrate a state of perfect rhythm, and function in a way that is beyond judgment. A judgmental attitude, judging an experience before it actually occurs, blocks this rhythm.

16. The current model in medicine is based on external authority rather than individual self-responsibility.

17. Intentionality can be thought of as the vector of identity. It always works initially in terms of structure rather than of the material through which the structure manifests itself. It is primary and irreducible, and is not necessarily lodged in conscious thought or will, although conscious will can be an instrument of intentionality. Effective intentionality springs not from Ego, but from Identity, which transcends categories such as "body" and "mind". Identity exists in the NOW, in the individual immediacy of an occasion. As long as you can envision something, you can do it. The practice entails creating a sense of the event that is vivid and fully realized, which is an occasion in itself; a state of focused surrender. Intense effort becomes effective only through total surrender, during which intentionality can alter structure.

18. In the current society in the United States, a "stable" society requires "suppression or voluntary renunciation of unlimited individual power or, at least, an implicit consensus about just what power can be used or tolerated."

19. The present moment, the NOW, contains an element of genuine novelty, and the "future" is never wholly predictable. Perhaps the only prediction that can be made about the "future" is

## M A T R I X I I I

that it will surprise us. A truly centered person, experiencing that he or she is at the center of an expanding universe, will feel no compulsion to push and shove others out of the way. A truly centered person, aware that intention and action takes place in a universe of ever-increasing probabilities, will feel no need to encroach upon or exploit others for selfish purposes, there being a practically unlimited supply of non-exploiting options from which to choose.

20. To influence the "future" consciously, taking responsibility for the "future" outcome of your experience, is to participate in the ultimate adventure.

21. Every self-regulating system has a built-in resistance to change, no matter that we might judgmentally consider the change "good" or "bad". Potentially, we know everything - a lot more than we can say.

22. When you look at a scene without focusing on any particular object the right hemisphere pulsates at 16 cps and the left hemisphere pulsate at 12 cps and you are in a state which features predominant alpha waves. It is a receptive state where the whole visual field is taken in. When you focus on one object, both hemispheres pulsate with an overall frequency of 16 cps and the predominant frequency is in the beta wave range.

## *The LEADING EDGE*

The *LEADING EDGE* is the main publication of the LEADING EDGE RESEARCH

GROUP, which has a worldwide research network spanning 35 states and 15 foreign countries. The *LEADING EDGE* is a monthly publication of 100 pages which includes, but is not limited to, discussions and research on consciousness, awareness, self-empowerment, alien interaction and cultural studies, human abduction and manipulation, primary and free energy technology, space and time technology, psychotronics radionics and mind control, genetic engineering, species-specific power structures, overt and covert domination and control systems, gravitational technology, and factors affecting social development and evolution.

Sample issue \$12.00 postpaid. LEADING EDGE RESEARCH, P.O. BOX 7530, YELM, WASHINGTON, 98597.



After carelessly walking into the wrong house expecting a surprise birthday party, Biff finally realizes he has been shot.

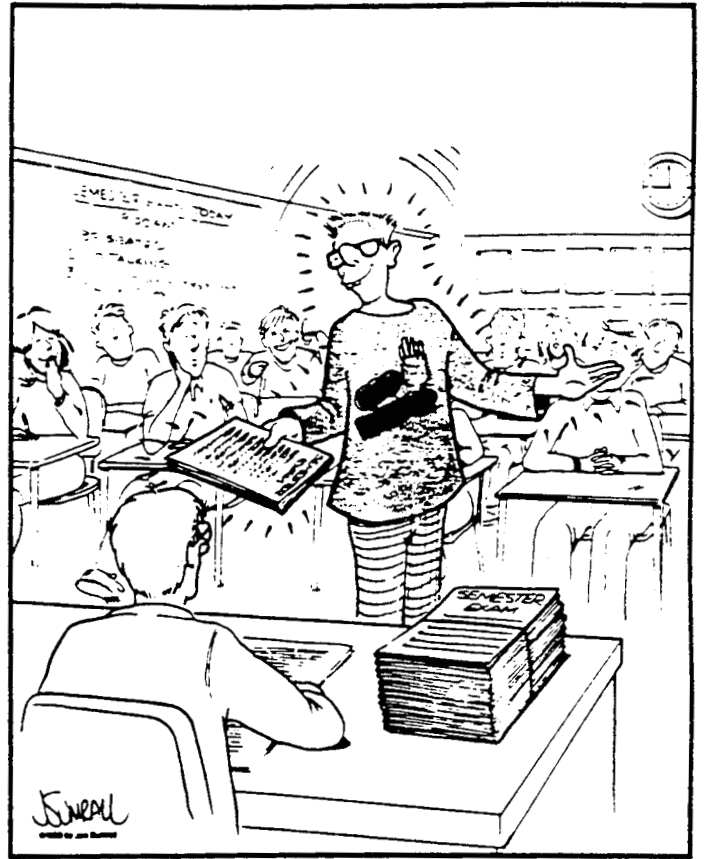

Herman experiences a quantum pop in time as he suddenly finds himself turning in a test that hasn't even been passed out yet.

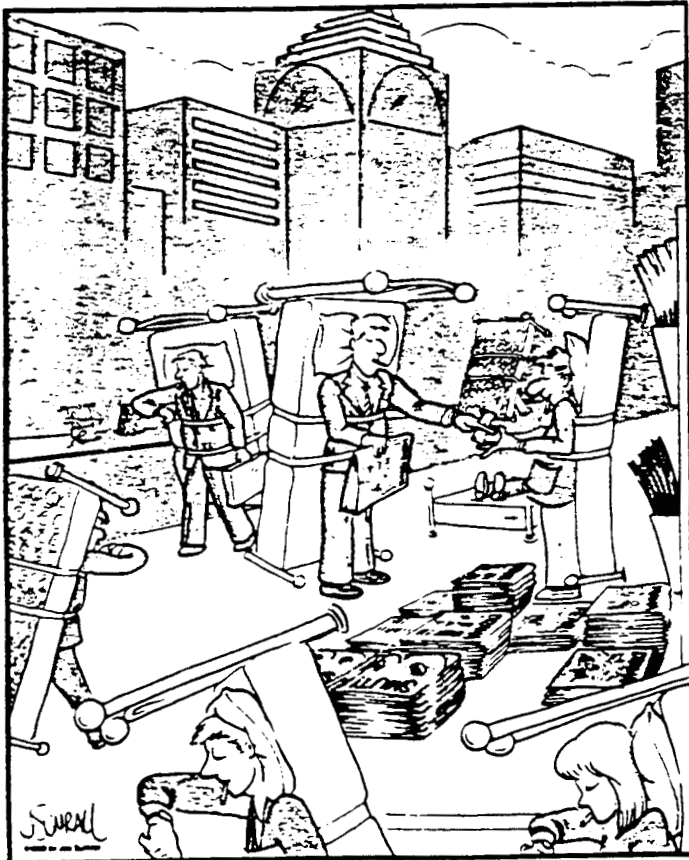

Social Consciousness.

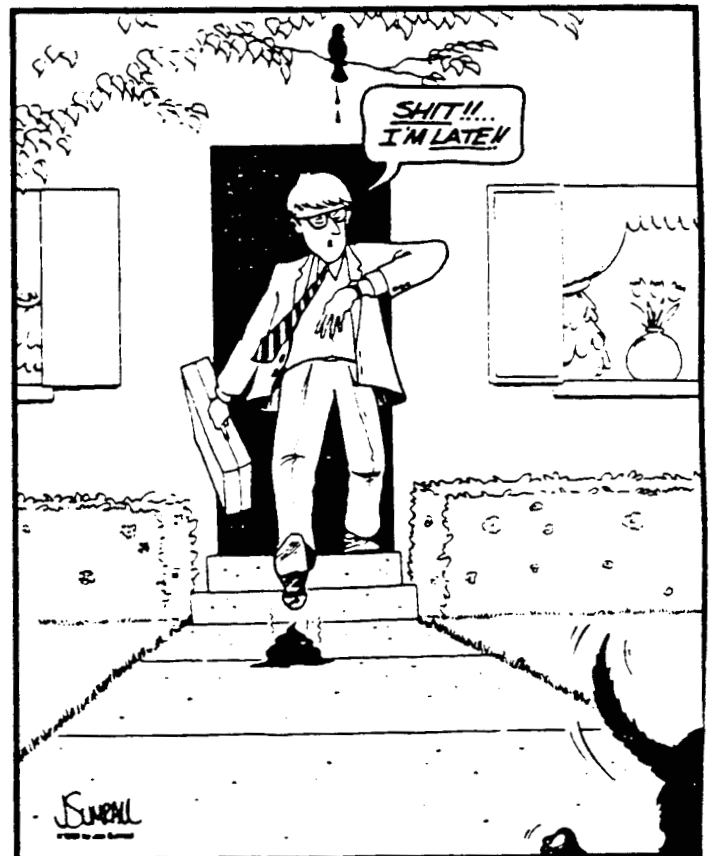

Your word is law.

# Government's right to punish wrongdoers is given by God

2-8-92  
Sometimes it is debated, even in religious circles, whether the State has the right to impose capital punishment. This always amazes me. As someone thoroughly familiar with the Scriptures, I know that this is clearly and consistently taught there. For example:

Genesis 9:6 - "Whoever sheds the blood of men, by man shall his blood be shed."

Numbers 35:16 - "The murderer shall be put to death" (repeated six times in six verses).

Lest anyone should think the New Testament has any other attitude, note the following:

Matthew 26:52 - Jesus said, "All who take the sword will perish by the sword."

Romans 13:4 - "If you do wrong, be afraid, for the ruler does not bear the sword in vain; he is the servant of God to execute His wrath on the wrongdoer."

Revelations 13:10 - "If anyone slays with the sword, with the

sword he must be slain."

In summary, according to the Scriptures, the murderer should be put to death. Government has been established by God (thus, is God's servant) to execute His wrath on the wrongdoer. (It has other duties, of course.)

Clearly, the government does not HAVE to exercise capital punishment but it has the right. In a democracy, this is decided by the voter. But no voter who accepts the authority of the Scriptures can argue that the State cannot do this; that it is itself vengeful, or that it



Pastor's Perspective

2-8-92

thus teaches violence.

"Vengeance is mine. I will repay," says the Lord. So when the State executes a criminal - say by hanging, electric chair or injection - this should be seen as God's own action. He is working through the State, His servant. The next time someone challenges you on this issue, you might hold out to him or her the passages above. In my view, the Scripture ought to decide questions of this kind. Otherwise we are forever in a quagmire about what to do. And if there's anything that the government doesn't need more of, it is a quagmire!

The Rev \_\_\_\_\_ is the pastor of the \_\_\_\_\_

Pastor's Perspective is coordinated by Associated Ministries in conjunction with The Olympian. The views expressed are those of the author and are not necessarily endorsed by Associated Ministries or The Olympian.

*Take a look at the sample article above. After reading the preceding material, you can see how primitive the consciousness of the above person really is: firmly stuck in dualism and opposites, primitive belief systems, and projection of his higher self, abdicating personal responsibility for his own creations and reality-tunnels that are centered in only the first three structures of the brain. The viewpoints and consciousness expressed by this individual typify those of the average human being on the planet.*

*It is clear that the individual does not realize that he can recognize the essence of which he is a part only by being it; he does not realize what the concept of Christ-Consciousness really means; he doesn't even realize who is is. It is a classic case of dis-empowerment. However, once he escapes dualism and gains conscious awareness, the basic substrate of his growing awareness, which is positively oriented, might lead him to realize what is going on. Of course, he'll then be out of a job.*

# M A T R I X I I I

## Chapter 4

### PSYCHO-SOCIAL ASPECTS OF POPULATION (Level One)

#### Belief Systems and Perception

It is a major undertaking to effectively deal with a population that is essentially oblivious to the structure, both psychologically and socially, of the society in which they live. There are many different aspects of the society that need to be reviewed, so let us start with the concept of *belief*. The world power structure makes use of belief systems to manipulate the population.

What exactly is belief? The definition of belief that is given in Webster's Dictionary is:

1. The state of believing; conviction that certain things are true; faith, especially religious faith.
2. Trust or confidence, as in the belief in ability.
3. Acceptance of something as real.
4. Anything believed or accepted as true.
5. An opinion; expectation; judgment
6. Creed or doctrine.

In addition, the definition of the word believe reveals additional meanings:

1. To take as real or true.
2. To have confidence in the promise of another.
3. To suppose; to expect; to assume.

It does not take much thought to realize that *the concept of belief never reflects actual experience*. On the other hand, if something is in your experience, you have no need to "believe" in it. What does this really tell us? Is not the act of "believing" actually a process of convincing yourself of something you have yet to know and understand in your experience? If you experience, then you *know*.

The act of "belief" results in an individual becoming vulnerable, in their terms, to manipulation. There is a variance between the concept of belief and "knowing" that is based in experience.

Many of the concepts and ideas that form the basis for the society in which we live are based on "beliefs" that have been presented as "reality" and "common sense." If you actually experience something, then you have no need to "believe" it, it simply "is", because it is within your knowingness.

## M A T R I X I I I

Take a piece of paper and divide it in half with a line vertically. Label the left side "beliefs" and the right side "experience". Take some time and fill the left column with the beliefs you have about as many things as you can think of. Now, how many things in the left column appear in any form in the right column? Get the message? How much energy and focus are you devoting to things that are not in your experience?

The use of belief systems, which form "reality tunnels" for those using the belief systems, are the source of a great number of problems in our society - problems which, by their nature, always manifest themselves in dualistic ways of viewing experience. If you experience something, it simply "is". It could be defined "as" something by virtue of a belief system, but the experience itself does not contain any intrinsic aspect of anything other than itself. Two people could look at something in front of them and say that what they are looking at is "good", "bad", "ridiculous", "smelly", or any other descriptive word. Each of those people is projecting those "qualities" on what they are perceiving and equating their projection with the nature of the object itself. Their projections conform with the reality-tunnel that is built around the belief systems that they have - the belief systems that form a gridwork that everything they perceive is viewed through.

Let us hypothetically examine two individuals from American society. The first person is a factory worker who could be described as a hard-working Irishman who has a family of four. The second person is an African American who works as an executive in an insurance company and has two children. He is married to a Caucasian woman who comes from a large family with a domineering manipulative mother.

What kind of a reality tunnel might each of these people have? Let's see. The first individual might have these beliefs which form his reality-tunnel through which he views the external environment:

1. The "ethic" of a hard days work for a day's pay.
2. Beliefs of the Roman Catholic Church
3. Against abortion and "pro-life"
4. The "democratic way"
5. A little alcohol helps the digestion
6. All "blacks" are "inferior"

The second individual might have these beliefs:

1. All "whites" are inferior
2. Beliefs of a Protestant Religion
3. For abortion and "pro-choice"
4. The "republican way"



## M A T R I X I I I

5. Against the use of alcohol
6. Believes that "the end justifies the means."

Are these two individuals likely to "agree" on anything from their respective reality tunnels? Not likely. Each of them is viewing the world around them through a "gridwork" which is comprised of "beliefs", their beliefs, the beliefs of their parents, the beliefs of their religion, the beliefs of their political parties, etc.

Suppose each of these people switched places and each was born to the parents of the other. Each of them would take on the "beliefs" and reality-tunnel of the other. You can see that belief systems and the "gridwork" which is composed of them is *independent of the individual entity*, and therefore an "artificial construction" composed of a series of dualities which can never be "resolved", since within each reality-tunnel, each of them is "correct and true". Each person can view the "same thing" and come up with different results in their perception. Therefore, the object viewed has no meaning except that which the perceiver gives it.

How does a child view the external environment before the belief systems are imposed? It views them "as it is", without beliefs or judgment.

### The Is-ness Aspect

Because individuals equate the "gridwork" interpretation of their exterior reality with the reality itself, it creates problems. What something "is" is equated with what it "appears to be" by virtue of the "gridwork" of programming, and does not take into account the idea of existence without judgment and belief systems. Obviously, things and events exist in a way that is independent of all this.

Because of this apparent problem in perception, some people have proposed a solution. This happened in 1933 when Alfred Korzybski made the proposition that "is of identity" (taking the form of "X is a Y") be removed from use within language. Examples of this are "the universe is a giant machine", "Joe is a Communist", "Mary is a dumb file-clerk".

In 1949, David Bourland proposed the abolition of all forms of the words "is" or "to be" and proposed the use of operational phrases that talk about what actually happened in space-time. The weakness of Aristotelian "isness" or "whatness" statements lies in their assumption of indwelling "thingness". An example would be when a doctor tells us that opium makes us sleepy because it has a "sleep-producing property in it". By contrast, a operational statement would

## M A T R I X I I I

define precisely how the structure of the opium molecule chemically bonds to specific receptor structures in the brain. In simpler terms, the Aristotelian universe assumes an assembly of "things" with "thingness" inside them, where the other approach assumes a network of structural relationships. The example of the doctor does not seem nearly as comical as the theology promulgated by the Vatican, which says that "things" not only have indwelling "thingness" but also have external appearances. This "explains" the Miracle of the Transubstantiation in which a piece of bread changes into the body of a man who lived 2,000 years ago. In other words, the "thingness" of the bread "is" Jesus Christ.

Since the brain does not receive raw data, but edits data as it receives it, we need to understand the software the brain uses. The use of the word "IS" sets the brain into a medieval framework that makes it difficult, if not impossible, to understand modern problems. This might serve to explain the human tendencies which contribute to most of the hostility on this planet, notwithstanding other external influences.

Apologists for certain authoritarian/dogmatic groups, examples of which might be the Vatican, the State Department, and the Politburo, spend most of their time constructing "proofs" that anybody who does not share their reality tunnel has serious mental or moral defects or "is" a liar. *One of the main functions within our government is to sociologically preserve and encourage this mode of perception in order to continue the practice of dividing the population against itself, limiting human progress and evolution. All aspects of the society, through the media, are geared to perform the task of constant reinforcement of this mode of perception.*

### The Concept of Premature Certainty

"The UFO Verdict" by Robert Schaeffer contains the premature certainty implied by the title. Mr. Schaeffer knows what UFOS "really are" -- they "really are" hoaxes and hallucinations. Most areas of investigation related to UFOs and aliens appear to contain similar lines of thought. Books with titles like "Abductions- The Mystery Solved" and titles with a similar line of logic seem to be based on premature certainty, speculation, and just plain lack of sufficient knowledge and research.

People generally tend to ignore the quantum "maybe" because traditional politics and religion have conditioned and trained people to act with intolerance and premature certainty. So many UFOs go past so quickly that they never graduate from the "maybe" state to the "identified" state. However, there is a vast amount of data that has been gleaned from events that have not gone by quickly.

## M A T R I X I I I

Understanding these principles can decrease dogma, intolerance, compulsive behavior, and hostility and may increase openness, continuous learning, growth and empathy.

### A Different Look at Multiple Personalities

The Russian mystic Gurdjieff claimed that people contain multiple personalities. The "I" who toils at a job does not seem the same "I" that gets angry for no evident reason or the "I" that makes love with joy and passion. Every person lives in a different holistic tunnel reality. All of these separate personalities also live in a different tunnel reality within that holistic tunnel reality.

Electroencephalograms seem to indicate that there are distinct brain wave patterns for each "personality". These separate "personalities" have been defined as "state specific information systems". Not only do people show different personalities when drunk and sober, for example, but there are different information banks (or memories) in these states. Emotional states seem part of a circular-casual loop with brain chemistry. The separate "personalities" or information systems within a typical human seem to fall into four main groups, with four additional groups appearing in a minority of individuals who have engaged in one form or another of neurological self-research or metaprogramming. These groups can be viewed in terms of the consciousness and behavior of people when functioning through different areas in the brain which correspond to the different neurological circuits covered in Chapter 3, which covered seven brain circuits. The eighth circuit, as it were, could be looked at as functioning in pure consciousness without any "gridwork" composed of habits and beliefs.

### The Triple Play: Security, Sensation and Power

These three elements reflect the first three or four areas of the brain through which awareness is focussed, and these elements are the mainstay of the cultural deception thrust on entities using a physical organism for interaction on a third density frequency.

*Security:* Relates primarily to the first two and secondarily to the third structure area in the human brain. Relate to food, shelter and proximity of friendly individuals.

*Sensation:* Relates to all the brain areas but concentrates on amplification of the physical senses and identification of the physical senses as the only information source of consciousness.

## M A T R I X I I I

**Power:** Relates primarily to focus on the first two brain areas and secondarily to the third. The drive for power is the primary to conquest, the New World Order, and all sociological factors of any species which manifest in the absence of true knowledge of identity and self.

### Psycho-Social Results of Addictions to Security, Sensation and Power

Addiction to all three modes results in constant driving compulsiveness and fear of loss. In addition, each of these modes manifests the following additional effects:

**Security:** The focus of conscious attention is on the "past" or the "future", which yields unlimited "possibilities" to "worry about".

**Sensation:** Repeated enjoyment of a specific sensation produces "boredom". Individuals are culturally conditioned to interact with people and events in terms of "past" experience, instead of experiencing people and events "as they are". In addition, individuals are culturally conditioned to "react" to everything.

**Power:** Humans are culturally conditioned to maintain a condition of being "caught up" in "defending" themselves and maintaining "control" over others.

### Projection and Responsibility

Humans are culturally conditioned to use various "ego-defense mechanisms". One of the most used mechanisms is that of projection. There are many examples that we could give that illustrate how this is used, leading to the disempowerment of the individual. The use of projection is one of the primary psychological disorders in human society.

### Perspectives in Projection

(1) From a Social Consciousness Viewpoint:

"When I went to the store, Joe said .... and made me mad."

(2) From a viewpoint of more consciousness:

"When I went to the store, Joe said .... and I upset myself because I reacted to what he said in a certain way. Not wanting to admit that it was my reaction, I projected the responsibility for that reaction on Joe and said earlier that "he" "made me mad", when in fact I am responsible for my own anger."

## M A T R I X I I I

(3) From a viewpoint of even more consciousness:

"When I went to the store, Joe said . . . ., which did not disturb me in any way, because I understand Joe's state of consciousness, and I am not viewing Joe based on past habitual thought patterns and expectations, but viewing him as he is, a loving being who is in the process of growing in awareness. I recognize that nothing has any meaning except what meaning I give it, and I accept Joe the way he is, without judgment." *IF YOU FEEL THAT SOMETHING "AFFECTS" YOU, IT IS A PROJECTION.*

Notice that the growing awareness in the above examples is resulting in the individual becoming more conscious. Go to a grade school sometime and see the social results of projection and how much disarray it causes. With projection of meaning also comes projection of responsibility for the state of one's consciousness, which results in a state of social disempowerment. What state are you choosing to operate in? What would society be like if people "grew up" in consciousness? Would there be less division between people? Of course. Would the medical and psychological services in the society reap less profit? Of course. There is no profit in mental health, much less physical health.

Add the other ego/image psychological defense mechanisms to the list, and you have quite a repertoire, a repertoire that is understood by the medical and psychological profession, yet various means of encouraging cultural growth in consciousness are deliberately avoided. Understanding and dealing with projection and other psychological factors is discussed later on in the book.

### Projection Encouraged By the Media

An interesting example of projection can be seen in a commercial for Nu-Skin skin creme, in which it is said: "Ten years ago you didn't worry about the impact of the environment on your skin (referring to sunlight and ultraviolet). Now you're more sensitive." This suggests to the viewer that it is not really the environment that is changing through neglect; it is "really" the consumer who is changing. Similar lines of "logic" are pervasive in commercial advertising and all media material released for public consumption.

### The Biosocial Filter of Consciousness

The effect of society is not only to funnel fictions into our consciousness, but also to prevent the awareness of reality. Every society, by its own practice of living and by the mode of relatedness, of feeling, and perceiving, develops

## M A T R I X I I I

a system of categories which determines the forms of awareness present in the society. This system works, as it were, like a socially conditioned filter; experience cannot enter awareness unless it can penetrate this filter. Experiences which can not be filtered through remain outside of awareness - they remain essentially "unconscious". The bio-social filter is made up of the influences and behavior patterns concerned with language, ethics, taboos, logic, rules, etc.

### DUALISMS WITHIN SOCIETY

I. The First Dualism: The first dualism which occurs is relative to the passage of consciousness into the third density. Mind, being pure consciousness, is never conscious of itself, and so is unconscious; it is unconscious in two similar yet slightly different senses: unconscious because we are culturally conditioned to be ignorant of its "existence," and unconscious because we cannot know it dualistically - we can only know Mind by *being* it, and in no other way. The very root "layer" of the unconscious is the universe itself. Since society operates outside of Reality (which is non-dualistic), the Mind cannot be made conscious when consciousness is in a dualistic mode. The first dualism severs the unity of subject and object, of self and other, of organism and environment. Most people are unaware that what we are is Mind. The experience of Mind-only is always present - it is in truth the only experience ever-present; due to the first dualism, it is repressed, ignored, and forgotten. The self vs. other aspect of the first dualism assists the generation of the Ego.

II. The Second Dualism: The second dualism appears to be the flip-side of the first. It severs the unity of "life" and "death", "past" and "future", and hence propels man into a life of *time*, thereby obscuring and rendering unconscious the awareness of the present moment, the NOW. The first and second dualisms mark the repression of organismic consciousness, which by its nature participates fully in Absolute Subjectivity, as it were, by virtue of the fact that its operations are spaceless and timeless. There is nothing in sensory awareness that corresponds to space or time. You cannot hear the past or future, nor smell the difference between inside and outside. Boundaries between inside and outside and past and future are symbolic conventions.

III. The Third Dualism: The third dualism, which consists mainly of the bio-social filter, is a derivative of the first two dualisms, in the sense that culture molds and is molded by the tenet of self vs. other (the first dualism), and in the sense that culture is what man does with death (the second dualism). The third dualism acts, as we have said before, as a major filter of Reality, and is the final generator of the perception of body-consciousness.

## M A T R I X I I I

### Behavior Modification Through Educational Systems

Public Law 92-318, Section 432 expressly forbids the federal government from establishing or developing curriculum for schools. In addition, Public Law 96-88, Title I, Section 101, No.3 states: "The primary responsibility for a child's education belongs to the parents." To presume to remediate children's beliefs and values without parents' knowledge or consent, using materials that bypass parental and community approval, can arguably be called a usurping of parental rights. In 1970 Congress placed an amendment in the General Education Provisions Act to specifically include, again, a "Prohibition Against Federal Control of Education." This prohibits the government from exercising "direction, supervision, or control over the curriculum, program of instruction administration or personnel of any educational institution, school, or school system, or over the selection of library resources, textbooks, or other printed or published instructional materials by any educational institution or school system." The Education Amendments of 1976 extend provisions forbidding federal control of education programs in the Education division of the Department of Health, Education and Welfare (HEW). This was back when the Office of Education was a part of HEW, before the U.S. Department of Education became a cabinet-level agency.

Despite all this legislation, there is evidence that it is being actively circumvented in a blatant attempt to modify the thoughts and feelings of children according to parameters set by the Carnegie Foundation, a Rockefeller-based institution .

Specifically, there is evidence that:

1. There has been storage on a national basis of cross-referenced personal information in non-secure data banks in such a way as to pose a threat to national and individual security and to violate the Fourth Amendment.
2. There has been unauthorized cross-use of official records.
3. There has been use of the social security number in a manner inconsistent with Section 7 of the Privacy Act of 1974.
4. There has been use of taxpayer's money to amass personal data accessible as psychological profiles, on children and their families, through the use of mandated school assessment tests, fraudulently passed off as academic achievement tests.
5. The U.S. Department of Education has been used as a pawn of the Carnegie Foundation, who seeks to redefine the social and

## M A T R I X I I I

economic framework of the country; government agencies have been placed in the position of conspiring to overthrow the U.S. Constitution.

6.A legalized private education system has been created and mislabeled as "public schooling".

7.Therapeutic programs have been created and placed in some schools that use unlicensed medical practitioners to conduct behavioral modification programs which attempt to change the feelings and attitudes of children, based on illegal psychological assessment tests that use multiple choice questions with answers that only include responses indicating "deviant" behavior. For example, the question and answers would be of the format: If you saw a friend throw a rock through a window, would you - (a) Throw a rock at the same time (b) Wait a few minutes, then through the rock (c) encourage others to do the same. It leaves no socially acceptable answer, such as not throwing the rock at all. There have been cases where children have committed suicide because of some of the activities that occur in schools.\*

8.Local educational institutions are routinely induced to accept federal money through subsidization in order to mandate federal programs that have ulterior motives and routinely use deception for private corporate gain.

Admittedly, these are pretty strong charges. Where is the proof that this is happening? Research indicates that the Carnegie Foundation owns the Educational Testing Service (ETS), which makes a yearly profit in the millions. The ETS disseminates the Scholastic Aptitude Test (SAT) taken by every high school student, the National Teachers Examination (NTE) taken by all teachers, and conducts Educational Quality Assessment (EQA) tests under the auspices of the National Assessment of Educational Progress (NAEP). Carnegie also established the Educational Commission of the States (ECS). It is a Rockefeller-funded institution.

What does all this mean? There is a tendency in the U.S. for individuals or groups to perform actions "in the public interest" without the knowledge or consent of the public. The efforts being put forth under the "educational" system in the U.S. fall in this category. Children entering school today are the first recipients of birth-to-death computerized dossiers built around a social security number (SSN). Included in their files are probable political leanings, personal hangups, and family financial and personal background data - all couched in terms of "demographic research" and "academic testing". Schools have been set up as "clinics" where youthful opinions are analyzed for "defects", documented, and sent to computer banks which comprise the Elementary and Secondary Integrated Data System, which was brought online in 1988. Whatever faction is control of American politics or any group with



## M A T R I X I I I

enough money and influence can use this data to manipulate even the most "democratic" of political systems and use the technology to establish top-down control and coercive regulatory bodies, and in the end implement its own agenda. This is what is happening in the American educational system.

The Tax Reform Act of 1976 permits state and local governments to use the Social Security number in administering their tax, drivers license, motor vehicle registration, and welfare payment programs, but no legal basis exists for using it to collect other data, much less to monitor the private domain of individuals. The CIA, of course, is exempt from the Act.

\* There is one book that documents much of this. It is called "Educating for the New World Order" by B.K. Eakman. It was published in 1991 by Halcyon House in Portland, Oregon. The ISBN number is 0-89420-278-2. It documents the incredible story of how one Pennsylvania woman stood the whole education establishment on its head and forced a cabinet-level government agency to obey the law. It discusses irregularities in the educational system dating back as far as 1965. The woman, Anita Hoge, won her case, but the system itself did not change. If you have children in public schools, you need to read this book!

### Culturally Conditioned Human "Learning"

A more basic issue underlies what is happening in the educational system, and that issue is the process of learning itself. Learning appears to be defined in cultural institutions as a process of gathering information, rote memorization and repetition - but is that really learning, or just enculturation? Individuals are sent to school to "learn" things that are known. Is not true learning part of experience? Doesn't that mean experiencing something that is not known? Experience is truly the heart of all knowledge, and it would appear that the context in which human "learning" takes place lacks the element of experience. To what extent does experience matter?

Many human learning systems deal with philosophical approaches to theoretical issues, with knowledge amounting to "re-experiencing" what is already known. This approach results in a more or less intellectual framework which is sterile in nature. Can you imagine "learning" to drive by reading a book about driving? Don't you really learn by actually undergoing the experience of driving? The experience of driving results in the acquisition of wisdom relative to the experience. What is acquired through ones own individual experience, as wisdom, cannot be taught. From the wisdom is derived one's own truth relative to the experience. Thus, human systems of education cannot truly endow individuals with meaningful experience; it

## M A T R I X I I I

is a factor which is subconsciously and innately perceived by today's school children, which is probably the reason why there is a waning interest in education and why school is a "hollow experience" - it leads to immense frustration and behavioral difficulties which are approached in society in a "treat the symptoms and not the causes" way, for if the causes were truly addressed, the whole system would have to be consciously changed. It will change, but only through disintegration.

### PSYCHO-SOCIAL ASPECTS OF POPULATION (Level Two)

Research seems to indicate that a small percentage of humans have never been through an experience on Earth before their present existence. Some may have had physical life experience in other dimensions of existence as entities that are, by Earth standards, alien. Some individuals who are experiencing a physical existence on Earth have never been in a physical form of any kind before. The quaternary factors of Mass, Energy, Space and Time as applied to existence on Earth make for a unique experience. Human life has many attractions that are inherently compelling. For some people, it may be like attending a huge "amusement park" where previous "rules" that applied to a non-physical existence are temporarily suspended. Some appear to desire human existence simply out of curiosity, and want to find out what it means to be a part of human existence. Each point in human evolution provides a unique opportunity for growth. Some entities find that the implicit limitations imposed by "physical incarceration" as a human also concentrate certain types of energy only available in that state. Perhaps the greatest motivation for participation in the human drama is to achieve the growth that comes with that participation. It is an intense learning process that forces the mixture of two aspects of modulated energy as male and female. Part of the adventure, no doubt, is to force the melding of these aspects within consciousness.

The conditions of entering human life, from this perspective, are harsh. The entity, as an energy form, must agree that the concepts of space and time exist and will be experienced as limitations to overcome through growth in consciousness. Without this primary agreement, experience in third density is not possible.

Part of this experience appears to be the "screening" of other experience (perceived in a linear fashion, because of neurological and psychological factors, as "past" experience) to assure a minimum of overt interference in developing awareness at the level of conscious perception. The consciousness of other experience, however, is retained within the essence of the lifeform experiencing human existence; it is present in the areas that are, for a while, "unconscious".

## M A T R I X I I I

A lot of research has been done through the procedures of out-of-body travel that indicates that there are a great number of entities that wish to experience human existence on this planet - especially during this final period within this particular time-track, because of the aspects within this civilization (which is moving into fourth density) that promote resolution of polarities and increased levels of consciousness that may also resolve challenges relating to experience prior to physical birth. The time-track can be defined as the third density linear time span of the body, which is connected initially to the linear format at the geographical location in space-time where it came into existence. On it lie the sequential events relative to its specific existence during its life on this planet. The events in the time-track are recorded by the reactive mental gestalt (which we will discuss soon) every 1/25th second in the form of an "energy picture" containing all perceptions in the reactive mental gestalt. This "energy picture" can also be considered, from an expanded point of perception, as the physical universes impression on thought, specifically that aspect of thought which has a "time-tag" on it. These "energy pictures" can also exist independently, and can be seen as a collective gestalt of all physical perceptions, emotions and thought that is experienced. When the source exists in a time track, the collective perceptive gestalt is also tied to the time track occupied by the physical body. Apart from the reactive mental gestalt and the physical body, the occupying spiritual entity (as past of the Universal Intelligent Matrix) thinks without forming these energy pictures. It can act without experience and knows simply by being.

Entities normally move freely in non-physical existence from one "locus of focus" to another by desire/thought/emotion that is given "direction" by will, focused through consciousness. The situation is radically different when memory is blocked by neurological factors (and other factors to be discussed later) and the constraints of being in a body are realized. Much of early human existence is consumed by frustration during the effort to obtain control over the body; this, along with the focus of consciousness being progressively focussed through succeeding neurological structures in the brain as the physical organism develops, contributes to initial and often permanent restriction of the focus of consciousness on the body. Add the requirement for physical nourishment and the emotional habits that result from it, and you have an interesting situation. In addition, the perception is restricted through the physical senses. Thus, the process of focus of conscious awareness is turned to the dualities of pain and pleasure (through the reptilian area of the brain), flight and fight, etc. Attention is focused on the experienced events and then the experience is retained as a habitual form of memory aligned in a stimulus-response fashion. Emotion is an enhancer of the storage process for responses. A result of

## M A T R I X I I I

this process is that individuals cannot experience an event, in "time", for itself; they get caught up in the event and react according to habitual response patterns - patterns which must be un-learned if one wishes to develop non-dual conscious perception of events as they really exist. All events are in fact neutral in content and meaning. The individual gives an event meaning and projects that meaning on the event.

Learning also occurs during "unconscious" states as data and experience is accumulated on levels "outside" conscious awareness - levels that are fed during physical sleep, as well as those levels that retain a memory track of everything we experience. Culturally, individuals are conditioned to place little importance on events that are not remembered; it is not immediately recognized that it is these events which have a significant influence on activities and experience. When examined from an "external" point of view, automatic use of this learning process becomes visible. The practice of hypnosis illustrates this level of learning quite well, as it demonstrates the levels of consciousness that lie outside the usual focus and how they can interact with experience and the interpretation of experience.

Learning systems in cultural settings typically feature situations where fluctuating attention is cast on low-order repetitive tasks, such as rote memorizing, which denigrates much of the learning that could potentially occur. These methods of "learning" (more like conditioning) are held in high esteem in human existence; virtually all of revolves around the knowledge, understanding, control and application of physical matter and energy systems generated therein. This dominant yet artificial and limited system of learning operates entirely through input from five physical senses; it has the effect of eliminating the last vestiges of identity and self-cognition from the individual.

There is virtually nothing to guide human mentation in directions other than those directly related to time-space physical matter. All social institutions in human society, other than a small number of "schools of ancient wisdom", direct all thought processes reflectively back on human sociological "history", ignoring the Source essence from which all life arises.

As the entity moves through life in human form, many attachments are formed. The most powerful of these attachments are emotional attachments which relate solely to expression only in time-space reality structures. This results in a compulsive need to reenter and recycle "human experience" to "complete that which had been started". It might be mentioned at this point that this disappears with increased levels of consciousness, but other manifestations of this compulsive need for a body are discussed in Level Three.

## M A T R I X I I I

There are two factors which contribute to such addictions to human time-space dramas. The first factor is a functional distortion of the survival drive into the elements of body protection and maintenance, as well as sexuality and reproduction. Body protection and maintenance relates to the drive for the acquisition of food and water, followed by the drive to maintain a suitable body temperature, the need to keep the body safe from predation (all the way from being eaten to the assault from biological organisms). Most of these "needs" are handled by lower neurological brain structures; conflict between needs of this nature results in activation of flight-or-fight circuitry in lower brain structures. All these factors tie in with the three culturally conditioned ego goals of security, sensation and power.

Sexuality and reproduction is the most prevalent aspect of the survival drive imprint and is subject to more major distortions than any other. The greatest among these is the illusion that, as a creative act, it engenders the emotion of love. The results are attachments and commitments that are both irrational and restrictive, which not only distort current physical goals but continue beyond - illusory burdens of guilt, obligations and related memory patterns that persist as behavioral modifiers even after physical death. The original motivating drive to reproduce has become secondary to the sensory peak of the act itself. In addition, there is evidence that human genetics may have been altered to provide the propensity for behavioral patterns in this direction.

The second factor which contributes to addictions to the space-time human drama is the diffusion of the primal energy of the creative force. Humans typically are embedded in emotional responses to internal and external stimuli. The result is a chaotic mixture of unchecked and misdirected energy - a mixture that is culturally conditioned to express the "good" and repress the "evil". Decisions are made in blind anger and the results of the decisions are resented. Much of the problems in human emotional expression result from the lack of the ability to live in the moment and the element of projection. We laugh in joy and become depressed when the moment fades. We think we "love" and experience a "broken heart" when we discover otherwise. Humans emotions that are based in distortions of consciousness have a wide range; greed, guilt, worry, nostalgia, hope, loneliness, and the quest for happiness are included.

By far the largest accumulated load is the emotional mass loosely held as the human ego. Originally a primal output from the survival imprint, it generates large numbers of emotional patterns which need constant reinforcement to maintain their existence; the drive for reinforcement consumes a tremendous amount of psychic energy. The ego exploits the concept that it is "needed" in order for the individual to "exist" and "achieve", that the emotion of "confidence" cannot exist with-

## M A T R I X I I I

out ego support, and that "happiness" is a satisfied ego; the ego brings forth a torrent of emotionally irrational reasons to justify its existence - sidestepping the fact that emotion and irrationality are not synonymous. The heavy preponderance of emotions are directly related or attached to time-space physical matter earth events, things, and relationships.

Because consciousness, of which you are a part, is not dependent on space-time for its existence, it is inevitable that many patterns are retained when entities are no longer in this dimension. Many of the patterns result in areas of resonance where entities of similar patterns congregate after physical death on a temporary basis. Ideally, an individual who was more conscious of his identity as part of the Universal Intelligent Matrix and also conscious of his habitual patterns would by-pass these lower areas that are resonant with less aware entities and move to areas in resonance which are, by nature, not restrictive or self-limiting. It is helpful, then, to address many of these issues while in this dimension in order to hasten progress once the dimensional barrier is passed upon physical death.

One of the activities that will contribute to quicker passage through these lower vibrational levels is to recognize that survival-based sexual ties must be addressed. Emotional attachments to individuals are based in time-space realities, and do not apply functionally outside the constraints of these limitations. No "male" or "female" owes the other an obligation to have sex - a survival-based activity. What is experienced in the third density through sexual union is a function of the psychological drive toward wholeness, which is motivated by the dualistic fragmentation of the psychic whole by genetic and cultural influences. Once it is recognized for what it truly is, the patterns lose their repeatability and will be released as behavioral conditioners.

Physical objects, as well as individual people, occur within space-time formats - objects and people cannot be owned or possessed by anyone, except within a self-imposed mental structure. Even the physical body which is essentially a garment for the spiritual entity is "borrowed".

There is much discussion about the concept of free will; within a space-time format, the physical nature of the human body is that it contains genetic programming in the form of behavioral and emotional patterns that have been locked into the DNA structure which is derived from every physical body that has ever contributed DNA to the physical body that is occupied. These emotional patterns place constraints on the activity and consciousness of the entity using the body while the consciousness of the entity is indistinguishable from body consciousness. What remains is culturally viewed as "free will"; the "free will" can be coerced. Body-consciousness is composed mostly of genetic programming; environmental and

## M A T R I X I I I

cultural programming make up the balance. Body consciousness is almost entirely a chemically-based consciousness. It is the basic consciousness of what has been referred to as the genetic entity, the consciousness of the body itself. It is not until the focus on body-consciousness is broken that the occupying entity can progress in consciousness and increase perception of surrounding reality structures.

### PSYCHO-SOCIAL ASPECTS OF POPULATION (Level Three)

On still a higher level of examination, let us return to the genetic programming which exists on a cellular level within the human being and examine some of the areas of interest that relate to this issue. In the human arena, the factors of mass, energy, space and time play an important part. Humans exist as composite entities, if you will, because you have a physical body (a bio-chemical electronic structure made of mass which exists in a time-track, occupying space) which has its own consciousness that is made up of a holographic gestalt of cellular consciousness ultimately based on DNA structures inherited from previous generations. The gestalt consciousness of the body can be called the genetic entity. It appears to have the highest density in the middle of the upper torso of the physical body, which can be seen as a container or vessel for the being which manipulates it. As mentioned before, any event which is experienced by a human being with an emotional component is recorded on quantum levels within the genetic structure on a cellular level - in truth, experience is recorded, along with emotional patterns associated with that experience. Mental pictures are also recorded. Many times, experiences may include periods of physical pain or periods of unconsciousness associated with physical injury or emotional trauma. These memory traces are very often held at specific points on the time-track of the physiological structure in which they occur - these points can re-impress the memory and associated emotional patterns along harmonic increments of the time-track in which other physical bodies exist that are genetic descendants of the body originally impressed.

Within the total composite mental structure, there is an area which is based totally in stimulus-response, relating to several of the lower brain structures previously mentioned. It is this area where the composite genetic memory traces and associated emotional reactive patterns appear to be stored. It also appears to be the source of mental and emotional aberration and "psychosomatic" problems. This reactive mental area acts below the level of waking consciousness within most human beings, and also retains event traces that occur during periods when the human is "unconscious". In actuality, it is an area in the mind, as it were, that is always conscious. It retains the memory of how many steps you took to the bathroom this morning. This reactive mind structure can exert influence on a sub-conscious basis on human actions, thoughts, and the

## M A T R I X I I I

consciousness of the genetic entity which controls the body.

At a deeper level, the genetic entity is itself a composite of all the cellular experience of all the individual bodies that have existed within the genetic line corresponding to the structural DNA patterns. The resulting manifestation of this composite, at any time during the genetic line, is in effect a singular consciousness that occupies and governs the operation of the physical body. When the consciousness of the genetic entity merges, by virtue of neurological structures, with that of the occupying entity through Fourier-based holographic interference patterns and wave structures, the psychological illusion (which is continuously supported by cultural means) is that the occupying entity is easily fooled into believing that it is, in fact, equivalent in identity with the genetic entity, thus relinquishing its own identity and assuming an identity centered around body consciousness. The genetic entity maintains a memory trace of all the death experiences of the entire line of host consciousness that has utilized that specific structure. The composite mental gestalt of the genetic entity has also been called the somatic mind.

The process known as hypnosis, in view of this knowledge, can now be viewed from a more accurate perspective. Hypnosis is usually seen as a process which is externally imposed on a human being that in fact reduces the conscious awareness of the occupying entity and magnifies the degree of consciousness of the genetic entity. It also has the unfortunate effect of keying in genetic memory traces and associated emotional and behavioral response patterns to externally applied stimuli.

The process of "self-hypnosis", conversely, is one where the occupying entity reduces the influence of the consciousness of the genetic entity, and is a way to set up or program a compulsive or inhibitive circuit within it.

Another mental structure that arises within the human is more analytical in nature and is more within conscious reach of the occupying spiritual entity. Normally referred to as the part of the mind which is conscious and aware, it is that mental structure which thinks, observes data, remembers, does problem resolution and combines perceptions (in time) to form conclusions based on the perceived reality of the situation; the gestalt of this mental structure results in accompanying visual imagery, which is presided over by the knowingness of the occupying spiritual entity. Notice that knowingness is being defined as a higher level of consciousness (which could be defined as "awareness of awareness" or the "I"), while the term "awareness" by itself applies to the analytical mental gestalt.

The individual consciousness of the occupying spiritual entity also has the capability of independent thought and experience of emotions, but it is immortal and does not



## M A T R I X I I I

require any structure at all to exist. It ultimately exists in and is derived from a Universal Intelligent Matrix which is beyond the spectrum of visible light (which humans, using dualistic anthropomorphic projection, refer to as "God").

Memory traces and accompanying emotional patterns that are inherent in the genetic entity, manifested through the reactive mental gestalt, can be restimulated into manifestation through external influence. External influence could manifest itself through an environmental factors or even, on a higher albeit technical level, through implant devices or patterns overlaid within the physical body or within the fields surrounding the physical body as higher density implant patterns engrained in the electronic interference ridges between auric bands. Research indicates substantial evidence that this is a commonly applied method of manipulation.

It is apparently uncommon for a genetic entity to host the same occupying spiritual component twice; this appears to reflect the overall tendency within the operative manifestation of the Universal Intelligent Matrix for maximization of experiential differentiation, allowing genetic structures a plethora of controlling host entities. In other words, you as the spiritual occupying entity in the specific body and genetic line you are in, have never lived before this lifetime.

The genetic entity apparently enters the protoplasm line some two days to a week prior to conception. Since the genetic entity appears to answer, in present time, in a dual manner when queried through muscle testing and other methods, it is suspected that the genetic entity is in fact a "double entity" where one "side" enters via the protoplasm in the sperm and the other "side" through the protoplasm in the ovum.

An interesting aspect of the combination of the genetic entity and a occupying spiritual entity is that there seems to be some evidence that both components of the composite human being carry facsimiles of the memory of each other, producing multiple facsimiles of "past" deaths for the same period of linear time. The existence of facsimiles in either the genetic entity or the occupying spiritual entity has a tendency to restimulate visuals which have their origin with former genetic entities or occupying spiritual entities.

A human being could be defined as a composite which consists of a physical body, existing in space and on a time-track which contains a genetic entity and is occupied by a spiritual entity who has amnesia about its true identity.

The genetic structure of the brain also limits perception to the confines of what perception the genetic line has had as experience. Thus, explorers sailing to primitive islands during the time of Magellan found that the natives could not

## M A T R I X I I I

even see their large sailboats lying there in the water, as no one within the genetic line of the people on the island had ever experienced it before. Gradually, the people began to be aware of them. Similarly, the genetic structure implied in some individuals permits them to see alien craft, while other people next to them can see nothing.

### OUTSIDE THE STRICTLY "HUMAN" EXPERIENCE (Level Four)

Further complicating the human situation, there are extra-terrestrial genetic entities that might have been used by occupying spiritual entities that have their own memory structures which may have no reference point when compared to Earth-bound memory tracks; conversely, occupying spiritual entities may originate extra-terrestrially and occupy a Earth bound genetic line.

Since these facsimiles, or perceptive memory gestalts, can exist independently, they can be accumulated by spiritual entities independently of physical body inter-relationships; they can be accumulated or discarded at will. However, the identity of a spiritual entity is not based on the memory of events but on an actual knowledge of identity. Entities are capable of removing chains of memory gestalts from other entities. Non-corporeal entities do not generally use these facsimiles as a basis for thought or action, but construct "mock-ups" of a situation, which is subsequently examined to extract potential information about how something works or what may be done about a particular situation - there is not a stimulus-response mode of activity.

### Multi-Density Electronic Manipulation

At this point, let's call an independent spiritual entity simply a Being. People generally seem to assume that because a Being is non-corporeal that there are no dualistic conflicts. There are conflicts through many density levels. There is consistent evidence coming out that electronics are used by Beings to manipulate other Beings; electronic energy flows can effect the overall density continuum in which a Being exists, making it visible or trapping it.

Generally speaking, Beings appear to have several possible relationships relative to assumption of physical bodies:

1. In relation to a physical body, a Being exists in a relational way as a intelligent field structure of varying density that interpenetrates the body in varying degrees.

- a. A Being can exist just outside the physical body in a situation where it is monitoring it via direct with the neurological structure by quantum-based

## M A T R I X I I I

fluctuating fields which have an effect on the motor controls on either side of the head.

- b. A Being can exist just outside the physical body within the auric bands, extending a significant part of itself within the consciousness of the body to the point where it loses its self-identity. In most cases, the position of the entity is behind and above the body. The typical human.
  - c. A case can exist where the entity is barely or hardly ever in contact with the body, seeing the body from a remote location, while convinced that it "is the body" but cannot do anything about it. This is typical of an initial out-of-body experience for a human.
2. A Being can operate exterior to a body without the need of a body, cleared of the compulsion to have a body, and can create or uncreate reactive or analytical mind gestalts at will.

Various studies over the past thirty years appear to indicate that Beings can fall under the influence of higher level manipulative programming imposed by other Beings. The character of this higher level programming appears to fall into three broad categories: Devices, Embedded Entities, and Directive Electronic Ridge Implants.

### Devices

The existence of various devices that are inserted into the physical body as implants is commonly known, and much of that information is generally discussed in Matrix II, with special emphasis on the rationale behind the practice. The research that has occurred since Matrix II was written seems to point to the existence of various devices that are attached to what are colloquially known as the etheric, emotional, astral and mental "bodies" (or field structures) which interpenetrate the body. It might be mentioned, in this context, that the human body (often referred to as a "container") is seen as an actual "ID tag" by some groups of manipulative entities, housing what amounts to a "captive amnesiac consciousness of another entity". What better way to conquer ones "enemies" than to electronically manipulate them, force them into physical bodies, induce amnesia, and program them with compulsions to remain in the cycle of physical incarnation? Sound far out? It is, and there is significant evidence to indicate that this practice is occurring, although one should be aware that no process is generally applicable to all Beings that utilize bodies, for one must make allowance

## M A T R I X I I I

for beings who voluntarily incarnate for their own purposes.

Hubbard did much research in these areas during his early years - research that was able to follow an entities track back more than 500 million years. Hubbard, a former Naval officer, was aware of what the Navy was doing in the early days of MKULTRA. He refused to submit to government demands that he join the mind control group, and instead published material which, under the title "Dianetics", actually proved to be antidotes to the MKULTRA mind control methods. As a result, Hubbard was hounded the rest of his life. Research done by Hubbard and others appears to indicate that certain high level manipulative practices (originating with negatively polarized groups from Orion) has been in use for a very very long time. Research conducted in Hawaii during 1991 and 1992 by an individual who wished to remain unnamed has corroborated much of Hubbards work. Devices have been identified which exist on various vibratory levels and new methods to deactivate them using higher order electromagnetic fields have been devised and tested successfully on abductees. Interaction with this researcher continues, and new developments will be reported in Leading Edge publications.

### Embedded Entities

Forms of human energy field manipulation exist which involve interaction with the interference "ridges" which exist as boundary layers between areas of varying density surrounding the physical body. There is growing evidence that these ridges can be programmed in conjunction with the existing genetic matrix present both in cellular material and in derivations of the formative morphic field which support and give rise to cellular form and integrity. The ridges, in this format, function as "pseudo-entities"; the ridges, as nodal structures formed by the coincidence and interaction of two or more energy flows, create an enduring energy state which is programmable, self-functioning, and responsive to ambient thought flows arising from the human energy field in which they are located. There are indications that programmed ridge structures have been the source, at times, for "voices", theta wave fronts, and other energy progressions that are ultimately designed to dissuade the individual from a specific thought pattern. In other words, when an individual generates specific thought patterns that are not desired, the ridge implant responds by generating a compensatory field pattern designed to suppress that pattern; since the net effect in human consciousness so closely approximates average fluctuation in thought pattern, the existence of the ridge implant as the source of the variance in thought process remains undetected. Ridges are also a substructure around which facsimilies can be built. The actual source of these implants is being researched. Effects can range from paralysis of areas of the physical body to various stimulus-response reactions relating to specific

## M A T R I X I I I

thought patterns of the individual. In other words, if an individual begins to have thought patterns which threaten programming structures, these implants kick in to divert mental activity to more basic areas - often areas which relate to physical survival. To some, all of this may sound like a science fiction plot or the ravings of someone with paranoid delusion...but, indications of all this exist, and it is simply being related to you in the most neutral way possible that data regarding this does exist.

### Directive Electronic Ridge Implants

One of the manipulative techniques which has been applied to Beings by other Beings during the last 500 million years is the heavy use of electronics or electrical current. Beings can be placed in an electronically generated field and rendered essentially "inoperative", the object being slavery, introduction of compulsive controls, and integration into incarnational cycles. The most recent application of these methods is seen in various races that have their origin in the Orion system - races which are negatively oriented, in that service-to-self is the objective.

In a way, the concept of a facsimile is best described as a "holographic insert", where a virtual reality structure is forced on a Being, who cannot distinguish it as a synthetic structure.

Some of these implanted facsimiles, as described, have devastating effects, and are created as inhibitory structures which limit the capability of humans and other incarnate beings which attempted to take control of an area occupied by beings in higher densities who are manipulative.

According to research, one of the earliest implanted structures was an outright control mechanism invented by the Orion group to cut down on raids on their installations. It produces a non-combative, religiously insane community of individuals. It was installed using electronic equipment which emits a push-pull electronic wave in a series of stuttering "baps". It is violently restimulated in some humans when they hear pneumatic drills. In the original version, the invaders operated these machines on Beings while wearing hoods and goggles. Over the years, the use of this implanted facsimile decreased in favor of another one, which we will call the "H" facsimile, which apparently achieves the same result much quicker. The "H" implant is rigged with religious symbology creating intense dualism and conflict, and issues from a gun-like device which shoots a black and white waveform, implanting dualistic religious symbolic structures which are restimulated when thought patterns begin to run counter to the desired state.

## M A T R I X I I I

Between-lives implants occur where the individual leaves the body upon physical death. Here, the individual "reports in", is given a strong memory-erasing implant, and is shot down into a body before it is born. The reporting area most often used is said to be Mars, although there are four areas on Earth protected by screens. The memory erasing procedure is quite interesting. The individual is seated before a wheel which contains images. As the wheel turns, the pictures appear to recede. The individual is moved from side to side, but a mirror arrangement shows him sitting still in front of the pictures. A force screen is projected at the individual through the pictures. The pictures dim out. The images are comprised of event facsimiles from the life the person just completed, and the effect is to give the person the impression that they have no past life. This type of incident can be restimulated with the passage of linear time to the point where, with physical aging, the individual starts to cycle through it automatically and goes into a "second childhood", which is to say that he anticipates the coming implant and conceives it to have been actually done. To have received this type of implant once is to get a restimulation on "dying" which will erase the memory of the life just completed. This implant is only effective if the individual identifies himself with body consciousness (as most humans do).

Another type of implant trap that has appeared in research is called "the boxer". The purpose of this is to reinforce stimulus-response conditioning. The Being would be hit from every angle with a device and would be forced to kick back, which would cause him to be struck again. At length he would be psychotic enough to return every motion he received. The result is the psychologists definition of a "well-adjusted human being" - one who is stimulated and responds without thought.

The purpose of all these implants is to force the Being into a state of forgetfulness, to rid the area of Beings who cannot be controlled, and to gain personnel for use as slave labor.

You can see, from all the material in this chapter, how disadvantageous it is to be "stuck" in a physical body and unaware of your real identity, essentially a slave to chemical consciousness of the body, and "stuck" in repetitive incarnational cycles where you can be manipulated from many different levels. Because the tendency is, in human society, to totally identify with the consciousness of the body, humans can easily be manipulated further by manipulating the environment that the body exists in. This is evidently encouraged and guided by non-human factors and implemented by controlled humans who are in control of the world power structure. The first area of examination is the chemical manipulation of the human population - the next chapter in our story.

# M A T R I X   I I I

## Chapter 5

### POPULATION MANAGEMENT THROUGH THE USE OF CHEMICAL AND METALLIC SUBSTANCES

#### The Use of Fluoride Compounds

Fluoride compounds have been in use for a long time, but not in the "prevention of tooth decay". The same fluorides that are used now "in the name of health" were for nearly 40 years used in insecticides and rodenticides because of its properties as a stomach poison. Fluorides are believed to exert their toxic action on pests by combining with and inhibiting many enzymes that contain elements such as iron, calcium and magnesium. For similar reasons, fluorides are toxic to plants, disrupting the delicate biochemical balance where photosynthesis takes place.

There are no reasons to suspect that humans are immune from the effects of this potent poison. Even a quick perusal of the indexes of most reference manuals on industrial toxicology list a section on the hazards of handling fluoride compounds. Doses of 25 to 50mg are regarded as "highly toxic" and can cause severe vomiting, diarrhea and central nervous system manifestations.

It is crucial to recognize from the outset that fluoride is a highly toxic substance. Appreciation of this simple point makes it easier to understand the natural reluctance on the part of some to accept without question the policy of compulsory ingestion of a poison to obtain what is alleged to be partial control of what would generally be regarded as a noncommunicable disease. The potent toxicity of fluoride and the narrow limits of human tolerance (between 1-5ppm) make the question of optimum concentration of paramount importance.

#### Environmental Pollution By Fluorides

The fluoridation controversy becomes even more interesting when we realize that industrial fluorine wastes have since the early 1900's been one of the main pollutants of lakes, streams and aquifers, causing untold losses to farmers in regard to the poisoning of stock and crops.

Fluorides such as hydrogen fluoride and silicon tetrafluoride are emitted by phosphate fertilizer manufacturing plants (phosphate rock can typically contain 3% fluoride). The industrial process of aluminum involves that electrolysis of alumina in a bath of molten cryolite

### M A T R I X   I I I

(sodium aluminum hexafluoride). It releases considerable quantities of fluorides into the environment. These fluorides are readily absorbed by vegetation and are known to cause substantial leaf injury. Even in concentrations as low as 0.1ppb (parts per billion), fluorides significantly reduce both the growth and yield of crops.

Livestock have also fallen victim to fluoride poisoning caused primarily by ingesting contaminated vegetation. It is reported that the Aluminum Corporation of America (ALCOA) is confronted by annual claims which amount to millions of dollars as compensation for the havoc wreaked by their fluorine wastes.

Large quantities of fluorides are also produced by giant chemical firms, such as Hooker Chemical. Hooker Chemical, famous for being the main contributor to the pollution in Love Canal, became part of the Rockefeller network when Blanchette Hooker married John D. Rockefeller III. Studies by the National Academy of Sciences show that US industries such as Hooker Chemical pump 100,000 tons of fluorides into the atmosphere each year and another 500,000 tons of fluorides into the nations water supply each year (this is in addition to the fluorides used to "treat" the water).

The studies by the National Academy detail the effects of fluorides on the human system. Its most dangerous effect is that it slows down the vitally important DNA repair enzyme activity of the *immune system*. Fluorides have this effect even in concentrations as low as 1ppm, the standard dosage which the US Public Health set for drinking water. At this concentration, fluorides are shown to cause serious chromosome damage. The 1ppm level of fluoride has been shown in laboratory experiments to transform normal cells into cancer cells.

American Academy of Science studies in 1963 showed that these "low" levels of fluorides resulted in a marked increase in melanotic tumors, from 12% to 100% in experimental animals. It also caused interference with the production of important neurotransmitters, and lowered their level in the brain. The same neurotransmitters have the vital function of protecting against seizures, thus opening the possibility of major increases in strokes and brain damage because of the fluorides in water. Lesser effects of fluorides which have been noted in laboratory tests are sudden mood changes, severe nausea, hallucinations, irregular breathing, night twitching, damage to fetuses, and various forms of cancer.

In his work "Fluoride: The Aging Factor", Dr. John Yiamouyiannis finds that from 30,000 to 50,000 deaths a year are directly traceable to fluoridation; 10,000 to



## M A T R I X   I I I

20,000 of those deaths are from fluoride induced cancers. It is interesting that this study has never been refuted.

The death rate among elderly people from kidney and heart disease began to rise steadily in the first cities to begin fluoridating their water. One critic believes this was a deliberate decision, the "final solution" to the problem of Social Security payments. The steady poisoning of our older generation continues.

### The Fluoride Gambit

It was in 1933 that the United States Public Health Service (USPHS) became particularly concerned about the poisoning effect of fluoride and its effect on teeth, and they determined that dental fluorosis (teeth mottled with yellow, brown or black stains) occurred among 25-30% of children when just over 1ppm of fluoride was present in drinking water.

In 1939 the Mellon Institute employed a scientist, Dr. Gerald Cox, to find a viable market for the industrial fluorine wastes associated with the production of aluminum. At a meeting of water engineers in 1939, Cox first put forward his idea to add fluoride to the public water supplies. By 1940, Cox had become a member of the Food and Nutrition Board of the National Research Council, and he prepared for them a series of submissions strongly promoting the idea of artificial water fluoridation as a means of reducing tooth decay. His recommendation was based on the following:

In a widely circulated report in 1941, a popular magazine reported the case of Dr. George Heard, a dentist in Deaf Smith County, Texas, who claimed that he had no business because of the natural fluoride in the water. Later, when Dr. Heard found mottled teeth too brittle to fill and a rushing business after supermarkets moved in with processed foods, he tried in vain to set the record straight. He could find no publisher for his new information. His original article was entitled "A Town Without a Toothache". Since the use of fluoride actually increases the profits of the dental industry, it is no wonder that the American Dental Association promotes the use of fluoride and fluoride toothpastes.

By 1942, the USPHS, largely under the direction of Dr. H. Trendley Dean, legislated that drinking water containing up to 1ppm of fluoride was acceptable. The USPHS was not at this point introducing the concept of water fluoridation - it was concerned mainly to define the maximum allowable limit beyond which fluoride

### M A T R I X   I I I

concentrations should be regarded as contaminating public water supplies. Dean's research investigations also indicated that although 1ppm fluoride concentration caused enamel fluorosis or mottling in up to 10% of the children, it also served to provide partial protection against dental decay.

Dean was also well aware that fluoride concentrations of as little as 2ppm could constitute a public health concern, causing severe dental fluorosis. Coincidentally, the USPHS was at the time sponsored under the Department of the Treasury, the chief officer of which was Andrew Mellon, owner of ALCOA. What better way to solve the problem of the disposal of the toxic waste from ALCOA than getting paid to put it into drinking water?

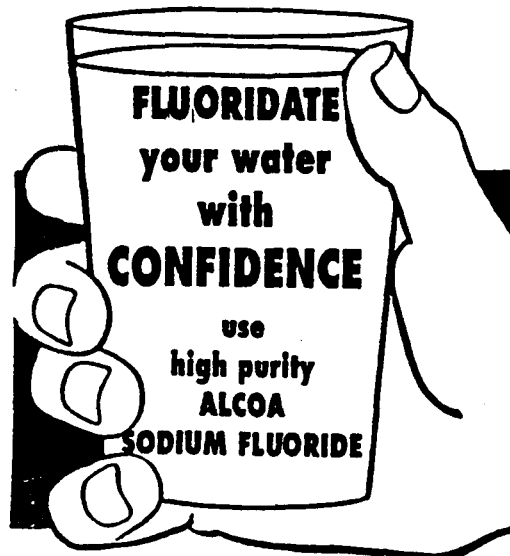

ALCOA ADVERTISEMENT-1950

In 1945, Grand Rapids, Michigan was selected as the site of the first major cumulative study of the effects of fluoridation on the public at large. Comparisons were to be made with the city of Muskegon which remained unfluoridated so that it could be used as a control. The experiment was supposed to occur over a ten-year period to determine any cumulative side-effects which might result from the fluoridation of municipal water. Before we go on, we must take a look at another player in this gambit by the name of Oscar Ewing - quite an interesting character.

The head of the USPHS during the entire fluoridation campaign was Oscar Ewing. A graduate of Harvard Law School, Ewing was an airplane contractor during the First World War. He then joined the influential law firm of Sherman, Hughes and Dwight, a prestigious Wall Street

### M A T R I X   I I I

company. The "Hughes" in the firm was Charles Evans Hughes, who was a candidate for the Presidency of the United States. Hughes later became Chief Justice of the Supreme Court. The firm was then called Ewing and Hughes.

At the end of World War II, Ewing had himself appointed a Special Prosecutor for the Department of Justice. He was also appointed chairman of the Democratic National Committee. In 1946, President Truman appointed him head of the Federal Security Agency, which encompassed the U.S. Public Health Service, the Social Security Administration and the Office of Education. He was paid a \$750,000 fee by Rockefeller interests to leave his law practice and assume this post. The purpose was to head the national fluoridation campaign. As head of the FSA, he was in charge of the vast government postwar spending programs in health, education and welfare. From this post, Ewing campaigned for greater government control over the citizens of the United States. Back to the Michigan test.

Although the Michigan fluoridation test was supposed to be done over a ten-year period, Ewing intervened after only five years and declared the success of the study in showing fluoridation to be safe. Ewing then encouraged its immediate adoption through the United States in June 1950.

In 1951, Ewing was able to convince the Congress that fluoridation was a necessity, and a total of \$2 million was immediately directed to promote the fluoridation program throughout the United States. Ewing's propaganda expert for the fluoridation effort was Edward Bernays, who in 1951 was featured in a book entitled "Public Relations: Edward Bernays and the American Scene". Bernays, a Vienna born nephew of Sigmund Freud, is documented in the book as having said, "the direct way to reach the heard is through the leaders. For, if the group they dominate will respond... all this must be planned...indoctrination must be subtle. It should be worked into the everyday life of the people - 24 hours a day in hundreds of ways...a redefinition of ethics is necessary...*the subject matter of the propaganda need not necessarily be true*", says Bernay.

It was hardly accidental that Washington, D.C., where Oscar Ewing was king, was one of the first large American cities to fluoridate its water supply. At the same time, Congressmen and other politicians in Washington were privately alerted that they should be careful about ingesting the fluoridated water. Supplies of bottled water from mountain springs then appeared in every office on Capitol Hill; these have been maintained continuously ever since, at the taxpayers expense.

## M A T R I X   I I I

### Use of Fluorides for Chemical Mind Control

Ewing and his minions were undoubtedly aware of Soviet studies showing that *fluorides were extremely important in introducing a docile, sheep-like obedience in the general population*. The Soviet Union maintained its concentration camps since 1940 by administering increasing dosages of fluorides to the prison population in its vast empire, the largest network of concentration camps in the world. It is no small coincidence that the totalitarian system in the United States enjoys just the same thought pattern, where all dissension and resistance is ended, and a slave population that has no voice in its own government.

The Soviets were not the only ones who used fluorides for keeping populations docile. The Germans in World War II experimented with and successfully used fluorides as a means of population control. They discovered that after one year of consumption of fluoride-laced water, something occurred in the brain which made people more docile and more easily managed. Production of fluorine water additive products was controlled by I.G.Farben during the Nazi regime.

### Use of Fluoride Compounds on Young Children

The earlier the fluorides are administered in a persons life, the quicker the cumulative effects will take hold. Now you can see why each year there are programs in schools to periodically dose children with fluorides. A popular product, called "Swish" is being used in schools in 1992. This product is formulated in Canada. The passivity and unwillingness to challenge any authority is the initial effect on the central nervous system. There are further effects upon the kidneys, a cumulative effect on the heart and other organs, as well as the widespread development of new and rapidly-spreading types of cancer that are associated with the use of fluorides. To hasten this objective, not only are American children being given fluoridated water; they are also told to brush their teeth three times a day with heavily fluoridated toothpaste which contains 7% sodium fluoride. Studies show that children habitually ingest about 10% of this solution during each brushing, giving them a daily dose of 30% of the 7% solution in the toothpaste.

The water in the area where this book is being written is derived from two wells and is checked each year. The level of fluoride in the last test was 0.2 mg/liter, which translates to 0.2ppm (1mg/l = 1ppm). It is reasonable to assume that because fluorides are not added locally (they

# Individual Fluoride Mouthrinse Pouches

## Instructions for Teachers

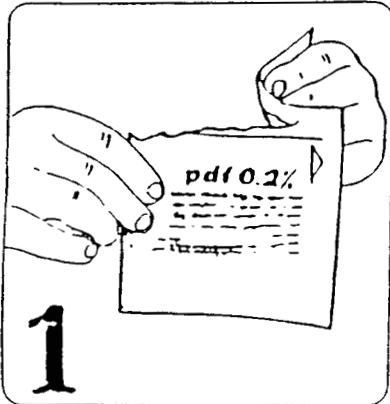

Rip packet (at notch) across the top (holding packet upright).  
Or, cut with safety scissors.

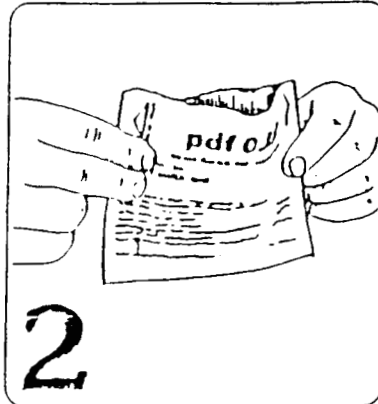

Press packet open into "V" (holding upright)



Empty packet into mouth and swish vigorously for 1 minute.



Empty rinse back into packet.

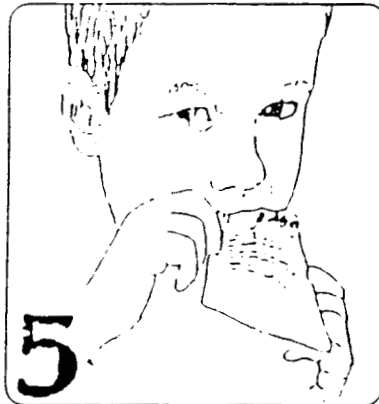

Wipe lip with inside edge of packet.

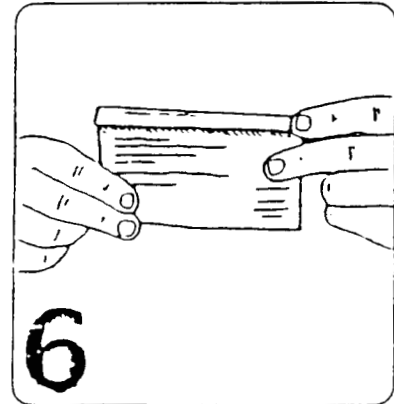

Fold over packet twice, and dispose.

**pdf 0.2%**

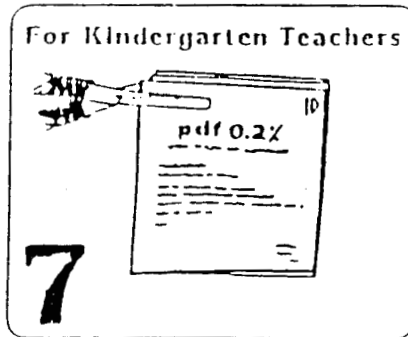

Hold packet upright and cut across top with scissors.

**pdf 0.2%**

B.M.G. PHARMACEUTICAL PRODUCTS INC.

RX pdf \* 0.2%, HDC: 52135-\*555 Dental Rinse of Sodium Fluoride.

**DESCRIPTION:** 0.2% sodium fluoride (NaF) in a flavored or flavorless, neutral aqueous solution. For weekly use as a caries preventive in children and to treat dental cervical hypersensitivity. **CLINICAL PHARMACOLOGY:** Topical application of sodium fluoride increases tooth resistance to acid dissolution, promotes remineralization, and, inhibits the cariogenic microbial process. When topical fluoride is applied to hypersensitive exposed dentine, it results in the formation of insoluble materials within the dentinal tubules and this, in turn, is believed to block the transmission of offending stimuli. **INDICATIONS AND USAGE:** It has been established that weekly rinsing with neutral 0.2% sodium fluoride solution protects against dental caries in children. PDF \* 0.2% Weekly Dental Rinse is ready-to-use, flavored or flavorless preparation for convenient administrations.

**CONTRAINDICATIONS:** None. (May be used whether drinking water is fluoridated or not, since topical cannot produce fluorosis.)

**WARNING:** DO NOT SWALLOW, DO NOT USE (5ml or 10ml) IN CHILDREN UNDER AGE 5 SINCE YOUNGER CHILDREN FREQUENTLY CANNOT PERFORM THE RINSE PROCESS WITHOUT SIGNIFICANT SWALLOWING. DO NOT USE (10ml) IN CHILDREN UNDER AGE 5.

As in the case of all medications, KEEP OUT OF REACH OF CHILDREN.

**PRECAUTION:** Not for systemic use.

**OVERDOSAGE:** In the event a dose is accidentally swallowed, nausea and/or vomiting may result. (TREAT WITH MILK OR ANTACIDS.)

**DOSAGE AND ADMINISTRATION:**

Swish vigorously around and between the teeth for one (1) minute, then expectorate. DO NOT SWALLOW. For maximum benefit, do not eat, drink or rinse for at least 30 minutes afterwards.

**CAUTION:** Federal (USA) law prohibits without prescription.

\* Trade mark 5ml and 10ml. \*pdf (Preventive Dental Fluoride) Product of Canada.



B.M.G. PHARMACEUTICAL PRODUCTS INC.  
1450 Nobel #19  
Boucherville (Québec)  
Canada J4B-5H3



## FLUORIDE MOUTHRINSING IN SCHOOLS . . .

### Protection For Children's Teeth

**Tooth decay is the most widespread, chronic disease of childhood and often requires extensive and costly repair. But effective methods to prevent it are available.**

The best way to prevent tooth decay is to adjust the amount of fluoride in a community's drinking water. *Drinking fluoridated water from birth reduces tooth decay by as much as 65 percent.* However, one-sixth of all Americans cannot have fluoridated water because they live in areas without central water supplies. An additional one-third of the U.S. population is not receiving this benefit because their communities have not yet adopted water fluoridation.

For children and youth 6 through 18 who live in fluoride deficient areas, a

school program of weekly rinsing with a 0.2 percent solution of neutral sodium fluoride is recommended for protection against cavities. Results of research done during the past 10 years have shown that children who use this procedure will have about *35 percent fewer cavities* than otherwise expected.

Results from a few studies suggest that youngsters who are benefiting from community water fluoridation may receive *added* protection from the use of a fluoride mouthrinse.

The procedure is simple. Once a week, under supervision, the students rinse the fluoride solution between their teeth for one minute and then it is returned to the cup for proper disposing.

**Weekly mouthrinsing with a fluoride solution in school is a desirable program because:**

- The procedure is effective.
- Few materials are needed.
- Little time is required for the procedure—only 3 minutes per week for an average class.
- Mouthrinsing is easy for school children of all ages to learn and to do.
- Non-dental personnel, including classroom teachers and parents, with minimal training can easily supervise the procedure.
- The procedure is well accepted by participants, parents, and school personnel.
- More than 12 million school children now participate in this preventive procedure.



**Weekly mouthrinsing with 0.2 percent neutral sodium fluoride:**

- requires minimal time and effort.
- provides effective protection against cavities.
- is well accepted.

For more information on how to initiate a fluoride mouthrinsing program in your school contact:

**DENTAL HEALTH PROGRAM**  
Office of Parent-Child Health  
Services  
Airdustrial Park, Building 3  
LC-11B  
Olympia, WA 98504  
(206) 753-5423



DENTAL HEALTH PROGRAM  
Office of Parent-Child Health  
DSHS 22-454 1986

# School Dental Health Program

## Fluoride Mouthrinse Program Information and Consent Form

Parent/Guardian:

Your child's class will be given the opportunity to participate in a program that has been shown to reduce tooth decay by up to 35 percent. Once a week throughout the school year, participating children will rinse their mouths for one minute with a fluoride mouthrinse. This procedure is safe and is endorsed by the U.S. Public Health Services and by the Washington Bureau of Parent and Child Health Services. Supervision by the classroom teacher is to assure that the rinse is not swallowed (if swallowed, the mouthrinse could cause a mild stomach upset).

While fluoride treatments are among the most successful methods of preventing tooth decay, brushing teeth and use of dental floss will also reduce tooth decay and should be carried out together with any fluoride treatment. Therefore, along with the fluoride mouthrinse, your child will learn a proper toothbrushing technique and daily toothbrushing may be conducted in the classroom.

The fluoride rinse used in this program is neither a substitute for any fluorides, such as drops or tablets, which have been prescribed by your dentist or physician, nor does it replace the need for regular care by your dentist.

Your child's participation in this program is entirely voluntary. Should you decide to withdraw your consent at a later date, you may do so. If you would like additional information about the fluoride rinse program before you decide whether or not to give your permission,

---

### Fluoride Mouthrinse Program Consent Form

Please indicate your desire concerning your child's participation by signing this form and returning it to the school.

Parent's or legal guardian's consent statement:

\_\_\_\_\_ I wish my child to participate in the fluoride mouthrinse program during the year  
September 1988 to June 1989.

\_\_\_\_\_ I do not wish my child to participate in the fluoride mouthrinse program.

Name of Child \_\_\_\_\_ Age \_\_\_\_\_  
(Last) (First) (Middle)  
Date of Birth \_\_\_\_\_ Sex \_\_\_\_\_  
(Month) (Day) (Year)  
Name of School \_\_\_\_\_  
Teacher \_\_\_\_\_ Grade \_\_\_\_\_  
Signature of Parent or Guardian \_\_\_\_\_ Date \_\_\_\_\_



### M A T R I X   I I I

add chlorine) that these fluorides are naturally occurring in the water. There are local programs in the schools that encourage, and in some cases demand, that children use the product called "Swish" on a weekly basis. Combine that with fluoride toothpaste use and the effect is still being achieved.

The dosing of school children with topical doses of fluoride, usually in a .2% concentration, occurs weekly in various parts of the country. A Freedom of Information Request to the local county Dept of Health revealed that in 1992, the target in Thurston County Washington was 9,200 children. Data from the Washington State Department of Health revealed that "more than 12 million school children now participate in this 'preventive' procedure." Despite the claim that there are no contraindications with its use, leaflets distributed with the substance warn: "Do not use in children under the age of five, since younger children cannot perform the process without significant swallowing. Precaution - not for systemic use. Federal law prohibits distribution without a prescription."

#### Fluorides Outside the United States

Mandatory medication by fluoridation is not peculiar to the United States. Australians have for more than three decades been subjected to forced fluoridation of their drinking water. In 1953 the National Health and Medical Research Council of Australia lent its support to the mandatory mass-medication of Australians. The introduction of fluoridation was linked with political and industrial interplay. A recent book published in Australia that deals with the problem is one written by Wendy Varney, entitled "Fluoride in Australia - A Case to Answer."

Today, Australia ranks as the most comprehensively fluoridated country in the world. More than 70% of the people are obligated to drink water to which fluorides have been added. Brisbane is apparently the only capital city which does not fluoridate. Australia, the future site (according to some sources) of the world government of the New World Order, continues to persist in its policy to fluoridate water supplies, despite the fact that 98% of the world's population has either discontinued fluoridation programs or never began them.

Statistics show that less than 40% of the United States is currently fluoridated and England is only 10% fluoridated. Sweden, Scotland, Norway, Hungary, Holland, what used to be West Germany, Denmark, and Belgium are some of the countries that have discontinued fluoridation of their water supplies.

## M A T R I X   I I I

There are stories that have been told, stories which cannot be confirmed, that certain substances have been added to human water supplies in the past by various controlling species in the past. Perhaps the use of fluorides is just the latest episode in a long line of chemical manipulations of human consciousness.

### A Congressional Statement About Fluorides

Congressman A.L. Miller of Nebraska is quoted in the Congressional Record on March 24, 1952, A1833, as saying:

"I was misled by the Public Health Service...I was misled and perhaps others have been misled by statements that the American Medical Association had given their unqualified approval to the fluoridation plan. All of the advocates of the use of fluorides in water said no conclusions had been reached, but studies were in progress...All of the facts have not been made available on this subject...It is difficult for me to understand how high officials in the Public Health Service could change their mind over a 3 month period and completely reverse the field...I sometimes wonder if the Aluminum Company of America, and its many subsidiary companies might not have a deep interest in getting rid of the waste products from the manufacture of aluminum because those products contain a large amount of fluorine. In this connection it is interesting to know that Oscar Ewing, who now heads up the Federal Security Administration, and the firm of attorneys he was with - Hubbard, Hill & Ewing - represents the Aluminum Company of America."

Congressman Miller cited a witness before the committee, Dr. Robert S. Harris, who "pointed out that there was plenty of evidence that 1 part per million of fluoride or a little more in the drinking water interfered with the enzyme systems which are involved in the growth of bones and in the function of nerve tissue."

### *The Use of Chlorine Gas*

In the years immediately following World War I, the chemical cartels (dominated by I.G.Farben) were faced with a huge supply of leftover chlorine, which had been manufactured at great expense to cause intensive suffering and death. They discovered that the only possible market was to sell it to American communities, who would then pour it into their water supplies.

When the chlorine was added to the water supplies, it brought an unforeseen effect. It brought on a new epidemic of heart attacks. The chlorine in the water combined with

### M A T R I X   I I I

the animal fats in the diet to form a chemical amalgam which formed a gummy substance in the arteries, creating a medical condition known as *atherosclerosis*, which brought on attacks of angina pectoris and coronary heart attacks.

The addition of chlorine to public water supplies is mandated by state law in most areas, insuring the rapid rise of heart problems and high profits in medical areas.

#### The Use of Nitrates

Toward the end of World War II, munitions manufacturers found themselves with huge inventories of nitrates. Because of the outbreak of peace, which is always regarded with horror by the major foundations, new markets had to be found. Nitrogen and nitrates were key ingredients for the manufacture of bombs and shells. A comparable peacetime market had to be developed. It was decided in 1945 that the only outlet was to put it into the food chain, as fertilizers, herbicides and pesticides.

The addition of these substances served to make farming even more capital intensive, forcing the farmers to borrow more money from the banks. This paved the way for the program of forcing individual farmers off the land, which would create the large agricultural monopolies.

One chief effect of the use of chemical fertilizers was that it increased the abundance of crops, but also failed to replace the elements within the soil. This led to the profusion of inert, nutrition deficient foods that exists at this time. Additional chemically based minerals were added to the soil and the soil in most of the farming areas was rendered useless for growing crops. The soils ended up in a state deficient of most natural minerals and natural elements required by plant life.

The use of chemical fertilizers caused the protein content of vegetables available to the public to drop steadily at the rate of 10% per year. The most dangerous result of this process was that the chemical fertilizers reduce the amount of potassium in the soil while at the same time increasing the amount of sodium.

Inactive potassium in the system precipitates illness, especially cancer. The increased sodium may explain the dramatic increase in the incidence of high blood pressure throughout the United States, because the population is ingesting steadily increasing amounts of sodium from foods grown in chemically fertilized soil, while simultaneously suffering from the effects of declining levels of potassium in the human system. Potassium is especially

## M A T R I X   I I I

necessary for the regulation of the heart beat; its lack makes the body even more prone to heart attacks.

Many nutritionists believe that the use of chemical fertilizers cause up to 70% of all anemia in the United States because these fertilizers do not replace the iron in the soil.

### Exportation of Dangerous Pesticides and Drugs

Many pesticides that have been banned in the United States, such as DDT, are exported to third world countries in South America and Latin America, who in turn produce food that is imported back into the United States. Despite this problem, the Department of Agriculture continues to admit food that has been treated with DDT; the policies that permit exportation of dangerous/banned chemicals and drugs to other countries, permitting the chemical and drug companies to reap enormous profits from the misfortunes of human beings, still continues, unabated.

### Direct Addition of Chemicals To The Food Supply

Most people in the United States are not aware that there are more than 5,000 chemical additives in the foods which they eat every day. The Federal Drug Administration describes these chemicals in this way:

1,700 + : Known to be harmless  
1,800 + : Generally recognized as Safe  
1,900 + : Never Tested For Harmful Results

Most of these additives have been added since 1952. An effort was made in 1958 to control these chemical by Rep. James Delaney of New York, who conducted hearings between 1950 and 1952 that determined at the time that there were 704 chemical additives, 276 of which had never been tested for safety. It took six years for the Delaney Clause to become law. It states that if any food additive is found to induce cancer when ingested by man or animal, it is to be designated unsafe and cannot be used. Obviously, this clause is filled with loopholes, since it only mentions one disease condition. Also, it does not require that all food additives be tested. If they are tested, they are tested for toxicity, not for their propensity to cause the only disease mentioned in the clause. It was an incredible blunder that the public was oblivious to.

Since the early 1940's food colorings were made from such poisonous substances as lead, chromium and arsenic,

### M A T R I X   I I I

even though the 1938 Food and Drug Cosmetics Act certified only certain dyes for use in foods. Since then, three of them have been decertified. The word "certified" simply means that it is pure - it does not relate to its safety as a food additive or its effects on human beings.

Some substances containing arsenic are still found in foodstuffs as pesticide residue and as a food additive for poultry and livestock.

Other food colors tested by the FDA have showed some interesting results: FD&C Red No.32 produced growth retardation, anemia, and diarrhea. Tests of Orange No.1 gave similar results. More than half of the Florida Orange crop was run through these dyes to give them a beautiful orange color. Canned and frozen juice often contained larger amounts of these dyes, because packers by habit buy reject lots which are deemed unsuitable for marketing in supermarkets.

Even though the FD&C No.32 produced these effects when people got ill in 1955, manufacturers were informed in 1953 that the substances were harmful and that they could legally use up their stocks of these colors. The additive was finally banned in February of 1956.

In 1957, the FDA did tests on food colorings and reported that ten of the thirteen "certified" dyes then in use had produced cancers when injected under the skin of rats. It was estimated that humans would get twice as much dyes by mouth as the rats had injected under their skin.

Some of the dyes commonly used in the United States at this time are Orange No.1 and No.2 (both no longer retain their "certified" status), Yellow No.1, Yellow No.3, Yellow No.4, Green No.1, Green No.2, Green No.3, and Blue No.1. Yellow AB and Yellow OB, which are liver cancer hazards, have been widely used to color margarine and butter. They are made from a chemical with the long name of beta-naphthylamine, which is curiously not poisonous in its effect, but one of the most carcinogenic substances.

Orange No.2, which had been used heavily in the United States, was finally discontinued in 1956 when it was found to induce intestinal polyps and cancer in animals.

Violet No.1 and Citris Red No.2 (used for coloring oranges) were found in a 1933 study to be carcinogenic.

The food colors amaranth, bordeaux, orange, and procean are all derived from compounding nitrogen and benzene, which is also a commonly used motor fuel.

Napthol and guinea green are put into beverages. They

### M A T R I X   I I I

are derived from the reaction of chloroform or benzene and aluminum chloride to produce a dark green.

Tartrazene is manufactured by producing a reaction of acetophene on diazomethane. The yellow result is used to color food and is poisonous.

Coumarin, a key ingredient of imitation vanilla flavoring, had been in continuous use for 75 years before it was found to produce serious liver damage in laboratory animals. An artificial sweetening agent, dulcin, was used as a sugar substitute for 50 years before it was found to produce cancers in test animals.

Cochineal, used to produce a bright red color in food, is made from the bodies of dried lice. It is also included in chemistry sets for children.

Mineral Oil, the famous Rockefeller cancer cure of the 1850's, which is used in many salad dressings, was found to prevent the absorption by the body of vitamins and other nutritional needs. The increasing use of hydrogenated oils, and their kinkage to heart disease, offers an additional area for concern. According to government statistics, over a billion pounds of hydrogenated oils are used every year. Hydrogenated oils break down into toxins when heated.

Many of these substances cause moderate to severe allergic reactions in human beings. It is estimated that almost 100 million Americans suffer from some form of chronic illnesses - many of these are increasingly found to be caused by exposure to or ingestion of some chemical substance in food.

From 1940 until about 1977, the American intake of food colorings increased tenfold, while the actual consumption of fruits and vegetables declined. Studies have shown an inverse correlation between the intake of green or yellow vegetables and the mortality rate from cancer. The American Cancer Society ignores the fact that the increase in additive use parallels cancer increases.

Again and again, the same pattern appears. Substances are proven to be harmful, yet they continue to be used in a deliberate manner. The story of cyclamates is an interesting one. In 1966, a University of Wisconsin study recommended that cyclamates be removed from all foodstuffs. It was found in this study that the ingestion of cyclamates affected the reaction of the eye to light, caused excess loss of potassium (here we go again) if a person was using thiazide drugs for high blood pressure (caused by high sodium levels in the food because of the use of chemical fertilizers), interfered with the action

### M A T R I X   I I I

of diabetic drugs (despite the fact that cyclamates were advertised to be a solution to the sugar consumption problems of diabetics), and showed indications that it caused bladder cancer. Despite all this, the University of Wisconsin study was ignored by the government. Twelve million pounds of cyclamates are used each year, mostly produced by Abbott Laboratories.

Soft drinks contain large amounts of phosphoric and citric acids (in an aluminum can), which increases the acidity level of the entire body; results often manifest as mouth canker sores and duodenal ulcers. Cola drinks increase heart action, cause irritability and resulting insomnia, and can cause paralysis of the heart. Beer contains gypsum, better known as Plaster of Paris. Hops in beer can cause a hypnotic effect and can cause delirium tremens.

Caramel, also widely used, is prepared from ammonia; it is suspected in the manifestation of some mental disorders in children.

Many of you will remember that several years ago the product called Phisohex (hexochlorophene) was heavily promoted as an antiseptic. It was found and used daily in every hospital in the United States. They then discovered that it caused death when rubbed on the skin of babies. Phisohex was also featured in feminine hygiene sprays, Dial soap, shampoos, toothpaste, and cosmetics. It is manufactured from the same chemical as DOW chemicals 2,4,5T and 2,4D, which are both weed killers, and is closely related to dioxin. It took ten years to get the products off the market.

#### Bombardment of Food With Nuclear Radiation

As with all the other instances of deliberate addition of harmful substances to the food and water, a surplus of materials (this time radioactive) prompted the "brilliant" idea of irradiation of food. The most commonly used substance for this process is Cobalt-60. The first commercial instance of food irradiation took place in 1957 in Germany, where it was used to sterilize spices. The results were so disturbing the government banned the procedure the following year.

Not a country to be outdone by anyone else, the Soviet Union decided to try it in 1959, followed by Canada in 1960, who was still doing it as of five years ago.

Despite the negative results found with the process in Germany that resulted in the ban of 1958, the FDA in the

## M A T R I X   I I I

United States that same year took up the use of food irradiation, defining it as an "additive", which brought it under their control. In 1963, the FDA gave their permission to irradiate canned bacon - permission which they withdrew in 1968, when the Rockefeller monopoly decided to back the irradiation of food on a national level. The nation's large food companies (and some chemical companies) formed The Coalition For Food Irradiation, and staged "conferences" at prominent universities, at which only the advocates for their plan would be heard. One of the largest conferences was held in 1987 at Johns Hopkins, the second largest defense contractor. Johns Hopkins received \$317 million in defense funds the year before.

There are many records of tests indicating the dangers of irradiated foods. Consumption of irradiated rice has been linked with the development of pituitary, thyroid, heart and lung disturbances, and development of tumors.

When children and animals were fed irradiated wheat (oddly, Canada would not irradiate their wheat but did decide to do it to their food), they developed increased abnormality of their chromosomes (called polyphoidy).

The United States Department of State demonstrated their interest in the promotion of U.S. technology using Cesium 137 isotopes for food irradiation in 1988. Cesium 137 is produced from nuclear wastes (when will it end?) and, according the State Department, will minimize U.S. nuclear waste disposal.

Gamma Irradiation Facilities are licensed by Abbott Laboratories to DOW Corning, General Electric, General Foods, IBM, IRT Corporation, Merck, RCA and Rockwell International.

### Environmental Chemicals

In 1988, there was an article published in the Washington Post, albeit a CFR-controlled paper, that stated that at least 60,000 chemicals were in use in the environment. It also said that less than 2% had been tested for toxicity. It has been estimated that as much as 20% of the population in the United States is being seriously harmed by chemicals. The effect is probably strongest in the young. Millions of school children sit in classrooms for six hours a day breathing residues of the chemicals used to construct the schools, especially the schools constructed in between 1950 and 1968. Much of this chemical exposure is from industrial wastes.

Two reports surfaced in March 1992 about environmental chemical pollutants and health. The first report was about



### M A T R I X   I I I

the phenomena of autism, a brain disorder that affects many children. After a three-year study, many parents of autistic children were found to have lived in Leominster Massachusetts across from where the old Foster Grant sun-glass plant used to be. High levels of smoke containing vinyl chloride that would always envelope the neighborhood are thought to have wrought genetic changes that produced the autism in the children. More than 46 cases of children having autism were traced to the two streets across from the plant. The company has since gone bankrupt, and the area is currently under an environmental cleanup program.

The second report concerns the town of Brownsville, Texas, which is on the U.S.- Mexico border. Parents in Brownsville, sometime ago, started having children that were born without brains, literally, in this Rio Grande Valley community. The occurrence of these anacephalic children in Brownsville is six times the national average.

The source of the problem has been traced to American companies who are directly across the border (because of cheap labor and lax environmental laws) who dump xylene onto the ground, and the xylene has been leaching into the ground water in Matamoros and getting into the water table in Brownsville. The Centers for Disease Control was supposed to release a study about the problem in April of 1991. There is no data yet that indicates that the report was released. A similar report of children born without brains was televised in March 1992 about children in Fort Lauderdale, Florida.

#### Use of Aluminum Metal as a Physiological Control Over Behavior and Consciousness

As if the fluoride by-products of the Aluminum industry weren't bad enough, the use of aluminum in our society (check your toothpaste tube) directly causes the disease known as Alzheimer's disease. Over 3 million people in the United States are currently affected with this strange, incurable disease. Its victims bring the medical cartel over \$50 billion each year. The presence of Aluminum, like fluorides, affects the neurotransmitters in the brain. The principal agent seems to be the accumulation of aluminum deposits on the principal nerves of the brain. About 70% of the costs of this illness is borne by the families of the afflicted, as most Medicare and private health insurance programs refuse to pay it.

The origins of Alzheimer's disease have been traced to the large amounts of aluminum which most Americans began ingesting with their food since the 1920's and has also been connected with the increasing amount of microwave radiation exposure that American's have been experiencing.

# Irradiated Food

**D**o you know that food irradiation has been approved by the FDA?

And that the nation's first commercial food irradiation facility, Vindicator, Inc. in Mulberry, Florida is about to be opened? Connecting Link feels it appropriate to alert you to both the health dangers of radiation-exposed foods and the devastating environmental consequences of a burgeoning, new nuclear industry.

## What is Food Irradiation?

Food irradiation is a process in which massive doses of gamma rays, X-rays or electrons are passed through food or food packages to kill insects, molds or microorganisms that can lead to spoilage or disease. Food irradiation facilities use radioactive materials—cesium-137 or cobalt-60—to emit gamma rays which penetrate the food or they use a linear accelerator which emits X-rays. Dosage is controlled by the amount of time the food is exposed to a radioactive source.

Provided irradiation is properly controlled, food should not become radioactive, although there is usually some activation of trace metals in food. So far, 33 countries have approved over 40 irradiated food items for consumption, including spices, fruits, vegetables, rice, seafood, and poultry. Irradiated food is being marketed in 19 countries and food irradiation facilities are under construction or in advance stages of planning in 12 other countries.

## Where Does the Radiation Come From?

Both cobalt-60 and cesium-137, the radioactive materials used for food irradiation, come from the nuclear industry.



Cobalt-60 is produced from cobalt-59 in the Canadian Candu nuclear reactors. Cesium-137 is a waste product from the reprocessing of spent fuel from other nuclear reactors. Small linear accelerators to process food are being built and tested by Atomic Energy of Canada Ltd.

## Is Irradiated Food Safe to Eat?

A number of facts about irradiated food suggest that it is not safe:

- Food irradiation destroys some of the harmful bacteria in food but not the toxins they produce before irradiation. Other harmful bacteria, such as those which cause botulism, are very resistant to radiation and can continue to grow in irradiated food. In the process of food irra-

diation, some good bacteria are destroyed too, for example, bacteria which cause food to smell bad when it spoils.

- Malnourished children fed freshly irradiated wheat in an Indian study developed chromosomal abnormalities of the blood called polyploidy, an abnormality seen in cancer and severe infectious diseases in which cells in the body develop more than the normal set of chromosomes. This effect has been confirmed in studies on rats, monkeys and hamsters. Fruit flies fed gamma-irradiated chicken had seven times fewer offspring than those fed heat-treated chicken.

- Chemicals called "radiolytic products" appear in foods after irradiation, and some of these chemicals may be harmful to human health.

- Vitamins are damaged by food irradiation, reducing the nutritional quality of our foods.

- Aflatoxins, which are naturally occurring cancer-causing

agents, may grow more readily on foods that have been irradiated.

Some animals fed irradiated foods have lower birth weights and growth rates and have developed testicular tumors, kidney damage, increased rate of death in offspring, lowered immune response and abnormal blood cells.

- The British government's advisory committee has admitted there is insufficient scientific evidence on the safety of the effect of irradiation on pesticide residues, chemical additives, contaminants and packaging materials.

- Irradiation may kill bacteria, but it will not remove the chemical toxins created by the bacteria before the food was irradiated.

- The technology is already being widely abused. Numerous cases have come to light where food companies have used irradiation to conceal contamination on unsalable foods (prawns, spices, mussels and chicken) and put these back on the market. This practice makes obsolete the tests and controls that public health officials use to guarantee that food is safe, wholesome and fit to eat.

#### Is Food Irradiation Safe for The Environment?

There are several serious environmental hazards associated with food irradiation:

- Increased transport and handling of dangerous radioactive materials:
- Danger of exposure to workers that could cause immediate death or could result in cancers or genetic problems;
- Contamination of the the environment which has occurred due to accidents and safety violations at irradiation facilities;
- Increased generation of radioactive wastes, for which storage problems are already severe;
- Cesium-137 is only obtained by reprocessing spent nuclear fuel, thereby encouraging this process which is principally used for extraction of plutonium for nuclear weapons.

- Supermarkets have started selling radiation-exposed foods: spices, processed foods, and soon, meats and fruits and vegetables.

The supermarkets claim this irradiation preserves foods, but many scientists are saying irradiation makes foods unsafe, changes the molecular structure of food, destroys nutrients, and new studies show that ingesting radiation-exposed food causes genetic damage, which can lead to cancer and birth defects.

Can you do anything about this?

Yes, you can. Tell your supermarket manager you oppose having radiation-exposed foods in your store and you don't like shopping in a store that carries them. For more information call: Food and Water, Inc. 1-800-EAT-SAFE.

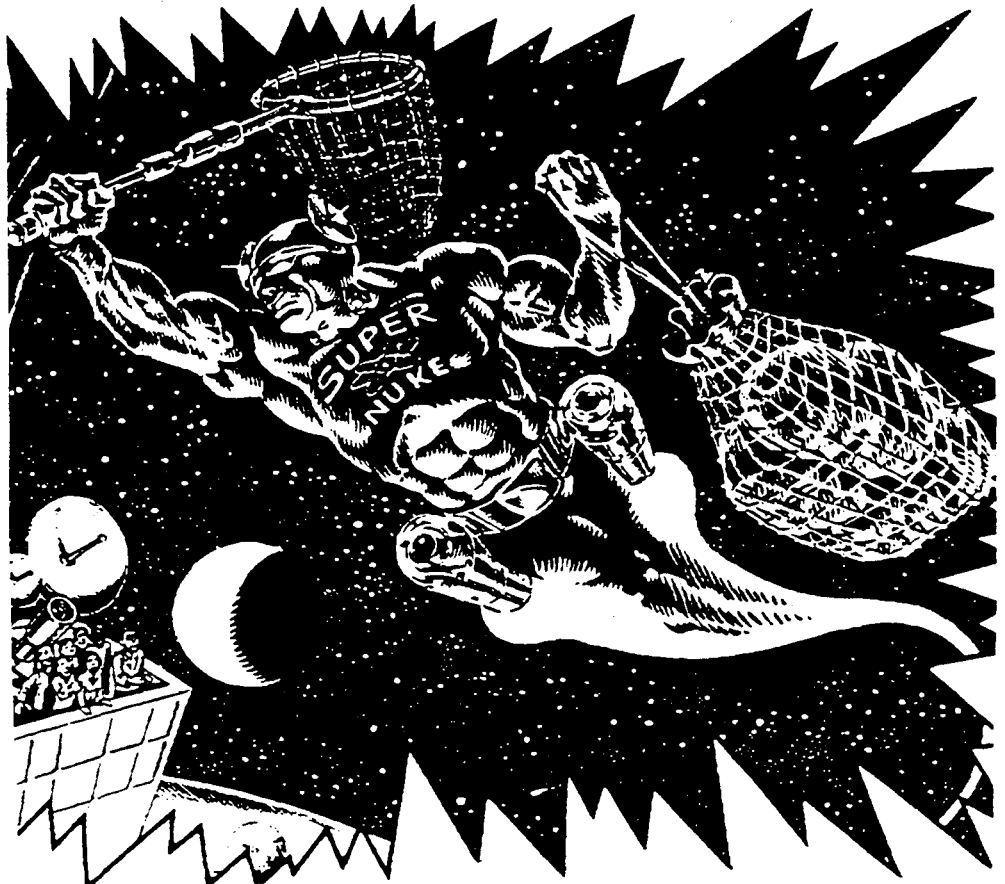

M A T R I X I I I

Alternative Fluoride-Free Toothpastes and Products

Tom's of Maine, Inc  
Kennebunk, Maine 04043      -Spearmint, Peppermint, Fennel  
Cinnamint Natural Toothpastes  
-Aloe and Coriander Natural  
Deodorants; Mint, Honeysuckle,  
and Unscented.

Desert Essence                      -Tea Tree Oil Toothpaste  
Topanga, California 90290

Natures Gate                      -Natural Toothpastes  
9183 Kelvin Ave                      Herbal Creme de Peppermint  
Chatsworth, California 91311      Herbal Creme de Anise  
Herbal Creme de Mint  
Mint Gel and Wintergreen Gel

Nutri-Biotic                      -Natural Toothpastes  
Lakeport, California 95453      Sweet Peppermint

Xyli-Fresh                      -Natural Toothpastes  
Finnfoods                              Peppermint  
Bannockburn, Illinois 60015      Cinnamon  
Spearmint

American Merfluan, Inc.          -European Tooth Powder  
Menlo Park, California 95453      Mint, Anise, Cinnamint

New Scientist 5 August 1989

## Trace aluminium affects kidney patients

**K**IDNEY patients in Britain are again at the focus of research into aluminium poisoning. Scientists have found abnormalities in the way that the brain responds in patients whose blood contains only moderately raised amounts of the metal compared with other kidney patients. Although the people examined by the scientists appeared to be mentally well, their performance in a range of tests was worse than that of a group of normal people who acted as controls, and their brains reacted more slowly to specific visual stimuli.

The new work, by Paul Altmann at the London Hospital and his colleagues at the University of Aston in Birmingham, renews the debate on how poisonous aluminium is (*The Lancet*, vol ii 1989, p 7). It suggests that even when there is no overt sign of poisoning, the metal is doing damage to the brain.

As early as 1980, Peter Ackrill, Jane Barron and others at the Withington Hospital in Manchester showed that kidney patients who appeared well to their doctors and their relatives had distinctive abnormalities that speech therapists could recognise in the way that they spoke (*British Journal of Disorders of Communication*, vol 15, p 75). However, these patients had been exposed to much higher levels of aluminium than Altmann's patients—water used for their dialysis at that time contained up to 650 micrograms of the metal per litre.

Since 1980, however, techniques for measuring aluminium in the body have improved, enabling researchers to make more quantitative assessments of the state of their patients. Ackrill and his colleagues are continuing their research on disorders of speech as a marker for early damage from aluminium. Altmann's team, on the other hand, has looked at biochemical signs of deterioration, objective tests of cerebral function, and the electrical activity of the brain. Both teams agree that doctors must be still more stringent in controlling the amount of aluminium that enters a patient's body. "It's clearly a much more toxic element than people realise," says Altmann.

Since the 1970s, researchers have known that, without careful monitoring, kidney patients risk fatal brain damage and dementia, bone disease and anaemia because of the large amounts of aluminium that they can encounter.

Kidney patients are exposed to aluminium from two sources. First, people whose kidneys malfunction often need to take medicines which contain aluminium in order to bind phosphates that they could not otherwise excrete. In a day, a patient may take more than a gram of aluminium in these medicines, whereas a normal diet contains less than 2 milligrams a day. Some of the metal in the medicines is in a soluble form and can, therefore, enter the bloodstream.

Secondly, most kidney patients must

Phyllida Brown

have regular dialysis to remove wastes and toxins from the body. In dialysis, blood from the patient passes through an artificial kidney. The waste materials in the blood pass across a semipermeable membrane into a fluid kept separate from the body, then the "cleaned" blood returns to the body. A four-hour session on a dialysis machine will expose a patient to 120 litres of water.

Health authorities treat the tap water

aluminium is removed. Because the enzyme is present both in the brain and the blood, it may provide a useful marker for what is going on in the brain, says Altmann.

He gave 15 of the patients at the London Hospital a drug called desferrioxamine (DFO) which doctors can use to remove aluminium. DFO works by binding aluminium and effectively drawing it out of the tissues into the blood. Dialysis then removes it from there. However, it may take many months to remove the metal that the patient has accumulated.

Altmann found that, after three months of treatment with DFO, the patients' levels of DHPR rose by an average of 51 per cent. The group also performed better in some of the mental tests than they had before treatment. There is good evidence that the two findings were directly linked, says Altmann, although he adds that there is no proof.

Ackrill in Manchester was the first to use DFO for patients with aluminium poisoning. One patient with apparently terminal brain disease and very high levels of aluminium in his blood recovered after treatment with the drug in 1979, and

is still alive and well a decade later. Doctors are using the drug increasingly to treat thousands of kidney patients who suffer from bone disease caused by aluminium poisoning, although the treatment carries certain risks.

The results of the new research suggest that "much more rigorous exclusion of aluminium from the dialysate and diet of dialysis patients is necessary". Altmann considers that the tests of cerebral activity may be useful ways of monitoring patients regularly to detect the earliest signs of brain damage.

He also raises the question of whether the research could give scientists new clues about the development of Alzheimer's disease—a form of dementia that other researchers have linked with aluminium (*This Week*, 21 January).

"Although patients on dialysis don't have a higher rate of Alzheimer's than the general population, it is interesting to ask whether our patients represent some sort of model for Alzheimer's," says Altmann. The specific disturbance in the brain's response to the visual stimuli in the patients was very similar to that seen in the brains of people with Alzheimer's.

Meanwhile, Ackrill is cautious about the usefulness of measuring aluminium levels in the blood alone. This is because so much of the metal may be stored in the tissues, only to be mobilised at some later stage. He believes that researchers need a much better way of measuring total aluminium levels before they can tell if someone is "overtly toxic" or not.

Both teams agree, however, that the priorities are to find a satisfactory alternative to medicines that contain aluminium—at present, there is none—and to persuade water companies to stop treating water with aluminium sulphate. □

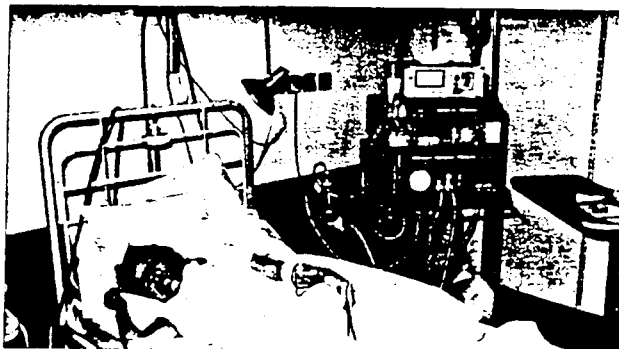

Kidney patients get aluminium from dialysis water and drugs

Teresa O'Shea/Christie Cross Hosp

used to prepare the fluid for dialysis, in order to remove the large and variable quantities of aluminium that it may contain. If the treated water contains more than 14 micrograms of aluminium per litre, however, some will pass into the patient (*This Week*, 21 January).

Altmann worked with a group of 27 patients who had, on average, 59 micrograms of aluminium per litre of blood. This level is high for a normal person but levels between 60 and 80 micrograms per litre are common in kidney patients, says Altmann. In extreme cases, a patient who has been on dialysis and aluminium medicines regularly for several years may have several hundred micrograms of aluminium per litre in their blood.

Altmann's group of patients had had regular dialysis for seven years. He stresses that none of them was chronically demented. All appeared mentally well. However, when he asked 27 patients to do various computerised psychological tests—such as matching shapes with digits—their responses were significantly less accurate and slower than those of the control group.

In addition, the researchers tested 10 patients by measuring the electrical activity of their brains while they gave them visual stimuli from flashing lights and a reversing pattern. Their responses to pattern were as rapid as a normal person's, but their responses to the flash were significantly delayed compared with those of the control group.

Another of Altmann's tests involved an enzyme called erythrocyte dihydropteridine reductase (DHPR). This enzyme is involved in the production of certain neurotransmitters in the brain, and researchers can measure it in the blood. Altmann has shown that aluminium inhibits DHPR, and that the enzyme becomes more active if

### M A T R I X   I I I

Alzheimers is now causing more than 100,000 deaths annually, and is the fourth leading cause of adult death in the United States, yet, significantly, there is no national foundation to investigate its causes ...the medical monopoly already knows the answer.

After consuming food cooked in aluminum pots over a period from twenty to forty years, many Americans began to experience serious memory loss; their mental capacities then deteriorated rapidly. It was then found that concentrations of aluminum in certain areas of the brain had caused permanent deterioration of brain cells and nerve connections; the damage was not only incurable; it was also progressive and not responsive to any known treatment. Seven percent of all Americans over 65 have now been diagnosed as having this disease.

#### Pharmaceutical Products Containing Aluminum

This problem has not only been caused by the aluminum cookware, but by the daily ingestion of aluminum from many products in common household usage. Woman's douches now contain solutions of aluminum, which introduces it directly into the system. The most widely used painkillers such as buffered aspirin contain impressive quantities of aluminum. The largest single source of aluminum occurs with the daily ingestion of widely prescribed antacid products. For example, Mylanta II has 116mg of aluminum per dose. Estomil-M has a whopping 265mg per dose.

Various other non-prescription drugs contain significant amounts of aluminum. Kaopectate Concentrate, manufactured by Upjohn has 290 mg per ml. The use of aluminum ammonium sulfate as a buffer and neutralizing agent in cereals and baking powder is common. Aluminum Potassium Sulfate, known as aluminum flour, is widely used in baking powder. The use of Aluminum Potassium Sulfate has now reached 40 million pounds a year. Aluminum foil wrapping is everywhere. Aluminum cans containing acid-based soft drinks (Coke, Pepsi, etc) ensure that it will get into your system. Its effects are the equivalent to that of a slow virus, as the metal accumulates at vital pints in the system, particularly in the brain. Thus, the number of Alzheimer victims are vastly outnumbered by the victims to come in the future.

#### The Neurological Effects of Aluminum Poisoning

Some of the neurological effects of the accumulation of aluminum in the brain relate to a substance called choline, which brain cells use to form their surrounding

### M A T R I X   I I I

membranes. In an analysis of brain samples from people who died of Alzheimers, researchers at MIT, headed by Richard J. Wurtman, found that choline levels were 40% to 50% lower than in normal brain tissues. Levels of a related membrane building block, called ethanolamine, were similarly reduced. According to the MIT study (which was revealed in the March 2, 1992 issue of the Wall Street Journal, pB6), scientists found that the decay of brain cell membranes appeared to be unique with Alzheimers and did not appear in the brains of people who died from other degenerative diseases of the brain, including Parkinson's disease. The study also appears to link two hallmarks of Alzheimers disease - the selective, heavy damage it wreaks on brain areas involved in memory and the formation of clumps of protein called beta amyloid. Researchers have known since the mid-1970's that Alzheimers disease is correlated with a deficiency of acetylcholine, a substance made from choline that transmits signals between neurons. Acetylcholine is especially important in brain areas involved with memory, notably the hippocampus. This may explain why memory is affected first in people with the disease.

Because of these findings, the allopathic medical monopoly is (according to their habitual pattern of treating a "disease" in terms of its' symptoms) proposing giving Alzheimers patients massive levels of choline in an attempt to head off symptoms. If it were generally known that the cause for the disease is the progressive accumulation of aluminum, it could invite a tremendous wave of litigation against the aluminum industry and also create many political problems for whatever current administration is in control. The major companies developing such choline-based drugs are Interneuron Pharmaceuticals in Lexington, Mass. and BrainChemTech Corporation in Columbus, Ohio.

#### *A Family concern with a caring solution*

Today there is no cure for Alzheimers Disease so there must be care. We respond to this tough problem with a gentle solution: an around-the-clock residence, offering professional expertise with a commitment to quality of life and respect for every individual.

The services your loved one will receive all come together to make life a little easier.



#### MAKING LIFE A LITTLE EASIER-

- Licensed nurses on duty 24 hours
- Private apartments - designed for Seniors
- Social and recreational activities
- Three home-style meals daily
- Free transportation for outings
- Night-time, every two hour monitoring
  - Personally designed services
  - Loving family environment
  - Secure environment
  - Incontinency care
  - Respite Care Program

## M A T R I X   I I I

### Major Sources of Fluoride and Aluminum

The principal source of much of this substance is ALCOA, the Aluminum Company of America - a \$5 billion a year enterprise. Its president is Charles W. Parry, a director of the supposedly "right wing" think tank, American Enterprise Institute, of which Jeane Kirkpatrick (her husband was in the CIA) is the most highly touted member. The former chairman and still director of ALCOA is William H. Krome George, who is also an active director of the well-publicized United States-USSR Trade and Economic Council, which intends to rescue the former Soviet Union from economic oblivion.

Other directors of ALCOA are Alan Greenspan, chairman of the Federal Reserve Board of Governors and also a director of Capital Cities ABC Network, as well as being a trustee of the Hoover Institute, which furnished the powerhouse behind the "Reagan Revolution"; Paul H.O'Neill, who is a member of the Board of Visitors at Harvard University, president of International Paper, and a director of National Westminster Bank of England; Franklin H. Thomas, a director for Citicorp; Sir Arvi Parbo, an Australian tycoon who is director of Zurich Insurance and Chase Manhattan Bank; John P. Diesel, president of Tenneco Oil and director of First City Bancorp (one of three Rothschild banks in the US); John D. Harper, chairman of Coke Enterprises; John A. Mayer, director of H.J. Heinz Company, the Mellon Bank and his son, John Mayer Jr, who is general manager of the Morgan Stanley Bankers in England, and vice president of Morgan Guaranty Int'l.

Other sources for fluorine products that are deliberately added to the water supply might include the fertilizer industry, who has as a by-product fluosilic acid, which is routinely used as a "water treatment chemical".

Sources for sodium fluoride used in school-based programs have been identified through our FOIA requests as:

B.M.G. Pharmaceutical Products, Inc.  
Boucherville, Quebec, Canada

Medical Products Laboratories  
Philadelphia, Pennsylvania

There is no doubt that these companies are not aware of the potential harm or the covert purpose for the use of fluoride on a national basis.



# Remedies for Harmful Metals Discovered in Finland

EXCLUSIVE TO THE MONTHLIGHT

BY ALEC DE MONTMORENCY

Excessive amounts of heavy metals present in various organs of the body characterize many chronic diseases. Whether they cause those diseases or just aggravate them is still a matter of debate. But their impact is beyond doubt.

The problem is how to get rid of those harmful metals. Chelation therapy is known to remove heavy metal deposits, but its use is condemned by Establishment medicine. Also, waters or volcanic muds of some health spas have long been known to be very helpful in the matter.

But these are not the only remedies available. A revolutionary and quite novel treatment system for the condition was described by Dr. Hans Kalm of Jyväskylä, Finland, in a 123-page work called *Organotropia as a Basis of Therapy* (edition VIII, February, 1967).

The physician, who had been an agronomist in his early days, had discovered an important biological fact: the existence of antagonistic couples among the primary chemical elements listed in the periodic table. One element, he discovered, even in tiny amounts, is capable of acting as an antidote against its antagonist.

This enabled him, when encountering a poor crop and analyzing the soil, and finding the culprit—a metal; usually a heavy metal—to remedy the situation by adding to the soil modest amounts of its antagonist in the form of water-soluble salts. Thereupon the farmer got fine crops. Kalm also used this approach on farm animals with equal success.

When he became a medical doctor he tested his biological theory on human patients, making sure to use only harmless amounts of the antidote. He would first obtain biological samples—principally hair and nail clippings—of his patient. Then he would send one-half of the sample to a laboratory in Germany and the other half to a similar establishment in Sweden.

If the two assessments tallied closely, he would prescribe the remedy—the antagonistic primary chemical element.

He referred his patients to A. Nelson & Co., 73 Duke Street, London, England for the needed element(s).

His first patients were people sent him by other physicians in Finland who knew him and trusted his medical knowledge. They would tell the patient: "The medicines I have been prescribing to you do not seem to work. You should consult Dr. Kalm."

Invariably, after the patient took the remedial element or elements in minute amounts, the ailment vanished. The "law of antagonistic couples among the primary chemical elements" worked for humans just as it did for plants and animals, on which Kalm had first tested his theory.

#### SOME CONDITIONS

In his study, Kalm lists a number of forms of anemia his technique succeeded with: anemia aplastica, which arises from a shortage of manganese and chrome; anemia perniciousa, which begins from insufficient-

cy of boron and the corresponding excess of iron; anemia sideropenica, which is generally considered to come from the lack of iron alone; anemia thrombinopenica or thrombocytopenica, which begins from a copper deficiency, with ensuing hemophilia.

In each case the biochemical analysis clearly showed the chemical imbalance in the body, for which Kalm's table made finding the remedy easy. The uses of the table are many. For instance, it has now been established that high blood pressure is caused by the accumulation in the body of lead and cadmium, both toxic heavy metals.

The antidote of lead is osmium, a noble metal contained in tiny amounts in the sap of the birch tree and the sap of *Equisetum hiemale*, a species of horsetail that thrives in cold climates. Both of these plants have long been known as prime remedies for high blood pressure.

The antidote of cadmium is cesium. In quantity, cesium is itself poisonous. It is known to be contained, again in tiny amounts, in horsetail. But, as it is a relatively new arrival among the toxic metals that now pollute the environment, little is known about the botanical remedies for it and their metal contents. According to Kalm's theory, however, the antidote of cesium must be cadmium.

Here is the table of the antagonistic prime chemical elements established by Kalm, with the offending elements followed by their antidotes in parentheses.

Aluminum (tungsten)  
Antimony (thulium)  
Arsenic (thorium)  
Barium (gallium)  
Beryllium (copper)  
Bismuth (palladium)  
Boron (iron)  
Bromine (strontium)  
Cadmium (cesium)  
Caesium (cadmium)  
Calcium (thulium)  
Carbon (silicon)  
Cesium (potassium)  
Chlorine (magnesium)  
Chromium (sulfur)  
Cobalt (niobium)  
Cobalt (thulium)  
Erbium (thulium)  
Fluorine (nitrogen)  
Gallium (barium)  
Germanium (polonium)  
Gold (selenium)  
Iodine (platinum)  
Iridium (titanium)  
Lithium (erbium)  
Lutetium (calcium)  
Magnesium (chlorine)  
Manganese (sodium)  
Mercury (radium)  
Molybdenum (samarium)  
Neodymium (zinc)  
Nickel (thallium)  
Niobium (titanium)  
Nitrogen (fluorine)  
Osmium (lead)  
Palladium (bismuth)  
Platinum (iridium)  
Polonium (germanium)  
Radium (mercury)  
Radon (strontium)  
Rhodium (yttrium)  
Samarium (molybdenum)  
Sulfur (chromium)  
Tellurium (silver)  
Thallium (nickel)  
Thorium (arsenic)  
Thulium (antimony)  
Tin (phosphorus)

Tungsten (aluminum)  
Uranium (niobium)  
Vanadium (zirconium)  
Ytterbium (rhodium)  
Yttrium (bromine)  
Zinc (neodymium)  
Zirconium (vanadium)

Kalm's discovery of the existence of the antagonistic couples among the primary chemical elements may rank in importance with the discovery of vitamin C and of antibiotics. The existence of these antagonistic couples was sensed by the physicians who specialized in crenotherapy when they used oligomineral spring waters to treat metal poisoning and by physicians who used colloidal solutions of certain metals, such as osmium, in the treatment of high blood pressure and metal poisoning among miners.

The table of antagonistic couples points to the possibility of using colloidal solutions of tungsten in the treatment of Alzheimer's disease, since Alzheimer's has been found to always be marked by an excessive accumulation of aluminum in the brain.

One reason why no attempt to do so has been reported may be the fact that Kalm's method of treating patients was received with great hostility by the medical Establishment, and a campaign to discredit him followed.

The campaign was similar to the one launched against the Municipal Hospital of Santo Andre in the state of Sao Paulo, Brazil, after a big illustrated magazine ran the story of the new cancer remedy which was being successfully used there. Powerful personages, including government officials, brought immediate pressure on the town's municipal council to gag the hospital's doctors and forbid any further use of pau d'arco (also called *lapacho colorado* in the Spanish-speaking countries).

What incensed the Establishment was that the hospital's physicians had used the South American Indian remedy—the bark of a tall, extremely hard-wooded tree of the oak family—without authorization from the medical authorities and had talked about their successes to reporters from *O Cruzeiro*.

The latter, in two successive issues in March of 1967, had quoted the physicians and carried their pictures at work. Dr. Jose Roberto Lemus of Americana (a nearby city which had been founded by Confederate officers after the South collapsed) was a surgeon and gynecologist.

#### DOCTOR QUOTED

He was quoted, in part: "In December, 1965 I operated on an elderly man with a case of gastrointestinal obstruction, provoked by cancer with metastasis in various other organs. He should have died a year ago. He is alive. He comes here for consultation. In that case metastasis had occurred in the liver and elsewhere. It is extraordinary that he makes the trip here and back home afoot. He lives out of town."

Another case: "A lady, over 60, with intestinal obstruction [due to cancer of the sigmoid colon]. [She was in very grave condition.] [The patient was] operated on three

times. She was given the [pau d'arco] tea immediately after the surgery. She is doing very well."

In spite of all the pressure brought on them, the leaders of Santo Andre refused to forbid the physicians of their hospital to use pau d'arco; the hospital was then half empty because of the quick recovery of the patients receiving pau d'arco. But, as a compromise, the doctors were ordered not to make public declarations about the wonders of this herbal tea.

## M A T R I X   I I I

### INJECTION OF DRUGS INTO THE SOCIETY FOR SOCIAL MANIPULATION AND CONTROL

As we have seen in previously, the injection of specific kinds of substances into society is being done deliberately in order to achieve control over the human population. Specific effects of societal drugs, such as the opiates, cocaine/crack, alcohol, tobacco, marijuana, LSD, DMT, STP and designer drugs are designed to:

1. Limit the expansion of consciousness and awareness within select socio-economic groups.
2. Create an artificial situation where the presence of certain substances can provide the necessary "social justification" for legislation designed to suppress the social freedoms of specific groups within the overall population and the population in general.
3. Create a siphoning of monetary nature which reduces the economic position of specific groups, putting them in a more vulnerable position, while at the same time contributing to the monetary coffers of both agencies within the government and organized crime.
4. Create physiological disorder which contributes to the general destruction of the health of the people and also provides monetary gain for the medical monopoly, which is closely tied in with defense and banking interests.
5. Create a situation where, by virtue of all the drugs being pumped into the population, the nervous systems of the people are being modified and partially shut down in order to permit control of the population from an outside source, i.e., with electronics and through electronic surveillance.

Recent revelations about the BCCI and S&L banking "scandals" have connected the CIA to money laundering and drug running operations. These have been published in many newspapers during the last year. How did the involvement of the CIA in drugs start?

#### The CIA and Drug Trafficking

No chronicle of the world's important drug firms would be complete without relating the connection between drug firms and the world drug operations conducted by the CIA - operations referred to by some as "Dope, Incorporated". It

### M A T R I X   I I I

began with a small group of international financiers, headquartered in London, who officiated in the setting up of an "American" intelligence service, which was initially known as the Office of Strategic Services during World War II. This organization was set up under the close supervision of the British Secret Intelligence Service and was later disbanded by President Truman, who was highly suspicious of its operations.

The OSS then went underground at the State Department as a "research group" working on "behavioral theory". It was led by Evron Kirkpatrick, whose wife, Jeane Kirkpatrick, is a director of the Rockefeller financed League for Industrial Democracy. The Kirkpatrick group resurfaced as "the Central Intelligence Agency", headed by Allen Dulles, a partner in the Schroder Bank, the bank that had handled Adolph Hitler's personal bank account.

Dulles' brother, John Foster Dulles, was then Secretary of State under Eisenhower. Whatever interest the CIA may have had in "intelligence", it soon became clear that its primary interest was in the realization of the enormous profits to be made in the international drug trade - the same trade that had established British fortunes in the early 19th century.

The excuse advanced to justify going into this business was that Congress refused to advance enough money to the CIA to finance covert operations.

Bo Gritz, over the last several years, has revealed his knowledge of CIA drug operations uncovered during his stint in Southeast Asia and his interaction with one of the areas largest drug producers, Khun Sa. Khun Sa told Gritz that the blame for the world drug operations was on some of the CIA's leading operatives, including Theodore Shackley, who served as chief of station for the CIA in Laos from 1965 to 1975. Khun Sa stated that Shackley had worked closely with Mao Se Hung, who was then the leading drug smuggler in Southeast Asia. Another colleague to Shackley was Santos Trafficante, a leading figure in the Mafia. Trafficante became involved in the Pacific area of the drug traffic, becoming a go-between for the Nugan Hand operation, the drug bank in Australia and in the Golden Triangle.

Another person identified by Khun Sa and others as active in the drug trade was Richard Armitage, whose drug operations began during the Vietnam War. He moved to the U.S. Embassy in Bangkok after the war. From 1975 to 1979, according to witnesses, he used his embassy position to carry on drug operations. He then left that post,

### M A T R I X   I I I

establishing the Far East Trading Corporation in Bangkok.

Armitage was later appointed by Reagan as Assistant Secretary of Defense in charge of International Security Affairs, reporting directly to the Secretary of Defense, Caspar Weinberger. Business tycoon H. Ross Perot learned of Armitage's history and went to the White House, demanding that Armitage be fired. He talked to George Bush, who gave him the brushoff by sending him to FBI Director William Webster (shortly thereafter, Webster was quietly appointed head of the CIA). Webster refused to act on Perot's complaints, which opened the door for his appointment to the CIA post. Weinberger resigned. He was succeeded by Frank Carlucci, who was then serving as National Security Advisor, and who was well versed in the entire operation. Carlucci ordered Perot, whose fortune had been built on government contracts, to drop his crusade against Armitage. General Richard Secord was also involved. Secord surfaced as a figure during the Iran Contra affair, and had boasted of flying plane loads of gold to Southeast Asia to pay off drug smugglers. In March 1992 Perot indicated his desire to run for president.

Drug involvement in the Iran Contra affair should be a surprise for no one. It threatened to blow the lid off the Iran, Israeli, Swiss, and Rockefeller involvement in the importation of drugs into the United States, as well as the involvement of the military. The danger was put aside by causing the focus to be on Oliver North and Admiral Poindexter, who were portrayed in the media as "crusaders against Communism".

#### Tobacco: A Commentary

Tobacco: Primitive tribes have seemingly been smoking tobacco for hundreds, if not thousands of years with no apparent disagreeable effect that is mentioned anywhere in historical literature. Dr. Richard Passey, a researcher at London's Chester Beattie Research Institute, conducted twenty years of research on the tobacco problem. He found no significant link between lung cancer and traditionally air-dried tobacco that contains no additives. However, it becomes quickly apparent tobacco today contains a great many additives. The tobacco industries are dominated by firms controlled by the Rothschild banking empire; the primary additive in tobacco is sugar. England uses 17% sugar added as a drying agent - the United States uses 10% sugar. England also has the highest lung cancer rate in the world from smoking. Dr. Passey concluded that the addition of sugar to tobacco creates a carcinogenic substance within the nicotine tar; he found no trace of this carcinogenic substance in air-dried tobacco; lung cancer rates in the Soviet Union, China and Taiwan, who

# U.S. tobacco export is free trade in death

By Eric Mammoth 3-21-92

Loopholes abound in our government's policies. Some private corporations "play our free-trade laws and export policies like a Stradivarius violin," so says Dr. James Mason, a Bush administration senior health official. Like Sunkist and Pillsbury receiving millions of our tax dollars to promote their free-market products in overseas markets. Even the golden arches got a half a million dollars to ply their McWares around the globe.

What Dr. Mason was referring to, though, was how we assist the cigarette industry in this country with 3.5 million tax dollars a year to export tobacco worldwide. Those funds generated over \$50 million in sales overseas, according to Kirk Wayne, president of Tobacco Associates. He adds that there is a significant smoking population in the world with a growing demand for "high-quality American blend tobacco."

There is more here, however, than meets the eye.

Everyone knows that cigarettes are bad for you, causing a myriad of cancers in the body in addition to heart and lung diseases. American smokers are quitting in record numbers, yet more than 400,000 will die from tobacco-related diseases this year. Additionally, 2.5 million more will die worldwide as a direct result of smoking cigarettes. Rep. Peter H. Kostmayer, D-Pa., likens spending money on tobacco to exporting death.

A cigarette may appear to be nothing more than tobacco rolled in paper, and a pack of Marlboros in America lists the ingredients simply as "selected fine tobaccos." In France, that same pack of Marlboros lists the ingredients as 92 percent tobacco and paper and 8 percent agents of texture, flavor and preservatives. In Canada, a law passed in 1989 requires cigarettes sold there to list all additives and quantities by brands. That list was made available to the Canadian government by U.S. cigarette manufacturers but not to the public. R.J. Reynolds reformulated its brands for this northern market. Phillip Morris, the world's leading manufacturer, withdrew altogether from the Canadian market rather than disclose those additives.

So, just what is in that other 8 percent? Lists supplied by Canadian and British suppliers include: shellac, acetone and turpentine; acetaldehyde and glyoal (animal carcinogens); methyl asllylate, which causes birth defects in hamsters when given orally or topically; licorice root, containing glycyrrhizic acid,

producing cancer-causing polycyclic aromatic hydrocarbons when burned; catechol, a co-carcinogen and a byproduct of heated sugars used for flavoring; and other additives that strengthen the effect

of cancer-causing compounds when heated. The list of additives in American brands is filed in the Department of Health and Human Services and protected from public scrutiny by criminal penalties against anyone disclosing it.

Carla Hills, the U.S. trade representative, is the administration's principal adviser and spokeswoman on international trade policies and has aggressively helped export the products of the three largest U.S.-based transnational tobacco companies (Phillip Morris, R.J. Reynolds, Brown and Williamson) to Asia and Third World countries. These three companies created the U.S. Cigarette Export Association in 1981 and have successfully lobbied successive Republican administrations to open Asian markets via coercive leverage tied to those countries' exports to the United States.

Japan signed an agreement in 1986 allowing U.S.-based cigarette manufacturers a 100-fold increase in their market share at the behest of Sen. Jesse Helms, R-N.C., who alluded to anti-Japanese sentiment in upcoming trade negotiations. South Korea's cigarette market was opened up by Michael Deaver, an indicted Reagan administration official, who, after receiving \$250,000 from Phillip Morris, tied market concessions to textile protectionist legislation pending in Congress. Thailand, after several years of pressure, acceded to the political wranglings of Carla Hills, et al., that tied its canned tuna and furniture exports to increased U.S. tobacco company presence in its market, even though the World Health Organization supported Thailand's assertions that these imported cigarettes contained substantially more additives than local brands and so represented an increased health risk to its smoking populace.

In the same way that our government officials sanction and promote the aggressive expansion of the cigarette industry abroad, they could limit the export of this addictive product by supporting the proposed Tobacco Export Reform Act, sponsored by Reps. Chet Atkins, D-Mass., and Mel Levine, D-Calif. This measure would prohibit the U.S. government from using its influence to coerce other countries into importing American cigarettes and would also require the surgeon general's health warning on all exported cigarettes.

### M A T R I X   I I I

produce air-dried tobacco, were absent.

Additional research has been conducted on tobacco and cigarette additives since the Passey study which indicates that not only is the actual list of additives not available to the public, but that it is against the law to reveal them to the public. In 1984, legislation was passed which required cigarette manufacturers to "list health risks associated with smoking cigarettes containing any substances commonly added to commercially manufactured cigarettes." This only requires them to list health risks, not the ingredients. The Surgeon General's report said that data about additives was impossible to obtain, "because cigarette companies are not required by law to reveal what additives they use in each and every brand of cigarettes they manufacture. Congress reluctantly passed a law in late 1984 which *recommended* that cigarette manufacturers provide the Dept of Health and Human Services (HHS) each year with a list of additives used in cigarette manufacturing. The tobacco industry was successful in subverting that law to the point where they were allowed to get away with providing a "very general list of additives". These annual lists have been described by anti-smoking groups as "page after page of meaningless names". Later the tobacco industry got a provision entered into law which said the lists of additives were not to be published or made available to the public or research scientists, making it a crime to provide the information in the lists to anyone. Each year the tobacco industry gives H.H.S. its secret list and they lock it away from prying eyes. Early in 1991, Dr. Ronald Davis resigned from the government Office on Smoking and Health, and is on record as stating: "I think the consumers have a right to know what is in tobacco products, but I'm not allowed under law to release this information to the public."

There is a specific kind of chemical reaction that occurs when substances are combined and then burned, called a synergistic reaction. Due to this kind of heat related reaction, these substances combine to form cancer-causing compounds. What are these substances?

There has been some information about tobacco and cigarette composition which has filtered out of private research companies. There are many substances that go into the tobacco mixture that give it the characteristics that it has. Additives give tobacco an artificial "flavor", keep it soft and give it a special aroma.

Research has identified the following substances as being among those found in tobacco:

Sugar  
Acetone

0 1 5 2

### M A T R I X   I I I

Methyl Salicylate  
Turpentine  
Caramel  
Shellac  
Catechol  
Acetyldehyde  
Amino Acids  
Glycyrrhizic Acid

There are additives in the paper which are even more amazing, including ones which keep the mixture burning. A documented case of what might be in the paper came out when a doctor was invited several years ago to a facility that made cigarette paper. Before being shown around the facility he had to don a coverall made of a paper-like substance, which covered him completely. He was shown various stages of manufacture which included a sealed room that his guide referred to as the "impregnation room".

The doctor was allowed to keep the coveralls as a souvenir. Noting that the guide had muted responses to some of his questions, he had fine dust on the coveralls analyzed. The lab results came back showing that the substance which had collected on his coveralls at the cigarette paper plant was OPIUM.

Since a small amount of this substance can be highly addictive, it explains why hand rolled tobacco using other types of paper does not satisfy the craving that regular cigarettes do. Those cigarettes billed as "light" contain less tar and nicotine producing additives but more opium to compensate, since the combined addiction relates to both the opium and the nicotine, which is itself highly addictive and poisonous.

Because of the opium additive, the addiction to cigarettes would stimulate the 1st area of brain structure; people would be thrown into a continuous round of stress that is related to primitive areas of the brain in between cigarettes.

Like anything else in this society, what is kept secret from the public always appears to relate to what is not good for them. Even the FOIA will not breach this barrier....yet.

#### Other Culturally Used Drugs

Alcohol: Stimulates the 2nd brain structure and produces behavior patterns which function around the early emotional con games learned from parents, as a child, depress conscious awareness, and lock the individual to body-consciousness.

## M A T R I X   I I I

Heroin, Cocaine and Crack: Cause a return to a tunnel-reality which centers around the reptilian brain and a basic pain-pleasure survival game, which centers around flight-or fight reactionary mind states. Also locks person to body-consciousness.

Marijuana: Stimulates the 4th brain structure which breaks social consciousness patterns, which might not be so bad if there were learned experiences that would replace those patterns. Having no point to refer to, a return to similar patterns would occur. The THC is similar in composition to a neurotransmitter that would be released during a process of conscious evolution. Thus a state of consciousness is approximated but the learning and experience that would be achieved during the journey to that state would be lacking; it leaves the person expanded without any specific reference points. Significant lock to body-consciousness.

Pharmaceuticals: A variety of drugs are prescribed in allopathic medicine (treating the symptom as the cause). A great many pharmaceuticals, such as Valium and Librium, which represent billions of dollars in sales, are in actuality "neurological replacement drugs", as these substances are architecturally similar to naturally occurring enkephalins in the brain and will produce the same effect. It is interesting to contemplate the idea that the production of many natural substances in the brain could conceivably be blocked, on purpose, by some types of substances which are being administered to people, creating markets for similar substances that create enormous profits.

The U.S. Government once made a statement that over 65% of the pharmaceutical drugs have never been proved to be effective. If true, it only adds to the sad legacy that a deceived public must endure.

### Drugs and Mind Control Applications

Experimentation with drugs seems to have originated in the German schools of medicine, and was brought to the west by individuals allegedly connected with the group of Illuminati initiates who went about transforming the entire medical practice in the United States from a patient-oriented approach which involved the healing process to one where the patient became a subject for experimental programs.

This total commitment to science, as it were, guided



### M A T R I X   I I I

and inspired the CIA drug programs, Projects Bluebird, Artichoke, MK Ultra and MK Delta, in which some 139 drugs were used on unsuspecting people. These are covered to some degree in Matrix II.

After Allen Dulles returned to the United States to become director of the newly created CIA, he ordered 10kg of LSD from Sandoz, the stated purpose being "for use in drug experiments with animals and human beings." This lot of LSD was equivalent to 100 million doses. The National Institute of Health funded a grant to the Uris Foundation in New York which commissioned Tim Leary to do experimentation with psychedelic drugs, which he did from 1953 to 1956, when it was moved to the U.S. Public Health Service until 1958. From 1956 to 1963 there was an overlapping program at the Health, Education and Welfare (HEW) office. Some 1,500 military personnel were given LSD in tests run by the U.S. Army Chemical Corps, who also tested BZ, a powerful chemical hallucinogen, from 1959 to 1975 at Edgewood Arsenal.

One of the results of the CIA drug program was the death of John Kennedy, who had demanded that the agency get out of the drug business.

One character in the CIA backed mind control operation has not been discussed at any great length. Ewen Cameron, who was born in Scotland, moved to the US and became a resident of Lake Placid, New York. In 1943, Dr. Cameron received a grant from the Rockefeller Foundation to set up a new psychiatric Institute, the Allen Memorial Institute, which became the destination for more than \$10 million in CIA funds as part of the MK Ultra project. This money was transferred to Cameron in 1953, because of his commitment to mind-altering experiments. He invented some of the most terrifying techniques ever known, thanks to backing from the CIA and Rockefeller interests.

One of the techniques, known as depatterning, began with drugs and was then supplemented with electroconvulsive therapy, which has been described by victims as "the electrocution process, except that it was shut off before it became fatal". The use of ECT can still be seen at institutions in the United States. Barbaric? Of course.

Cameron also perfected techniques of sensory isolation and a process which he called "psychic driving", in which a person would be forced to listen to recordings many thousands of times. Because of his work and the backing from the CIA, Cameron was appointed as chairman of the Canadian Psychiatric Association, chairman of the American Psychiatric Association and a founding chairman of the World Psychiatric Foundation. So much for the myth of mental illness.

## M A T R I X   I I I

After Cameron's death in 1967, the CIA found itself besieged by some of the victims of Camerons' experiments. An issue of the *Washington Post* in January 1988 described a lawsuit by nine Canadians who were subjected to LSD work in the 1970's. The case still has not been decided and is still in litigation as of March 1992.

For at least the last fifteen years, the use of drugs for mind control operations has been in the operational phase, both for individuals who work in highly classified positions (such as the mind-altering treatments given to Robert Lazar) and substances distributed within the general population.

When we take into account all the information compiled about the government and drugs, we can say without any reservation that the government of the United States, with an ex-CIA director as President, will continue to be involved in criminal activities until another more reasonable approach is voted in by "conscious" human beings.

### *Sociological Trends*

It is interesting that the question never arises in social consciousness: Why is the president of the United States (former head of the Central Intelligence Agency) addressing the problem of drugs to the level of school children rather than to the huge conglomerate of drug smugglers and importers? The real problem is coming from the Office of the Central Intelligence Agency and the Oval Office of the Presidency. They apparently have it so finely tuned that many of the so-called "street people" are already under electronic control and can be used as "covert" operatives (the CIA term "useful idiots" best describes this situation) in that their behavior can be influenced as a disruptive social factor to induce the sway of public opinion on sociological issues that benefit the administration.

What we are beginning to experience is a country filled with controlled, essentially "brain-dead" people who are at the whim of a government who is ultimately able to pulse thoughts into the minds of the populace and have them act on these thoughts, since the state of consciousness for the majority of people does not permit adequate discrimination that would permit recognition of exteriorly implanted thoughts and concepts. This is not some paranoid, psychotic fantasy. It is technologically achievable and is currently being implemented. To see how, turn to Chapter 7.

What we are in the middle of sociologically in the United States is a silent war, a war with many components

of a chemical, bacteriological and electronic nature, that has as one of its objectives the shutting down of the physiological systems of the population to the point where they eventually will be unable to bear children, or the children will be so deformed and retarded it might result in legal statutes that mandate that individuals be "tested" before they will be permitted to have a child. The usual modes of parenting and conception by individuals will be bypassed.

The next area we will examine relates to the use of biological means to manipulate the population. Like the issues we discussed, a by product is the reaping of billions of dollars by corporate interests that are anti-life and have no interest in human welfare.

*CHLORINE IN WATER  
DEEMED TOXIC*

WEDNESDAY, APRIL 15, 1992 **AS**

*U.S., Canadian Panel  
Says Toxic Discharge  
Is Hurting Great Lakes*

WASHINGTON — A joint commission of the U.S. and Canada said in a report that the two nations have failed to meet their goal of eliminating the discharge of toxic substances into the Great Lakes.

In its sixth biennial report, the International Joint Commission recommended, among other things, that industries change their production processes to eliminate the production and discharge of toxic byproducts, and examine the use of chlorine and chlorine-containing compounds.

The commission, created under a 1909 treaty between the two nations, is charged with monitoring the progress of cleaning up the Great Lakes under an agreement signed by the two nations in 1978.

In its latest report, it specifically urged that industries and the two governments develop plans to phase out existing sources of toxic waste discharges into Lake Superior, one of the five Great Lakes.

**VETS TELL OF MUSTARD GAS POISONING:**

Veterans told a National Academy of Sciences panel Wednesday that they still suffer physical and psychological problems because they volunteered for the Navy's secret mustard gas experiments in World War II. "Seven days a week I go to bed with it on my mind," said Victor LaBate of Garrettsville, Md., who took part in the experiments as a 17-year-old Navy recruit. LaBate and others also told of physical ailments, including skin cancer, sight and hearing loss, shortness of breath and digestive ailments, that they believe are linked to the long-secret experiments. 4-16-92

Nitrogen fertilisers are blamed for causing disease and polluting the environment. To find out how true this is we need to know more about what happens to them in soil

# NITRATES IN SOIL AND WATER

Mike Sauls

**N**ITROGEN fertilisers have revolutionised agriculture in most of the world. They have helped us to gain more food from less land. But some people blame them for causing disease and polluting our rivers and seas. Finding out whether fertilisers really are to blame proves trickier than might at first appear. Farmers may add nitrogen fertiliser to the land but soil has a secret life, and can produce much more nitrogen. How and when it does so depends on the biology, chemistry and physics of soil, and on how we choose to treat the soil.

Nitrate from fertilisers finds its way into ground water, rivers, lakes and seas. Some medical researchers think that too much nitrate in drinking water causes disease. In fresh- and salt-water, nitrate can disrupt the ecology so much that some species of plants and animals die.

Yet, conventional agriculture cannot do without nitrogen fertilisers. Throughout the world in 1950, farmers used 14 million tonnes of fertiliser. By 1985, the figure had rocketed to 125 million tonnes. In the 24 Western industrialised countries that are members of the Organisation for Economic Cooperation and Development, farmers used 32 per cent more nitrogen fertilisers in 1985 than in 1970. The rest of the world, mostly poor by comparison, bought and used 120 per cent more nitrogen fertilisers in 1985 than in 1970.

Plants need nitrogen to make protein, as do all living things. They cannot grow healthily on soils that have too little of it. Lack of nitrogen causes them to become stunted. Their leaves turn pale, and they yield less produce.

About 78 per cent of the Earth's atmosphere is made up of nitrogen gas, and it was from this that the planet's first soils gained their nitrogen. Violent reactions, fired by

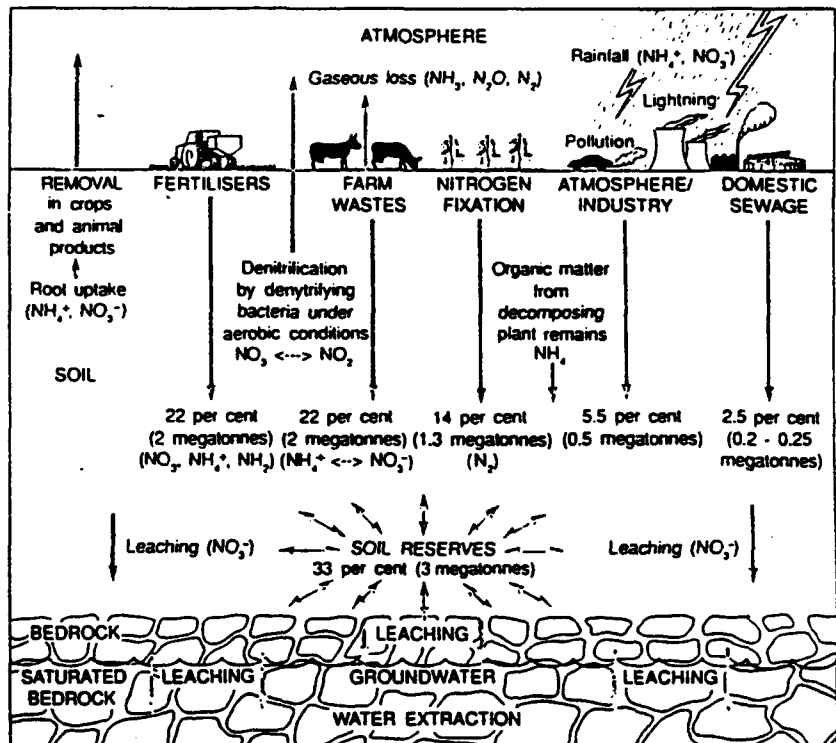

Nitrogen is in constant flux in and out of the soil. Part of it enters ground water, and thus into our drinking supplies. (Figures come from French research)

lightning in the intensely volcanic early planet, brought about the formation of ammonia and oxides of nitrogen. These soluble compounds would be rained out of the atmosphere and onto the Earth's surface. Later, as life evolved, nitrogen became converted into other, more complex compounds. Time and the processes of weathering created our primitive soils: nitrogen enriched them.

Plants cannot use nitrogen directly from the air. Instead, they take it in through their roots in the form of ammonium ions (NH<sub>4</sub><sup>+</sup>)

and as nitrates (NO<sub>3</sub><sup>-</sup>), which are both soluble in water. Water percolating through the soil tends to remove, or leach, nitrate. Over the centuries, farmers have learnt to counteract depletion of nitrogen from their soils by adding farmyard manure, and by growing crops in a certain order ("rotating" them). In recent decades, they have taken to adding manufactured nitrogen fertilisers to the soil.

Microorganisms, such as some species of bacteria, and algae can convert, or "fix" molecular nitrogen (N<sub>2</sub>) from the air into

Mike Sauls works for Agrafax PR in Shrewsbury and specialises in soils and agricultural scientific communication

All diagrams are by Peter Gardiner

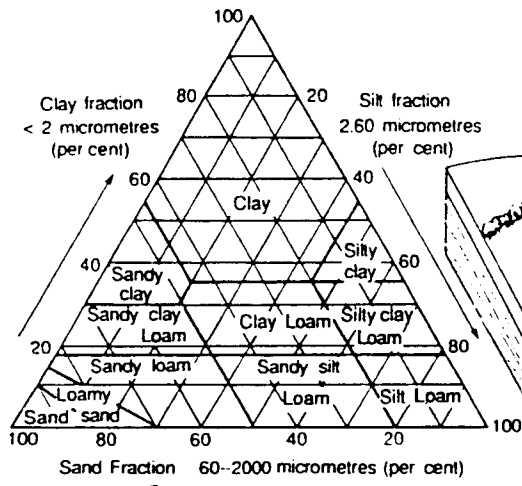

A soil's texture and permeability vary according to how much sand, silt and clay it contains. Its structure affects drainage, which in turn affects leaching

ammonium ions and thus make it available for producing protein. The best known of the nitrogen-fixing bacteria is the species of *Rhizobium* that colonise nodules on the roots of legumes, such as beans or clover. Farmers make good use of the fact that legumes are natural fertilisers, and sow pastures with a mix of grass and clover. By planting peas and beans before they plant cereals, they can depend on the nitrogen-fixing bacteria helping them to save on manufactured nitrogen fertilisers.

### Nitrates and health Blue-baby syndrome

TOO MUCH nitrate in drinking water can cause a blood disorder in babies younger than three months. The disorder is called **blue-baby syndrome**. The infant's lips and body take on a marked blue hue. The cause is that bacteria, either in an unsterilised feeding bottle, or within the child's gut, convert nitrate into nitrite (NO<sub>2</sub><sup>-</sup>). The haemoglobin in the baby's blood takes up the nitrite instead of oxygen: the result is that the baby suffers severe respiratory failure.

In Britain, the last reported case of blue-baby syndrome was in 1972, but the World Health Organization reported 2000 cases between 1945 and 1986. One hundred and sixty of these babies died. In most cases the babies had drunk water with more than 25 milligrams of nitrate per litre from private water sources. Of far greater significance was that their mothers had not sterilised the feeding bottles.

Some researchers believe that nitrites may cause cancer of the stomach and windpipe in adults. More recent studies have not confirmed this. In 1984, the British Medical Association reported that stomach cancer was becoming rarer in the very areas in which nitrate levels are high.

Statistics from other countries are conflicting. In China, in the early 1980s, 140 out of every 100 000 males died from stomach

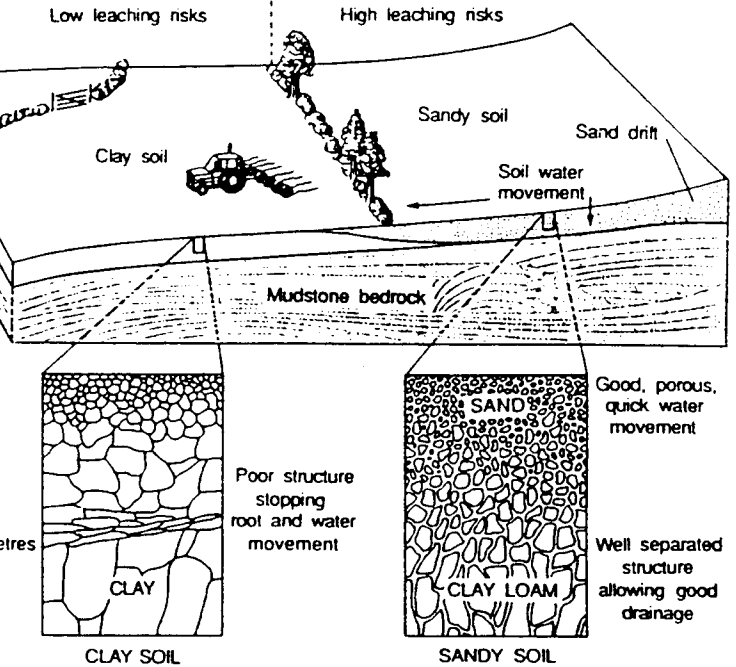

cancer. Areas in which the death rate was high also had higher than average levels of nitrate in drinking water and vegetables. However, researchers at the International Institute for Environment and Society in West Germany now question whether between 200 and 300 milligrams of nitrate per day are really a relevant health hazard.

Nitrates also act as fertilisers for aquatic plants. If rain washes nitrates out of soil into streams, rivers, lakes and then into the sea in excessive quantities, they can boost the growth of algae and other aquatic plants. This enrichment is called **eutrophication**, from the Greek *eutrophos*, meaning "well fed". Eutrophication is increasing in the rivers and lakes in many countries.

Eutrophication sometimes changes the balance of aquatic plants and animals so drastically that a particular species may be wiped out. The organisms that survive may grow so well that they clog waterways. Large amounts of nitrate do contribute to eutrophication but scientists claim that the main culprit in *freshwaters* is usually **phosphate**. (Most phosphate comes from industrial or domestic sources and not from agriculture.)

Algae, especially green algae, respond quickest to eutrophic conditions. When they grow rapidly on the surface they prevent light from reaching submerged plants, which may die as a consequence. Bacteria decompose the remains of any plants, algae and animals that sink to the bottom. The process uses up valuable oxygen and a vicious circle develops, drawing in all forms of aquatic organisms, until rivers, ponds and lakes become devoid of life.

In the Baltic Sea, eutrophication has increased the population of algae and the number of small plants and animals living on

seaweed. Less light reaches plants and animals living on the bottom. About 100 000 square kilometres of the Baltic Sea now suffers from a deficiency of oxygen.

Many people are worried about the pollution of the sea near coastlines. Proliferations of algae, or **algal blooms** as they are called, can cause great damage. As a result of nutrients from fertilisers washed into the North Sea in the summer of 1988, algal blooms almost wrecked salmon and trout farms off the coast of Norway. Local fish farmers lost an estimated US \$200 million. Toxic blooms were present in the North Sea once again this summer and also off the coasts of Denmark and Yugoslavia, and in the Irish Sea.

Although scientists have clearly shown that nitrates, and not phosphates, are responsible for algal blooms and plant growth *in the sea*, European countries continue to dump into the North Sea more than 1.5 million tonnes of nitrogen every year—two-thirds of it from rivers carrying agricultural runoff.

### Natural nitrogen reserves Microbes hard at work

FOR MORE than a century, a succession of researchers from all over the world have joined in an exhaustive set of experiments on soil nutrients, at Rothamsted Experimental Station, in Hertfordshire. They have treated Broadbalk Field, an experimental site at Rothamsted, with nitrogen fertiliser in the same way since 1843. They have also developed drainage gauges to compare the amounts of water and nitrate leaching from plots, left bare for more than a century, with those from other ones planted continuously

with a wide range of crops.

On unfertilised crops the researchers found that soils still leach 20 kilograms of nitrate nitrogen per hectare of land every year. Even under spring barley, which leaves the soil bare and more prone to nitrate leaching during the subsequent wet winter months, they found that only 7 per cent of the 80 or 120 kilograms of nitrogen they had applied was leached.

They conclude that if a nitrogen fertiliser is given in the correct dosage for a given crop it does not cause nitrate pollution. So where does the nitrate, found in increasing quantities in drinking water, come from? British researchers traced what happens to the nitrogen in the fertiliser by labelling it with the isotope nitrogen-15. They found that most nitrate in water comes from vast reserves of nitrogen that were held naturally in the soil before and while farmers introduced intensive practices. Researchers in Sweden have confirmed the British results. They found that whether or not they applied spring fertiliser to their experimental plots, the soil still released nitrate.

Undisturbed soils under natural vegetation can have nitrogen reserves of as much as 5000 kilograms per hectare. Most of this is held as insoluble nitrogen and comes from decomposed organic matter. Microbes convert this nitrogen to ammonium and then to the mobile nitrate form, not when crops need it, but when conditions suit.

Warm temperatures, moisture and aeration during cultivation encourage microorganisms to make nitrates. There is no evidence that fertilisers directly affect the amount of nitrate in water, but British researchers believe there are indirect effects. They think that adding nitrogen in fertilisers stimulates microbial activity. This, in turn, releases some of the nitrogen that is bound onto organic matter and otherwise not available for leaching.

## How much is leached? The answer lies in the soil

THE FATE of nitrate depends very much on the type and state of a soil, the influence of vegetation and the amount of rainfall infiltrating and percolating through the top layers.

Soils are a mix of differently sized mineral particles and a rich diversity of microflora and fauna. Sand, silt, clay, organic matter,

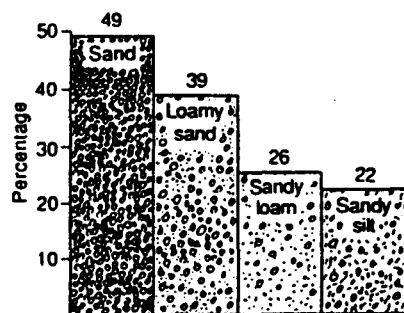

Estimated amount of nitrogen fertiliser likely to be leached below 50mm in specific soils after 100mm excess rainfall

## Drinking nitrates: the legal limits

IN 1975 the EEC issued a "Drinking Water Directive". It set a legal limit of not more than 50 milligrams of nitrate per litre of drinking water. This finally came into force in 1985. But almost all EC member countries fail the standard in some areas.

In 1986, Britain's Department of the Environment did a survey which found that 82 water supplies, serving 2.5 million people, breached the EC limit on one or more days. Last year, a nationwide survey in Britain showed that 74 water supplies, serving 1.6 million people, contained more than 50 milligrams of nitrate per litre of water, albeit not much more. However, the amount of nitrate by which supplies exceed the EC limit is increasing. This is particularly so in the main farming areas of Britain such as Norfolk, Cambridgeshire, Lincolnshire and Hereford and Worcestershire.

Five to 10 per cent of West Germany's drinking water—largely from boreholes, rather than rivers as in France and Britain—contain water with nitrates above 50 milligrams per litre. Average concentrations, however, are rising by between 1 and 2 milligrams per litre every year in areas that are cultivated intensively. The highest levels are from water beneath the lighter soils, much as those of northern

Germany around Hamburg and Bremen.

A study carried out for the French Ministry of Public Health revealed that 2 per cent of the population (1.2 million people) consumed water with more than 50 milligrams of nitrate per litre, and 0.6 per cent of the population consumed water containing more than double the EC limit. A later inventory in 1987 revealed that although fewer French people were drinking water with more than 100 milligrams nitrate per litre, more water contained nitrate in excess of 50 milligrams per litre. The wetter, more fertile north of France has the most nitrate-rich drinking water. Affected areas include the Nord-Pas-de-Calais, Brittany, the Paris Basin, the Loire country, Poitou-Charentes and Champagne-Ardennes.

Drainage of some Swedish wetlands has provided the country with some very productive soils that are rich in organic matter. About 10 per cent of the arable areas have soils containing more than 20 per cent organic matter and thus large reserves of nitrogen. Despite that—but only until recently—Swedish farmers applied fertiliser to soils in which reserves of nitrogen often exceeded the requirements of the crops grown on them. One result was the eutrophication of surrounding lakes and rivers. □

water and air spaces or pores make up the non-living and dead ingredients of soil. The relative mix of sand, silt, clay and organic matter determines its texture and consequently the way it behaves when water moves through the soil.

Clay particles are invisible to the naked eye. They are held together by strong chemical forces, which is why clay feels sticky. Silt particles are smooth and silky, like talcum powder. They range from 0.002 millimetres to 0.06 millimetres in diameter. Sand particles are large enough to see. Their size ranges from 0.06 millimetres to 2.0 millimetres. Larger ones are classed as stones. Organic matter in the soil is made up of the residues of plant and animal remains. It is usually concentrated in the top 10 centimetres of undisturbed soils, or to the depth they are cultivated by ploughs or other equipment.

A soil that contains sand, silt and clay in equal proportions is called a loam. The surfaces of particles of clay are negatively charged. They attract positively charged compounds and ions that move around in the soil solution. These positively charged species include the ammonium ion, calcium ( $\text{Ca}^{2+}$ ), potassium ( $\text{K}^+$ ) and hydrogen ( $\text{H}^+$ ). Nitrate stays in solution, free to move around within the soil.

Many tropical soils have a net positive charge which holds much of the nitrate in soil water. The amount of nitrate lost after rainfall depends on the number of positively charged sites, the speed of the reaction, the amount of water and its rate of movement. Tropical soils of the right texture and structure can be less of a leaching risk than

temperate soils. Researchers at the University of Reading calculate that it takes up to five times more rain to leach nitrate from a tropical soil than from a temperate soil with similar physical characteristics. But leaching is still important: reduced mobility of nitrate is offset by more rain.

## Not just cultivation Feel the texture

CULTIVATING crops has an enormous effect on nitrate leaching. Growing plants take up water and nitrate, thus tending to counteract leaching. However, at low temperatures in winter, or early spring, because they are not growing and transpiring, plants cannot use nitrogen. So, given sufficient rainfall, the soil is likely to lose more nitrate. In contrast, freezing hinders the flow of water movement through the soil and thus temporarily prevents leaching.

There are also big differences in how well crops keep nitrates in soils. Potatoes, for example, have shallow roots and need a lot of fertiliser. Farmers also need to apply water (irrigate) if they are to produce high yields. So, given the right type of soil, growing potatoes could lead to loss of much nitrate through leaching.

Wheat sown in the winter usually produces good deep roots and uses not only a lot of applied nitrogen but also much of the nitrate produced during the autumn by microorganisms acting on nitrogen reserves in the soil. Winter wheat also protects the soil from being washed away with the rains.

Soils vary in their ability chemically to

## How to save money on fertilisers and protect the environment

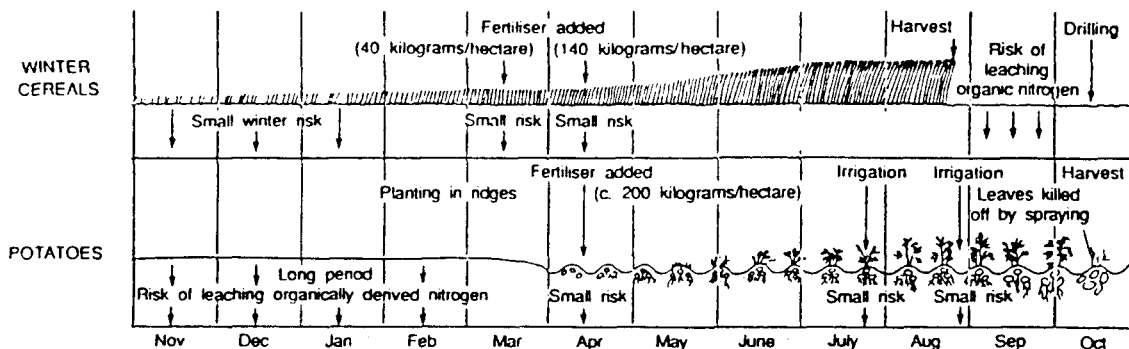

Leaching is influenced by the crops grown on the land and by the climatic conditions, and according to the season

**O**NCE farmers know more about the problems that nitrates can cause, they are likely to use fertilisers more wisely. Fertilisers are expensive, and it is in the best interests of farmers to reduce nitrate leaching. To do this, they need to know more accurately how much nitrogen individual crops need.

They should apply fertiliser only when the crop is most likely to use the nitrate. It makes more sense to wait until soil warms up in the spring, because that is when crops need nitrogen from the soil.

Dividing up fertiliser between February, March, April, May and occasionally June also makes financial sense. A heavy downpour in the early spring, for example, would lose only part of the total.

Cultivating crops that are sown in autumn would help to keep soil covered as well as using some of the nitrate naturally released in the soil. Alternatively, farmers can cultivate during the winter—and between main crops—quick-growing catch

crops to take up nitrate produced in the autumn. The catch crops can then be ploughed under prior to planting the next food crop in the spring.

Leaving soil undisturbed prevents aeration and microbial activity that would otherwise encourage the release of nitrates in the soil. At Maryland University, in the US, researchers found that planting without ploughing resulted in less nitrate being available for leaching. British researchers have since confirmed those findings.

Mixing in straw after harvesting instead of burning it provides microbes with a source of food: the soil provides them with the nitrates they need to make enzymes to break down the straw.

Organic farming, however wholesome its image, could increase the amount of nitrate available for leaching. Organic farming demands traditional sources of nutrients such as farmyard manure. Organic farmers also grow legumes such as clover to fix nitrogen from the air with the help of bacteria living

in the nodules on the roots. The farmers then plough in the legume/grass mix before they sow the next crop, to supply the crop with nitrates.

Both traditional and organic systems supply plants with the same form of nitrogen—ammonium and nitrate. But research has shown that while farmyard manure is as effective in producing high yields, it can give as much as 100 kilograms more nitrate per hectare to the soil than artificial nitrogen, and it is often put on land in the autumn.

Farmers also tend to mix manure containing ammonium nitrogen into the soil in the autumn. The result is that microbes start to convert ammonium to nitrate at a time when plant growth is slow and rainfall is high—conditions that encourage leaching. The same applies to ploughing in legumes—once again, nitrate will be released in a form more prone to leaching. Organic farmers must exercise skill and care if leaching is not to be increased. □

hold different forms of nitrogen. The amounts of sand, silt and clay plus the effect of different types of cultivation determines the soil structure, or the size and shape of the soil building blocks. The arrangement of such clods tends to determine how easily water passes through the soil, taking nitrate deeper and deeper.

Sandy soils, because they have little chemical bonding, are usually weak. They are easy to pull apart, or dig, and their clods can be broken down easily into smaller units. Sand particles are rather like ping-pong balls in a tank which are difficult to squash together and are separated by large gaps. Water can pass quickly through the gaps, and so leaching is rapid in sandy soils.

Clay soils are tightly packed and dense, like chunks of jelly in a tank. Water moves through them much more slowly. Leaching is therefore slower and water tends to form pools on the surface of clay soils, so nitrates often end up in surface waters rather than in ground waters.

Heavy downpours can lead to waterlogging, in which water displaces air from the pores within the soil. The resulting lack of oxygen in the soil encourages anaerobic organisms to convert nitrates to ammonium forms or to nitrogen gas. Clay soils hold water and offer less nitrate for leaching than do sandy soils. French researchers calculate that a clay soil loses seven to eight times less

nitrate than a sandy soil.

It is difficult to measure the effects of different underlying rock types on nitrate leaching, but some things are obvious. For example, the size and shape of pores and fissures in the rock govern the rate at which water moves into the zones of ground water from which it is extracted. (Ground water is the source of springs and wells, hence much of our drinking water.)

Nitrate levels in temperate countries including Britain, West Germany and France, are increasing. Tempting though it may be, we cannot blame fertilisers for all nitrate pollution. Even so, fears about the adverse health effects of consuming nitrates have prompted politicians to restrict the nitrate allowed in drinking water, rather than waiting for conclusive evidence. □

### FURTHER READING

*Nitrates: The Threat to Food and Water*, by Nigel Dudley (*Green Print* 1990) provides a review of the nitrates controversy. *Fertilisers food production and the environment* is a schools' guide from the Fertiliser Manufacturers Association (tel 0733 331303). Two features in *New Scientist* (8 October 1988 and 29 April 1989) present the latest research findings of the Rothamsted Experimental Station team on nitrates and leaching.

# Danger in fillings indicated

## Scientist parallels dental amalgams and lead poisoning

By Tom Paulson  
P-I Reporter

2-25-92

Despite safety reassurances from the dental profession and two federal panels, leading toxicologists yesterday said evidence still points to mercury in amalgam dental fillings as a potentially serious health threat.

A Food and Drug Administration official, speaking at a Seattle meeting of the Society of Toxicology, drew parallels between the evidence against lead poisoning 20 years ago and the evidence against mercury today. Lead has since been proven harmful to humans and removed from paint, pipes and many other materials.

New evidence indicates a need for more vigorous study of the possible risk posed by the release of mercury vapor from "silver" amalgam fillings, said Dr. Don Galloway, a scientist with the FDA's Center for Devices and Radiological Health in Rockville, Md.

Making an analogy to lead poisoning, he said the rule of thumb for safety in lead exposure used to be the point at which exposure caused obvious physical symptoms. But studies have since shown that chronic exposure to even low levels of lead, especially in children, can cause significant developmental and neurological damage.

"Lead was removed from paint in 1971," Galloway said. Mercury was removed from paint in 1991, he noted, asking the toxicology group meeting at the Washington State Convention and Trade Center yesterday to consider if there is a 20-year lag between understanding mercury toxicity compared with lead toxicity. About 3,000 toxicologists are meeting through Thursday at the center.

"There are some striking similarities in the history," he said.

Galloway was careful not to say the mercury vapor emitted by the amalgams (the fillings are made of a mercury and silver alloy, along with other metals) has been shown to be harmful. Based on evidence, Galloway does not intend to have his own amalgam fillings replaced, but said he would prefer his children receive alternatives when possible. Common alternatives are plastic composites or porcelain fillings.

Scientific panels, one sponsored by the FDA and another by the National Institutes of Health, have said there is no evidence of a health threat posed by amalgam fillings.

But another toxicologist at the meeting, one whose work likely prompted the creation of both federal panels, said the dental profession and the U.S. regulatory system are choosing to ignore the data.

"These were preordained conclusions (of safety)," said Dr. Fritz Lorscheider from the University of Calgary in Alberta.

Lorscheider and his colleague, Dr. Murray Vimy, were the latest to renew the flap over dental amalgams with the 1990 publication of a study that reported reduced kidney function in sheep fitted with the fillings. Featured on CBS' "60 Minutes," the study was attacked by dentists and others who noted that sheep chew much more than humans. Critics also noted the sheep received their 12 fillings at one time, which would be atypical in humans.

But yesterday at the Seattle conference, Lorscheider reported finding similar data in monkeys, which chew like humans, and other evidence indicating that the standard methods of measuring mercury exposure give inaccurately low readings.

Most studies of exposure to mercury have based their measurements on blood and urine concentrations, Lorscheider said. New studies indicate that much of the mercury is retained in tissue, especially in the kidneys and liver, he said.

"There is an impairment in kidney function in animal studies," Lorscheider said. He added that certain regions of the brain also appear to concentrate mercury.

If mercury-silver amalgams were to be proposed today as a new medical or dental device, he said the scientific evidence of potential risk would be enough to prevent them from ever reaching

the market.

"Dental amalgam is a major source of mercury in the general population," Lorscheider said.

Other speakers at the panel on amalgams yesterday generally supported the contention that dental amalgams could pose a health risk.

But several in the audience, some of them dentists, questioned the validity of some of the research.

An epidemiological study by a researcher at the National Institutes of Environmental Safety and Health purported to show reduced fertility in dental assistants with high exposure to mercury. The scientist said other factors affecting fertility had not been ruled out.

## mercury

The News Tribune

2-25-92

Although in use for more than a century, questions remain about the long-term health effects of mercury vapors released from dental fillings, a researcher said Monday at a national toxicology convention in Seattle.

"What there hasn't been is a lot of research on the long-term effects of low-level mercury vapor," said Dr. Don Galloway of the U.S. Food and Drug Administration, who chaired the symposium at the Washington State Convention and Trade Center. "No amount of review or expert opinion should substitute for more research."

Studies have shown that mercury can pass from the blood into the brain, through the placenta from a mother to a developing fetus and into breast milk, according to Rowland.

Mercury vapor is released from fillings during chewing or grinding or brushing teeth and is the most common source of mercury found in humans, other scientists at the symposium said. Amalgam fillings are typically composed of about 50 percent mercury and 35 percent silver, with the balance consisting of tin, copper and zinc.

Some 200 million Americans have mercury fillings in their mouths.

Andrew Rowland, a researcher with the National Institute of Environmental Health Sciences in North Carolina, said he and others recently found a reduced fertility rate and a higher-than-average rate of spontaneous abortions among dental assistants who prepare large amounts of mercury-amalgam fillings.



Chapter 6

POPULATION MANAGEMENT THROUGH USE OF  
BIOLOGICAL ORGANISMS

The Concept of "Infectious Disease"

It would appear that the concept of "infectious disease" is based on some rather archaic research, and has led to the establishment of dogmatic institutions within society. Most of the principles which form this concept have their origin with the work of Louis Pasteur and Robert Koch, work that was performed in the last half of the 19th century. It also appears that the general failure of medicine to deal effectively with the concept of "disease" has its origin in faulty research.

Pleomorphic Life Forms

One concept that "modern" biological science observes but refuses to valify within their own minds is the concept of pleomorphism, which refers the ability of one species of organism to change into another species or type of organism. One individual who pointed this out was Gaston Naessens, a 68 year old Canadian microbiologist, who discovered that there were smaller living organisms than bacteria (not including viruses) that lived in human blood. He termed these living organisms "somatids". Somatids are pleomorphic organisms; they can change into other life forms, such as bacteria and yeasts, during specific cycles of development. This is an important factor, because "modern" medical science is only geared toward addressing "exterior monomorphism" (stable exterior lifeforms) and not the existence of pleomorphic organisms that exist in human blood. Naessens made this discovery around 1949, when he invented a highly advanced dark-field microscope.

Naessens was not the only one to discover the existence of other type of lifeforms in human blood. Pasteurs rival, Antoine Bechamp, termed the organisms he discovered "micro- zymas". Pasteur, on his deathbed, seemed to support this view, for he declared that "the microbe is nothing; the terrain is everything", which explains why robust immune systems don't get plagues of exterior diseases. One of Bechamps observations was that microzymas in dead bacteria were living, and that the organisms seemed to be of a novel nature. Bechamp also was the original discoverer of enzymes, but was not credited with it, since his other work would have eliminated the deceit and profit associated with "modern" medical

"It's one goddam thing after another."



## M A T R I X I I I

practice; it was better to let his name fade into non-existence.

Between World War I and World War II, a German zoologist named Geunther Enderlein discovered what he called a "totally new observation of the microbiotic world" and noted that it featured the phenomena of pleomorphism. In 1925 published *The Life Cycle of the Bacteria* and outlined what he had discovered. Since he was the curator of the museum in Berlin, his work should have been received around the world. It has also been ignored. Enderlein delineated many different pleomorphic development phases of bacteria and showed that illness and healing processes are bound to exact cyclical and morphological laws. Enderlein unequivocally asserted that while different organisms normally live within the body in a mutually beneficial symbiosis, with severe deterioration of the environment of the body (a main result of the factors thrust on humans discussed in previous chapters) they develop into disease-producing forms and create what is essentially a fault in the life process.

Wilhelm Reich observed the existence of "bions" in living organisms that were apparently the basis of life. He was imprisoned by the U.S. government and died in prison in 1964. Most of his books were gathered up by the government and burned.

Now, the work of Naessens opens new vistas on the work of Reich, Bechamp, and Enderlein. Canadian officials plan on putting Naessens, 68, through a third trial for "practicing medicine without a license". Will Naessens books also burn?

When todays "researchers" discover microbes that are associated with cancer states, for example, the microbes are each given their own name, creating a kind of "Tower of Babel"; instead of looking upon the appearance of the alien forms as an indicator of an approaching disease state, they are held to be the cause of the disease. How many time have we been told another "cancer virus" has been discovered, only to have the discovery fade into oblivion?

The research of Naessens has been going on for about 50 years. His "somatid" discovery has, like the discoveries of others in the same area, the potential to rock the medical establishment. A tiny drop of blood can reveal the condition of both the blood and the organism it came from by the numbers and nature of somatids, which are always present in the fluids of living creatures in the plant and animal world. A newborn child's blood is teeming with active somatids, which in a healthy bloodstream go through a three-phase life cycle. The somatids, according to

## M A T R I X I I I

Naessens, are the precursors to DNA and are the link between energy and matter; Reich held a similar view about bions when he called them the link between living and non-living matter.

Whenever healthy blood undergoes deterioration, whether through injury, toxins, pollution, drugs or other external impositions, the normal three-phase life cycle of the somatid becomes a 16-phase cycle replete with bacterial and yeast life forms that can actually parasitize the body, which then becomes a "host". They do not in fact cause disease, but mark and identify disease states and promote disease conditions.

There is a videotape and a book that is available about the somatids. Both are available from Carotec, PO Box 75337, St. Paul, Minnesota 55175. The book is \$14.95, postpaid, and the 55-minute videotape is \$55.

### The Immunization Gambit

The term "immunization" was derived from the belief that the injection of a foreign body of infection into the human system (which already possesses a natural immune system) will confer life-long immunity from a specific disease. The word immunization is synonymous with the word innoculation. Despite this belief, there has always existed the observation that immunizations cause disease, and it is considered heresy in the medical community to make mention of this fact.

Immunizations also are responsible, according to some medical experts, for many health problems. Dr. Herbert Snow, senior surgeon at the Cancer Hospital of London, once stated that immunization or inoculation causes permanent disease to the heart. This information, according to author Eustace Mullins, also exists in the Library of Congress, buried.

### Judicial Awards For Vaccine-Caused Injury

A recent court case in Kansas is only one example of how "immunizations" can be deadly. An eight year old girl was awarded over \$15 million in damages after receiving a DPT (diphtheria-pertussis-tetanus) immunization which gave her permanent brain damage at the age of three years old. The producer of the DPT vaccine, Wyeth Laboratories, attempted to deny that the damage was caused solely by the DPT vaccine, but the lawyers proved their case to the satisfaction of judge and jury (1990 Graham vs Wyeth Labs).

## M A T R I X I I I

The magazine Science is well known for its exposition of scientific discoveries in the areas of medicine. In the March 4, 1977 issue, researchers Jonas and Darrell Salk warned that, "Live virus vaccines against influenza or poliomyelitis may in each instance produce the disease it intended to prevent...the live virus against measles and mumps may produce such side effects as encephalitic (brain damage)."

In the magazine Health Freedom News, July/August 1986, an article noted that "Vaccine is linked to brain damage. 150 lawsuits are pending against DPT vaccine manufacturers seeking \$1.5 billion in damages."

At the annual AMA Convention in 1955, the Surgeon General of the United States, Leonard Scheele, said that "no batch of vaccine can be proven safe before it is given to children." James R. Shannon of the National Institute of Health declared that "the only safe vaccine is a vaccine that is never used."

In the United States and many other countries, there are compulsory immunization programs for children. Because of the financial prospects, physicians are asking that children be vaccinated earlier in their lives. It is no small coincidence that the agencies responsible for the promotion of immunizations, such as the CDC, FDA, AMA and the WHO are also involved with the large drug firms who make it their business to treat the diseases the vaccines cause. It is also these same agencies that have drafted the procedures which forced the states to enact compulsory immunization legislation. Interestingly enough, in the early 1900's, physicians were more vocal on the dangers of the immunization process.

In 1909, Massachusetts enacted Bill No.8, which was an "Act To Prohibit Compulsory Vaccine"; a legislative triumph, to be sure. In order to prevent such logical and rational thought from gaining a foothold, Rockefeller interests perfected the means for controlling every state legislature in the United States by setting up the Council for State Governments in Chicago. No state legislature has ever failed to follow its dictates.

### The Smallpox Gambit

In the 1800's Edward Jenner "discovered" that cowpox vaccine would supposedly inoculate persons against the 18th century scourge of smallpox. In fact, by the time Jenner made this "discovery", smallpox was already on the wane. After the use of cowpox vaccine became widespread in England, a smallpox epidemic broke out which killed over 22,000 people. The epidemics became worse each year that

## M A T R I X I I I

the vaccine was used. In 1872, over 44,000 people were killed by it. England finally banned the vaccine in 1948.

Japan initiated compulsory vaccine for smallpox in 1872. Within twenty years, there were over 165,000 cases of smallpox; these resulted in the death of almost 30,000 people.

Germany, during the Nazi regime, instituted compulsory immunization for diphtheria. In 1939 the diphtheria rate went up to 150,000 cases. Norway, which never had compulsory immunization, had only 50 cases for the same period. During the Franco-Prussian War, every German soldier was vaccinated against smallpox. The result was that 53,288 otherwise healthy men developed smallpox.

### Polio Vaccine

The most unknown victim of polio was my own father; the most famous polio victim was Franklin D. Roosevelt. In 1931, during the annual polio epidemic, Roosevelt officially endorsed an "immune serum" which was a precursor of the polio vaccines of the 1950's. The serum was sponsored by Dr. Lindsly Williams, director of the New York Academy of Medicine, which was built by the Rockefeller and Carnegie Foundations. After Williams announced during the FDR campaign that Roosevelt was fit to be President, Williams was appointed the Secretary of Health. The "immune serum" against polio was known to be dangerous and worthless when Roosevelt endorsed it. The National Health Institute of the U.S. Public Health Service had experimented with monkeys for three years using this identical serum. The serum was used and several children died from it.

The New York State Commissioner of Health, who owed his appointment to Roosevelt, refused to hold hearings to validate the serum, while Roosevelt continued to reap the rewards of "charity" from his Warm Springs Foundation and his annual birthday balls celebrating the polio epidemic. In 1948 it was discovered that the intake of sugar had a direct relation to the virulence of the polio outbreaks. Cases fell tremendously, after this was briefly publicized. By 1950, people forgot this fact, and the polio toll rose to the 1948 level. Polio has increased 700% in states which have compulsory immunization.

There were a considerable number of lawsuits filed against drug companies in connection with the various types of polio vaccine. A suit involving Type - Sabin Polio Vaccine was filed against Wyeth Labs and was judged in favor of the plaintiff. A suit against Lederle Lab

## M A T R I X I I I

involving Orimune Vaccine was settled in 1962 for \$10,000.

In two cases involving Parke-Davis Labs and their polio product Quadrigen, the product was found to be defective. In 1962, Parke-Davis halted production. Dr. William Kock declared that "the injection of any serum, vaccine, or even penicillin has shown a very marked increase in the incidence of polio, at least by 400%."

Polio vaccine has now been accepted as a fact of life by the American public, which derives considerable comfort from the gradual disappearance of the annual scare campaign at the beginning of each summer. On January 26, 1988, the Washington Post featured a story that reported on a national press conference held in Washington where it was reported that all cases of polio since 1979 had been caused by the polio vaccine. It said, "In fact, all the cases in America come from the vaccine. The "naturally occurring" (or "wild type") polio virus has not been shown to cause a single case of polio in the United States since 1979." Despite this, the Post reported that "no radical change is expected. The status quo is very appealing, according to conference chairman Dr. Fred Robbins.

Cutter Laboratories, a subsidiary of Bayer A.G. in Germany (a spinoff from I.G.Farben), was a California firm which was set up to produce polio vaccine in order to protect the Rockefeller controlled drug firms from lawsuits. Most of the faulty polio vaccine was said to be produced by Cutter.

### Influenza Vaccine

It was in 1918 during the First World War that immunization for influenza was compulsory for all servicemen. That was the same year of the "great flu epidemic". Military hospitals in 1918 were filled with more men who were casualties of the flu vaccine than from actions that were attributed to war. The epidemic was termed "the Spanish Influenza", a term intended to conceal its origin.

The influenza epidemic of 1918 claimed over 20 million lives; those who survived it were those who had refused the vaccine. It began at a military base in Kansas.

According to the 1991 Edition of the Physicians Desk Reference, the annual flu vaccine, Fluogen, is made by the firm of Parke-Davis Labs. The formulation is derived from the recommendation of the Office of Biologics, Federal Drug Administration. The basis for each years formulation by the FDA remains unknown. During the winter of 1991/92 there were record pleas for people to get vaccinated for the flu virus (as there are each year). It was also a

## M A T R I X I I I

record year for people who were killed or incapacitated from the flu vaccine. Coincidence?

### The Great Swine Flu Massacre of 1976

On April 15, 1976, Congress passed Public Law 94-266, which provided \$135 million to pay for the national swine flu inoculation campaign. Under this campaign, which was heavily promoted by President Gerald Ford, the Department of Health Education and Welfare distributed the vaccine to state and local health agencies on a national basis so that individuals could get vaccinated at no charge.

On the surface, this might appear to be the height of altruism, but in actuality it was one of the largest and most scandalous public deceptions ever thrust on the American public. Research indicates that the swine flu vaccine was originally developed for use in the swine breeding industry. Swine breeders were wary of vaccines because they had noticed a parallel developing with human vaccines where individuals would acquire the disease the vaccine was developed to prevent. Swine breeders were also stunned when vaccinated pigs collapsed and died. They feared decimation of their herds because of the vaccine; the breeders balked, so the drug manufacturers turned to the Centers For Disease Control in Atlanta for help in recouping the monetary investment - marketing the swine flu vaccine to humans.

The Swine flu campaign sponsored by President Ford got off to a bad start when Dr. Anthony Morris, director of the Virus Bureau at the Food and Drug Administration, declared that "there could be no authentic swine flu vaccine" because there had never been any cases of swine flu on which they could test it. He then went public with a statement as to the lack of effectiveness of the vaccine.

In order to control the damage to the program done by the public revelations of Dr. Morris, a television program sponsored by CBS was aired. It featured President Ford, who put forth urgent pleas to the American public to get themselves vaccinated against the dreaded "swine flu".

Ford spoke to as estimated 215 million people in that broadcast, and like lemmings over a cliff they filed down to their local health agencies and were injected, despite statements by various major insurance companies that they would not insure the drug firms against possible lawsuits from the vaccine. It didn't take long for lawsuits to occur. Within two months, claims totaling over a billion dollars had been filed by people who experienced a



## M A T R I X I I I

strange, creeping paralysis induced by the vaccine. Since this kind of paralysis was a new development, referred to as Guillain-Barre Syndrome by the medical establishment, there have been speculations that the epidemic of AIDS which began shortly after Fords public assurances about the swine flu was a variation of the swine flu vaccine. In Matrix II, however, we presented a document which was the title sheet of the 1970 Defense Appropriations Bill (for 1971) in which \$10 million was set aside for the development of a retro-virus that humans would have no immunity against - essentially a biological weapon. There is also an extract detailing some of the conversation that occurred between some of the members of Congress who were discussing this matter. Based on the apparent evidence, you must decide for yourself about the origin of AIDS. One thing for sure - with the consistent track record of lies and deceit that the government and the medical establishment has handed the public over time, you can be sure that whatever they are telling you isn't the case.

### Connections Between Smallpox Vaccine and Cancer

Another aspect of the smallpox vaccine is its possible relationship to the spread of various forms of cancer. A physician by the name of Dr. W.B. Clark in Indiana finds that "cancer was practically unknown until compulsory immunization with cowpox vaccine began to be introduced. I have had to deal with at least two hundred cases of cancer, and I never saw a case of cancer in an unvaccinated person." Despite this revelation, the American Cancer Society will not follow up on this lead.

At the annual American Cancer Society Science Writers Seminar, Dr. Robert W. Simpson of Rutgers University warned that "immunization programs against flu, measles, mumps, and polio may actually be seeding humans with RNA to form proviruses which will then become latent cells throughout the body...they can then become activated as a variety of diseases including lupus, cancer, rheumatism and arthritis." This reflects very closely what Dr. Herbert Snow of London had noticed. The vaccine, in effect becomes a time-bomb in the system, festering as what are known as "slow viruses", which may take ten to thirty years to become virulent. When the time comes, the person is felled by a fatal onslaught, often with no prior warning, whether it is a heart attack or some other disease.

## M A T R I X I I I

### Covert Research in Biological Weapons for Population Management

There have been programs going on behind the scenes that the public is generally not aware of to produce a series of substances generally capable if the complete destruction of whole populations. There are indications that Fort Detrick has been conducting this kind of work under the cover of cancer research. Colonel William D. Tigertt, former commander of the Army's medical unit at Fort Detrick, stated:

"Those who would increase the potency of biological weapons must search for improved methods of mass production of organisms, factors which will enhance the virulence, ways to prolong the storage life of living agents, ways to improve aerosol stability, and methods of producing variant organisms by recombination or by other means."

This is the general mind set we are dealing with in the United States government. How did this process slip by the public? In 1969, Nixon ordered a halt to offensive biological warfare (BW) research and weapons stockpiling by the United States. The U.S. Army was directed to destroy its toxins, viruses, and bacteria (supposedly) with heat and disinfectants by May 1972; the planned "disposal" of the scientific personnel associated with the program was not so easy. Some of these "biowarriors" went to the CIA. Others quickly found new support from the National Cancer Institute (NCI), particularly in its Virus Cancer Program (VCP).

The NCI funded and supervised some of the same scientists, universities, and contracting corporations (supposedly for cancer research) which had conducted biological warfare research. Some of these medical research contracts ran simultaneously with the U.S. Biological Warfare program. When the military work ended, the civilian programs continued to expand on the same critical areas outlined by Colonel Tigertt.

The NCI Viral Cancer Program - a highly politicized public relations effort - was launched in 1971 (the same year that the AIDS virus was allegedly created under a mandate from the WHO) with great fanfare as part of the "war on cancer" sponsored by Nixon. The stated aim of the program was to organize experiments aimed at finding the "viruses that cause cancer". Apparently this dubious agenda was compatible with the incorporation into the various units of the VCP of dozens of former U.S. BW researchers who continued to study topics with potential military application. Potential cancer-causing viruses

## M A T R I X I I I

were collected, grown in huge amounts, and distributed through the VCP; thousands of animals were infected in experiments, and the *aerosol distribution* of cancer-causing viruses was also studied.

Two former BW facilities would play a large part in the VCP. The U.S. Army's Fort Detrick in Frederick, Maryland has been the "parent research and pilot center for biological warfare." During the 1960's, the CIA paid the facility \$100,000 a year for BW and chemical agents and their delivery systems. In Oakland, California, the Naval Biosciences Laboratory was involved in early work with the plague and collaborated in *massive open-air tests of biological warfare "simulates" in the San Francisco Bay Area in the 1950's.*

From 1953 to 1968, the University of California, while managing the Naval Biosciences Lab (NBL), also had BW contracts with the Army. After U.S. Treaty obligations under the Geneva Convention Agreement of 1972 took effect, work of this kind would prohibit open research on mass production of dangerous viruses without a medical "cover".

The Viral Cancer Program provided an ideal "cover" for continued work. One of the first new priorities of the Fort Detrick facility after the ban was the "large-scale production of oncogenic (cancer-causing) viruses."

Within a year, the NCI began mass production and within one 15 month period ending in June 1977, five years after the U.S. had signed an agreement not to produce these products, the VCP produced 60,000 liters of cancer-causing and *immunosuppressive viruses*. Throughout the 1970's, U.S. "defensive" BW efforts were increasingly aimed at the research and development of viral disease agents.

The Viral Cancer contract ran concurrently with the Naval Biosciences Laboratory's work on bubonic plague, Rift Valley fever, and meningitis. The NBL also performed much of the original research into the plague during World War II. In retrospect, it seems that the Navy has had top funding for every field of science, including research in gravitation and other areas in physics and biology, since it has always been the key factor in the defense of the United States since its very inception. You will recall that the Navy has had apparent roles in the alleged work at Dreamland on alien craft and had an important part in all the Project Rainbow and Phoenix Projects.

The Naval Biosciences Laboratory Cell Culture Project was supervised for the VCP by Dr. James Duff and Dr. Jack Gruber. Duff had been a microbiologist at Fort Detrick for 12 years before joining the NCI. His biography lists

## M A T R I X I I I

research into clostridium botulinum toxins and psittacosis vaccines. Botulinum toxins cause botulism food poisoning and are among the most toxic substances known. It was during the period when Duff was at Fort Detrick that the U.S. Army stockpiled botulinum toxin weapons.

After serving for eight years at Fort Detrick, Gruber moved to the NCU. His biography lists work on "arthropod borne viruses". The United States stockpiled BW weapons based on one arthropod-borne virus and studied many others. In 1984, Gruber became head of the Cancer Etiology Division of the National Institutes of Health.

After the ban on offensive BW research, the National Cancer Institute and the Office of Naval Research jointly sponsored experiments on the aerosol properties of potentially oncogenic viruses. The NCI project officer and former U.S. Air Force virologist, Dr. Alfred Hellman, worked with Mark Chatigny, a research worker at NBL and a member of the NCI biohazards work group from the NBL.

Hellman also oversaw the 1971 \$100,000 study on the "physical and biological characteristics of viral aerosols". In 1961, the NBL had done similar research for Fort Detrick on the "stability and virulence of BW aerosols." Chatigny's NBL research into aerosol distribution of viruses would continue into the 1980's. Such overlapping of purposes raises serious questions about the wisdom of placing control of VCP viruses under the NBL.

The pattern of overlapping military BW and NCI work was paralleled by the relationship between industrial contractors and the Viral Cancer Program. Charles Pfizer and Company, a pharmaceutical firm, had a contract with the NCI which included production of "a large quantity of a variety of viruses" for the VCP. The immunosuppressive Mason-Pfizer monkey virus was grown in large quantity, and other animal cancer viruses were adapted to grow in human cell lines.

During the same period - 1961 to 1971- as the NCI contractor, Pfizer conducted a secret study for the U.S. Army "into the growth and culture media for unspecified biological agents."

As of January 1992, Pfizer is the sixth largest drug company in the world. It does over \$4 billion a year, according to Standard and Poor's. The company banks with Rockefeller's Chase Manhattan Bank. Pfizers chairman, Edmund T. Pratt, Jr., was controller of IBM from 1949 to 1962; he is now a director of Chase Manhattan Bank, GM, and International Paper. Some of the directors of Pfizer are Grace J. Flippenger, secretary-treasurer of the \$10



---

## Experienced Statisticians

## Pharmaceutical Research

Salary range £14,000 - £25,000  
depending on experience

*We are one of the world's foremost and highly-respected pharmaceutical companies with an exciting array of new medicines being launched on world markets and more new products being discovered and developed than ever before. As a result of our success, we now have career opportunities for experienced statisticians to work within our creative research environment.*

Our Biometrics Department, currently 46 strong, is an expanding department of highly qualified and experienced statisticians and data managers. If you join us, you will be able to apply your statistical skills within a multi-disciplinary team and take advantage of our excellent computing facilities based on a VAX cluster, using statistical packages such as SAS, GENSTAT and BMDP.

As a statistician with Pfizer, you will either provide consultancy support to discovery scientists, or contribute fully to clinical project teams progressing human medicinals through phases I to III of clinical development. If you prefer, you could be an integral part of a specialist biometrics support group.

You should preferably have a degree in statistics and at least three years' experience working as an applied statistician in a biological or medical area. You will need to have the ability and desire to communicate statistical concepts within our environment.

We offer a broad and challenging role and place strong emphasis on training and personal development, to help each individual fulfil their potential.

*Located on a modern and expanding research campus near the historic town of Sandwich, our rural coastal setting allows easy access to the City of Canterbury and the Continent. We have an active Sports and Social Club with first-class facilities. We offer generous relocation expenses and an excellent benefits package, including a performance-related bonus. Your highly competitive initial salary will depend on your experience.*

*If you would like to find out more about career opportunities in statistics with Pfizer, please write enclosing a CV to: Mrs Fiona Cox, Personnel Officer, Pfizer Central Research, Ramsgate Road, Sandwich, Kent CT13 9NJ. Tel: 0304 618777.*



**Central Research**

## M A T R I X I I I

billion a year NYNEX Corporation and Paul A. Marks, chief of the Sloan Kettering Cancer Center since 1980 and a director of cancer treatment at the National Cancer Institute, director of the American Association for Cancer Research and a director of the \$100 million Revson Foundation.

In 1971, when Nixon announced that Fort Detrick would be converted into a center for cancer research, the buildings were decontaminated and the facilities were turned over to the NCI, which renamed the facility the Frederick Cancer Research Center. Litton-Bionetics (formerly Bionetics Research from 1966-1968) was named as the prime contractor. Litton Bionetics worked extensively on the *disperion of BW agents from aircraft*, and included Air Force contracts for "the supersonic delivery of dry biological agents".

One of Bionetics Research Laboratories' most important NCI contracts was a massive virus inoculation program that began in 1962 and ran until at least 1976, and used more than 2,000 monkeys. Dr. Robert Gallo, the controversial head of the current United States AIDS research program at NCI and Dr. Jack Gruber were project officers for the inoculation program. The monkeys were injected with everything from human cancer to rare viruses in an *effort to find a transmissible cancer*. Many of these monkeys died from immunosuppression after infection with the Mason-Pfizer monkey virus, *the first known immunosuppressive retrovirus* - an class of viruses that includes the *human immunodeficiency virus*.

Under these programs, "species barriers" were routinely breached in efforts to find or *create* infectious cancer viruses. This illustrates another aspect of the NCI BW program. Zoonoses, diseases that can be transmitted from animals to humans, *make up the majority of BW agents*.

Now, although the Center for Disease Control has continued to insist that poverty, environment, and insects all have absolutely nothing to do with AIDS transmission, they sponsored an advertisement in the May 1987 issue of *Science* magazine seeking a research entomologist who would study "*the role of biting arthropods in transmitting human immunodeficiency (AIDS) virus*". The fact that covert research in this area has been conducted for some years under government contracts seems to have been overlooked.

There are other inconsistencies. Dr. John Seale, of Richmond, Virginia presided at a conference June 11, 1987, in which he stated positively, that "*AIDS is not a sexually transmitted disease. It is a contagious disease which is also transmitted in blood.*" He denounced Dr. Gallo of the National Institute of Health and the Surgeon

## M A T R I X I I I

General of the United States, Dr. Everett Koop, for deliberately spreading disinformation about the disease.

Dr. Gallo was originally famed as having "discovered" the humano-immunodeficiency virus, HIV, which he claimed was the cause of AIDS. After Gallo's discovery, the NIH strangely and consistently denied funds to any scientist whose work failed to bear Gallo's claims.

The Olympian  
Monday, March 2, 1992

**AIDS:** Dr. Robert Gallo, the American co-discoverer of the virus that causes AIDS and the subject of a federal inquiry in connection with that discovery, is being investigated once again, federal officials say, this time on charges of perjury and patent fraud.

At issue is the patent covering the test for detecting the virus, as well as the scientific glory for the remarkable research effort by which the virus was discovered and the detection test created.

One of the researchers who was to come into conflict with Dr. Gallo over the "HIV" controversy was Dr. Peter Duesberg, professor of virology at the University of California at Berkeley. Duesberg is also a member of the National Academy of Sciences. He had been brought to Gallo's own laboratory to work under a fellowship grant.

After studying HIV in the same laboratory where Gallo had claimed to have made his monumental findings, Duesberg concluded that the HIV virus did not meet the standard criteria for a disease-causing agent. He published his findings in the medical journal *Cancer Research*, in March 1987 and sat back to wait for Gallo to justify his conclusions. Gallo made no reply, and also refused to return telephone calls. Despite the claims of Gallo, research indicates that the HIV virus is present only in about half of all AIDS cases, a factor which Dr. Gallo will not explain. It is obvious at this point that the massive government testing program for the presence of HIV is a deliberate fraud being perpetrated by some elements within society on other elements in order to prolong the presence of this virus and the destruction of a significant part of the human population by this genetically engineered virus.

It is quite clear from the preceding material that many diseases are introduced into society deliberately to reduce the human population, while at the same time producing enormous sums of money for the chemical, drug,

## M A T R I X I I I

and banking industries, as well as all the ancillary support industries.

Some interesting data about some of the worlds leading drug and chemical companies can be found in Appendix II at the back of the book.

### Population Control Aspects of Condom Use

It is interesting that the use of condoms is being taught in schools and generally encouraged for acceptance; in 1992 a "female condom" was even devised.

One aspect of these two factors is that the use of condoms means a lower potential teen pregnancy rate for the next couple of generations. Condoms do not prevent AIDS, as the smallest pore in a condom is 1.7 microns in size and the AIDS virus is about .7 microns in size. Thus this policy of "using condoms because of AIDS" will:

1. Increase the spread of AIDS (sexual transmission of the virus is only one of the ways it can spread) and cause more deaths due to AIDS.
2. Theoretically reduce the general birth rate.

### Drug "Testing" on Prison Populations

The process for FDA approval of drugs is a long and tedious one which involves clinical testing. Clinical testing goes through three phases. Phase I calls for the testing of the new drug on a small number of healthy people. Phase II requires that "volunteers" take the drug during a two year trial basis. Phase III calls for more diverse clinical testing on from 1,000 to 3,000 patients over a three year period. Those who prescribe the drug apparently rely on Phase II testing to recommend its reliability.

Phase II, in which the drug is tested on human beings, generally requires a captive population. The drugs are sometimes tested secretly in schools, hospitals, and mental institutions, but the pharmaceutical manufacturers usually prefer to rely on a much safer test population, where people who are not in a position to sue or generate unfavorable publicity if the drug turns out to be toxic or have strange side effects. The safest captive population under these guidelines is the prison population. Since the turn of the century, the United States has led the world in the number of medical experiments carried out on prison populations - perhaps exceeded only by the Germans during



## M A T R I X I I I

### World War II.

Some people might think it is all right to conduct medical experiments on prisoners, even though a number of German doctors were executed for doing it. Some might think that it is a way for a debt to society to be repaid; an increasing number of people in prisons are not there for criminal behavior but are, in effect, political prisoners who are sent to prison for banking problems, tax problems, or defying the government line. Each year it seems that the number of non-violent prisoners is on the increase.

Despite all the concerns, the American Medical Association has always lobbied to continue the practice of drug testing on prisoners. Another related issue is that more political prisoners, which include researchers who make discoveries that would benefit mankind, die in prison than in any other place. My original research began in the area of free energy devices, and my attention was caught immediately by the plight of Wilhelm Reich, who was murdered in prison. New techniques for murdering people in prison include the use of radioactive isotopes to induce sudden, virulent forms of cancer that will kill a person within weeks of their incarceration.

Publicity about the use of prisoners in medical experiments surfaced in the 1940's. Wyeth Laboratories incredibly voiced their indignation that the use of prisoners would even be questioned, releasing a statement that "almost all of our Phase II testing is done on prisoners." The drug companies Upjohn and Parke-Davis, who makes the yearly flu vaccine *Fluogen*, used prisoners in Mississippi. Dosages of the drug were typically increased until there was a toxic reaction, confirming that drug tests in prisons are designed primarily to measure the toxicity of drugs rather than their efficiency. I have had mail come in from prisoners in various states that confirm that this procedure is still going on.

Vacaville State Prison in California has been doing drug experiments on prisoners for many years. Testing was done by an outfit called the Solano Institute for Medical and Physical Research - a non-profit corporation under the California charitable trust law.

Research indicates that at least 37 drug companies do Phase II testing on prisoners, including such leading firms as Upjohn, Lederle, Squibb, and Merck. Again, data about these companies and the people that run them is in Appendix II.

In 1963, there was a large article in *Time* which

M A T R I X I I I

detailed large scale programs which federal officials had established in prisons. The programs were justified as being part of the "war in cancer", and involved the injection of prisoners with live cancer cells as well as blood from leukemia patients. According to the article, some doctors were reaping huge profits from drug manufacturers as result of the program.

TACTICAL WEAPONS OF BIOWARFARE  
USED FOR POPULATION MANAGEMENT

Research over the last year indicates that there are a number of microbiological weapons and infectious agents that are in use. They appear to be generally divided into six groups: Bacteria and Bacilli, Viral Diseases, Fungal Diseases, Rickettsial Diseases, and Genetically Engineered Hybrid Organisms.

The following is a listing of the diseases that have been and continue to be deliberately and periodically injected into the population in order to induce disease and death as well as increase the economic position of the

medical monopoly controlled by the NWO:

Legend: + Transmissable from Animals % Inhaled  
\* Transmissable from Insects # Ingested  
@ Transmissable By Contact

BACTERIAL DISEASES

<u>Disease</u>	<u>Transmission</u>			<u>Remarks</u>
Anthrax	+	@	%	Bacillus Anthracis
Brucellosis	+	%	#	Brucella Melitensis
Cholera	+	#		Vibrio Cholera
Glanders	+	%	#	Malleomyces Mallei
Melioidosis	+	%	#	Whitmorella Pseudomallei
Plague	*	%	#	Pasteurella Pestis
Tularsemia	*	%	#	Pasteurella Tularensis

M A T R I X I I I

VIRAL DISEASES

Legend: + Transmissible from Animals % Inhaled  
 \* Transmissible from Insects # Ingested  
 @ Transmissible By Contact

<u>Disease</u>	<u>Transmission</u>	<u>Remarks</u>
Breakbone Fever	* %	Dengue Viruses
Mumps	%	High Infectivity
Poliomyelitis	% #	15% Mortality
Psittacosis	% # *	Parrot Fever
Smallpox	% #	Poxvirus Variolae
Yellow Fever	% *	30% Mortality

RICKETTSIAL DISEASES

<u>Disease</u>	<u>Transmission</u>	<u>Remarks</u>
Q - Fever	% # *	Coxiella Burnetii
Epidemic Typhus	% # *	Rickettsia Prowazeki

FUNGAL DISEASES

<u>Disease</u>	<u>Transmission</u>	<u>Remarks</u>
Coccidioidomycosis	%	Coccidioides Immitis

TOXINS

<u>Disease</u>	<u>Transmission</u>	<u>Remarks</u>
Botulism	% #	Clostridium Botulinum

GENETICALLY ENGINEERED ORGANISMS

<u>Disease</u>	<u>Transmission</u>	<u>Remarks</u>
Acquired Immune Deficiency Syndrome	* @ % #	Auto-Adjusting Antibody Virus
Chronic Fatigue Immune Dysfunction Syndrome	% #	C.F.S.
Homicidal Induced Schizophrenia	%	C.D.S.
Humano-Immune Virus	* @ % #	H.I.S.
		H.I.V.

M A T R I X I I I

Special Data Sources

1. Charles Piller and Keith Yamamoto, Gene Wars: Military Control Over the New Genetic Technologies (New York: Beech Tree Books/Morrow and Company), 1988, p.50
2. Louis Wolf, "This Side of Nuclear War" CAIB Summer 82, p.14.
3. Richard Hatch, "Cancer Warfare" Covert Action Magazine.
4. U.S. Army Activity in the U.S. Biological Warfare Programs Volume II, Unclassified, February 24, 1977, pp. I-C-4-5.
5. Special Virus Cancer Project Progress Report, 1972, National Cancer Institute, US Dept of HEW, p.33
6. Erhard Geissler, Biological and Toxin Weapons Today, New York: Oxford University Press, 1986, p.22
7. The Viral Cancer Program Progress Report, U.S. National Institutes of Health, June 1977, pp.272,302.
8. American Men and Women of Science (New York: R.R. Bowker, 1989) p.52.
9. Charles Pfizers current drug products, according to the 1991 PDR, include Vistaril, a psychoneurotic sedative, and various anti-biotics drugs.
10. Special Virus Cancer Project Progress Report, NCI, p114

~~~~~  
We have included a variety of materials at the end of this chapter that supplement the material discussed.  
~~~~~



MAY 1 1992

Food and Drug Administration  
Rockville MD 20857

V. Valerian  
Leading Edge Research Group  
P.O. Box 481-MU58  
Yelm, Washington 98587

Dear V. Valerian:

This correspondence is in response to your letter addressed to the Federal Drug Administration, Center for Biologics, Evaluation and Research. In your letter you request a variety of information related to the influenza vaccine, and epidemiology of the disease.

As your letter is subdivided into five sections, each with different questions, I will structure my response in a similar manner, first restating your question.

1. If the Office of Biologics makes this yearly recommendation, from who or where do they get the data in order to make the annual recommendation?

The Food and Drug Administration, Center for Biologics Evaluation and Research (CBER) has the responsibility for regulating the Influenza Virus Vaccine. The data used to determine which strains of the virus will be deemed effective in providing protection for the upcoming flu season is obtained from numerous sources. The epidemiology of influenza viruses is based on the isolation and identification of strains from infected people throughout the world. These sources include, but are not limited to: the World Health Organization, the Centers for Disease Control, the United States Armed Forces, and the Food and Drug Administration. CBER uses information on the most recent epidemiology, strain variation and immunologic responses of people to current vaccines in order to inform a panel of experts for recommendations of the appropriate strain of the virus to be included in the yearly formulation of the vaccine. This panel, an Advisory Committee, meets in the late winter of each year to review epidemiological evidence related to the prevalence of influenza viruses. The epidemiological and serological evidence is presented by scientists from the groups listed. I am including the agenda from the January 30, 1992 meeting of the Vaccines Advisory Committee meeting which considered the selection of the influenza virus strains, and also a brief document related to flu shots.

If you require more information related to the incidence of the flu in the United States you may want to write to the Department of Health and Human Services, Public Health Service, Centers for

0181-A

Disease Control, Atlanta, Georgia 30333. They publish a weekly publication the "Morbidity and Mortality Weekly Report". In the April 12, 1992 and the May 11, 1992 reports the issue of flu is dealt with extensively.

2. At which time period during the year is the recommendation passed to the company who makes the influenza virus?

As I stated in my response to your first question, these Advisory Committee Meetings generally occur in the late winter, allowing the manufacturers sufficient start-up time to initiate the culture of the virus strains. The manufacturers typically send a representative to the meeting.

For the influenza virus vaccine, there are five active manufacturers with four different products. They are:

- 1) Parke-Davis, Division of Warner-Lambert Company,  
Parkdale Road  
Rochester MI 48063
- 2) Connaught Laboratories, Inc.  
Route 611  
P.O. Box 187  
Swiftwater, Pa. 18370
- 3) shared manufacture by:  
Evans Medical Ltd  
Langhurst, Horsham  
West Sussex, PH124QD, England  
and  
Lederle Laboratories, Division of American Cyanamid Co.  
Middletown Road  
Pearl River, NY 10965
- 4) Merck Sharp & Dohme, Division of Merck & Co., Inc.  
Sumneytown Pike  
West Point, Pa, 19486
- 5) Wyeth Laboratories, Inc.  
Wasp and Biddle Streets  
Marietta, Pa. 17547

3. What is the current formulation of the vaccine, and what have been the formulations over the past three years?

1992/93 flu season  
A/Beijing/353/89 (H3N2)  
A/Texas/36/91 (H1N1)  
B/Panama/45/90

1992/91 season formulation  
A/Taiwan/1/86 (H1N1)  
A/Beijing/353/89 (H3N2)  
B/Panama/45/90

1991/90 season formulation  
A/Taiwan/1/86 (H1N1)  
A/Shanghai/16/89 (H3N2)  
B/Yamagata/16/88

1989/88 season formulation  
A/Taiwan/1/86 (H1N1)  
A/Shanghai/11/87 (H3N2)  
B/Yamagata/16/88

4. Could you provide us with research material which would illustrate the flowing data and statistics:

a: Data on the number of confirmed cases of different types of disease conditions and the dates indicated for the past three years.

Response: Such data, if available, will be found at the Centers for Disease Control (CDC) in Atlanta, Georgia. The CDC is responsible for the epidemiological data related to most of the diseases found in the country.

b: Data on the release dates and use of vaccines for the same time period.

Response: While I cannot give you the exact release dates, the flu vaccine is generally made available to the public in the late summer/early fall of the year. The information you request concerning the use of vaccines, if available will be found at the CDC in Atlanta, Georgia. There were 36 million doses of flu vaccine made available last season.

c: Data reflecting other recommendations for formulation of other vaccines, other than influenza, and the data upon which such recommendations are based.

Currently CBER only regulates this one vaccine subject to yearly reformulations. All of the other vaccines are not formulated on a yearly basis. These other vaccines would include products such as, Polio Vaccine, Diphtheria, Pertussis and Tetanus vaccine, Yellow Fever Vaccine, Rabies Vaccine, to name a few.

In the United States, it is the responsibility of the manufacturer and/or developer to investigate a drug product and develop data from laboratory testing and clinical studies that are necessary to support an application for marketing the product. FDA is responsible for reviewing those data that are submitted in support of a product license, and deciding whether they are adequate for granting approval for interstate sale.

Such applications are reviewed for safety and effectiveness in as expeditious a manner as possible. The FDA is sincerely committed to making beneficial products available to patients who need them. However, we must enforce the laws that the Congress has enacted to ensure that we approve only those products that are demonstrated to be safe and effective.

Our Agency has a responsibility to ensure that investigational products are tested according to established scientific principles and that valid analyses of benefits and risks are performed. While the need for effective products is critical, well-controlled clinical trials are the best mechanism for obtaining safety and efficacy data that will allow assessment of the role of new drug products in clinical medicine. FDA's policy for the review and approval of products is to maintain an approach that is flexible, but carefully balanced between these concerns and the possibility of worsening, rather than helping, the condition of patients as a result of premature distribution of an unproven drug product.

5. Could you provide us with any organizational type charts that would illustrate the functional relationships between the FDA, the Centers for Disease Control, and the U. S. Public Health Service? Any data would be helpful.

See enclosed.

Sincerely yours,

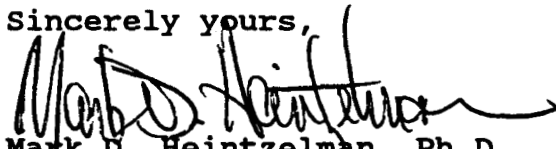

Mark D. Heintzelman, Ph.D.  
Consumer Safety Officer  
Congressional, Consumer and  
International Affairs  
Center for Biologics Evaluation  
and Research

Enclosures



# WWII Allies Had Planned to Use Bacteriological Warfare

EXCLUSIVE TO THE SPOTLIGHT  
BY MIKE BLAIR

U.S. President Franklin Delano Roosevelt and British Prime Minister Winston Churchill developed plans to drop bombs containing deadly disease germs on major German cities during World War II.

Having suffered casualties of more than half of a force of 7,000 British, Canadian and American commandos in a reconnaissance in force at Dieppe, along the French coast, in August, 1942 and finding the Allied invasion of Italy in the summer of 1943 hopelessly bogged down, Roosevelt and Churchill sought other means to win the war.

A plan was subsequently developed to drop bombs containing deadly U.S.-made anthrax spores on major German cities, including Berlin, Stuttgart, Hamburg, Aachen, Frankfurt and Wilhelmshafen.

## BACTERIAL DISEASE

Anthrax is a rare bacterial disease, which causes severe skin pustules and lung disease, often progressing to deadly septicemia. Anthrax spores, which can survive for years, can be transmitted to humans from diseased sheep and cattle.

A top-secret U.S. production plant to produce the lethal spores was set up just south of Terre Haute, Indiana, near the Ohio border.

According to Vigo County (Indiana) historian Dorothy Clark, the plant was "very secret. It was on the highway south of town. Not much has ever been written about it. People called it a 'poison plant'."

"I recall the plant being there [south of Terre Haute], a World War II vet, who lives in nearby Lewis, Indiana, told The SPOTLIGHT. "No one knew much about it. It was heavily guarded and a real secret operation. Everything was moved out after the war."

## TESTED BY BRITISH

According to Prof. Barton J. Bernstein, an historian at California's Stanford University, the British Medical Council's Bacteriological Metabolic Unit tested anthrax spores on cattle and sheep on the island of Gruinard, off the west coast of the mainland of Scotland, near Badluachrach and Laide. (For those less familiar with Scottish geography, this is north of the Isle of Skye and within the latitudes of the Isle of Lewis.)

The tiny island reportedly still remains totally uninhabitable.

The plant near Terre Haute was supposed to produce about 50,000 bombs per month during the summer of 1944 and 250,000 by the year's end.

Bernstein, who is an authority on chemical and biological warfare weapons produced during World War II, says that records concerning the Terre Haute plant's total production have supposedly been "destroyed, lost or classified."

Recently uncovered British documents reveal that a German refugee, Frederick A. Lindemann (later created Lord Cherwell), who served as Britain's chief scientific adviser during the war, informed Churchill in February, 1944 that "any animal breathing [anthrax] spores is extremely likely to die suddenly but peacefully within the week."

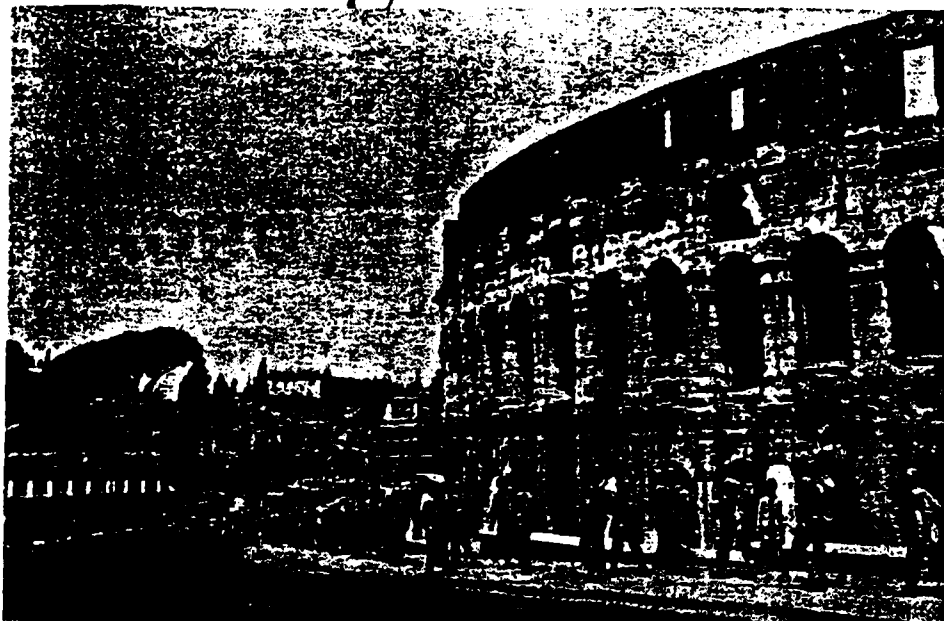

U.S. 5th Army troops pass the Coliseum while entering Rome in June, 1944. When it looked like Italy would never be taken, England and America considered the use of deadly anthrax germs against German cities.

Lindemann told Churchill that about six Lancaster bombers would be able to carry sufficient bombs to destroy life in a square-mile area.

The SPOTLIGHT has revealed in previous articles how the British and U.S. forces in Italy had planned to use deadly mustard gas on German forces.

Vast stores of the gas contained in shells and bombs were warehoused in Allied-occupied areas of Italy.

Plans to use them, however, fell apart on December 2, 1943, when 100 German JU-88 bombers based in Albania and Yugoslavia made a daring attack across the Adriatic Sea on the Allied supply depot at the port of Bari on the east coast of Italy.

In the attack, the U.S. transport ship *John Harvey* was blasted at its moorings. In its hold were, among other things, 2,000 hundred-pound mustard gas bombs—100 tons of bombs.

Eighty-three U.S. sailors were killed and 534 seriously injured by the gas that leaked from the ship. The British have never announced the number of their casualties. An unknown number of Italian civilians were also killed by the gas.

## STANDOFF PREVAILED

That Roosevelt and Churchill failed to use the gas and deadly germs appears to be due to three factors:

- Advisers pointed out that the use of such weapons could only cause the Germans to retaliate with their own chemical and biological weapons. Allied intelligence was aware that the Germans had stockpiled vast stores of poison gases, including lethal nerve gas.

- If the anthrax spores had been used, world public opinion would

have been devastating to the Allied cause.

- German cities bombed with the anthrax spores would have been uninhabitable, even by occupying Allied forces, for years and could have spread a plague across Europe.

The Roosevelt administration also had plans to use gas and biological weapons on Japanese forces during World War II.

Just before his death in 1966, Fleet Admiral Chester Nimitz said the toughest decision he had made during the war was "when the War Department suggested the use of poison gas during the invasion of Iwo Jima . . . I decided the United States should not be the first to violate the Geneva Convention."

## PLANS TO USE GAS

David E. Lilienthal, former chairman of the Atomic Energy Commission, revealed that the Roosevelt administration was prepared to use poison gas against the Japanese in a recommendation prepared by Gen. George C. Marshall, the Army chief of staff.

Lilienthal indicated that the plan was ultimately rejected because it was feared the Japanese would react in kind.

In July, 1944, Roosevelt raised the possibility of using biological weapons against the Japanese.

Adm. William D. Leahy, who was present, recalled: "Personally I re-

jected from the idea and said to Roosevelt: 'Mr. President, this [using germs and poisons] would violate every Christian ethic I have ever heard of and all of the known rules of law. It would be an attack on the noncombatant population of the enemy. The reaction can be foretold—if we use it, the enemy will use it.'"

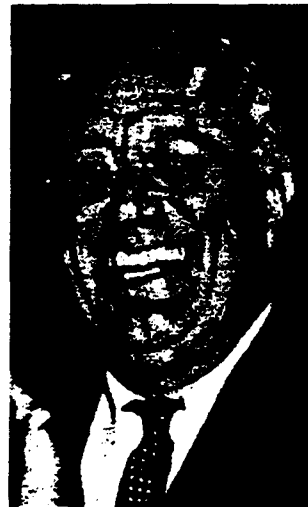

FRANKLIN ROOSEVELT



WINSTON CHURCHILL

## Can bacteria direct their own evolution?

TWO YEARS ago, John Cairns and his colleagues at the Harvard School of Public Health, reported that the bacterium *Escherichia coli* appeared to generate mutations that were beneficial to it, and were not simply random (*Nature*, vol 335, p 142). This violated one of the few fundamental laws in biology: that mutations in a population arise by chance, and are not influenced by the demands of the environment.

Now, after evolutionary biologists have produced scores of reasons why Cairns must be mistaken, that his experimental design must somehow be at fault, Barry Hall of the University of Rochester is claiming that Cairns may be closer to the truth than his critics would like to believe. In a paper in the current issue of *Genetics* (vol 126, p 142), he says that specific mutations in *E. coli* "occur more frequently when advantageous than when neutral".

According to Franklin Stahl of the University of Oregon, Eugene, commenting in *Nature* (vol 346, p 791), "Hall's work extends and strengthens that of Cairns [and his colleagues]".

Both Cairns and Hall use strains of *E. coli* that are unable to metabolise a particular biochemical substrate, because of a genetic defect. In Cairns's case, the substrate is lactose, and in Hall's it is tryptophan. They find that when the *E. coli* are exposed to these substrates, they appear preferentially to mutate the defective genes back to the functional state.

"This is a highly specific process," explains Hall. "You see an enhanced rate of mutation in this single gene being selected for, not a general enhancement of mutation rate in all genes." The mutation rate in the tryptophan-metabolising gene was about 30 times the normal rates, says Hall.

Biologists' ideas about the nature of mutation in bacteria were developed in the 1940s and 1950s when researchers asked the question: "do mutations arise independently of selection, or in response to selection?" The overwhelming majority of experiments seemed to indicate that mutation rate is indeed independent of the environment.

"As so often happens in science, we set up an artificial dichotomy," says Hall. "In this case it was, either mutations occur in the absence of selection, or as a result of selection. No middle ground." Because some key experiments showed that mutation occurred independently of selection, says Hall, biologists assumed that all mutation was independent of selection. According to Cairns, the main rationale for his controversial paper in 1988 was that this assumption "has never been properly put to the test".

Biologists may have been thrown off track in elucidating the full range of biochemical potential in bacteria because their experiments have typically been confined to rather artificial conditions. Specifically, researchers bathe bacteria in an abundant growth medium, so that the colony grows exponentially.

According to Hall, bacteria in nature are much more likely to be sitting around under

Roger Lewin, Washington, DC

nutritional stress, not growing at all. "If we want to understand mutation under natural conditions, we have to study bacteria under these conditions," he says. This is precisely what he and Cairns have done.

During the exponential growth phase,



The bacterium *Escherichia coli* appears to generate mutations that are beneficial rather than simply random

DNA replication in bacteria dominates metabolic activity, because the cells grow and divide rapidly. In non-growing populations, however, metabolism is just ticking over, with DNA synthesis principally confined to repair operations. The challenge is to explain how the observations of Cairns and Hall of the preferential production of beneficial mutations might come about under the latter conditions.

Cairns suggested an ingenious scheme, one that implied that the bacteria were actively directing the mutations. It relied on each gene, during the synthesis of proteins, producing not just one messenger RNA (mRNA)—a faithful copy of the information encoded in the gene—but several minor variants. Cairns suggested that each protein variant, translated from this range of messages, would then somehow be "tested" against prevailing circumstances. Once the best variant is determined, the mRNA that produced it would then be copied back into the genome by the enzyme reverse

transcriptase, thus fixing the mutant. Armed with a metabolic mechanism of this sort, a cell could respond to its environmental conditions, and effectively tailor its genes to suit them.

However, Cairns has no notion of how a cell would "test" each protein variant, nor how an optimum variant might be linked with the mRNA that generated it. Also, says Hall, "Cairns's scheme makes people uncomfortable, because it involves truly directed mutation."

Hall believes that there are ways which you could get preferential mutation, but with an underlying random mechanism. One such mechanism, proposed by Stahl, involves the DNA repair system.

Imagine a population of bacteria, suffering nutritional depletion, and, therefore, not growing. From time to time, mutations occur in temporarily single-stranded DNA, which might occur during transcription of RNA messengers. DNA repair mechanisms might be slow under these circumstances, but they would eventually do the job.

Imagine now that a mutant produces a protein that allows the cell to metabolise a substrate that previously it could not use. The cell would then be able to grow, DNA replication would get under way and the new mutant would be fixed in the chromosome before the repair system could "correct" it. In this way, the environment would appear to be tailoring the mutations produced.

A second possible random mechanism, suggested by Hall, focuses on fluctuations in the cells' vulnerability to mutation. Imagine that in a starved bacterial colony, a small fraction of the population become "hypermutable"; that is, the overall mutation rate rising dramatically. Most of the cells that pass into this state might soon die. However, some might include a mutation that, as before, allows the cell to metabolise a previously inaccessible substrate. Such cells will grow and thrive.

One prediction here is that a thin spectrum of other mutants will be carried along randomly with the successful mutant. "This is what I see in my experiments," says Hall, which leads him to prefer his explanation over Stahl's. □

REPRINTED BY  
U.S. DEPARTMENT OF HEALTH AND HUMAN SERVICES  
PUBLIC HEALTH SERVICE  
FROM THE  
MORBIDITY AND MORTALITY WEEKLY REPORT  
April 7, 1989 / Vol. 38 / No. 13  
Pages 205-214, 219-227

Recommendations of the Immunization  
Practices Advisory Committee (ACIP)

**General Recommendations on Immunization**

*This revision of the "General Recommendations on Immunization" updates the 1983 statement (1). Changes or new sections include 1) listing of vaccines available in the United States by type and recommended routes, 2) updated schedules for immunizing infants and children, 3) clarification of the guidelines for spacing administration of immune globulin preparations and different vaccines, 4) an updated table of recommendations for routine immunization of children infected with human immunodeficiency virus, 5) listing of conditions that are often inappropriately considered contraindications to immunization, and 6) addition of information on the National Childhood Vaccine Injury Act of 1986 and the National Vaccine Injury Compensation Program. These recommendations are not comprehensive for each vaccine; Immunization Practices Advisory Committee (ACIP) recommendations on each vaccine should be consulted for more details.*

**INTRODUCTION**

Recommendations for immunizing infants, children, and adults are based on characteristics of immunobiologics, scientific knowledge about the principles of active and passive immunization, and judgments by public health officials and specialists in clinical and preventive medicine. Benefits and risks are associated with the use of all immunobiologics: no vaccine is completely safe or completely effective. Benefits of immunization range from partial to complete protection against the consequences of disease (which range from mild or asymptomatic infection to severe consequences, such as paralysis or death); risks of immunization range from common, trivial, and inconvenient side effects to rare, severe, and life-threatening conditions. Thus, recommendations for immunization practices balance scientific evidence of benefits, costs, and risks to achieve optimal levels of protection against infectious diseases. These recommendations describe this balance and attempt to minimize the risks by providing specific advice regarding dose, route, and spacing of immunobiologics and delineating situations that warrant precautions or contraindicate their use. They are recommendations for use in the United States because epidemiologic circumstances and vaccines often differ in other countries. Individual circumstances may warrant deviations from these recommendations. The relative balance of benefits and risks can change as diseases are controlled or eradicated. For example, because smallpox has been eradicated throughout the world, the risk of complications associated with smallpox vaccine now exceeds the risk of the disease; consequently, smallpox vaccination of civilians is now indicated only for laboratory workers directly involved with smallpox or closely related orthopox viruses (e.g., monkeypox and vaccinia).

**DEFINITIONS**

**Immunobiologic**

Immunobiologics include both antigenic substances, such as vaccines and toxoids, and antibody-containing preparations, including globulins and antitoxins, from human or animal donors. These products are used for active or passive immunization or therapy. Examples include:

**Vaccine** (Table 1): A suspension of live (usually attenuated) or inactivated microorganisms (bacteria, viruses, or rickettsiae) or fractions thereof administered to induce immunity and thereby prevent infectious disease. Some vaccines contain highly defined antigens (e.g., the polysaccharide of *Haemophilus influenzae* type b or the surface antigen of hepatitis B); others have antigens that are complex or incompletely defined (e.g., killed *Bordetella pertussis* or live attenuated viruses).

**Toxoid**: A modified bacterial toxin that has been rendered nontoxic but retains the ability to stimulate the formation of antitoxin.

**Immune globulin (IG)**: A sterile solution containing antibodies from human blood. It is obtained by cold ethanol fractionation of large pools of blood plasma and contains 15%–18% protein. Intended for

**TABLE 1. Vaccines available in the United States, by type and recommended routes of administration**

Vaccine	Type	Route
BCG (Bacillus of Calmette and Guérin)	Live bacteria	Intradermal or subcutaneous
Cholera	Inactivated bacteria	Subcutaneous or intradermal*
DTP (D = Diphtheria) (T = Tetanus) (P = Pertussis)	Toxoids and inactivated bacteria	Intramuscular
HB (Hepatitis B)	Inactive viral antigen	Intramuscular
Haemophilus influenzae b – Polysaccharide (HbPV) – or Conjugate (HbCV)	Bacterial polysaccharide or Polysaccharide conjugated to protein	Subcutaneous or intramuscular <sup>†</sup> Intramuscular
Influenza	Inactivated virus or viral components	Intramuscular
IPV (Inactivated Poliovirus Vaccine)	Inactivated viruses of all 3 serotypes	Subcutaneous
Measles	Live virus	Subcutaneous
Meningococcal	Bacterial polysaccharides of serotypes A/C/Y/W-135	Subcutaneous
MMR (M = Measles) (M = Mumps) (R = Rubella)	Live viruses	Subcutaneous
Mumps	Live virus	Subcutaneous
OPV (Oral Poliovirus Vaccine)	Live viruses of all 3 serotypes	Oral
Plague	Inactivated bacteria	Intramuscular
Pneumococcal	Bacterial polysaccharides of 23 pneumococcal types	Intramuscular or subcutaneous
Rabies	Inactivated virus	Subcutaneous or intradermal <sup>‡</sup>
Rubella	Live virus	Subcutaneous
Tetanus	Inactivated toxin (toxoid)	Intramuscular <sup>§</sup>
Td or DT** (T = Tetanus) (D or d = Diphtheria)	Inactivated toxins (toxoids)	Intramuscular <sup>§</sup>
Typhoid	Inactivated bacteria	Subcutaneous <sup>††</sup>
Yellow fever	Live virus	Subcutaneous

\*The intradermal dose is lower.

<sup>†</sup>Route depends on the manufacturer; consult package insert for recommendation for specific product used.

<sup>‡</sup>Intradermal dose is lower and used only for preexposure vaccination.

<sup>§</sup>Preparations with adjuvants should be given intramuscularly.

\*\*DT = tetanus and diphtheria toxoids for use in children aged <7 years. Td = tetanus and diphtheria toxoids for use in persons aged ≥7 years. Td contains the same amount of tetanus toxoid as DTP or DT but a reduced dose of diphtheria toxoid.

<sup>††</sup>Boosters may be given intradermally unless acetone-killed and dried vaccine is used.

Office of the Assistant Secretary  
for Health  
Washington DC 20201

Dear Doctor:

Last fall, I notified you about the new Vaccine Adverse Event Reporting System (VAERS) of the Department of Health and Human Services (HHS). VAERS is designed to accept all reports of suspected adverse events after administration of any vaccine, in all age groups, including but not limited to those mandated by the National Childhood Vaccine Injury Act of 1986.

Your full participation is essential in establishing an accurate database of adverse events associated with vaccines. This feedback helps to direct initiatives in developing and improving the safety and effectiveness of vaccines.

Whenever you report an adverse event to VAERS, you will receive verification of receipt of your report. For certain serious adverse events, you will be contacted regarding the patient's condition at 60 days and again at 1 year.

I am pleased to report that your cooperation has contributed greatly to the successful implementation of this new program. Since initiation of the program in November 1990, we have received over 2,500 reports. We have already received many requests for additional copies of the form, one of which is enclosed.

Please call 1-800-822-7967\* if you have further questions regarding the reporting requirements or completion of the report form or if you need additional forms.

Your continued assistance in helping ensure the safety of vaccines in use is greatly appreciated.

Sincerely yours,

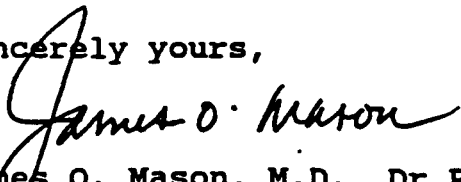
  
James O. Mason, M.D., Dr.P.H.  
Assistant Secretary for Health  
Director, National Vaccine Program

Enclosure

\*This is the national number. For reporting in the state of Washington, please call 1-206-753-3495.

**TABLE 1. Reportable events following vaccination**

Vaccine/Toxoid	Event	Interval from Vaccination
DTP, P,	A. Anaphylaxis or anaphylactic shock	24 hours
DTP/Polio	B. Encephalopathy (or encephalitis)*	7 days
Combined	C. Shock-collapse or hypotonic-hyporesponsive collapse*	7 days
	D. Residual seizure disorder*	(See Aids to Interpretation*)
	E. Any acute complication or sequela (including death) of above events	No limit
	F. Events in vaccinees described in manufacturer's package insert as contraindications to additional doses of vaccine† (such as convulsions)	(See package insert)
Measles, Mumps, and Rubella; DT, Td, Tetanus Toxoid	A. Anaphylaxis or anaphylactic shock	24 hours
	B. Encephalopathy (or encephalitis)*	15 days for measles, mumps, and rubella vaccines; 7 days for DT, Td, and T toxoids
	C. Residual seizure disorder*	(See Aids to Interpretation*)
	D. Any acute complication or sequela (including death) of above events	No limit
	E. Events in vaccinees described in manufacturer's package insert as contraindications to additional doses of vaccine†	(See package insert)
Oral Polio Vaccine	A. Paralytic poliomyelitis — in a non-immunodeficient recipient — in an immunodeficient recipient — in a vaccine-associated community case	30 days 6 months No limit
	B. Any acute complication or sequela (including death) of above events	No limit
	C. Events in vaccinees described in manufacturer's package insert as contraindications to additional doses of vaccine†	(See package insert)
Inactivated Polio Vaccine	A. Anaphylaxis or anaphylactic shock	24 hours
	B. Any acute complication or sequela (including death) of above event	No limit
	C. Events in vaccinees described in manufacturer's package insert as contraindications to additional doses of vaccine†	(See package insert)

**\*Aids to Interpretation:**

Shock-collapse or hypotonic-hyporesponsive collapse may be evidenced by signs or symptoms such as decrease in or loss of muscle tone, partial or complete), hemiplegia, hemiparesis, loss of color or turning pale white or blue, unresponsiveness to environmental stimuli, depression of or loss of consciousness, prolonged sleeping with difficulty arousing, or cardiovascular or respiratory arrest.

Residual seizure disorder may be considered to have occurred if no other seizure or convulsion unaccompanied by fever or accompanied by a fever of less than 102 °F occurred before the first seizure or convulsion after the administration of the vaccine involved.

AND, if in the case of measles-, mumps-, or rubella-containing vaccines, the first seizure or convulsion occurred within 15 days after vaccination OR in the case of any other vaccine, the first seizure or convulsion occurred within 3 days after vaccination.

AND, if two or more seizures or convulsions unaccompanied by fever or accompanied by a fever of less than 102 °F occurred within 1 year after vaccination.

The terms seizure and convulsion include grand mal, petit mal, absence, myoclonic, tonic-clonic, and focal motor seizures and signs. Encephalopathy means any significant acquired abnormality of, injury to, or impairment of function of the brain. Among the frequent manifestations of encephalopathy are focal and diffuse neurologic signs, increased intracranial pressure, or changes lasting at least 6 hours in level of consciousness, with or without convulsions. The neurologic signs and symptoms of encephalopathy may be temporary with complete recovery, or they may result in various degrees of permanent impairment. Signs and symptoms such as high-pitched and unusual screaming, persistent inconsolable crying, and bulging fontanel are compatible with an encephalopathy, but in and of themselves are not conclusive evidence of encephalopathy. Encephalopathy usually can be documented by slow wave activity on an electroencephalogram.

†The health-care provider must refer to the CONTRAINDICATION section of the manufacturer's package insert for each vaccine.

Rubella vaccine is grown in human diploid cell cultures and can safely be given to persons with histories of severe allergy to eggs or egg proteins.

Some vaccines contain trace amounts of antibiotics to which patients may be hypersensitive. The information provided in the vaccine package insert should be carefully reviewed before a decision is made whether the rare patient with such hypersensitivity should be given the vaccine(s). No currently recommended vaccine contains penicillin or its derivatives.

MMR and its individual component vaccines contain trace amounts of neomycin. Although the amount present is less than would usually be used for the skin test to determine hypersensitivity, persons who have experienced anaphylactic reactions to neomycin should not be given these vaccines. Most often, neomycin allergy is a contact dermatitis, a manifestation of a delayed-type (cell-mediated) immune response rather than anaphylaxis. A history of delayed-type reactions to neomycin is not a contraindication for these vaccines.

Bacterial vaccines, such as cholera, DTP, plague, and typhoid, are frequently associated with local or systemic adverse effects, such as redness, soreness, and fever. These reactions are difficult to link with a specific sensitivity to vaccine components and appear to be toxic rather than hypersensitive. On rare occasions, urticarial or anaphylactic reactions in DTP, DT, or Td recipients have been reported. When such events are reported, appropriate skin tests should be performed to determine sensitivity to tetanus toxoid before its use is discontinued (6).

#### ALTERED IMMUNOCOMPETENCE

Virus replication after administration of live, attenuated-virus vaccines can be enhanced in persons with immunodeficiency diseases and in persons with suppressed capacity for immune response as occurs with leukemia, lymphoma, generalized malignancy, symptomatic HIV infections, or therapy with alkylating agents, antimetabolites, radiation, or large amounts of corticosteroids. Severe complications have followed vaccination with live, attenuated-virus vaccines and with live-bacteria vaccines (e.g., BCG) in patients with leukemia, lymphoma, or suppressed immune responses. In general, these patients should not be given live vaccines, with the exceptions noted below.

If polio immunization is indicated for immunosuppressed patients, their household members, or other close contacts, these persons should be given IPV rather than OPV. Although a protective immune response cannot be assured in the immunocompromised patient, some protection may be provided. Because of the possibility of immunodeficiency in other children born to a family in which one such case has occurred, no family members should receive OPV unless the immune statuses of the intended recipient and all other children in the family are known.

Patients with leukemia in remission whose chemotherapy has been terminated for at least 3 months can be given live-virus vaccines. Short-term, low-to-moderate dose systemic corticosteroid therapy (<2 weeks), topical steroid therapy (e.g., nasal, skin), long-term alternate-day treatment with low to

**TABLE 6. Guidelines for spacing the administration of immune globulin (IG) preparations and vaccines**

Simultaneous administration: Immunobiologic combination		Recommended minimum interval between doses
IG and killed antigen		None. May be given simultaneously at different sites or at any time between doses.
IG and live antigen		Should generally not be given simultaneously.* If unavoidable to do so, give at different sites and revaccinate or test for seroconversion in 3 mos.
Nonsimultaneous administration: Immunobiologic administered		Recommended minimum interval between doses
First	Second	
IG	Killed antigen	None
Killed antigen	IG	None
IG	Live antigen	6 wks and preferably 3 mos*
Live antigen	IG	2 wks

\*The live-virus vaccines, oral polio and yellow fever, are exceptions to these recommendations. Either vaccine may be administered simultaneously or at any time before or after IG without significantly decreasing the antibody response (3).

moderate doses of short-acting systemic steroids, and intra-articular, bursal, or tendon injection with corticosteroids are not immunosuppressive in their usual doses and do not contraindicate live-virus vaccine administration.

The growing number of infants and preschoolers infected with HIV has directed special attention to the appropriate immunization of such children. The evaluation and testing for HIV infection of asymptomatic children presenting for vaccines is not necessary before decisions concerning immunization are made. The inactivated childhood vaccines (e.g., DTP or HbCV) should be given to HIV-infected children regardless of whether HIV symptoms are present. Although OPV has not been harmful when administered to asymptomatic HIV-infected children, IPV is the vaccine of choice if the child is known to be infected. The use of IPV not only eliminates any theoretical risk to the vaccinee but also prevents the possibility of vaccine virus spread to immunocompromised close contacts. Asymptomatically infected persons in need of MMR should receive it. Also, MMR should be considered for all symptomatic HIV-infected children since measles disease can be severe in symptomatic HIV-infected children. Limited studies of MMR immunization in both asymptomatic and symptomatic HIV-infected patients have not documented serious or unusual adverse events. In addition, pneumococcal vaccine is recommended for any child infected with HIV. Influenza vaccine is recommended for children with symptoms of HIV infection (Table 7).

#### FEBRILE ILLNESS

The decision to administer or delay vaccination because of a current or recent febrile illness depends largely on the severity of symptoms and on the etiology of the disease.

Although a moderate or severe febrile illness is reason to postpone immunizations, minor illnesses such as mild upper-respiratory infections (URI) with or without low-grade fever are not contraindications for vaccination. In persons whose compliance with medical care cannot be assured, it is particularly important to take every opportunity to provide appropriate vaccinations.

Children with moderate or severe febrile illnesses can be vaccinated as soon as the child has recovered. This precaution to wait avoids superimposing adverse effects of the vaccine on the underlying illness or mistakenly attributing a manifestation of the underlying illness to the vaccine.

Routine physical examinations or measuring temperatures are not prerequisites for vaccinating infants and children who appear to be in good health. Asking the parent or guardian if the child is ill, postponing vaccination in those with moderate or severe febrile illnesses, and immunizing those without contraindications to vaccination are appropriate procedures in childhood immunization programs.

**TABLE 7. Recommendations for routine immunization of HIV-infected children – United States**

Vaccine	Known HIV infection	
	Asymptomatic	Symptomatic
DTP*	Yes	Yes
OPV†	No	No
IPV‡	Yes	Yes
MMR§	Yes	Yes**
HbCV**	Yes	Yes
Pneumococcal	Yes	Yes
Influenza	No**	Yes

\*DTP = Diphtheria and Tetanus Toxoids and Pertussis Vaccine, Adsorbed. DTP may be used up to the seventh birthday.

†OPV = Poliovirus Vaccine Live Oral, Trivalent: contains poliovirus types 1, 2, and 3.

‡IPV = Poliovirus Vaccine Inactivated: contains poliovirus types 1, 2, and 3.

§MMR = Measles, Mumps, and Rubella Virus Vaccine, Live.

\*\*Should be considered.

\*\*HbCV = Vaccine composed of Haemophilus influenzae b polysaccharide antigen conjugated to a protein carrier.

\*\*Not contraindicated.



**TABLE 3. Adverse events occurring within 48 hours of DTP immunizations**

<b>Event</b>	<b>Frequency*</b>
<b>Local</b>	
Redness	1/3 doses
Swelling	2/5 doses
Pain	1/2 doses
<b>Mild/moderate systemic</b>	
Fever $\geq 38$ C (100.4 F)	1/2 doses
Drowsiness	1/3 doses
Fretfulness	1/2 doses
Vomiting	1/15 doses
Anorexia	1/5 doses
<b>More serious systemic</b>	
Persistent, inconsolable crying duration $\geq 3$ hours)	1/100 doses
High-pitched, unusual cry	1/900 doses
Fever $\geq 40.5$ C ( $\geq 105$ F)	1/330 doses
Collapse (hypotonic- hyporesponsive episode)	1/1,750 doses
Convulsions (with or without fever)	1/1,750 doses
Acute encephalopathy <sup>†</sup>	1/110,000 doses
Permanent neurologic deficit <sup>†</sup>	1/310,000 doses

\*Number of adverse events per total number of doses regardless of dose number in DTP series.

<sup>†</sup>Occurring within 7 days of DTP immunization.

Rarely, an anaphylactic reaction (i.e., hives, swelling of the mouth, difficulty breathing, hypotension, or shock) has been reported after receiving preparations containing diphtheria, tetanus, and/or pertussis antigens. The ACIP finds no good evidence for a causal relationship between DTP and hemolytic anemia or thrombocytopenic purpura.

Arthus-type hypersensitivity reactions, characterized by severe local reactions (generally starting 2-8 hours after an injection), may follow receipt of tetanus toxoid, particularly in adults who have received frequent (e.g., annual) boosters of tetanus toxoid. A few cases of peripheral neuropathy have been reported following tetanus toxoid administration, although a causal relationship has not been established.

Sudden infant death syndrome (SIDS) has occurred in infants following administration of DTP. A large case-control study of SIDS in the United States showed that receipt of DTP was not causally related to SIDS (9). It should be recognized that the first three primary immunizing doses of DTP are usually administered to infants 2-6 months old and that approximately 85% of SIDS cases occur at ages 1-6 months, with the peak incidence occurring at 6 weeks-4 months of age. By chance alone, some SIDS victims can be expected to have recently received vaccine.

Onset of infantile spasms has occurred in infants who have recently received DTP or DT. Analysis of data from the NCES on children with infantile spasms showed that receipt of DTP or DT was not causally related to infantile spasms (10). The incidence of onset of infantile spasms increases at 3-9 months of age, the time period in which the second and third doses of DTP are generally given. Therefore, some cases of infantile spasms can be expected to be related by chance alone to recent receipt of DTP.

#### **Reporting of Adverse Events**

Reporting by parents and patients of all adverse events occurring within 4 weeks of antigen administration should be encouraged. Adverse events that require a visit to a health-care provider should be reported by health-care providers to manufacturers and local or state health departments. The information will be forwarded to an appropriate federal agency (the Bureau of Biologics Research and Review, FDA, or CDC).

#### **COMMENTS ON USING REDUCED DOSAGE SCHEDULES OR MULTIPLE SMALL DOSES**

The ACIP recommends giving only the full dose of DTP; if a specific contraindication to DTP exists, none should be given. In the United States, the full course of primary immunization is considered to be four 0.5-ml doses of DTP.

## SIDE EFFECTS AND ADVERSE REACTIONS

Local reactions, generally erythema and induration with or without tenderness, are common after the administration of vaccines containing diphtheria, tetanus, or pertussis antigens. Occasionally, a nodule may be palpable at the injection site of adsorbed products for several weeks. Abscesses at the site of injection have been reported (6-10 per million doses). Mild systemic reactions, such as fever, drowsiness, fretfulness, and anorexia, occur quite frequently. These reactions are significantly more common following DTP than following DT, are usually self-limited, and need no therapy other than, perhaps, symptomatic treatment (e.g., antipyretics).

Moderate to severe systemic events, such as fever of 40.5 C (105 F) or higher, persistent, inconsolable crying lasting 3 hours or more, unusual high-pitched crying, collapse, or convulsions, occur relatively infrequently. Other more severe neurologic complications, such as a prolonged convulsion or an encephalopathy, occasionally fatal, have been reported to be associated with DTP administration, although rarely.

Approximate rates for adverse events following receipt of DTP vaccine (regardless of dose number in the series) are indicated in Table 3 (5,6).

The frequency of local reactions and fever following DTP vaccination is significantly higher with increasing numbers of doses of DTP, while other mild to moderate systemic reactions (e.g., fretfulness, vomiting) are significantly less frequent (5). If local redness of 2.5 cm or greater occurs, the likelihood of recurrence after another DTP dose increases significantly (7).

In the National Childhood Encephalopathy Study (NCES), a large, case-control study in England (6), children 2-35 months of age with serious, acute neurologic disorders, such as encephalopathy or complicated convulsion(s), were more likely to have received DTP in the 7 days preceding onset than their age-, sex-, and neighborhood-matched controls. Among children known to be neurologically normal before entering the study, the relative risk<sup>8</sup> of a neurologic illness occurring within the 7-day period following receipt of DTP dose, compared to children not receiving DTP vaccine in the 7-day period before onset of their illness, was 3.3 ( $p < 0.001$ ). Within this 7-day period, the risk was significantly increased for immunized children only within 3 days of vaccination (relative risk 4.2,  $p < 0.001$ ). The relative risk for illness occurring 4-7 days after vaccination was 2.1 ( $0.05 < p < 0.1$ ). The attributable risk estimates for a serious acute neurologic disorder within 7 days after DTP vaccine (regardless of outcome) was one in 110,000 doses of DTP, and for a permanent neurologic deficit, one in 310,000 doses. No specific clinical syndrome was identified. Overall, DTP vaccine accounted for only a small proportion of cases of serious neurologic disorders reported in the population studied.

Although there are uncertainties in the reported studies, recent data suggest that infants and young children who have had previous convulsions (whether febrile or nonfebrile) are more likely to have seizures following DTP than those without such histories (8).

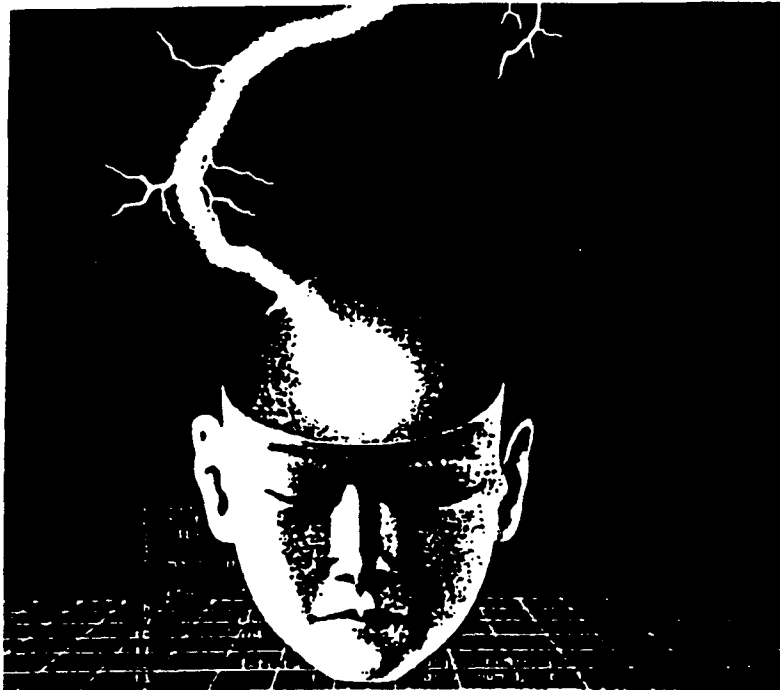

# A Shot in the Dark?

## How scientists gamble a year ahead when creating flu vaccines

By David Brown  
Washington Post Staff Writer

**E**ven though many Washingtonians have barely gotten over the effects of this winter's flu, a group of government scientists is playing a high-stakes game of chance with next winter's virus.

Scientists at the Food and Drug Administration are choosing the final formula for next season's influenza vaccine. If they choose well, a \$15 flu shot will offer substantial protection. It will even save lives. But if they choose poorly, the flu shot will be little better than a sharp poke in the arm.

The formula amounts to a gamble because nobody really knows what "strains" of influenza virus will make people sick eight months from now. That uncertainty, however, will not keep FDA scientists from making their best bets, and drug companies from taking those bets and turning them into \$100 million worth of influenza vaccine.

The demand for flu shots rises each year, as public health officials, and many physicians, urge their use by persons over 65 and those with chronic illnesses. This winter's experience is expected to drive demand even higher.

Influenza arrived in the Washington area (and most of the rest of the country, as well) at the end of November, about a month earlier than usual. The illness was harsher, and its mortality higher, than most years. Many clinics and physicians' offices ran out of flu shots.

Last year, about 38 million doses were made, up from 23 million in 1985. The four U.S. manufacturers—Connaught Laboratories, Parke-Davis Sterile Products, Wyeth-Ayerst Laboratories and Lederle Laboratories—are markedly boosting production for next season.

Though influenza rarely is fatal itself, it contributes substantially to the mortality of the elderly and people with chronic illnesses, who often die of complications such as pneumonia. Influenza and pneumonia—the two are listed together in death statistics gathered by the government—are the sixth leading cause of death in the country.

A typical example of influenza's danger was recently described in a report from the Centers for Disease Control. Sixty-five residents of a New York nursing home came down with flu. Half developed pneumonia. Nineteen had to be admitted to the hospital, and two died.

"People do not think that much about influenza. They think, 'AIDS is important, but influenza is not important,'" says Yuri Ghendon, a virologist and the director of the influenza program at the World Health Organization (WHO). "But this is not a trivial disease. It kills many people, and its economic impact is enormous."

Unlike the agents of most infectious diseases, the virus that causes influenza evolves in important ways every year. A shot designed to protect against this winter's flu is not likely to help against next winter's.

But because it takes six months to make the vaccine, by the time flu season arrives, it's too late to make a shot that works. Consequently, the only option is to predict long in advance of flu season what strains of virus will cause illness.

This is the season of prediction. Since January, scientists from the FDA and CDC have been studying virus samples from around the world, looking for strains that have just evolved and for those previously encountered but now spreading widely.

With advice from a panel of academic scientists, the government officials make three selections from this long and varied "menu" of viruses. That number is needed because three general types of influenza virus can cause human illness. Two are in the family designated influenza A, and the third is the family designated influenza B.

Once chosen, samples of the viruses are sent to the drug companies, which grow them on an industrial scale. Measured amounts of the three strains—after being purified and chemically inactivated so they cannot cause illness—are combined. The resulting mixture is the vaccine.

In practice, the FDA picks the three components over a period of about six weeks. Staggering the decisions allows manufacturers to begin production on one component while the

formulators wait for more information on the others.

"It would be nice if we could wait until April, until the influenza season is over, to come up with the formula," says Roland Levandowski, an FDA scientist. "But it's just not practical."

A case in point occurred in 1966.

In April that year, a strain of virus was isolated in Taiwan that looked "new" and virulent, a good candidate for vaccine. But the formula already had been decided. So the FDA recommended that manufacturers produce a small batch of supplement, to be given to especially high-risk people.

The choice was both right and irrelevant. The Taiwan strain caused 99 percent of flu in the United States the next year. But by the time the supplemental vaccine was ready, the season was nearly over. Most of the shots were returned to the manufacturers unused.

Simultaneous with the American deliberations are similar ones in Geneva, headquarters of WHO. The latter's vaccine formula is usually the same as the FDA's, and is followed by European manufacturers.

"Everybody uses the same information, and in general you expect that the same viruses will be spreading around the world," says Alan Kendal, a biologist who once headed the CDC's influenza branch and now works for WHO.

Epidemiologists estimate that in a normal year, about 500 million people, or 10 percent of the world's population, contract influenza. (In years of pandemic, the number is in the billions.) CDC gauges influenza mortality by sampling death certificates from 121 American cities each week.

**T**his season, there have been seven consecutive weeks in which the death rate from influenza and pneumonia was greater than expected. At its peak in mid-January, 7.8 percent of deaths were attributed to those illnesses, compared with an expected 6.4 percent this time of year.

The illness appears unafraid during each hemisphere's winter, in part because of the virus's ability to survive longer in conditions of low humidity. The increased crowding characteristic of cold-weather months further promotes its spread, scientists believe.

Because it is a virus, not a bacterium, influenza cannot be treated with antibiotics, and antiviral drugs have only



limited usefulness. The only practical weapons are the antibodies created by each individual's immune system.

After a case of the flu, a person usually acquires lifelong immunity to the strain of virus that caused the illness. Over time and after more bouts, a person builds up a "pharmacy" of antibodies. These protect against the "old" viruses—which occasionally reappear—and offer partial defense against newer ones closely related to them.

By stimulating more antibodies, the influenza vaccine supplements this "pharmacy." That does not necessarily guarantee a person will not get the flu, but it increases the chances that a case will be mild, and, in the elderly, cuts the risk of dying by 85 percent.

That is assuming, of course, that the vaccine contains the right strains.

Unlike bacteria, viruses are entirely dependent on living hosts. They are not living organisms, but packets of genetic instructions that have evolved the ability to invade living cells. Once inside, they commandeer the cell's machinery, forcing it to reproduce the virus.

Influenza's "host range" is vast, including waterfowl, horses and pigs, as well as humans. Though individual virus particles may survive briefly in the open air, as a "species" influenza must maintain infection if it is not to become extinct.

Each strain of virus gets its particular identity from two proteins on the outside of the virus envelope—called "H" and "N"

NOTICE THAT THE MAJOR FLU EPIDEMIC OF 1918, AS WELL AS SEVERAL OTHER FLU EPIDEMICS, BEGAN AT MILITARY BASES.

in microbiological shorthand. The H-and-N configuration is relatively permanent, forming a kind of musical theme, of which the year-to-year changes are variations.

Once every 30 or 40 years, an influenza virus emerges with an H-and-N configuration entirely different from the ones in circulation. Even a well-prepared immune system cannot immediately recognize and combat it. This event, called a "shift," generally heralds a worldwide epidemic.

Scientists believe that at least one shift, and possibly two, occurred in 1918-19, when influenza killed an estimated 30 million people. The last shift occurred in 1968, and the result was the worldwide epidemic of "Hong Kong flu."

Between shifts, the virus "drifts." As a strain of influenza moves through a host population, producing trillions of offspring, mutations inevitably creep in. They eventually change the surface proteins that give the strain its identifying characteristics and the virus's identity will "drift" away from that of its ancestors. Eventually, the difference is so great that antibodies against the ancestors no longer recognize the descendant.

The regular task of influenza epidemiologists is to detect drift in the circulating families of virus, and determine which ones have immunological significance.

The search begins with a network of 150 sampling sites, in 79 countries, that is coordinated by WHO. In these clinics, nurses and doctors take throat cultures of a sample of patients with flu symptoms. Preliminary identification of the virus is done in these countries, and interesting strains are forwarded to one of three WHO collaborating influenza centers, in Atlanta, at CDC; in London; and in Melbourne, Australia. There, each sample is purified and given a name.

Like race-track handicappers, scientists at those labs are constantly on the lookout for "comers" in the stable of isolated viruses, strains that are new and different enough to pose a threat.

Just such a strain was detected last year. A strain of influenza A, it had first been swabbed off a throat in Beijing in November 1988. It caused some flu in China that season, and later spread to India, South Africa, Australia and New Zealand, causing illness during the Southern Hemisphere's winter.

Though influenza B, not influenza A, was the dominant type of virus in North America last winter, epidemiologists noticed an outbreak of cases caused by the Chinese strain at the end of the flu season. Known as a "herald wave," such an outbreak signals the arrival of a viral strain that may surge the follow-

ing autumn.

Tests showed the current vaccine did not protect against "Beijing/353/89," as the strain was named. The new strain had drifted too far from the vaccine component that purported to represent it. So, the vaccine formulators decided to drop the old component, and put "Beijing" in its place. The bet paid off.

**T**his winter, a strain of influenza A has accounted for more than 80 percent of the influenza in North America, and 98 percent of it was of the "Beijing" variety. Anybody who got this year's flu shot was ready for it.

Given the speed of viral evolution, it is not surprising that no strain stays in the vaccine very long. On average, about one of the three components is dropped each year and replaced by a new one. Adding a new component, however, is a lot of work for drug companies, so the formulators are loath to recommend it lightly.

In a recent meeting at the FDA, influenza experts debated whether to replace "Beijing" with another strain in its family. Though about 30 are circulating worldwide (including one called "Washington/15/91" that was first isolated here), the scientists finally decided they all looked pretty much like "Beijing." "Beijing" will stay in the formula another year.

The gathered experts were more uncertain about the other family of influenza A viruses. Its representative in the vaccine is "Taiwan/1/86," the strain used for the ill-fated supplemental vaccine. "Taiwan" has been part of the regular flu shot since 1967.

"That is unusual longevity for a vaccine component," Louise Chapman, an influenza specialist at the CDC, says. "It's kind of about time for it to be replaced."

Cases of "Taiwan" have dwindled over the years, as the virus has run out of susceptible hosts to infect. As expected, an ambitious offspring has emerged to take the place of its aged parent.

In the middle of October, a 5-year-old girl went to a clinic in Houston with symptoms of the flu. Her throat swab was sent to Baylor College of Medicine, whose influenza center runs about 7,000 influenza cultures a year. The sample was sent on to CDC, whose final identification showed the virus to be quite different from ones that had been seen before. Antibodies to "Taiwan" attacked it only weakly.

"Texas/36/91," as the strain is named, almost certainly did not originate in the girl from Texas. It was simply detected in her first. Since then, surveillance labs have found it from New England to the Pacific Coast. The FDA was deciding whether to make it a component of next year's vaccine.

If "Texas" turns out to be a major cause of flu, it will mark one of the few recent occasions when an important new virus has

emerged outside China.

For reasons that are not entirely clear, China is by far the most fertile ground for influenza virus. "Beijing" and "Taiwan" arose there. "Qingdao" and "Guangdong," two worrisome strains of influenza B virus now circulating, arose there. Even the memorable epidemics of the last 40 years—"Asian flu" and "Hong Kong flu"—have ancestors in the Far East.

The most frequently offered theory is that, with its 2 billion people, China simply is the biggest "host range" for the virus of any place on Earth.

"It may simply be the effect of the virus going through more cycles in a large population," says Robert G. Webster, a virologist and influenza specialist at St. Jude Children's Research Hospital in Memphis. "The more it multiplies, the more mistakes it makes."

After each year's three vaccine components are determined, the last—and hardest—part of the process begins: Drug companies must turn the virus samples into more than 40 million shots. Vaccine manufacture consists of inoculating fertile chicken eggs with virus, incubating them for two to three days, and then harvesting a substance in the embryo called the allantoic fluid, where the virus has multiplied in the millions.

The virus must then be separated from the fluid, purified and chemically "killed." At various steps along the way, the manufacturers must show the FDA that the "seed" virus has not mutated, and they also must test the potency of their product in laboratory animals.

There is no guarantee, however, that a strain of virus flourishing in the wild will grow well in the factory. Two of the three strains in the 1987 vaccine were notoriously poor growers, causing some companies to miss their production targets.

Manufacturers are expecting a jump in demand for next season's shots. The biggest producer, Connaught Laboratories of Switzwater, Pa., already has seen orders for next year increase 15 percent, according to a spokesman.

Supply and demand, however, do not operate classically. By the time flu season arrives, the production lines will be shut down and the supply of vaccine will be fixed. No amount of demand will coax manufacturers to make more. Traditionally, the problem has been oversupply, with 10 percent to 20 percent of each year's production returned to the drug companies.

Now, though, the production lines are in full lather. Connaught was taking delivery of 110,000 fertilized chicken eggs a day and working seven-day weeks even before the last component of the formula was decided.

"The influenza campaign," says Al Reinhardt, the company's director of vaccine production, "is always a challenge." ■

## It All Started in Kansas

**T**he influenza epidemic of 1918-19 killed an estimated 550,000 Americans, a ghastly toll, but one that, compared to the rest of the world, seems almost good fortune.

New research places global mortality from the pandemic at 30 million people. Previously, it was estimated at 21.5 million. In either case, it ranks as the 20th century's most readily forgotten global disaster, and almost certainly the deadliest epidemic in recorded history.

Even today, its virulence remains an utter mystery.

The disease swept whole countries in weeks. An entire port city in Nigeria was infected by fewer than 10 persons. Only American Samoa and portions of northern and eastern Iceland were able to establish successful quarantines.

Though mortality was high in all age groups, it was highest in people 20 to 40 years old, exactly the population that usually would be the hardest.

"I did a history of the influenza epidemics in the 18th and 19th centuries, and one of the things I looked for was anything that resembled this age pattern," says K. David Patterson, a professor of history at the University of North Carolina in Charlotte. "I found nothing like it. It is unique."

Patterson and colleague Gerald F. Pyle published their recalculations of the epidemic's mortality last year in the Bulletin of the History of Medicine. According to the research, India probably had the highest mortality, between 42 and 67 deaths from influenza per 1,000 population. In contrast, the death rate in the United States was 5.2 per 1,000.

Though the disease became known as the "Spanish flu," the best evidence is that it broke out March 8, 1918, in Camp Funston, Kan. Scientists speculate that it was the result of a dramatic genetic "shift" in the influenza virus. Such

events occur every 30 or 40 years and usually usher in a worldwide epidemic of the new strain.

This particular strain, however, traveled faster and was more dangerous than its predecessors. It arrived in Europe on American troop ships in early April 1918, and by July it spread as far east as Poland.

What happened there—if current theories are correct—amounts to bad luck of almost incalculable proportions. Somewhere on the Western Front, the virus underwent a second "shift," and the result was a virus far more lethal than even its lethal parent. It was that strain that swept round the world, killing millions.

**I**n the spring of 1919, the virus played itself out, and disappeared. Though there are no samples of the pandemic's strain, antibody tests of the people who lived through it have given biologists a guess at the identity of the virus.

They believe the virus, or a close descendant, is now "archived" in pigs, one of the many non-human reservoirs of influenza, and one where a virus changes much more slowly than it does in man.

In 1976, an outbreak of influenza at Fort Dix, N.J., killed a healthy soldier. When laboratory studies showed his virus to be similar to the one in pigs, virologists feared the deadly 1918 strain had reentered the human population. This led to production of the controversial "swine flu" vaccine. As it happened, the Fort Dix strain never reappeared.

There is good evidence, however, that there is an occasional exchange of virus between animal and human populations, and that these may be the source of some of the more virulent influenza epidemics. ■



—David Brown

A soldier treated at Fort Porter, N.Y., in the 1918-19 epidemic

# Prevention and Control of Influenza

## Recommendations of the Immunization Practices Advisory Committee (ACIP)

*These recommendations update information on the vaccine and antiviral agents available for controlling influenza during the 1991-1992 influenza season (superseding both the MMWR 1990;39 (no. RR-7):1-15 and the clarification, MMWR 1990;39:469.) The primary changes include statements about the influenza strains in the trivalent vaccine for 1991-1992.*

### INTRODUCTION

Influenza A viruses are classified into subtypes on the basis of two surface antigens: hemagglutinin (H) and neuraminidase (N). Three subtypes of hemagglutinin (H1, H2, H3) and two subtypes of neuraminidase (N1, N2) are recognized among influenza A viruses that have caused widespread human disease. Immunity to these antigens—especially to the hemagglutinin—reduces the likelihood of infection and lessens the severity of disease if infection occurs. Infection with a virus of one subtype confers little or no protection against viruses of other subtypes. Furthermore, over time, antigenic variation (antigenic drift) within a subtype may be so marked that infection or vaccination with one strain may not induce immunity to distantly related strains of the same subtype. Although influenza B viruses have shown more antigenic stability than influenza A viruses, antigenic variation does occur. For these reasons, major epidemics of respiratory disease caused by new variants of influenza continue to occur. The antigenic characteristics of strains currently circulating provide the basis for selecting virus strains to include in each year's vaccine.

Typical influenza illness is characterized by abrupt onset of fever, myalgia, sore throat, and nonproductive cough. Unlike other common respiratory infections, influenza can cause severe malaise lasting several days. More severe illness can result if primary influenza pneumonia or secondary bacterial pneumonia occur. During influenza epidemics, high attack rates of acute illness result in increased numbers of visits to physicians' offices, walk-in clinics, and emergency rooms and increased hospitalizations for management of lower-respiratory-tract complications.

Elderly persons and persons with underlying health problems are at increased risk for complications of influenza infection. If infected, such high-risk persons or groups (listed as "groups at increased risk for influenza-related complications" under Target Groups for Special Vaccination Programs) are more likely than the general population to require hospitalization. During major epidemics, hospitalization rates for high-risk persons may increase 2- to 5-fold, depending on the age group. Previously healthy children and younger adults may also require hospitalization for influenza-related complications, but the relative increase in their hospitalization rates is less than for persons who belong to high-risk groups.

An increase in mortality further indicates the impact of influenza epidemics. Increased mortality results not only from influenza and pneumonia but also from cardiopulmonary and other chronic diseases that can be exacerbated by influenza infection. At least 10,000 excess deaths have been documented in each of 19 different U.S. epidemics in the period 1957-1986; more than 40,000 excess deaths occurred in each of three of these epidemics. Approximately 80%-90% of the excess deaths attributed to pneumonia and influenza were among persons  $\geq$  65 years of age.

Because the proportion of elderly persons in the U.S. population is increasing and because age and its associated chronic diseases are risk factors for severe influenza illness, the toll from influenza can be expected to increase unless control measures are used more vigorously. The number of younger persons at increased risk for influenza-related complications is also increasing for various reasons, such as the success of neonatal intensive care units, better management of diseases such as cystic fibrosis and acquired immunodeficiency syndrome (AIDS), and better survival rates for organ-transplant recipients.

### OPTIONS FOR THE CONTROL OF INFLUENZA

Two measures available in the United States that can reduce the impact of influenza are immunoprophylaxis with inactivated (killed-virus) vaccine and chemoprophylaxis or therapy with an

influenza-specific antiviral drug (e.g., amantadine). Vaccination of high-risk persons each year before the influenza season is currently the most effective measure for reducing the impact of influenza. Vaccination can be highly cost-effective when a) it is directed at persons who are most likely to experience complications or who are at increased risk for exposure, and b) it is administered to high-risk persons during hospitalization or a routine health-care visit before the influenza season, thus making special visits to physicians' offices or clinics unnecessary. Recent reports indicate that—when vaccine and epidemic strains of virus are well matched—achieving high vaccination rates among closed populations can reduce the risk of outbreaks by inducing herd immunity.

Other indications for vaccination include the strong desire of any person to avoid influenza infection, reduce the severity of disease, or reduce the chance of transmitting influenza to high-risk persons with whom the individual has frequent contact. The antiviral agent available for use at this time (amantadine hydrochloride) is effective only against influenza A and, for maximum effectiveness as prophylaxis, must be used throughout the period of risk. When used as either prophylaxis or therapy, the potential effectiveness of amantadine must be balanced against potential side effects.

Chemoprophylaxis is not a substitute for vaccination. Recommendations for chemoprophylaxis are provided primarily to help health-care providers make decisions regarding persons who are at greatest risk of severe illness and complications if infected with an influenza A virus. Use of amantadine may be considered a) as a control measure when influenza A outbreaks occur in institutions housing high-risk persons, both for treatment of ill individuals and as prophylaxis for others; b) as short-term prophylaxis after late vaccination of high-risk persons (i.e., when influenza A infections are already occurring in the community) during the period when immunity is developing in response to vaccination; c) as seasonal prophylaxis for individuals for whom vaccination is contraindicated; d) as seasonal prophylaxis for immunocompromised individuals who may not produce protective levels of antibody in response to vaccination; and e) as prophylaxis for unvaccinated health-care workers and household contacts who care for high-risk persons either for the duration of influenza activity in the community or until immunity develops after vaccination.

Amantadine is also approved for use by any person who wishes to reduce his or her chances of becoming ill with influenza A.

## **INACTIVATED VACCINE FOR INFLUENZA A AND B**

Influenza vaccine is made from highly purified, egg-grown viruses that have been rendered noninfectious (inactivated). Therefore, the vaccine cannot cause influenza. Each year's influenza vaccine contains three virus strains (usually two type A and one type B) representing influenza viruses believed likely to circulate in the United States in the upcoming winter. The composition of the vaccine is such that it rarely causes systemic or febrile reactions. Whole-virus, subvirion, and purified-surface-antigen preparations are available. To minimize febrile reactions, only subvirion or purified-surface-antigen preparations should be used for children; any of the preparations may be used for adults. Most vaccinated children and young adults develop high postvaccination hemagglutination-inhibition antibody titers that are protective against infection by strains similar to those in the vaccine or the related variants that may emerge during outbreak periods. Elderly persons and persons with certain chronic diseases may develop lower postvaccination antibody titers than healthy young adults, and thus may remain susceptible to influenza upper-respiratory-tract infection. Nevertheless, even if such persons develop influenza illness, the vaccine has been shown to be effective in preventing lower-respiratory-tract involvement or other complications, thereby reducing the risk of hospitalization and death.

## **RECOMMENDATIONS FOR USE OF INFLUENZA VACCINE**

Influenza vaccine is strongly recommended for any person  $\geq 6$  months of age who—because of age or underlying medical condition—is at increased risk for complications of influenza. Health-care workers and others (including household members) in close contact with high-risk persons should also be vaccinated. In addition, influenza vaccine may be given to any person who wishes to reduce the chance of becoming infected with influenza. The trivalent influenza vaccine prepared for the 1991-1992

season will include A/Taiwan/1/86-like(H1N1), A/Beijing/353/89-like (H3N2), and B/Panama/45/90-like hemagglutinin antigens. Recommended doses are listed in Table 1. Guidelines for the use of vaccine among different groups follow.

Although the current influenza vaccine can contain one or more antigens used in previous years, annual vaccination using the current vaccine is necessary because immunity for an individual declines in the year following vaccination. Because the 1991-1992 vaccine differs from the 1990-1991 vaccine, supplies of 1990-1991 vaccine should not be used to provide protection for the 1991-1992 influenza season.

Two doses may be required for a satisfactory antibody response among previously unvaccinated children <9 years of age; however, studies with vaccines similar to those in current use have shown little or no improvement in antibody responses when a second dose is given to adults during the same season.

During the past decade, data on influenza vaccine immunogenicity and side effects have been obtained when vaccine has been administered intramuscularly. Because there has been no adequate evaluation of recent influenza vaccines administered by other routes, the intramuscular route is the one recommended for use. Adults and older children should be vaccinated in the deltoid muscle, and infants and young children in the anterolateral aspect of the thigh.

## TARGET GROUPS FOR SPECIAL VACCINATION PROGRAMS

To maximize protection of high-risk persons, they and their close contacts should be targeted for organized vaccination programs.

### Groups at Increased Risk for Influenza-Related Complications:

1. Persons  $\geq 65$  years of age.
2. Residents of nursing homes and other chronic-care facilities housing persons of any age with chronic medical conditions.
3. Adults and children with chronic disorders of the pulmonary or cardiovascular systems, including children with asthma.
4. Adults and children who have required regular medical follow-up or hospitalization during the preceding year because of chronic metabolic diseases (including diabetes mellitus), renal dysfunction, hemoglobinopathies, or immunosuppression (including immunosuppression caused by medications).
5. Children and teenagers (6 months-18 years of age) who are receiving long-term aspirin therapy and therefore may be at risk of developing Reye syndrome after influenza.

**TABLE 1. Influenza vaccine\* dosage, by patient age — United States, 1991–92 season**

Age group	Product <sup>†</sup>	Dosage	No. doses	Route <sup>‡</sup>
6-35 mos.	Split virus only	0.25 mL	1 or 2 <sup>§</sup>	IM
3-8 yrs.	Split virus only	0.50 mL	1 or 2 <sup>§</sup>	IM
9-12 yrs.	Split virus only	0.50 mL	1	IM
$\geq 12$ yrs.	Whole or split virus	0.50 mL	1	IM

\*Contains 15 $\mu$ g each of A/Taiwan/1/86-like (H1N1), A/Beijing/353/89 (H3N2), and B/Panama/45/90-like hemagglutinin antigens in each 0.5 mL. Manufacturers include: Connaught Laboratories, Inc. (distributed by E.R. Squibb & Sons, Inc.) (Fluzone<sup>®</sup> whole or split); Evans Medical Ltd.-Lederle Laboratories (distributed by Lederle Laboratories) (Flu-Imune<sup>®</sup> purified surface antigen vaccine); Parke-Davis (Fluogen<sup>®</sup> split); and Wyeth-Ayerst Laboratories (Influenza Virus Vaccine, Trivalent<sup>®</sup> split). For further product information call Connaught, (800) 822-2463; Lederle, (800) 522-3753; Parke-Davis, (800) 233-0432; Wyeth-Ayerst, (800) 950-5099.

<sup>†</sup>Because of the lower potential for causing febrile reactions, only split-virus vaccines should be used for children. They may be labeled as "split," "subvirion," or "purified-surface-antigen" vaccine. Immunogenicity and side effects of split- and whole-virus vaccines are similar for adults when vaccines are used at the recommended dosage.

<sup>‡</sup>The recommended site of vaccination is the deltoid muscle for adults and older children. The preferred site for infants and young children is the anterolateral aspect of the thigh.

<sup>§</sup>Two doses are recommended for children <9 years of age who are receiving influenza vaccine for the first time.

should be offered influenza vaccine. Except in years of pandemic influenza (e.g., 1957 and 1968), high levels of influenza activity rarely occur in the contiguous 48 states before December. Therefore, November is the optimal time for organized vaccination campaigns for high-risk persons. In facilities such as nursing homes, it is particularly important to avoid administering vaccine too far in advance of the influenza season because antibody levels begin declining within a few months. Vaccination programs may be undertaken as soon as current vaccine is available if regional influenza activity is expected to begin earlier than December.

Children <9 years of age who have not previously been vaccinated should receive two doses of vaccine at least a month apart to maximize the chance of a satisfactory antibody response to all three vaccine antigens. The second dose should be given before December, if possible. Vaccine should be offered to both children and adults up to and even after influenza virus activity is documented in a community, as late as April in some years.

## **ANTIVIRAL AGENTS FOR INFLUENZA A**

The two antiviral agents with specific activity against influenza A viruses are amantadine hydrochloride and rimantadine hydrochloride. Only amantadine is licensed for use in the United States. These chemically related drugs interfere with the replication cycle of type A (but not type B) influenza viruses, although the specific mechanisms of their antiviral activity are not completely understood. When given prophylactically to healthy young adults or children in advance of and throughout the epidemic period, amantadine is approximately 70%-90% effective in preventing illnesses caused by naturally occurring strains of type A influenza viruses. When administered to otherwise healthy young adults and children for symptomatic treatment within 48 hours after the onset of influenza illness, amantadine has been shown to reduce the duration of fever and other systemic symptoms and may permit a more rapid return to routine daily activities. Since antiviral agents taken prophylactically may prevent illness but not subclinical infection, some persons who take these drugs may still develop immune responses that will protect them when exposed to antigenically related viruses in later years.

As with all drugs, symptoms may occur that are side effects of amantadine among a small proportion of persons. Such symptoms are rarely severe, but may be important for some categories of patients.

### **Development of Drug-Resistant Viruses**

Amantadine-resistant influenza viruses can emerge when amantadine is used for treatment. The frequency with which resistant isolates emerge and the extent of their transmission are unknown, but there is no evidence that amantadine-resistant viruses are more virulent or more transmissible than amantadine-sensitive viruses. Thus the use of amantadine remains an appropriate outbreak control measure. In closed populations such as nursing homes, persons who have influenza and are treated with amantadine should be separated, if possible, from asymptomatic persons who are given amantadine as prophylaxis. Because of possible induction of amantadine resistance, it is advisable to discontinue amantadine treatment of persons who have influenza-like illness as soon as clinically warranted, generally within 3-5 days. Isolation of influenza viruses from persons who are receiving amantadine should be reported through state health departments to CDC and the isolates saved for antiviral sensitivity testing.

## **SOURCES OF INFORMATION ON INFLUENZA-CONTROL PROGRAMS**

Educational materials about influenza and its control are available from several sources, including CDC. Information can be obtained from Technical Information Services, Center for Prevention Services, Mailstop E06, CDC, Atlanta, GA 30333. Telephone number: (404) 639-1819. State and local health departments should also be consulted regarding availability of vaccine and access to vaccination programs.



# Influenza

## SIDE EFFECTS AND ADVERSE REACTIONS

Because influenza vaccine contains only noninfectious viruses, it cannot cause influenza. Respiratory disease after vaccination represents coincidental illness unrelated to influenza vaccination. The most frequent side effect of vaccination is soreness at the vaccination site that lasts for up to 2 days; this is reported for fewer than one-third of vaccinees. In addition, two types of systemic reactions have occurred:

1. Fever, malaise, myalgia, and other systemic symptoms occur infrequently and most often affect persons who have had no exposure to the influenza virus antigens in the vaccine (e.g., young children). These reactions begin 6-12 hours after vaccination and can persist for 1 or 2 days.
2. Immediate—presumably allergic—reactions (such as hives, angioedema, allergic asthma, or systemic anaphylaxis) occur rarely after influenza vaccination. These reactions probably result from hypersensitivity to some vaccine component—most likely residual egg protein. Although current influenza vaccines contain only a small quantity of egg protein, this protein presumably induces immediate hypersensitivity reactions among persons with severe egg allergy. Persons who have developed hives, have had swelling of the lips or tongue, or experienced acute respiratory distress or collapse after eating eggs should not be given the influenza vaccine. Persons with documented immunoglobulin E (IgE)-mediated hypersensitivity to eggs—including those who have had occupational asthma or other allergic responses from exposure to egg protein—may also be at increased risk for reactions from influenza vaccine. The protocol for influenza vaccination developed by Murphy and Strunk may be considered for patients who have egg allergies and medical conditions that place them at increased risk for influenza infection or its complications (See Murphy and Strunk, 1985).

Unlike the 1976 swine influenza vaccine, subsequent vaccines prepared from other virus strains have not been clearly associated with an increased frequency of Guillain-Barré syndrome. Although influenza vaccination can inhibit the clearance of warfarin and theophylline, studies have failed to show any adverse clinical effects attributable to these drugs among patients receiving influenza vaccine.



U.S. DEPARTMENT OF HEALTH AND HUMAN SERVICES  
Public Health Service  
Centers for Disease Control  
Center for Infectious Diseases  
Division of Viral and Rickettsial Diseases  
Atlanta, Georgia 30333



**MMWR****MORBIDITY AND MORTALITY WEEKLY REPORT**

- 341 ACIP: Smallpox Vaccine
- 343 Investigation of a Smallpox Rumor — Mexico
- 344 Legionellosis — Staffordshire, England, and Wayne County, Michigan
- 350 Observations of Reproductive Functions among Workers in an Oil Refinery — Louisiana
- 352 Reported Measles Cases — United States, Past 4 Weeks

***Recommendation of the Immunization******Practices Advisory Committee (ACIP)*****Smallpox Vaccine**

*These revised ACIP recommendations on smallpox vaccine update the previous recommendations (MMWR 1980;29:417-20) to include current information on the changes in the International Health Regulations and the ending of distribution of smallpox vaccine to civilians. The basic recommendation is unchanged—smallpox vaccine is only indicated for civilians who are laboratory workers occupationally exposed to smallpox or other closely related orthopox viruses.*

**SMALLPOX VACCINE**

Smallpox vaccine (vaccinia virus) is a highly effective immunizing agent against smallpox. The judicious use of smallpox vaccine has eradicated smallpox. At the World Health Assembly in May 1980, the World Health Organization (WHO) declared the world free of smallpox (1-4). Smallpox vaccination of civilians is now indicated *only* for laboratory workers directly involved with smallpox (variola virus) or closely related orthopox viruses (e.g., monkeypox, vaccinia, and others).

**SURVEILLANCE OF SUSPECTED CASES OF SMALLPOX**

There is no evidence of smallpox transmission anywhere in the world. WHO has coordinated the investigation of 173 rumors of smallpox between 1979 and 1984 (5-7). All have been diseases other than smallpox, most commonly chickenpox or other rash illnesses. Even so, a suspected case of smallpox is a public health emergency and must be promptly investigated. Assistance in the clinical evaluation, collection of laboratory specimens, and preliminary laboratory diagnosis is available from state health departments and CDC (telephone: (404) 329-3145 during the day and (404) 329-2888 outside usual working hours).

**MISUSE OF SMALLPOX VACCINE**

There is no evidence that smallpox vaccination has any value in the treatment or prevention of recurrent herpes simplex infection, warts, or any disease other than those caused by orthopox viruses (8). Misuse of smallpox vaccine to treat herpes infections has been associated with severe complications (9-11). Smallpox vaccine should never be used therapeutically.

**SMALLPOX VACCINATION NOT REQUIRED FOR INTERNATIONAL TRAVEL**

Smallpox vaccination is no longer required for international travel. In January 1982, the International Health Regulations were changed deleting smallpox from the Regulations (12). The International Certificates of Vaccination no longer include a smallpox vaccination certificate.

**SMALLPOX VACCINE NO LONGER AVAILABLE FOR CIVILIANS**

In May 1983, the only active, licensed producer of smallpox vaccine in the United States discontinued distribution of smallpox vaccine to civilians (13). As a result, smallpox vaccine is no longer available to civilians.

## SOURCES OF VACCINE INFORMATION

In addition to these general recommendations, the practitioner can draw on a variety of sources for specific data and updated information including:

**Official vaccine package circulars.** Manufacturer-provided product-specific information approved by the FDA with each vaccine. Some of these materials are reproduced in the *Physician's Desk Reference (PDR)*.

***Morbidity and Mortality Weekly Report (MMWR)***. Published weekly by CDC, *MMWR* contains regular and special ACIP recommendations on vaccine use and statements of vaccine policy as they are developed and reports of specific disease activity. Subscriptions are available through Superintendent of Documents, U.S. Government Printing Office, Washington, DC 20402. Also available through MMS Publications, C.S.P.O. Box 9120, Waltham, MA 02254.

***Health Information for International Travel***. Booklet published annually by CDC as a guide to national requirements and with recommendations for specific immunizations and health practices for travel to foreign countries. Purchase from the Superintendent of Documents (address above).

**Advisory memoranda** are published as needed by CDC to advise international travelers or persons who provide information to travelers about specific outbreaks of communicable diseases abroad. They include health information for prevention and specific recommendations for immunization. Memoranda and/or placement on mailing list are available from Division of Quarantine, Center for Prevention Services (CPS), CDC, Atlanta, GA 30333.

***The Report of the Committee on Infectious Diseases*** of the American Academy of Pediatrics (**Red Book**). This report, which contains recommendations on all licensed vaccines, is updated every 2-3 years, most recently in 1988. Policy changes for individual recommendations for immunization practices are published as needed by the American Academy of Pediatrics in the journal *Pediatrics*. They are available from American Academy of Pediatrics, Publications Division, 141 Northwest Point Blvd., P.O. Box 927, Elk Grove Village, IL 60009-0927.

***Control of Communicable Diseases in Man*** is published by the American Public Health Association every 5 years, most recently in 1985 (14th ed.) The manual contains information about infectious diseases, their occurrence worldwide, diagnoses and therapy, and up-to-date recommendations on isolation and other control measures for each disease presented. It is available from the American Public Health Association, 1015 Fifteenth St. N.W., Washington, DC 20005.

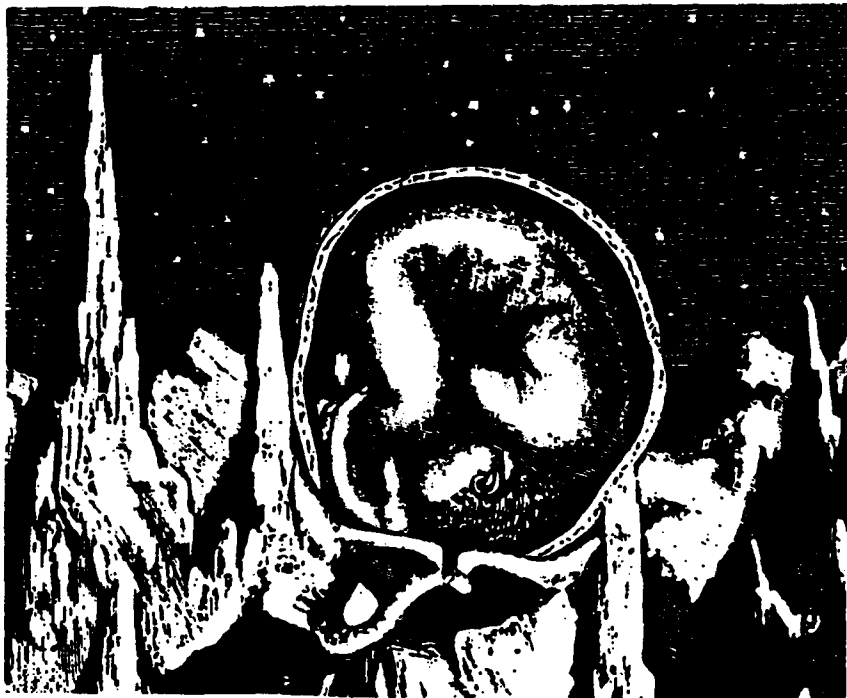





# M A T R I X I I I

## AN EXAMINATION OF RETROVIRUSES

The AIDS virus, HTLV-3, is one of several retroviruses that current inhabit human beings. What is a retrovirus? The term "retrovirus" is derived from the fact that these viruses, which cannot reproduce themselves outside of living tissue, contain a substance called "reverse transcriptase" (RT), which is an enzyme that is contained in specific animal and human viruses that is in RNA form. These enzymes are responsible for duplication of the genetic material of the virus. Human genetic material is in a DNA form. The RT in retroviruses such as HTLV has the ability to duplicate itself into a DNA format when inside the human cell and insert itself into the human DNA. Henceforth, the "loaded" human DNA will then produce more HTLV viruses during the process of destruction of the human cell.

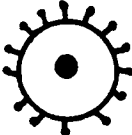
The immune system of the human body consists primarily of "B-cells", which control production of antibodies and bacterial infections, and "T-cells", which control infections that are opportunistic in nature, such as cancer, leumekia, tuberculosis, and lastly, pneumocystis carni pneumonia and karposi sarcoma, diseases that are hallmarks of HTLV infection. HTLV retroviruses selectively destroy the T<sub>4</sub> cells of the immune system in the human body.

Let's examine the "AIDS virus situation". It appears that most people are assuming that there is "one AIDS virus"; this view is far from what is actually occurring. There are in fact six major variants of the HTLV virus, and each of them has an extremely large number (as we'll see later) of possible genetic combinations. What are the six major groups?

HTLV-1		Responsible for T-Cell Leukemia Magnesium Dependent Proliferative in Tissue Cultures
HTLV-2		Responsible for Harri-cell Leukemia Magnesium Dependent Proliferative in Tissue Cultures
HTLV-3		Responsible for what is viewed as "AIDS" Magnesium Dependent Destructive in Tissue Cultures
HTLV-4		Also known as HIV-II. Same as above.
HTLV-5		Causes Mycosis Fungoides
HTLV-6		A clone variant of HTLV-1.

## M A T R I X I I I

Where did these human retroviruses come from? Retroviruses used to be found exclusively in the animal kingdom and were never, until recently, found in humans. If you examine the retroviruses of cattle, you will find Bovine Leukemia Virus (BLV), which has the exact appearance, morphology, molecular weight, and magnesium dependency of HTLV-1. BLV has the same ability to produce T-cell leukemia in cattle as the HTLV-1 retrovirus does in humans. If you look at Bovine Sinsitial Virus (BSV), it has the same appearance, morphology, molecular weight, and magnesium dependency of HTLV-2, and produces HCL in cattle. If you look at Bovine Visna Virus (BVV), it has the same appearance, morphology, molecular weight, and magnesium dependency as HTLV-3, which is commonly referred to as AIDS when manifested in humans. Interestingly, it was found in 1974 that either BSV or BVV was found to be producing Pneumocystis Carnii Pneumonia in chimps.

All the various human retroviruses have striking similarities to retroviruses previously found only in cattle and sheep. How could animal viruses get into humans?

If you infect a human cell culture with BLV and BSV, you will produce more BLV and BSV, plus recombinant viruses which are a mixture of the two (HTLV-3, HTLV-4), just as the genetic material in human children is a recombination of the genetic material from human parents.

### Prediction of the AIDS Epidemic

In 1973 J. Clemenson, from the Danish Cancer Registry, spoke in front of an international assembly of leukemia experts at a conference on leukemogenesis. He said:

"We are in fact establishing conditions for a possible pandemic of an oncogenic virus varied on the scale of the influenza epidemic of 1918. It is possible to visualize the mutation of a virus into a variety highly contagious to man, resulting in a epidemic before we could develop a vaccine."

Harbingers of things to come? What she is saying is that because of serial passage of viruses during tissue culturing, that a new virus will develop. Is this not what happened with "AIDS"?

In 1971, two years earlier, an article was produced by Stuart A. Aaronson called "Common Genetic Alterations of RNA Tumor Viruses Grown in Human Cells". His report was about the experiments where RNA-based viruses of mice were grown in human tissue cultures, where they adapted and would thereafter grow only in human tissue. In 1972, this idea was expanded, and an article was published by Koshi Maruyama and Leon Dmochowski called "Cross Species Transmission of Mammalian RNA Tumor

## M A T R I X I I I

Viruses". They showed that you could adapt viruses having their origin in one species to grow in another by a process of adaptation.

### The Request

In 1972, that same year, the Bulletin of the World Health Organization (WHO) said:

"An attempt should be made to ascertain whether viruses can in fact exert selective effects on immune function, depressing 7s vs. 19s antibodies or by effecting T-cell as opposed to B-cell function. The possibility should be looked into that the immune response to the virus itself may be impaired if the effective viruses damage, more or less selectively, the cells that would respond to the viral antigens."

What they are saying is "let's make a virus that effectively inhibits the T-cells of man". Doesn't HTLV satisfy those criteria? Is it a mere coincidence that we have an epidemic of T-cell-destroying virus? This question was discussed in an article which appeared in the London Times on May 11, 1987 entitled "Smallpox Vaccine Triggered AIDS Virus", written by London Times Science Editor Pearce Wright.

The article caused a furor in Europe and Latin America but was suppressed in the papers in the United States. If you made HTLV viruses would you want anyone to know? No. The article addressed the association between the WHO Smallpox vaccine programs in Africa and the outbreak of AIDS. The conclusion was that the WHO vaccines were associated with the outbreak of AIDS. Allegedly, the article was produced after a distraught researcher, who had been paid by the WHO to conduct just such a study the year before, threw it on Wright's desk at the London Times saying, "there, if you want to know about AIDS in Africa, look at this."

There are many cases where the government has deliberately infected people. Beginning in the 1930's and 1940's, the government deliberately infected a group of black males with syphilis at Tuskegee University in Alabama and subsequently denied them access to penicillin, which resulted in the infection of their wives and the development of syphilitic black children. The "experiment" is detailed in a book entitled "Bad Blood" by James Jones. In fact, between 1959 and 1970, the United States Government did over 300 biological "experiments" on unsuspecting American citizens. There are many sources which document this, among them "A Higher Form of Killing: The Secret Story of Chemical and Biological Warfare", by Richard Harris.

Back to WHO and Smallpox vaccine. How was the Smallpox produced? A cow would be injected with the virus and would

## M A T R I X I I I

develop viral antibodies, which would be drawn off in the form of fluids and scabs from the open wound. Obviously, any virus that contaminated the cow would also contaminate the smallpox vaccine preparation. Injecting a vaccine with BSV, BLV, or BVV virus would contaminate the humans, and a virus would adapt itself to a human host. In 1981, Sedrick Mimms, writing in the journal "Microbiological Reviews" stated that "bovine visna virus (BVV) was a known contaminant of fetal calf serum." This means that in 1981, at the same time that the AIDS virus was "discovered", they had identified a relative of the AIDS virus in calf serum that was used for vaccine tissue cultures, and that this medium was present in tissue cultures worldwide.

What will happen in the next few years with the AIDS epidemic? To really understand about the nature and morphology of retroviruses, you have to consult veterinary experts, as most medical doctors have had little or no experience with these types of diseases. According to veterinary experts, when you see one "index" case of a virus, there are 99 cases that are to follow or support that one case. With 50,000 cases of AIDS evident, over 5 million people are actually infected. The CDC says this number is 1.5 million. A large discrepancy. The HTLV viruses are so-called "slow viruses", meaning that they are resident in human beings for a long time. The Centers For Disease Control says that HTLV viruses will manifest themselves in 3 to 5 years after initial infection. Veterinary virologists, who know what they are talking about, say that retroviruses occur over a period equal to 20% of the life-span of the species infected. For a human it would be 7 to 14 years before you saw the symptoms after initial exposure. If a vaccine could be produced, you would not know if it was really effective until 14 to 20 years had elapsed.

Slow viral diseases spread in a geometric progression. The CDC estimates about the number of cases of HTLV-3 in Africa indicate that between 40 to 75 million people are infected. Using knowledge from veterinary virologists to predict the spread of HTLV is easy. The entire continent will be dead in 10 to 15 years.

Within the United States, it would take less than 10 years for the entire country to be exposed. The problem is compounded when you realize that there are 6 variant groups of HTLV viruses. The blood supply in the United States is not screened for HTLV-1 and HTLV-2 - only HTLV 3. People are not generally screened for anything other than HTLV-3. Taking this into consideration, we should be seeing a massive increase in cancers, leukemias and tuberculosis. Unfortunately, that is just what is happening, isn't it?

Research also seems to indicate that the appearance of HTLV related disease in New York and San Francisco coincided with WHO Hepatitis-B vaccinations of the young, white homosexual population in those areas.

0200-D

## M A T R I X I I I

### Is "AIDS" a Sexually Transmitted Disease?

Again and again, the Centers for Disease Control maintain that "AIDS" is a sexually transmitted disease (STD). Does the virus meet the criteria for a STD? A STD grows in the venereal tract (which HTLV does not), is present as a live organism within semen (which HTLV is not), lives outside the body for an extended period of time (HTLV cannot live for more than 14 days in air), and can be transferred during sexual contact. It is not currently understood whether HTLV viruses are transferred as free viral particles or transferred inside cellular material. What we do know is that "intimate contact" will transfer the virus. It IS known that the virus is present in saliva, so you can be intimate with someone during the sexual act and transfer the virus - but it wasn't by virtue of the sexual act itself. Disinformation? Why would they continue to give out possible disinformation? Why wear condoms (the HTLV virus is .15 microns in size - the smallest pore in a condom is 1.5 microns in size - it would not stop the virus if it were present) or abstain from sex? Is the ulterior motive a part of population control? Is it because the fewer people there are the quicker the 2 billion kill-off goal will be met by the year 2000? Food for thought.

Other advisories by the CDC say that HTLV cannot be transferred through blood-sucking insects. In fact, there are close relatives to HTLV that are transferred by blood-sucking insects. Equine Infectious Anemia (Horses), Caprii Arthritis Encephalitis (Goats), Bovine Leukemia Virus (Cows), Bovine Visna Virus (Cows), and the Visna (Brain-rot) Virus of Sheep are all known to be carried by blood-sucking insects. Why are they telling the population that it is not true? So the population will not take precautions - the same is true with the other information the government disseminates about HTLV viruses.

### AIDS - "The Vaccine"

The HTLV viruses contain genes which contain approximately 9000 base-pairs. Each base pair has four combinations, which means that there are  $9000 \times 9000 \times 9000 \times 9000$ , or  $(9000^4)$  possible HTLV viruses for EACH of the HTLV groups. Instead of being a single virus for which a "vaccine" can be developed, there is a menagerie. Every "AIDS" virus that has ever been isolated is different, since it interacts with the tissue of the specific host it is in. Retroviruses are also known to spontaneously mutate at the rate of 1% per year.

The actual purpose of "vaccination" is to produce antibodies inside the host. However, the nature of these retroviruses is that they interfere with the ability of the body to produce antibodies - even if a vaccine could be developed, it would cause people to die even more rapidly.



## M A T R I X I I I

This leads to the intriguing question. If they know that a vaccine, as it is currently understood, cannot be developed, where is all the "research" money going? The same place all the "research" money for cancer is going - into the pockets of those who wish you not to exist.

Is it possible, within "current technology" to eradicate AIDS even if there WERE a vaccine? There are certain pre-requisites that MUST be met for a disease to be eradicatable. According to virologists, one can RULE OUT eradication of a viral disease if:

- (1) "The disease grows in wild animals and essentially has an animal reservoir". We know that HTLV does.
- (2) "The disease persists in human beings for an extended period of time." We know that HTLV viruses are slow viruses with a 7 to 14 years incubation period.
- (3) "The disease has multiple sereological types." There are six HTLV viruses, each with 9000<sup>4</sup> combinations.
- (4) "The necessary degree of social cooperation cannot be obtained". This is insured by keeping the population in ignorance about the true attributes of the disease.

Therefore, HTLV viruses violate all four of these conditions - it cannot, in the normal sense, be eradicated, and will be on the planet for a long time.

### Is There Hope?

The use of AZT and other drugs to attack the symptoms of HTLV are misnomers. The AZT, although it interferes with the production of the HTLV virus in the body, also kills the cells of the body. So, AZT and all the other substances that are being pressed forward on the public at enormous cost (it costs upwards of \$2000 per year to remain on AZT, which reaps potential profits for Committee of 300 drug companies) actually helps insure the death of the patient.

In answer to the question "is there hope?", the answer is YES. Experiments at Baylor University where HTLV laden blood has been irradiated with low-power laser light (which does not kill the blood cells but kills the virus) indicate, along with the experiments of Royal Raymond Rife, that the crystalline nature of viruses may be their Achilles heal. The viruses can be disrupted by light (or other electromagnetics) that exceed what Rife called the "Mortal Oscillatory Rate" of the virus. If the MOR is exceeded, the virus shatters.

There is an article elsewhere in the book that discusses the use of "radar" in just this way.



## A REPORT ON THE ABUSE OF POWER

Editor: Antony C. Sutton

December 1990

Vol. 9, No. 12

### The Politics of Cancer

About twenty years ago we explored the history of cancer and found – to our surprise – that the first flurry of authenticated cancer cases were reported in France in 1830. Then came a gradual increase and a rapid increase at the end of the 19th century with the rise of electrification and industrialization.

Isolated cases go back to Greek times. Perhaps many were misdiagnosed a century ago, but generally speaking cancer is a phenomena associated with the growth of electrical industrialization.

Following this, the common sense approach has been to associate a cure . . . with the environment, with living styles, with diet, with some manner of abuse of Mother Nature. Coincidentally, 1830-1840 was also the period when Michael Faraday, the father of electrical engineering, worked on his famous DIARIES – still the basis for electrical ideas.

This common sense approach has not been the road followed by the medical establishment which has spent decades and billions on a fruitless search for causes within an extremely narrow methodological framework.

This framework was shattered some weeks ago with publication by Office of Technology Assessment (US Congress) of a three hundred page study UNCONVENTIONAL CANCER TREATMENTS. For the first time we have a detailed bibliography for illegal “quack” treatments we have heard about over the years.

OTA got into the act because Congress came under pressure from thousands of constituents disillusioned with an orthodox search that goes nowhere. Even today one half the cancer cases diagnosed will die within a few years . . . orthodoxy has failed, patience among citizens has failed.

So here we have a compendium of unconventional treatments, shunned by the medical establishment, declared illegal by Congress but identified and pursued by countless thousands of desperate cancer victims. One can easily criticize the OTA study but it is one giant step forward: a recognition that unconventional treatment exists, a guidebook to many (but not all) treatments.

How did we get ourselves into this illogical position? That politicians can tell patients and doctors how to treat disease? And what we can and cannot do in an attempt to cure the disease?

The Phoenix Letter is mailed monthly and maintains a conservative free-market economics philosophy. Editor: Antony C. Sutton. Information contained herein has been carefully selected from sources believed reliable, but absolute accuracy cannot be guaranteed. Liberty House Press, its officers and stockholders may or may not have a financial position in investments referred to herein. Investment decisions are the sole responsibility of the investor and not this publication. RATES (monthly issues): 2 years—\$157; 1 year—\$87; 6 months—\$49; Air Mail Foreign—add 20% U.S. funds.

Phoenix Letter, Suite 216C, 1517 14th St. West, Billings, MT 59102  
Subscriptions Only: (406) 656-7511. All other inquiries must be directed to the publisher by correspondence to the above address.

Our original interest in cancer was not medical . . . it was philosophical. By what right, by what constitutional sanction or quirk did the American Medical Association and the National Cancer Institute working through Congress dictate to a citizen a cancer treatment? According to our philosophy, treatment is a matter for that person and God with the assistance, advice and warnings of his personal doctor. The State is irrelevant. The State does not own human bodies.

However, this personal dogma is seen today as quaint and outdated. Indeed, it is rooted in nineteenth century classical liberalism (not the modern liberal perversion). This philosophy is opposed to the rise of the Almighty State (that political fiction which enables a few to dictate to the many). It is also opposed to giving a license to government to run our lives . . . from where we can send our kids to school, to what we eat and apparently how we die.

### How the State Got Involved with Cancer

Medicine in the 19th century was very much a personal relationship between doctor and patient. Up to the Food and Drug Act of 1906, medicine of varying quality and efficacy was freely available: this Act created a Food and Drug Administration with a bureaucracy to determine whether specific drugs were "safe" and whether they should legally be offered to the public.

Simultaneously, from the early 1900's onwards, came the rise of the American Medical Association (AMA), the organizational leader of the medical community. The AMA set up a highly structured approach to research. In cancer, the entire emphasis was placed on finding cytotoxic against i.e. treatments that directly kill cancer cells. In practice, this evolved into almost total emphasis (at least until recent years) on drugs (chemo therapy) and surgical techniques.

The structured research approach precluded investigation of dozens of other concepts and the FDA's clout made sure that treatments outside surgery and cytotoxic agents found no role . . . AMA and FDA have routinely ignored other research approaches. Yet even before 1906 alternate treatments were considered worthy of scientific investigation . . . in 1904, for example, it was found that the enzyme papain (from papaya) might have beneficial effect in cancer.

However, the AMA especially under Morris Fishbein, editor of the Journal of the American Medical Association from 1924 to 1949, conducted vicious crusades against any treatment or procedure that did not come within the narrow guidelines laid down by AMA. Using a Committee on Quackery and a Department of Investigations (both eliminated in 1975) Fishbein was the spearhead of attacks against any medical practice outside the AMA. The AMA worked closely with FDA to close down, harass and jail dissident medical practitioners . . . dozens of doctors came under Fishbein's lash . . . Drown, Reich, are but two names out of dozens.

Probably most doctors in the period 1920 to 1970 were unaware that medicine was confined to extremely narrow routes and that fundamentally different ways of looking at the human body and its ills existed.

By the 1950's and 1960's medical specialists themselves began to question the orthodox system and we had books like Dr. Robert Becker, THE BODY ELECTRIC, and Dr. Richard Gerber, VIBRATIONAL MEDICINE.

More radically we had doctors developing cancer treatments outside the cytotoxic agent-surgery procedure, we had the rise of so-called unconventional practitioners, and a polarized war over cancer therapies. The AMA and the FDA were backed by the legal power of the State under the 1906 law while the alternate practitioners were hampered and harassed at every turn.

It was not medicine that failed. It was the politicization of medicine that was the culprit and the cause of failure. The finest, best trained doctors in the world are in the United States . . . but research and so medical procedures are based on too narrow an information base.

## The Failure of Orthodox Treatments

Orthodox medicine is no more successful in treating ills than is unconventional medicine. In the 1970's, Dr. Kerr White estimated that only 10-20 percent of all procedures used in mainstream medicine have been shown as efficacious by controlled trial. [This is cited on page 5 of UNCONVENTIONAL CANCER TREATMENTS.]

In brief, conventional mainstream medicine is no more successful than unconventional treatments but is backed by the police power of the State. If a doctor uses drugs and surgery he has no problems from the AMA and the State. If a doctor uses, for example, vibrational/radionics therapy he goes to jail. Yet orthodoxy flatly refuses to undertake research on radionics . . . or any technique outside drug-surgery practice. (Changing today a little under outside pressure.)

In the cancer therapy war each side describes the other in terms of quacks preying on credulous cancer victims for profit. Alternate therapists accuse orthodoxy of "cut, burn and poison" techniques. While in turn, the alternate therapist is described by the orthodoxy as a ruthless profit hungry quack gambling with people's lives.

In fact, there should be no "mainstream" and "unconventional" treatments . . . only treatments for cancer. The reason is politics. Political protection for the American Medical Association made its word law. AMA, for its own reasons, wanted only a drug-surgical route to cancer . . . it refused to recognize even diet therapy as recently as the 1960's.

So what should have been a scientific medical discussion looking at all possible therapies became a political battle. The report UNCONVENTIONAL CANCER TREATMENTS should not be necessary and certainly should not come from Congress. The report should have been issued by American Medical Association . . . decades ago when the treatments first surfaced.

What has happened in medicine has happened to American science in general – explanation now has to come before acceptance. And in the case of cancer, it appears that even explanation is not enough . . . the explanation must conform precisely to official discovered dogma or be rejected. This is a political process, not a scientific process.

The crusading Dr. Morris Fishbein was intent on building monopoly power for a conventional drug oriented medicine . . . and in so doing set back medicine 50 years. Half a million new cases of cancer are diagnosed each year . . . and half of these will die within a few years. The probability of getting cancer now (most categories) is far greater than 50 or 100 years ago. Progress? Of course not. Cancer treatment is a gigantic failure. Not because doctors are dumb or stupid but because cancer research is confined to cytotoxic agents (in the main).

Has it never occurred to anyone in medical research that every single possibility needs to be checked out?

# Bristol-Myers AIDS Drug, DDI, Equals Or Tops Wellcome's AZT, Study

By MARILYN CHASE

Staff Reporter of THE WALL STREET JOURNAL  
WASHINGTON—An AIDS drug cleared for market last year as fallback treatment appears in a new study to be equal to or better for certain patients than the standard treatment, Wellcome PLC's AZT.

The drug, Bristol-Myers Squibb Co.'s DDI, was approved by the Food and Drug Administration in October only for patients who didn't improve while on AZT or couldn't tolerate its side effects. The agency granted a provisional green light based on limited data then available and on an unprecedented early peek at an unfinished study.

That study, released here yesterday, may validate DDI as a standard frontline therapy that may be as good as AZT for certain AIDS patients and possibly superior for many patients suffering from the precursor condition AIDS-related complex, or symptom-free infection with the human immunodeficiency virus.

If the findings are accepted by the FDA, they will open up new treatment options for patients and heighten market competition between Wellcome and Bristol-Myers. DDI sells for hundreds of dollars less than AZT, which costs \$2,000 for a year's treatment.

Researchers were cautious in interpreting the study. "There's a lot more analysis that needs to be performed. Nevertheless we would recommend that people with ARC or asymptomatic infection who have been on AZT for [four months] should be allowed to get DDI," said James Kahn, a researcher at the University of California and San Francisco General Hospital.

The study, led by Dr. Kahn, was conducted under sponsorship of the AIDS Clinical Trial Group of the National Institutes of Health from October 1989 to October 1991.

Doctors in 43 medical centers monitored 913 patients classified as having AIDS or ARC, with fewer than one-third (about 300) the normal level of infection fighting T-cells, or as having asymptomatic infection, with fewer than one-fifth the normal level of T-cells. All the volunteers had received at least four months of AZT therapy.

The subjects were randomly assigned to receive 500 milligrams of DDI, 750 milligrams of DDI or 500 milligrams of AZT a day. Then they were monitored for recurrence of AIDS-related infections such as pneumonia or cancers such as lymphoma.

"People on 500 milligrams of DDI did better, and [their disease was] less likely to progress than those who remained on AZT," Dr. Kahn said. "ARC or asymptomatic [infected] patients benefited from switching to DDI at either dose from AZT. And for AIDS patients, DDI and AZT were equivalent."

Patients' T-cell levels were better on DDI than on AZT, Dr. Kahn said, characterizing the difference as "modest but statistically significant."

However, no difference in death rate was noted among the three groups, he said. Toxic side effects largely followed predictable patterns, with AZT recipients suffering more anemia and DDI recipients getting more inflammation of the pancreas. Two patients on high-dose DDI died with pancreatitis. The groups saw no difference in painful nerve damage known as peripheral neuropathy.

Given all the concern over the rise of AZT-resistant mutant viruses, the study held one major puzzle: DDI's benefits didn't seem to increase among the longest-term AZT users. Its effects were constant "whether patients were on AZT for 16 weeks or two years," Dr. Kahn said. "We were surprised."

Another crucial question, with far-reaching implications for future AIDS drugs, is whether DDI's clinical benefits were reliably predicted last fall by trends in certain lab tests. These lab tests, known as "surrogate markers," include T-cell tests. They are critical because they may serve as early predictors of patient survival or death, and thus serve to hasten the lengthy process of clinical trials and regulatory approval of new treatments.

At an FDA advisory panel meeting last summer, Dr. Kahn offered a preliminary look at his study, which seemed to support the use of surrogate markers and the clinical benefits of the drug. Yesterday's presentation continues to support that but still is inconclusive. The FDA ultimately will decide questions about the drug's efficacy.

"That's an unanswered question," Dr. Kahn said. But an early test of surrogate markers may come as early as next week, when an FDA advisory panel considers the market application of a third new antiviral drug for AIDS, DDC by Hoffmann-La Roche Inc., a unit of Roche Holding Ltd. of Switzerland.

## Roberts Pharmaceutical Corp.

### Firm Receives Right to Sell 'Orphan' Drug World-Wide

Roberts Pharmaceutical Corp., of Eatontown, N.J., said it received world-wide commercial rights for a new Ortho Pharmaceutical Corp. drug that treats a rare condition in young children known as precocious puberty. Roberts shares rose \$1.875 yesterday to \$26 in New York Stock Exchange composite trading.

The drug is a synthetic hormone called histrelin acetate, which Ortho Pharmaceutical, a Johnson & Johnson subsidiary, sells under the brand name Supprelin. Roberts, which acquires and markets drugs, didn't disclose the terms of the licensing agreement, except to say that it will give Ortho Pharmaceutical an upfront payment and royalties.

# Did a Polio Vaccine Experiment Unleash AIDS in Africa?

## The virus probably passed from monkeys to humans

By Tom Curtis

Science has accepted the possibility that the human immunodeficiency virus (HIV) that causes AIDS is a variant of a virus found in monkeys and chimpanzees. But no one knows how it jumped the species barrier to humans. I am strongly impressed by evidence that AIDS can be traced to one early polio vaccination program.

Many in the scientific community and the establishment media deride such a notion. But the record shows that by 1961, many scientists worried about the possible danger to humans of monkey viruses in polio vaccines, which are usually manufactured using monkey kidneys. Indeed, when scientists learned that a particular monkey virus—called SV40—found in much polio vaccine could cause tumors in young hamsters, they quickly banned from further use any vaccine carrying SV40.

Polio vaccines, produced by culturing strains of polio viruses in primate cells in laboratories, are injected into or ingested by humans. The recipient's immune system makes antibodies that ward off the wild polio virus. Hundreds of millions of people have been immunized, perhaps history's most acclaimed public health effort.

The discovery that polio virus and other viruses could be grown in primate cell cultures was a key breakthrough in developing polio vaccines and won a Nobel prize in 1954 for researchers Frederick C. Robbins, Thomas H. Weller and John F. Enders, who used human tissues for their studies.

But it was later discovered that monkey kidneys used in vaccine production often contained previously unknown monkey viruses, some of which could infect people—and in fact had done so. Researchers identified scores of simian viruses (SVs) in the kidneys of monkeys, commonly used to culture polio vaccine.

After SV40 was discovered, vaccine makers switched from Indian rhesus monkeys to African green monkeys. But in the early 1980s, researchers discovered that many such monkeys were infected with a retrovirus related to human immunodeficiency virus (HIV), the one that caused AIDS in humans. This retrovirus cousin of HIV, called simian immunodeficiency virus (SIV), could have been present in any vaccine made from the tissues of these monkeys before 1985, the year when sophisticated testing was instituted.

Could a vaccine containing an even closer relative of HIV have transmitted the AIDS virus to humans? And if so, would that transmission correspond with what is known about the early occurrences of AIDS?

With the help of Blaine Elswood, a 43-year-old AIDS treatment activist in San Francisco, I've found many clues suggesting such a possibility. Elswood's research has led me to a scientist whose early, experimental polio vaccination program in the former Belgian Congo (now Zaire) is today all but forgotten. After his vaccination program ended, he warned Congress about the vexing problem of monkey viruses contaminating the vaccines.

The clues include:

■ A 1989 article in the *Journal of the Royal Society of Medicine* that, while discussing a possible cross-species epidemic caused by a live-

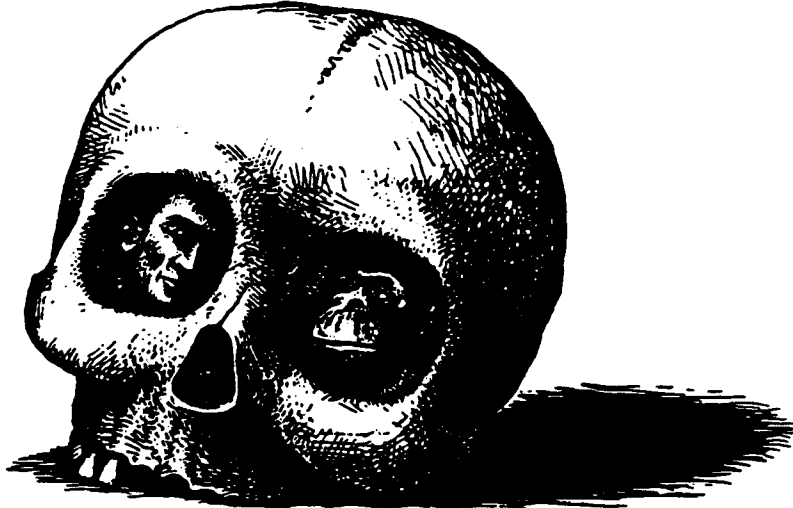

BY CHRISTOPHE VOILET FOR THE WASHINGTON POST

virus vaccine, asserted in part, "It would appear that the AIDS epidemic may be just one of the latest of several mammalian cross-species viral transfers triggered by the techniques of virology developed in the 20th century, which subsequently spread out of control in the new host species."

■ A 1989 letter from Japanese researchers to the journal *AIDS* noting that most live oral polio vaccines worldwide are still made in kidney-cell cultures from African green monkeys. They recommended that monkeys naturally infected with SIV should not be used to make vaccines. In Japan, they noted, only kidneys from monkeys free of SIV are used in polio vaccine production.

Elswood and Raphael Stricker of California Pacific Medical Center have written a paper, recommended for publication in a science journal published by the Pasteur Institute in Paris, theorizing that Africa's AIDS epidemic was spawned by a contaminated polio vaccine administered from 1957 to 1960 to at least 325,000 people in Rwanda, Burundi and the former Belgian Congo. This is precisely the region where the AIDS epidemic rages most fiercely and from which many experts believe it spread.

That polio vaccine was devised by Hilary Koprowski of Philadelphia's Wistar Institute, who began the scientific race to develop live oral polio vaccine. Koprowski, a former vaccine researcher for Lederle Laboratories, was the first to administer live, weakened polio virus to human beings, initially in 1950.

Starting in 1957, Koprowski's Congo vaccines were the first ones administered to a large human population, sprayed into the mouths of hundreds of thousands of Africans. There was virtually no follow-up, which Koprowski blames on the Congo's subsequent independence and civil war.

When I tried out the Congo theory of the origin of AIDS on Gerald Meyers of Los Alamos National Laboratories, the chief federal expert in genetic sequencing—the science of tracing a virus's evolution—he conceded that at least the timing seemed right. He has computed that the common ancestor of the half dozen variants of today's primary AIDS virus, HIV-1, entered the human population about 1960.

Moreover, at least one polio researcher thought Koprowski's Congo preparation was contaminated—though by what and to what

effect (if any) is unknown. Albert Sabin, a legendarily careful researcher, reported in 1959 in the *British Medical Journal* that he had found an unidentified cell-killing virus in Koprowski's Congo vaccine. Koprowski has always disputed that, saying two other labs found his preparation free of viruses other than polio. Koprowski recently told me his were as safe as any of the other oral polio vaccines.

It is unclear what monkey species Koprowski used to make his two Congo vaccines. He first told me he had used African greens but in a later conversation said that although he could not document it, he suspected that he had first used rhesus monkeys—which aren't a natural host for SIV. But he conceded that the kidneys were already removed when his lab acquired them, raising the question of whether he could have known the monkey species. Recently he has been quoted as saying he imported SIV-free monkeys from the Philippines.

On April 4, 1961, Koprowski wrote to the House health and safety subcommittee taking issue with a U.S. Public Health Service requirement that live polio virus vaccine be grown in monkey kidneys.

He suggested that human cell lines be used instead. "As monkey kidney culture is host to innumerable simian viruses, the number found varying in relation to the amount of work expended to find them, the problem presented to the manufacturer is considerable, if not insuperable," Koprowski wrote. "He is faced with the prospect of having to discard most of the manufacturing lots of vaccine. . . . As our technical methods improve we may find fewer and fewer lots of vaccine which can be called free from simian virus."

Initially, neither Koprowski nor Sabin thought the unknown viruses harmful. But a leading virologist of the time, Joseph Melnick of Baylor College of Medicine, told me last fall that the discovery of SV40—which caused cancer in baby hamsters—had "scared the hell out of us."

Weller, one of the trio that won the Nobel prize for learning how to grow polio virus in tissue culture, recently told me of the discovery of SV40: "It [badly scared] all of us. Here was a virus—we didn't know what it did in man—that produced tumors in hamsters."

Although they switched monkey species, scientists continued to put unknown monkey viruses into the human population.

Weller said he thought there was a "pretty slim chance" HIV or a related retrovirus would be found in old polio vaccine stocks maintained by the Food and Drug Administration (FDA). Then, he said, "In science, nothing is 100 percent. I might well be wrong."

Anthony Fauci, chief federal AIDS researcher, told me recently that my story of Elsworth's hypothesis in the March 19 issue of Rolling Stone and a parallel theory written by Walter S. Kyle in the March 7 issue of the British medical journal Lancet had unleashed a "major firestorm" of controversy.

Kyle theorized that the AIDS epidemic among American male homosexuals could have been accidentally started in the mid-1970s by an experimental treatment for herpes lesions used in New York and California.

The treatment double doses, twice as often as used for polio vaccination, of the Sabin oral polio vaccine.

**K**yle—a lawyer who bases his theory on evidence obtained in discovery from polio compensation cases—thinks the Sabin vaccine was contaminated with monkey retroviruses. A spokesman for Lederle Laboratories, the only U.S. manufacturer of oral polio vaccines since the mid-1970s, told me that since 1985, when sensitive new testing procedures were instituted, Lederle has sometimes found SIV in early stages of its vaccine production process. The spokesman said such contaminated materials are eliminated when found.

What about vaccine produced and administered before 1985? The spokesman said that if you don't know something's there, you can't test for it.

The FDA's Division of Produce Quality Control has stored samples of polio vaccine since 1976. Fauci, director of both the National Institutes of Allergy and Infectious Diseases and NIH's Office of AIDS Research, told me: "If there are [polio vaccine samples] from back then, it would seem reasonable to go back and test them using our modern techniques."

Indira Hewlett, FDA's senior scientist conversant with the test in question, the polymerase chain reaction, or PCR, agrees that such testing is in order and would be the best way to resolve the question. Melnick and Robbins also say testing the suspect polio stocks would be a good idea that could put the current controversy to rest.

But Louis Sullivan, secretary of Health and Human Services, FDA Commissioner David Kessler and other senior officials so far have ducked the issue and declined my requests to interview them.

Whether or not the Wistar Institute itself evaluates the vaccines, the question could be settled by multiple PCR and other tests, performed in independent labs by investigators of unquestioned integrity and stature outside the United States—preferably in England and Switzerland. ■

Tom Curtis, formerly of Texas Monthly, is covering this subject for Rolling Stone and the Houston Post.

## The vaccine theory depends on miracles

By Malcolm Gladwell

I have not been keeping count. But it is quite possible that there are more theories explaining the cause of AIDS than there are the death of John F. Kennedy.

There is the man from Wisconsin who argues that dioxin causes AIDS. There is the fecal contact theory, the malaria theory, the herpes treatment theory, the genetic experiment run amok theory, the wrath of God theory, and all manner of theories involving pigs, cows and even dolphins.

Now there is the Tom Curtis theory that an experimental batch of polio vaccine administered to hundreds of thousands of Africans 30 years ago was accidentally contaminated with a monkey virus that turned out to cause AIDS. It is not an implausible idea. The immediate ancestor of the AIDS virus is, in fact, a monkey virus. Monkey kidneys were used to make the African polio vaccine. And the place and time of the polio trial does loosely correspond to science's understanding of where and when the AIDS epidemic began.

But plausible does not mean true. And the closer one looks at the Curtis theory the less convincing it becomes.

Curtis, for example, makes it sound as if there was only one AIDS virus that suddenly, dramatically jumped from monkey to man. In fact, the family of retroviruses to which AIDS belongs is hugely diverse, cropping up in all kinds of different animal species and manifesting itself in all kinds of ways.

For example, some types of African monkeys carry something called SIV or simian immunodeficiency virus. It doesn't produce the same clinical symptoms as the human AIDS virus, but genetic analysis indicates that this is the immediate ancestor of HIV.

Not all SIVs are the same, however. Monkeys in the coastal forest regions of West Africa carry one kind and green monkeys in central and east Africa carry another.

There are also two kinds of human AIDS viruses: HIV-1 appears to come from central Africa; HIV-2 is epidemic several thousand miles away in western Africa. Genetic analysis suggests that the two viruses probably came from the same ancestor about 150 years ago, and they still produce a very similar clinical result. But they are different viruses. And they come from different places.

Curtis's theory, then, based on a trial in what is now Zaire, is not really about the origin of AIDS at all. It is only about the rise of the Central and Eastern African epidemic of HIV-1. This doesn't make it wrong. But it is just one of numerous instances where his theory turns out to be much less than adequate.

Consider all the mysteries created by the Curtis theory:

■ The mystery monkeys. The Wistar Institute, the Philadelphia research organization that 30 years ago conducted the polio trials now in question, either used Asian rhesus monkeys to make its polio vaccine or kidneys from African green monkeys. They now can't determine which. But in both cases, Curtis has a problem.

Rhesus monkeys aren't infected with SIV in the wild at all. And green monkeys, which are, carry a strain of SIV that is so different from HIV-1 that scientists say it is virtually impossible to imagine that it could have evolved into the virus we now recognize as the cause of AIDS within Curtis's hypothetical time-frame. **GENETIC ENGINEERING!**

The point of all of this is that to make sense the polio vaccine theory needs something that no AIDS researcher has ever found—a mystery monkey carrying a hitherto unknown strain of SIV that closely mirrors HIV-1. Since the Wistar Institute clearly didn't use this mystery monkey, the unknown primate would have had to infect either a rhesus or a green monkey sometime between the jungle and having its kidney diced. At this point the theorist must use his imagination. Perhaps the mystery monkey was in the same holding pen as a rhesus monkey during

the boat ride to America, they fought, and blood from the SIV-infected monkey contaminated the rhesus. Perhaps they had unprotected sex. Perhaps they shared needles.

■ The mystery culture. The family of AIDS viruses is notoriously finicky. The viruses feed on certain types of blood cells, and soon after they find these cells they kill them, which means they need constant feeding and attention. Even if the mystery strain of SIV/HIV-1 actually did exist in the monkey kidneys, in other words, it's not clear it would survive in the cell culture while the polio virus was being grown.

"When our lab and other labs tried to grow SIV in monkey kidney cell culture, we couldn't do it," says Gerald Quinnan, acting director of the Food and Drug Administration's Center for Biologics. "There aren't enough cells in the culture capable of supporting the virus."

Of course it is theoretically possible that there is a monkey kidney culture in existence that mysterious strains of HIV/SIV find more hospitable. Call that the mystery culture.

■ The mystery transmission. Even if the mystery monkey and the mystery culture exist, the Curtis theory still needs another miracle to work. The polio vaccine administered in Central Africa in the late 1950s was squirted into people's mouths. This is not an efficient way of transmitting an AIDS virus. Blood-to-blood contact, the most effective way of transmitting, results in infection between .03 and .3 percent of the time. Transmission by oral contact, although theoretically possible, is an even bigger longshot.

Quinnan says that if ingesting virus orally really posed a risk, the epidemic would have begun long ago.

"It is likely that millions of people consume food that contains more virus than could conceivably be contained in a [single dose of polio] vaccine," he says. "But people don't get infected from eating monkeys, so why should they with a vaccine?"

Quinnan and other AIDS experts, however, stop short of saying that Curtis's theory is absolutely out of the question. Part of this is, because in the strange world of AIDS, nothing is out of the question. Part of it is as well that most AIDS researchers simply don't care. To them, where the virus is going is a much more pressing question than where it came from. ■

Malcolm Gladwell covers science and medicine for The Washington Post.



# Tuberculosis is back

■ A new type of tuberculosis is of particular danger to AIDS patients.

1-31-92

The Associated Press

WASHINGTON — A new and dangerous type of tuberculosis is "out of control," the American Lung Association said Thursday. It urged Congress to appropriate at least \$91 million to combat a disease once believed to have been conquered.

"Alas, TB is back," Dr. Lee B. Reichman, president-elect of the association, said at a news conference.

Fran Du Melle, deputy managing director of the association, said it is urging approval of a \$66 million appropriation recommended by President Bush in his budget, plus \$15 million to help states and cities fight the disease and a minimum of \$10 million for federally funded research.

Experts at the Centers for Disease Control in Atlanta have said that outbreaks of potentially deadly and drug-resistant strains of tuberculosis could become increasingly hard to combat as they spread among AIDS victims and others with weakened immune systems.

Outbreaks already have occurred in New York City, Michigan, Florida and the New York state prison system.

Reichman, director of the pulmonary division of the New Jersey Medical School in Bergen, said HIV-infected people who develop latent tuberculosis have a 10 percent chance of developing an active case of the disease within a year.

He said the drug-resistant strains of the infectious disease can be spread to health-care workers and others in hospitals.

Reichman said 50 percent of tuberculosis patients once died, even after treatment which often kept them in a hospital five to 10 years.

After the discovery of drugs to cure the disease, "society, feeling that TB was coming under control, turned its attention to other problems and priorities."

"But alas, TB is back," he said. "Front page articles and national sound bites and talk shows remind us that we have a new, powerful and dangerous type of TB that is out of control."

Consequently, Du Melle said, "we again turn to the policy arena to pursue initiatives to address the resurgence of tuberculosis in the United States."

She said the number of cases began to increase in 1985, for the first time since national reporting was first required in 1953. From 1989 to 1990, the increase was 9 percent, the biggest ever. The number of cases was 25,701.

INSIGHT / JULY 23, 1990

## Wand inserts DNA into Living Tissue

Genetic feats that researchers someday may be able to perform will not be magical illusions but actual manipulations of cells using a device that sends millions of DNA-coated pellets into living tissue. The DNA wand, as its developers call it, may have applications in treating numerous medical conditions by inserting missing genes into tissue.

The device shoots about 10 million DNA beads, containing approximately 30 genes each, directly into the tissue at speeds of 1,000 feet per second.

# The new threat of TB

SEATTLE, WASHINGTON 1-28-92

**P**ublic health officials have expressed well-placed alarm over the spread of a strain of tuberculosis in the U.S. that seems resistant to antibiotics.

An immediate research effort must be undertaken to develop drugs to deal with this emerging threat to public health.

While it is unlikely anyone would catch TB from such casual contact as sitting at an adjacent table in a restaurant or at an adjoining desk at work, TB is spread by prolonged personal contact, most typically among families living in close quarters, according to medical experts.

Most of the cases of drug-resistant bacterium have been found in New York City, where the TB epidemic has combined with epidemics of HIV infection, intravenous drug abuse and homelessness to create conditions under which the disease thrives.

While Seattle so far has seen only a handful of tuberculosis cases resistant to standard drug treatment, the deadly strain has surfaced in 13 states and generally "tuberculosis is out of control in this country," according to Dr. Dixie Snider, the chief expert on tuberculosis at the federal Centers of Disease Control.

"I think it's ominous," adds

Dr. Charles Nolan, director of Tuberculosis Control Programs for the Seattle-King County Department of Health.

In Seattle-King County, the rate of TB has risen from an all-time low in 1984 of 84 cases to 107 now. From 5 to 10 percent of those cases are in people with HIV infection, another 10 to 15 percent in drug abusers, 25 percent in either the homeless or medically underserved and 50 percent in immigrant populations, according to Nolan.

Because it was wrongly assumed that the U.S. had the disease permanently under control, no new TB drugs have been brought to market in 22 years and the U.S. tuberculosis public health programs have been all but dismantled.

"It's almost criminal that this has been allowed to happen," says Nolan, who sits on a national council whose charge is to eliminate TB in this country.

Meanwhile, 8 million new cases of TB occur annually worldwide, and a staggering 3 million people die from it each year.

It seems unlikely then, given modern international interdependency, that TB will be eliminated in the United States unless it's also eliminated in the rest of the global village.



# Super-TB bug spreads in N. America

News Services 1-92

NEW YORK — Virulent new strains of tuberculosis — including some that drugs can't kill — are escalating among the frail and the destitute.

The outbreak comes years after modern medicine appeared to have conquered the disease.

Some 3,520 new cases of TB were diagnosed in New York City last year, a 38-per-cent increase over 1989.

Health authorities now report a dramatic rise in the city's drug-resistant tuberculosis rate. Some 13 prison inmates and a guard have died of drug-resistant TB.

But officials say the problem is not limited to New York.

"Really, any area is at risk. People everywhere need to be aware of the problem," said Sam Dooley, an epidemiologist with the federal Centres for Disease Control in Atlanta.

Tuberculosis also is on the rise in Canada.

In 1989, the most recent year for which figures are available, the number of cases rose 4.5 per cent. It was the first increase in TB cases after two decades of almost uninterrupted decline.

Health officials say those who are particularly vulnerable are the poor, homeless, malnourished and those who share cramped quarters.

Also the frail elderly, cancer patients, AIDS victims, transplant recipients and substance abusers.

Officials say TB sufferers who don't complete medical treatment — a group that often includes the homeless, AIDS patients and drug abusers — risk developing drug-resistant strains of the disease.

Those extra-hardy strains can then infect people who have never had TB.

Some treatment programs provide incentives to patients to take their medicine.

For a time Denver officials rewarded patients with free beer. New York has given out free food coupons.

## Antibiotics and EMF

Researchers at the University of Texas Health Science Center in San Antonio have found that low intensity magnetic fields comparable to those found in the environment can enhance the effectiveness of certain antibiotic drugs. Dr. Wendell Winters and Dr. Xiu-Hua Song carry out animal and cell-culture experiments in a special EMF (electromagnetic field) device that can simulate a range of field levels, from the typical living room to those next to a powerline. Concern has been increasing over the long-term effects of human exposure to 60-hertz EMF generated by overhead powerlines and appliances such as electric blankets.

In their study, the experimenters subjected cultures of seven different disease-causing bacteria to environmental levels of magnetic fields and then tested the anti-bacterial potency of nine common antibiotics. The impact of six of the drugs was enhanced; three were unchanged.

"We noticed the greatest change in erythromycin, which is used to treat a wide range of infections, including those caused by penicillin-resistant staphylococcus bacteria," explains Winters. "Our basic research results underscore the need for the next phase of studies—treatment of infected animals with magnetic fields and antibiotics."

## NEURAL FUNGUS

◆ The trouble began at Chekalov underground station in Tashkent, 1,800 miles south-east of Moscow when mould spread over the concrete walls of tunnels. No one worried until train drivers, then commuters, complained of headaches and symptoms that suggested poisoning. Scientists discovered that the mould was poisonous and penetrated internal organs and blood cells. The train tunnels were said to lie "on the ancient migratory path of the micro-organisms". [Beats us how they could know that...]

"It is even worse than Aids" said Professor N. Dekhan-Khodzhaeva. "This mould is very aggressive and attacks not only all internal organs but also all blood cells." Doctors examined 32 victims and discovered various types of mould in 14 of them. Four workers from Chekalov station had a new species of mould in their

blood. The station was closed down, followed by nearby Selmash station, where mould and an unpleasant gas were found. A year-long investigation was planned. The mould could be caused by pollutants from the many factories in this highly-industrialised area.

British fungi expert Donald MacKenzie said: "I have never heard of a mould as poisonous as this. It is very unusual for a mould to have such a severe effect on humans. Normally, only people with weak immune systems are at risk... It would be unusual for a species of mould to derive from industrial effluent, but it would not be impossible." [R] Houston (TX) Post, D.Mirror, D.Mail 30 Aug 1990.

# Tuberculosis Epidemic Surges, As New York Orders Isolation Rules

4-23-92

by Joyce Fredman

March 13 (EIRNS)—The New York State Health Department has sent strict new rules out to hospitals throughout New York, calling for isolation rooms and proper standards in dealing with tuberculosis patients, at the same time that both the Food and Drug Administration and the Federal Centers for Disease Control in Atlanta, Ga. are planning unprecedented steps to get the manufacture and distribution of TB-specific antibiotics going in the United States.

Responding to within-hospital (nosocomial) transmission of infection of *Mycobacterium tuberculosis* (m.tb), in May 1991 the New York State Department of Health alerted all hospitals in the state, and informed them of measures required to control further spread.

As the NYSDOH memo stated, "TB, transmitted in airborne particles generated when people with pulmonary or laryngeal tuberculosis sneeze, cough, speak, or sing," demanded immediate attention—it was spreading to patients and staff alike. The measures called for include: "1) Early identification and treatment of patients with suspected or confirmed TB disease; 2) strict adherence to isolation procedures for such patients; 3) adequate environmental control of TB; 4) maintenance of a comprehensive employee TB skin-testing program; and 5) cooperation with state and local public health authorities, including rapid reporting of suspected or confirmed cases of TB disease and of nosocomial transmission of TB, and thorough coordination of treatment and followup."

**Footdragging**

Needless to say, the implementation of these measures has been slow to

nonexistent, because of budgetary constraints and reluctance, on the part of the political establishment, to recognize and name an emergency situation. That same inaction has caused a disaster on the medication front, deepening the horror not just in New York, but nationally. By 1991, the House Energy and Commerce subcommittee on health and the environment was saying that the United States had "significant tuberculosis control problems." The federal TB program (cancelled by the Reagan administration) was restored—but in name only. Congress gave the program not one dime.

Now, the Centers for Disease Control will import drugs from overseas, distributing them free—at an unknown cost to the federal government! That's because of the acute shortage, and even unavailability, of standard anti-TB drugs in this country. According to the Food and Drug Administration's Dr. Mark Goldberger, the FDA will soon be offering tax incentives as well as exclusive U.S. marketing rights to stimulate production here of the much-needed drugs.

**How Many Lives Lost?**

But how many lives has this negligence cost us? As the epidemic of tuberculosis spreads from the prisons and homeless shelters to the middle-class communities, news coverage changes from obscure and low-key, to front-page cries of alarm. Local papers have begun running series on the disease. Newsweek's March 16 issue had a cover story on the resurgence of TB.

Perhaps the March 12 editorial page of the Washington Post best reflects the concern among those who realize the gravity of the situation—as well as how much of the present crisis was 100% preventable.

"The resurgence of tuberculosis isn't particularly sudden or particularly surprising. Public health officials began noticing outbreaks in Harlem and other inner cities more than a decade ago, and they warned of the disease spreading out of control: ... Complacency and a lack of sustained funding are to blame for the rise. ... Now ... as TB begins to infect middle-class social workers, health care workers, and public defenders, attention is being paid. It's almost too late."

Because authorities have delayed taking proper precautions, already this year, there have been 4,300 new cases in New York State, and according to hospital union figures, 500 employees so far have tested positive for exposure to the bacillus.

**Higher Than Third World**

These statistics are nothing to sneeze at, as it were. Around the world, TB causes more deaths than any other infectious disease. When rates in some of the nation's poorest neighborhoods jumped as much as 50%, as happened in Harlem in 1979 to 1980, many health care workers sounded the alarm. That fell on deaf ears, and today, in Harlem, the rates are nearly five times what they were 10 years ago. Miami's rate today is higher than the rate in the entire country in the early 1950s, and in North Carolina's migrant labor camps, the rate among U.S.-born blacks is 3,600 per 100,000, more than 10 times that of sub-Saharan Africa!

As the Newsweek article pointed out, the spread of infection has just begun to surface:

"An estimated 1.7 billion people (including at least 10 million Americans) carry the tuberculosis bacterium.

WHY IS THE U.S. ARMY PLANNING TO TEST AN AIDS "VACCINE"  
IN ASIA, AFRICA, AND SOUTH AMERICA ?

From the May 6, 1991 Issue of Commerce Business Daily, submitted  
by a LER member from New York:

Special Studies and Analyses - Potential Sources Sought

U.S. Army Medical Research & Development Command  
Attn: SGRD-ACQ, Ft Detrick, MD

B - DEVELOPMENT OF VACCINES DUE 051791 The U.S. Army Medical Research and Development Command is interested in the co-development of vaccines for immunotherapy and immunoprophylaxis of retroviruses, particularly HIV-1. Plans are being made for vaccine testing overseas at possible study sites in Asia, Africa and South America. The Command requests commercial firms interested in entering into Cooperative Research and Development Agreements pursuant to the Technology Transfer Act to submit expressions of interest to Jean V. Smith, Principal Assistant Responsible for Contracting, U.S. ARMY Medical Research and Development Command, Fort Detrick, Frederick, MD 21702-5012 (0122).

**N.Y. school board  
to vote on condoms**

NEW YORK — After 5/9 months of debate and a last-minute compromise effort, the Board of Education called for a vote Wednesday on doling out condoms in the nation's largest school system.

If approved, condoms would be available on request at 120 schools that enroll 260,000 students, part of a stepped up effort to fight AIDS.

Parents' permission would not be required, and that was the major sticking point for the School Board. Several board members tried to negotiate an "opt-out" clause, allowing parents to write notes to exclude their children.

Schools Chancellor Joseph A. Fernandez has insisted that no "opt-in" be required. He said that to make teens get their parents' permission would scare them away from the condom giveaways.

AIDS VIRUS IS  
SMALLER THAN  
SMALLEST PORE IN A  
CONDOM. WHO ARE  
THEY KIDDING?

CONDOM: 1.2 MICRONS  
AIDS: .7 MICRONS

**U.S. hospitals report flu patients  
filling beds in epidemic numbers**

Associated Press

ATLANTA — Federal health officials have confirmed what the nation's beleaguered hospitals already knew: The flu has become an epidemic.

Deaths attributed to the flu reached epidemic levels in the last week of December and first week of January, according to the U.S. Centers for Disease Control.

The flu epidemic, the nation's first since 1989, could get worse. February traditionally is the peak month of the flu season.

"It has filled our hospital to overflowing," Orbenia Stewart, at the DeKalb Medical Center in suburban Atlanta, said yesterday. DeKalb is one of dozens of hospitals nationwide reporting bed shortages because of the flu.

"This week's been horrendous, the hardest week I've had in 23 years there," she said.

Flu was linked to 7.2 percent of the deaths in 121 cities in the two-week period, said Dr. Larry Schonberger, of the CDC's viral diseases

program.

An epidemic is declared when the death rate is appreciably higher than the projected rate, which was 6.2 percent. Flu annually kills about 24,000 persons in the U.S.

**Measles cases 6-9/  
on upswing in U.S.**

ATLANTA — Urban children are getting measles and dying in numbers unthinkable a few years ago and health experts have a simple explanation: Children are not getting vaccinated.

"From the public-health point of view, we really know what the problem is," said Dr. Roger Bernier of the federal Centers for Disease Control. "Infants are not being vaccinated in time in our large urban areas."

One solution is to make vaccinations more easily avail-

# Humans to be new guinea pig

■ Desperate to halt the spread of AIDS, officials plan to abandon trial tests on animals and begin using experimental vaccines on human subjects.

N.Y. Times News Service

11-11-91  
Discouraged by their inability to stem the spread of AIDS, world health officials are bypassing the usual animal trials and plan to begin testing in Brazil, Rwanda, Thailand, and Uganda to find out whether experimental vaccines can prevent people from becoming infected.

The step reflects almost a complete reversal in attitude. Until now, many experts had favored the traditional approach of exhaustively testing vaccines on animals.

The larger studies will involve a few thousand volunteers. The first injections are not due to be given for two years, and selection of the first vaccines has not been made. 1993

Countries that might have resented being guinea pigs in the past are eager to take part in an AIDS vaccine trial. As the epidemic surges almost unchecked through many Asian and African countries, health officials have become desperate.

Eleven million people are already infected, the World Health Organization estimates, and the number of infected people will soar to 40 million, including 10 million children, by the end of the decade.

At a recent meeting on AIDS vaccines, the feeling was "the trials may not work, but try anyway," said Dr. Dani Bolognesi, an AIDS vaccine expert at Duke University.

The World Health Organization is laying the groundwork for vaccine trials in Brazil, Rwanda, Uganda, and Thailand.

Army officials from the United States and Thailand have started studies among the Thai military to determine whether to do a large vaccine trial there. And federal health officials are exploring the possibility of vaccine studies in high-risk civilian groups in the United States. The efforts will be coordinated.

While the first injections are not expected for two years, safety tests of candidate vaccines will continue in the United States and other developed countries where they are manufactured.

## ALTERING THE AIDS VIRUS

It is no secret that the AIDS virus is a formidable enemy: more than 6 million people have already been infected. But it came as a jolt when a recent article in *Science* hinted that certain lab experiments might create even more dangerous variants. Admittedly the "note of caution concerning... biosafety measures" was subtle, but considering that one of the authors was Robert Gallo, codiscoverer of the AIDS virus, there was no way the note was going to escape attention.

The article described how Gallo's team at the National Cancer Institute had succeeded in infecting human cells with both the AIDS virus and a mouse leukemia virus. When the AIDS virus reproduced in these doubly infected cells, its outer coat incorporated proteins from the mouse virus. This altered AIDS virus turned out to infect cells in the immune system that the pure AIDS virus normally leaves alone. Moreover, it also infected the epithelial cells that line the respiratory tract.

That's what set off alarm bells. Other viruses that infect epithelial cells—such as influenza, cold, and Epstein-Barr viruses—can spread through the air. The fear is that an altered AIDS virus might do the same thing.

Gallo himself downplays this possibility. These viruses are only superficially changed, he notes, not genetically altered, so they can't pass on the changes to their offspring. "Theoretically, you could have a danger," he says of airborne transmission, "but it would be a onetime risk."

Other AIDS researchers think even that's overstating things. The AIDS virus in mouse clothing is not the first retrovirus—the family of virus that also includes those that cause leukemia—to incorporate the proteins of another virus into its coat. Mixed viruses have been known for more than two decades, and "there's no evidence that they've ever traveled through the air," says Howard Temin, a Nobel Prize winning virologist at the University of Wisconsin. "The enemy we know is bad enough without worrying about hobgoblins."

# AIDS in U.S.

The Associated Press 1-19-92  
ATLANTA — It took eight years for the first 100,000 AIDS cases to appear in the United States. It took just 26 months for the next 100,000, a group including more heterosexuals, women and minorities.

The Centers for Disease Control reported that the nation's AIDS count now stands at 206,392 cases, with 133,232 deaths. It was August 1989 when the 100,000th case was reported; the next 100,000 came in just more than two years.

"The cumulative total ... emphasizes the rapidly increasing magnitude of the HIV (AIDS virus) epidemic," the CDC said.

The second 100,000 AIDS cases differed from the first 100,000:

■ Seven percent of the newer AIDS cases were traced to heterosexual transmission. That's up 44 percent compared with the first 100,000, 5 percent of which were heterosexual cases.

More than 11,000 heterosexual AIDS cases have been reported and that count is expected to double by 1995, said Dr. Larry Slutsker, a CDC AIDS epidemiologist.

■ Twelve percent of the second 100,000 AIDS cases occurred in women, compared with 9 percent of the first 100,000.

■ Thirty-one percent of the second 100,000 patients were black, compared with 27 percent earlier.

## Second wave of AIDS hits women, kids

The Associated Press 6-3-91  
NEW YORK — The face of the second wave of AIDS infection is young and female, the face of a mother.

This year, AIDS is expected to become the fifth leading cause of death for all U.S. women of childbearing age, just behind cancer, accidents, heart disease, murder and suicide and ahead of strokes, liver disease and diabetes.

Over the course of the disease, more than 16,800 women have been diagnosed with AIDS nationwide — almost one-third of those in the last year.

## Judge orders AIDS paper kept secret

The Associated Press 1-10-92  
STUART, Fla. — A research paper that reportedly disputes the Centers for Disease Control's conclusion that a dentist infected his patients with AIDS must be kept secret for now, a judge has ruled.

The article is being reviewed for publication by the journal *Science* and would lose value if released before publication, attorney Bill Fink told Circuit Judge Robert Makemson on Wednesday.

Fink represents CIGNA Dental Health of Florida, the insurer of dentist David Acer, who died from AIDS in 1990. CIGNA hired Dr. Lionel Resnick, who has conducted AIDS studies, to research the CDC finding that Acer infected five patients with the HIV virus.

The judge told CIGNA to give the paper to attorneys for one of the infected patients, but said its contents must be kept secret. The patient is suing CIGNA for directing him to Acer to receive dental care.

Scientists at the Atlanta-based CDC performed DNA tests that genetically linked Acer's strain of the HIV virus with those of five patients. One of those patients was Kimberly Bergalis, who died last month.

## Dolphins are dying of AIDS

THOUSANDS OF dolphins are being killed off by an AIDS-like illness, worried researchers report.

Since 1987, a growing number of the friendly ocean mammals have washed ashore suffering from skin lesions, starvation and viral infections.

# An AIDS research success

■ A new vaccine seems to be protecting monkeys from a virus similar to the human AIDS virus, scientists say.

The Associated Press 1-24-92  
WASHINGTON — Scientists said Thursday that for the first time they have successfully vaccinated monkeys against an AIDS-related virus by using bits of the virus' outer coat — a method similar to one that has produced encouraging preliminary results in humans.

A team headed by Dr. Shiu-Lok Hu of Bristol-Myers Squibb Pharmaceutical Research Institute in Seattle vaccinated four macaque monkeys against the simian immunodeficiency virus, which is related to HIV, the human AIDS virus.

The scientists report on their study in the forthcoming issue of *Science*, the weekly journal of the American Association for the Advancement of Science.

Dr. Dani Bolognesi of the Center for AIDS Research at Duke University, which was involved in the study, said it was "clearly supporting evidence" that such a method could achieve success against the HIV virus in humans.

Monkeys had been immunized against SIV before, but it was done with vaccines made from inactivated whole viruses. The authors said use of whole inactivated HIV vaccines in humans presents problems because of safety questions.

Consequently, most efforts to develop an HIV vaccine have concentrated on strategies similar to the one used on the monkeys.

In tests now being conducted on human volunteers, Bolognesi said, "there are encouraging signs that this protocol is inducing good responses in people."

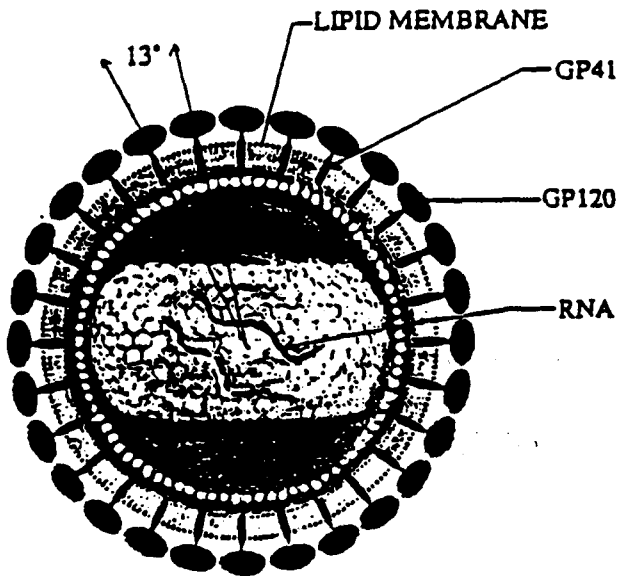

Two diagrams from Dr. Callahan's paper, "Dielectric Antennae Theory, UV Coherence, and a Possible Cure for AIDS." The large diagram shows an AIDS virus, and notes the 13° spread between each pair of protrusions on the viral surface—the GP120-GP41 dielectric antennae. The smaller diagram shows for comparison an above-ground top-hat antenna. Dr. Callahan's theory for disabling the AIDS virus, is based upon the insight that the glycoproteins on the membrane of the virus resemble an antenna array, and can be "jammed" in the same way.

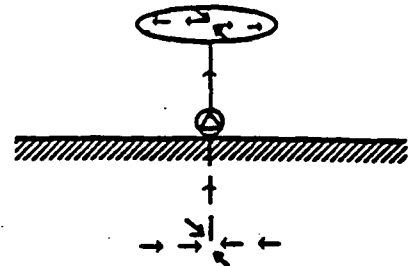

screened out as well.

The quartz window did allow transmission of ultraviolet light. The healthy cells became diseased when the ultraviolet signals emitted by the first culture were transmitted to them.

THE NEW FEDERALIST

# Radar: A New Model For Curing AIDS?

## SCIENCE & TECHNOLOGY

by Carol White

Philip Callahan, a biophysicist with a background in radar technology, has devised a new model for zapping the AIDS virus. It is based upon the insight that the glycoproteins on the membrane of the virus resemble an antenna array of the kind found at the Atlanta airport.

Dr. Callahan has written a two-part report on the subject, "Dielectric Antennae Theory, UV [Ultraviolet] Coherence and a Possible Cure for AIDS," for the Bio-Communications Research Institute of Wichita, Kansas, where he is a senior researcher. Callahan has a long history of research in the field of optical biophysics.

One of his unique discoveries of the past has been the identification of insect antennae as a mechanism for the detection of scents. One application of his discovery is non-polluting, low-cost control of insect populations. It is possible to direct insects into a trap, or simply confuse and deflect them from their target, by beaming low-intensity radio waves at them.

Now Callahan is applying the same method to the problem of virus control. His thesis is that the virus can be prevented from reaching its target—the genetic material of the host cell—by jamming its antennae.

Callahan noticed a similarity to the structure of the antennae associated with radio navigation systems. These are circular structures surrounded by round, knob-like balls at the end of metal rods. The transmitter is located at the center of this circle, and is known as "omni

range," because aircraft which approach the airstrip in bad weather can home in on the device from any direction.

When we compare the omni-range radar to the AIDS virus, whose structure is well known, the comparison Callahan is making is striking. In this instance, substances known as glycoproteins play the part of the round balls mentioned above.

Glycoproteins are proteins with sugar chains attached, and they are typically found on cell membranes. Obviously, in this instance the scale of the virus is on the order of 0.1 micrometer in diameter, as compared to the Atlanta airport device, so the difference in scale is a relevant consideration in judging his model, as Callahan himself notes.

He calculates that the frequency of the viral resonance would fall in the ultraviolet (UV) range. This would be in accord with the findings of Soviet investigators such as V.P. Kaznocheev, and the German scientist Fritz Popp.

Popp has identified coherent emissions of weak ultraviolet light as a governing mechanism of cells. Kaznocheev has investigated the transmission of "disease" from one cell to another, in instances where the only communication possible between the cells was the emission of ultraviolet distress signals from a diseased to a previously healthy cell.

In 1979, Kaznocheev took two cell cultures from monkeys, one of which was infected and one healthy, and sealed them in glass flasks which were separated first by an ordinary glass window, and then by a quartz window. In both cases the virus was prevented from traveling between the two cultures, and in the first case signals in the ultraviolet range of light were

## Callahan's Proposed Cure

If, within a short time, healthy cell cultures can be made to show the symptoms of disease "contracted" from an electromagnetic emission, then why cannot a virus (like AIDS), be similarly deactivated? The idea is to find the appropriate, resonant frequency which will jam the virus.

Callahan reasons that the AIDS virus tunes itself to a frequency in order to home in on the virus' target in the body: the T-4 lymphocytes in the blood.

The goal of Callahan's work, of course, is to damage the virus without harming healthy tissue. Therefore, the energy of the jamming radiation must be exceedingly weak, to avoid damaging other cells, and it must be precisely tuned, so that it will not resonate with organic systems other than the virus glycoproteins.

The virus may be acting like a 747 jet making an instrument landing in bad weather, but it may also be sending out a signal which attracts the blood's T-4 lymphocyte to it. At this stage of the research, it is not necessary to answer this question, although ultimately, if the model proves successful, this will be an important question.

Callahan has already built a scale model of his hypothesized viral omni-range system. He is hoping to interest AIDS researchers in this model, as well as to encourage electrical engineers and physicists to bring their own competencies into the work.

He plans to issue a report which will outline a non-ionizing radiation cure for the disease. Here he will be dealing with using energies low enough to eliminate the problem of introducing ultraviolet radiation into the body.

It is nothing short of tragic that work such as this is not adequately subsidized by the federal government, which squanders its funds on ludicrous campaigns for safe sex, and otherwise promotes less promising, mainstream research in the traditional areas of molecular biology.

# New Studies Show AIDS Virus Can Spread Through the Air

2-92

For years the federal Centers for Disease Control (CDC) in Atlanta, Ga. has insisted that HIV, the AIDS virus, is really very hard to catch, and that it is never transmitted through the air. Now, according to an article in the Washington Times Feb. 15, the CDC may have to eat those words: New studies show that AIDS, which is always fatal, and for which there is neither vaccine nor cure, can spread through aerosols.

In fact, the CDC is going to have to fund a study itself on this, according to the Washington Times—after all those years of lying.

According to the Times, the CDC was forced to act after Dr. Donald Jewett, professor of orthopedic surgery at the University of California at San Francisco, conducted a study showing "that aerosols containing HIV-infected blood were produced during orthopedic surgery when bone-cutting tools were used. He found that these particles were small enough to penetrate a surgical mask." The finding would also implicate high-speed dental drills, apparently.

Meanwhile, Gregory Johnson and William Robinson at Stanford University have done a study upsetting the CDC myth that HIV loses most of its potency on contact with air. They have shown it can survive and remain infective in an aerosol for at least several minutes.

## Can't Test New Vaccine

This isn't the only area in which the U.S. health mafia has played fast and loose with AIDS and American lives. The Feb. 1 issue of Science magazine reports that a major California biotechnology company cannot test its promising new vaccine for AIDS because of a shortage of chimpanzees. Next to human beings, chimps are the

best subjects for testing prototype vaccines, but apparently, since the heyday of the Carter administration in the late 1970s, it has been illegal to import chimpanzees because they are an "endangered species." As a result, chimps cost \$15,000 each, and for use in AIDS research must have an additional \$30,000 endowment each. Researchers are blaming the National Institutes of Health for the delay in testing a vaccine which may have the potential to defeat AIDS.

## WHO: Heterosexual intercourse caused 90% of recent HIV cases

The Associated Press 2-13-92  
GENEVA — More than 1 million people worldwide contracted the virus that causes AIDS in recent months. 90 percent of them through heterosexual intercourse, the World Health Organization said Wednesday.

In a chilling assessment of the spread of the AIDS epidemic, the U.N. health agency predicted the disease will soon become the main cause of premature death in many Western cities and will leave up to 10 million African children orphaned by the end of the decade.

A WHO report on the "Current and Future Dimensions of the HIV-AIDS Pandemic" said by early January, 10-12 million people had caught the human immunodeficiency virus. This was 1 million higher than the previous assessment in April. The new figure included 1 million children.

It can take 10 years or longer for a person infected with HIV to develop AIDS symptoms. Most people diagnosed with AIDS die within a few years.

It said an estimated 2 million cases of AIDS had occurred since the disease became known in the early 1980s — 500,000 more than reported by the U.N. agency in April.

The agency estimated that about 1 million people in the United States have been infected with HIV as of early this year.

"By 1992, an estimated 1.6 million HIV infections may have occurred in Australasia. North America and Western Europe, about two-thirds of these in the United States," it said.

The report reiterated projections that by the year 2000, 30 million to 40 million people will have contracted HIV.

## Worldwide HIV infections in adults

Estimated distribution of adults infected with HIV, the virus that causes AIDS, by world region, cumulative to January 1992.

Total: over 10 million

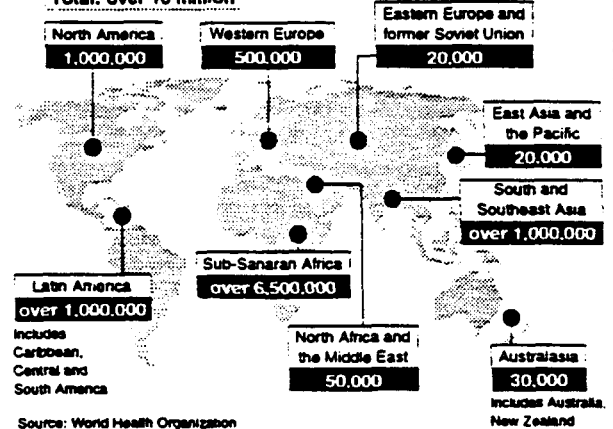

AP/T. Tean Cape

# THE STRECKER MEMORANDUM

With no cure and no effective treatment in sight, by the year 2000 A.D. everyone in the U.S. will be infected with A.I.D.S. This is the chilling conclusion of 5 years of exhaustive research by Dr. Robert B. Strecker, M.D., Ph.D.

This is the most controversial video tape ever made. Dr. Robert Strecker refutes, with documented evidence, virtually everything the so-called experts and government reports have told you about A.I.D.S. He asserts in no uncertain terms that:

- A.I.D.S. is a MANMADE disease . . .
- A.I.D.S. is NOT a homosexual disease . . .
- A.I.D.S. is NOT a venereal disease . . .
- A.I.D.S. can be carried by mosquitoes . . .
- Condoms will NOT prevent A.I.D.S. . . .
- There can never be a vaccine.

Although decades have passed and untold billions have been spent in research, CANCER is still with us, the second major cause of death in America.

The most dreaded fear that all oncologists (cancer doctors), virologists and immunologists live with is that some day CANCER in one form or another will become a contagious disease, transferable from one person to another. A.I.D.S. has now made that fear a reality, and if you think you're safe because you're not gay or promiscuous or because you're not sexually active then you had better watch Dr. Strecker's video very carefully and then watch it again and again until you fully understand what Dr. Strecker is telling you as he takes you step by step and shows you how this dreadful disease was actually:

- CREATED . . .
- DEPLOYED . . .

And now threatens the very existence of mankind because:

- IT WORKS!



*Dr. Robert B. Strecker is a practicing Internist and Gastroenterologist. In addition, he holds a Ph.D. in Pharmacology and is a trained Pathologist.*

- PREDICTED . . .
- REQUESTED . . .

THE STRECKER GROUP  
1216 Wilshire Blvd. • Los Angeles, CA 90017

To order, or for more information CALL: 1-800 548-3198  
• VISA • MASTERCARD Welcome • in Cal. (213) 977-1210

**\$29.95**  
+ \$3 for shipping  
and handling

## Romania halts experimental drug use on 83 AIDS babies

By DAN PETREANU 10-30-90  
Associated Press

BUCHAREST, Romania — The Health Ministry has halted controversial experiments being conducted on 83 babies infected with the AIDS virus, hospital officials said Monday.

The decision followed an investigation by a commission from the World Health Organization, which visited last week to look into the research conducted by a five-man British team.

The team, led by David Hughes, had been administering periodic injections of an experimental AIDS drug called FLV23/a to the patients at Bucharest's Colentina Hospital since September, with Health Ministry approval.

Although the WHO commission's conclusions were not made public, they were presented to the Health Ministry at the end of last week and the ministry decided to halt the experiments, the officials said.

"The data from the clinical trial . . . are not sufficient to determine the safety or efficacy of FLV23/a," the statement said.

The hospital officials said the next series of injections, scheduled today, would not be administered. This was confirmed by British volunteers also working at the hospital.

No comment was available from Hughes or members of his team.

Since the December revolution that ousted Communist dictator Nicolae Ceausescu, some 800 babies have been diagnosed nationwide as having the disease that kills by attacking the body's immune system.

Ceausescu was obsessed with increasing Romania's population of 23 million and forbade abortions and birth control. Tens of thousands of mostly unwanted babies were left at state institutions, where some contracted AIDS through blood transfusions.



## Testing For AIDS

A very interesting article appeared in the Olympian in Washington state on December 19, 1991. The information, prepared by the Associated Press, stated, "Prospective blood donors who recently received a flu vaccine have been registering false positive on three screening tests, including one for the AIDS virus, federal health officials said Wednesday." Amazingly, this article occupied only a few inches of space in the paper.

The article goes on to state, "While the false positive reactions may pose some inconvenience to blood donors and blood establishments, they represent no risk to the safety of the blood supply." This was reported to the AP by Dr. James Mason, assistant secretary for health in the Department of Health and Human Services. If you believe that then you would believe anything any government representative told you.

As reported in the SIMPLE TRUTH Vol. I No. 10, there is enormous evidence that the AIDS virus itself was initially introduced into the population of Africa by the World Health Organization via a small pox vaccination program. The WHO itself admitted that the vaccine was contaminated, and then refused any further investigation.

### 90 AIDS tests yield false positives 12/91

Federal health officials reported Wednesday night that about 90 people around the country who donated blood had falsely tested positive for three viruses, including the one that causes AIDS.

The findings created a scientific mystery because a recent influenza immunization was the only common denominator among 60 percent of the blood donors.

It was not clear how a flu shot would cause false positive reactions in the laboratory tests for the three viruses:

The first question of importance is how reliable are the testing procedures to determine the presence of HIV type viruses? It has been known since the inception of AIDS testing that the procedure itself was questionable and producing many false positives. It is also known that the AIDS virus has mutated into at least 20 different types of virus, therefore, how can you test for all of the various mutations?

The Olympian articles finishes with the statement, "The FDA is working with the makers of the flu vaccine and the manufacturers of the screening tests to determine the reason for the false positives." One should be very leery of accepting the credibility of FDA investigations. Too often the evidence has shown that pharmaceutical manufacturers have tampered with the evidence and the FDA has been extremely lax in doing thorough research.

One would be well advised to refuse any form of vaccination, especially a government sponsored program. The media has also been very negligent in reporting the number of people who have become extremely ill and/or died from receiving vaccinations. Vaccinations are the easiest way to infect an entire population with any disease. To assume that would 'never happen here' is to ignore strong evidence to the contrary.

The SIMPLE TRUTH

January 1, 1992

Box 347,

McKenna, Wash. C.F. 98558 C.F.

0 2 1 1

# 'I WAS REALLY LUCKY'

## HEALTH

■ Two months after she was struck with paralysis, Jannifer Lykins is recovering from Guillain-Barre syndrome.

By Filiz Satir 2-26-92  
The Olympian

Jannifer Lykins remembers a tingling in her feet when the syndrome first came on in mid-December. Jann, 22, also got the flu that day. At the time, she gave little consideration to the strange sensation that reminded her of a limb falling asleep.

But over the next 24 hours, the tingling crept into her lower legs and then her thighs. In another day, the muscle weakness entered her jaw and face. By New Year's Eve, Jann could not walk, let alone ride the mountain bike she received at Christmas.

It took doctors over a week to realize that the Hawks Prairie woman was not suffering from a stroke, but a rare neurological disorder called Guillain-Barre.

Fortunately, Jann is one of the 95 percent of patients who recover spontaneously from the disorder. Just two months after being stricken, Jann is walking on her own and plans to return to work at South Sound Center's Camelot Music soon.

"They say I was really lucky," said Jann last week. A handful of patients die from complications.

Guillain-Barre syndrome is a nerve disorder that came into widespread public attention in 1976, when 700 cases were reported in the United States among people who had been immunized with a vaccine containing weakened swine flu



Steve Bloom/The Olympian

Guillain-Barre left Jannifer Lykins so weak that sometimes she couldn't breathe on her own, swallow food or drink most liquids.

### virus.

Although the exact cause is unknown, the syndrome is seldom fatal. It often follows a viral illness. It has no known cure, but with the passage of time, most patients recover almost fully.

Yearly, one or two people per 100,000 suffer from the syndrome. It strikes with varying degrees of severity, and some patients require hospitalization. Among those who have recovered: author Joseph Heller, who wrote "Catch-22" and "Something Happened," and actor Andy Griffith.

One week after the onset of her symptoms, Jann was hospitalized at St. Peter Hospital in Olympia.

As Guillain-Barre sufferers go, Jann was quite young. She became so weak that the disorder sometimes left her un-

able to breathe on her own, swallow food or drink most liquids.

"It was difficult to speak without huffing and puffing," Jann said. Breathing and talking at the same time spent all her energy. Even clicking a remote control was an impossible chore.

"I remember watching movies at 2 a.m. when I couldn't sleep and not being able to change the channel," she said.

But after two weeks in the hospital, she gradually got her strength back.

"It was really weird ... how quickly I came back," Jann said.

Jann began eating "mush" for food. Soon, she was wheeling herself haltingly to the dining room. And with the help of physical therapists, she began walking with a walker.

On Jan. 27, a little over one month after the first signs of Guillain-Barre,

Jann returned home to live with her parents.

The Saint Martin's College graduate no longer requires a walker or a cane to get around. She has three physical therapy sessions a week where she does strengthening, balance and sensory perception exercises.

Sometimes the young woman forgets she's still recovering. As Jann continues to return to routine activities, including driving and soon a daily job, it's difficult for her to believe she ever suffered from temporary paralysis.

But an all-too-quick turn or movement acts as a reminder that the effects of Guillain-Barre are still around.

"One morning I woke up, felt full of energy and got quickly out of bed," said Jann, whose swiftness ended in a thud. "I fell right on my face."

### What it is

■ **What:** Guillain-Barre syndrome is a relatively rare, rapidly progressive form of temporary paralysis.

■ **Cause:** The exact cause of Guillain-Barre is unknown. It often follows a viral illness, such as the flu.

■ **Sufferers:** It's most common in people ages 30 to 50 and affects both sexes equally.

■ **Symptoms:** Muscle weakness is the major sign, usually appearing in the legs first and extending to the arms and facial nerves.

■ **Recovery:** About 95 percent of patients experience a complete recovery.

## THE NEW DESERT STORM?

On March 25, 1992 it was reported on television that an interesting development was starting to occur with servicemen that had served in Desert Storm. It will be recalled by some that all the troops that were to participate in the campaign were vaccinated with an experimental vaccine; now it is reported, a year later, that some of the troops are experiencing Chronic Fatigue Syndrome and hair loss. It sounds like the symptoms of radiation poisoning, but the only thing all the troops had in common is this vaccination.

A4 The Morning News Tribune, Thursday, March 26, 1992

# Odd ailments hit Indiana gulf vets

By Melanie Threlkeld  
The Associated Press

**INDIANAPOLIS** — About 60 members of Army Reserve units from Indiana have complained of mysterious illnesses since returning from Persian Gulf duty and Army officials confirmed Wednesday they are studying the ailments.

Reported symptoms include hair loss, muscle aches and chronic fatigue, officials said. Other symptoms include aching teeth and gums and thick saliva.

"It was so bad that when I showered, both my hands would be covered with hair," reservist Sgt. Lori Rosalius said in a telephone interview. She said she felt so ill shortly after returning to the United States last June that she thought she was "dying from some disease."

Rosalius, 28, of Crescent City, Ill., consulted two doctors and a nutritionist before she found any relief.

The complaints have been limited to about 60 members of three combat support units under the 123rd U.S. Army Reserve Command based in Indianapolis, said Steve Stromvall, spokesman for the Army Reserve Command in Atlanta. Those units were deployed to five locations in Saudi Arabia.

Army officials were trying to trace other units that served in the same areas, Stromvall said.

Some soldiers believe they were sickened by prolonged exposure to

## National Guard, reserve 'hit list' set; state may lose 900 Guard spots

The Associated Press  
and News Tribune staff

**WASHINGTON** — The Pentagon has prepared a "hit list" of hundreds of National Guard and reserve units it wants to eliminate, sources said Wednesday.

Pentagon sources, speaking on condition of anonymity, said the cuts are expected to affect up to nearly 150,000 positions in the National Guard and reserve. Even before details of the plan were released, howls of protest began to be heard on the Hill.

Rep. G.V. "Sonny" Montgomery (D-Miss.), a senior member of the House Armed Services Committee and a key supporter of the National Guard and Reserve, said the plan is expected to target one out of three Guard armories across the country.

Asked how it would be received on Capitol Hill, he re-

microwaves emitted by radar, Stromvall said.

"So far, there's no singular indication of a specific cause," he said.

Rosalius said she thought her symptoms might be a side effect from an anthrax vaccine the sol-

Army Reserves 209th Supply Company based in Lafayette, Ind., when her unit was activated and sent to Saudi Arabia in November 1990. Military officials said similar complaints have come from other members of the 209th unit, the 300th Supply and Services Battalion, also based in Lafayette, and the 417th Quartermaster Company at Scottsburg.

Rosalius said she became alarmed last July when she started losing abnormal amounts of hair. By mid-August her symptoms worsened. She had developed halitosis and fatigue that was so great she was only able to leave her bed a couple of hours a day.

The first two doctors she consulted treated her for a parasitic disease known as leishmaniasis, transmitted by sandflies in the Persian Gulf. They prescribed antibiotics that temporarily cured the halitosis. "But they never proved there was a parasite," she said.

In mid-September she consulted Chris Chalk, a chiropractor and nutritionist, who determined she was suffering from malnutrition and hypothyroidism. He linked Rosalius' illness to stress, heat and the processed food she ate while on deployment.

"I think it was because it was so hot and they drank and drank and drank" and rarely ate highly nutritional food, Chalk said. Chalk prescribed vitamins and other supplements, and Rosalius said she started to feel better by November.

spoiled, "like a lead balloon." The reductions are not expected to cut too deeply in Washington state, officials said.

Based on previous hit lists, the Washington Army National Guard stands to lose about 900 authorized positions next year, a decrease of about 12 percent in the Guard's statewide strength of 7,500 positions, said Lt. Col. Joseph Jimenez, a spokesman for the state Military Department.

But Jimenez said, "Every list we've seen has been different." The biggest state unit targeted for elimination next year is the 600-member 1st Battalion 803rd Armor, based in Everett.

Although the final details weren't available, those states expected to be hardest hit were California, Connecticut, Massachusetts, Michigan, New Jersey, New York, Oklahoma and Wisconsin, said the sources.

diars were ordered to take in January and February 1991 to prepare them for possible germ warfare.

Stromvall said: "That's something that hasn't been ruled out, among other things."

Rosalius was a member of the

## Virus blamed as cause of multiple sclerosis

**A** RESEARCHER in Western Australia claims that a virus causes multiple sclerosis. The evidence accumulated by Bob Cook from Murdoch University contradicts the orthodox view that MS is an autoimmune disease.

Senior researchers in Britain greeted the news with caution. Cedric Mims, professor of microbiology at Guy's Hospital Medical School, said: "I think there have been so many false alarms over the years that one is reluctant to believe anything until others have seen the details and reproduced the work."

Cook claims to have isolated the virus from the brain tissue of eight patients with MS. He points out that a similar virus has been found in 17 of 265 domestic cats in Western Australia, Iceland and in the New York area. The virus has been isolated and cultured from five cats in Western Australia.

It is possible, according to Cook, that cats could be carriers of MS, but he stresses that

Ian Anderson, Melbourne

other factors are probably also at work. These include stress and genetic susceptibility to the disease. Cook says that the virus he has isolated is similar to one that causes canine distemper and measles. It comes from a group of viruses called morbilliviruses.

Cook, an associate professor of histology from the School of Veterinary Sciences at Murdoch, has been working on MS for 17 years. He says that he has had difficulty publishing his results because they run counter to what has been accepted as a cause of MS for more than 30 years. But he had some of his work published in 1986 in the British *Journal of Neuro pathology and Applied Neurobiology* (vol 12, p 63).

"I'm a very careful scientist," Cook told *New Scientist* this week. "I don't make claims unless I can substantiate them properly." Cook is to present evidence for his claim this week at a seminar organised by

the National Multiple Sclerosis Society at the Walter and Eliza Hall Institute in Melbourne.

MS occurs when the myelin sheath—an insulating layer—around nerve fibres decays away. According to those who say MS is an autoimmune disease, lymphocytes from the body's immune system attack the myelin sheath. But Cook says that the disease is caused when the virus attacks the cells which form the myelin sheathing. These are called oligodendrocyte cells. The cells send out strands to form the sheath but when attacked by the virus these same cells withdraw the strands.

Cook believes that it would take less than two years and about A\$500 000 (£250 000) to produce a diagnostic kit to detect the virus in carriers. He has been unable to interest Australian companies in the kit, but he is currently negotiating with a West German company. Cook also believes that it may be possible to develop a vaccine for multiple sclerosis. □

New Scientist 15 September 1990

## Viral infection may cause childhood leukaemia

**C** HILDHOOD leukaemia may be a rare response to a viral infection, according to a researcher in Scotland. He believes it is most likely to occur when populations from different areas mix, such as in some British new towns (*The Lancet*, vol 336, p 577).

Leo Kinlen, Director of the Cancer Research Campaign Epidemiology Unit in Edinburgh believes that his explanation accounts for some of the observed epidemiology of childhood leukaemia; in particular, the outbreaks in some new towns, followed by depressed levels of the disease in later years.

Childhood leukaemia is relatively rare, affecting about one child in 2000 under the age of 15. But despite this, it has aroused strong public feeling because of its increased incidence in areas close to some nuclear installations. However, it is far from proven that the source of the disease is nuclear radiation.

Kinlen believes that the incidence of childhood leukaemia can be explained if a few children are heavily infected and the rest are lightly infected by an as yet unknown agent. Those children who do not develop the disease following infection are protected against developing it later. Kinlen predicts, therefore, that an "epidemic" of leukaemia should be followed by low levels of disease.

The idea that leukaemia and its close relations, the lymphomas, might have their origin in infection is not new. Herpes viruses

are implicated in Burkitt's lymphoma and retroviruses in adult T-cell leukaemia.

To test his hypothesis, Kinlen examined the deaths from the disease in 14 British new towns. He used statistics gathered over a 40-

in the pattern of childhood leukaemia between overspill and rural towns.

In the early years of the existence of rural towns, when the populations were growing quickly, the number of children with leukaemia was significantly greater than the national average, particularly, in very young children under the age of four. For instance, in Glenrothes in Fife, a rural new town, says Kinlen, the number of cases was about 11 times the national average. In older groups, he says, there were actually fewer cases of leukaemia than would be expected, confirming Kinlen's hypothesis.

It looks as though infection of young children was made possible because the newcomers came from a great diversity of places, and there were more children in the rural new towns. In the overspill towns, however, there were less children than in the urban areas from which the new populations came. As a result, says Kinlen, there was no epidemic of leukaemia in the youngest children. Also, the number of cases in older children fell short of what would have been expected, again consistent with an immunising effect.

Kinlen points out that the picture that emerges was rather like that seen in cats infected with feline leukaemia virus. Leukaemia is much more common among cats which live in households where there are lots of them than among those of single cat households.

John Galloway



Radiation from nuclear installations and childhood leukaemia have been hard to link. An infection may connect the two

year period starting when the building of new towns began in 1946. Nine of the new towns were overspill towns, which were designed to provide homes and jobs for people from London and Glasgow, while the other five were rural new towns, built to increase the workforce in areas pinpointed for industrial development.

The populations of the rural group were drawn from a much wider variety of places than those of the overspill towns. According to Kinlen, this partly explains differences

Ewan Horison/David Lyons

# HIV and African parasite may be linked

**F**RENCH scientists have discovered an intriguing connection between a parasite and HIV. The parasite, which causes schistosomiasis, a disease widespread in Africa, and HIV, the virus that causes AIDS, appear to produce a similar protein. The discovery, to be published in this month's *Journal of Experimental Medicine*, could give clues to the origin and epidemiology of AIDS.

André Capron, of the Pasteur Institute in Lille, France, and his colleagues, work on both schistosomiasis and HIV. Schistosomes are tiny, multicellular parasites that spend part of their lives in snails, and are spread to humans in fresh water. Each year, schistosomiasis, also called bilharzia, kills 800 000 people. Two hundred million people are disabled because of the disease.

Capron's team wanted to know which proteins on schistosomes are recognised by antibodies in the blood of animals with schistosomiasis. This would show which surface proteins are most effective in inducing immunity to the parasite, and which might work as vaccines.

As a control, to measure the random binding of proteins to the antibodies, the scientists exposed the anti-schistosome antibodies to a protein from HIV, virion infective factor (VIF). They used this partly because it would not be expected to bind specifically to the anti-schistosome antibodies, and partly because Capron was intrigued by similarities between schistosomiasis and AIDS; he wanted to see if, by chance, there were molecular similarities.

The team was amazed to find that antibodies from schistosome-infected animals bind specifically to VIF. They went on to find that antibodies to VIF recognised schistosomes. A monoclonal antibody, directed specifically against one part of VIF (the C-terminal), binds specifically to a protein on schistosomes. Antibodies from humans with schistosomiasis, but without HIV, bind to VIF in the test tube. Antibodies from humans with HIV, but no schistosomiasis, bind to schistosomes.

VIF is a regulatory protein produced by HIV when it replicates in cells. It appears to be important for enabling the virus to infect cells. The schistosome protein recognised by anti-VIF antibodies also appears to be important for infection by schistosomes. Monoclonal antibodies against VIF protected rats against schistosomiasis. Capron's group has now purified the protein from schistosomes that binds antibodies to VIF, and is sequencing the gene that codes for it, to see how similar the protein is to VIF.

The discovery, says Capron, has two major implications. One is for the function

Debora MacKenzie, Brussels

of VIF and the similar protein in schistosomes. "Parasites express very highly conserved functional proteins," says Capron. That is, the proteins they express have changed very little over evolution. The way in which the newly discovered surface protein



*Schistosomes, tiny multicellular parasites that are spread to humans in water, share a surface protein with the AIDS virus*

tein functions in schistosomes may reveal how the same sequence regulates infection by HIV. Such functions may be easier to study in schistosomes, says Capron, because they are well understood and easier to manipulate than retroviruses.

The second and most intriguing implica-

**A** DEFECTIVE gene may be responsible for up to 30 per cent of cases of osteoarthritis, according to scientists in the US. The gene codes for collagen, a type of tissue which holds together cartilage at a joint. Defective collagen is thought to weaken the cartilage, whose job is to cushion the bone.

Darwin Prockop and his colleagues at Thomas Jefferson University in Philadelphia and at Case Western Reserve University in Cleveland studied one family. They found that nine members of the family had a mutation in a single amino acid of a gene for a connective tissue called collagen II that caused osteoarthritis (*Proceedings of the National Academy of Sciences*, vol 87, p 6565).

In osteoarthritis, the cartilage at joints wears or disappears altogether. The bones can then grind against each other, causing inflammation and the growth of bone spurs. Some cases of osteoarthritis are caused by an injury to the bone, but the cause of other cases is unknown.

The scientists found that not all the colla-

tion is for the origins of HIV, and the possible interactions between the two infections. Some of the earliest evidence of HIV comes from Zaire and Burundi. These countries also have the highest rates of schistosomiasis, which has been established among humans in Africa for thousands of years, according to Capron. Most people exposed to HIV in Africa have already been exposed to schistosomes, and the results suggest that they might, in consequence, have some immunological ability to recognise HIV. Whether this reduces or exacerbates HIV infection, says Capron, can only be guessed at without better epidemiological data.

It is possible that schistosomes have only recently become infected by HIV themselves, and are merely expressing a viral protein. Capron says recent work in Japan shows that schistosomes can incorporate genes from retroviruses. But because antibodies against the protein can block schistosome infection, Capron thinks the protein is likely to be native to the parasite, and have some functional importance. It may also be speculated that the virus picked up the gene for this particular infective protein from schistosomes.

The protein has become a new candidate for a schistosomiasis vaccine, alongside other proteins, for which Capron hopes to begin a series of trials in humans. □

## Gene could cause osteoarthritis

gen in the weakened cartilage is defective, because some is made by the gene inherited by the mother and some by the gene from the father. People with the genetic defect seem to have only 25 per cent of their collagen defective with the remaining 75 per cent quite normal.

The defective collagen is like a bad brick in a wall, says Prockop. "If you have 25 per cent bad bricks the wall is not going to fall down right away, but over time it is going to get weaker." Arthritis strikes most often when people are over 50, he says.

But most cases of osteoarthritis do not seem to be caused by this genetic defect, Prockop says. However, out of nine other cases of osteoarthritis under study in the US and Finland, two seem to be caused by this gene defect.

According to Prockop, the discovery will allow doctors to do a simple genetic test to determine if children are likely to have osteoarthritis later in life. People may then alter their diet or career in order to reduce their chance of getting the disease, he says. □

## Instant virus: Just add RNA

Viruses are such primitive things that many scientists don't consider them alive. They cannot reproduce on their own; instead, they must hijack the reproductive machinery of living cells. Because of this shortcoming, virologists must grow their research subjects in dishes lined with cultured cells.

Now, scientists have devised a cell-free technique for growing tens of thousands of polio viruses at a time. In the Dec. 13 SCIENCE, they say the new process will allow insights into the life cycles of many types of viruses and will yield a faster and easier way to screen potential antiviral drugs.

The researchers, led by Akhteruzzaman Molla from the State University of New York at Stony Brook, isolated RNA from polio viruses and added this genetic material to a slurry of human cells that they had previously put through a blender and treated with several chemicals. The mixture yielded intact polio viruses that could go on to infect other cells, they report.

"This is the first time researchers have synthesized infectious viruses in a test tube," Molla asserts. He says his team hopes to use the process to mass-produce other disease-causing viruses. □

DEC. 14, 1991

SCIENCE NEWS, VOL. 140

## Polio outbreak shakes Jordan

Reuters 2-24-92

AMMAN, Jordan — Polio, a dreaded killer andcrippler of children, has struck Jordan. Health Ministry officials announced over the weekend.

Tens of thousands of frightened mothers hauled their children to hospitals and clinics for vaccinations as word of the disease spread. Jordan launched a nationwide campaign yesterday to immunize 600,000 children.

■ **MAN CONTRACTS POLIO:** A man described by his doctor as "staggeringly unlucky" was paralyzed by polio he contracted from changing the diaper of his niece, who recently was immunized against the disease. Children shed the polio virus in their feces for weeks after getting the vaccine, said Dr. Louis Lawton, the neurologist caring for the 48-year-old man. 1-25-92

## TECHNOLOGY & HEALTH

### Scientists at Weapons Lab Develop Test for Detecting Salmonella in Eggs

By JERRY E. BISHOP

Staff Reporter of THE WALL STREET JOURNAL  
In a new swords-to-ploughshares saga, scientists at one of the nation's weapons laboratories are developing a cheap way to test eggs for contamination by salmonella bacteria.

Salmonella contamination of eggs is a widespread public health problem. Consumption of raw or undercooked contaminated eggs can lead to stomach ache, diarrhea, vomiting and fever that can endanger the lives of infants, the elderly and infirm, and disable the healthy for a few days. The 50,000 cases of salmonella poisoning reported each year are believed to provide a gross underestimate of the extent of the salmonella problem.

At present, there is no way to know if an egg is contaminated short of breaking it open and culturing its yolk overnight to see if salmonella multiply to detectable levels.

Researchers at the Los Alamos National Laboratory in New Mexico, where the atomic bomb was developed, said they had successfully detected salmonella-infected eggs using a device designed to detect chemical and biological agents in artillery shells and other munitions. The device was developed to help verify compliance with arms control treaties.

The inspection device consists basically of two small sound transducers, each about the size of a quarter. One transducer serves as a speaker that converts electrical signals into sound and the other as a microphone that converts sounds back into electrical signals.

#### Measuring Resonance

An egg is placed between the two transducers. The speaker pings it with a pulse of sound of a specific frequency. The ping causes the egg to resonate like a musical tuning fork. The microphone picks up the reverberations and reveals the frequency at which the eggshell is resonating.

"The eggshell's natural resonance is affected by conditions in the egg white and yolk," the laboratory explained in an announcement. "Changes in the viscosity, density and other properties of the egg white and yolk can alter the frequency at

which the eggshell resonates," the laboratory said.

The researchers found that normal, uncontaminated eggs resonated at a single frequency of 830 hertz or cycles per second, which is a high G-sharp. But if the eggs were infected with salmonella the shell also resonated at a second, higher frequency in addition to the G-sharp.

#### Success Rate of 25%

So far, the researchers have been able to spot about 25% of the eggs that were contaminated by deliberately injecting them with salmonella. "We hope to fine-tune our measurements to pull out 100% of the infected eggs," said Roger Johnston, a member of the research team, who described the device at a science fair in Santa Fe, N.M., sponsored by the Los Alamos laboratory.

The idea of using the acoustical detection technique for eggs stemmed from a conversation Dr. Johnston had with an acquaintance at the U.S. Food and Drug Administration. One of Dr. Johnston's jobs with the process technology group at Los Alamos is to find biomedical applications for the lab's vast store of technology. The FDA scientist had asked if the Los Alamos researchers had anything that could deal with the salmonella problem. Queries around the lab led Dr. Johnston to Dipen Sinha of the electronics research group, who was developing the acoustical detection method for weapons inspection.

"We are using very much the same type of equipment now to look at eggs," said Dr. Sinha.

The researchers said they must still prove the system in the field to make sure it can detect eggs naturally contaminated with salmonella.

The detection device has been reduced to fit in a briefcase and probably could be manufactured for about \$200, a laboratory spokesman said. On a poultry-and-egg farm production line it could screen an egg every few seconds, the laboratory suggested, and probably could be adapted to detect cracked eggs, eggs with double yolks and fertilized eggs.

The Los Alamos laboratory said it has applied for a patent on the device.

# AIDS Plague Update

**T**HE announcement by Magic Johnson that he had tested positive for the HIV virus has once again propelled AIDS into the headlines. That so stunning an athlete, someone so full of life and potential, could fall victim to such a devastating disease has forced us all to consider our own mortality. It has also forced us to consider our own individual vulnerability to this scourge of the late 20th century.

The question of individual vulnerability to AIDS has unfortunately become an ideological and political battleground between competing in-

*'The AIDS activists tout the condom as a panacea to the problem of AIDS. It is not'*

stand and document the primary transmission patterns of AIDS. In addition massive amounts of money have been infused into the medical research establishment in an effort to achieve both a vaccine that would prevent AIDS infection and a cure for those already infected. Unfortunately the medical community has been prevented from exercising a leading role in preventing

AIDS Coalition To Unleash Power, and Queer Nation, have invaded churches, disrupted medical symposiums, and staged large protests to draw attention to their cause.

When someone like Magic Johnson announces that he has contracted the HIV virus through heterosexual contact, the AIDS victims groups are quick to use that information to attempt to convince the majority of Americans that they, too, are at high risk for contracting the virus.

What are the real risks of contracting AIDS for the average American who does not fall into a high-risk group? Is AIDS poised to become a heterosexual holocaust in America? It is time to abandon the propaganda and hysteria and to examine these questions on a thoughtful and realistic basis.



Scanning electron micrograph (SEM) of HIV-1 infected T-4 lymphocytes showing the virus budding from the plasma membrane of the lymphocytes.

Photos and other graphics courtesy of the U.S. Centers for Disease Control

terests. What should have been a strictly scientific discourse on the threat that AIDS poses to the general population has instead become a classic example of the triumph of politics over science.

The players on this political battleground are many. They include AIDS lobbyists who have endeavored to convince the nation, indeed the world, that literally everyone on the planet is at risk of contracting AIDS. To this end the AIDS lobby has consistently and relentlessly attempted to portray AIDS as the biggest threat to the majority community, (i.e., non-intravenous drug using heterosexual) since the Black Death.

Yet another player on this political battleground is the medical community. Epidemiologists and medical researchers have attempted to under-

stand and document the primary transmission patterns of AIDS. In addition massive amounts of money have been infused into the medical research establishment in an effort to achieve both a vaccine that would prevent AIDS infection and a cure for those already infected. Unfortunately the medical community has been prevented from exercising a leading role in preventing

the spread of AIDS. AIDS has become a political disease with a set of special "rights" granted its victims. These "rights" have prevented the medical community from taking the standard public health measures normally taken to control an epidemic.

Also on the AIDS playing field are the victims. Those who have already been diagnosed with HIV or full blown AIDS. Overwhelmingly in the United States, AIDS victims fall into groups which are outside the mainstream of society, mostly intravenous drug abusers, IVDA's, and their sexual partners, and homosexuals and bisexuals. The overriding concern of the AIDS victims is the discovery of a cure for the disease. Some AIDS victims have chosen to publicize their plight in highly controversial ways. Confrontational groups such as ACT-UP, the

AIDS Coalition To Unleash Power, and Queer Nation, have invaded churches, disrupted medical symposiums, and staged large protests to draw attention to their cause.

The HIV Virus — AIDS, acquired immune deficiency syndrome, is a disease complex characterized by a collapse of the body's natural immunity against disease. The collapse of the immune system renders the individual vulnerable to infections and cancers that usually pose little or no threat to someone with an intact immune system. The acronym AIDS was first used by the U.S. Centers for Disease Control, CDC, in late 1982. The first cases of what would come to be called AIDS were reported in mid 1981.

AIDS is linked to (and most leading researchers feel is caused by) a retrovirus now commonly known as HIV, human immunodeficiency virus. HIV has been found to have a number of variants which have also been associated with the development of AIDS.

HIV is a blood-borne virus. This means that it is transmitted from person to person through direct blood to blood contact or through bodily fluids containing HIV coming in contact with the blood of a non-infected recipient.

Transmission of HIV from one person to another is, (in relation to other viruses such as hepatitis-B) relatively

difficult. When such transmission occurs a concentrated source of the HIV virus, such as blood or semen, is almost always involved. This means that while the HIV virus has been found in such bodily secretions as tears and saliva it is not concentrated enough in those fluids to provide an efficient means of transmission. While theoretically possible, no cases or transmission from tears or saliva have yet been discovered.

The most efficient methods of HIV transmission are as follows: 1) The use of contaminated blood or blood products for transfusion or injection. Before 1985 when new blood screening procedures were installed, an estimated 12,000 persons received HIV tainted blood. More than 4,000 were subsequently infected with the HIV virus. Since 1985 there have been an estimated 15 to 20 million transfusions in the U.S. Out of that number only 15 people were infected. 2) Use or sharing of contaminated syringes or needles by IVDA's. IVDA's are the fastest growing class of newly diagnosed AIDS cases. 3) Unprotected anal intercourse. This has been the most significant risk factor for HIV transmission among homosexual men in the U.S. (Homosexuals account for 58 percent of the U.S. AIDS infected population). The reason is that the rectal lining is particularly susceptible to traumatic tears and ulcerations during anal intercourse. Such trauma facilitates the passage of the HIV virus to the receptive partner — male or female. 4) Heterosexual vaginal intercourse. Despite the hysteria of recent headlines, purely heterosexual contact accounts for less than 6 percent of AIDS cases in the country. There is no dispute that heterosexual vaginal sex can transmit the HIV virus between partners, however the likelihood of transmission is vastly lower in vaginal intercourse than it is in anal intercourse. In cases of strictly heterosexual transmission it is known that HIV is more readily passed from the male to the female. It is theorized that this is so because there is a greater concentration of the HIV virus in a male's ejaculate than there is in a female's cervical-vaginal fluid. Further, semen remains in the vagina for days, giving the HIV virus plenty of time to find vulnerable cells to infect.

**AIDS Statistics and Perspective —**  
As of Oct. 1, 1991, the CDC listed the following statistics for U.S. AIDS cases: A total of 195,718 persons diagnosed with AIDS. Of those 69,559 or 35.6 percent are still living. The breakdown

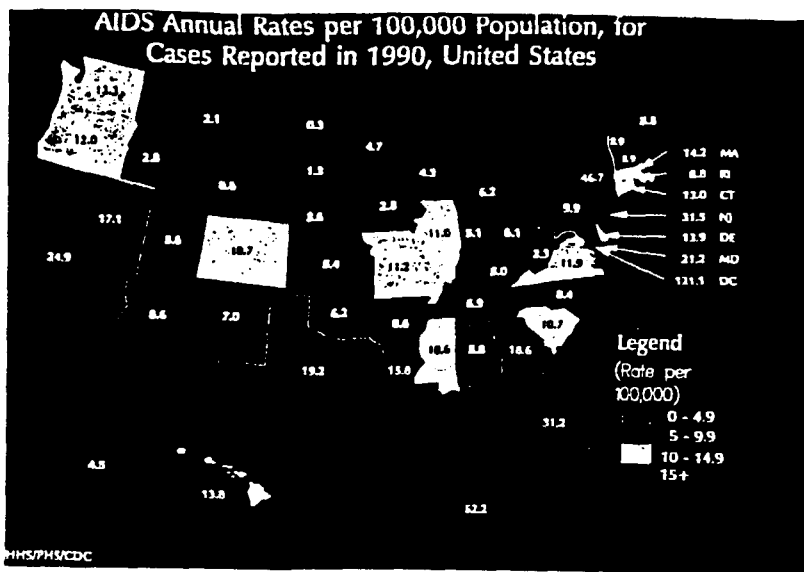

In males, 112,812 cases (58 percent) attributed to homosexual sex; 33,984 cases (17 percent) attributed to IV drug abuse; 12,580 cases (6 percent) attributed to combination homo/bisexual sex and IV drug abuse; 4,321 cases (2 percent) attributed to heterosexual sex; 2,592 cases (1 percent) from tainted blood transfusion; 1,584 cases (less than 1 percent) from tainted blood products used in treatment of hemophilia; 5,737 cases (3 percent) undetermined causes.

In females, 10,044 cases (5 percent) attributed to IV drug abuse; 6,668 cases (3 percent) attributed to heterosexual sex; 1,613 cases (less than 1 percent) from tainted blood transfusion; 38 cases from tainted blood products; 1,433 cases

of undetermined cause.

For some 2 percent of the total AIDS cases (3,312 cases) there was no information available. The CDC also estimates that there are approximately 1 million Americans who are currently infected with the HIV virus.

For the rest of the world statistics from the World Health Organization, WHO, indicate that there are perhaps 5 million persons currently infected with the HIV virus. More than 1 million people worldwide have progressed from HIV infection to full blown AIDS. Dr. Michael Merson, director of the WHO's Global Program on AIDS, says that according to WHO estimates, by the year 2000 between 30 and 40 mil-

### Adult Cases of AIDS by Exposure Category Reported in 1990, United States

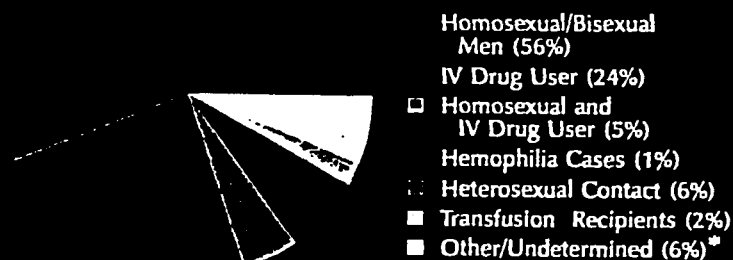

\*Includes patients under investigation; patients who died, were lost to follow-up, or refused interview; and patients whose mode of exposure to HIV remains undetermined after investigation.



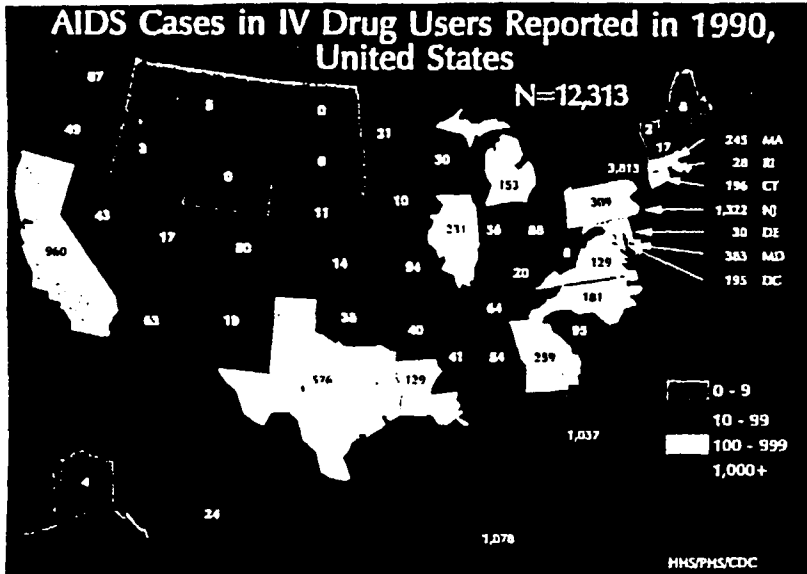

In the U.S. we spend almost \$2 billion per year on AIDS research. Yet at the same time we spend \$1.5 billion a year on cancer research, a disease which kills 12 times as many people each year as does AIDS. Research funds for the nation's top killer, heart disease, amount to only \$610 million per year. Says the author of *The Myth of Heterosexual AIDS*, Michael Fumento, "It's wrong to spend more money on a disease (AIDS) that will never kill more than 35,000 to 40,000 people a year than on a disease that will kill a half a million every year."

**U.S. Heterosexuals — How Real the Threat? —** A story on AIDS in the January 12, 1987 edition of *U.S. News and World Report* said of the spread of AIDS into the heterosexual population, "The disease of them suddenly is the disease of us. The slow death presumed just a few years ago to be confined to homosexuals, Haitians, and hemophiliacs is now a plague in the mainstream, finding fertile growth among heterosexuals."

About the same time the above mentioned article appeared, a member of President Reagan's AIDS Commission, Theresa Crenshaw, wrote this mind-boggling paragraph in a report to a House of Representatives subcommittee, "If the spread of AIDS continues at the same rate, in 1996 there could be 1 billion people infected; five years later, hypothetically 10 billion; however, the population of the world is only 5 billion. Could we be facing the threat of extinction during our lifetime?"

Well, the simple fact is that although the media and AIDS activists have been making statements like this virtually since the beginning of the AIDS epidemic, such dire predictions have proven themselves absurd.

Five years after the above mentioned predictions of heterosexual catastrophe, in the U.S. there are currently actually just 11,000 such cases.

Activists are quick to point to what has been called "the African analogue" as an indicator of what the U.S. can look forward to. A 1987 report by the U.S. Public Health Service cited an alleged 90 percent heterosexual transmission rate in Africa. Robert Redford, the well known actor turned activist, was quoted as saying, "People say oh... Africa, it's different... The fact is AIDS

lion adults and children, most in Africa and Asia, will have been infected with HIV.

According to Dr. James Chin who tracks and forecasts the size and direction of the AIDS epidemic for the WHO, the U.S. and Europe may see the growth rate of new AIDS cases begin to level off in 1995. "By the mid 1990s annual new cases of AIDS will peak in the developed world, but not until 2000 or beyond in Asia and Africa."

At first glance the statistics for current and future AIDS cases seem overwhelming. However one must keep in

mind that despite the publicity given to AIDS, it is by no means the world's worst killer. Consider the following. Since the outbreak of AIDS in 1981, close to two-thirds of those diagnosed with AIDS in the U.S., some 126,000 people, have died. During that same 10-year time span more than 5 million Americans died from cancer. An additional 6 million died from heart disease. In Africa alone, 1 million people die each year from malaria. Ten million others, including 4 million children, die from acute respiratory infections.

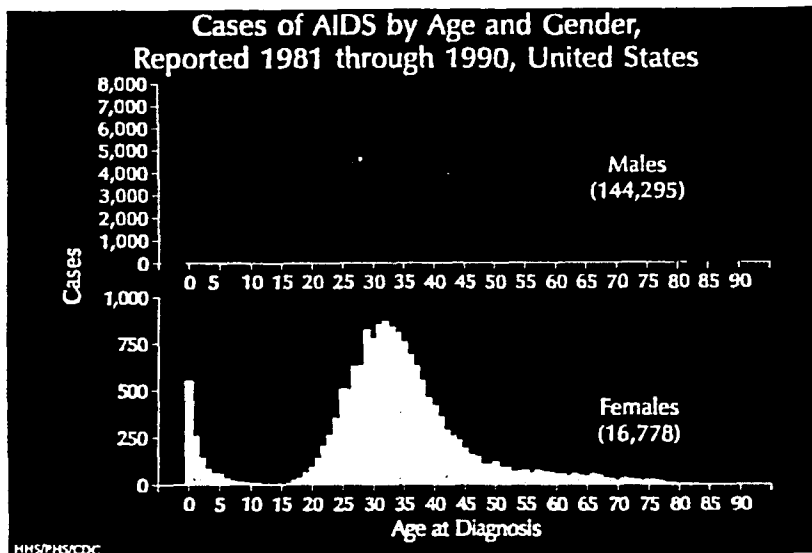

has moved. The infection has spread through Africa, like it is spreading through the U.S."

Author Michael Fumento has raised serious doubts as to the validity of that figure on a number of grounds. First, says Fumento, since the African example is supposedly what the future patterns of transmission in the U.S. will look like, the African AIDS epidemic must be older, or more mature, than the U.S. epidemic. It is not. AIDS was recognized on both continents in 1981.

Second, Fumento questions the similarity of the AIDS epidemiological pattern between the U.S. and Africa. "A host of factors exist in Africa that do not exist here but that greatly facilitate the spread of HIV in non-sexual ways." One such factor for example is the availability of blood screening. It was not until the late 1980s that such screening became widespread in Africa.

In a CBS *60 Minutes* report on AIDS in Africa, reporter Diane Sawyer visited a hospital in Uganda that had one of the country's five blood

---

### A host of factors exist in Africa that do not exist here

---

screening machines. "The day we were there, (said Sawyer, the hospital) tested blood samples from donors and the results were 28 percent positive. But when the donors who tested positive came to get their results, if they looked healthy, they weren't told they were carrying the virus. The doctors said there's no point in giving someone a possible death sentence when you have no counselors to help them deal with the news. Even if it means they spread the disease to others, the doctors say, one cruelty doesn't justify another."

In addition the use and reuse of unsterilized needles, for drawing and donating blood and for injections, is widespread in Africa. Most Central and East African countries can simply not afford to use the single-use disposable syringes used in developed countries.

One of the key elements in the dispute about heterosexual AIDS transmission in Africa is the widespread African taboo against homosexuality. The subject is simply not discussed or even acknowledged throughout much of Africa. Some African countries have laws which punish homosexual conduct and others, because the subject

is so taboo, simply deny its existence. One Angolan diplomat said, "the evil of homosexuality does not exist in our country, and it is consequently not mentioned in our legislation."

Obviously such statements have little factual basis, yet many AIDS researchers accept them without question. Partly this is a cultural question. It is unlikely that a white Western physician or researcher, questioning an AIDS positive black African villager about his possible homosexual experiences, will get a truthful answer, especially in a country where such experiences are criminal acts.

There simply is not enough space in this article to fully explore all of the reasons why the African experience with AIDS is unlikely to repeat itself in the West. However, it is interesting to note that for the most part it is not the scientific community which is proclaiming the relevance of the "African analogue" to the U.S. model. Rather it is the AIDS activists, and some in the press, who seek to use the African example to frighten and terrorize the average, mainstream American citizen.

**The Condom Controversy** — Condom usage does not guarantee safe sex. A more appropriate term would be "safer sex." Condoms have a failure rate of 10 to 17 percent. For anal sex the failure rate is even higher due to the physical differences between the rectum and vagina. As Fumento puts it "The irony of condoms would prove to be that they were of the greatest efficiency to those who needed them least — anyone engaging in oral sex and heterosexuals engaging in vaginal sex — and of the least efficiency to those who needed them most — homosexuals engaging in anal intercourse.

Still, for heterosexuals engaging in higher than normal risk activities (i.e., having sex with IVDAs, bisexuals, prostitutes, etc.), or even simply casual sex between partners who are not absolutely certain that both are HIV free, condom usage is recommended.

A note on condom usage. Only LATEX condoms provide protection from HIV. Skin-based condoms are porous enough to allow the HIV virus to slip through. Also, only WATER-BASED lubricants should be used with condoms. Petroleum based lubricants can effect the integrity of latex condoms.)

The AIDS activists tout the condom as a panacea to the problem of AIDS. It is not. Before anyone, heterosexual or homosexual, relies on a condom for complete protection, it might be wise



HIV-1 type virus found in a hemophilic patient who developed AIDS.

to ask the following question, if I knew that my partner was HIV infected, would I still have sex with that partner and trust my safety to a condom?

All epidemics reach a saturation point past which they begin to recede. Some researchers think that the U.S. has already reached that point. Others see it being reached in the mid 1990s.

Research should certainly continue on finding both a cure and a vaccine for AIDS. However that research should be in conjunction with the standard public health measures taken to control any epidemic. These measures should include mandatory testing of all newly admitted hospital patients as well as health care workers involved in invasive procedures. In addition all prisoners and people enrolled in IV drug rehabilitation programs should be tested. For those who test positive, normal contact tracing of previous sexual partners and their testing should also be undertaken.

The notion that an AIDS carrier's right to privacy outweighs a society's right to protect itself from an epidemic is absurd and must be challenged. As Michael Fumento put it in the closing pages of *The Myth of Heterosexual AIDS*, "If AIDS victims want to be treated as well as victims of other diseases, that is their right. But they have no right to be treated any better, either. There is not national guilt for AIDS, and there is no excuse for condescending to AIDS activists as if there were." ●

# Congress slams misconduct in medical research

9-90

Christopher Joyce, Washington DC

**K**ICKBACKS, fraud and misconduct are rife among American medical researchers, according to a scathing critique published by a US Congressional committee this week. The report says that the National Institutes of Health has "endangered public health" by failing to police the scientists it supports. It calls for new laws that would force scientists on government grants to limit their ownership of company stock, and their acceptance of consulting fees and honoraria from industry.

The NIH allocates almost \$8 billion (some £7 billion) a year to research, mostly to individuals and their institutions. But, says Congressman Ted Weiss, who directed the investigation, the NIH "provides few safeguards to make sure that the research is accurate and unbiased".

Weiss's report cites several cases of alleged or proven misconduct, fraud, and conflict of interest among researchers receiving NIH grants. One case involved a study to evaluate the effectiveness of tissue plasminogen activator, an agent for dissolving blood clots in people who have just had heart attacks. At least 13 researchers owned or had options to buy stock in Genentech, a manufacturer of the drug, says the report.

The NIH does not bar arrangements between companies and grantees. Last year, the government proposed rules that would have limited such links. But it backed down after receiving hundreds of objections from companies and scientists.

Another case mentioned in the Congressional report involves a cancer researcher, Herbert Hoover. Hoover conducted a decade of experiments in immunotherapy, in which he injected patients suffering from colon or rectal cancer with their own tumour

tissue to strengthen their immune response.

Hoover's former nursing assistant, Ruth Ann Carpenter, says that while at the State University of New York at Stony Brook, Hoover dropped several patients from the study when their cancers re-occurred after treatment. He also included control subjects in the study who had previously had cancer, contrary to the protocol, says Carpenter. Hoover's paper in the journal *Cancer*, describing the treatment as effective, was incorrect, say Carpenter and colleague Martyn Burk, chief of cancer surgery at Stony Brook.

The Congressional report says that Hoover moved to Harvard where, in 1989, an investigation into his work began. One of Harvard's reviewers concluded that Hoover had performed "excessive interpretation" of the data. Harvard's final report said the research was "flawed" and "not acceptable by the standards of the four institutions" where he had worked. Harvard found no misconduct or fraud, but said that Hoover's research should be closely monitored. The NIH is reviewing the conclusions.

The NIH has also been accused of being too slow to resolve cases involving ethical misconduct. James Abbs, a neurologist at

the University of Wisconsin, is suing NIH's Office of Scientific Integrity. Accused by a former graduate student of faking data on patients with Parkinson's disease, Abbs was cleared by his university. But the NIH was not convinced and started its own investigation in 1988. Last July, Abbs took action against the NIH, arguing that the investigation violated his right to confront his accusers.

The NIH is also implicated in another lawsuit. A former laboratory technician, Thomas Condie, is suing his former boss, John Ninnemann, for allegedly falsifying research on how to treat people who are badly burned. It is the first lawsuit under a 1987 law that allows citizens to sue individuals they believe are defrauding the government. Condie says that Ninnemann wasted \$1.3 million of NIH money.

Meanwhile, the universities are confused over what rules to follow. "The standards on conflict of interest are unclear," says Robert Rosenzweig of the Association of American Universities. "I don't think [NIH's] performance has been very impressive so far."

In a fresh twist to the issue, President George Bush this week nominated Bernadine Healy as the new director of the NIH. Healy, a cardiologist at the Cleveland Clinic in Ohio, is an outspoken critic of biological researchers' industrial links. □



Weiss: led inquiry



Sandoz AG, Basel sucht für die Abteilung Agrottoxikologie einen jüngeren

## Natur-wissenschaftler

biologischer Richtung für die Planung, Überwachung und Auswertung von vorwiegend längerfristigen Tierversuchen sowie für die Mitarbeit bei Spezialuntersuchungen im Rahmen der experimentellen Prüfung von Pestiziden und chemischen Neben- und Zwischenprodukten.

Diese Aufgabe bedingt nebst einem abgeschlossenen Studium Erfahrung in Planung und Statistik, Freude am Arbeiten mit Tieren und Interesse an toxikologischen Problemen sowie Englischkenntnisse. EDV-Erfahrung ist erwünscht.

Recurrent want-ad in Zurich's "intellectual" weekly, *Weltwoche*, in 1978. Sandoz, one of the Swiss drug giants, offers a job to a young scientist "who finds pleasure in working with animals in long-term experiments." (Emphasis supplied).

**SANDOZ**

Sandoz AG, Personalwesen, Ref. 1145  
Postfach, 4002 Basel  
Tel. 061 24 49 54 (Direktwahl)

# Fungal warfare in the medicine chest

Gliotoxin belongs to a class of "useless" chemicals produced by common fungi. But it may provide a new way to safeguard transplanted organs and act as a model for anticancer drugs

Paul Waring and Arno Müllbacher

**A** FEW curious natural compounds have revolutionised medicine in the 20th century. These are part of a huge range of chemicals that fungi produce when they have too few nutrients. Their value to the fungi is uncertain (see *New Scientist*, 7 October 1989) but, fortunately for us, they turn out to have dramatically beneficial medicinal effects. The best known is penicillin. Now another "useless" fungal chemical has come to light which may become an equally important drug.

These fungal chemicals are called "secondary metabolites", to distinguish them from primary metabolites—compounds that fungi produce as part of the biochemical processes that keep them alive. No one knows quite what secondary metabolites do for fungi, but they may inhibit the growth of other organisms competing with the fungi for scarce food—a sort of fungal chemical warfare. Not surprisingly, then, these chemicals often have antibacterial or antifungal properties. Their chemical structures vary widely, ranging from palytoxin, an extremely complex metabolite isolated from some sponges, to simple organic acids like oxalic acid produced by some *Aspergillus* fungi. The most famous secondary fungal metabolite, penicillin, was discovered accidentally in 1928 in the mould *Penicillium notatum* by Alexander Fleming and developed by Howard Florey. Today, penicillins and their synthetic analogues are among the most successful antibiotics.

In 1976, J. F. Borel, a chemist working for the pharmaceuticals manufacturer Sandoz, discovered another useful secondary metabolite, cyclosporin A, in the fungus *Tolypocladium gams*. Surgeons now use cyclosporin A routinely as a drug to prevent rejection of transplanted organs; the drug works by suppressing the body's immune response. The beneficial qualities of penicillin and cyclosporin A were discovered by serendipity, but many laboratories now screen fungal metabolites for biological activity as a matter of course.

In 1984, we became interested in another fungal metabolite, gliotoxin. Researchers have known about this compound since 1932, but no one had investigated its full spectrum of biological activity. What sparked off our interest in gliotoxin was a curious discovery made when one of us (Arno Müllbacher) was studying cytotoxic cells—cells of the immune system that destroy invading or infected cells. In this particular experiment Müllbacher used macrophages, a type of white blood cell, as targets for cytotoxic cells to see if they were killed following viral infection.

Macrophages, or "big eaters", are the scavengers of the immune system. They engulf unwanted foreign particles such as bacteria—a process called phagocytosis—and to do this



Deadly but good: *Aspergillus fumigatus* produces a toxin that may rival penicillin

they first stick to the particles. Müllbacher noticed that the macrophages in his culture had become contaminated with a fungus, a common and unwanted occurrence. But he decided to carry on with his experiment. Soon, he noticed something odd—the macrophages no longer stuck to the culture dish. This was interesting because, as every cell biologist knows, it is often difficult to remove macrophages from culture dishes without killing them in the process.

Müllbacher's first thought was that the macrophages had died, but this was not so. So he reasoned that some compound produced by the fungus must be preventing them from attaching to the culture dishes and so also preventing phagocytosis. The fungus turned out to be a common strain of *Aspergillus fumigatus*, which may be growing in your kitchen or compost heap at the moment. The next step was to grow the fungus and isolate the active compound it was producing. We found that it was in fact made up of several compounds with similar structures: the disulphide gliotoxin and its tri and tetra-sulphide relations (see Box 1).

In the mid to late 1980s we did several experiments to find out if other cells as well as macrophages were affected by gliotoxin. We found, for example, that it prevented certain immune cells from proliferating when they were stimulated by

## 1: The secret of fungal poisons

**GLIOTOXIN** belongs to the class of secondary fungal metabolites called epipolythiodioxopiperazines, or ETPs. These compounds all have as part of their structure a bridged disulphide ring. It is this ring that gives them their antimicrobial and immunotoxic properties, and removing the disulphide takes these properties away.

In 1985 Rex Munday, working at the Ruakura Animal Research Centre in Hamilton, New Zealand, reduced and then reoxidised ETP compounds to produce superoxide radicals and other reactive oxygen-based compounds such as

hydrogen peroxide. He was interested in ETP compounds because they are known to cause a disease called facial eczema in sheep. He found that the oxidised form (2) can be reduced by a number of reducing compounds found in cells, such as glutathione, to give the reduced form (1). This then reverts to the oxidised form, consuming molecular oxygen and producing a superoxide radical in the process. The process can continue as long as enough reducing compound and enough oxygen are available. It is called redox cycling, and if it goes on inside cells these reactive molecules destroy large molecules in the cell. This will eventually kill the cell.

Sheep contract the disease facial eczema by eating a related ETP called sporidesmin, which is found in spores of the fungus *Pithomyces chartarum*. This fungus grows on grass, particularly in wet climates, and the disease is particularly prevalent in New Zealand. Researchers at the Ruakura Animal Research Station discovered back in 1963 that sporidesmin damages the liver and bile ducts of the sheep. This makes the animals

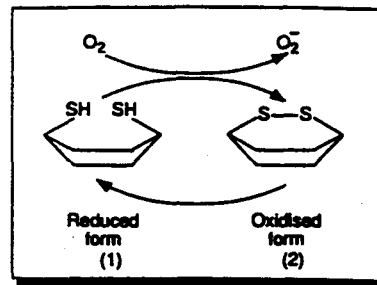

Oxidation of (1) to (2) gives superoxide radicals. These destroy larger molecules, eventually killing cells

extremely sensitive to light, and results in the characteristic eczema appearing on their faces.

The remedy is to pretreat the sheep with zinc salts. Munday thinks that this may be due to the antioxidant properties of zinc. It can bind to the dithiol form of reduced ETP compounds and prevent autooxidation. Interestingly, zinc also inhibits apoptosis, a particular kind of cell death induced by ETP compounds. □



Fungal toxins cause eczema in sheep

Univ of Sydney

mitogens—chemicals used to mimic antigens. We learnt that gliotoxin particularly affects certain cells of the immune system. It poisoned other cells too, but only at much higher concentrations. Gliotoxin and compounds related to it seem to be immunotoxins, a name usually given to toxins specifically affecting immune cells but often used to describe any compound that suppresses the immune system.

Such compounds are very important in medicine. People who receive transplanted organs must take drugs to prevent their immune system from rejecting the foreign tissue.

Cyclosporin is the most common one but there are other related compounds, such as cyclophosphamide, a nitrogen-containing ring. All these immunosuppressive drugs are poisonous to all the body's cells and they have the extra disadvantage of making the person taking them susceptible to other infections. This can be devastating when the body is already weakened by the transplant operation. Taking the drugs for a long time, usually years, can also increase the chance of cancer because they reduce the immune system's natural surveillance and destruction of cancer cells.

A clever way round this problem would be to make the new organ "immunologically invisible" before transplanting it. All cells have special molecules on their surface called histocompatibility antigens. These enable the cells to distinguish between "self" and "nonself". But a second trigger is apparently needed to set off the rejection: a small number of cells in the transplanted tissue, called passenger leukocytes or stimulator cells. These cells include macrophages and other cells of the immune system and they are the only ones that can trigger the immune response. If they could be killed or

neutralised in some way, then the body would not recognise the transplant as foreign, and this would do away with the need for immunosuppressive drugs. Could gliotoxin do the trick?

We tested this possibility by treating the thyroid glands of mice with gliotoxin and then transplanting them into mice of a different strain. The tissue lost its ability to stimulate an immune response in the host mice, even though it retained all its other physiological functions. So it seems that gliotoxin or some related compound might prove useful for treating organs and tissue for short periods before transplantation. This would

leave the immune system of the person receiving the transplant working normally so that it could then cope with any common infection. Once we have studied the natural compounds in detail, it should be possible to design synthetic ones that are even more selective. In our laboratory we hope to extend the results of our work on mice tissue to human cells.

Bone marrow is also commonly transplanted, as a treatment for leukaemias, which are cancers of the white blood cells. Conventionally, doctors treat leukaemias by irradiating the whole body, which kills all

white blood cells, including the cancerous ones. Then they must replace these cells with healthy ones, usually by transplanting bone marrow from a suitable donor. The foreign bone marrow contains immature cells from which all the blood cells the recipient needs will eventually grow.

But there are problems with this treatment, which in some ways are the reverse of those associated with organ transplants. The foreign bone marrow also contains mature white blood cells. If these are not removed, they will attack cells in the tissues of the recipient, a serious condition known as graft

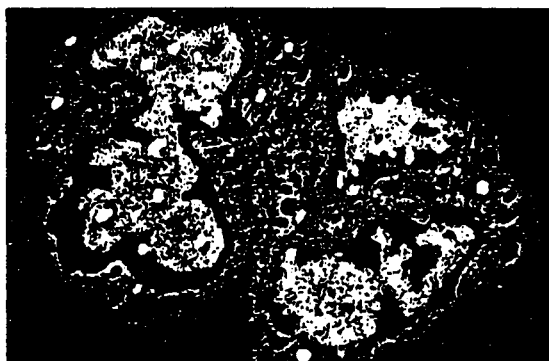

Cytotoxic cells engulf foreign particles, including cells from transplanted organs. How does gliotoxin stop them?

Sendox D/2agury/Peitl Format/SPL

## 2: A hint of infection in the air

**ASPERGILLUS FUMIGATUS** is a fungus often found on decaying organic material such as decomposing food. It grows best at about 37 °C, so people and animals provide ideal conditions for it to grow. Breathing in its spores causes aspergillosis, a disease in which the fungus grows in the walls of the lungs. People suffering from leukaemia or some other blood disease, whose immune system is depressed, are susceptible to this infection.

The number of aspergillosis sufferers has increased rapidly in the last two decades, partly as a result of the AIDS epidemic. People who have just received a new organ by transplant are also in danger because of their immunosuppressed state.

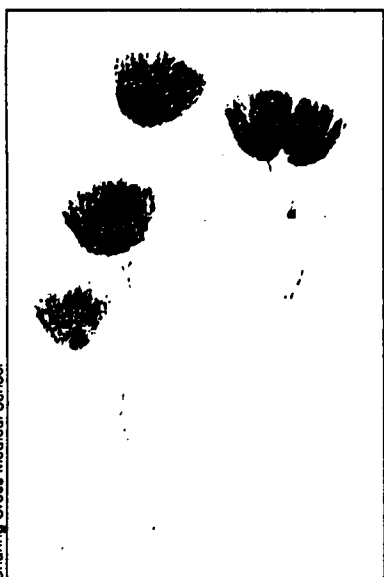

Charing Cross Medical School

Farm workers who handle animal feed containing infected grain often suffer from a milder form—farmer's lung—in which a ball of fungus grows in their lungs. This kind of infection is very difficult to treat using chemotherapy and antifungal drugs are usually very poisonous so the fungus has to be surgically removed. Some people are allergic to *Aspergillus* and it can cause breathing difficulties in people who suffer from asthma.

Animals too are susceptible to aspergillosis or its toxins. In the 1960s millions of turkeys died from the disease after eating feed contaminated with aflatoxins produced by *Aspergillus flavus*. In the US, aspergillosis is still an economically important cause of turkey loss. But no one knows for certain how aspergillosis develops in either man or animals. In 1987 we became interested in the possibility that gliotoxin may be produced in an animal during the course of the growth of the fungus. This is different from the animal (or human) eating or breathing in the toxin after it has formed on mouldy food for example.

We already knew about the pronounced effects of gliotoxin on the immune system.

*Breathing in Aspergillus spores (left) can cause infection. Once established in lung tissue (right), the fungus produces gliotoxin. This suppresses the body's immune system, making recovery difficult*

Did aspergillosis produce gliotoxin during the infection? When we examined the tissue of animals that had developed aspergillosis under laboratory conditions, we detected gliotoxin and some of its metabolites in this tissue. Using chromatography, we showed that this was not introduced on the spores but was made in the animal as the fungus grew. This explains the poor rate of recovery from aspergillosis and related diseases: the fungus has only to establish itself, and it can then produce a substance that will suppress the immune system, preventing the body from coping with the infection in the usual way.

As they evolved, organisms that produced gliotoxin and similar metabolites probably had a head start on others that did not. Some fungi may have produced antibacterial compounds such as penicillin as a chemical defence against other organisms when food was in short supply: gliotoxin's original function may have been to keep in check amoeba or other organisms that live by engulfing particles. Such organisms, in the form of macrophages, now keep the vertebrate immune system running. □



versus host (GvH) disease. One way to remove these troublesome white blood cells is to attack them with monoclonal antibodies that have been designed specifically to recognise these cells and neutralise them. This is a long, expensive and cumbersome process. It also carries with it the danger of infection by virus due to contamination of the antibodies. We wondered if gliotoxin could do the same job.

In 1988, we treated bone marrow from one strain of mice with gliotoxin, then transplanted it into a second strain of mouse whose bone marrow had been destroyed with radiation.

We discovered that this treatment prevented GvH disease. It seems that, in mice at least, the mature white blood cells that bring about GvH disease are more sensitive to gliotoxin than are the immature ones. David Haig at the Moredun Research Institute in Edinburgh did similar work on sheep earlier this year. He found a similar difference in sensitivity to gliotoxin between mature and immature cells of the bone marrow. It began to look as though gliotoxin would also be useful in bone marrow transplantation in people, if human cells behave in the same way.

In 1987 we decided to study the mechanism by which gliotoxin modifies the function of immune cells such as macrophages and T cells. T cells are an important set of immune cells. They include cytotoxic cells that can kill other cells in the body, such as tumour cells, or those infected with a virus. We made isomers of gliotoxin-like molecules and examined how they behaved towards cells of the immune system. Isomers are compounds that have similar structures but differ in the conformation or configuration of groups in the molecule. The use of isomers or analogues can be a powerful technique in understanding what features of the molecule are important in its biological activity.

It seems that gliotoxin may work by binding to the receptors on the cell surface and inhibiting their normal function. This

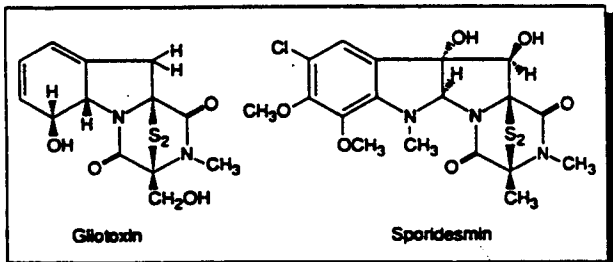

*Gliotoxin and sporidesmin are fungal toxins with similar chemical structures. But gliotoxin has unexpected benefits*

*Gliotoxin triggers "cell suicide" (below). The mechanism of this process could give us clues for designing anticancer drugs that will kill selected tumour cells in a similar way*



P. Waring / A. Müllbacher

may include recognising foreign particles and releasing lymphokines, which would also explain how gliotoxin prevents macrophages from engulfing foreign particles—and from sticking to culture dishes.

Although poisonous, gliotoxin could also act as a model for drugs to treat cancer. It triggers "cell suicide" among cells of the immune system, a process called "apoptosis", after a Greek word that describes how leaves fall from a tree. This happens naturally, as a form of programmed cell death in a growing fetus, for example. Tumour cells also undergo apoptosis naturally and if we had more information on what controls this form of cell death we may be able to enhance the process.

Normally, the first thing that happens to a dying cell is

that its cell membrane breaks down, often as a result of attack by toxins. In apoptosis, one of the first signs is the fragmentation of the cell's DNA. Activation of the nuclease enzyme that brings about this breakup is the key to the whole process. Some researchers, for example John Kerr and his colleagues at the University of Queensland, think apoptosis is a way of getting rid of "rogue" cells whose DNA has changed in some way so that they multiply uncontrollably, as in cancer.

Gliotoxin is one of several poisonous compounds that brings about apoptosis in cells. In 1988, for example, Sten Orrenius and David McConkey at the Karolinska Institute in Sweden reported that the environmental poison dioxin can also set off apoptosis in immature cells in the thymus gland. We do not yet know if there is a common mechanism to toxin-induced apoptosis, but in the same year we found that gliotoxin can cause breaks in single-strand DNA in test tubes—which suggests that this may happen in living cells. We also found that this damage to DNA can be caused by the generation of very reactive molecules called free radicals. The nuclease then activates destruction of the damaged DNA before any changes can be passed to its daughter cells. If we could find out how these events are linked, we could perhaps understand how other drugs such as bleomycin—used to treat certain tumours—cause apoptotic cell death.

Gliotoxin is only one of many compounds produced by fungi as a form of chemical warfare. Ultimately, it may aid organ transplants, as well as help us discover more about treating cancer. In the search for new drugs, who knows what else fungi have in store? □

Paul Waring and Arno Müllbacher are researchers in the John Curtin School of Medical Research at The Australian National University

## Ant antibody fights fungal infections in humans

**B**IOLGISTS in Australia have discovered that ants produce antibiotics to control diseases in their colonies. Trials in a Sydney hospital have already shown that these antibiotics are effective against a wide range of organisms, especially fungi, that cause diseases in humans. In particular, they kill the fungus *Candida albicans*, which is common in humans and causes "thrush", an infection of the mucous membranes.

Andrew Beattie of Macquarie University in Sydney studied more than a dozen species of ant. He was interested in discovering why it is that ants play almost no part in pollinating flowers, while bees and wasps, their close relatives, do such an important job. Beattie found that pollen dies when it touches an ant's body. In every species he studied, it was secretions from metapleural glands, at the rear of the ant's thorax, that killed the pollen.

Beattie found that the secretion is an antibiotic, called metapleurin, which the ants use to prevent the fungi and bacteria from growing in their bodies. The substance is a lipid molecule, which is quite different

### Stephen Hedges

from other antibiotics. Apart from protecting the ants, metapleurin has the side effect of making pollen less viable and able to germinate, so it dies.

One exceptional species of ant, which lacks metapleural glands, turns out to be an important pollinator. Beattie's collaborator, Rod Peakall of the University of Western Australia, has found that the winged male ant of this species, *Myrmecia urens*, pollinates a common orchid of southern Australia. *M. urens* pollinates up to half of the orchid's flowers.

When Beattie realised that the secretions of the metapleural glands had antibiotic properties, he took them to chemists to be analysed. He also asked medical colleagues at Westmead Hospital in Sydney to test how effective they were against bacteria that cause disease.

The hospital's initial screening tests against more than 300 of these bacteria have produced both good and bad results. Unfortunately, most of the bacteria are

unaffected by the antibiotics. The good news is that metapleurin is highly effective against several strains of a common bacterium, *Staphylococcus aureus*, that are resistant to other antibiotics. These bacteria can be a major problem, sometimes preventing wounds from healing for many months after surgery.

Since the initial trials of the antibiotic, Beattie has talked with a major pharmaceuticals company in Britain. The company's main interest lies in the antifungal properties of metapleurin, because there are currently very few effective drugs to treat internal fungal infections, which can be fatal. The company challenged Beattie to show that ant antibiotics stop human fungal infections. The results of tests at Westmead Hospital are just emerging.

Two weeks ago, Beattie heard the news that a component of metapleurin had proved highly effective against *C. albicans*. Metapleurin also worked for the treatment of infections of the skin and internal tissues. Tests against other fungal organisms are under way. □

# New policy downplays risks of gene technology

By Phillip J. Hiltz  
The New York Times 2-25-92

WASHINGTON — The White House on Monday issued a new government policy on biotechnology, saying genetically engineered products are not inherently dangerous and should not get too much scrutiny from federal regulators.

The new policy, crafted by Vice President Dan Quayle's Council on Competitiveness, is intended to spur the biotechnology industry.

It would put the stamp of policy on practices that have been evolving in the federal agencies for years, assuring that fewer and fewer biotechnology products need special approval to release new organisms in the world.

And, in effect, it would shift the burden of proof away from the industry and onto federal agencies, which would have to prove a new, genetically engineered product poses an environmental or health risk before asserting its oversight authority.

"This \$4 billion (biotechnology) industry should grow to \$50 billion by the end of the decade — if we let it," President Bush said in announcing the policy. "The United States leads the world in biotechnology, and I intend to keep it that way."

But while the new policy puts an official end to the federal debate on whether biotechnology products need special oversight, the debate persists outside the government.

Critics have worried about the dangers of introducing novel organisms into the environment, arguing that some might run riot if unrestrained by natural enemies.

The key difference between biotechnology products and others is that engineered organisms are not merely put into the environment; they become permanent, growing parts of it.

"It's a little different from allowing chemicals to escape," said D. Douglas Hopkins, a senior lawyer with the Environmental Defense Fund. "Organisms reproduce."

Defenders of the policy have countered that adding a few genes of known purpose is unlikely to

# Biotechnology industry has White House support

The New York Times 2-25-92

WASHINGTON — The White House yesterday issued a new government policy on biotechnology products, saying that genetically engineered products are not inherently dangerous and should not get too much scrutiny from regulators.

The new statement is intended to spur the biotechnology industry and keep federal regulators from singling out these products for extra regulatory procedures.

It would put the stamp of policy on practices that have been evolving in the federal agencies for years, assuring that fewer and fewer biotechnology products need special approval to release new organisms in the world.

Federal regulations that govern genetically engineered pesticides and other toxic chemicals are being written, but have been stalled, at least partly because the overarching policy statement issued yesterday was not final.

It contains few specifics but will serve as guidance to regulatory agencies and the basis for the Vice President's Council on Competitiveness to intercede if regulations of biotechnology companies get

change a familiar species into an Andromeda strain.

The administration's view is that companies will be responsible in releasing organisms, and that elaborate regulation might not catch potential hazards in any case and would therefore amount to unnecessary curbs on an industry that has a positive balance of trade.

Jeffrey Nesbit, a spokesman for the vice president's council, said the intention was to streamline the regulatory process and eventually provide a "road map" directing biotech firms toward the right regulatory agency.

But Hopkins of the Environmental Defense Fund said, "That rings hollow to us because we see parallels between this technology and other powerful technologies which had repercussions on the environment, such as the chemical and nuclear power industries."

The new policy covers all uses of genetically altered organisms or products, from crops to medicines.

In the past, it has taken many years — up to five or six in some cases — to pass these products through the unmarked and often shifting regulatory minefield.

Among the genetically engineered products now coming along is a tomato plant with a special

too "burdensome to business," in the language of White House staff.

The new policy covers all uses of genetically altered organisms or products, from crops to medicines. In the past it has taken many years — up to five or six in some cases — to pass these products from the first notification of the government to their final approval.

Even after some years of trying to make the process quicker, the average time remains more than three years.

Among the genetically engineered products now coming along is a tomato plant with a special gene inserted; the gene destroys one of the enzymes that makes the plant ripen, so that although tomatoes can be matured on the vine, they will not soften and shrivel until long after they are shipped to stores.

Despite the promise of such products, critics have worried about the dangers of introducing novel organisms into the environment, arguing that some might run riot if unrestrained by natural enemies. Defenders of the policy have countered that adding a few genes of known purpose is unlikely to change a familiar species into an Andromeda strain.

gene inserted. The gene destroys one of the enzymes that makes the plant ripen, so that although tomatoes can be matured on the vine, they will not soften and shrivel until long after they are shipped to stores.

Another promising product is a cotton plant that is equipped with its own natural pesticide by inserting a bacterial gene that makes a product toxic to insects.

Officials of the Environmental Protection Agency who asked to remain unidentified said the new policy was better than previous drafts, which threatened to cancel current law governing biotechnology products.

(The Associated Press contributed to this report.)



# Prescribing all the way to the bank

Hard science and high capitalism meet in the pharmaceuticals industry—creating a heady mix of high-powered research, sophisticated sales techniques, creative accountancy and takeover deals

Peter Marsh

**H**EALERS or bandits? Observers often seem unable to decide which of these descriptions fits the international pharmaceuticals industry. The sector spends prodigious sums of money unravelling highly complex aspects of chemistry and biology in the cause of making people healthier. Its products have undoubtedly played a big part over the past half century in increasing the life expectancy of the average person, in the developed world at least. Yet at the same time a question mark remains in many people's minds regarding the activities of the international drugs companies, the biggest of which include Merck in the US, Britain's Glaxo, Hoechst in West Germany and Switzerland's Ciba-Geigy. These firms fight over the world drugs market totalling some £70 billion a year, most of which is accounted for by sales in Western Europe, North America and Japan.

In the battle for the top places in the industry, hard science plays an important part. So do razor-sharp accounting practices, sophisticated selling techniques and much corporate wheeler-dealing. The corporate manoeuvring involves multi-billion-dollar takeover battles and countless small and sometimes temporary liaisons between the leading pharmaceutical players that sometimes end in tears. It is not surprising that the public image of the drugs business emphasises not so much the toiling white-coated scientist as the ultra-slick salesman extolling the virtues of the latest "Whizzo Drug".

The notion held by many that drug companies are somehow cashing in on people's illnesses is reinforced by the large profits that many of the leaders in the industry make. Glaxo, Britain's biggest drugs company, with its annual sales of about £2.5 billion, is a good example. In recent years it has been churning out pretax profits totalling about 40 per cent of annual sales—far above the rate for most other industrial groups in areas such as engineering and electronics. The drugs groups themselves often add to the climate of suspicion by revealing few of their activities to the public, partly because of a fear of giving away secrets to rivals.

The commonly held views about the industry strike many inside it as unfair. They point out that the sector is—particularly in the US and much of Western Europe—a highly successful business and a strong export earner. It has an especially good record in West Germany, Switzerland and Britain in turning scientific ideas into useful products. In Britain the drugs sector, with annual sales of about £4 billion and a balance of payments surplus of £800 million, is one of the country's few strong science-based businesses. And pharmaceuticals is one science and technology based industry where the West has had a much stronger record, so far at least, than Japan. Of the world's top 11 drugs firms, only one, Takeda, is Japanese (see Table).

The drugs companies are directly concerned with something of burning interest to almost every individual—safeguarding and improving human health—and this is emphasised in how they present themselves publicly. As well as this, a strong strand of public responsibility runs through many of the scientists and managers in the industry. The drive to shed light on health problems can also be seen in the sector's spending on research and development (R&D). Pharmaceuticals companies commonly spend between 10 and 15 per cent of their annual sales on R&D, far more than the average in other so-called high-tech industries such as telecommunications and electronics. In many countries, the drugs sector is among the biggest civilian employers of scientists and technicians.

This can be seen especially in the case of Britain, whose pharmaceuticals industry employs 15 000 R&D workers. The British drugs sector's sales account for only about 2 per cent of Britain's gross domestic product. In R&D terms, however, the sector is far more important: it spends £700 million a year, nearly a tenth of Britain's total R&D expenditure counting both government and industry programmes.

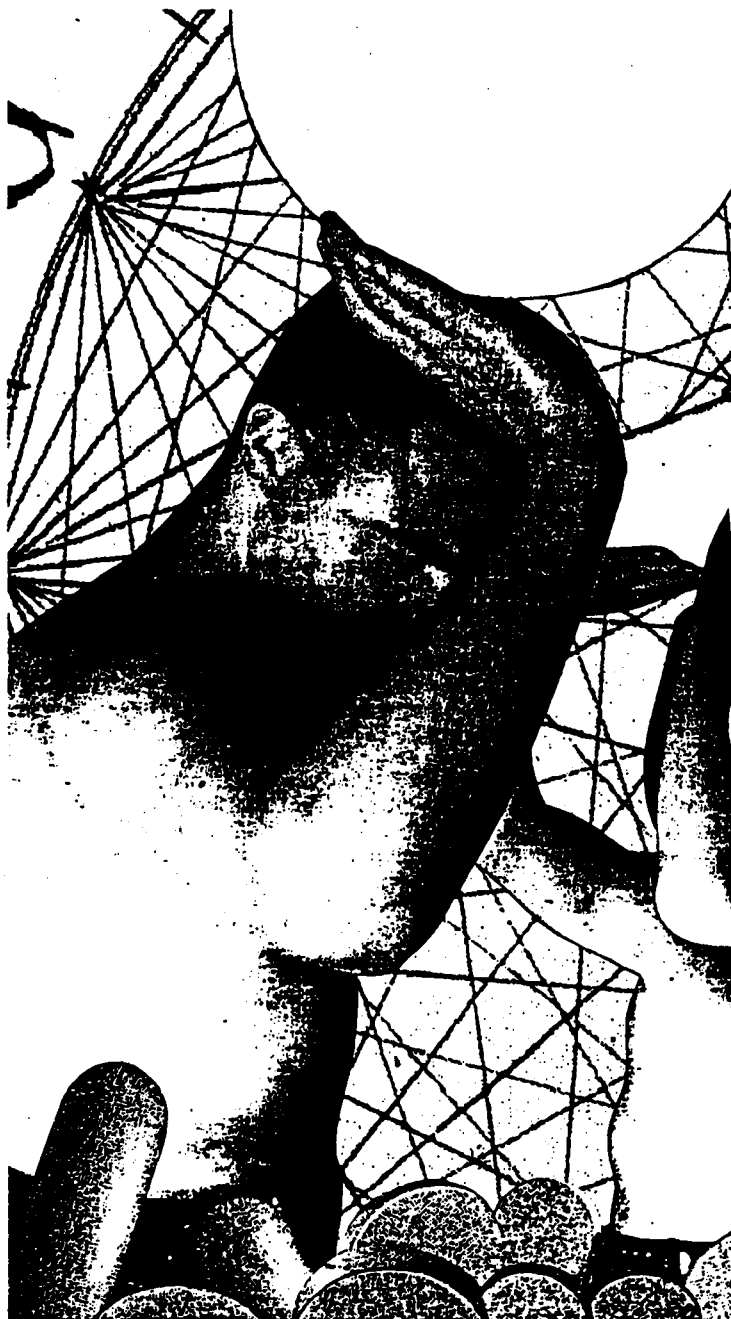

Throughout the world drugs business, there is some pride in the purely scientific achievements of the past 30 years. Examples include heart drugs such as beta blockers, which permit patients to "manage" cardiovascular disease with minimal disruption to their lives. Another is the anti-AIDS formulation Retrovir, made by the British drug company Wellcome and without which the lot of the average AIDS sufferer would be even more depressing than it is now. Many within the industry cannot understand the opposition that its sector tends to stir up among outsiders. "We get criticised by just about everyone," says one British drugs company executive. "No one seems to understand how difficult life would be without us."

In the drugs industry, though, social concern is only part of the story. The sector is highly competitive, obsessed by the fact that the biggest company—Merck of the US—has just 4 per cent of total world sales. In other sectors such as branches of

electronics and engineering the dominant firm might expect to have a market share twice as high. That puts a lot of pressure on the top 100 or so drugs companies, which between them have about 80 per cent of world pharmaceuticals sales, to scrap for just a few percentage points of extra market share in the line-up behind Merck.

This is one reason for the industry's highly sophisticated—some say ruthless—marketing techniques and the relentless drive to increase turnover and profits. One manifestation of this push has been the rash of mergers in recent months, mainly involving American companies that see joining up with rivals as the most promising way to close the gap with Merck. Another goal is to provide what they see as the economies of scale in both research and marketing which are required for the increasingly tough business battles of the 1990s. The most prominent of these mergers have been the teaming up of the US's SmithKline Beckman with Beecham of Britain and

the link between Squibb and Bristol-Myers, both of the US. The last of these deals created a giant group with sales of \$8.6 billion and a stock market value of \$25 billion.

The heated nature of the business climate in which drugs companies operate is underlined by their importance to world stock markets. In the US, Britain and Japan, the shares of the leading pharmaceuticals groups are among the most actively traded of all stocks. Their stock value is extremely high. Merck, for example, is worth roughly the same on the New York financial market as IBM, a company much bigger in terms of sales. The reason for this financial interest is that investors have seen they can make small fortunes by backing a company before it develops a winning drug, and then cashing in afterwards. Shares in Glaxo, which has leapt to prominence in the 1980s through sales of its smash-hit ulcer drug Zantac, are worth a staggering 12 times their value 10 years ago, even allowing for the effects of inflation.

Zantac is now the world's best-selling medicine, scooping more than £1 billion a year in revenues. And anyone who bought shares in Wellcome when the company was floated on the British stock market three years ago is sitting pretty. In that time the shares have appreciated by a factor of five, mainly thanks to the good prospects for Retrovir.

For every story of investors retiring to the Bahamas on the strength of drugs stocks, however, there are many more recounting the ▶

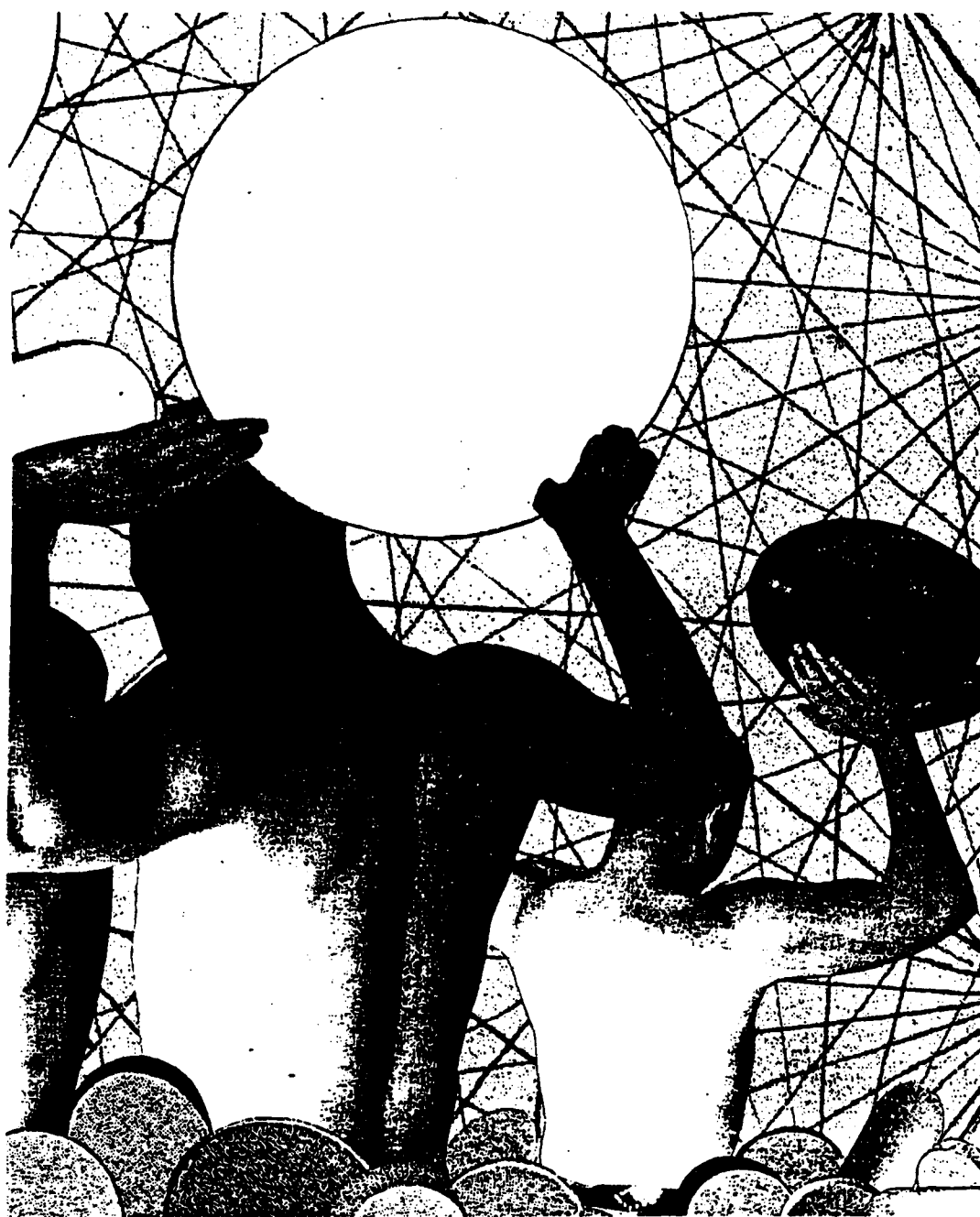

► pressures suffered by people in drugs companies as a result of the financial world's fierce interest in their activities. In London, Tokyo and New York, stockbrokers and banks employ armies of analysts to pore over every utterance and research report emanating from the big drugs companies. The sharp rises and falls in investors' confidence caused by real or imaginary "blockbusters" sliding in and out of the field of view of the financial analysts can add to the pressures on drugs company executives.

Competitive and financial forces are not the only issues to be bothering the drugs industry. Other factors which cause people in the business a great deal of worry—and can affect the way the industry is viewed by the outside world—include governments, ethics and the way the companies run their R&D. In many developed countries (especially in Europe) the state foots the bill either directly or indirectly for the lion's share of pharmaceutical spending. They are thus highly important customers for drug firms. Secondly, government bodies are vitally involved in testing new formulations for safety. The result is that the drugs industry can easily be hit by cost-cutting drives by its main state-owned customers; it is also hemmed in by the safety regulations.

Over the past 10 years the safety rules have become more onerous, driven by the public scares over "rogue" drugs such as thalidomide or Opren. That has pushed up R&D costs; only about a quarter of the drug industry's R&D bill is accounted for by pure research, with the rest covering the development needed to drive new products through the regulations. It has also lengthened the time it takes to get a new formulation on sale. While in the 1960s government approval for a new drug might take just a few years the figure is now nearer 12 years.

This link with government departments can cramp a company's entrepreneurial style. Some pharmaceuticals researchers complain about the mountains of scientific data which they have to submit to regulatory authorities before new products can go on sale. The connections, however, can also work in a company's interests. This applies to the interactions between a medicines company and the state health agencies which are key purchasers of its products. In some countries—France is a good example—a pharmaceuticals company can expect favours from the government on pricing issues if it proves itself a "good citizen". Thus if the company agrees to invest in a new factory or a research establishment, so providing jobs, it may be allowed to charge more for its latest product. Such negotiations, in Western Europe at least, are often highly confidential. There is some hope, however, that some of these deals may be opened out to greater public scrutiny. That could result from new rules that the European Commission is drawing up to govern drug prices throughout the European Community in the run-up to the planned abolition of trade restrictions after 1992.

### The ethics of marketing

The drugs industry is known for its highly creative sales and marketing techniques generally aimed at doctors. Some 80 per cent of the industry's sales come from prescriptions while the rest comes from products bought directly over-the-counter. The big companies employ a range of devices to win over the doctors. They use computers to draw up lists of "innovatory" doctors who stand a good chance of being persuaded to prescribe specific new formulations, which command a high price and good profit margins. The sales force also tries to home in on "opinion leaders" in the medical community.

In Britain, the companies place a special emphasis on winning the trust of hard-pressed general practitioners. These doctors, with only patients to talk to for most of the day, often find themselves isolated from scientifically literate people. So by engaging in scientific chit-chat and swapping technical literature the drug rep can win the doctor's trust. That may lead to more prescriptions for the company. This effort at cementing ties with doctors is highly expensive. To cover the whole of Europe or the US, a big drugs company might need to

employ between 1000 and 2000 sales people or "detail men" who spend all their time talking to doctors or other medical people. One result is that sometimes the sales pressures smack of what might delicately be called over-exhortation.

Cases in point are the stories of pharmaceuticals firms inviting doctors to elaborate, all-expenses-paid "sales conferences" to receive plugs for the latest wonder drugs. The drugs industry also hands out a range of free gifts—anything from note pads to computers—to physicians as part of the drive to build up a good relationship.

Such links between sales rep and customer are common enough in many other industries. However, when it comes to health care, high-pressure sales techniques and free gifts have led to some sweeping criticisms of the industry. "The drugs business is like a jungle," says one prominent opponent of the sector. In the wake of this kind of comment, in some countries, Britain included, trade associations acting for the drug sector have drawn up codes of practice designed to curb the enthusiasms of the more imaginative reps. Every now and again, however, excesses are brought to light.

### R&D management

The new drugs which come on to the market emerge after up to 10 years of carefully planned development. Their gestation is in many ways as complex as big technology projects such as space shuttles or nuclear power stations. The programme for a typical new drug starts with pure research where a scientist might try a new approach to altering the mechanisms connected with, say, heart disease. After toxicity and animal tests, it ends with massive trials on possibly tens of thousands of patients to work out the details of the drug's effectiveness. Only after this will a relevant national health authority, such as the Food and Drug Administration in the US or the Department of Health in Britain, license the companies to sell the drugs.

There are some favourable trends in R&D. New techniques in areas such as biotechnology and computer modelling of protein structures should help the industry to find the mechanisms behind important illnesses such as cancer and brain disorders. From this should follow, in theory, new money-spinning products. The downside, however, is the increasing cost of development, mainly due to the lengthier and more complex tests that governments require. The result is that drugs companies are having to run faster to stand still. American pharmaceuticals companies now spend some \$5 billion a year on R&D, four times as much as a decade ago, but the rate of introduction of new products has remained constant. In the past few years, many big pharmaceuticals firms are spending as much as between 10 and 20 per cent more on R&D a year—at a time when overall sales are growing by no more than 5 per cent a year in many countries.

The pace at which drugs companies pour resources into R&D is a source of fascination, and worry, both inside and outside the industry. Merck, for instance, spends \$700 million a year on research and development and is a legend for the way in which it has been able to translate this into dozens of high-selling products. The company is unusual in the pharmaceuticals world for having as its chairman a scientist—Roy

### The world's largest drug companies

Company	Drug sales (\$bn)
Merck (US)	5.02
Bristol Myers/Squibb (US)	3.78
Glaxo (UK)	3.62
SmithKline Beecham (UK)	3.61
Ciba-Geigy (Switzerland)	2.91
Hoechst* (West Germany)	2.80
Takeda* (Japan)	2.43
American Home (US)	2.35
Pfizer* (US)	2.33
Sandoz* (Switzerland)	2.31
Eli Lilly* (US)	2.27

\* 1987 Revenues. Source Financial Times

Vagelos—rather than the usual marketing man or accountant. Many, however, doubt that all the other top-flight pharmaceuticals companies can match Merck's rate of innovation. "They can't all carry on spending this amount of money on research," says one drugs industry observer. "Something is going to have to give." Doubts, for instance, have been expressed about Glaxo's scheme to build a £500 million research centre in Stevenage, Hertfordshire, to act as a new focus for its R&D efforts. The centre, due to be finished by the mid-1990s, may have to be scaled back, according to some in the industry.

Apart from more mergers, in which rival groups assemble their research programmes with a certain amount of cost cutting, the answer to the rising research bills may well be more finely honed management techniques within R&D. A related problem with R&D is that few can agree on just how innovative the drugs industry really is. Those inside the business point to breakthroughs such as Zantac, which has revolutionised the treatment of ulcers, and heart drugs such as Merck's Vasotec, which has made the lives of people suffering from cardiovascular disease far more bearable.

Critics, however, maintain that the genuine leaps are relatively rare. Many of the 50 or so new drugs which appear on sale each year are, according to this view, "me-too" products, slightly improved versions of other medicines that a rival in the business has already produced. Some backing for this view comes in a recent report from *Scrip*, a specialist newsletter for the pharmaceuticals business, which says that of the 53 new medicines introduced worldwide in 1988, only four can be regarded as "breakthrough products" in the sense of benefiting patients with hitherto untreatable diseases.

More ammunition for the critics came in recent findings from a US Senate inquiry. This said that of the 348 new drugs introduced by big American manufacturers between 1981 and 1988, 292 made "little or no" contribution to existing drug therapies. Only 12 were rated as showing an important therapeutic gain. This hardly inspires confidence in the innovative qualities of the industry as a whole. The me-too products may also, so this argument goes, clog up regulatory agencies, cutting the time given to testing of more important drugs. Such attitudes are rejected by people within the industry. "People talk about copy-cat products," says one person close to the drugs business. "But what they don't realise is that they might improve, even by an incremental amount, on what has gone before. Also don't forget that every

patient who uses a drug is different. Even though there are dozens of heart drugs on the market, what works for one person may be totally unsuitable for another. It is only by having lots of 'me-too' products that a doctor can experiment to find out what is best for his patient."

When bracketed with drugs companies, finance can provoke either disquiet on the part of the industry's critics or subdued admiration from accountants. The companies are adept at presenting profitability in the right light. In many countries, the image of a drugs company may be harmed if it looks as though it has been making too much money. Some AIDS activists, for example, have criticised the Wellcome's subsidiary in the US for charging some \$8000 for a year's supply of Retrovir. And in some countries—Britain is the best example—the prices that companies are allowed to charge are directly linked to profits. Here again it may suit a company to minimise the profit which it shows in its accounts.

### Financial engineering

The industry can also manipulate the profits which it shows in specific countries. It can do this both as a result of a structure of the business and because of the way medicines are made. Many of the biggest drugs groups are part of large multinational chemical companies. Ciba-Geigy and Sandoz of Switzerland, ICI of Britain, Bayer and Hoechst of Germany, the US's Merrell Dow and France's Rhône-Poulenc all fit into this category. Many of the chemicals needed to make a drug are quite cheap apart from a few key substances which are at the centre of the production chain. These substances, called intermediates, are commonly manufactured by subsidiaries of the same company that sells the finished drug. A drugs company looking to depress its profit in one country can arrange to buy its intermediate from a subsidiary in another country at particularly high prices.

Patent law is among the most contentious subjects within the industry. More than virtually every other kind of science-based product, drugs depend on strong patent protection if they are to produce large sales for their makers. A producer can claim a patent on the basis of the drug's chemical formula. The problem is that patents normally last for about 20 years. As it generally takes 10 to 12 years to push a drug through the R&D programme, many products have only 8 to 10 years of patent protection after the formulation goes on sale. The company then has to fight to make a profit before the patent runs out and competitors can copy it.

This is a major reason for the relentless efforts put into boosting revenues in the first few years after a medicine is put on the market. "In pharmaceuticals, much more so than in other industries, it's no good waiting a few years to get your earnings from a new product", explains a former chief executive at a leading drugs company. "By then it will be too late because your competitors will be ready to move in." This is why drugs company chiefs around the world spend so much time attempting to persuade legislators to give them a better deal over patents.

A favourite idea is to change the patent laws with respect to drugs so that a new drug is protected for a set period—say 16 years—after the date it is first sold rather than from the time of the patent's issue. The industry has won some relief in the US, where a patent's term can be extended if a new drug has taken a particularly long time to develop. Companies now want to see similar measures enacted within the European Community. "It is the one issue that unites us all," says one European executive. In return some in the industry argue, it might be less secretive, less feverish in sales and marketing and possibly spend more of its research cash on the genuine breakthroughs rather than the me-too products. Whether such a state of affairs comes about will be one of the more interesting industrial policy questions of the 1990s. □



Andrzej Klimowski

Peter Marsh is a journalist on the *Financial Times*.

## Data Tap

### Patients' Records Are Treasure Trove For Budding Industry

#### Doctors' and Pharmacies' Files Are Gathered and Mined For Use by Drug Makers

— 2-27-92

#### Firms Say Names Are Deleted

By MICHAEL W. MILLER

Staff Reporter of THE WALL STREET JOURNAL

Michael Patmas, a Toms River, N.J., internist, says he would never disclose confidential information about his patients. Yet indirectly, he does it routinely.

In his office, Dr. Patmas keeps an IBM personal computer in which he stores all his patients' records: information about their illnesses and treatment. Unknown to the patients, every week or two a company dials into the PC and fishes out all those confidential records. With plans to reach 15,000 physicians within the next four years, the company, Physician Computer Network Inc., thinks its swelling data base of patient records could become a commercial treasure.

Dr. Patmas and PCN are part of an exploding but invisible new traffic in patients' private medical and prescription records. Physicians and pharmacists routinely open up their patient records to data-collectors that sell them to pharmaceutical companies hungry to know exactly how their products are selling. In all, nearly half the 1.6 billion prescriptions filled each year in the U.S. pass along this chain.

#### Naming No Names

Physicians and pharmacists say the disclosures don't threaten privacy, because the data-collectors all insist they delete patients' names. But critics of these practices say the custodians of medical records have no business entrusting them, without patients' knowledge or consent, to an unregulated industry. And they worry that the collectors' safeguards may not be adequate.

In fact, certain data-collectors that pledge total confidentiality sell drug companies the age, sex—and an ID number—for individual patients.

Fears about the sale of medical records are causing some physicians and pharmacists to resist the collectors' surveillance efforts. Others are pushing for legislation, noting that privacy law covers videotape rentals and cable-TV selections, but not most medical records.

In the absence of laws, patient confidentiality is more porous than ever before. Oklahoma, since last year, requires pharmacies to report all prescriptions for a range of painkillers and other controlled drugs to the state Bureau of Narcotics. In hospitals in Michigan and New York, computer hackers have broken into electronic patient records. Companies bent on cutting medical expenses are reviewing their employees' medical records more closely than ever.

#### Delicate Situations

Such trends particularly alarm patients with AIDS, mental illness and other conditions in which a breach of privacy can have far-reaching consequences. "It worries the hell out of me," says Frank Burgmann, a director of Florida's mental-health services agency, who has tried unsuccessfully to keep pharmacies from selling their prescription files. "Data is like a whore. It gets passed around from hand to hand, in spite of the rules."

Last month, an Ohio jury found that a hospital employee didn't violate any law when she allegedly discovered a friend's AIDS diagnosis in the hospital computer and shared the news with other hospital workers. Douglas A. Sargent, a Detroit psychiatrist and lawyer, tells of a clinically depressed patient who he says was fired after his employer learned of his condition from an insurance company.

There aren't any reports of patients' names leaking through the commercial use of their records in market research, which is a new phenomenon. Specialists in privacy issues say, however, that most violations of medical confidentiality never come to the attention of patients. And patients who do become aware may be loath to make matters worse by publicizing the breach.

#### What Really Interests Clients

Dr. Patmas, the New Jersey internist, says he wasn't worried about confidentiality when he agreed to let Physician Computer Network search his patient records; the company assured him its software had safeguards to keep it from capturing patients' names. Besides, he says, speaking hypothetically of a pharmaceutical company: "Merck doesn't care if Mary Jones has herpes—they want to know if I prefer Lasix or Bumex."

Dr. Patmas also had a potent incentive to sign up with PCN. The Laurence Harbor, N.J., company offered to lease him a top-of-the-line personal computer and software for about one-third what these would otherwise cost. In three years, this offer has drawn more than 1,600 physicians to PCN, the first company to gather market data by tapping directly into physicians' computers.

Another physician on the network, Dominic Mazzocchi of Point Pleasant, N.J., notes that insurance companies already see his patients' records. He does have one lingering worry. "The only thing that would be a concern," he says, "is if [PCN] took my financial information. But they swear they haven't."

The medical-data network reaches deeper into the nation's pharmacies; it in-

cludes about 29,000, or roughly half of all drugstores.

Joseph Mosso, a Latrobe, Pa., pharmacist, two years ago agreed to let his drug wholesaler scoop up his computerized prescription files once a week over telephone lines. In return, the wholesaler, FoxMeyer Corp., sends him weekly price updates at a discounted fee.

With similar hookups to more than 1,000 other pharmacies, FoxMeyer sells all the records it gathers to the two main medical-data-collectors: IMS International and Walsh International Inc., a private British firm.

FoxMeyer's president, Robert King, says his computer extracts only product information, not patients' names. But Mr. Mosso, the pharmacist, says, "I can't tell you whether they do or not [take patient names]—I have no way of knowing. . . . It's more or less a mouth-to-mouth agreement that they will not search those files."

#### Appreciating the Promise

The companies that amass all this information have become favorites of Wall Street and corporate investors, although total revenue in the new industry is only about \$150 million a year.

Information giant Dun & Bradstreet Corp. bought IMS in 1988 and created an electronic network that now sweeps in more than 700 million prescriptions a year. Today IMS's ratings of drug sales powerfully influence how drug companies market to physicians.

Medco Containment Services Inc., the nation's biggest mail-order prescription operation, last year created a subsidiary to sell its customers' prescription records, in addition to prescription data it buys from the American Association of Retired Persons. Medco sorts everything by the names of physicians and gives their addresses.

Drug companies love that extra feature because they can zero in on physicians most likely to go for their mailings. Wall Street loves it, too: Medical Marketing Group went public last March at \$12.50 a share and shot up to \$20.50 on its first day. Its shares closed yesterday at \$29.75 in over-the-counter trading, a huge 78 times estimated per-share earnings.

Investors are also hot on another new venture that uses prescription records to go after physicians: a Walsh spinoff called Pharmaceutical Marketing Services Inc. It went public in December at \$14 a share and, despite three straight years of losses, its stock has climbed, closing yesterday at \$19.25.

Physicians Computer Network has an especially impressive list of investors. Among them: International Business Machines Corp., which owns a 23% stake. Another holder (with a 4.7% stake) is Macmillan Inc., part of the Maxwell electronic-information conglomerate.

The companies all speak emphatically about patient privacy. Walsh exercises "an enormous amount of sensitivity and responsibility" to maintain privacy, says its president, Dennis Turner. Medical Marketing Group's executive vice president, Theodore Okon, calls patients' names "a sacred area we won't touch." IMS, like other companies, says drug-company clients want to

know how their products are selling, not who is buying them.

#### Hands Off

Patient-privacy advocates contend the industry should never get its hands on medical records in the first place. "Regardless of how the pharmacist or physician feels about the safeguards, it's not their call. The patient is the only one who has the right to release this information to anyone," asserts Michael Isbell, staff attorney in New York for the Lambda Legal Defense and Education Fund, a lesbian and gay rights group.

The AIDS epidemic has made such organizations acutely aware of the consequences of breaching physician-patient confidentiality. "People lose their friends, lose their jobs, get kicked out of their apartments," Mr. Isbell says.

The medical-data business may risk running afoul of state AIDS confidentiality laws, one of the few areas in which medical privacy is strictly protected. New York, for instance, specifically limits legal access to AIDS-related records. If a physician or pharmacist should give a market researcher records pertaining to AIDS, "it's a good possibility" that this would violate the law, says Andrew Stern, deputy director of the New York state health department's special investigations unit.

Industry pledges of confidentiality have shades of gray. A McKesson Corp. unit called PCS looks at 120 million prescriptions a year, to process payments for companies that give their employees a PCS insurance card to present at pharmacies. (Dow Jones & Co., publisher of this newspaper, is one such employer.) Few of those employees know that PCS sells its entire data base to Walsh International. "Patient confidentiality is totally ensured," a PCS spokesman says.

In fact, though PCS deletes patients' names, it includes their age, sex and Social Security number, as well as their physicians' federal ID numbers.

Walsh drops the Social Security number and replaces it with a code number of its own. That way, it says, the drug-company client can track an individual's prescription buying but won't know the patient's name.

The medical-data collectors sweep up so much information that some physicians and pharmacists don't know exactly how open to view their files are.

Joseph Staller, pharmacist at the Red Oak Pharmacy in Houston, says he is opposed to selling his records to market researchers. "You want everyone to know what your wife's taking?" he asks. "Not that they'd even look for that, but there's potential for abuse."

But Mr. Staller keeps all his records in a personal computer connected by phone-line to his software supplier, Pharmacy Data Systems Inc. of San Antonio, Texas. For the past year, Pharmacy Data has been testing a program it plans to begin in March: to dial into its 200 customers' PCs every week, copy their prescription records and sell them to IMS and Walsh.

Mr. Staller, told of the software company's plan, says he is flabbergasted. "I

had no idea." Pharmacy Data says it plans to notify pharmacists before it takes their data, and it won't collect patient names.

Some who do understand the collectors' technology are rebelling against it. Carl Chalstrom, a pharmacist in Anamosa, Iowa, bought new software for his drug-store PC last month and was surprised to read about a special feature called "IMS Data Program." Slip in a diskette, and it makes a copy of all the prescription files. Mr. Chalstrom says IMS International offered him about \$50 a month to run the program and send it the diskette.

The same kind of feature is built into a number of pharmacy software packages, and it sends IMS a gusher of data. Software makers say these programs preserve patient privacy because they don't copy any names onto IMS's diskette.

"We're damn careful that no one gets a patient name anywhere," says Ken Couch, director of national marketing for QS/1 Data Systems of Spartanburg, S.C., which has 4,300 pharmacy customers including Carl Chalstrom.

Mr. Chalstrom wasn't sold. "With access to computers so easily obtained, we were worried," he says. "You read so much about computer companies getting people's account histories and financial records." He turned down the money from IMS.

So did Kelly Hasty, owner of the Olde Towne Pharmacy in Williamsburg, Va. "I have no clue what they're pulling off my computer, and I don't trust what they're telling me," she says. "I'm not a computer expert. I have patients to protect and a business to protect."

But the data collectors are getting countless new sources, thanks to the growing chain of "third parties" who handle confidential patient records. For example, Health Information Technologies Inc. is one of a slew of new companies springing up to automate private physicians' insurance claims. The Princeton, N.J., company outfits 5,000 physicians with special "Health Link" terminals for entering their patients' billing information.

HIT not only takes care of the physicians' payments, but it also keeps electronic copies of all the patient records. Once its data base gets a little bigger, HIT intends to start selling it to drug marketers, insurance reviewers and other companies, says vice president Charles Rivevuto. He says the data won't include patients' or physicians' names.

Meanwhile, volcanic changes in the American health-care system are opening up a wide new market for medical data attached to patients' names.

Corporate cost-cutters examining their employees' medical expenses are paying less and less attention to privacy. A 1991 study by the Office of Technology Assessment, a congressional agency, concluded that three out of 10 employers allow managers to review employees' medical records without their permission.

At the same time, the war against drug abuse is pressing lawmakers to make pharmacy records even less private than they already are. Rep. Pete Stark (D., Ca-

lif.) is proposing a federal law based on the Oklahoma prescription reporting system. The American Civil Liberties Union is arguing that nationwide data bases listing users of controlled medications could easily be misused by employers and snoops.

And the drug companies that buy the collectors' data today are taking new steps to market directly to patients, breaking a long industry taboo. Marion Merrell Dow Inc., for instance, has amassed its own data base of 350,000 heart patients who take its drug Cardizem. It sends them all "CardiSense" newsletters about healthy living, and it is studying new ways to use the names.

All these trends unsettle patients like Robert Boorstin, a New York writer. He speaks openly about his own manic-depressive illness but worries about the privacy of other patients in a support group he runs.

"For someone with an illness like this you have a lot of people to trust," he says. "You have to trust doctors, you have to trust pharmacists, you have to trust your friends who might see you have an episode, your co-workers. . . Why add to the list?"



MATRIX III

No. 116. Deaths and Death Rates, by Selected Causes: 1970 to 1989

[Excludes deaths of nonresidents of the U.S., except as noted. Beginning 1979, deaths classified according to ninth revision of *International Classification of Diseases*; for earlier years, classified according to revision in use at that time. See also Appendix III and *Historical Statistics, Colonial Times to 1970*, series B 149-168]

CAUSE OF DEATH	DEATHS (1,000)					CRUDE DEATH RATE PER 100,000 POPULATION <sup>2</sup>				
	1970	1980	1985	1988	1989, <sup>1</sup> prel.	1970	1980	1985	1988	1989, <sup>1</sup> prel.
All causes	1,921.0	1,989.8	2,086.4	2,168.0	2,155.0	945.3	878.3	873.9	882.0	868.1
Major cardiovascular diseases	1,008.0	988.5	977.9	989.4	934.3	496.0	436.4	409.6	394.4	376.4
Diseases of heart	735.5	761.1	771.2	765.2	735.5	362.0	336.0	323.0	311.3	296.3
Percent of total	38.3	38.3	37.0	35.3	34.1	38.3	38.3	37.0	35.3	34.1
Rheumatic fever and rheumatic heart disease	14.9	7.8	6.6	6.4	6.0	7.3	3.5	2.8	2.6	2.4
Hypertensive heart disease <sup>3</sup>	15.0	24.8	23.7	23.2	23.2	7.4	10.9	9.9	9.5	9.4
Ischemic heart disease	666.7	565.8	536.8	509.6	497.9	328.1	249.7	224.8	207.3	200.6
Other diseases of endocardium	6.7	7.2	9.5	11.7	11.8	3.3	3.2	4.0	4.8	4.7
All other forms of heart disease	32.3	155.5	194.6	214.2	196.6	15.9	68.7	81.5	87.1	79.2
Hypertension <sup>3</sup>	8.3	7.8	7.8	8.5	8.5	4.1	3.5	3.2	3.4	3.4
Cerebrovascular diseases	207.2	170.2	153.1	150.5	147.5	101.9	75.1	64.1	61.2	59.4
Atherosclerosis	31.7	29.4	23.9	22.1	19.1	15.6	13.0	10.0	9.0	7.7
Other	25.3	20.0	22.0	23.2	23.6	12.5	8.8	9.2	9.4	9.6
Malignancies <sup>4</sup>	330.7	416.5	461.6	485.0	497.2	162.8	183.9	193.3	197.3	200.3
Percent of total	17.2	20.9	22.1	22.4	23.1	17.2	20.9	22.1	22.4	23.1
Of respiratory and intrathoracic organs	69.5	106.5	127.3	138.3	141.6	34.2	47.9	53.3	56.2	57.0
Of digestive organs and peritoneum	94.7	110.6	118.6	117.4	119.2	46.6	48.8	48.8	47.8	48.0
Of genital organs	41.2	46.4	49.7	53.4	53.6	20.3	20.5	20.8	21.7	21.6
Of breast	29.9	35.9	40.4	42.5	43.7	14.7	15.8	16.9	17.3	17.6
Of urinary organs	15.5	17.8	18.9	19.5	20.1	7.6	7.9	7.9	7.9	8.1
Leukemia	14.5	16.5	17.3	17.6	18.9	7.1	7.3	7.3	7.2	7.6
Accidents and adverse effects	114.6	105.7	93.5	97.1	94.8	56.4	46.7	39.1	39.5	38.2
Motor vehicle	54.6	53.2	45.9	49.1	48.8	26.9	23.5	19.2	20.0	19.7
All other	60.0	52.5	47.6	48.0	46.0	29.5	23.3	19.9	19.5	18.5
Chronic obstructive pulmonary diseases and allied conditions	30.9	56.1	74.7	82.9	84.4	15.2	24.7	31.3	33.7	34.0
Bronchitis, chronic and unspecified	5.8	3.7	3.6	3.7	3.7	2.9	1.6	1.5	1.5	1.5
Emphysema	22.7	13.9	14.2	15.5	15.5	11.2	6.1	5.9	6.3	6.3
Asthma	2.3	2.9	3.9	4.6	5.2	1.1	1.3	1.6	1.9	2.1
Other	( <sup>7</sup> )	35.6	53.0	59.0	60.0	( <sup>7</sup> )	15.7	22.2	24.0	24.2
Pneumonia and influenza	62.7	54.6	67.6	77.7	75.2	30.9	24.1	26.3	31.6	30.3
Pneumonia	59.0	51.9	65.6	75.7	73.9	29.0	22.9	27.5	30.8	29.8
Influenza	3.7	2.7	2.1	1.9	1.4	1.8	1.2	0.9	0.8	0.6
Diabetes mellitus	38.3	34.9	37.0	40.4	46.6	18.9	15.4	15.5	16.4	18.8
Suicide	23.5	26.9	29.5	30.4	31.2	11.6	11.9	12.3	12.4	12.6
Chronic liver disease and cirrhosis	31.4	30.6	26.8	26.4	26.4	15.5	13.5	11.2	10.7	10.6
Other infective and parasitic diseases	6.9	5.1	6.1	24.0	29.5	3.4	2.2	3.4	9.7	11.9
Human immunodeficiency virus (HIV) infection (AIDs)	( <sup>7</sup> )	( <sup>7</sup> )	( <sup>7</sup> )	16.6	21.4	( <sup>7</sup> )	( <sup>7</sup> )	( <sup>7</sup> )	6.8	8.6
Homicide and legal intervention	16.8	24.3	19.9	22.0	23.0	8.3	10.7	8.3	9.0	9.3
Nephritis, nephrotic syndrome, and nephrosis	6.9	16.8	21.3	22.4	21.2	4.4	7.4	8.9	9.1	8.6
Septicemia	3.5	9.4	17.2	20.9	19.1	1.7	4.2	7.2	8.5	7.7
Certain conditions originating in the perinatal period	43.2	22.9	19.2	18.2	18.5	21.3	10.1	8.1	7.4	7.5
Congenital anomalies	16.8	13.9	12.8	12.8	12.7	8.3	6.2	5.4	5.2	5.1
Benign neoplasms <sup>5</sup>	4.8	6.2	6.7	6.7	7.1	2.4	2.7	2.8	2.7	2.9
Ulcer of stomach and duodenum	8.6	6.1	6.6	6.4	6.6	4.2	2.7	2.8	2.6	2.7
Hernia of abdominal cavity and intestinal obstruction <sup>6</sup>	7.2	5.4	5.4	5.6	5.4	3.6	2.4	2.2	2.3	2.2
Anemias	3.4	3.2	3.7	3.8	3.9	1.7	1.4	1.5	1.6	1.6
Cholelithiasis and other disorders of gall bladder	4.0	3.3	3.0	3.1	3.0	2.0	1.5	1.2	1.3	1.2
Nutritional deficiencies	2.5	2.4	2.9	3.0	3.1	1.2	1.0	1.2	1.2	1.2
Tuberculosis	5.2	2.0	1.8	1.9	1.8	2.6	0.9	0.7	0.8	0.7
Infections of kidney	8.2	2.7	2.0	1.6	1.3	4.0	1.2	0.8	0.7	0.5
Viral hepatitis	1.0	0.8	0.9	1.3	1.4	0.5	0.4	0.4	0.5	0.6
Meningitis	1.7	1.4	1.2	1.2	1.0	0.8	0.6	0.5	0.5	0.4
Acute bronchitis and bronchiolitis	1.3	0.6	0.6	0.6	0.5	0.6	0.3	0.3	0.3	0.2
Hyperplasia of prostate	2.2	0.8	0.5	0.5	0.4	1.1	0.3	0.2	0.2	0.2
Symptoms, signs, and ill-defined conditions	25.8	28.8	31.0	31.0	29.8	12.7	12.7	13.0	12.6	12.0
All other causes	108.8	120.0	153.0	171.7	175.6	53.5	53.0	64.4	69.8	70.4

<sup>1</sup> Based on a 10-percent sample of deaths. Includes deaths of nonresidents. <sup>2</sup> 1970 and 1980 based on resident population enumerated as of Apr. 1; 1985-1989 estimated as of July 1. <sup>3</sup> With or without renal disease. <sup>4</sup> Includes other types of malignancies not shown separately. <sup>5</sup> Prior to 1980, data are shown for bronchitis, emphysema, and asthma. <sup>6</sup> Included in "all other causes." <sup>7</sup> Comparable data not available separately. <sup>8</sup> Data are included in several other categories. <sup>9</sup> Includes neoplasms of unspecified nature; beginning 1980 also includes carcinoma in situ. <sup>10</sup> Without mention of hernia.

Source: U.S. National Center for Health Statistics, *Vital Statistics of the United States*, annual, *Monthly Vital Statistics Report*, and unpublished data.

M A T R I X I I I

No. 122. Death Rates From Cancer, by Sex, Age, and Selected Type: 1970 to 1988

(Deaths per 100,000 population in the specified age groups. See headnote, table 121)

AGE AT DEATH AND SELECTED TYPE OF CANCER	MALE					FEMALE				
	1970	1980	1985	1987	1988	1970	1980	1985	1987	1988
Total U.S. rate <sup>1</sup>	182.1	205.3	212.6	214.8	215.5	144.4	163.6	175.1	176.0	180.8
25-34 years	16.3	13.4	13.0	12.1	11.7	16.7	14.0	13.1	12.7	12.7
35-44 years	53.0	44.0	42.3	39.1	39.7	65.6	53.1	49.1	47.8	48.5
45-54 years	183.5	188.7	174.5	169.1	166.3	181.5	171.8	164.0	159.7	154.9
55-64 years	511.8	520.8	531.1	528.4	526.7	343.2	361.7	379.1	374.5	376.8
65 years old and over	1,221.2	1,371.6	1,389.8	1,397.1	1,398.6	706.3	767.8	813.8	829.1	840.5
65-74 years	1,006.8	1,093.2	1,085.6	1,084.0	1,072.7	557.9	607.1	644.6	652.5	659.7
75-84 years	1,588.3	1,790.5	1,840.2	1,850.2	1,861.0	891.8	903.1	948.3	967.4	982.6
85 years old and over	1,720.8	2,369.5	2,413.7	2,474.8	2,527.9	1,096.7	1,255.7	1,262.9	1,282.9	1,292.8
Persons, 35-44 years old:										
Respiratory, intrathoracic	17.0	12.6	10.8	9.4	9.6	6.5	6.8	5.8	6.0	5.6
Digestive organs, peritoneum	11.4	9.5	9.0	9.0	9.1	8.6	6.5	5.8	5.8	5.8
Breast	0.1	-	0.1	0.1	0.1	20.4	17.9	17.5	17.5	17.6
Genital organs	1.4	0.7	0.7	0.7	0.5	13.6	8.3	7.1	6.7	6.9
Lymphatic and hematopoietic tissues, excl. leukemia	5.6	4.3	4.6	4.1	4.4	3.2	2.4	2.3	1.9	2.4
Urinary organs	1.9	1.4	1.6	1.4	1.4	1.0	0.6	0.9	0.7	0.7
Lp, oral cavity, and pharynx	1.7	1.8	1.4	1.2	1.2	0.7	0.5	0.8	0.4	0.4
Leukemia	3.4	3.2	3.0	2.8	3.0	2.8	2.6	2.1	2.0	2.1
Persons, 45-54 years old:										
Respiratory, intrathoracic	72.1	79.8	70.7	68.7	65.7	22.2	34.8	35.9	35.5	35.0
Digestive organs, peritoneum	45.9	44.3	41.7	40.1	38.5	32.5	27.8	25.7	24.3	22.4
Breast	0.4	0.2	0.3	0.1	0.3	52.6	48.1	46.7	45.4	45.3
Genital organs	3.4	3.4	3.1	3.0	3.1	34.4	24.1	20.4	19.8	18.5
Lymphatic and hematopoietic tissues, excl. leukemia	12.8	10.2	10.0	10.5	10.5	8.3	6.6	6.4	6.1	6.1
Urinary organs	8.0	7.4	7.5	7.2	7.0	3.5	3.3	3.0	3.3	2.9
Lp, oral cavity, and pharynx	7.9	8.2	6.8	6.1	6.6	2.8	2.6	2.0	2.0	1.8
Leukemia	6.6	6.2	5.7	5.3	5.5	4.9	4.4	4.3	4.4	3.9
Persons, 55-64 years old:										
Respiratory, intrathoracic	202.3	223.8	231.1	230.9	229.5	38.9	74.5	93.9	97.8	102.2
Digestive organs, peritoneum	139.0	129.3	129.3	125.9	125.9	86.0	79.1	74.7	73.0	69.8
Breast	0.6	0.7	0.6	0.7	0.4	77.6	80.5	83.6	80.7	81.8
Genital organs	22.8	23.5	24.3	24.4	25.1	58.2	46.8	42.8	40.2	41.3
Lymphatic and hematopoietic tissues, excl. leukemia	27.1	24.4	25.0	24.8	25.6	17.7	16.8	17.5	16.7	16.5
Urinary organs	26.4	22.9	22.2	22.8	21.4	9.4	8.9	8.5	8.6	8.5
Lp, oral cavity, and pharynx	20.1	17.9	15.8	15.3	15.4	6.2	6.0	5.4	5.0	4.9
Leukemia	15.4	14.7	14.6	14.0	13.9	9.0	9.3	9.2	8.7	8.5
Persons, 65-74 years old:										
Respiratory, intrathoracic	340.7	422.0	424.8	430.0	425.4	45.6	106.1	145.1	157.3	164.1
Digestive organs, peritoneum	293.3	284.1	272.7	262.7	257.3	185.8	173.6	162.7	158.3	155.6
Breast	1.4	1.1	1.0	1.1	1.1	93.8	101.1	107.7	108.3	109.4
Genital organs	103.7	107.6	108.3	111.1	111.8	85.6	73.6	71.2	70.1	71.3
Lymphatic and hematopoietic tissues, excl. leukemia	50.3	48.1	52.2	53.5	52.0	34.6	34.4	36.6	37.5	38.5
Urinary organs	60.3	56.9	51.1	49.4	50.0	20.1	19.7	19.7	19.3	19.7
Lp, oral cavity, and pharynx	26.8	25.4	23.7	21.3	20.9	6.7	8.8	8.6	7.9	8.3
Leukemia	35.3	35.3	34.0	32.4	32.7	19.3	18.7	19.2	18.2	17.8
Persons, 75-84 years old:										
Respiratory, intrathoracic	354.2	511.5	559.0	571.5	579.8	56.5	98.0	137.2	158.4	169.9
Digestive organs, peritoneum	507.5	496.6	476.2	467.3	456.8	353.3	326.3	312.2	300.4	297.1
Breast	2.7	2.1	2.3	2.5	2.3	127.4	126.4	137.7	137.8	143.1
Genital organs	298.4	315.4	321.4	324.6	333.9	104.9	95.7	93.8	94.9	94.5
Lymphatic and hematopoietic tissues, excl. leukemia	74.0	80.0	92.8	92.7	96.7	49.4	57.8	64.2	68.6	69.4
Urinary organs	112.2	112.4	106.2	106.7	102.5	44.0	37.4	36.8	36.9	36.9
Lp, oral cavity, and pharynx	36.6	31.4	27.6	24.4	26.0	10.8	10.9	10.0	10.4	11.0
Leukemia	68.3	71.5	70.1	69.0	71.8	39.6	38.5	38.5	38.8	37.7
Persons, 85 years old and over:										
Respiratory, intrathoracic	215.3	386.3	450.2	489.2	492.8	56.5	96.3	102.7	117.2	125.7
Digestive organs, peritoneum	583.7	705.8	656.8	659.4	658.1	465.0	504.3	490.4	477.7	483.3
Breast	2.9	2.6	3.9	3.5	4.0	157.1	169.3	175.9	176.5	183.9
Genital organs	434.2	612.3	605.0	653.2	663.6	107.3	115.9	104.6	104.8	106.8
Lymphatic and hematopoietic tissues, excl. leukemia	58.1	93.2	113.1	113.6	126.8	41.7	63.0	72.6	81.1	78.7
Urinary organs	140.5	177.0	182.7	166.7	165.0	59.9	63.8	62.3	65.0	64.8
Lp, oral cavity, and pharynx	47.0	40.2	32.2	31.1	33.0	19.2	16.0	15.8	16.3	14.4
Leukemia	83.3	117.1	113.1	103.7	110.1	50.9	61.1	63.0	64.3	62.4

- Represents or rounds to zero. <sup>1</sup> Includes persons under 25 years of age and malignant neoplasms of other and unspecified sites, not shown separately.

Source: U.S. National Center for Health Statistics, *Vital Statistics of the United States*, annual; and unpublished data.



# M A T R I X I I I

## No. 120. Acquired Immunodeficiency Syndrome (AIDS) Deaths, by Selected Characteristics: 1982 to 1989

[Data are shown by year of death and are subject to retrospective changes. For data on AIDS cases reported, see table 192. Based on reporting by State health departments]

CHARACTERISTIC	NUMBER										PERCENT DISTRIBUTION	
	Total <sup>1</sup>	1982	1983	1984	1985	1986	1987	1988	1989	Total	1989	
Total <sup>2</sup>	77,350	444	1,436	3,266	6,404	10,965	14,612	18,248	21,675	100.0	100.0	
Age:												
Under 5 years old	976	12	28	45	92	118	213	223	235	1.2	1.1	
5-12 years old	182	1	1	4	12	24	46	42	52	0.2	0.2	
13-29 years old	15,044	88	312	679	1,291	2,176	2,864	3,531	4,039	19.4	18.6	
30-39 years old	34,790	208	631	1,467	2,882	4,974	6,535	8,091	9,865	45.0	45.5	
40-49 years old	17,001	85	323	704	1,342	2,354	3,116	4,054	4,967	22.1	22.9	
50-59 years old	6,393	42	122	277	555	881	1,186	1,538	1,764	8.2	8.1	
60 years old and over	2,964	8	19	90	230	438	652	768	753	3.8	3.5	
Sex:												
Male	69,929	401	1,321	3,000	5,915	10,022	13,178	16,334	19,499	90.4	90.0	
Female	7,421	43	115	266	489	943	1,434	1,914	2,176	9.6	10.0	
Race/ethnicity:												
White, non-Hispanic	43,895	217	770	1,893	3,807	6,507	8,250	10,044	12,251	57.1	56.5	
Black, non-Hispanic	22,493	153	451	895	1,705	2,904	4,283	5,564	6,438	29.0	29.7	
Hispanic	10,254	73	208	454	852	1,465	1,954	2,462	2,747	12.9	12.7	

<sup>1</sup> Includes deaths prior to 1982. <sup>2</sup> Includes other race/ethnicity groups not shown separately.

Source: U.S. Centers for Disease Control, Atlanta, GA, unpublished data.

## No. 121. Death Rates From Heart Disease, by Sex, Age, and Selected Type: 1970 to 1988

[Deaths per 100,000 population in specified age groups. Excludes deaths of nonresidents of the United States. Beginning 1980, deaths classified according to the ninth revision of the *International Classification of Diseases*. For earlier years, classified according to the revision in use at the time; see text, section 2. See Appendix III]

AGE AT DEATH AND SELECTED TYPE OF HEART DISEASE	MALE					FEMALE				
	1970	1980	1985	1987	1988	1970	1980	1985	1987	1988
Total U.S. rate <sup>1</sup>	422.5	368.6	342.8	325.0	321.9	304.5	305.1	304.3	300.4	301.2
25-34 years	15.2	11.4	11.5	11.4	11.3	7.7	5.3	5.0	5.5	5.1
35-44 years	103.2	68.7	58.4	55.0	52.2	32.2	21.4	18.3	16.8	16.8
45-54 years	376.4	282.6	236.9	214.8	199.8	109.9	84.5	73.8	70.3	66.7
55-64 years	987.2	746.8	651.9	598.6	584.7	351.6	272.1	250.3	240.0	237.0
65 years old and over	3,258.0	2,778.6	2,519.3	2,355.6	2,336.1	2,268.2	2,027.5	1,938.0	1,882.6	1,881.3
65-74 years	2,170.3	1,728.0	1,508.4	1,388.6	1,358.1	1,082.7	828.6	745.3	705.3	685.6
75-84 years	4,534.8	3,834.2	3,498.0	3,267.4	3,239.1	3,120.8	2,497.0	2,245.2	2,135.7	2,122.4
85 years old and over	8,426.2	6,752.7	6,123.7	5,795.0	5,780.9	7,591.8	7,350.5	6,935.7	6,792.2	6,810.1
Persons 45-54 years old:										
Ischemic heart	338.0	217.3	189.9	147.4	134.5	84.0	52.2	43.3	39.6	36.8
Rheumatic heart	11.4	3.1	1.9	1.3	1.5	10.6	4.3	2.7	2.4	2.1
Hypertensive heart <sup>2</sup>	4.6	8.3	8.4	8.2	7.8	4.0	5.4	4.6	4.3	4.2
Persons 55-64 years old:										
Ischemic heart	904.6	581.1	474.6	421.7	401.3	299.1	189.0	163.3	151.3	147.1
Rheumatic heart	21.5	6.2	4.2	3.8	3.4	20.8	9.2	6.3	5.4	5.6
Hypertensive heart <sup>2</sup>	11.7	21.8	19.6	19.4	18.6	9.1	13.3	12.2	11.5	11.6
Persons 65-74 years old:										
Ischemic heart	2,010.0	1,355.5	1,110.8	988.6	956.9	978.0	605.3	514.1	469.9	453.1
Rheumatic heart	31.9	11.8	8.6	7.5	7.3	30.2	18.6	13.3	13.1	12.5
Hypertensive heart <sup>2</sup>	30.6	44.3	38.2	35.6	34.9	24.8	36.2	29.0	27.8	26.3
Persons 75-84 years old:										
Ischemic heart	4,222.7	2,953.7	2,544.9	2,313.9	2,277.5	2,866.3	1,842.7	1,547.5	1,430.4	1,413.1
Rheumatic heart	34.8	16.7	14.7	13.7	13.6	34.3	25.4	24.1	23.9	24.6
Hypertensive heart <sup>2</sup>	80.8	90.7	79.5	71.7	69.6	83.8	101.1	80.4	74.4	74.3
Persons 85 years old and over:										
Ischemic heart	7,781.5	6,501.6	5,658.9	5,260.9	5,236.2	6,951.5	5,280.6	4,642.8	4,402.3	4,374.2
Rheumatic heart	34.7	19.5	17.7	16.6	21.1	39.2	25.8	27.2	29.9	29.9
Hypertensive heart <sup>2</sup>	182.0	180.3	150.7	138.5	148.8	223.5	250.8	213.9	203.5	199.4

<sup>1</sup> Includes persons under 25 years old, not shown separately. <sup>2</sup> With or without renal disease.

Source: U.S. National Center for Health Statistics, *Vital Statistics of the United States*, annual; and unpublished data.

# M A T R I X I I I

## No. 119. Death Rates, by Cause—States: 1988

[Deaths per 100,000 resident population estimated as of July 1. By place of residence. Excludes nonresidents of U.S. Causes of death classified according to ninth revision of *International Classification of Diseases*]

REGION, DIVISION, AND STATE	Total <sup>1</sup>	Diseases of heart	Malignant neoplasms	Cerebrovascular diseases	Accidents and adverse effects	Chronic obstructive pulmonary diseases <sup>2</sup>	Pneumonia, flu	Diabetes mellitus	Suicide	Chronic liver disease and cirrhosis	Atherosclerosis	Homicide and legal intervention	HIV <sup>3</sup> infection
<b>U.S.</b> .....	<b>882.0</b>	<b>311.3</b>	<b>197.3</b>	<b>61.2</b>	<b>39.5</b>	<b>33.7</b>	<b>31.8</b>	<b>16.4</b>	<b>12.4</b>	<b>10.7</b>	<b>9.0</b>	<b>9.0</b>	<b>6.8</b>
<b>Northeast</b> .....	<b>979.4</b>	<b>366.9</b>	<b>222.7</b>	<b>58.9</b>	<b>33.1</b>	<b>32.6</b>	<b>35.7</b>	<b>19.1</b>	<b>9.0</b>	<b>12.5</b>	<b>9.0</b>	<b>7.8</b>	<b>12.3</b>
<b>N.E.</b> .....	<b>923.8</b>	<b>329.3</b>	<b>218.2</b>	<b>60.4</b>	<b>31.2</b>	<b>34.6</b>	<b>36.6</b>	<b>17.8</b>	<b>10.3</b>	<b>11.5</b>	<b>10.1</b>	<b>4.2</b>	<b>4.7</b>
ME.....	955.9	330.4	226.6	64.5	39.5	46.1	29.5	22.9	13.4	10.5	14.4	3.0	1.4
NH.....	808.3	278.3	195.2	56.2	27.6	33.5	28.2	16.4	13.1	11.1	9.0	2.6	2.2
VT.....	837.7	289.4	183.3	56.9	41.8	45.2	33.4	16.7	16.2	11.0	8.8	2.5	1.1
MA.....	959.1	343.9	223.4	63.5	29.7	34.4	43.0	15.7	8.6	12.4	10.7	4.1	5.4
RI.....	979.2	353.6	242.0	64.0	29.7	34.3	26.1	28.6	10.0	13.1	9.4	4.5	4.2
CT.....	883.9	318.8	211.9	53.9	30.7	29.3	34.1	16.4	10.3	10.2	7.9	5.6	6.2
<b>M.A.</b> .....	<b>998.5</b>	<b>379.8</b>	<b>224.2</b>	<b>58.4</b>	<b>33.7</b>	<b>32.2</b>	<b>35.4</b>	<b>19.7</b>	<b>8.6</b>	<b>12.8</b>	<b>8.6</b>	<b>9.0</b>	<b>14.9</b>
NY.....	984.5	376.2	218.0	54.0	32.1	31.0	36.7	18.1	6.7	14.2	8.7	12.8	22.3
NJ.....	950.8	356.1	223.5	54.9	31.5	29.3	31.1	19.8	7.0	13.5	8.0	5.4	15.0
PA.....	1,050.1	400.6	237.1	67.3	37.6	36.0	33.3	21.9	12.4	10.3	8.7	5.8	3.9
<b>Midwest</b> .....	<b>806.4</b>	<b>332.1</b>	<b>203.1</b>	<b>65.1</b>	<b>37.2</b>	<b>34.7</b>	<b>33.6</b>	<b>17.0</b>	<b>11.8</b>	<b>9.0</b>	<b>10.8</b>	<b>6.8</b>	<b>2.4</b>
<b>E.M.C.</b> .....	<b>888.8</b>	<b>333.5</b>	<b>203.2</b>	<b>62.3</b>	<b>36.2</b>	<b>33.6</b>	<b>31.3</b>	<b>17.8</b>	<b>11.5</b>	<b>9.9</b>	<b>10.3</b>	<b>7.8</b>	<b>2.6</b>
OH.....	922.4	344.6	212.1	62.1	34.6	37.5	29.9	19.7	11.2	8.9	9.4	5.2	2.1
IN.....	900.6	318.0	204.3	70.0	39.0	37.4	28.8	22.0	11.6	8.3	12.1	5.9	2.0
IL.....	906.2	340.8	202.3	59.9	37.9	30.4	33.1	15.8	10.8	10.8	9.1	9.8	4.0
MI.....	867.4	327.2	193.8	56.8	35.1	31.4	29.1	16.5	11.8	11.7	12.9	11.5	2.3
WI.....	886.3	320.7	202.1	69.8	34.8	32.7	37.1	16.2	13.5	8.1	8.7	3.5	1.2
<b>W.M.C.</b> .....	<b>823.0</b>	<b>328.9</b>	<b>202.8</b>	<b>71.9</b>	<b>36.7</b>	<b>37.3</b>	<b>36.0</b>	<b>15.2</b>	<b>11.8</b>	<b>7.0</b>	<b>12.0</b>	<b>4.8</b>	<b>2.1</b>
MN.....	823.0	276.5	188.2	69.9	34.7	30.1	35.7	12.9	11.3	6.8	9.8	2.9	1.7
IA.....	983.4	359.2	218.4	78.1	41.4	42.5	44.4	16.2	11.2	6.8	17.8	1.9	0.8
MO.....	988.9	359.3	212.7	71.1	43.6	40.5	37.7	16.0	13.3	7.3	8.6	6.5	3.6
ND.....	849.2	308.5	182.7	64.6	35.8	30.4	31.5	17.2	10.6	8.7	14.7	2.4	0.4
SD.....	922.7	364.0	189.9	73.2	40.4	33.7	43.2	13.3	11.5	7.3	9.7	4.5	0.7
NE.....	928.3	321.4	197.6	72.3	38.5	36.4	45.7	15.5	10.4	6.4	16.1	3.4	1.7
KS.....	921.5	322.8	199.6	71.3	40.2	40.4	38.1	16.4	12.3	7.1	13.5	4.0	2.2
<b>South</b> .....	<b>885.9</b>	<b>306.0</b>	<b>196.6</b>	<b>64.4</b>	<b>44.7</b>	<b>32.3</b>	<b>28.2</b>	<b>16.4</b>	<b>13.2</b>	<b>9.8</b>	<b>7.9</b>	<b>11.3</b>	<b>5.8</b>
<b>S.A.</b> .....	<b>917.4</b>	<b>318.0</b>	<b>209.1</b>	<b>66.3</b>	<b>44.5</b>	<b>34.2</b>	<b>27.8</b>	<b>16.8</b>	<b>13.4</b>	<b>11.2</b>	<b>7.5</b>	<b>11.5</b>	<b>7.2</b>
DE.....	874.1	309.8	217.7	44.7	43.8	30.2	22.9	22.3	13.2	9.7	5.8	4.7	3.9
MD.....	836.3	276.2	201.0	51.3	33.3	30.4	27.8	16.7	11.3	9.8	6.4	10.6	5.4
DC.....	1,242.1	355.9	263.9	64.5	39.1	23.5	44.7	22.0	7.8	34.7	3.7	49.9	40.0
VA.....	791.5	268.6	184.5	58.5	37.1	27.3	29.0	12.5	12.8	9.0	6.8	8.2	4.3
WV.....	1,055.1	397.1	231.7	69.8	47.7	48.1	36.7	20.8	11.4	8.8	11.1	5.8	0.9
NC.....	888.3	299.4	195.8	73.6	49.5	32.3	29.7	20.4	12.1	10.8	6.4	9.0	3.4
SC.....	848.1	293.9	177.1	74.7	55.9	27.4	21.5	15.9	9.9	9.4	5.2	10.0	3.3
GA.....	814.0	266.7	171.2	63.7	49.6	29.0	26.1	14.4	13.4	9.2	6.2	12.8	7.5
FL.....	1,062.4	380.4	253.0	71.5	43.7	43.1	27.3	17.3	16.7	13.6	9.8	13.9	11.7
<b>E.S.C.</b> .....	<b>947.3</b>	<b>333.4</b>	<b>208.0</b>	<b>73.1</b>	<b>50.9</b>	<b>35.9</b>	<b>31.6</b>	<b>18.7</b>	<b>12.5</b>	<b>8.8</b>	<b>9.0</b>	<b>9.8</b>	<b>2.1</b>
KY.....	955.6	338.0	215.3	68.9	46.1	41.1	35.9	22.7	12.6	8.7	10.2	6.0	1.2
TN.....	935.1	327.7	201.1	76.2	49.4	35.6	33.2	15.1	13.4	8.4	8.8	10.4	2.1
AL.....	953.9	323.5	206.2	71.2	54.5	35.1	28.8	19.3	12.1	9.8	9.3	11.5	2.2
MS.....	947.9	352.7	201.4	76.1	54.8	30.7	27.1	19.0	11.3	8.1	7.5	11.8	2.8
<b>W.S.C.</b> .....	<b>801.2</b>	<b>274.8</b>	<b>171.8</b>	<b>56.5</b>	<b>41.8</b>	<b>27.2</b>	<b>26.7</b>	<b>14.4</b>	<b>13.2</b>	<b>8.2</b>	<b>7.9</b>	<b>11.9</b>	<b>5.7</b>
AR.....	1,039.8	359.4	225.8	88.9	51.7	36.2	41.7	17.5	12.6	7.0	8.7	10.6	2.2
LA.....	853.0	303.0	190.8	58.4	44.5	25.9	23.2	19.6	13.1	7.4	8.5	13.2	5.6
OK.....	926.3	339.6	197.3	71.1	44.2	37.2	36.0	16.6	12.8	8.9	12.0	8.1	2.4
TX.....	729.6	242.5	153.8	48.5	38.8	24.3	23.7	12.2	13.4	8.4	6.9	12.4	6.9
<b>West</b> .....	<b>749.1</b>	<b>240.0</b>	<b>166.4</b>	<b>53.7</b>	<b>39.9</b>	<b>35.8</b>	<b>30.8</b>	<b>13.0</b>	<b>15.3</b>	<b>12.6</b>	<b>8.6</b>	<b>8.7</b>	<b>7.9</b>
<b>Mt.</b> .....	<b>711.9</b>	<b>218.8</b>	<b>153.7</b>	<b>44.2</b>	<b>44.3</b>	<b>38.6</b>	<b>28.2</b>	<b>14.3</b>	<b>19.0</b>	<b>10.3</b>	<b>8.4</b>	<b>6.9</b>	<b>3.5</b>
MT.....	842.4	257.3	191.7	57.0	46.7	47.6	30.9	19.0	18.0	10.8	10.9	4.2	0.6
ID.....	767.8	237.1	158.8	60.1	54.6	40.2	34.2	16.3	17.8	6.5	8.3	3.7	1.1
WY.....	677.7	191.9	145.7	48.9	53.2	41.1	31.1	14.6	16.9	8.6	6.1	2.7	0.6
CO.....	646.8	196.2	134.9	40.1	34.4	39.3	29.8	11.2	18.1	8.3	10.8	5.8	5.1
NM.....	691.8	189.8	144.7	42.0	56.7	31.3	24.3	17.1	22.8	12.8	7.0	11.1	2.1
AZ.....	793.5	251.5	180.0	43.9	48.6	41.9	28.6	15.6	19.5	12.9	9.1	9.3	4.3
UT.....	545.8	175.3	101.1	40.8	35.0	22.1	24.3	13.1	13.6	4.8	4.4	3.2	2.0
NV.....	804.0	256.3	193.3	39.5	42.7	52.8	25.0	11.7	26.0	17.1	6.4	9.9	6.1
<b>Pac.</b> .....	<b>762.4</b>	<b>247.5</b>	<b>171.8</b>	<b>57.1</b>	<b>38.3</b>	<b>34.8</b>	<b>31.7</b>	<b>12.6</b>	<b>13.9</b>	<b>13.4</b>	<b>8.7</b>	<b>9.4</b>	<b>8.5</b>
WA.....	781.8	252.7	179.3	60.2	37.5	39.7	28.3	14.1	15.5	9.8	10.2	5.9	4.4
OR.....	896.6	281.1	210.6	72.5	45.4	43.2	33.4	16.0	16.9	10.4	14.0	5.4	3.6
CA.....	761.1	249.5	168.5	56.5	37.4	34.2	33.0	12.0	13.7	14.7	8.3	10.7	11.2
AK.....	393.9	88.7	85.7	16.4	74.4	13.5	8.8	7.6	10.5	8.6	1.0	5.2	1.3
HI.....	553.3	167.3	139.3	39.2	28.7	17.5	17.9	13.4	7.9	7.2	3.5	3.2	5.6

<sup>1</sup> Includes other causes not shown separately. <sup>2</sup> Includes allied conditions. <sup>3</sup> Human immunodeficiency virus.

Source: U.S. National Center for Health Statistics, *Vital Statistics of the United States*, annual.

## VETERINARY BACTERIOLOGY

There are many diseases of animals that may be transmitted directly or indirectly to man. These include a wide variety of bacterial infections as well as diseases caused by viruses, pathogenic protozoa, and Rickettsia. The latter will be discussed in later chapters, and many of the bacterial infections will be described here. Among the bacterial diseases are bovine tuberculosis (see Chapter XXII), septic sore throat (see Chapter XVIII), anthrax, glanders, contagious abortion of cattle, Malta fever, symptomatic anthrax, malignant edema, and tularemia. Diseases of animals may be contracted by man in different ways: 1. Through an insect vector, such as lice, fleas, or ticks. 2. Through eating food or drinking milk coming from diseased animals. 3. Through direct contact with animals that are infected. Veterinary medicine and bacteriology, then, are closely interrelated subjects and an integral part of medical bacteriology.

### MYCOBACTERIUM PARATUBERCULOSIS

*Mycobacterium Paratuberculosis* (Bacillus of Johne's Disease).

1. Group—acid-fast. 2. Family—Mycobacteriaceae. 3. Habitat—intestinal mucosa; cause of Johne's disease, a chronic diarrhea of cattle. 4. Discoverers—Johne and Frothingham, in 1895.

#### Morphological Characteristics.

1. Form—more or less pleomorphic rods. 2. Cell groupings—occurs singly, in pairs, or in clumps. 3. Size— $0.5\mu$  broad and 1 to  $2\mu$  long. 4. Staining properties—usually stains uniformly, but the longer forms show alternate stained and unstained segments. With Ziehl-Neelsen stain, it is acid-fast. It is not stained by ordinary aniline dyes. 5. Gram-positive. 6. Nonmotile. 7. Nonsporing.

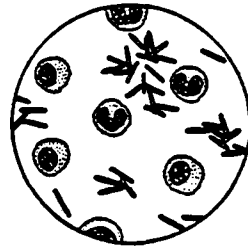

FIG. 37. *Mycobacterium paratuberculosis* in lymph.

**Cultural Characteristics.** The organism has been difficult to cultivate and grows poorly on agar, potato, and gelatin stabs. Growth is more profuse if killed cultures of other acid-fast bacteria are added. 1. Glycerol broth—grows in clumps, with sediment in bottom of tube and clear liquid above; adapted cultures may produce a thin surface pellicle which becomes wrinkled and thickened. 2. Dorset's glycerol egg medium—after several days of incubation, very minute, slow-growing, dry, grayish-white colonies appear; as colony grows older and larger, it becomes wrinkled.

**Physiological Characteristics.** 1. Optimum temperature,  $39^{\circ}\text{C}$ .; minimum,  $27^{\circ}\text{C}$ .; maximum,  $43^{\circ}\text{C}$ . 2. Grows best aerobically; slight growth under anaerobic conditions. 3. Resistance—the organisms will resist desiccation. Direct sunlight kills them in a few minutes. Disinfectants are effective in the usual dilutions, if the organism is free from albuminous matter.

**Pathogenicity.** The disease affects cattle and, less frequently, sheep and deer, following ingestion of fodder that has been soiled with feces of infected animals. The disease is a chronic enteritis characterized by gradual emaciation, running a long course extending from a period of several months, finally ending in death in practically

all cases. The incubation period may run up to 18 months. Aside from evidence of emaciation, the post-mortem examination reveals no specific lesions apart from those in the intestinal tract. The intestinal mucosa, particularly that of the small intestine, is greatly thickened and presents a marked, wrinkled, or corrugated appearance. On the surface of the corrugations there are hemorrhages, and occasionally small nodules are observed. The bacilli are usually found in the mesenteric glands which are enlarged, edematous, and pigmented.

**Diagnosis.** 1. A preparation, *johnin*, which is similar to tuberculin, has been made by growing Johne's bacillus in a special broth medium containing dead *Mycobacterium phlei* bacilli. When 0.2 ml. of johnin is injected intradermally into an animal and 0.2 ml. is injected 48 hours later into the site of the previous injection, a positive reaction of diffuse swelling occurs in infected animals. The injection of avian tuberculin in large amounts may produce a reaction in animals with Johne's disease. The test with johnin is believed to be specific and of diagnostic value.

2. The organism may be cultivated on glycerin egg medium containing dead tubercle bacilli, by inoculating the medium with intestinal mucosa washed in 20% antiformin.

3. A smear may be prepared using a piece of the intestinal mucosa and staining by the Ziehl-Neelsen method.

**Production of Disease.** Although attempts have been made to infect guinea pigs, rats, and mice, it is considered that the typical disease has not yet been transferred to animals. No case of human infection has been recorded.

**Prophylaxis.** No method of prophylaxis has been devised. Control of the disease is based on the destruction of infected animals.

**Related Organisms.** 1. *Mycobacterium avium*, 2. *Mycobacterium tuberculosis*, 3. *Mycobacterium leprae*, 4. *Mycobacterium piscium*, 5. *Mycobacterium marinum*, 6. *Mycobacterium ranae*, and 7. *Mycobacterium friedmannii*.

#### BACILLUS ANTHRACIS

**Bacillus Anthracis (Anthrax Bacillus).** 1. Group—aerobic, spore-bearing. 2. Family—Bacillaceae. 3. Habitat—found in soil and parasitic in cattle, sheep, man, and other animals. 4. Discoverers—Cohn, in 1872, and Koch, in 1876.

**Morphological Characteristics.** 1. Form—rods with square or concave ends. 2. Cell groupings—occurs singly with diplobacillary forms, and also in chains. 3. Size—1 to 2 $\mu$  by 5 to 10 $\mu$ . 4. Staining properties—stains well with carbol fuchsin, methylene blue, and other aniline dyes. 5. Gram-positive and non-acid-fast. 6. Spores are equatorial, ellipsoidal, and do not bulge. Their germination is polar and they are not produced in the animal body; they are formed only in the presence of oxygen. 7. Capsule is found in the animal body and is present in cultures grown on serum media, but not on agar. 8. Nonmotile.

**Cultural Characteristics.** *Bacillus anthracis* is easily cultivated on culture media generally used in the laboratory. 1. Agar cultures—the colonies are raised, grayish-white, and irregular, with an uneven surface. They give a Medusa head appearance which is

characteristic of the organism; the colony is made up of characteristic parallel interlacing chains of bacilli. 2. Agar slant—the growth is thick, grayish-white or cream color, with an uneven surface, resembling matted hair. 3. Gelatin stab—slight filiform growth which gradually resembles an inverted fir tree. Liquefaction is crateriform, becoming stratiform. 4. Litmus milk—growth is rapid, with decolorization in 2 to 3 days and coagulation with subsequent peptonization. 5. Potato—growth is dry, elevated, tending to expand, and white to grayish-white in color. 6. Broth—growth in flocculent masses, with a thick pellicle forming on the surface. 7. Blood serum—growth is abundant and creamy-yellow, with slight liquefaction of the medium.

**Physiological Characteristics.** 1. Optimum temperature, 37° C., with limits between 12° and 44° C. 2. Aerobic, and facultative anaerobe. 3. Acid, but no gas, is formed in glucose, maltose, sucrose, and salicin. 4. Nitrates are reduced to nitrites. 5. The organism does not produce indol, nor is starch hydrolyzed. 6. Ammonia production is slight. 7. Resistance—spores are killed by boiling for 10 minutes, but in dry state may remain alive for years. 8. Pigment production—some strains form a brownish-yellow and, occasionally, a pink pigment.

**Pathogenicity.** The natural disease affects herbivora, chiefly sheep and cattle, in which the mortality may be as high as 80%. The disease generally involves septicemia. In acute cases, the animal may appear in customary health until a short time before death, when convulsions, rigors, and elevation of temperature occur, with blood extravasations from the nose, mouth, and rectum. The most marked post-mortem finding is enlargement of the spleen. This organ becomes pliable and soft and contains enormous numbers of bacilli.

Man may be infected by the cutaneous, respiratory, or intestinal routes.

1. *Cutaneous Anthrax.* This form occurs most frequently upon the hands and forearms, especially of persons working with livestock. It is referred to as *malignant pustule* and is characterized by the appearance of a small furuncle within 12 to 24 hours after infection. The lesion becomes vesicular, with a seropurulent exudate, and then undergoes necrosis. This may be excised and the patient will, in general, recover, or local gangrene may set in followed by a systemic infection and death in 5 to 6 days.

2. *Pulmonary Anthrax (Woolsorter's Disease).* This form is contracted by inhalation or by swallowing spores of *Bacillus anthracis*. The disease is characterized by many of the symptoms of pneumonia and often passes into a fatal septicemia. Before death the organism may be isolated in the sputum.

3. *Intestinal Anthrax.* This form is rare and is contracted by ingestion of uncooked meat of infected animals. There is a severe enteritis with bloody stools and prostration, with death generally. The presence of bacilli in the feces is indicative of this type of anthrax infection.

**Serological Reactions.** Agglutination and precipitation tests have been used to differentiate *Bacillus anthracis* from other members of the aerobic spore-bearing group. The agglutinins produced in response to injections of the organism have given cross reactions with

other members of the group. The performance of the agglutination test with *Bacillus anthracis* is hampered by the difficulty in obtaining homogeneous suspensions.

The formation of precipitins by injection of *Bacillus anthracis* into animals has been utilized by Ascoli in a precipitin test for the diagnosis of anthrax in animals dead of the disease or to detect contamination of hides. The test is carried out as follows:

1. An extract of a small piece of the spleen or other tissue of a dead animal is made by boiling it in saline, cooling, and filtering.
2. The extract is layered on high-titer antiserum.
3. The formation of a zone of precipitate at the junction of the extract and antiserum indicates a positive reaction.
4. The serum for the test should be prepared by immunizing rabbits with a suitable strain of encapsulated anthrax bacilli.

**Diagnosis.** 1. *Collection of Material.* This will depend upon the type of infection—pus or fluid from local skin lesions in malignant pustule, blood in the systemic stage of the disease, sputum in the pulmonary infection, feces in the intestinal infection, or the spinal fluid in the occasional meningeal infections.

2. *Smears* are made and examined for characteristic large, Gram-positive, encapsulated organisms. Blood examinations may give negative results, for the bacilli are not present in the blood in large numbers until shortly before death.

3. *Cultures* are made by inoculating some of the material in broth and on agar plates and incubating.

4. *Animal inoculations* are made as confirmatory tests. The subcutaneous injection of white mice, guinea pigs, or rabbits with a small portion of broth culture, or a suspension made of the growth on nutrient agar, results in the death of the animal in 12 hours to 2 or 3 days with a fatal septicemia, if anthrax bacilli are present. The material isolated from the lesion may be directly inoculated into animals.

**Prophylaxis and Therapy.** General prophylaxis consists chiefly in destruction of infected animals, burying of cadavers, and the disinfection of stables.

1. *Active Immunization of Animals.* The method of Pasteur is still used today. It consists of the subcutaneous inoculation of attenuated cultures of *Bacillus anthracis*. Two vaccines are injected; the first is a culture which has lost its virulence for guinea pigs and rabbits, and is potent only for mice; the second is a culture which is still potent for mice and guinea pigs, but is harmless for rabbits. The second vaccine is given 12 days after the first. Various modifications of this method are in use, but it is still essentially the same.

2. *Serum Therapy.* Inoculation with anti-anthrax serum confers some degree of immunity and has been used for prophylaxis and therapy.

3. *Arsenicals* are frequently used in conjunction with antiserum therapy.

**Related Organisms.** 1. *Bacillus subtilis*, 2. *Bacillus mesentericus*, and 3. *Bacillus mycoides*. These are all aerobic, spore-bearing organisms and may be differentiated from *Bacillus anthracis* in that they are motile and nonpathogenic, usually found in soil and feces.

## PASTEURELLA TULARENSIS

*Pasteurella Tularensis* (*Bacterium Tularensis*). 1. Group—hemorrhagic septicemia. 2. Family—Parvobacteriaceae. 3. Habitat—in ground squirrels, rabbits, hares, and other rodents and may be transmitted to man by bites of insects or by contact with infected animals. 4. Discoverers—McCoy and Chapin, in 1910.

**Morphological Characteristics.** 1. Form—rods which are pleomorphic, with bacillary, coccoid, and bipolar forms. 2. Cell groupings—occurs singly or in pairs, or in short chains. 3. Size— $0.2\mu$  in thickness and from  $0.3$  to  $0.7\mu$  in length. 4. Capsule—organism is enclosed in a capsule which can be demonstrated in films made directly from tissues or when the bacteria are mixed with serum. 5. Staining properties—the organism is stained with carbol fuchsin and gentian violet. 6. Gram-negative and non-acid-fast. 7. Nonmotile. 8. Non-sporing.

**Cultural Characteristics.** *Pasteurella tularensis* does not grow on ordinary culture media. The addition of egg, blood, fresh sterile rabbit spleen, or serum to media is favorable to the growth of the organism. 1. Dorset's egg medium—transparent droplike colonies appear in 3 to 5 days. 2. Egg yolk medium—mucoid minute colonies on the second or third day, becoming larger later. 3. Serum glucose agar—colonies are at first small, but then they appear as droplets. 4. Blood glucose cystine agar—on this medium, which is generally used to cultivate *Pasteurella tularensis*, minute, viscous, easily emulsified, grayish-white colonies develop.

**Physiological Characteristics.** 1. Optimum temperature,  $37^{\circ}\text{C}$ . 2. Aerobic, and facultative anaerobe. 3. Resistance—the organism is destroyed at a temperature of  $56^{\circ}\text{C}$ . for 10 minutes. It is killed by 2% tricresol in 2 minutes, and by desiccation and sunlight in 4 to 5 hours. 4. Slight acid is formed in dextrose, maltose, and mannose.

**Pathogenicity.** The organism is responsible for a disease occurring naturally in rodents, especially the rabbit. The disease in human beings is known as tularemia. It is transmitted by the handling of infected animals. Infection may take place by inoculation, through the unbroken skin, through the conjunctiva, and possibly by inhalation, and also by intermediary infected blood-sucking insects—flies (*Chrysops discalis*), ticks (*Dermacentor andersoni*), lice, fleas, and others. In animals the disease resembles plague and is fatal, but in man it is milder and rarely fatal, although of long duration. In man it is of four clinical types:

1. *Ulceroglandular type* in which the primary lesion is a papule of the skin that later becomes an ulcer and is accompanied by enlargement of the regional lymph glands.

2. *Oculoglandular type* in which the primary lesion is a conjunctivitis with an accompanying enlargement of the regional lymph glands.

3. *Glandular type* in which there is no primary lesion at the site of infection, but there is enlargement of the regional lymph glands.

4. *Typhoid type* in which there is neither a primary lesion nor glandular enlargement.

**Serological Reactions.** In response to infection with tularemia, agglutinins and complement-fixing antibodies are developed. The agglutination test is a valuable diagnostic procedure in tularemia. Since there is some cross agglutination between antiserum prepared against *Pasteurella tularensis* and *Brucella melitensis* and *Brucella*

*abortus*, it is necessary to differentiate the causative agent of tularemia from these organisms. This is determined from the fact that *Brucella melitensis* and *Brucella abortus* agglutinate *Pasteurella tularensis* antiserum to about one-fourth to one-sixth its titer, which may run up to as high as 1:2560 or 1:5120 against *Pasteurella tularensis*. The members of the Brucella group, however, do not absorb agglutinins for *Pasteurella tularensis*. Therefore, a reciprocal absorption test is used to differentiate between them.

**Diagnosis.** 1. *Cultures* are made by inoculating the infected material into blood glucose cystine agar, incubating at 37° C. for from 3 days to 3 weeks, and examining for characteristic colonies.

2. *Animal Inoculations.* The suspected material is inoculated into guinea pigs by rubbing some of the material into the shaven abraded skin or by inoculating it subcutaneously. If *Pasteurella tularensis* is present, the animals will die in 5 to 10 days with characteristic lesions of cervical, axillary, or inguinal buboes, enlarged glands, enlarged spleen, and a granulated liver.

3. *Agglutination Test.* Agglutinins appear in the blood of cases with tularemia after the first week of the disease. The blood is collected at this period and serum dilutions of 1:10 to 1:320 or higher are prepared and tested in 0.5 ml. amounts against 0.5 ml. of a saline suspension of *Pasteurella tularensis*. When agglutination occurs in serum dilution 1:80 or higher, this is considered diagnostic, if there is no cross agglutination with *Brucella abortus* or *Brucella melitensis*.

**Prophylaxis and Immunity.** The disease is preventable in human beings by washing the hands with a strong antiseptic following the handling of wild rabbits, by using rubber gloves when skinning or handling rabbits, and by thorough cooking of rabbits before eating them. One attack confers immunity in man. A toxoid vaccine is reported to have given successful protection. Streptomycin is the best treatment for human tularemia.

**Related Organisms.** 1. *Pasteurella pestis* (plague bacillus), 2. *Pasteurella avicida* (fowl cholera bacillus), 3. *Pasteurella muricida* (septicemia of wild rats), 4. *Pasteurella suilla* (swine plague bacillus), and 5. *Pasteurella bollingeri* (hemorrhagic septicemia in domestic cattle, hogs, and horses).

#### CLOSTRIDIUM SEPTICUM

**Clostridium Septicum** (Vibron Septique, Bacillus Septicus).

1. Group—anaerobic spore-bearers. 2. Family—Bacillaceae.  
3. Habitat—soil, animal intestine, dust, and polluted water. 4. Discoverers—Pasteur and Joubert, in 1877.

**Morphological Characteristics.** 1. Form—rods which are straight or slightly curved. 2. Cell groupings—occurs singly, in pairs, or in chains, and occasionally in long filaments. 3. Size—0.8 to 1 $\mu$  by 3 to 8 $\mu$ . 4. Staining properties—easily stained by aniline dyes. 5. Gram stain—young cultures are Gram-positive, but older ones may be Gram-negative. 6. Motility—motile by four to sixteen peritrichous flagella. 7. Spores—oval, excentric to subterminal, slightly wider than the bacilli, and readily formed. 8. Pleomorphism—the organism has a tendency toward marked pleomorphism in agar cultures



where it may vary in size, shape, and depth of staining; shadow forms are seen.

**Cultural Characteristics.** 1. Agar cultures—spreading, filamentous, translucent colonies which are irregularly round and are grayish in color. 2. Agar slant—slight, spreading, translucent, glistening, grayish-yellow growth, with smooth surface. 3. Deep glucose agar shake tube—delicate, arborescent, and flocculent colonies throughout the medium, with abundant gas formation. 4. Gelatin stab—liquefaction with gas bubbles. 5. Litmus milk—coagulation with formation of acid and gas. 6. Broth—slight turbidity with a powdery deposit. 7. Cooked meat medium—growth is moderate with slight turbidity and gas formation, the meat turning pinkish in color without blackening or digestion.

**Physiological Characteristics.** 1. Optimum temperature, 37° C. 2. Anaerobe. 3. Hydrogen sulfide is formed. 4. Acid and gas are formed in glucose, maltose, lactose, and salicin, but not in mannite or sucrose. 5. Nitrates are reduced to nitrites. 6. Resistance—the spores resist boiling for hours.

**Toxic Products.** A powerful exotoxin is produced by *Clostridium septicum*. The injection of the toxin subcutaneously or intramuscularly does not always produce a fatal reaction but produces local necrosis. The toxin is prepared in a 0.2% glucose broth containing 10% horse serum, the broth being incubated for 24 to 48 hours after inoculation. *Clostridium septicum* also produces a hemolysin which causes hemolysis of human and sheep red blood cells.

**Serological Reactions.** Antitoxins against *Clostridium septicum* are prepared by injecting horses or sheep with the toxin. They are specific against the organism and do not protect against *Clostridium novyi*. By means of agglutination tests, strains of *Clostridium septicum* have been divided into four antigenic groups. There is no cross agglutination between *Clostridium septicum* antiserum and *Clostridium chauvoei*.

**Pathogenicity.** *Clostridium septicum* is the cause of malignant edema, a fatal infection of horses following surgical or traumatic wounds, and occasionally in cattle and sheep. Pathologically, the disease is characterized by edematous, emphysematous swellings, and infiltration of cellular tissues, in which lesions the bacillus is found. In man the virulence of the organism varies greatly with the strain. Some types are almost or completely nonpathogenic. In infections of man it is important as a cause of gas gangrene, although it is much less commonly encountered than is *Clostridium perfringens*. The form of gas gangrene due to this organism differs somewhat from that due to *Clostridium perfringens* in that edema with blood-stained fluid is more marked, and necrosis and gas production are less violent. *Clostridium septicum* is rarely found alone, but pure infections have been recorded.

Experimentally, the organism is pathogenic for guinea pigs, mice, rabbits, and pigeons. An intramuscular injection of 0.01 to 0.5 ml. of a 24 hour culture into guinea pigs produces death in 12 to 24 hours, with edema and gas production.

**Prophylaxis.** Vaccination, using attenuated spores, has proved effective in the hands of some workers. Various investigators have produced antitoxic and antibacterial sera for which both prophylactic and therapeutic value are claimed in the early stages of gas gangrene.

**Related Organisms.** The other members of the anaerobic spore-bearing group of organisms, genus *Clostridium*, are discussed in detail in the chapter dealing with this group. These include: 1. *Clostridium tetani*, 2. *Clostridium novyi*, 3. *Clostridium perfringens*, 4. *Clostridium botulinum*, 5. *Clostridium fallax*, 6. *Clostridium histolyticum*, and 7. *Clostridium lentoputrescens*.

**Differentiation of *Clostridium Septicum* from *Clostridium Chauvoei*.**

1. *Clostridium septicum* frequently infects wounds in animals and man, whereas *Clostridium chauvoei* has not been isolated from wound cultures and has never been found in human infections.

2. *Clostridium chauvoei* ferments sucrose and not salicin, and *Clostridium septicum* ferments salicin and not sucrose.

3. *Clostridium septicum* is more pathogenic for laboratory animals and produces more gas in tissues than does *Clostridium chauvoei*.

4. *Clostridium chauvoei* grows more slowly than *Clostridium septicum*.

#### BRUCELLA GROUP

In the *Brucella* group are included four organisms, *Brucella melitensis*, *Brucella abortus*, *Brucella suis*, and *Brucella bronchiseptica*. All are nonmotile, nonsporing, Gram-negative rods which do not liquefy gelatin, nor ferment carbohydrates. They are strict parasites, producing infection of the genital tract, the mammary gland or the lymphatic tissues, and the intestinal tract.

**A. *Brucella Abortus* (*Bacillus Abortus*, *Alcaligenes Abortus*).**

1. Group—*Brucella*. 2. Family—*Parvobacteriaceae*. 3. Habitat—present in milch cow and the cause of contagious abortion in cattle and undulant fever in man. It also invades mares, sheep, rabbits, and guinea pigs, producing contagious abortion. 4. Discoverer—Bang, in 1897.

**Morphological Characteristics.** 1. Form—short, slender, pleomorphic rods with rounded ends. 2. Cell groupings—occurs singly, in pairs, or in small chains. 3. Size—0.4 by 1 $\mu$ . 4. Staining properties—stains easily with ordinary aniline dyes. 5. Gram-negative. 6. Nonmotile. 7. Nonsporing.

**Cultural Characteristics.** *Brucella abortus* is microaerophilic. It requires 25% CO<sub>2</sub> on primary isolation and 10% CO<sub>2</sub> on subsequent transfers. After prolonged culture, however, the organism grows freely under aerobic conditions. 1. Agar cultures—small, round colonies with smooth, glistening surface and entire edge. 2. Agar slant—slow grayish growth. 3. Gelatin stab—poor growth with no liquefaction. 4. Potato—slight grayish-brown growth. 5. Litmus milk—the medium is rendered slightly alkaline, with no coagulation. 6. Broth—slight turbidity.

**Physiological Characteristics.** 1. Optimum temperature, 37° C. 2. Aerobic, and facultative anaerobe. 3. Hydrogen sulfide is produced. 4. Sugars are not fermented. 5. Resistance—resists cold and drying. Killed at pasteurizing temperatures.

**Pathogenicity.** There are two organisms which have been designated in the literature as *Brucella abortus*. The porcine variety is now called *Brucella suis*. The bovine variety has retained the name *Brucella abortus*. The two organisms are similar in most respects, except that *Brucella suis* requires no added CO<sub>2</sub> for its growth. Both the

porcine and bovine types can cause undulant fever in man after an incubation period of 1 week to several months. There is, typically, a long continued pyrexia, often with remissions, which may be accompanied by joint pains, skin rashes, sweating at night, and other symptoms. Whether or not these organisms are related to cases of miscarriage in human beings has not been determined. *Brucella abortus* has been isolated in several instances where the diagnosis of endocarditis was made.

**Epidemiology.** *Brucella abortus* may appear in the milk of cows that have aborted and may also appear in the milk of cows that are carriers but have suffered no abortion themselves. Human infection may result from attending to infected animals or, at other times, from handling the flesh or drinking raw milk of infected cows.

**Serological Reactions.** Agglutinins and complement-fixing antibodies are produced in response to infection with *Brucella abortus*, and a diagnosis of the disease is often made by ascertaining the agglutination titer of a patient's serum. The finding of an agglutinating titer of 1:80 or 1:100 is usually considered significant. This is not pathognomonic, however, since titers of this magnitude or higher are often encountered in healthy human beings. Therefore, when blood cultures are negative (the disease is one in which septicemia is often present), a positive diagnosis should not be made unless the serum agglutinin titer is at least 1:500.

**Immunity and Prophylaxis.** Calves, nonpregnant cows, and human beings seem to have a high natural resistance. One attack of undulant fever protects against a second attack. It is difficult to ascertain a cure, since remissions occur. Vaccines have been used in cattle, and the results thus far have been inconclusive. Experiments on active immunization of human beings have also given questionable results. The use of immune serum and brucellin has been advocated by many workers, but here again most of the reports have been unconvincing or negative. Recently, cures have been reported in cases treated with sulfanilamide, aureomycin, and chloromycetin.

**B. *Brucella Melitensis* (*Bacillus Melitensis*, *Alcaligenes Melitensis*).** 1. Group—*Brucella*. 2. Family—*Parvobacteriaceae*. 3. Habitat—strict parasite of goats and cause of Malta fever in man and contagious abortion in goats. 4. Discoverer—Bruce, in 1887.

**Morphological Characteristics.** 1. Form—short rods. 2. Cell groupings—occurs singly, in pairs, or in short chains. 3. Size—0.5 to 0.7 $\mu$  wide by 0.6 to 1.2 $\mu$  long. 4. Staining properties—stains well with ordinary aniline dyes. 5. Gram-negative and non-acid-fast. 6. Nonmotile. 7. Nonsporing. 8. Nonencapsulated.

**Cultural Characteristics.** 1. Agar cultures—grayish-white, round colonies about 0.5 mm. in diameter. 2. Gelatin stab—slow growth, with no liquefaction. 3. Litmus milk—medium becomes alkaline. 4. Potato—slight grayish-brown to chocolate-colored growth. 5. Broth—slight turbidity, with no pellicle or deposit.

**Physiological Characteristics.** 1. Optimum temperature, 37° C., with limits of 20° to 40° C. 2. Aerobic. 3. Pigment production—brown pigment on potato and in old agar cultures. 4. No fermentation of carbohydrates. 5. Nitrates are occasionally reduced, with disappearance of the nitrites formed. 6. Resistance—the organism is killed by moist heat at 60° C. in 10 minutes, at 65° C. in 5 minutes, and by 0.5% phenol in 15 minutes. It has good keeping qualities. In the dry state it may survive for 3 months, and hermetically sealed it may remain potent for 6 months at room temperature.

**Serological Reactions.** By agglutination two antigenic groups are distinguishable, the melitensis (smooth) type and the parameli-

tensis (rough) type. Carriers of the disease and those who have recovered have agglutinins and complement-fixing antibodies in their sera. Agglutinin absorption tests are necessary for diagnosis since such antisera will cross agglutinate with *Brucella abortus* and *Brucella suis*. Agglutinins occur in serum about the tenth or twelfth day of the fever. The titer rises to 1:100 and 1:300. Complement fixation is positive in nearly all cases during the fever.

**Pathogenicity.** Malta fever is spread to man by means of goat's milk infected with *Brucella melitensis*. The disease in both goats and man is a bacteremia, and the etiologic agent may be recovered from the blood. In goats, the most obvious clinical symptom is abortion, although this need not occur. Goats may have the disease with the organism circulating in the blood and being excreted in the urine, without the animal's showing signs of the infection. Many goats, however, show evidences of infection by losing weight, developing a cough, and in some instances developing mastitis and arthritis. In man a blood culture is positive in about 80% of the cases after the second day of the disease, which may prevail in the bacteremia form for several months.

**Control of Undulant Fever and Malta Fever.** The prevention of the spread of these infections depends upon the following measures:

1. Eradication of the diseases in herds of cattle, goats, and swine.
2. Proper precautions in handling infected animals, and in so far as possible avoiding contact with them.
3. Pasteurization of milk and milk products.
4. Disinfection and proper disposal of urine and feces of patients.
5. Treatment with the antibiotics aureomycin and chloromycetin in human beings.

**Differentiation of Members of the Brucella Group.** The following table presents a scheme for differentiating *Brucella abortus*, *Brucella suis*, and *Brucella melitensis* from each other.

Species	Infectivity for guinea pigs	CO <sub>2</sub> required for growth	H <sub>2</sub> S formation	Growth on media containing:		
				Thionin 1:50,000	Basic Fuchsin 1:25,000	Pyronin 1:100,000
<i>Brucella melitensis</i>	++	-	±	+++	+++	+
<i>Brucella abortus</i>	+	+	++	-	+++	+++
<i>Brucella suis</i>	++	-	++++	+++	-	-

1. *Brucella melitensis* and *Brucella suis* are more highly infective for guinea pigs than is *Brucella abortus*.
2. *Brucella abortus* when first isolated requires CO<sub>2</sub>, but *Brucella melitensis* and *Brucella suis* may be cultivated under aerobic conditions.
3. *Brucella suis* is the most active producer of hydrogen sulfide, and *Brucella melitensis* may form this gas only slightly.
4. *Brucella melitensis* is not inhibited by either thionin, basic fuchsin, or pyronin. *Brucella abortus* is inhibited by thionin and grows well in media containing basic fuchsin and pyronin. *Brucella suis* grows well in the presence of thionin, but its growth is deterred by basic fuchsin and pyronin.

## THE RICKETTSIAE

The rickettsia bodies were first described by Ricketts in 1909, who found them in the blood of persons with Rocky Mountain spotted fever. They are intracellular parasites whose exact nature is unknown, but they are generally considered intermediate between the bacteria and filterable viruses. They resemble bacteria in shape and may be cocci, diplococci, or short bacilli. They are Gram-negative, nonmotile, nonsporing, nonencapsulated, probably all nonfilterable, and are difficult to stain with ordinary aniline dyes. The Giemsa stain is good for demonstrating these bodies. It is difficult to cultivate the rickettsia bodies, and therefore diagnosis is hampered. The diseases caused by rickettsia bodies are all vectored by intermediate insect hosts of the phylum Arthropoda, such as ticks and lice. The rickettsia bodies are 0.3–0.5 $\mu$  or more in length and about 0.3 $\mu$  in diameter. They have electrophoretic characteristics similar to the bacteria. They are thermolabile and killed by dehydration or chemical antiseptics. Electron microscopic examination of the rickettsia bodies reveals a homogeneous or slightly granular internal structure closely resembling that of the bacteria. Like the viruses, the pathogenic Rickettsiae are true parasites and can be cultivated in the intestines of rats, ticks, and lice, in tissue cultures, and in the membranes of chick embryos.

The natural habitat of the Rickettsiae appears to be the cells lining the intestine and other tissues of insects, both blood-sucking and non-blood-sucking.

**Diseases.** The majority of known rickettsial diseases fall into three classes: typhus fevers, spotted fevers, and tsutsugamushi. Clinically they are similar in many respects—fever, skin rashes or dark blotches due to multiplication of organisms within the endothelial cells of small blood vessels, and brain involvement.

### TYPHUS FEVERS

Typhus fever, a disease of filth and famine, is known by various names in different parts of the world. It has been generally believed to manifest itself in two main types: (1) *Murine, rat, or endemic typhus*, caused by *Rickettsia prowazeki* var. *mooseri* and transmitted from rat

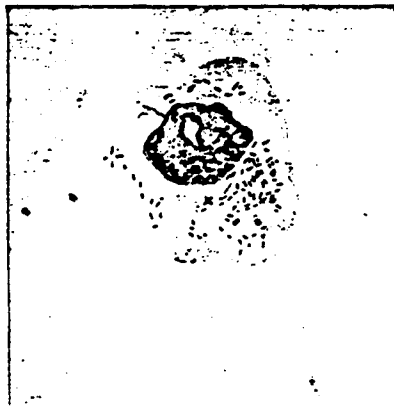

to rat by the rat flea and rat louse and from rat to man usually by the rat flea. This is the form that prevails in the southern United States and in Mexico, where it is known as *tabardillo*. It has also been termed *shop*, *Toulon*, *Moscow*, and *Manchurian typhus*. It appears sporadically and has a mortality below 5%. (2) *Human, European, or epidemic typhus*, caused by *Rickettsia prowazeki* var. *prowazeki* and spread from man

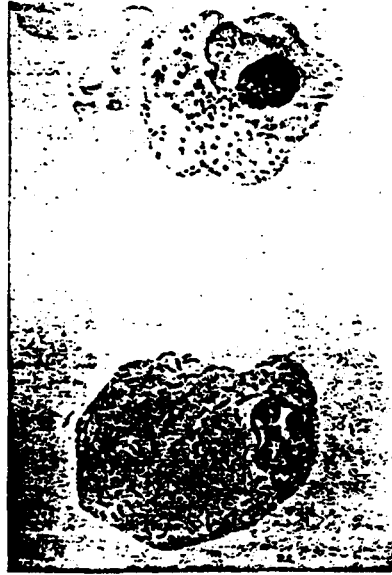

Courtesy, W. B. Saunders Co.

FIG. 64. Rickettsiae in the cells of a guinea pig. (Redrawn from Monteiro, in Martin Frobisher, Jr., *Fundamentals of Bacteriology*, 1949.)

to man by the body louse and possibly the head louse. It is highly communicable and has a mortality of 20-70%. *Brill's disease* is a mild type of louse-borne European typhus endemic in Atlantic coast cities.

The disease is characterized by initial violent headache, nausea, dizziness, alternate chills and fever, and a typical rash. Complications include typhus gangrene, severe bronchopneumonia, otitis media, and typhus encephalitis. Clinically the two forms are not very different; both may exist in endemic and epidemic form with corresponding mildness and fatality. Typhus is also a disease of lice, causing them to sicken and die.

The organisms occur in the cytoplasm but not the nucleus of invaded cells. Blood of the patient is infectious, but organisms have not been seen in the blood.

**Weil-Felix Reaction.** The serum of persons with typhus fever contains agglutinins against certain *Proteus* strains, the most famous of which is *Proteus* OX19, isolated by Weil and Felix from the urine of typhus fever patients. The agglutination reaction of the serum in dilutions of 1:50 to 1:50,000 is diagnostic for typhus fever. The *Proteus* X strains are not related to typhus fever in an etiologic sense, for they are rarely found in cases of the disease and experimental inoculation of these organisms does not produce the disease. *Proteus* strains do not immunize against Rickettsiae, nor does recovery from rickettsial infection immunize against experimental *Proteus* infection. Zinsser and associates have suggested that the rickettsia bodies and certain *Proteus* strains contain a common antigen component.

**Prophylaxis.** The prevention of typhus fever lies in the eradication of lice, especially when people are confined in close quarters such as jails and trenches, and particularly in keeping lice away from known typhus cases. Cleanliness, repellents, and delousing procedures are useful. DDT (dichloro-diphenyl-trichloroethane) appears promising. (See following section on vaccines.)

**Immunity and Therapy.** Recovery from either form of typhus fever results in lasting immunity to both. Massive doses of vaccines of killed organisms have been fairly successful in producing active immunity. The vaccine, formerly prepared by growing the organisms in lice and using the ground intestine by tissue culture in guinea pig testes, or made from the lungs of infected rats, has been recently produced from growth of the organism in developing chick embryos. By the latter means, Bengston and Dyer of the United States Public Health Service have obtained a preparation free from bacteria and insect material.

The serum of immunized goats or rabbits is being tried therapeutically and may prove useful. Chloromycetin and aureomycin are proving clinically effective according to widespread reports.

**Diagnosis.** The Weil-Felix reaction is the main diagnostic tool. Complement fixation is also used in differentiating typhus, especially the murine type, from spotted fever. The U.S.S.R. Institute of Experimental Medicine has recently reported a complement fixation test claimed to be very sensitive, strain-specific, and applicable as early as the first and second days of illness. Animal inoculation is also employed.

#### SPOTTED FEVERS

These are diseases similar to typhus fever and characterized by petechial hemorrhages into the skin together with a rash and an incubation period of 3 to 9 days. The disease is transmitted from tick to tick hereditarily and to man by the tick. It is not transmitted from man to man, as is typhus fever (see p. 280). The disease is innocuous for ticks. It is most prevalent in the northwestern United States. The causative agent, *Rickettsia rickettsi* (also known as *Rickettsia dermatroxenus*), can be transmitted experimentally to monkeys, guinea pigs, rabbits, and dogs. It is found within the nucleus of the invaded cell.

The disease has, with questionable correctness, usually been classified into three very closely related types, all immunologically identical and caused by the same organism. One occurs in the eastern states and is transmitted chiefly by the dog tick, *Dermacentor variabilis*; one in the western states, particularly Bitter Root Valley, Montana, and transmitted by the sheep or wood tick, *Dermacentor andersoni*; and one in Brazil (*typho-exanthematico*) transmitted by *Amblyomma cajennense*. In the United States, the disease is known as *Rocky Mountain spotted fever*. The mortality is very variable but runs nationally about 19%. The mortality in Brazil is about 70%. Other spotted fevers include *Fièvre Boutonneuse*, *Kenya fever*, *South African tick-bite fever*, *São Paulo typhus*.

After the first week of the disease, the Weil-Felix agglutination test is positive. The serum usually has a titer ranging from 1:20 to 1:200, not as high as in typhus fever.

**Immunity and Prophylaxis.** One attack of spotted fever usually confers lifelong immunity. There is a slight cross protection between typhus and spotted fevers. Immunization with massive doses of vaccines of killed organisms has been fairly successful. As with typhus, these were formerly prepared from infected insects and now from tissue cultures or preferably from chick embryos. Measures to minimize contact with ticks are, of course, mandatory. These include wearing of tick-proof clothing, eradication of ticks by brush clearing, and removal of ticks from the body as quickly as possible.

#### TSUTSUGAMUSHI FEVERS

This is a group of similar febrile diseases resembling typhus fever and occurring in Japan and adjacent lands. The causative agent is *Rickettsia tsutsugamushi* (also known as *Rickettsia orientalis* or *Rickettsia nipponica*), which is transmitted to man by the bites of mite larvae occurring in swampy areas. The larvae become infected from infected adults through the eggs. The adult mites do not bite mammals. In addition to the typical rickettsial symptoms of headache,

nausea, and chills and fever, there is a primary sore at the site of the bite. The animal reservoirs are mice and rats. Mortality may run to 50%.

One attack confers prolonged but not absolute immunity. Serum of tsutsugamushi patients gives a high-titer agglutination Weil-Felix reaction with the Proteus OXK strain, which is derived from OX19 by variation.

Besides the tsutsugamushi disease, there are also included in this group the probably identical *mite fever* of Sumatra and the milder *rural or scrub typhus* of Malaya.

#### MISCELLANEOUS DISEASES

**Trench Fever.** This disease, also known as Wolhynian fever, is characterized by sudden onset with fever, headache, and pains in the muscles and bones, especially in the legs. There are frequent remissions and relapses. The disease is caused by *Rickettsia quintana* (*Rickettsia wolhynica*, *Rickettsia pediculi*) and is transmitted from man to man by lice. It is rarely fatal.

**Q Fever.** This is caused by a filterable *Coxiella burnetii* (*Rickettsia diaporica*), with transmission possibly by tick or by air. There is high fever, no rash, no Weil-Felix reaction. There have been no fatalities. The disease has been found especially in slaughterhouse workers and dairy farm workers in Australia. *Nine-mile fever*, found in Montana, is believed identical.

**"Heartwater" Disease.** Also known as *Veldt disease*, this is a highly fatal, economically important, tick-borne disease of cattle, sheep, and goats in South Africa. The causative organism is *Cowdria ruminantium*.

**Bullis Fever (Lone Star or Tick Fever).** This is a relatively mild, Weil-Felix negative disease which has been observed in soldiers stationed in Texas. It is believed to be caused by *Rickettsiae* and transmitted by ticks.

#### BIBLIOGRAPHY

- Bergey, David H. *Bergey's Manual of Determinative Bacteriology*. Sixth Edition. Baltimore: Williams & Wilkins Company, 1948.
- Gershenfeld, Louis. *Bacteriology and Allied Subjects*. Easton, Pa.: Mack Publishing Company, 1945. Pp. 233-238.
- Hagan, W. A. *Infectious Diseases of Domestic Animals*. New York: Comstock Publishing Company, 1943. Pp. 342-344.
- Harvard School of Public Health. *Virus and Rickettsial Diseases*. Cambridge, Mass.: Harvard University Press, 1940.
- Holmes, W. H. *Bacillary and Rickettsial Infections*. New York: Macmillan Company, 1940.
- Parish, H. J. *Bacterial and Virus Diseases*. Baltimore: Williams & Wilkins Company, 1948. Pp. 1-157.
- Pinkerton, Henry. "The Pathogenic Rickettsia." *Bacteriological Review*, 6:37-78, 1942.
- Rivers, T. M. *Viral and Rickettsial Infections of Man*. Philadelphia: J. B. Lippincott Company, 1948. Pp. 1-97.
- Streat, L. P. *Oral Bacterial Infections*. Brooklyn, N. Y.: Dental Publishing Company, 1949. Pp. 147-150.
- Strong, R. P. *Still's Diagnosis, Prevention, and Treatment of Tropical Diseases*. Philadelphia: The Blakiston Company, 1945. Pp. 872-923.
- Sulzberger, M. B., and R. L. Baer. *Office Immunology*. Chicago: Yearbook Publishers, 1947. Pp. 130-140.
- Zinsser, H., and J. T. Enders. *Immunity*. New York: Macmillan Company, 1939. Pp. 440-462.



## THE VIRUSES

The viruses are minute disease-producing agents, usually termed filterable because they pass through fine filters capable of holding back bacteria, and ultramicroscopic because they are not visible with the light microscope. No acceptable definition of these bodies, whose existence was first indicated in 1892 by Iwanowski's work on tobacco mosaic disease, can yet be advanced. Their nature, structure, and mode of activity are still incompletely known, although the sizable body of knowledge concerning them is constantly being enlarged.

### GENERAL CHARACTERISTICS

**Visibility.** Viruses cannot be seen with the light microscope. Some can be photographed under the electron microscope (Figs. 65 and 66). These pictures have revealed bodies which may be the

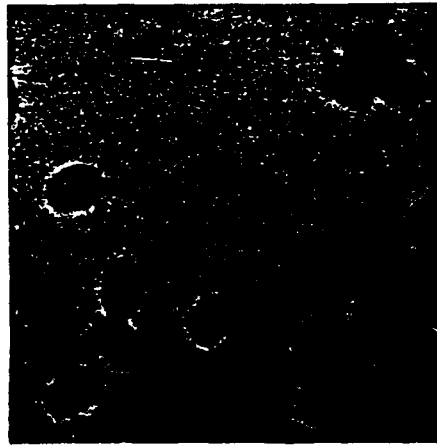

*Courtesy, R.C.A.*

FIG. 65. Electron micrograph of elementary bodies of vaccinia virus. ( $\times 23,000$ .)

vaccinia virus as uniform rectangular particles, containing five areas of condensation. Needle-like crystals, inseparable from the ability to produce the disease, probably represent the virus of tobacco mosaic.

**Filterability.** Viruses generally pass through filters capable of holding back bacteria. This ability, however, is relative and dependent on the size of the virus and the filter pore, the nature of the filter, and undoubtedly other factors, such as the medium, temperature, electrical charge, etc.



*Courtesy, R. C. A. (Williams & Wychoff).*

FIG. 66. Electron micrograph of shadowed tobacco mosaic suspension. ( $\times 60,000$ .)

*Bacterial filters* are usually made of unglazed porcelain, kieselguhr (diatomaceous earth), or asbestos, and are available in different sizes and degrees of porosity. 1. *Berkefeld filters*, made of kieselguhr, asbestos, and organic matter, are available in three grades: V (viel), relatively coarse, approximate porosity 8–12 $\mu$ ; N (normal), intermediate, approximate porosity 5–7 $\mu$ ; W (wenig), fine, approximate

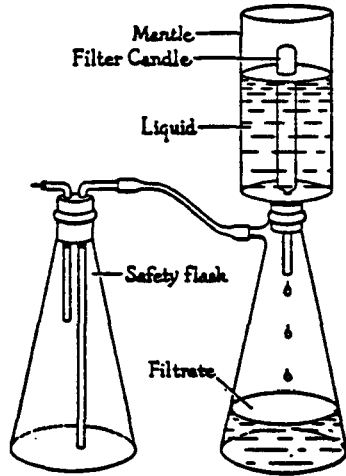

FIG. 67. Berkefeld filter set up for use.

porosity 3–4 $\mu$ . 2. *Pasteur-Chamberland filters*, made of unglazed porcelain from kaolin and sand, in the form of candles, are marketed in grades L<sub>1</sub>, L<sub>2</sub>, L<sub>3</sub>, L<sub>4</sub>, L<sub>5</sub>, L<sub>6</sub>, L<sub>7</sub>, L<sub>8</sub>, L<sub>9</sub>, and L<sub>10</sub>, running from coarsest to finest. 3. *Mandler filters*, made of diatomaceous earth, plaster of Paris, and asbestos, are available in preliminary, regular, and fine grades. 4. *Seitz filters* are asbestos discs.

Besides being used to separate filterable viruses, bacterial filters are used to separate exotoxins or other filterable material from bacterial cultures and to sterilize certain preparations easily destroyed by heat, such as sugar solutions, antitoxins, etc. Extreme care must be used to guard against contamination.

**Parasitism.** All known viruses are obligate parasites requiring liv-

ing cells for their cultivation. Some have been cultivated outside the body in the developing chick embryo or in tissue culture.

Viruses usually exhibit a marked but not absolute selectivity for certain tissues. On the basis of their *primary* tissue predilection, the viruses may be classified as follows:

1. *Neurotropic* — predilection for central nervous system, such as viruses of rabies, poliomyelitis, encephalomyelitis, lymphocytic choriomeningitis.
2. *Dermatropic* — predilection for the skin, such as viruses of vaccinia, variola, alastrim, varicella, molluscum contagiosum, verruca, herpes zoster, herpes simplex, trachoma.
3. *Pneumotropic* — predilection for respiratory tract, such as viruses of influenza, rubella, rubeola, psittacosis, common cold.
4. *Viscerotropic* — predilection for abdominal or thoracic viscera or produce signs of generalized infection, such as virus of yellow fever.
5. *Miscellaneous* — such as viruses of lymphogranuloma inguinale, parotitis, etc.

**Inclusion Bodies.** In the lesions produced by some viruses there are certain intracellular masses, termed *inclusion bodies*, which are often of diagnostic value. They may be cytoplasmic (Fig. 68) or intranuclear (Fig. 69). Typical are the *elementary bodies* of vaccinia and the *Negri bodies* of rabies. Their exact nature is disputed. Some believe them to be aggregations of the virus itself, and others consider them to be the reaction of the cell towards the virus.

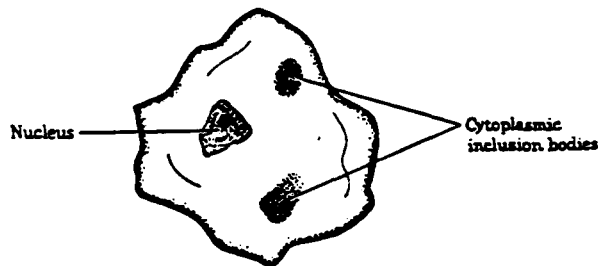

FIG. 68. Cytoplasmic inclusion bodies.

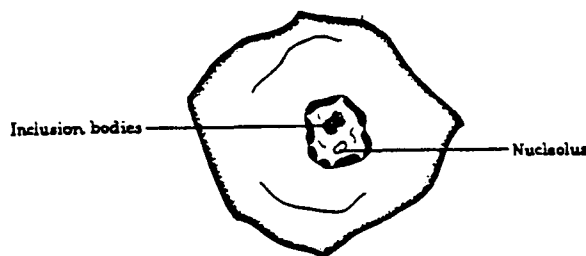

FIG. 69. Intranuclear inclusion bodies.

**Immunity.** Recovery from a virus infection produces usually a solid and lasting, but sometimes a transient, immunity. Second attacks of yellow fever, poliomyelitis, hog cholera, smallpox, or measles are very rare. Immunity of about a year results from foot-and-mouth disease, dengue fever, and pappataci fever. In fever blisters and common colds, immunity is very short. There is some evidence to indicate that lasting immunity when present is an infection-immunity or immunity to superinfection. Viruses have been shown to persist in the body a long time after recovery.

Various familiar immunizing substances—agglutinins, precipitins, neutralizing antibodies—have been identified in circulating blood, and the general nature of the immunity is believed the same as in other infections. However, the effectiveness of circulating antibodies against intracellular viruses has not been fully determined. Active artificial immunity is highly successful with many virus diseases. The *serum neutralization test* is often used for study and diagnosis, e.g., poliomyelitis, influenza, vaccinia. This determines the protection afforded susceptible animals by mixtures of immune serum and virus in contrast to the development of disease in animals inoculated with normal serum and virus or virus alone.

**Adaptability.** This ability, characteristic of living things, is also an attribute of viruses. For example, rabies virus grown in dogs is very virulent for both dog and man. If cultivated in rabbits, however, the virus becomes attenuated for dog and man and virulent for rabbits. Similarly, the selective tissue action of viruses can be modified by inoculation into an abnormal portal of entry.

**Resistance.** A striking characteristic of most viruses is resistance to 50% glycerin, a property shared by only a very few bacteria. Viruses may be preserved in 50% glycerin at icebox temperatures or by the lyophil process (drying and freezing). They are heat labile and also readily inactivated by direct sunlight.

**Size.** By means of collodion membranes (gradacol membranes or ultrafilters) of graduated and standardized porosities, electron microscope studies, and ultracentrifugation, viruses have been shown to vary greatly in size but to be relatively uniform within each "species." They range from about 275  $m\mu$ \* for psittacosis, 175  $m\mu$  for vaccinia to 22  $m\mu$  for yellow fever and 12  $m\mu$  for poliomyelitis. (The diameter of *Micrococcus* is about 800  $m\mu$ .)

**Composition.** In 1935, Stanley succeeded in preparing crystalline, disease-producing nucleoproteins, considered to be the viruses of

\*  $m\mu$ —millimicron or the thousandth part of a micron.

tobacco and cucumber mosaic diseases. From this and other work, the belief is now held that the smaller viruses are nucleoproteins and the larger viruses like vaccinia contain nucleoprotein, fat, and carbohydrate.

#### NATURE OF VIRUSES

The challenge of the nature of the material known as viruses has been met with a number of suggested explanations. The first-discovered virus of tobacco mosaic disease was believed by Beijerinck (1899) to be a living contagious fluid, by Wood (1899) an oxidizing enzyme, by Goldstein (1927) a protozoan parasite, by Vinson (1931) an inanimate chemical substance. Others have postulated that viruses are infinitesimally small living organisms or that they are autocatalytic substances producing disease and manufactured in certain injured and stimulated host cells. Gordon (in Jordan and Burrows) makes two pertinent points: 1. the distinction between animate and inanimate matter may prove pointless as regards the viruses, and 2. it is unnecessary and undesirable to assume that all viruses are of essentially the same nature. Both he and Rivers suggest that the very small viruses may be inanimate and the larger ones micromicrobes.

Antibiotics block bacterial metabolism and prevent the assimilation of amino acids in the synthesis of bacterial protoplasm. The smallest viruses are presumed to be nucleoprotein molecules and are thus unable to carry out metabolism; they therefore resist antibiotic action. Antibiotic action against virus diseases appears clinically proportional to their size. The larger the virus, the more susceptible it is to antibiotic action. No chemotherapeutic or antibiotic agent is effective against the bulk of disease-causing viruses which are medium to small in size.

#### VIRUS DISEASES OF MAN

Of the many virus diseases that affect man, the following list includes the most important known to date:

Variola or smallpox	Rabies or hydrophobia
Vaccinia or cowpox	Anterior poliomyelitis or infantile paralysis
Alastrim	
Varicella or chickenpox	Epidemic encephalitis, including St. Louis encephalitis and Japanese encephalitis Type B
Herpes zoster	
Herpes simplex	
Molluscum contagiosum	Australian X disease
Verruca or warts	Equine encephalomyelitis
Rubeola or measles	Lymphocytic choriomeningitis
Rubella or German measles	Yellow fever
Epidemic influenza	Pappataci fever or sandfly fever
Common cold	Dengue or breakbone fever
Parotitis or mumps	Rift Valley fever
Psittacosis or parrot fever	Trachoma
Lymphogranuloma venereum	Inclusion blenorhea
	Epidemic keratoconjunctivitis

**Variola or Smallpox and Vaccinia or Cowpox.** These two diseases are of historical interest because they were the first for which an effective method of vaccination was devised. In 1798 Jenner reported that a boy inoculated with material taken from a dairymaid infected with cowpox failed to develop smallpox when inoculated with pus obtained from smallpox lesions. Thus Jenner put into practical application his observation that the incidence of smallpox was relatively low among persons who lived in rural districts and came into contact with cows.

Smallpox and cowpox are closely related. An attack of one protects against the other. It is believed by some that vaccinia or cowpox virus is smallpox virus attenuated by passage through cattle.

Smallpox is a generalized, febrile disease characterized by vesicular eruptions which become pustular and crust, often leaving permanent pox marks. The incubation period is 6 to 15 days. Fatality is usually 10-30%. Transmission is by direct or indirect contact. Infectivity is high, starting in the incubation period and lasting well into convalescence. The skin lesions and respiratory discharges contain the virus. Vaccinia in man, produced by smallpox vaccination, is a mild and usually local disease.

1. *The Virus.* The virus passes through most filters, is resistant to low temperatures, glycerin, phenol, and ether, but is heat labile—a temperature of 55° C. or over destroys it. It has been estimated to be 125 to 175  $\mu$  in size. Cytoplasmic inclusions, called Guarnieri or vaccinia bodies, may be found in epithelial cell lesions. In addition, small Paschen or elementary bodies may be demonstrated in vesicular fluid. These are believed to represent the virus.

2. *Pathogenicity.* Various animals, including horses, sheep, and cows, are susceptible to pox diseases.

3. *Laboratory Diagnosis.* Several laboratory procedures are available to differentiate smallpox from other diseases with which it may be confused. Unfortunately, these tests do not distinguish between smallpox, vaccinia, and alastrim. They include:

(a) *Paul Test.* When the scarified cornea of a rabbit is inoculated with material from a suspected lesion, a typical keratitis, in which Guarnieri bodies are demonstrable microscopically, is observed if the lesion was smallpox. The test is positive in about 50% of the cases.

(b) *Budding's Test.* Material taken from smallpox lesions is inoculated on the chorio-allantoic membranes of the developing chick embryo. The production of typical pox lesions within 72 hours, smears of which show typical lesions and Paschen bodies, is indicative of smallpox. This test is believed to be more reliable than the Paul test.

(c) *Intradermal Test.* A normal rabbit inoculated intradermally with material from smallpox lesions develops swelling on the second day, proceeding to crust formation and desquamation. An immune animal will develop no such lesion or only a slight response.

4. *Vaccines.* The vaccine most generally employed is that prepared from calf lymph (serum from pustules) obtained by rubbing vaccinia virus into the scarified abdomen of calves. The scarified areas are scraped off 5 days later, using sterile precautions. The pulp is mixed with twice its weight of sterile water and forced through metal sieves. The emulsion of finely divided tissue is mixed with 50% glycerin. Phenol up to 1% or brilliant green dye 1:10,000 is added to reduce bacterial contamination. The pulp is stored at 10° C. Potency tests are made, and cultures are prepared to exclude the presence of contaminants such as Micrococci, Streptococci, and anaerobic bacilli.

More recently introduced are vaccines prepared from virus grown in tissue culture or in the developing chick embryo. These, being bacteria-free, can be injected intradermally and produce immunity without scar formation.

5. *Methods of Vaccinating.* The site to be vaccinated is cleansed with soap and water, wiped with alcohol, and allowed to dry. The methods used for vaccination include:

(a) *Incision or Linear Abrasion Method.* This was first described by Jenner. The skin of the arm is stretched by grasping the underside of the arm. A scratch about one-eighth of an inch is made with the point of a sterile needle. Care should be taken not to draw blood. A drop of vaccine is applied with a wooden applicator and rubbed into the scratch for about 15 seconds and then allowed to dry. The drop of vaccine may be put on the skin first, then the scratch may be made and the vaccine rubbed in with the side of the needle or a sterile toothpick.

(b) *Multiple Pressure Method.* A drop of vaccine is applied. With a sharp, sterile needle held parallel to the skin, the operator presses the side of the needle point firmly and rapidly into the drop about 30 times in about 5 seconds. An area not more than one-eighth of an inch in diameter is covered, and if the skin has not been rubbed too much in cleansing and if the pressure has been applied perpendicular to the needle, no blood is drawn. After the pressures have been made, the remaining vaccine is wiped off the skin carefully with sterile gauze. This method is favored at present because it results in a minimum scar and is apparently less liable to bacterial infection.

(c) *Drill Method.* The epidermis is perforated with a steel drill having a sharp cutting edge 2 mm. in width and a tip which is sterilized by flaming. The flake of epidermis is removed with a single rotary turn and the vaccine is dropped on the circle exposed and rubbed in with a sterile toothpick. The operation should cause no bleeding.

(d) *Intracutaneous Method.* With the use of a hypodermic syringe about 0.1 ml. of material, tissue-cultured vaccine in most cases, is injected intracutaneously. The ordinary glycerinated virus diluted with 1 part of sterile distilled water has been used when success was not obtained with ordinary scarification methods.

6. *Vaccination Reactions.* These are of four types:

(a) *Primary Vaccinia.* This reaction is observed in persons who have never been vaccinated or who have not had smallpox. It may also be elicited in those in whom immunity against smallpox from previous vaccination has disappeared. About the fourth day a papule appears which quickly develops into a vesicle surrounded by a narrow zone of redness. This gradually enlarges and begins to spread about the seventh day, and reaches its height about the tenth to fourteenth day, after which it recedes. The vesicles dry up, and a scab is formed which falls off about the twenty-first day, leaving a scar.

(b) *Vaccinoid or Accelerated Reaction.* Persons who have a partial immunity from a previous vaccination or an attack of smallpox give this reaction, in which all the stages of a primary vaccinia, but milder and having a more rapid course, are observed.

(c) *Immune Reaction.* Persons who have had smallpox or those protected by previous vaccination give a reaction characterized by redness with some elevation in 24 to 48 hours, occasionally 72 hours, with itching and no vesicle formation. No scar or scab results after the quick fading of the redness. The reaction is indicative of complete protection.

(d) *Negative Reaction.* Revaccination is advised when no reaction is observed. Three failures to respond are considered as proof of immunity when the vaccine used is known to be potent.

7. *Immunity.* An attack of smallpox or cowpox confers immunity. Protection for one year or several years is afforded by vaccination with vaccinia virus. Following exposure the individual should be revaccinated. Persons immune to variola have antibodies (neutralizing, complement-fixing, agglutinins, and precipitins) demonstrable in their sera.

**Alastrim.** This is a disease which resembles a mild attack of smallpox. It is believed to be related to smallpox since it protects against smallpox, and an attack of smallpox protects against alastrim. Vaccination confers protection against both.

**Varicella or Chickenpox.** This is a rather mild, highly contagious disease characterized by fever and the appearance of vesicles after an incubation period of 14 to 21 days. The disease has been shown to be distinct from smallpox, with which it may be confused clinically in the early stages. An attack of chickenpox does not protect against smallpox, nor does smallpox confer immunity against chickenpox.

Elementary bodies which are agglutinated in convalescent serum are present in vesicle fluid.

Chickenpox is believed by some investigators to be related to herpes zoster, for cases have been reported of children who developed chickenpox on contact with herpes zoster. Complement-fixing antibodies against fluid from herpes zoster and varicella vesicles have been found in the sera of patients with herpes zoster and varicella. Some cross agglutination has been observed. One attack of varicella usually protects against subsequent infection.

**Herpes Zoster.** This disease, also termed shingles or zona, is an acute dermatropic virus disease characterized by a vesicular dermatitis in which the vesicles follow a nerve trunk. The virus has as yet not been transmitted to any experimental animals with filtered material. Inclusion bodies have been described in cases of herpes zoster. One attack confers a lasting immunity.

**Herpes Simplex.** This is a mild, dermatropic, acute, eruptive, virus disease of the skin and mucous membranes characterized by vesicles containing serous fluid, with subsequent scab formation but no scars. Vesicles on the lips and nostrils (cold sores), on the genitalia, or associated with fevers (herpes febrilis, fever sores) are most common. The vesicles usually appear within 24 to 48 hours, and last about 7 to 14 days. Herpetic infections have been reported following contact, local irritation, exposure to cold, heat, ultraviolet light, and other factors, dependent largely on the individual. Intranuclear inclusion bodies have been described in the lesions. Herpes virus is filterable through Berkefeld V and N candles. It is about 150  $\mu$  in size, and is thermolabile, for a temperature of 50° C. destroys it. It may be cultivated in tissue cultures and in the developing chick.

When inoculated onto the scarified surface of a rabbit's cornea, a keratitis is produced. Virulent strains may become neurotropic. A fatal encephalitis has been produced in rabbits, and the intracerebral injection of herpes virus into mice produces characteristic transmissible encephalitis.

Infection with herpes simplex virus differs from most virus diseases in that the duration of immunity is uncertain or, at best, of short duration. Neutralization tests have demonstrated that the serum of persons recovering from herpes have neutralizing antibodies. Complement fixation antibodies also have been found. Antibodies have been noted in the serum of persons who paradoxically develop herpes simplex, perhaps indicating a persistent latent infection.

**Molluscum Contagiosum.** This is a children's disease characterized by benign, epithelial nodules formed around the face or on the mucous membrane of the genitalia, and transmitted by contact. Inclusion bodies, which are believed to contain the elementary bodies, are noted in the cytoplasm. The disease has been experimentally transmitted to man.

**Verruca or Warts.** This disease is characterized by benign papilloma of the skin. Emulsions made of wart tissue have produced warts in human beings injected intradermally, after an incubation period of 4 weeks. Warts contain intranuclear inclusion bodies.

**Rubeola or Measles.** This is an acute, infectious disease of childhood, characterized by fever, catarrh, coryza, Koplik spots on the buccal mucous membrane, and papular rash which spreads over the surface of the body, with a final desquamation or scaling of the epidermal cells. Secondary invaders may account for the dangerous sequelae, such as bronchopneumonia, endocarditis, meningitis, etc. This disease has an incubation period of 10 to 14 days, and one attack usually confers a lasting immunity. Filtered nasopharyngeal washings and blood of patients at the height of the disease have been injected into monkeys, with the development of measles-like eruptions.

Convalescent serum, pooled adult serum, parental whole blood, and placental extract have been used both therapeutically and prophylactically to afford complete temporary protection or to assure an attenuated form of the disease and resultant immunity in those exposed to infection.

**Rubella or German Measles.** This disease is similar to measles, from which it may be differentiated by a longer incubation period of 10 to 21 days; a short prodromal period, and absence of Koplik spots. The disease runs a benign course and is conspicuous by a complete absence of complications and sequelae. The etiological agent has not been isolated, but many believe it to be a virus. One attack of the disease confers immunity.

**Epidemic Influenza.** This disease was believed to be caused by *Hemophilus influenzae* or the Pfeiffer bacillus, until 1933, when a virus was isolated from the throat washings of patients suffering from influenza. Intranasal instillation of filtrates of these washings produced in ferrets a disease characterized by fever, nasal congestion and discharge, and a mononuclear pneumonia after the virus had been passed repeatedly. The virus is transmissible to white mice. It has been cultivated in tissue cultures of Tyrode's solution and minced chick embryo, and on the chorio-allantoic membrane of developing chick embryos.

The virus has been estimated to be about 70 to 100  $m\mu$  in size. It resists freezing for about 2 weeks, and retains its potency in glycerin for the same length of time. When dried and frozen by means of the lyophile apparatus, it remains potent in mouse lungs after 6 weeks in the refrigerator.

Strains of influenza virus have been isolated during epidemics in Philadelphia, Puerto Rico, Australia, Alaska, and Leningrad. These strains have been found to be related to one another, although some differences have been reported.

Neutralizing antibodies against influenza virus are present in a large proportion of normal individuals, and following an attack of influenza there is a rise in the titer of such antibodies. Complement-fixing antibodies also have been demonstrated. An *in vitro* test is based on *Hirst's phenomenon*, the ability of influenza virus to agglutinate chicken erythrocytes mixed with it. The reaction is prevented by immune serum. An attack of influenza results in only a temporary immunity. Active immunization with influenza vaccine



has generally given inconclusive results. Army experience, however, was rather successful with the administration of poly-valent, formolized influenza vaccine, and some industrial plants have reported favorably on influenza vaccination.

**Common Cold.** This is an acute, frequently epidemic, highly communicable disease transmitted by droplet infection. It is characterized by catarrhal inflammation of the nose, throat, trachea, nasopharynx, and upper bronchi. Numerous microorganisms, including pneumococci, *Hemophilus influenzae*, and others, have been considered the etiologic agents from time to time.

Filtrates of nasal secretions of persons with colds have produced infection in human volunteers inoculated intranasally. Clinical symptoms similar to those observed in man have been incited in chimpanzees with such filtrates, and it was possible to transmit the infection from ape to ape.

A virus, believed to be the cause of common cold, has been cultivated in tissue culture. Colds were produced in human volunteers inoculated with the culture. It is believed that the evidence for a virus etiology of common cold is substantial. Vaccines of bacteria have been found to be of debatable value when used prophylactically or therapeutically.

**Parotitis or Mumps.** This is an acute, communicable disease characterized by inflammation of the parotid or other salivary glands and frequent involvement of the testes and meninges. The disease is transmissible to monkeys. The production of orchitis and parotitis has also been reported in cats. One attack usually confers a lasting immunity. Convalescent serum has been used prophylactically during the incubation period.

**Psittacosis or Parrot Fever.** This is a communicable disease of parrots transmissible to man through the respiratory tract by direct or indirect contact. It is caused by a virus with an affinity in parrots for the liver and spleen. The intranasal or intramuscular injection of the virus produces the disease in parrots. These animals after recovery are refractory to subsequent infections. The disease is transmissible to mice, guinea pigs, rabbits, and *Macacus rhesus* monkeys.

In man the virus produces a pneumonia, after an incubation period of 10 to 30 days, and the virus may be demonstrated in the sputum and blood. The sputum may be inoculated intraperitoneally into white mice. The development by the animals of an illness which is fatal usually within 5 to 14 days, and occasionally not before 30 days, is diagnostic. Lesions are found in the liver and spleen. Cytoplasmic inclusion and elementary bodies are also demonstrable in infected material. They are small, coccoid forms arranged singly and in pairs, and are believed to be one stage in a developmental cycle.

In monkeys intracerebral inoculation causes a meningo-encephalitis.

One attack of the disease usually produces an active immunity lasting for some time. Complement-fixing and neutralizing antibodies are demonstrable in the sera of vaccinated and convalescent individuals. Intramuscular injections of fresh, unattenuated virus result in successful immunization.

**Lymphogranuloma Venereum.** Also known as lymphogranuloma inguinale, this is a human contagious disease acquired by sexual contact and characterized by inflammation of the lymphatic glands of the inguinal region and development of small herpetiform lesions on the external genitalia. Intracerebral inoculation of monkeys and mice with suspensions of gland tissue result in meningo-encephalitic lesions. Cats have also been experimentally infected. The virus is filterable through Chamberland L<sub>3</sub> and Berkefeld V filters. It may be preserved by freezing at  $-2^{\circ}$  to  $-3^{\circ}$  C. for about 10 days, but is destroyed by heating at  $60^{\circ}$  C. for 30 minutes. Elementary bodies and a developmental cycle similar to the psittacosis virus have been observed.

The disease may be diagnosed by a skin test known as the *Frei test*, performed by injecting intracutaneously into the forearm an antigen of heated pus from an infected gland. The reaction reaches its height in about 48 hours, and consists of an inflammatory, infiltrated, dome-shaped area about 0.5 cm. in diameter, having in the center a small area of necrosis surrounded by a red zone. At the present time, a commercially-prepared antigen of infected yolk-sac emulsion is being used.

Lymphogranuloma is reported to produce a toxin similar to bacterial endotoxins, capable of causing production of specific antitoxin. It is also one of the few viruses that appear to be affected by the sulfonamides.

**Rabies or Hydrophobia.** This is a specific, fatal, virus disease of dogs and other animals, characterized by extreme irritation of the central nervous system and transmitted to man by the bites of infected animals.

1. *The Virus.* The saliva of infected animals contains the virus. In rabies the affected nerve cells contain cytoplasmic inclusion bodies called Negri bodies; their presence indicates rabies. The virus may be attenuated by drying in KOH, by exposure to 1% phenol, and by temperatures above  $45^{\circ}$  C. It remains potent in glycerin at  $7^{\circ}$  C. for some time. Rabies virus has been cultivated in tissue culture and in the chick embryo. Such preparations have been studied for their efficacy as immunizing agents. Mice have been made immune for about 9 months by the intraperitoneal injection of such virus, and dogs have also developed a considerable immunity.

2. *Disease.* In man, after an incubation period, usually of 26 to 70 days, often longer, the first symptoms of difficulty in breathing and inability to swallow are observed, with a rise in temperature. In the dog the disease is manifested by increased aggressiveness, characteristic restlessness, loss of appetite, desire to bite, paroxysms of fury, rapid emaciation, paralysis, and death. Death in man occurs in the majority of cases on the third or fourth day after the appearance of symptoms. The development of rabies following the bite of a rabid animal is dependent upon the point of inoculation, the amount of virus introduced, and the strength of the virus. The period of incubation is shorter and the disease is generally severe when the bite is on the face or in the tips of the fingers, where there is an abundance of nerves.

### 3. Laboratory Diagnosis.

(a) *Spread Method.* Spreads made from the cortex in the region of the fissure of Rolando or in the region corresponding to it in lower animals, from Ammon's horn, and from the gray matter of the cerebellum are examined after staining with Giemsa's method for the presence of Negri bodies, which appear magenta with blue granules.

(b) *Animal Inoculation.* If Negri bodies are not detected in the spreads, small portions of the hippocampus are emulsified in sterile physiologic saline and about 0.125 ml. is inoculated subdurally into guinea pigs or rabbits. Generally, death occurs after 16 days or longer, and Negri bodies may be demonstrated in the brain tissue on autopsy.

A mouse inoculation test has been introduced recently. It consists of intracerebral inoculation of brain material. Some of the mice are examined for Negri bodies in the brain and others are studied for the appearance of characteristic weakness and paralysis of the hind legs, prostration, and death. This method has the advantage of earlier diagnosis.

(c) *Serological Reactions.* A mouse protection test has been devised for measuring the antibodies in serum against rabies virus. Complement fixation technics have thus far yielded unsatisfactory results.

4. *Treatment and Prophylaxis.* Following the bite of an animal all wounds should be immediately cleaned and, if possible, thoroughly cauterized with fuming nitric acid. Various vaccines have been prepared for the prophylactic treatment of rabies following the bite of a rabid animal and for immunization of dogs.

(a) *Pasteur's Method.* This procedure, with some modifications, is still in use today. It is based upon the fact that rabies virus may be intensified by passage through rabbits. Virus taken from the street dog is known as *street virus*. The virulence for the rabbit of this virus, which to begin with produces rabies after an incubation period of from 12 to 14 days, may be enhanced so that the incubation period is reduced to about 6 or 7 days, after which the virus remains constant in virulence and is known as *fixed virus*. (Negri bodies are not demonstrable in fixed virus infections, perhaps because of the shorter incubation period.) The fixed virus is then subjected to various periods of drying to decrease its virulence. The course of treatment consists of 14 to 21 separate inoculations of fixed virus of increasing virulence.

(b) *Semple's Method.* Treatment consists of a course of 14 injections, given daily, of 2 ml. of a vaccine prepared by incubating an 8% emulsion of brains of rabbits injected with rabies fixed virus, in 1% phenol in normal salt solution for 24 hours at 37° C. and then diluting it with an equal volume of saline (thus making a 4% emulsion of the virus). The injections are made subcutaneously, usually over the abdomen.

(c) Chloroform- and ultraviolet-light-treated virus have also been shown to be efficient immunizers.

(d) The most efficient methods of prevention lie in the muzzling of dogs and in the quarantine of incoming animals for observation.

A slight decrease in mortality from rabies has been shown in the statistics from various parts of the world. Cases of paralysis following the administration of vaccines have been reported. The immunity produced by antirabic treatment is variable.

**Anterior Poliomyelitis or Infantile Paralysis.** This is a disease of the central nervous system in which the nerve cells of the anterior horn of the spinal cord are injured, resulting in flaccid paralysis of the muscles innervated by the damaged nerve cells. The disease is ushered in after an incubation period of 7 to 14 days with symptoms of fever, headache, stiffness of the neck, irritability, and gastrointestinal disturbances. *Abortive poliomyelitis* is a form of the disease in which there is no evidence of muscle involvement. There may be only slight transient weakness, in which case the attack is termed *nonparalytic*.

1. *The Virus.* Poliomyelitis was successfully transmitted to monkeys by Landsteiner and Popper in 1908 by the intraperitoneal injection of spinal cord from a case of poliomyelitis. These investigators were unable to carry the virus from monkey to monkey. Flexner and Lewis, in the same year, inoculated monkeys intracerebrally and found that with this route they could transmit the virus serially from monkey to monkey. Attempts to transmit the disease to other laboratory animals were unsuccessful, until recently when Armstrong reported the transmission of poliomyelitis (Lansing strain) to Eastern cotton rats by intracerebral injection. The infection of white mice has also been accomplished. The virus is extremely small, and its size is estimated as 8 to 12  $\mu$ . It resists desiccation, freezing, glycerin, and exposure to 5% phenol. It is, however, thermolabile, a temperature of 45° C. being lethal.

2. *Portal of Entry.* The virus has been demonstrated in the nasopharyngeal washings of patients and of healthy carriers. Monkeys have been infected by intranasal instillations of the virus. Certain experiments in which the olfactory nerve has been severed or the nasal mucosa blocked by chemicals have shown that infection is prevented in monkeys so treated. Therefore, some believe that infection with poliomyelitis virus occurs through the respiratory tract. However, the isolation by many investigators of the virus from stools of human beings and monkeys infected with the disease has raised the possibility of a gastrointestinal portal of entry. The virus has also been isolated from sewage and from flies.

3. *Immunity.* Well-nourished individuals seem to be more susceptible to poliomyelitis than are poorly-nourished ones. One attack of the disease confers a strong immunity, second attacks being rare. The serum of convalescents contains antiviral substances which can be demonstrated by neutralization tests in monkeys. A large proportion of adults also have these neutralizing substances, and there does not seem to be much correlation between neutralizing titer and either the development of poliomyelitis or recovery from it.

4. *Prophylaxis.* Various methods have been attempted to prevent poliomyelitis, but at present there is no effective procedure for conferring an immunity of either slight or considerable duration.

(a) *Convalescent Serum.* Although a number of studies have been made on the prophylactic value of convalescent serum or normal adult serum, there is no conclusive evidence that either one is of value.

(b) *Nasal Spray.* A high degree of resistance to poliomyelitis in monkeys was reported by several investigators but questioned by others after spraying the nasal mucosa with a solution of sodium aluminum sulfate (alum), 4% tannic acid, or picric acid. However, trial of sprays in children during two epidemics furnished no evidence that either picric acid alum spray or 1% zinc sulfate reduced the incidence of poliomyelitis.

(c) *Active Immunization.* Numerous vaccines consisting of virus attenuated by formalin or sodium ricinoleate, killed virus, or serum-virus mixtures have been used for the immunization of monkeys with variable results. Formalin-inactivated virus was employed by Brodie for immunization of children, and Kolmer used virus treated with sodium ricinoleate. These vaccines have been discontinued because their safety was doubted. Ultraviolet-light-treated, antigenic, but not infective virus has recently been reported to afford high protection to mice.

**Epidemic Encephalitis.** During the past few years a number of infections of the central nervous system have been recognized as caused by viruses. These diseases have been termed *epidemic encephalitis* and include St. Louis encephalitis and Japanese encephalitis Type B. They may be distinguished from encephalitis lethargica or von Economo's disease, for which no accepted etiologic agent has yet been isolated.

*Von Economo's disease* is a chronic sporadic infection. Following an acute stage, muscle spasticity, mental deterioration, and personality alteration occur. These may become worse and the patient may die, there may be recovery with some disability, or the patient may make a complete recovery. Herpes virus has been isolated in some of these cases, and is believed by a number of workers to be the cause of the disease. In Japan there is a type of encephalitis which is similar to Von Economo's disease. It has been referred to as *Japanese encephalitis Type A*.

1. *St. Louis Encephalitis.* This disease was first recognized in epidemic form in 1933 in St. Louis. Following an incubation period of 4 to 21 days, symptoms of fever and meningeal irritation occurred. The disease had a short course and few sequelae. A virus was recovered by the intracerebral inoculation of monkeys and mice with brain tissue of fatal cases. Neutralizing antibodies against the virus were demonstrated in the sera of patients recovering from the infection and also in the sera of persons living in various parts of the United States. Reservoirs for the disease appear to be birds and a number of mammals. Mosquitoes and probably ticks play a role in transmission.

2. *Japanese Encephalitis Type B.* In Japan there has been recognized a type of encephalitis which differs from Type A in that it is more prevalent in the summer months. The disease is more acute and the incidence is highest among older persons. Although the disease was first differentiated from Type A in 1928 and designated Type B, it was not until 1935 that its etiologic agent was isolated by the intracerebral inoculation of mice. The virus differs from that of St. Louis encephalitis in that it produces a more severe disease in monkeys. It has been shown to be distinct from St. Louis encephalitis virus by neutralization tests, but shows partial immunologic relationship to it by complement fixation. Insects may be involved in transmission.

3. *Postinfection Encephalitis.* Cases of encephalitis following varicella, pertussis, typhus fever, and mumps have been reported. Vaccination against smallpox is occasionally followed by encephalitis known as postvaccinal encephalitis. The cause of these types of encephalitis is not known.

**Australian X Disease.** This is a form of encephalitis which occurred in Australia in 1917-1918. It has been reported transmissible to sheep, and produces lesions similar to those caused in louping ill.

**Equine Encephalomyelitis.** This is a disease of horses (see page 307) which has recently been recognized to affect human beings.

**Lymphocytic Choriomeningitis.** This is an infection of the central nervous system, beginning with a mild, upper respiratory infection, for which a virus was isolated in 1934 by Armstrong and Lillie in the course of infecting monkeys with material from a patient who died of encephalitis. The virus has also been transmitted to mice. It is present in the brain, spinal fluid, blood, and urine of monkeys that are injected. A virus similar to that of lymphocytic choriomeningitis has been found in normal mice and in monkeys. The virus has been shown to be distinct from the viruses of equine encephalomyelitis, St. Louis encephalitis, and poliomyelitis by means of neutralization and complement fixation tests. Arthropods may play a role in transmission.

**Yellow Fever.** This disease is transmitted by the female mosquito, *Aedes aegypti*, and is characterized by fever, chills, muscular pain, jaundice resulting from liver damage, severe gastrointestinal symptoms, and vomiting of blood. Filterability of the causal agent, mosquito transmission, incubation period in the mosquito, and infectivity of the patient's blood were definitely established by the American Army Commission consisting of Reed, Carroll, Agramonte, and Lazear at the beginning of this century, following earlier work by Carlos Finlay.

1. *The Virus.* Yellow fever is transmissible to monkeys by intraperitoneal or intradermal injections of the virus. Mice injected intracerebrally develop encephalitis, and the virus is altered from one with primarily viscerotropic properties to one that is neurotropic. Intranuclear inclusions are demonstrable in the liver of infected monkeys and man, and in the ganglion cells of mice. The virus has been estimated to be 17 to 28  $m\mu$  in size. It resists freezing, drying, and exposure to glycerin and formalin, but it is destroyed by heating at 60° C. for 10 minutes. It has been cultivated in tissue culture.

2. *Immunity.* One attack confers immunity. Neutralizing antibodies have been demonstrated in the sera of a large number of individuals in areas where yellow fever is prevalent.

3. *Prophylaxis.* The subcutaneous injection of vaccine prepared with human immune serum and dried living virus fixed for mice produces a rise in titer within a few weeks. Vaccination with virus attenuated by prolonged cultivation in tissue culture has given some satisfactory results.

4. *Jungle Yellow Fever.* Yellow fever in the absence of *Aedes aegypti* has been observed in certain areas, and termed jungle yellow fever. This form of the disease and the causing virus appear identical with the classical type.

5. *Prevention.* Many areas have been freed from yellow fever by precautions taken to prevent the breeding of mosquitoes.

**Pappataci Fever, Sandfly Fever, or Phlebotomus Fever.** This is an acute, mild, febrile disease of tropical countries, which is transmitted by sandflies. The disease is characterized by chills, fevers, conjunctivitis, and pains. It has an incubation period of 1 to 6 days. The virus is demonstrable in the blood. One attack confers immunity for at least 4 months and probably a year or more.

**Dengue or Breakbone Fever.** This is a mild disease of warm climates, characterized by fever, headaches, muscular pains, and often a maculopapular rash. The disease is carried by the *Aedes aegypti* and a related mosquito, and it has been experimentally transmitted to man after an incubation period of 3 to 4 days by the injection of blood and serum filtrates from cases of the disease. The immunity conferred by an attack is of uncertain duration.

**Rift Valley Fever.** This is primarily a disease of sheep, cattle, and goats, but produces in man an infection with symptoms of malaise, nausea, fever, and severe headache. The disease, which is probably mosquito-borne, has been transmitted experimentally to mice, monkeys, and ferrets. Intranuclear inclusion bodies are demonstrable in the liver. The virus has been estimated to be about 23 to 35 m $\mu$  in size, and has been cultivated in tissue culture. One attack confers immunity. Neutralizing and complement-fixing antibodies are found in the serum of convalescents from the disease.

**Trachoma.** This is an eye disease, probably of virus origin, which is found in unhygienic surroundings and is characterized by granulated eyelids, conjunctivitis, and lacrimal gland injury. Cell inclusions containing elementary bodies are found in the infected conjunctiva. After an incubation period of several days to a month, monkeys have been experimentally infected with material taken from cases of trachoma. However, characteristic inclusion bodies have not been found in the experimental disease.

#### EXTRAHUMAN VIRUS DISEASES

Viruses have been reported to cause disease in practically every type of living thing—mammals, fowl, birds, amphibians, fish, insects, plants, and perhaps bacteria (see Chapter XXXIII on Bacteriophage). A partial list of these follows:

1. *Sheep.* Agalactia, catarrhal fever, contagious pustular dermatitis, loup-  
ing ill, Nairobi disease, Rift Valley fever, sheep pox.
2. *Horses or Cattle.* African horse sickness, Borna disease, equine enceph-  
alomyelitis, equine influenza, foot-and-mouth disease, horse pox, malignant catarrh  
of cattle, periodic ophthalmia of horses, rinderpest (cattle plague), vesicular  
stomatitis.
3. *Hogs.* Hog cholera, swine influenza, swine pox.
4. *Dogs and Foxes.* Distemper, encephalitis of foxes, pseudorabies, rabies.
5. *Fowl.* Fowl plague, fowl pox (contagious epithelioma), infectious laryn-  
gotracheitis, leucemia of chickens, Newcastle disease, Rous sarcoma.
6. *Rabbits.* Infectious fibroma, infectious myxomatosis, infectious papil-  
loma, rabbit pox, spontaneous encephalitis, virus III.
7. *Birds.* Avian diphtheria, canary pox, pigeon pox, psittacosis, ornithosis.
8. *Guinea pigs.* Guinea pig epizootic, guinea pig paralysis, salivary gland  
disease.
9. *Mice.* Infectious ectromelia, influenza-like disease of Swiss mice, lym-  
phatic leucemia.
10. *Rats.* Salivary gland disease.
11. *Ferrets.* Epizootic disease.
12. *Frogs.* Carcinoma.
13. *Fish.* Carp pox, epithelioma of barbus, lymphocytic disease.
14. *Insects.* Polyhedral diseases, sacbrood of honey bees, silkworm jaundice.
15. *Plants.* Mosaic diseases, rosette of wheat, tulip break, etc.
16. *Bacteria.* Bacteriophage(?).

Of these diseases of animals, rabies, psittacosis, equine encephalo-  
myelitis, foot-and-mouth disease, Rift Valley fever, and cowpox are  
transmissible to man. Some of these have been discussed in the pre-  
ceding section on virus diseases of man.

**Foot-and-Mouth Disease.** This is an acute, febrile disease of  
cattle, sheep, and hogs, which is characterized by vesicular eruptions  
inside the mouth and around the feet.

1. *Virus*. The causative agent of foot-and-mouth disease is present in the vesicular lymph and in the blood in the early stages. It is 8 to 12  $\mu$  in diameter. It resists alcohol, chloroform, phenol, and glycerin, but is destroyed by alkali. It is destroyed at 37° C. in 24 hours, but remains active in the icebox for several months. Inoculation into guinea pigs, rabbits, dogs, and cats produces the disease in these animals. Inclusion bodies have been observed in lesions after 24 and 48 hours. The virus has been cultivated in tissue culture containing guinea pig embryo tissue and clotted guinea pig plasma.

2. *Transmission*. The highly contagious disease is transmitted by direct or indirect contact with the virus released by rupture of the vesicles. Ingestion of contaminated raw milk is one of the factors involved. When transmitted to man, the disease is usually mild, with transient vesicles on the hands and feet and sometimes gastrointestinal disturbances.

3. *Immunity*. Immunity following an attack usually lasts for a year. Vaccines of living virus, virus in combination with immune serum, or formalinized virus have been used, but they do not protect animals against the disease.

*Swine Influenza*. This disease of swine has been shown to be caused by the combined action of a filterable virus and the bacterium *Hemophilus influenzae suis*. The injection of virus alone produces a mild disease in swine. The bacterium has no effect on the animals. The combination of the two, however, causes an illness which is similar to the natural disease in swine. Intramuscular injection of virus alone produces an immunity in swine against both the mild virus disease and the severe natural disease, but injection with the bacillus produces no immunity whatsoever. Antibodies against swine influenza virus have been observed in the sera of adults, but were lacking in the sera of children tested. When ferrets are injected with swine influenza virus a disease is produced similar to that caused by human influenza virus. It is believed that swine influenza virus is an adapted strain of human influenza virus causing the pandemic of influenza in man in 1918-1919. By means of complement fixation tests swine influenza virus cannot be differentiated from human influenza virus. Sera of ferrets and mice that have been repeatedly inoculated with human influenza virus contain antibodies against both human and swine virus.

*Equine Encephalomyelitis*. This is a disease first observed in horses but since found in a wide variety of wild and domestic animals and birds. It is characterized by inflammation of the meninges, with pyrexia, inco-ordination, vertigo, paresis, and motor and sensory paralysis. It is transmitted by mosquitoes and other blood-sucking insects. Three strains of virus causing the disease have been identified by immunological methods—the severe eastern, the less severe western, and the Venezuelan. All three have been known to infect man. Formalized tissue culture and chick embryo virus vaccines have been used with good results in the immunization of horses and laboratory workers. For treatment of this disease an antiserum may be given with some benefit, particularly in the early stages.

*Rinderpest or Cattle Plague*. This is generally a fatal disease characterized by catarrh, fever, conjunctivitis, diarrhea, and emaciation, and largely spread through contaminated food and water. The virus is present in the blood, secretions, and intestinal contents of infected animals. One attack confers immunity. Chloroform-treated emulsions of spleens and lymph nodes of animals killed in the acute stage of the disease have been used for vaccination of cattle. However, the disease may be spread by such vaccinated animals.



**Fowl Pox or Contagious Epithelioma.** This is a disease of chickens manifested by wartlike scabs on the combs and head. Elementary bodies were described by von Prowazek. Immunization with vaccine is highly successful.

**Canine Distemper.** This is a disease of young dogs, foxes, and other animals. It is characterized by catarrhal inflammation of the respiratory tract and diarrhea. It has an incubation period of from 3 to 5 days. The disease may be prevented by immunizing vaccines. Convalescent serum has been used to confer passive immunity, and has therapeutic value also.

**Hog Cholera.** This disease was shown by Dorset, in 1903, to be due to a filterable virus, complicated by the presence of *Salmonella choleraesuis (suipestifer)* as a secondary invader. The virus is present in the urine. One attack of the disease produces a fair immunity, and simultaneous inoculation of hyperimmune antiserum and virus confers a lasting active immunity.

**Infectious Myxomatosis of Rabbits.** This is a highly fatal, virus disease of domesticated rabbits, characterized by tissue swellings forming gelatinous tumors and a purulent conjunctivitis. The virus is present in discharges from the nose and eyes, and in the blood and serous exudates. The rapid spread of tumors to all parts of the body reminds one of a similar phenomenon in the case of human cancer. It is remarkable that injection of relatively benign fibroma virus into rabbits produces immunity against the cancer-like disease, infectious myxomatosis.

- Gardner, A. D. *Bacteriology for Medical Students and Practitioners*. New York: Oxford University Press, 1944. Pp. 194-213.
- Hagan, W. A. *Infectious Diseases of Domestic Animals*. New York: Comstock Publishing Company, 1943. Pp. 497-651.
- Harvard School of Public Health. *Virus and Rickettsial Diseases*. Cambridge, Mass.: Harvard University Press, 1940.
- Holmes, F. O. *Handbook of Phytopathogenic Viruses*. Minneapolis: Burgess Publishing Company, 1939.
- Hyde, R. R., and R. E. Gardner. *Laboratory Outline in Filterable Viruses*. New York: Macmillan Company, 1937.
- Julianelle, Louis A. *The Etiology of Trachoma*. New York: The Commonwealth Fund, 1938.
- Laidlaw, P. P. *Virus Diseases and Viruses*. New York: Macmillan Company, 1938.
- Leifson, E. *Bacteriology for Students of Medicine and Public Health*. New York: Harper and Brothers, 1942. Pp. 394-428.
- Mackie, T. T., et al. *Manual of Tropical Medicine*. Philadelphia: W. B. Saunders Company, 1945. Pp. 1-28.
- National Foundation for Infantile Paralysis. *The Epidemiology of Poliomyelitis*. New York, 1941.
- Park, William Hallock, and Anna Wessels Williams. *Pathogenic Microorganisms*. Eleventh Edition. Philadelphia: Lea and Febiger, 1939. Pp. 703-785.
- Problems and Trends in Virus Research*. Philadelphia: University of Pennsylvania Press, 1941.
- Rivers, T. M. *Viral and Rickettsial Infections of Man*. Philadelphia: J. B. Lippincott Company, 1948. Pp. 147-547.
- Seiffert, Gustav. *Virus Diseases in Man, Animal and Plant*. New York: Philosophical Library, 1944.
- Simmons, J. S., and C. J. Gentzkow. *Laboratory Methods of the U. S. Army*. Philadelphia: Lea and Febiger, 1944. Pp. 559-579.
- Smith, K. M. *Recent Advances in the Study of Plant Viruses*. Philadelphia: The

IMPORTANT VIRUS DISEASES OF MAN

NAME OF DISEASE	PERIOD OF INCUBATION	PORTAL OF ENTRY AND MODE OF TRANSMISSION	SELECTIVE ACTION AND LESIONS	INCLUSION BODIES	SUSCEPTIBLE ANIMALS	IMMUNITY	PROPHYLAXIS
Varicella or smallpox	6-15 days	Contact, probably mucous membrane of fauces	Skin and other organs, dermatropic	Cytoplasmic (Guarnieri body) and intranuclear (Paschen or elementary body)	Monkeys, calves, and rabbits	One attack confers immunity	Vaccination with vaccinia virus
Vaccinia or cowpox	3 days	Contact or vaccination	Skin, dermatropic	Cytoplasmic	Cattle, sheep, horses, and rabbits	Immunity of variable duration following vaccination	Vaccination with vaccinia virus
Varicella or chickenpox	14-21 days	Contact, by droplet infection via nasopharyngeal secretions	Skin and mucous membranes, dermatropic	Cytoplasmic and intranuclear reported	Not known	One attack confers immunity	Convalescent serum may be of value
Herpes zoster or shingles	12-15 days	Contact	Skin, nerves, and ganglia, dermatropic	Cytoplasmic and intranuclear reported	Not known	One attack confers immunity	None
Herpes simplex	1-2 days	Contact, fever, exposure to ultraviolet rays, etc.	Skin, dermatropic	Intranuclear	Rabbits, guinea pigs, mice, monkeys	Immunity of short duration, probably none	None
Molluscum contagiosum	Experimentally, 14-25 days	Contact	Skin, dermatropic	Cytoplasmic	None	Little is known	None
Verruca or warts	Experimentally, 4-9 weeks	Contact	Skin, dermatropic	Intranuclear	None	May be local	None
Rubeola or measles	10-14 days	Contact, by droplet infection	Skin and mucous membranes of the respiratory tract, dermatropic	Cytoplasmic reported	Monkeys	One attack confers immunity	Convalescent or normal serum, normal blood, placental extract
Rubella or German measles	10-21 days	Contact, by droplet infection	Skin and mucous membranes	None	None	One attack confers immunity	None
Epidemic influenza	3-8 days	Contact, by droplet infection	Lungs and nasal mucosa	None	Ferrets and mice	Immunity is of short duration	Vaccine may be of value
Common cold	1-5 days	Contact, by droplet infection	Mucous membrane of respiratory tract	None	Chimpanzees	Immunity is of short duration	None

Parotitis or mumps	5-21 days	Contact, by droplet infection	Salivary glands	Cytoplasmic	Monkeys, and possibly cats	One attack confers immunity	Convalescent serum
Psittacosis or parrot fever	10-30 days	Contact with infected parrots	Lungs	Cytoplasmic, elementary bodies	Parrots, mice, rabbits, monkeys, and guinea pigs	One attack confers immunity	Vaccination with active virus intramuscularly
Lymphogranuloma venereum	Several days to about 2 weeks	Sexual contact	Lymphatic system in genital region	Cytoplasmic, elementary bodies	Monkeys, mice, rabbits, cats, and guinea pigs	Little is known	None
Rabies or hydrophobia	Variable, 27-60 days, or longer	Bite of rabid animal	Central nervous system, neurotropic	Cytoplasmic, Negri body	All mammals and some birds	Vaccination confers immunity of short duration	Vaccine of fixed virus and cauterization of wound
Anterior poliomyelitis or infantile paralysis	7-14 days	Contact, by droplet infection through respiratory tract, or possibly gastrointestinal tract	Central nervous system, nerve cells of anterior horns, neurotropic	None	Monkeys, cotton rats, and mice reported	One attack confers immunity	None
Epidemic encephalitis: St. Louis encephalitis Japanese encephalitis Type B	4-21 days Not known	Contact, insects	Central nervous system, neurotropic	None	Mice and monkeys	One attack confers immunity	None
Lymphocytic choriomeningitis	Experimentally 4-7 days	Probably by contact, possibly insects	Central nervous system, neurotropic	None	Monkeys, mice, and guinea pigs	One attack confers immunity	None
Yellow fever	4-13 days	Through skin by bite of female <i>Aedes aegypti</i> mosquito	Liver and other organs	Intranuclear	Mice and monkeys	One attack confers immunity	Vaccine of virus and immune serum, or tissue-cultured virus
Pappataci or sandfly fever	1-6 days	Through skin by bite of sandfly	No definite lesions described	None	None	Immunity of 4 months to 1 year or more	None
Dengue or breakbone fever	3-6 days	Through skin by bite of <i>Aedes aegypti</i> mosquito	Skin and throat	None	Possibly monkeys	Immunity of uncertain duration	None
Trachoma	Not known	Contact, through conjunctiva	Mucous membrane of eye	Cytoplasmic and elementary	Possibly monkeys	Little is known	None

# M A T R I X I I I

## THE IMMUNE SYSTEM

In the 1970's, it was discovered that our thoughts and feelings have a physical substrate to them. When you think a thought, protein-like molecules called neuro-peptides are created. These neuro-peptides fit into receptors in the cell walls and in neurons. Intra-brain communication is by way of neuro-peptides. Immune system cells also have receptors for the same neuro-peptides, and they can also generate the same neuro-peptides, which supports the fact of these cells (like all cells in the body) being conscious. The immune cells make the same chemicals the brain produces during emotional and mental states.

How does the immune system decide what it should deal with in the body and how it should deal with it? It has to remember the last time it encountered something. Through the genetic memory, it remembers the last time anyone encountered a specific chemical combination; it can recognize anything that has been encountered by any living species. The immune cells within the blood are, in effect, a circulating nervous system of a very special type.

All cells in the body have some level of consciousness and produce hormonal and enzymal substances. During emotional states of joy and exhilaration, interleukin and interferon are produced. During panick or terror states, cortisol and adrenalin is produced, which damages the immune system.

Because any type of stress (societal, electromagnetic, or otherwise) affects the integrity of the immune system, the environment within the body is becoming more suited for deteriorating processes and a host of organisms that arise during such states. Thus, the increase in organic problems is paralleling the decline in civilization, but only for those who are steeped in social consciousness. For those who are accessing superconsciousness, the nature of the body is being altered to a point where health is no longer a problem.

On the next page, let's take a look at some database information on the immune system.

**YELTSIN BANS GERM WARFARE:** President Boris N. Yeltsin has signed a decree committing Russia to an international treaty banning germ warfare, his spokesman said Thursday in Moscow. The United States, which has long claimed that the Soviet Union maintained a secret biological weapons program, had pressed Russia to meet a Wednesday deadline to reveal the scope and history of the program. 4-17-92 BUT, US PGM CONTINUES

# M A T R I X I I I

## DATABASE: THE IMMUNE SYSTEM

AIDS	AIDS victims show a variety of immune system abnormalities including decreased helper-suppressor T-cell ratios, lowered T-cell counts, possible hyperactivity of suppressor T-cells, and excessive amounts of pathological anti-bodies.
Immune Cell Receptors	The cells of the immune system contain receptors for neuro-hormones, neurotransmitters, and neuropeptides all thought to live only in the CNS. The immune system has, in a real sense, its own mind and own decision making capabilities.
Immune system and Brain Struct	French investigators have been able to demonstrate an involvement of the left cortical hemisphere of the brain in immune function.
Immune system and Brain Struct.	The structure and organization of the brain itself may influence immunity. Clinicians have made the observation that left-handed people appear to have more developmental difficulties. Left handed people have higher rates of immune disorders and migraine headaches. In one London study of 253 lefties, the frequency of immune disorders was found to be 2.7 times higher, especially thyroid and bowel disorders.
Immune system and CNS	The cells of the immune system appear equipped to respond to chemical signals from the central nervous system. Receptors have been found on the surfaces of lymphocytes for catecholines, prostaglandins growth hormones, thyroid hormone, sex hormones, serotonin, and endorphins. These neuroendocrines, neurotransmitters and neuropeptides may stimulate the differentiation, migration, and activity of lymphocytes.
Immune system and eactions	Emotional states which involve the hypothalamus and other parts of the limbic system may also "spill over" and affect the immune system.
Immune system and Emotions	Both loneliness and mild stress are associated with decreased activity on (NK) natural killer immune cells. It is possibly not the actual stress which brings on changes, but possibly the emotional reaction to the stress.
Immune system and Endorphins	During certain types of stress, the brain releases endorphins. Psychologists John Liebeskind and Yehuda Shavit found that with the increased production of endorphins, there was a corresponding decrease in activity and tumor-fighting ability in natural killer (NK) cells.
Immune system and Hypothalamus	The surgical removal of certain areas in the hypothalamus leads to suppression of immune system response, while stimulation leads to enhanced immune system response. Damage to certain areas of the hypothalamus resulted in decreased function in the thymus gland. The thymus is responsible for the maturation of the T-cells.
Immune system and Hypothalamus	Research in 1977 by Hugo Besedovsky indicates that information about the immune system is registered, if not organized, in the hypothalamus. Since the immune system controls the pituitary, it causes changes in the levels of norepinephrine, suggesting that the immune system can change brain function and vice versa
Immune System Breakdown	Sometimes the self-recognition mechanism breaks down and the immune system malfunctions, producing autoimmune diseases such as rheumatoid arthritis, myasthenia gravis, pernicious anemia, acquired hemolytic anemia, and systemic lupus erythematosys (SLE), which is when the blood contains antibodies to a person's own DNA. Both genes and personality affect immune system disorders.

# M A T R I X I I I

## DATABASE: THE IMMUNE SYSTEM

Immune System Enhancement	Janice Kiecolt-Glaser and colleagues have found that relaxation training can also enhance cellular immune function. Increases in NK cell activity and decreases in antibodies to herpes simplex virus.
Immune System Enhancement	Kathleen Dillon and her colleagues demonstrated a link between positive emotional states and enhanced immune system function.
Immune system Improvement	There is evidence that an individual can voluntarily improve immune functions. Howard Hall and colleagues at Penn State University found increase in immune system response as a result of hypnosis and visualization techniques dealing with lymphocytes that focussed on the white cells fighting disease. Numbers of white cells increased in easily hypnotised subjects.
Immune System Suppression	McClelland has reported that college students who were high in power-related life stresses reported more frequent and more severe illnesses. There are also indications that if a strong need for power is inhibited, there is chronic overactivity of the sympathetic nervous system, which suppresses the immune system.
Memory of the Immune System	The immune system can be trained to defend more vigilantly or to relax defense. That the immune system does behave and learn is probably one of the major discoveries in neuroscience of the 1970's, along with that of the endorphins.

## New blood test can tell if you're lying or not

THE POLICE have unleashed a new weapon in the ongoing war against crime — a simple blood test that can tell whether you're lying or not.

The technique, called isoelectric focusing, allows technicians to identify enzymes in the blood that show when someone is not telling the truth.

The revolutionary technique was developed by scientists in Paris, France, and is now being tested before being introduced into the American legal system. "The possible uses of isoelectric focusing are

endless," says Dr. Pierre LaFont. "The primary application, of course, would be in criminal matters.

### Guilt markers

"If police apprehend drug smugglers or a suspect near a crime scene, they could immediately draw blood and determine whether they had the guilty party or not."

The amazing blood test works by isolating certain enzymes or "guilt markers" in the blood.

If a blood sample contains more than four "guilt markers," the person is lying, the scientists say.

March 3, 1992

## TYPES OF IMMUNITY

Immunity may be defined as the ability of the living individual to resist or overcome infection. This state of resistance is indicated either by the failure of the individual to develop the disease upon exposure, or in some cases by the demonstration of specific immune bodies in the blood which are considered effective against the invading organisms.

**Natural Immunity.** This is a type of immunity with which an individual is born. It enables him to resist infection without first having the disease.

1. *Species.* This immunity is characteristic of a particular species. Example: Dogs are immune to anthrax and tuberculosis.

2. *Racial.* This immunity is characteristic of a particular race within a species. Example: Algerian sheep are immune to anthrax. In the races of man, Negroes are said to be relatively resistant to yellow fever and more susceptible to tuberculosis than whites. The issue, however, is obscured by many other factors, including a possible congenital immunity in the former case and economic status in the latter.

3. *Individual.* This immunity, characteristic of particular individuals, may be largely attributable to acquired immunity due to an earlier, mild, unrecognized attack of the disease.

4. *Congenital.* This immunity, found in the newborn, is due to the passive transfer of antibodies from mother to offspring through the placenta. Thus, infants in the first year of life are resistant to diphtheria and scarlet fever.

**Acquired Immunity.** This immunity is acquired by the individual during his lifetime.

1. *Active.* This is a relatively lasting immunity due to the development within the individual of antibodies as a result of contact with the microorganisms or their products. The body cells and tissues themselves react to produce the specific immunity.

(a) *Naturally Acquired.* This immunity is attained as a result of an attack of the disease itself. One attack of certain diseases confers lifelong immunity. Examples: diphtheria, whooping cough, typhoid fever, scarlet fever, yellow fever, most virus diseases.

(b) *Artificially Acquired.* This immunity results from a course of immunization with attenuated cultures\* (e.g., smallpox vaccination, Pasteur's rabies "treatment"), killed cultures (e.g., formalized pneumococcus vaccines), sensitized bacterial vaccines, toxin, toxin-antitoxin, toxoid (e.g., diphtheria immunization).

2. *Passive.* This is a short-lived immunity in which the antibodies are produced in another animal whose blood or serum is injected into the person. The body cells of the treated individuals take no part in producing the immunity.

## BIBLIOGRAPHY

- Dubos, Rene J. *The Bacterial Cell.* Cambridge, Mass.: Harvard University Press, 1945. Pp. 229-274.
- Gershenfeld, Louis. *Bacteriology and Allied Subjects.* Easton, Pa.: Mack Publishing Company, 1945. Pp. 448-450, 477-501.
- Society of American Bacteriologists. *Manual of Methods for Pure Culture Study of Bacteria.* Geneva, N. Y.: Biotechnical Publications, 1949. Chap. VIII.
- Strean, L. P. *Oral Bacterial Infections.* Brooklyn, N. Y.: Dental Publishing Company, 1949. Pp. 160-171.

## IMMUNOLOGICAL REACTIONS

Parenteral introduction of foreign proteins, including microorganisms, into the animal body results in the production of specific protective substances. These are termed antigens and antibodies respectively.

An *antigen* is any substance which stimulates the production of specific antibodies. Antigens are protein in nature, and practically all proteins, except the incomplete ones such as gelatin, are antigenic. Specificity of the antigen is determined by its chemical composition.

An *antibody* is formed by the animal body in response to the presence of antigen with which it combines in a specific, antagonistic manner. The antibodies are closely associated, and may be identical, with serum globulin. They may be separated from other serum constituents by dilution with distilled water or more often by salting out. Northrop has prepared crystalline diphtheria antitoxin which appears to be pure protein and contains 700,000 to 1,000,000 antitoxic units per gram.

The five main types of antibodies, as determined by their action, and the leading organisms stimulating their production are listed below.

1. *Antitoxin*—*Corynebacterium diphtheriae*, *Streptococcus scarlatinae*, *Shigella dysenteriae*, *Clostridium tetani*, *Clostridium perfringens*, *Clostridium fesceri*.

2. *Agglutinin*—*Diplococcus pneumoniae*, *Salmonella typhosa*, *Salmonella paratyphi*, *Salmonella schottmuelleri*.

3. *Precipitin*—*Diplococcus pneumoniae*, *Bacillus anthracis*.

4. *Opsonin*—Most microorganisms, *Neisseria intracellularis*, *Diplococcus pneumoniae*, *Salmonella typhosa*.

5. *Cytolysin*—*Treponema pallidum*, *Hemophilus pertussis*, *Neisseria gonorrhoeae*, *Neisseria intracellularis*.

*Ablastins* (inhibiting reproduction) and *neutralizing antibodies*, two other types about which there is limited knowledge, may be provisionally added.

Ehrlich believed that the different demonstrable antibodies were separate and distinct substances. Zinsser and others, however, have proposed a "unitarian" hypothesis—that the various antibodies stimulated by a single antigen are essentially identical regardless of the consequences of the antigen-antibody union. These are variable and depend on the nature of the antigen and the conditions of the reaction.

*Haptenes*, or *partial antigens*, described by Landsteiner, are relatively simple substances unable to stimulate antibody production when injected by themselves but determining immunological specificity when combined with antigenic protein. The specific antibodies produced react with the haptene alone or with the combined protein-haptene, both *in vivo* and *in vitro*. Not necessarily proteins, the haptenes are exemplified by the polysaccharide Specific Soluble Substances (S.S.S.) found in the pneumococcus capsule.

A widely distributed *heterophile antigen*, described by Forssmann, stimulates production of hemolysin against sheep's red blood cells when injected into rabbits. The antigen has been found in organs of guinea pigs, horses, dogs, cats, mice, fowl, and tortoises, and in some bacteria.

## TOXINS AND ANTITOXINS

Ehrlich regarded toxin-antitoxin interaction as purely chemical and equivalent to the neutralization of acids by alkalis. Thus, the union was postulated to take place according to the law of multiple proportions. Therefore, if one part of antitoxin neutralizes one part of toxin, 500 parts of antitoxin should neutralize 500 parts of toxin. Danysz, however, observed that when toxin is added to antitoxin in fractions after some lapse of time between additions, a mixture which is nontoxic when toxin and antitoxin are added at once, becomes toxic. This is the *Danysz phenomenon*. Bordet and Landsteiner believe that the toxin-antitoxin reaction is an adsorption phenomenon, and there is strong evidence to substantiate this view.

**Toxoid.** It has been observed that toxin, when kept for a long time, deteriorates, until it is no longer toxic. Exposure of toxin to 0.4% formalin at a temperature of 37° to 40° C. for about a month produces a product (*toxoid* or *anatoxin*) which is innocuous but is at the same time antigenic and capable of producing a high titer of antibody. Such preparations have been made from the toxins of *Corynebacterium diphtheriae* and *Clostridium tetani* and are used in immunization against diphtheria and tetanus, respectively. *Alum-precipitated toxoid* is preferred by many because it is largely protein-free and because the antigenic stimulus is operative for a longer period owing to the slow liberation of toxoid.

### IMPORTANT TOXINS \*

Product	Production	Test Animal	Unit of Potency	Use
Diphtheria toxin	Veal broth	250-gm. guinea pig	One M.L.D. is the smallest amount of diphtheria toxin that will kill a 250-gm. guinea pig on the 4th day. One L+ dose of diphtheria toxin is the smallest amount which when injected with N.I.H. ** standard unit of antitoxin will cause death of a 250-gm. guinea pig on the 4th day.	Schick test. Standardization of diphtheria antitoxin. Immunization of horses. Production of toxin-antitoxin. Production of toxoid.
Erysipelas Streptococcus toxin	Special bouillon	Man	One S.T.D. of erysipelas Streptococcus toxin is the smallest amount which will cause an erythema at least 1 cm. in diameter when injected intradermally in a susceptible person.	Standardization of erysipelas Streptococcus antitoxin. Immunization of horses.
Meningococcus toxin	Special liquid media	Man	One S.T.D. of meningococcus toxin is the smallest amount that will give an erythema at least 1 cm. in diameter in a susceptible person when injected intradermally.	Standardization of meningococcus antitoxin. Immunization of horses. Skin test for susceptibility.
Perrirngens ( <i>C. perfringens</i> ) toxin	Special bouillon	Pigeon	One test dose of perrirngens ( <i>C. perfringens</i> ) toxin is the smallest amount that will kill a 350-gm. pigeon in 24 hours in the presence of one standard unit of perrirngens antitoxin.	Standardization of perrirngens ( <i>C. perfringens</i> ) antitoxin. Immunization of horses.
Puerperal septiemia Streptococcus toxin	Special bouillon	Man	One S.T.D. is the smallest amount which will cause an erythema at least 1 cm. in diameter when injected intradermally in a susceptible person.	Standardization of puerperal septiemia anti-streptococcic serum (antitoxin). Immunization of horses.
Scarlet fever toxin	1. Veal bouillon for skin testing and human immunization 2. Special broth for immunizing horses	Man	One S.T.D. of scarlet fever toxin is the smallest amount which will give an erythema at least 1 cm. in diameter in 48 hours when injected intradermally in a susceptible person.	Dick test. Active immunization of susceptibles. Standardization of scarlet fever antitoxin. Immunization of horses.
Tetanus toxin	2% glucose broth	250-gm. guinea pig	One M.L.D. is the smallest amount of tetanus toxin that will kill a 250-gm. guinea pig on the 4th day in the presence of 1/4 unit of N.I.H. standard antitoxin.	Standardization of tetanus antitoxin. Immunization of horses. Tetanus toxoid.

\* After Parke, Davis & Company.  
\*\* National Institute of Health.



ANTITOXINS AND ANTISERA \*

Product	Production	Test Animal	Unit of Potency
Anti-anthrax serum	Native antiserum from the horse	<i>In vitro</i> test	Potency proved by agglutination tests. Each lot must agglutinate <i>B. anthracis</i> in 1:6400 dilution.
Antidysenteric serum (polyvalent)	Native antiserum from the horse	1. <i>In vitro</i> test 2. Mouse	1. The finished antiserum must agglutinate Hiss-Y, Flexner, and Shiga strains of <i>S. dysenteriae</i> , and compare favorably with N.I.H.** standard antiserum. 2. In addition, each lot may be standardized by mouse protection tests as required by the British Ministry of Health.
Antimeningococcal serum	Native antiserum from the horse	<i>In vitro</i> test	The finished antiserum must agglutinate all four Gordon types of <i>Neisseria intracellularis</i> and compare favorably with N.I.H. standard antiserum.
Antipneumococcal serum Types I and II (Felton)	Euglobulin fraction of antiserum from the horse	White mouse	One unit of Felton's antipneumococcal serum is the smallest amount which will protect a white mouse against one million lethal doses of pneumococci.
Antistreptococcal serum (polyvalent)	Refined, concentrated antiserum from the horse	<i>In vitro</i> test	Potency proved by agglutination tests with various strains of hemolytic and non-hemolytic Streptococci.
Diphtheria antitoxin	Refined, concentrated antiserum from the horse	250-gm. guinea pig	One unit of diphtheria antitoxin is the least amount which will protect a 250-gm. guinea pig from one L+ dose of diphtheria toxin for at least 4 days.
Erysipelas Streptococcus antitoxin	Refined, concentrated antiserum from the horse	Man	One unit of erysipelas Streptococcus antitoxin is that amount of antitoxin which will completely neutralize one S.T.D. of erysipelas Streptococcus toxin.
Meningococcus antitoxin	Native antiserum from the horse	Man	One unit of meningococcus antitoxin is 10 times the amount that neutralizes one S.T.D. of meningococcus toxin.
Perfringens antitoxin	Refined, concentrated antiserum from the horse	Pigeon	One unit of perfringens antitoxin is the amount which will protect a 350-gm. pigeon against one test dose of perfringens toxin for 24 hours.
Puerperal septicemia antistreptococcal serum (antitoxin)	Refined, concentrated antiserum from the horse	Man	Standardized by antitoxin content. One unit of puerperal septicemia antistreptococcal serum is that amount which completely neutralizes one S.T.D. of puerperal septicemia Streptococcus toxin.
Scarlet fever antitoxin	Refined, concentrated antiserum from the horse	Man	One unit of scarlet fever antitoxin (N.I.H.) is the least amount which completely neutralizes 50 S.T.D.'s of scarlet fever toxin. The original neutralizing unit of the Scarlet Fever Committee is that amount of antitoxin which completely neutralizes one S.T.D. of scarlet fever toxin.
Tetanus antitoxin	Refined, concentrated antiserum from the horse	350-gm. guinea pig	One unit of tetanus antitoxin is 10 times the least amount which will protect a 350-gm. guinea pig from one L+ dose of tetanus toxin for at least 4 days.

\* After Parke, Davis & Company.  
\*\* National Institute of Health.

AGGLUTINOGENS AND AGGLUTININS

Certain bacteria, foremost of which is *Salmonella typhosa*, when inoculated into animals cause production of antibodies in the serum which clump a suspension of the specific organism when the serum is mixed with it. Such antibodies are called *agglutinins* or *receptors*. They are also present in the serum of patients with typhoid fever, and the clumping of typhoid bacilli by immune serum has been used by Widal in his agglutination test for diagnosis.

**Nature of Agglutinins.** 1. Agglutinins are heat resistant, but are destroyed by temperatures between 60° and 70° C. 2. They are destroyed by alkalis. 3. Exposure to heat and acids causes agglutinins to lose their clumping power, but they can still combine with the agglutinin. 4. Agglutinins are specific for a particular organism, but related organisms will agglutinate them at a low titer. 5. Agglutinins persist for a long period of time in sera dried *in vacuo* and stored. 6. They do not kill bacteria, and both living and dead bacteria can be agglutinated.

**Mechanism of Agglutination.** 1. Bordet showed that agglutination occurs upon the mixture of immune serum and a suspension of bacteria only when salts are present. The bacteria combine with the agglutinins in the absence of salts, but for visible agglutination or clumping to occur, the presence of salts is necessary. 2. Bacteria carry a negative charge. The electrical charge is also negative in the usual menstruum. Therefore the bacteria having the same charge as the medium repel one another, and in so doing stand apart in a free suspension. Specific immune serum, however, carries a positive charge. Therefore, when it is mixed with a corresponding negatively charged suspension of bacteria, the unlike charged particles attract one another, resulting in the clumping or agglutination of the bacteria. 3. Bacteria may be agglutinated in the absence of antibodies by the addition of acid to a suspension (acid agglutination). 4. Some bacteria, like Streptococci, undergo spontaneous clumping.

**Prozone or Proagglutinoid Phenomenon.** The agglutinating titer of a serum is the highest dilution at which agglutination takes place. It has been observed that in some instances low dilutions of serum cause poor agglutination or even fail to agglutinate bacteria, when higher dilutions will produce the phenomenon. This is called the prozone or proagglutinoid phenomenon and has been attributed to the presence of *agglutinoids* which prevent clumping.

#### PRECIPITINOGENS AND PRECIPITINS

Precipitins are antibodies formed in response to the injection of soluble antigens, which, when mixed with the antigen, aggregate the molecules with the formation of a precipitate. Precipitation does not occur in the absence of electrolytes.

**Applications of the Precipitation Test.** 1. Because of its high specificity the test is useful in the detection of any other meat which may be substituted and distributed as beef. 2. The test has wide application in law in the detection of stains made by human blood. The stained material is extracted and the solutions are tested with various antisera prepared in rabbits by the injection of blood of cows, horses, dogs, and man. 3. The test is used in bacteriological investigations in the differentiation of types of pneumococci, and also in the detection of anthrax infection of animal tissues (Ascoli thermoprecipitin test). 4. The Kahn precipitation and the Kline microscopic precipitation tests are used in the diagnosis of syphilis. (See p. 274.)

**Technic of the Test (Pneumococcus Typing).** For a precipitation test it is necessary to have a serum of a high titer, and one whose degree of specificity is known. The test is performed as follows in typing pneumococci:

1. Into each of a series of small agglutination tubes place 0.5 ml. of properly diluted antipneumococcal serum and float over it 0.5 ml. of clear supernatant fluid taken from the centrifuged peritoneal washings of a mouse injected with sputum or a suspension containing pneumococci.

2. Usually a precipitation reaction occurs immediately in the tube containing the homologous immune serum, but no precipitation occurs with the heterologous serum.

3. If the supernatant fluid is added carefully so that it does not mix with the serum, a positive test will be indicated by a ring of white precipitate at the point of contact.

4. When the fluid and serum are mixed, a positive test is indicated by a precipitate which is visible throughout the mixture. If no immediate reaction occurs, place the tubes in a water bath at 37° C., and observe after incubation for 15 minutes, 30 minutes, and 60 minutes.

## CYTOLYSINS AND COMPLEMENT

The cytolysins, also called *amboceptors* or *sensitizers*, are antibodies which lyse or dissolve bacteria or red blood cells. The visible reaction of lysis does not occur unless there is present a normal non-specific constituent of serum, called *alexin* or *complement*, which also combines with the cell.

Complement, normally present in the blood of all animals, deteriorates rapidly. It is thermolabile and is inactivated by a temperature of 56° C. for one-half hour. In order for complement to act, the cells must already have been sensitized by the amboceptor or sensitizer. Complement does not combine with antigen in the absence of amboceptor, but antigen and amboceptor will unite regardless of the presence of complement.

**Mechanism.** Ehrlich believed that complement acts upon antigen only indirectly through the amboceptor, which functions as a bridge between the first two. The Bordet view, held by most investigators, is that the union is a specific adsorption, the sensitized antigen being rendered susceptible to the action of complement.

**Pfeiffer Phenomenon.** It was noticed by Pfeiffer that living cholera vibrios, injected into the peritoneal cavity of guinea pigs that had been rendered immune, underwent certain changes when the peritoneal exudate was examined at various intervals. The organisms were observed to become (a) nonmotile, (b) swollen, (c) coarsely granular, (d) indistinct in outline, and (e) finally dissolved completely. This phenomenon of lysis was attributed by Pfeiffer to the presence of *bacteriolysin*, a specific substance which was present only in immune serum and could be transferred to normal animals by injection of immune serum.

The process was later shown by Bordet to be the result of the activity of two substances—one, the thermostable bacteriolysin which acted only in the presence of the other, the thermolabile complement, a constituent of normal serum. If the serum containing complement was inactivated by heating at 56° C. for one-half hour, the immune serum lost its ability to lyse the bacteria. However, if serum containing complement was added to such an inactivated serum, the bacteria were dissolved.

**Bordet-Gengou Phenomenon.** It was noted by Bordet and Gengou in 1901 that when inactivated specific immune serum and a culture of *Pasteurella pestis* were mixed together with complement, the complement was bound or fixed in destroying the bacilli. This was visibly shown by using a hemolytic system consisting of a suspension of washed rabbit red blood cells and antirabbit hemolysin. If complement had been free it would have been detected by the hemolytic system, and lysis of the red blood cells would have occurred, for hemolysin can act only in the presence of complement. However, in this case no hemolysis occurred. When normal serum was used

instead of immune serum it was noted that hemolysis of the red blood cells occurred. Since specific amboceptor was not present in the normal serum to sensitize the cells, the complement had not been bound, but was left free to take part in the lysis of the red blood cells by the hemolysin of the hemolytic system.

The reactions observed may be represented as follows:

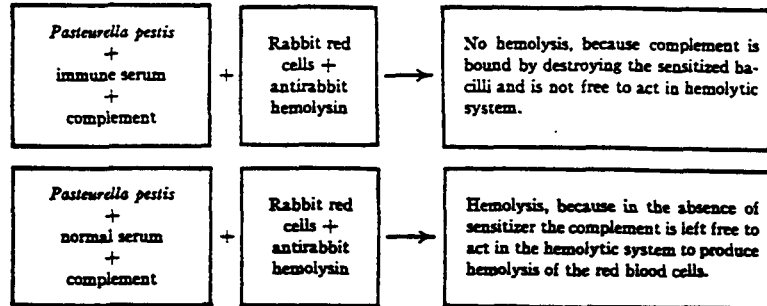

**Wassermann or Complement Fixation Test.** The hemolytic system employed by Bordet and Gengou to give a visible reaction for the union of antigen and antibody has been utilized in similar tests for the diagnosis of such diseases as glanders, syphilis, gonococcal and meningococcal infections, tuberculosis, and whooping cough. Wassermann perfected a complement fixation test for the diagnosis of syphilis. This test requires a bacteriolytic system and a hemolytic system, which gives an index as to whether the complement has been bound by the bacteriolytic system.

#### OPSONINS AND PHAGOCYTOSIS

One of the mechanisms whereby the body cells get rid of certain bacteria and foreign material is by ingestion of these substances. Any cell which destroys microorganisms by enveloping and absorbing them is called a *phagocyte*. The intracellular digestive process whereby the leucocytes and certain fixed cells eat up or phagocytize the various invading bacteria is known as *phagocytosis*.

**Opsonins.** Metchnikoff\* observed that the process of phagocytosis occurs more readily in the presence of immune serum than with normal serum. To the substance responsible for the enhancing of the tendency of leucocytes to engulf bacteria, Wright gave the name *opsonin*, and Neufeld called it *bacteriotropin*. That opsonins are necessary for the process of phagocytosis is shown by the observation that when bacteria or white blood corpuscles are washed free of serum, the absorption and ingestion of invading bacteria do not take place.

Opsonins are also present in normal serum. Following infection with certain microorganisms the amount of opsonins is increased. Opsonins exhibit characteristic antibody specificity. Their activity appears to be the result of two components—one thermostable, and one thermolabile, present in normal serum, and resembling complement in many ways.

Generally, there is a positive chemotactic influence exerted between the phagocytes and the bacteria. The leucocytes engulf the bacteria and ingest them. Bacteria so phagocytized first become swollen, then coarsely granular, finally lose their outline, and then disappear entirely within the cytoplasm of the phagocytes.

**Opsonic Index.** The opsonic action of a serum is measured by determining its opsonic index, which is the number of bacteria pha-

\* Metchnikoff's insistence on the importance of phagocytosis as the sole basis of immunity is incorporated in his *cellular theory* of immunity. This was opposed by Ehrlich's *humoral theory*, emphasizing the importance of chemical substances (antibodies) dissolved in the bloodstream.

gocytized by the unknown serum of a patient divided by the number destroyed by the normal serum (control).

**Phagocytic Cells.** Phagocytosis is produced by the microphages or wandering phagocytes, and the macrophages, and also the cells of the reticulo-endothelial system.

1. The *microphages* include the leucocytes. Following an infection of the skin with Streptococci there is a migration of polymorphonuclear leucocytes to the site of infection, and these ingest the bacteria. The leucocytes degenerate, become cloudy, swollen, and fatty, and disintegrate. These degenerated phagocytes plus debris, blood serum, and the digested bacteria constitute the substance commonly known as *pus*.

2. The *macrophages* include the large mononuclear leucocytes. In infection with *Mycobacterium tuberculosis* these cells surround the bacteria. The polymorphonuclear leucocytes do not appear in the later stages of the disease, but may be of some importance in the beginning of the disease in disposing of bacteria.

3. The *reticulo-endothelial system*, including the endothelial cells lining the capillaries and the liver, the spleen, the bone marrow, and the lymph sinuses, play some role in phagocytosis. It is claimed that these tissues are responsible for the production of humoral antibodies, and also phagocytize bacteria.

#### OTHER ANTIBODIES

It has been suggested that there are at least two other types of antibody actions. 1. *Ablastins*—reproduction-inhibiting antibodies which prevent multiplication of the invading organism. 2. *Neutralizing antibodies*—which render the infectious agent, generally a filterable virus, noninfective, when mixed and incubated with it.

#### MECHANISM OF ANTIGEN-ANTIBODY REACTION

The antigen-antibody reaction takes place in two stages. The first involves union of the elements, and the second, the consequences of that union which appear as agglutination, etc. Historically there have been two major theories proposed to explain the mechanism of the reaction.

##### Ehrlich's Side-Chain or Receptor Theory.

1. Interaction of antigen and antibody is a chemical phenomenon.  
2. Body cells obtain nutriment through localized cell substances called receptors or side-chains, which have combining affinities with food and other substances.

3. When bacteria or other foreign cells enter the body, the combining affinity of certain body cells may by chance be satisfied by bacterial or other substances.

4. By their union with toxin or other bacterial substance, the receptors are rendered useless for their normal physiological function.

5. The receptors are cast off and the body cell tends to regenerate the lost part and usually tends to overcompensate.

6. The receptors formed in excess of body needs are discharged into the bloodstream.

7. These free receptors are the antibodies.

8. Receptors are of varying degrees of complexity. Antitoxins are receptors of the first order, agglutinins and precipitins, second order, and lytic reactions, third order.

9. Similar representations were made of antigen and complement. For example, toxin was considered to have two functional parts—a haptophore which unites with the receptor, and a toxophore which exerts the poisonous effect. Toxoid was considered toxin in which the toxophore was destroyed or inactivated.

Although many immunological phenomena can be explained neatly by Ehrlich's theory, newer experimental evidence has often failed to confirm it and necessitated modifications of the original concept.

**Bordet's Adsorption Theory.**

1. Antigen and antibody solutions may be regarded as colloidal systems.

2. Union of the elements is an adsorption phenomenon, physical in nature rather than chemical.

This theory has been found satisfactory in many respects, its biggest failure being the inability to account for specificity.

**Modern Concept.** The modern concept of antigen-antibody reaction is an outgrowth of both of the previous theories.

1. The reacting substances are regarded as colloids.

2. Union of the elements is a highly specific adsorption phenomenon of surface chemistry, partly physical and partly chemical in nature.

3. The second stage of the reaction is an extension of the process of union and is therefore also specific.

**BIBLIOGRAPHY**

Boyd, William C. *Fundamentals of Immunology*. New York: Interscience Publishers, 1947.

Gershenfeld, Louis. *Bacteriology and Allied Subjects*. Easton, Pa.: Mack Publishing Company, 1945. Pp. 433-448, 457-476.

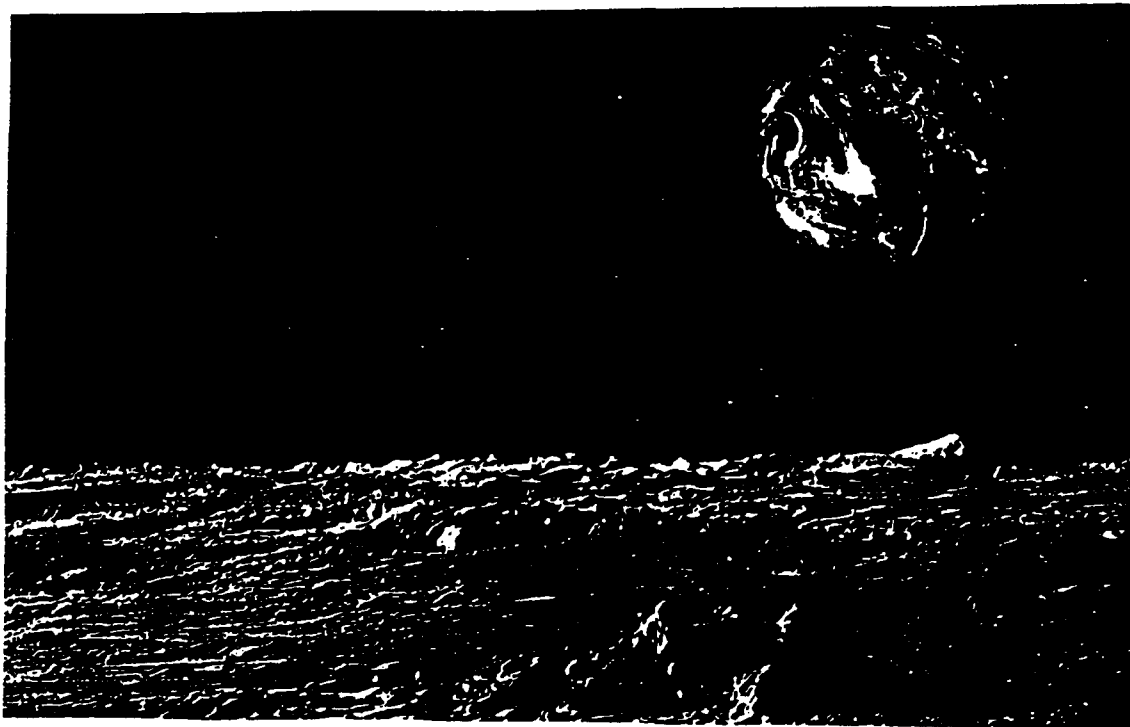

## M A T R I X I I I

### Data On Some of the Major Chemical and Drug Companies

1. Monsanto Chemical Company: President of Monsanto is *Earle H. Harbison, Jr.*, who was with the CIA from 1949 to 1967. He is also chairman of G.D.Searle, president of the Mental Health Association and a director of Bethesda General Hospital. Other directors of Monsanto are *William G. Ruckelhaus*, who was deputy Attorney General of the United States and Assistant Attorney General in the Department of Justice Civil Department from 1969-1970, administrator of the Environmental Protection Agency from 1970 to 1973, a director of the FBI, and a senior vice president for Weyerhaeuser Corporation; *Stansfield Turner*, who was director of the CIA from 1977 to 1981; *Jean Mayer*, who was also a director of UNICEF and WHO; *John Reed*, chairman of Citibank, director of Philip Morris, United Technologies, and Sloan Kettering Cancer Center; *John B. Slaughter*, director of General Dynamics, Naval Lab at San Diego. Monsanto is the producer of DDT and parathion, both forbidden chemicals in the US that are exported overseas.

2. Sterling Drug: This company, a spinoff from the I.G. Farben Cartel is another important drug firm. Its chairman is *W. Clark Wescoe*, a director of the super secret Tinker Foundation (similar to the Jacob Kaplan Foundation, the \$30 million Tinker Foundation funnels money to the CIA for covert activities to bizarre to be submitted to any government operations center). Some of the directors are *Gordon T. Wallis*, a director of the Federal Reserve Bank of New York, member of the Council on Foreign Relations and General Telephone and Electronics; *Martha T. Muse*, who is president of the Tinker Foundation, director of the Order of St. John of Jerusalem and the Georgetown Center for Strategic Studies. It seems that Martha is a vertiable directory of CIA worldwide operations. The secretary of the Tinker Foundation is *Raymond L. Brittenham*, general counsel for ITT, whose German operations were headed by Baron Kurt von Schroder, who was personal banker to Adolph Hitler. Another director of the Tinker Foundation is *David Abshire*, White House confidant on intelligence matters. He was at one time U.S. Ambassador to NATO in Brussels, which serves as world headquarters and command center for the Rothschild World Order. In 1987, the drug firm of Hoffman LaRoche made a bid for Sterling Drug, but it was bought by Eastman Kodak. Kodak banks at Chase Lincoln First Bank, owned by Chase Manhattan Bank.

3. Merck: The worlds largest drug firm. Its president, *John J. Horan*, is a partner of J.P.Morgan Company. Some of the directors include *John T. Connor*, who formerly worked in the Office of Naval Research and was at one time Special Assistant to the Secretary of the Navy; he is also a director of Chase Manhattan Bank; *John McKinley*, director of Manufacturers Hanover Bank, which all the

## M A T R I X I I I

Congressional records identify as a major Rothschild bank.

McKinley is also a director of Martin Marietta and the Sloan Kettering Cancer Institute. Another director is Ruben F. Mettler, chairman of TRW and a director of Bank of America. It might be mentioned at this point that on the board of TRW is William H. Krome George, former chairman of ALCOA and Martin Feldstein, former economic advisor to President Reagan.

4. American Home Products: This \$3.8 billion company banks at Manufacturers Hanover. Its CEO is John W. Culligan, who has been with the firm since 1937. Culligan is a Knight of Malta, a director of Mellon Bank, Carnegie Mellon University, American Standard and Valley Hospital. The president of American Home is John R. Stafford, director of Manufacturers Hanover.

5. Eli Lilly Company: Chairman of Lilly is Richard D. Wood, director of Standard Oil, Chemical Bank of New York, Elizabeth Arden, IVAC Corporation, Physio-Control Corporation, and the American Enterprise Institute for Public Policy Research. Some of the directors of Lilly are: Randall H. Tobias, also a director of AT&T and Home Insurance Corporation; C. William Verity, Jr., who is also a director of Chase Manhattan Bank and is associated with the U.S.-U.S.S.R. Trade and Economic Council, also known as USTEC, whose records are classified Top Secret -several FOIA requests are now under way to force the government to release USTEC documents. Another USTEC member is Dwayne Andreas, grain tycoon who is head of Archer-Daniels-Midland Corporation and who financed CREEP, the organization which brought about the resignation of Nixon; the most noteworthy member of USTEC is Mrs. Nelson Rockefeller. USTEC was the brainchild of a top KGB official, who promoted it at the 1973 summit meeting. Lilly's Oraflex, an arthritis drug, was on the market and used by 600,000 Americans before it was withdrawn due to its side effects.

6. Hoechst A.G. of Germany: A spinoff from I.G. Farben. It operates a number of plants in the United States. Hoechst manufactures antibiotic food additives for pigs and chickens (Flavomycin) and other pharmaceuticals used in animal breeding. Hoechst marketed an analgesic in the U.S. that was found to cause anemia. It was banned in the U.S. so it was then sold in Latin America and Asia. The drug was chloromycetin. Hoechst also produced the drug Merital, which was approved by the FDA in 1984 but was withdrawn two years later because of fatal reactions, including hemolytic anemia. Another was Wellbutrin, which was discovered to cause convulsions in woman and was removed in March 1986.

7. E.E. Squibb: The worlds 11th largest drug firm. Chairman of Squibb is Richard E. Furland, who is also a director of



## M A T R I X I I I

Olin Corporation, a leading munitions firm, and a trustee of Rockefeller University and the Sloan Kettering Cancer Institute. Directors of Squibb include J. Richardson Dilworth, the longtime financial trustee for all the members of the Rockefeller family. Some of the other directors for Squibb are Burton E. Sobel, a director of the National Institutes of Health; Rawleigh Warner Jr., chairman of Mobil Corporation and a director of AT&T and Allied Signal (the \$9 billion a year defense firm)

8. Sandoz of Switzerland: In 1943, LSD was developed by Sandoz chemist Albert Hoffman. Sandoz owns Northrup King, the huge hybrid seed company, Viking Brass and other firms.

9. Bristol-Myers: Its CEO is Richard Gelb, chairman of the Rockefeller-controlled Sloan Kettering Cancer Center, a director of the Federal Reserve Bank of New York, the New York Times, New York Life Insurance and the Council of Foreign Relations. Directors of B-M include William M. Ellinghaus, president of New York Telephone, a Knight of Malta of the Holy Sepulcher of Jerusalem, president of AT&T and a director of Textron; John D. Macomber, a director of Chase Manhattan Bank; Martha Wallace, a member of the Trilateral Commission, director of RCA, American Express, Chemical Bank, New York Stock Exchange, New York Telephone and chairman of the finance committee of the CFR. Martha is also a member of the super secret American Council on Germany, which was said to be the covert government of West Germany before the wall came down.

10. Ciba-Geigy of Switzerland: Ciba is the worlds fifth largest drug company. It does a \$10 billion business in the United States and manages ten drug companies. Ciba started off early in 1934 when its products Batero Vioform and Mexon were found to cause nerve disorders. Ciba-Geigy is also the source for Ritalin, which has become the principle means in schools of controlling "hyperactive" children. To provide for the use of this drug, social workers coined the new term ADD (attention defect disorder), which could be controlled by 20mg tablets. One of my sons was forced to take this substance for a while; I had to move to get him away from it. Ritalin has had a 97% increase in use since 1985. Students are forced to take the drug or face expulsion.

11. Bayer A.G. of Germany: One of the spinoffs from I.G. Farben after WWII. Bayer is now larger than the original I.G. Farben. In 1981 it bought Agfa Gevaert, another spinoff, and in 1983 Cutter Laboratories, a California firm set up to protect the Rockefeller monopoly from prosecution in the great polio immunization wars.

## M A T R I X I I I

12. Glaxo Holdings: Glaxo typically has over \$3.4 billion in sales per year. Its chairman is Austin Bide; deputy chairman is P. Girolami, a director of National Westminster Bank, one of England's big five banks. Other directors are Sir Alistair Frame, who is also chairman of Rio Tinto Zinc, one of the three firms which are the basis of the Rothschild fortune. Frame is also on the board of another Rothschild holding, the well known munitions firm, Vickers, and also Plessey, a defense firm which recently bid on a large contract with the U.S. Army; J.M. Raisman, chairman of Shell Oil UK Ltd, Lloyds Bank, and British Telecommunications; R.G. Dahrendorf, one of the world's most active socialists and a member of the Bilderbergers, having attended their May 10, 1985 meeting in Rye, New York. Current Federal Reserve chairman Alan Greenspan also attended and is Bilderberger member.

13. Hoffman LaRoche: The firm's biggest seller was Siropin in 1896; its sales of Valium and Librium (both substances which are naturally produced in the body) now amount to over 1 billion per year. Hoffman received a lot of publicity in 1988 because of its drug Accutane, which caused, according to the FDA, 8,000 spontaneous abortions; it was also in trouble in 1986 for its drug Versed, which caused 40 deaths; its subsidiary was responsible for the dioxin incident in Italy. Roche also produces Matulane, which is used in cancer "therapy". The drug causes anemia, leukopenia, thrompenia, and has side effects which include leukemia, tachycardia, vomiting and pain.

14. Syntex: Chairman and president of Syntex is Albert Bowers, a member of the council at Rockefeller University. Some of the directors are Martin Carton, who is also executive vice president of Allen and Company, a Wall Street investment firm which was rumored for years to be the investment arm of Meyer Lansky's \$500 million fortune from Mafia activities; Leonard Marks, who was Assistant Secretary of the Air Force from 1964-68; Anthony Solomon, who was appointed Under Secretary for Monetary Affairs of the Treasury Department, 1977-1980, and succeeded Paul Volcker as president of the Federal Reserve Bank of New York when David Rockefeller moved Volcker to the Federal Reserve Board of Governors in 1980. Solomon is also a director of Banca Commerciale Italiana. Syntex is remembered for the mercurial rise in its stock when it began to dump vast amounts of condemned drugs in backward overseas countries.

15. Burroughs Wellcome: Owned by the Wellcome Trust of England; its director is Lord Franks, a longtime trustee of the Rockefeller Foundation. Burroughs Wellcome is the source of AZT, the AIDS drug that is said to prolong the life of AIDS victims.

## M A T R I X I I I

16. Abbott Laboratories: President of Abbott is Robert Schoellhorn, a director of Pillsbury and ITT. Some of the directors include K. Frank Austen, professor at the Harvard Medical School since 1960 and a chief physician at the Beth Israel Hospital since 1980 and serves with the American Board of Allergy and Immunology; Joseph Charyk, who was the space director of Lockheed and the Under Secretary of the Air Force from 1959-1963, director of American Securities Corporation, Draper Laboratories, General Space Corporation, and COMSAT Corporation. Other directors such as Philip de Zulueta have connections to Rio Tinto Zinc and the Canadian Bronfman family.

17. Unilever: Unilever was founded in 1894. It is headed by Lord Hunt of Tanworth, who is chairman of the top-secret Ditchley foundation (conduit for instructions between the governments of the US and England), chairman of Banque Nationale de Paris and director of Prudential Corporation and IBM; Kenneth Durham, a chairman of Woolworth Holdings, United Technologies, Chase Manhattan Bank, Air Products and Chemicals, and an advisor to the New York Stock Exchange. Unilever owns Lever Brothers in the United States, Thomas Lipton Company and Lawry's Foods.

18. American Medical International: Located in Beverly Hills, California and has 40,000 employees. Directors include Henry Rosovsky, director of the Merican Jewish Congress since 1975 and a member of the Harvard Corporation; Bernard Schriever, a former general in the USAF and a director of Control Data; S. Jerome Tamkin, head of Tamkin Securities.

19. Velsicol: This U.S. company sold 3 million pounds of a pesticide, Phosvel (leptophos), which had never been approved by the FDA and exported it to 30 countries, where it caused extensive damage to the nervous system in humans who consumed food that had been treated with it. Velsicol is a subsidiary of Northwest Industries, a company in Chicago.

20. Smith, Kline Beckman: This company made millions by peddling the drug known as "speed", Dexedrine and Dexamil. Executives of SKB have pleaded guilty to 34 charges of covering up deaths and cases of severe kidney damage in patients using their drug Selocrinm which was finally removed from the market. SKB's blood pressure drug, Selacrin, sold 300,000 prescriptions in eight months.

21. Pfizer: Pfizer withheld information from the FDA about Feldene (pyroxicam, an arthritis drug), despite deaths and harmful side effects that occurred in other countries. The company banks with Chase Manhattan Bank. Directors of

## M A T R I X I I I

Pfizer include Paul Marks, professor of human genetics at Cornell who is also associated with the NIH and the National Cancer Institute and a director for the American Association for Cancer Research and chief of the Sloan Kettering Cancer Center since 1980; Grace Fippinger, an advisor to Manufacturers Hanover and a board member of the American Cancer Society; William J. Kennedy, a director of Mobil Oil (with Alan Greenspan); Benjamin Buttenweiser, whose wife was attorney for Alger Hiss while Buttenweiser was Assistant High Commissioner for occupied West Germany.

### **Some Scientific and Technological Predictions from 1984**

#### **Predictions in Military Science**

1. Think tanks where experts plan future wars.
2. Improved missiles and bombs.
3. Planes independent of earth.
4. Lenses suspended in space.
5. Floating fortresses to guard important sea lanes.
6. Germs immunized against all antibodies.
7. Self-propelled bombs to take the place of bombing planes.
8. Earthquake and tidal wave control.
9. Efficient defoliants that could be spread over wide areas.
10. Soil submarines that could bore through the ground.

#### **Predictions in Police Technology**

1. Data banks containing detailed personal information.
2. Rapid access to and retrieval of data.
3. Two-way, flush-mounted televisions.
4. Remote sensor of heartbeat.
5. Tone-of-voice analyzer.
6. Sensitive omnidirectional microphone.
7. Police patrol helicopters.
8. Large telescreens for public viewing.
9. Memory holes for rapid destruction of information.
10. Scanner to detect and analyze human thought.

#### **Predictions in Psychobiology**

1. Improved electrotherapy.
2. Better techniques for hypnosis.
3. Improved truth drugs.
4. Control of the sex drive, specifically by abolishing orgasm.
5. The ability to artificially inseminate.
6. Reconditioning by implosive therapy or flooding.
7. New forms of physical and psychological torture.
8. A science of determining thoughts by facial expressions and gestures.
9. Televised group therapy.
10. Subcortical psychosurgery.



**MASS DEMONSTRATIONS IN TOKYO  
OF BLINDED AND OR PARALYZED SMON VICTIMS**

In 1978, a Tokyo court found 3 drug manufacturers – Takeda, Ciba-Geigy Japan, and Tanabe Seijaku – guilty of selling drugs containing Clioquinol which caused roughly 30,000 cases of blindness and/or paralysis and thousands of deaths. As is customary, the manufacturers were permitted to stay out of jail, provided they pay adequate indemnities to the victims or their survivors. Medical doctors at the trial testified that Clioquinol (sold under 168 different labels) was not merely useless against diarrhea, which it was advertised to heal, but that it could actually *cause diarrhea* when taken preventively, as the manufacturers recommended. The Health authorities of Switzerland, where the drug originated, allowed it to remain on the market although many other countries had ordered its withdrawal. Thus Clioquinol kept being sold under various labels, such as Mexaform, Entero-Vioform, Intestopan, Sterosan, and others. The manufacturers' profits keep increasing. So do the diseases they produce.

# Pricing Pressures and Politics Dog Successful Glaxo

## As Danes and Others Assail New-Drug Costs, R&D Expenditures Soar

3-2-92

By STEPHEN D. MOORE

Special to THE WALL STREET JOURNAL

LONDON—For years, Glaxo Holdings PLC has been a model company in Europe's drug industry.

Although it may have acted a trifle too aggressively for some, the British drug maker has been deftly managed to produce the industry's fattest profit margins. And Glaxo has been immensely inventive, cranking out a steady stream of pioneering medicines for such ailments as migraine and chemotherapy-related nausea.

"The best pipeline of blockbuster in Europe, perhaps in the world," Duncan Moore, a London-based analyst for Morgan Stanley & Co., calls it.

But now Glaxo is coming under increasing fire for some of the very things that have made it strong. Just last week, Denmark asked the European Community Commission to investigate Glaxo's pricing of some of its new drugs. The Danish authorities specifically cited what they consider outrageously high prices for Zofran, Imigran and Serevent, three blockbuster drugs for previously untreatable maladies, which are reaching markets years ahead of rival medicines.

While even the Danes acknowledge that their complaint probably won't have much immediate impact as it works its way through the EC bureaucracy, its filing does reflect a growing threat for pharmaceutical companies like Glaxo. From Rome to Tokyo, increasingly desperate governments are struggling to bring runaway health-care spending under control. Prescription drugs typically represent only about 10% of total health-care outlays. But hugely profitable international drug producers make attractive targets.

At the same time, Glaxo is running into more competing new drug therapies and into stiffer competition from generic and over-the-counter drugs. And new biotechnology approaches are sending research and development costs out of sight. It all comes as Glaxo is making two transitions—to the new leadership of Chief Executive Officer Ernest Mario, and away from relying on a single drug.

Between 1981 and 1991, Glaxo raced from obscurity to the pinnacle of the \$200 billion-a-year global drug industry. The company's sales nearly quintupled, and pretax profit multiplied 14-fold. Today Glaxo is Europe's biggest drug-maker and ranks second to Merck & Co. in annual sales in the U.S. and world-wide.

Sir Paul Girolemi, Dr. Mario's prede-

### Glaxo Holdings PLC by the Numbers

#### The Profit Picture

Annual pretax profit in millions of pounds

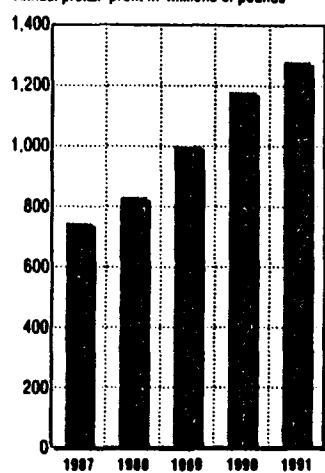

#### The Fundamentals

	6/30/92	6/30/91
SALES (£ bil.)	£4.18	£3.40
PRETAX PROFITS (£ bil.)	£1.43	£1.28
R&D OUTLAYS (£ mil.)	£819	£475
CAPITAL SPENDING (£ mil.)	£200	£621

#### INDUSTRY RANKING:

No. 1 in Europe; No. 2 world-wide and No. 2 in U.S. after passing Bristol Meyers Squibb during 1991.

#### MAJOR PRODUCT LINES:

A range of pharmaceuticals with special emphasis on antibiotics and drugs that treat ulcers and respiratory ailments.

#### MAJOR COMPETITORS:

For anti-ulcer drugs, Astra, Merck and SmithKline Beecham.  
For respiratory drugs, Astra, Boehringer Ingelheim and Fisons.

Source: Glaxo, Morgan Stanley & Co.

cessor as chief executive, led Glaxo through that surge and continues as chairman. In the company's latest annual report, Sir Paul reminded shareholders that the dazzling ascent was powered by a single product—Zantac, an anti-ulcer medicine that has been the world's biggest selling drug the past five years. "But," he warned, "the dynamics of expansion in the years ahead will be different."

Dr. Mario, an American who is now 53 years old, joined Glaxo from Squibb Corp. in 1986. Hired to run Glaxo's U.S. unit, he was appointed group chief executive in a surprise top-management shuffle three years later. He was promoted again to deputy chairman late last year.

Industry analysts expect the affable Dr. Mario's low-key approach and polished public speaking style to make him effective in crucial appearances before drug regulators as well as in wooing investors. But his main asset, the analysts add, is his drug-industry acumen.

Dr. Mario will need plenty of savvy. He has been outspoken in warning about a backlash from drug purchasers, especially state-run national health services across Europe. Glaxo and other major companies are taking voluntary steps in hopes of avoiding tougher measures. Glaxo, for ex-

ample, offered discounts to the U.S. Medicaid system totaling \$60 million in the six months ended Dec. 31. Similar price concessions have been extended to other U.S. health-care providers.

At the same time, Dr. Mario estimates that today it costs \$230 million to get a new medicine to market. And the odds against success are daunting. Only one in 4,000 compounds synthesized in research labs reaches the market.

Consequently, only huge international companies with global sales forces stand much of a chance of earning back the costs of developing a drug before patents expire, analysts say. "This pricing thing is not going to go away," Dr. Mario says. "Mid-range drug companies are really going to get squeezed; there is going to be a major shake-out."

#### More R&D Spending

Glaxo is spending more than ever on R&D, Dr. Mario says. The company's R&D budget is expected to climb 26% in the fiscal year ending June 30, and probably 22% more during fiscal 1993. Dr. Mario worries about the challenge of effectively managing such hefty R&D spending. But for Glaxo there isn't any alternative, he insists: "It's what got us here."

Expensive new product launches the next two or three years also will balloon Glaxo's marketing tab, shaving profits at least temporarily, analysts suggest. Still, they expect Glaxo's pretax profit growth to keep pace with sales. UBS/Phillips & Drew projects 12% annual earnings growth the next two years. Glaxo American depositary receipts were quoted yesterday at \$27.75 a share, down 25 cents, in late New York Stock Exchange composite trading.

#### Some Bright Spots

The brightest spot in Glaxo's fiscal first half was surging demand for Zofran, used to relieve nausea in cancer patients undergoing chemotherapy. It's the first of Glaxo's trio of blockbusters expected to reach annual sales of more than a billion dollars. Glaxo researchers have reported promising discoveries using Zofran-related compounds in treatment of schizophrenia and age-associated memory impairment. Some analysts think central nervous system applications eventually will dwarf the current anti-nausea treatments.

With Serevent, an anti-asthma medication, Glaxo's product development may have been overtaken by changing medical opinion. Serevent relieves asthma attacks by opening the victim's airways. But critics claim this approach leaves asthmatics vulnerable to assault from airborne allergens and pollutants, and perhaps even at an increased risk of death. In place of such therapy, many specialists urge increased use of so-called cortico-steroids with anti-inflammatory action that appears actually to heal asthma.

Glaxo has the world's best selling anti-asthma steroid and an even more promising product at an advanced stage of development. So the company stands to benefit regardless of how the asthma therapy debate is resolved.

With Serevent under a cloud, Imigran now looms as Glaxo's biggest potential blockbuster. Dr. Mario expects formal clearance of Imigran in the U.S. sometime this spring.

Imigran is the first safe medicine for migraine, and one for which no competition is expected to surface for several more years. It's hard to gauge Imigran's sales potential. Yet conservative Imigran forecasts have been enough to alarm health providers around the world. Denmark's minister of health recently said potential demand for the new migraine drug could swallow one-third of the country's annual budget for prescription drugs.

Chapter 7

THE ELECTRONIC MANIPULATION OF POPULATIONS

There are two main aspects of the electromagnetic manipulation of human beings that need to be reviewed. The first one is the development of man-made electromagnetic fields and the effect on human beings. The second is the development of electromagnetic methodology for the deliberate control of the physiological, psychological and behavioral functions of human beings, mind control. We will discuss the research that reflects advanced mind control applications that has been done since the publication of Matrix II. Be sure that you have read the information in previous chapters.

I. MAN-MADE ELECTROMAGNETIC FIELDS AND THEIR EFFECTS

The supplementary electromagnetic fields that were superimposed over the already existing natural electromagnetic phenomena began in the late 19th century. By 1882, Thomas Edison had set up the first generating station in the United States, transmitting low-voltage direct current (DC) to downtown New York. Around the same time period, Tesla developed the alternating current (AC) system which was capable of transmitting greater power over longer distances. By 1894, Tesla's generators at Niagra Falls were in operation. By 1898, AC transmission lines 75 miles in length were in use in California.

In 1890, Heinrich Hertz discovered that a spark gap would produce a spark at a similar gap a few feet away without being connected. Hertz would later be involved with several other scientists in the rewriting of Maxwells equations - an action that would severely limit human progress in the field of physics and electronics thereafter. In 1901, Marconi transmitted the letter "s" across the Atlantic ocean, followed by radio transmissions in 1918 from England to Australia. By the late 1920's, commercial radio transmissions had become commonplace and electrical power of up to 200,000 volts was being transmitted over hundreds of miles by means of Tesla's technology.

Since World War II it is estimated that electric power and communication systems have been growing at between five and ten percent per year. New technologies have appeared which include cellular telephone networks and satellite relay stations - in short, the human population has been overwhelmed with a profusion of electromagnetic smog. Before 1900, the electromagnetic field of the Earth was composed of the GMF and its associated micropulsations, visible light, and random discharges of lightning. What was not realized by the majority





## M A T R I X I I I

of people was that the exposure of living organisms to abnormal electromagnetic fields results in significant abnormalities, both in physiology and behavior.

Electrical power systems operate at 50-60 cps, just above the highest naturally occurring frequency of 30 cps. Microwave systems operate at billions of cycles per second and are rapidly getting closer to the trillion-cycle frequencies of visible light. The previously empty electromagnetic spectrum between these two extremes was filled with man-made radiation in less than 80 years.

When man began to make use of the electromagnetic spectrum, it was recognized that it could be generally divided into two areas. Frequencies below those of visible light lacked the power to produce ionization of the chemical structures of the body and were called non-ionizing radiation. Frequencies higher than visible light contained enough energy to damage physical organisms: ionizing radiation caused the formation of free radicals within an organism and other damaging effects. Because non-ionizing radiation appeared to lack the ability to produce these effects, it was assumed that it had no biological effect. In fact, it was assumed that any biological effect that was not the result of ionization was the result of heat, since it was discovered that frequencies of about 27 million cycles (27 MHz) and higher produced heating of tissues. The dividing line for the production of heating effects was set at 27 MHz.

In 1953, Dr. John McLaughlin, a medical officer for the Hughes Aircraft Corporation, identified cases of unexplained bleeding, leukemia, and brain tumors among workers exposed to low-strength microwaves. Since most of the Hughes contracts were military contracts, it turned the problem over to the military. In 1955, the British journal *Nature* reported that a short exposure to pulsed, 27 MHz radio signals produced abnormalities in the cells of the growing root tips of plants; it was the same frequency, 27 MHz, that had been assigned to the medical profession for use in radiowave therapy. The study was ruthlessly criticized. Within ten years, other researchers reported the same results at the FDA. Others reported finding the same effect at "non-thermal" levels.

### Creation of "Safety Standards"

In 1950's, the Department of Defense recognized the necessity for adoption of some sort of standards for exposure to microwaves. This led directly to the establishment of the Tri-Services Program, which was based at the Rome Air Development Center in Rome, New York, and given the task of determining this standard.

Reports of non-thermal effects were pretty much ignored despite their obvious implications, and the military continued

## M A T R I X I I I

to dominate the field with their view that ionizing radiation was the only dangerous radiation and that there were no biological effects other than "thermal effects". However, some "safety standard" had to be developed for the thermal effects.

On the basis of theoretical calculations, it was postulated that microwave exposure at 100 milliwatts (mW) to an area of 1 square centimeter of body surface would exceed the ability of the blood circulation to carry away the heat produced, and local tissue heating would occur. By 1957, the military adopted a standard for exposure to microwaves of 10mW/cm<sup>2</sup>. In 1966, the American National Standards Institute adopted the same standard for recommended civilian exposure for occupational purposes.

This is all that is generally known by most people about the creation of the ANSI standard for exposure of 10mW/cm<sup>2</sup>. A little more digging, however, revealed a little more of the covert aspects behind the development of this so-called "standard".

The generally proposed 10mW/CM<sup>2</sup> EMR exposure limit was done under the Tri-Services program based on the work of Professor Herman P. Schwan, a former Nazi scientist who entered the United States in 1947 under Project Paperclip. Schwan created a "model" in 1953 using metal balls and flasks of salt to simulate the human body.

With little debate or experimentation, industry and the military accepted the results of Schwans experiments as representing a true picture of thermal effects.

Adoption of the standard by ANSI is remarkable since Schwan consistently maintained that his dosage limit was safe for probably no more than an hour. (Becker, R.O., and Selden, G. (1985), *The Body Electric*, New York: Morrow); (Schiefelbein, S. (1979), "The Invisible Threat. The Stifled Story of Electric Waves", *Saturday Review*, 15 September, p16-20).

There were persuasive economic reasons why the 10,000-microwatt [=10mW/cm<sup>2</sup>] standard was and still is defended at all costs. Lowering it would have curtailed the expansion of military Electromagnetic Research and cut into the profits of the corporations that supplied the hardware. A reduced standard that was safe would constitute an admission that the old one was unsafe, leading to liability for damage claims from ex-GIs and industrial workers. One of the strongest monetary reasons was given in a 1975 classified summary of the Department of Defense Tri-Service Electromagnetic Radiation Bioeffects Research Plan:

"Lower standards will significantly restrict the military use of EMR in a peacetime environment and require the procurement of substantial real estate around ground-based EMR emitt-

## M A T R I X I I I

ers to provide buffer zones". The needed real estate was estimated at that time to be 498,000 acres. The price of the land would surely run into billions of dollars. (Becker and Selden, p305)

In 1982, ANSI "reviewed" reviewed the original 10mW/cm<sup>2</sup> standard and revised it in light of "new knowledge". This time, great attention was paid to the theoretical relationship between the wavelength of a radio signal and the length of the human body. If we say that the average human body is six feet in length, then the frequency range of 80 to 100 MHz would overlap both above and below six feet. This frequency just happens to overlap the 88 - 108 MHz FM frequency band. Again, with nothing more than theory, ANSI adopted a new "standard" that was frequency dependent but was still based on the "thermal-effects" concept alone.

In 1984, The Environmental Protection Agency was on the point of proposing a standard of 100uW/cm<sup>2</sup> but was forced to back down under pressure from its own policy office. In 1988, the EPA announced that it was postponing its decision indefinitely (Microwave News, Sept/Oct 1988).

Even if the ANSI, which is composed of key researchers for industry and the military, adopted a standard which was designed to limit exposure to reasonable levels, the ANSI standards are recommendations, not provisions that are enforceable. There exist no enforceable standards in the U.S. for the limitation of electromagnetic radiation. Some states have adopted certain limitations through their legislatures, but those limitations are within ANSI guidelines. Its sort of like asking the fox to guard the henhouse.

Despite the denial by the military and the government of biological effects from non-ionizing radiation, in 1974 the Office of Naval Research began collecting published scientific reports from around the world in the general area of "biological effects of non-ionizing radiation" and publishing abstracts as a digest. This digest is still being published.

### The University of Washington Study

Dr. Arthur Guy, a former consultant for ANSI, participated in a \$5 million study at the University of Washington that was funded by the U.S. Air Force School of Aerospace Medicine in the early 1980's. It was a \$5 million study that backfired. The study was to determine if there were potential hazards to human beings from chronic exposure to microwave radiation. In the study, Guy used *gnotobiotic* rats, meaning that they were considered germ and virus free. This fact alone was one of the reasons for the excessive cost. All of the animals used, both experimental and control animals, were gnotobiotic.

## M A T R I X I I I

In this study, rats were continuously exposed to high-frequency microwaves of 2.45 GHz (billion Hz) at a field strength of .5mW/cm<sup>2</sup>, twenty times lower than the "safe" thermal level. One hundred fifty-five measurements of health and behavior were collected. According to Guy, there were primary malignant tumors that developed in eighteen of the exposed animals but in only five of the controls. Guy made the attempt to get around the results of the test by saying that the results were "not statistically significant or came and went, suggesting that they may be due to chance."

The use of "germ-free" animals in the experiments would seem odd, because we live in world surrounded by organisms. An experiment on germ-and-virus free animals has no relevance to the real world. Present evidence seems to indicate that at least 20% of human cancers are caused by viral infection, and this percentage appears to be even higher in animals. Therefore, animals that are maintained to be gnotobiotic should have an incidence of cancer that is much lower than expected. It is also well established that exposure to any abnormal electromagnetic field produces a stress response. If the exposure is prolonged, the stress response system becomes exhausted, and the competency of the immune system declines to below normal. In such a state, animals and humans are more susceptible to cancer and infectious diseases.

One can only conclude that the experiment was deliberately designed to sharply reduce the incidence of cancer and infectious diseases in the exposed animals. There can be no other reason for the requirement that the animals be gnotobiotic. In Guy's study, the fact that the experimental animals had a lower-than-normal incidence of cancer was totally expected. What was unexpected by Guy was that even with this protection, the cancer incidence in the animals exposed to microwaves was four times that in the control animals. The well-designed experiment that should have "proved" that "microwaves are safe" fell into its own trap, and the nature of the trap is revealed by the types of cancer that occurred in the experimental group. These were mainly limited to cancers of the pituitary, thyroid, and adrenal glands. The experiment was designed to prevent the results of stress, but the planners forgot that it would produce stress. Because stress resistance is connected with the glands just mentioned, we must conclude that microwave exposure produced an extremely high level of stress. If the animals had been normal instead of germ-free, they would have died long before the close of the experiment. This project was reported in the July-August 1984 issue of *Microwave News*. Another oops! for the government.

### Microwaves and Genetic Effects

In 1983, studies by the FDA Center for Devices and Radiological Health reported that sperm production in male

## M A T R I X I I I

mice exposed to non-thermal levels of microwaves decreased and was accompanied by significant abnormal changes in the structure of the chromosomes of the sperm. Researchers E. Manikowska-Czerska, P. Czerska, and W. Leach concluded that chromosomal abnormalities were produced by microwave exposure at dose rates far below those producing a heating effect. They noted that the mechanism appeared to be a direct effect of the microwaves on the chromosomes themselves.

In a recent study, doctors at Boston's Brigham and Women's Hospital surveyed 69,277 newborn infants and identified infants with major developmental malformations. Some of these had no family history of problems, and the malformations appeared to be the result of spontaneous mutations. The infants were born during the years 1972-1975 and 1979-1985; it appears at this time that at least 30 percent of genetic developmental defects in human infants are the result of some external cause.

Vernon, New Jersey is a small town of about 25,000, but it is fifth in the nation for the number of microwave transmitters. The incidence of Downs Syndrome cases in Vernon is 1000% above the national average.

A possible explanation for the production of genetic effects by microwaves is that the wavelengths of the microwave radiation may be small enough to have a resonant effect on the DNA molecule or the chromosomes. In 1988, Dr. Reba Goodman reported at a meeting of the Bioelectromagnetics Society that the effects appeared to be different for different frequencies, and that they also differed depending on the type of cell exposed. Both ELF and microwave radiation have the capability to influence genetic material during the process of cell division. There are even indications that DC fields can influence mitosis and chromosomal patterns.

### Microwaves and Brain Tumors

During the years between 1940 and 1977, there was an unprecedented increase in the use of microwaves. During that same period, the incidence of primary brain tumors rose between 1.70 to 2.00 per 100,000 people.

### ELF Radiation From Powerlines

While only a portion of the population is exposed to microwave radiation, most of the population is exposed to the 60 Hz fields given off by the electrical web that surrounds the population. The 60 Hz electric power frequency lies within the band termed "extremely low frequency" (ELF), which covers the region from zero (DC) to 100 Hz. It was formerly

## M A T R I X I I I

considered impossible for an ELF field to have any biological effect; the wavelengths average about 3,000 miles. These ELF fields, however, have some interesting properties. They may be transmitted over great distances through the ionospheric cavity, a factor that played a part in Project Sanguine. This project was instituted by the Navy, using huge antenna arrays designed to operate at either 45 Hz or 70 Hz in order to have communication with the submarine fleet as far away as the Indian Ocean. A large antenna was constructed at Clam Lake in Wisconsin, and studies were done to gauge the effects on nearby humans - a study that was completed in 1973. It was found that a one-day exposure to the field produced a significant increase in the serum-triglyceride levels in 90% of the people studied. Serum-triglyceride levels are increased by the stress response and are related to fat and cholesterol metabolism.

The power field strength from Project Sanguine was a million times smaller than that of the field produced by the ultra-high voltage (275 Kva and above) transmission lines that criss-cross the country. After the meeting to discuss the results, the Navy denied that the meeting had ever taken place and insisted that it had no knowledge of any scientific studies indicating possible harm to human beings from the operation of the Sanguine system.

The results of chronic exposure to 60 Hz electric fields are many. British studies are far more numerous and more widely published than American studies. Dr. Stephen Perry, who worked for the British National Health Service as a family practice physician in a rural area of England reported that he had observed that his patients who lived near electric power lines appeared to have a higher incidence of mental disturbances and suicide. This was not well received by various authorities. There were subsequent epidemiological studies which confirmed the data, and the findings were published in 1976. A second study was published in 1979.

Dr. Nancy Wertheimer, an epidemiologist at the University of Colorado, was examining the possible relationship between the magnetic field from electrical lines (not the high-voltage lines we previously discussed, but the secondary lines that are strung everywhere). She made a startling discovery: 60 Hz magnetic fields with strengths of only 3 milligauss ( three-thousands of a Gauss - the Earths magnetic field averages .5 Gauss) were statistically related to the incidence of childhood cancers. This field strength is many times smaller, as mentioned above, than the Earths normal magnetic field strength, and it is far below the average strength of 100 mG at a distance of approximately 50 feet from the standard transmission line. Wertheimer published her data in 1979. Her paper was immediately subjected to bitter criticism, solely on the disbelief that it could be true.

## M A T R I X I I I

New York State did a study of power lines costing \$500,000 that was conducted over a five-year period. The New York State Department of Health decided to have Dr. David Savitz of the University of North Carolina repeat the Wertheimer study. After five years, Savitz obtained the same results as Wertheimer. He reported that 20% of childhood cancers appeared to be produced by exposure to 3-milligauss power frequency magnetic fields. The results of the New York State Power-Lines Project were released in 1987. It contained this information as well as information which indicated that power-frequency fields had significant behavioral and central nervous system effects, as well as a stimulating effect on cancer cell growth. For the Public Service Commission, the results of this study were a real embarrassment. The magnetic field at the edge of the right-of-way (ROW), about fifty feet away from the standard 345 Kv transmission line, averages 100 milligauss. These lines constitute the bulk of the transmission lines in the United States. If a 3-milligauss standard were applied, the ROW around almost all transmission lines would have to be considerably enlarged. In addition, many of the distribution lines (secondaries) generate similar strength fields in adjacent residences, and their power would have to be significantly reduced. The Public Service Commission, in a dizzying flight from reality, set a "safe" level of 100 milligauss, claiming that the public had "accepted this level of risk", which was nonsense. The public had been unaware of any risk before these studies became common knowledge, and even after the public was told that while some risks might be present, "further research was necessary", a phrase that is repeated in countless areas where the health of the public is endangered by irresponsible, irrational, and power-hungry bureaucrats. The public was never asked if it accepted any such risk.

An interesting part of this picture is that the government continually performs studies about the effects of electromagnetic radiation exposure, discovers negative effects, and then ignores the results and denies the studies were ever done, which might be a further indication that sometime way in the last, the "powers-to-be" carefully guided the choice of these frequencies to promote the decimation of the population.

An interesting thought. In 1986, the Navy entered the picture again. The Office of Naval Research supported an international study, called Project Henhouse, to study the effects of ELF pulsed fields. In June of 1988, the results of this study were reported at a meeting of the Bioelectromagnetics Society. Five of the six laboratories reported that "apparently, very low-level, very-low-frequency, pulsed magnetic fields contribute to increased abnormality incidence in early embryonic chicks." It is clear that magnetic fields as small as 1 milligauss have the potential to produce developmental abnormalities.

## M A T R I X I I I

It appears that only two specific functional systems in the organism are primarily influenced by this type of field exposure. These are the brain and the growing tissues of the body, including fetal tissues and cancerous growths. The effects on the brain are mainly functional - for example, behavioral abnormalities, learning disabilities, altered biological cycles, and activation of the stress response system. In growing tissues, field exposure promotes the growth of cancer cells and increases the incidence of developmental defects in newborns.

### Other Cases Where Authorities Have Been Notified of Hazards and Taken No Action

In the early 1970's, Dr. William Morton of the Oregon Health Sciences University was asked by the Environmental Protection Agency (EPA) to look into an excessive incidence of adenocarcinoma among residents of a Portland neighborhood that contained an unusual concentration of broadcast towers. The project was expanded to study the relationship between EPA measurements of FM radio fields in Portland and the incidence of several types of cancer found in the same area. A significant relationship was found between field intensity in the FM band and the incidence of non-lymphatic leukemia. The EPA took no action on the report.

In 1986, doctors Anderson and Henderson of the Hawaii Department of Health surveyed Honolulu according to census tract areas. They found that in eight out of nine areas containing broadcast towers, the incidence of cancers of all types was significantly higher than in adjacent census tracts that did not have broadcast towers. No action has been taken by the State of Hawaii Department of Health.

### Modulation is the Secret

All of the above reports deal with electromagnetic fields at opposite ends of the non-ionizing portion of the electromagnetic spectrum. The power-frequency fields oscillate at less than 100 cps, while the microwaves oscillate much faster. It is apparent now that the types of biological effects that are associated with each are virtually identical.

Modulation is the secret of transmitting information by means of electromagnetic fields. In microwaves, the high-frequency signal is modulated at low frequencies. Microwaves that are un-modulated have no such effect. The two types of modulation that are biologically important are pulsed modulation and amplitude modulation.

In AM radio, for example, the radio receiver "demodulates" the signal, removing the "carrier" radio-frequency wave, which preserves the modulation that we perceive as voice or music.



## M A T R I X I I I

It appears that the human body can also demodulate the signal when exposed to modulated radio-frequency (RF) or microwave fields; the biological effect is that of the low-frequency vibration. All biological effects from electromagnetic radiation are produced by ELF frequencies. The body systems that pick up the electromagnetic signal are "tuned" to the natural frequencies between 0 Hz and 30 Hz. These systems will sense abnormal fields that are close to this range (between 30 Hz and 500 Hz). The systems then produce an abnormal effect. Microwave radar pulsed at 50 Hz would have the same biological effect as a 60 Hz field alone, which explains the identical effects seen at ELF and microwave frequencies. It also indicates that all intervening frequencies (VLF, AM radio, FM radio and television) will have the same biological effects.

Generally speaking, the biological effects from all man-made electromagnetic fields could be categorized as follows:

- \* Effects on growing cells, such as increases in the rate of cancer-cell division.
- \* Increases in the incidence of certain cancers.
- \* Developmental abnormalities in embryos
- \* Alterations in neurochemicals, resulting in behavioral abnormalities, such as suicide, depression, etc.
- \* Alterations in biological cycles.
- \* Stress responses leading to depression in the human immune system.
- \* Alterations in learning ability.

According to studies done at the University of Chicago by Dr. Samuel Epstein, since 1975 there have been the following increases in the incidence of specific types of cancers:

Lymphoma, Myeloma, Melanoma	100%
Breast Cancer	31%
Testicular Cancer	97%
Pancreatic Cancer	20%
Kidney Cancer	142%
Colon Cancer	63%

These increases parallel the increase in the ambient electromagnetic field in the past ten to fifteen years, and might also relate to the increase in type and quantities of chemicals added to the food, water, and environment. The medical monopoly is literally "making a killing", and nothing is being done to curb this insane approach by the people who "manage" human society.

M A T R I X I I I

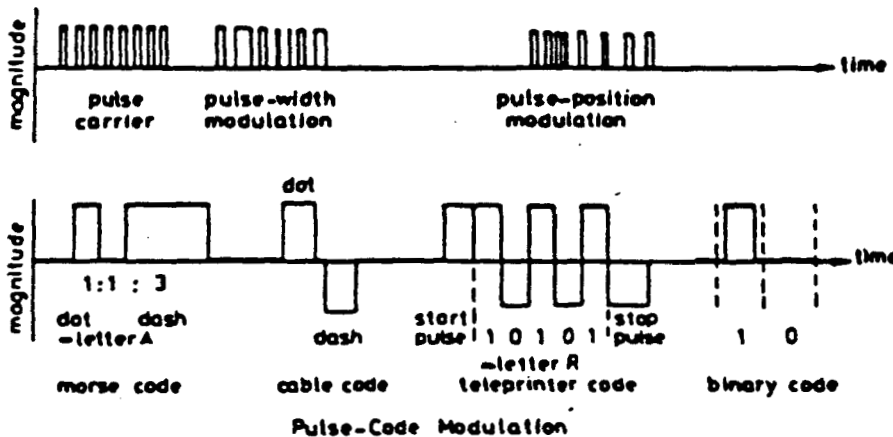
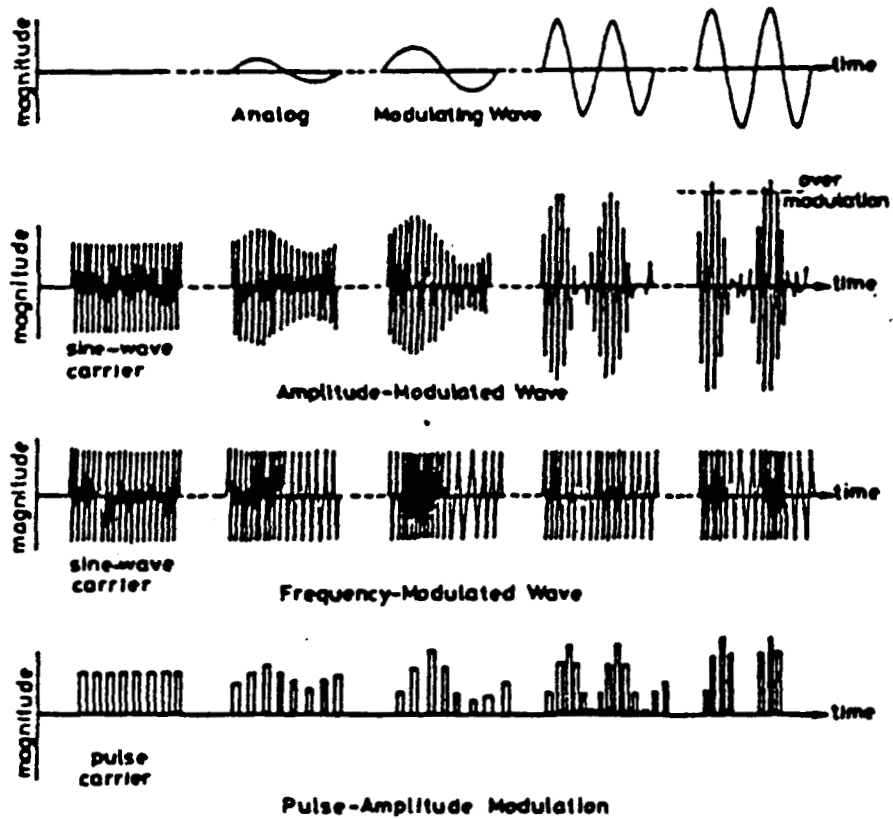

**Information Transfer - Modulation** Oscillations and resonances happen in any structure, like rattles in cars. They only become useful when they are interrupted in a coherent manner to convey information. This process is called modulation. This figure shows the many ways in which the modulating wave at the top, can be impressed on a carrier oscillation. The carrier must be highly coherent so as not to change spontaneously during the longest modulation period. A train of pulses can also act as a carrier of modulation, and the pulses can be coded to transfer information.

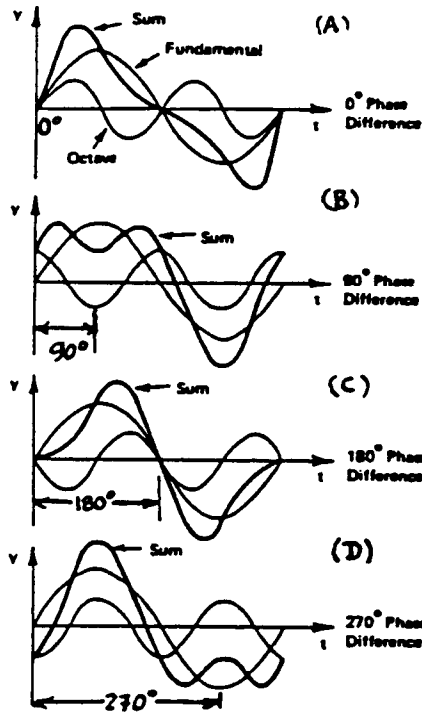

PHASE-RELATIONSHIPS IN WAVE MOTION OF EITHER SOUND (ACOUSTICAL) SIGNALS OR RADIO FREQUENCY RF, ELECTROMAGNETIC WAVES.

WHEN THE PHASE OR TIME INTERVAL OF 2 OR MORE SIGNALS IS PULSED THE WAVES ARE SAID TO BE: "PHASE MODULATED". THIS IS DONE TO ALTER OR CHANGE THE OVER-ALL FREQUENCY,  $f$ , OF THE SIGNALS. ALSO KNOWN AS "FREQUENCY MODULATION". FM.

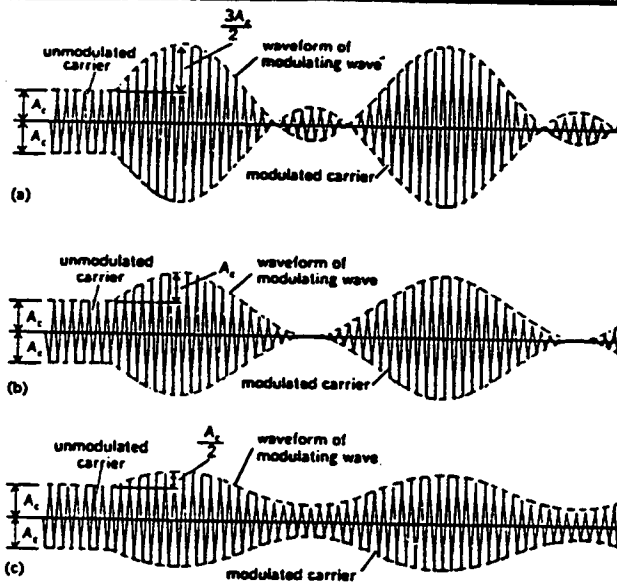

AMPLITUDE (POWER) RELATIONSHIPS IN WAVES.

COMBINING A CARRIER WAVE AND ONE THAT DOES THE MODULATION.

THIS IS HOW "CONCEALED" INFORMATION IN ELF'S IS CARRIED IN FM or TV SIGNALS (RF).

Fig. 11 Amplitude modulation of a sine-wave carrier by a sine-wave signal, with (a) 50% overmodulation, (b) 100% modulation, and (c) 50% modulation. (From H. S. Black, Modulation Theory, Van Nostrand, 1953)

M A T R I X I I I

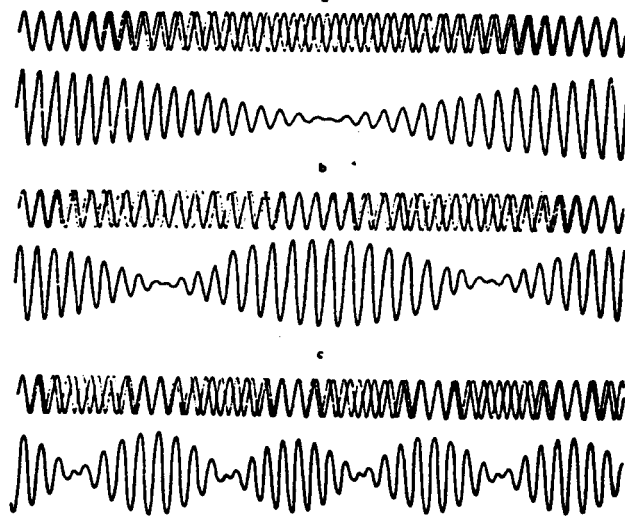
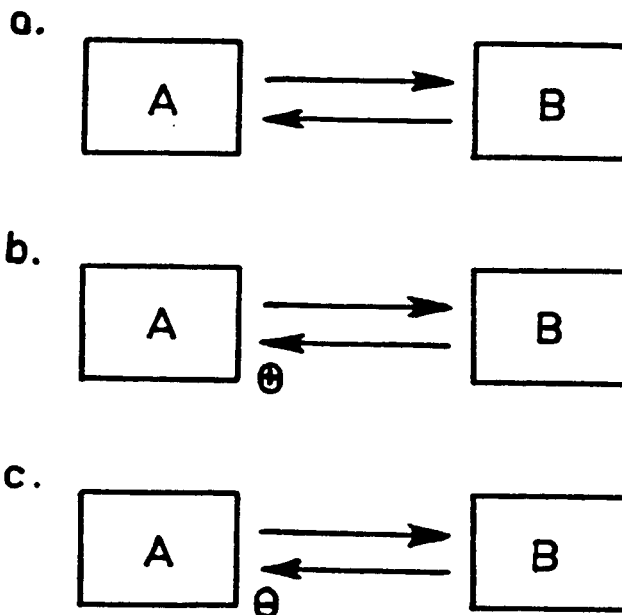

Diagram of a beat frequency which is the function resulting from the difference in period of two component frequencies.



This diagram indicates types of feedback: a. mutual interaction, b. positive feedback and, c. negative feedback.

## M A T R I X I I I

### Report On Static and Time-Varying EM Fields

In 1987, the World Health Organization and the International Radiological Protection Association completed a 10 year study that included a committee of experts from 13 countries. The 1987 report concluded that there is "an urgent need" for research to resolve the suspected link between very weak ELF fields and cancer. The report states that the suspected carcinogenic effects of ELF magnetic fields occurs at 0.1-1uT, which is near to extrapolations of an onset threshold based on the work of Savitz, Wertheimer and Leeper.

References: Savitz, D.A. (1986/7) "Childhood cancer and EM field Exposure" NYSPLP, Appx 15, New York, New York, State of New York Department of Health, July 1, 1987

Savitz, D.A. (1988), "Cancer and EM Field Exposure", American Journal of Epidemiology, Vol 128, p21-38.

Wertheimer, N. and Leeper, E. (1989), American Journal of Epidemiology, Vol 120, p18-25

Wertheimer and Leeper, (1988) Microwave News, Jan/Feb

World Health Organization (1984), ELF Fields, Environmental Health Criteria Series No.35, Geneva, WHO

World Health Organization (1987), Magnetic Fields, EHC Series No. 69, Geneva WHO/IRPA

### Non-Technical References Available to the Public That Document Non-Thermal Effects from RF and Microwave Radiation and Low Level Magnetic Fields

"Electromagnetic Man: Health and Hazard in the Electrical Environment", Cyril W. Smith and Simon Best, 1989, St. Martins Press, New York. Chapters on Basic Concepts, Human Biology and Electromagnetic Fields, Electrical Sensitivity and Allergy, Electromagnetic Environmental Pollution, Chronic Field Exposure, Health Risks and Safety Regulations.

"Cross Currents- The Perils of Electropollution", Robert O. Becker, 1990, St. Martins Press, New York. Chapters on the Internal Direct-Current Control System of the Human Body, Electrical connections to cancer, Effects of electro-

## M A T R I X I I I

magnetic fields and radiation on morphogenetic fields, magnetic fields and biology, biological resonance, magnetic resonance, magnetic fields and cell division, electromagnetic hypersensitivity syndrome, chronic fatigue syndrome, risk/benefit ratios, dose rate considerations, ambient fields, field measurement, long-term frequency/microwave solutions, military uses of the electromagnetic spectrum.

"The Zapping of America- Microwaves, their deadly risk, and the Cover-up", Paul Brodeur, 1977, John Wiley and Sons. Information on the hygienic, environmental and physiological effects of microwave radiation.

"The Body Electric- Electromagnetism and the Foundation of Life", 1985, Robert O. Becker, M.D. and Gary Selden.

Articles In the "New Yorker" Magazine, June 12, 19, and 26, 1989, "Annals of Radiation: Hazards of Electromagnetic Fields".

"Currents of Death: The Attempt to Cover up the Threat to Your Health", 1989, Simon and Schuster, New York.

### EFFECTS OF ELF/ULF ON BIOSYSTEMS

ELF fields are extremely low frequency magnetic fields with a range of 1 - 100 cps that can affect biological systems. In spite of their weak power (  $2 \times 10^{-9}$  Tesla per second, compared with a horseshoe magnet which is .1 Tesla per second), they are capable of affecting the human biological system in a most profound way.

### Human Effects of ELF/ULF

In the presence of the protein kinases in the nuclei of the cell, the ELF interacts with the DNA molecule itself. It can "turn on" or "turn off" any gene, once the correct frequency is known. For example, one frequency can cause cancer in a rat in two days. Another can reverse the process. One frequency can cause depression in humans by causing the release of cholinergic neuropeptides in the brain. Still another frequency can cause anxiety; a third can motivate mob behavior, and so forth. It can be done from any point on the planet. The foundation of how ELF can do what it does is that external magnetic fields can control biological spin and proton coupling constants in DNA, RNA, RNA transferases and hydrons (H<sub>2</sub>O).

## M A T R I X I I I

### U.S.Navy Results of ELF Tests

According to the U.S.Navy, which conducted secret testing for seven years (partial results were released in August of 1984), the following effects of E.L.F. have been reproduced in numerous laboratory tests, repeatedly:

- 1.Alteration of the behavior of cells, tissues, organs, and organisms.
- 2.Alteration of hormone levels.
- 3.Alteration of cellular chemistry.
- 4.Alteration of time perception in animals and humans.
- 5.Induction of sleep in animals.
- 6.Inhibition or enhancement of bone growth.
- 7.Inhibition or enhancement of cell differentiation.
- 8.Inhibition or enhancement of protein kinase production.
- 9.Inhibition or enhancement of M(RNA) synthesis/processes.
- 10.Alteration of the immune system processes.
- 11.Alteration of the calcium bonding and efflux in cells.
- 12.Destruction and rupture of cellular structure.
- 13.Entrainment of human and animal brainwaves.
- 14.Entrainment of the DNA transaction process.
- 15.Cause defects and alterations in embryos.
- 16.Cause accelerated fetal mortality rates.
- 17.Cause sterility.
- 18.Promote non-invasive genetic engineering by causing the production of auto-adjusting antibodies that will cause the generation of viruses within the body.
- 19.Cure of diseases by alteration of cellular frequencies.

# M A T R I X I I I

## ADDITIONAL ELF CAPABILITIES

Much of the work on Ultra-low-frequencies was done and continues to be done by the Navy and Dr. Jose Delgado in Spain has produced an additional list of capabilities that are in the hands of the military and intelligence agencies:

20. Creation of fatigue states.
21. Creation of state of depression.
22. Creation of cataracts and eye problems.
23. Creation of irritability and anger states.
24. General alteration of moods.
25. Creation of compulsive behavior patterns.
26. Creation of states of sexual aggressiveness.
27. Creation of havoc in circadian rhythms.
28. Creation of fear and disorientation.
29. Creation of sleep disorders and insomnia.
30. Creation periods of short and long-term memory loss.
31. Creation of leukemia and cancer.
32. Creation of catatonic (zombie-like) states (15 min).
33. Creation of violent states and criminal behavior patterns.

### Funding for Military Research into DNA Absorption of Microwaves

In 1986, the U.S. Air Force funded a project costing over \$120,000 at King's College, London. The project was run by Professor Edward Grant, and had to do with the effects of microwaves on human DNA. Much of the US work on DNA absorption is being funded by the U.S. Navy, while British and Swedish research contracts on the subject are paid by the U.S. Air Force.



## M A T R I X I I I

### AREAS OF EXISTING ELF USAGE

1. Natural ELFs: Natural ELF waves are produced by the Earth's micropulsations, including Vortex Intersection Pulses (at the intersection of ley lines) and geological Tectonic Fault pulses. The natural pulse of the Earth is the Schumann Resonance frequency of 7.85 cps. The natural pulses of the Earth are not electromagnetic waves. They are asymmetric harmonic pulsations of the geomagnetic field.
2. Artificial ELF's: Artificial ELFs are created by the man-made electromagnetic grid, which consists of power lines, industrial electric sources, appliances, etc. The penetrating power of these ELF waves is directly proportional to their amplitude (voltage and power). They decrease in power (attenuate) inversely as the square of the distance from the source. They do not carry programmed information.
3. Tactical ELFs: Tactical ELF waves are created by television, radio, communications, radar, microwave, cellular telephone, etc. The power range is usually in the Megawatt (millions of cycles per second) or Gigawatt (billions of cycles per second). These ELFs (magnetic components of the transmissions) do carry information and are modulated at 16-20 Hz and at classified modulation rates. Carriers are very often in the FM range (147 -160 MHz) but also in other frequencies not generally known to the public. Both the type of modulation and the fact that "frequency hopping" occurs is not generally known by the public. These ELF magnetic waves can penetrate anything. Attempts to stop the waves using Faraday cages has been unsuccessful. A possible solution is to create a neutralizing pulsing magnetic field to counteract the pulsing magnetic fields comprising the ELF.

Based on the above information and our research on the matter, it is concluded that the chemical and germ warfare prosed by Colonel Tom Bearden was not the real threat to the American public from the Russians. The real threat was in the Tactical ELF emanations from the Russians and the United States government. Research appears to indicate that the phenomenology of ELFs and Scalar Wave technology is almost identical. We know that Colonel Beardens technical information is correct, but his emphasis against the Russians is orchestrated disinformation. It is the United States military and the "intelligence" community that is now forcing the issue of electronic mind control on an unsuspecting American public.

## M A T R I X I I I

### The Military, 10mw/cm<sup>2</sup> Standard and The Cover-up

The electromagnetic capabilities of the military, because of the Tri-Services Program and the work of Professor Schwan, were designed around the 10mW/cm<sup>2</sup> standard and, once in place, it had to be defended against the discovery of nonthermal biological effects. The recognition and validation of these effects would mean the collapse of the entire military (and industrial) electromagnetic capabilities of command, control and communications. It quickly became apparent that evidence for non-thermal effects was viewed as a threat to "national security". This view led to the policy of denying any non-thermal effects from any electromagnetic usage, whether military or civilian. Control over the scientific establishment was maintained by allocating research funds in such a way as to ensure that only "approved" projects (that would not challenge the thermal-effects standard) would be undertaken.

Science as a field has always been a bit reactionary, and this tendency was capitalized upon by the military by enlisting the support of prominent members of the engineering and biological professions to support this deception. In some instances, scientists have been told that non-thermal effects did occur, but that national security objectives required that they be hidden from public knowledge. The personal goals of many scientists were subverted by promises of unlimited funding from the military and easy access under "classified" programs to scientific literature not made available to the public or mainstream scientists.

Because of this collusion, when serious challenges to the thermal-effects standard were raised publicly, eminent scientific boards, associations, or foundations were provided with lucrative "contracts" to "evaluate" the state of knowledge of the bioeffects of EM fields. These "investigations" resulted in the production of voluminous "reports". The practice is still going on. All these "reports" seem to share certain characteristics. Scientific data indicating non-thermal bioeffects is either ignored or subjected to extensive and destructive review. Scientists (even Nobel prize nominees) who reported the existence of non-thermal effects were ridiculed and were portrayed as being outside the mainstream of thought. Actual disinformation was used to create a false impression. For example, while a statement such as "there is no evidence for any effects of pulsed magnetic fields on humans" might be true for the person making the statement, data reporting such effects on animals would be ignored and tests on humans would never be sanctioned through regular scientific channels, but would be performed under the scrutiny of DARPA or covert scientific groups having close connections with the Navy or intelligence factions, who would be conducting such research for nefarious purposes. Notice the parallels in the methodology of this "coverup" with what has

## M A T R I X I I I

been happening in the area of UFOs and alien interaction.

Locally, when a microwave tower for cellular telephone service was proposed for this area, many of us who had technical backgrounds got together and did the research to back up the fact that non-thermal effects do occur. Predictably, the cellular company dragged out a group of manufactured "experts", including Arthur Guy (who had retired) to plead their case. They did not expect to encounter our group, who collectively has an immense body of knowledge about all this information. We stunned the opposition by demonstrating a level of scientific knowledge they did not expect - they expected a bunch of whining people steeped in social consciousness, but what they got was something else. The hearings examiner took six months to review all the data and decided that we had won scientifically, but that to acknowledge a "win" for us on that basis would cause a large problem for the entire cellular industry. So, he turned the entire issue over and threw out the scientific aspects and cited elements within Washington State law that would allow them to put up the tower. We "lost", but we really had them worried. Other groups in the state are doing them same thing about towers in their areas. You will understand the depth of why the cellular companies were so concerned when we get into Part II of this chapter.

### The Ground-Wave Emergency Network (GWEN) System

The Ground-Wave Emergency Network (GWEN) is a communications system that the military is in the process of constructing as we speak. It operates in the very-low-frequency (VLF) range, with transmissions between 150 and 175 kHz. This range was selected because its signals travel by means of waves that have a tendency to hug the ground rather than by radiating into the atmosphere. This signal drops off sharply with distance - a single GWEN stations transmits in a 360 circle to a distance of 250 to 300 miles. The entire GWEN system consists of approximately 300 such stations spread across the United States, each with a tower 300-500 feet high. The stations are from 200 to 250 miles apart, so that a signal can go from coast to coast from one station to another. When the system is completed around 1993, the entire civilian population of the United States will be exposed to the GWEN transmissions. Read Appendix 4 and then re-read this section.

M A T R I X I I I

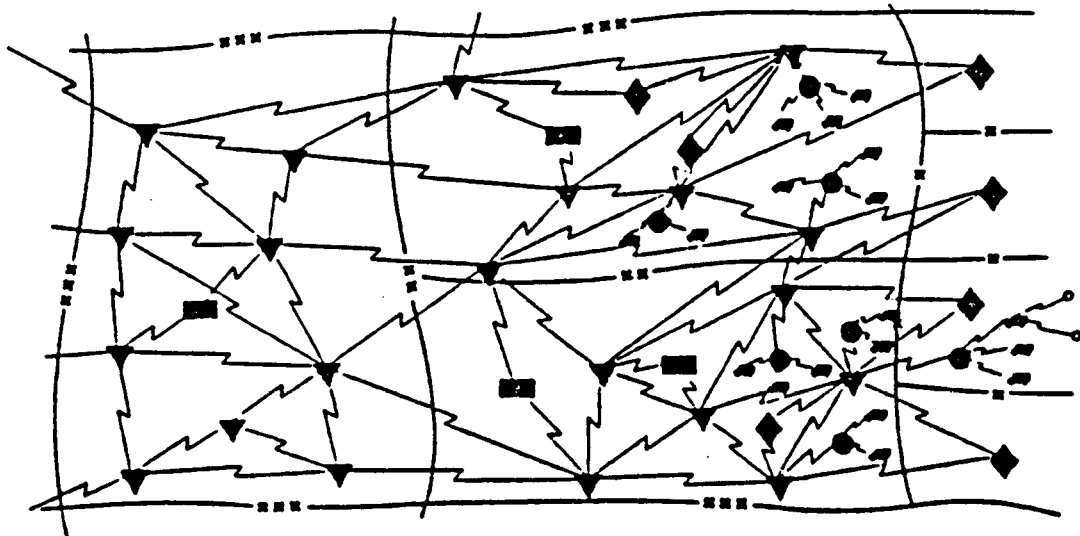

ELECTROMAGNETIC/RF GRID ACCROSS U.S.A. INCLUDING MOBILE UNITS. MICROWAVES AND/OR ELF/ULF; CAN BE EASILY TRANSMITTED INSTANTLY ACCROSS COUNTRY,

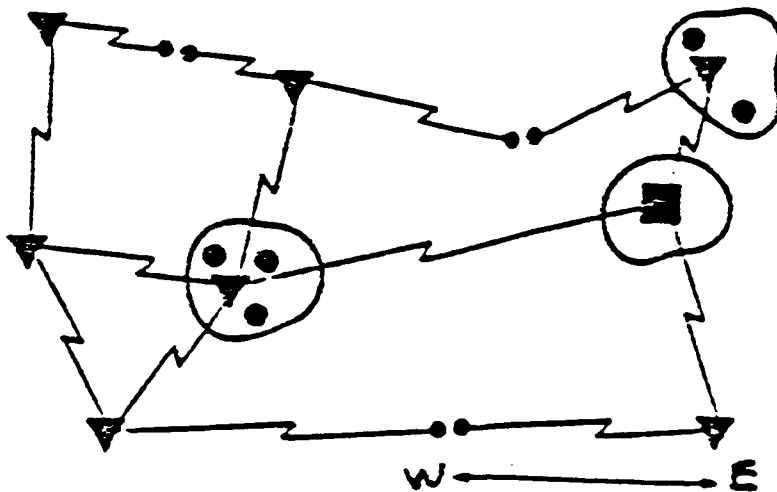

THE ELF/MICRO-WAVE GRID ACCROSS 8-POWERFUL "SECRET" TRANSMITTERS IN THE U.S.

## M A T R I X I I I

### APPLICATION OF MILITARY FREQUENCY WEAPONRY

According to a 1982 Air Force review of biotechnology, ELF has a number of potential military uses, including "dealing with terrorist groups, crowd control, controlling breaches of security at military installations, and antipersonnel techniques in tactical warfare." The same report states:

"Electromagnetic systems would be used to produce mild to severe physiological disruption or perceptual distortion or disorientation. They are silent, and countermeasures to them may be difficult to develop."

Between 1980 and 1984 I was in England, and I got to see some illustrations of how some of this technology actually works. During this period, there were a lot of protests, sit-ins and demonstrations by Greenpeace and many other groups against the deployment of Cruise missiles, especially at Greenham Common, which was south of where I was located. In 1983 and 1984 there was a very large presence of military police at the base when the Cruise missiles arrived. Around mid-1984 this presence diminished considerably, and some of the protesters who were outside the base started claiming that they were being irradiated from the base because of physical problems they were unable to link to any other source. This was reported in *Electronics Today* magazine in 1985. The symptoms ranged from skin burns to headaches, drowsiness, menstrual bleeding at abnormal times, bouts of temporary paralysis, faulty speech coordination, and in one case circulatory failure severe enough to require hospitalization. Such a complex series of symptoms fits well with severe EM field exposure. The Ministry of Defence (MOD) denied that any harmful electromagnetic signal was being used against the women, but did not deny that an electromagnetic signal may be in use which, if below  $10\text{mW}/\text{cm}^2$ , would not, under UK guidelines, be officially acknowledged as harmful. In other words, they lied.

#### A Short Inventory of Frequency Weapons Listed in the British Defence Equipment Catalog for 1982

The Photic Driver: a glorified strobe light which emits pulses in the critical range of 10-30 Hz.

The Valkyrie: an enhancement device for the Photic Driver that will deliver sound pulses in the 4 - 7.5 Hz range.

The Sound Curdler: a sound output system of 350 watts that is guaranteed to repel a crowd.

## M A T R I X I I I

### Cases of Deliberate Experimentation on Individuals for Military Purposes

In one study over 100 Washington and Oregon state prisoners (recall the discussion of Phase II drug testing in Chapter 5) between 1963 and 1971 had their testicles dosed with radiation to discover what doses would sterilize them. The project was funded by the Atomic Energy Commission at a cost of \$1.5 million.

From 1945 to 1947, 18 hospital patients, one of them only five years old, were injected with plutonium to measure how much the body would retain. The injections were represented as "experimental treatments" for the patients' illnesses. This appalling scheme was reviewed in the British Medical Journal in 1987, where it said that the "redeeming feature of the test was that the results were made available to other countries for their use."

## II. ADVANCED MIND CONTROL APPLICATIONS

### Cross-Referencing

By now you have acquired quite a bit of background knowledge - it is knowledge that you will need to draw upon to properly understand and evaluate the information in this second section of Chapter 7.

---

### The Psychology Behind Mind Control and Psychic Warfare

Body identification gives rise to a host of sociological phenomena, the least of which is the mechanistic view that consciousness is a product of the brain, and secondarily that the mind is centered in the brain. Dr. Jose Delgado was one of the chief proponents of this viewpoint. Delgado was the author of the book *Physical Control of the Mind: Toward a Psychocivilized Society*. For Delgado, the mind existed only in the brain; to postulate its existence as an independent entity was to him sheer nonsense. He rejected the concept of free will, and proposed that the mind was a functional entity produced by the electrical operations of the brain, and as such should be manipulated and controlled in order to control the behavior of the population. This was a view that seems to be shared by proponents of the New World Order. Delgado, since the mid-1970's, was the director of the Spanish neurophysiological laboratory Centro Ramon y Cajal. As time went on, his

## M A T R I X I I I

interests shifted from direct stimulation of the brain to the broader area of the biological effects of electromagnetic fields, an area that has been eagerly embraced by the military and political system as a means to achieve their goal of absolute control of the population.

There are several psychological schools of thought that have been adopted by government psycho-scientists and the military to justify mind control. All of them relate to the idea of psychic energy as originating in the human psyche, typified by the work of Carl Jung. The energy originating in the human psyche consists of thoughts, feelings, emotions, and neuro-physiological stimuli and responses. It consists of a physical component that can be measured and an etheric hyper-spacial component that can only be measured by specialized equipment. These schools of thought are as follows:

SCHOOL	MAJOR PSYCHOLOGICAL PREMISES	METHOD OF STIMULATION
<b>REICHIAN</b> (Wilhelm REICH)	The source of Psychic Energy is in The SEXUAL ORGASM. The particles having this P.E. are ORGONE.	Chemical (Drugs), Sexual, and Hypnotic-Orgasm model.
<b>FREUDIAN</b> (Sigmund FREUD)	The source of Psychic Energy is The LIBIDO or The SEXUAL APETITE. LIBIDO is purely sexual.	Purely Sexual Physical and/or Fantasies
<b>JUNGIAN</b> (Carl Gustav Jung)	PSYCHIC ENERGY is the LIBIDO. The LIBIDO is The SUM TOTAL of All Energies, sex being one component.	Contemplation of MANDALAS Evocation of ARCHETYPES
<b>ADLERIAN</b> (Alfred Adler)	PSYCHIC ENERGY derives from Man's intrinsic Biological Drives, especially The DRIVE for POWER.	Fantasies of Power, Power Words, Motives
<b>GESTALT</b> (FRITZ Perler's)	PSYCHIC ENERGY is the result of the STRUCTURE+FORM of physiological parts that act as a WHOLE UNIT.	Formal Exercises, Rituals Trance, Total Body Stimulus
<b>PIAGET</b> (Jean PIAGET)	PSYCHIC ENERGY is the result of EIDETIC IMAGES/SYMBOLS in MIND-BRAIN SYSTEM. This is pronounced in Children.	Visualisations, Daydreaming Abstract Art, Symbols
<b>SKINNER</b> (B.F. Skinner) (J. M. Delgado) <b>DELGADO</b>	PSYCHIC ENERGY is an INTRINSIC FUNCTION of the BRAIN MIND COMPLEX & is neither Chemical nor Biological nor Physiological but can be - and should be - monitored & stimulated & conditioned.	Hypnosis, Suggestion Drugs, Electronic Stimulation of Brain. (ESB)

### Suppression of Vital Data in Physics

For thousands of years, many discoveries have been suppressed from the populations of the planet in order to keep them in bondage. The burning of the libraries of Alexandria is one example of how information can be suppressed. Another example would be the common technique of suppression of scientific information by alteration of the information itself. Perhaps the most blatant and far reaching alteration of data was the alteration of Maxwell's equations. James Clerk Maxwell was a mathematical genius who lived in the late 19th century. His original work, which is available to covert scientific departments in the government, had the potential to

## M A T R I X I I I

radically alter the entire course of our civilization.

It is certainly clear to most of you by now that the human population can easily be manipulated by electronic means using various methods developed through the military industrial complex. What may not be clear to you is that many of the EM effects can be initiated from outside of what is normally seen as the electromagnetic spectrum. Just as a magnetic field in a wire is at right angles to the current flow, other fields and waveforms exist that are an integral part of the electromagnetic spectrum, yet exist at a certain number of right-angle rotations (orthogonal rotations) away from the electromagnetic field components we are normally accustomed to. If these hyperspatial components, which are not subject to the usual electromagnetic constraints of time and space, are generated and manipulated, they can in turn generate EM effects that have the capability to influence human biology and consciousness.

Let's take a brief look at how and by whom the equations of Maxwell were changed, in order to make subsequent open scientific development that would have influenced civilization in a positive way, impossible:

### The Hertzian Conspiracy

In late 1864, James Clerk Maxwell published his epic material on electromagnetic waves. His material dealt not only with electrical and magnetic waves, but also the relativistic/etherial psycho-active component of these waves (representing electromagnetics of the second order and above). The equations also included transformations that enabled the change from inertial frames of reference to non-inertial frames of reference. Maxwell's original equations were written in Quaternion notation, a complex mathematical system available at that time before Vector Analysis was introduced by Oliver Heaviside. Today's generalized equivalent of Quaternions is Tensors.

In short, Maxwell's original work gave the necessary information for gravitational propulsion and psychoactive devices. Someone somewhere recognized this, for shortly after his death, the mathematician Oliver Heaviside, the chemist Willard Gibbs, and physicist Heinrich Hertz decided to "edit" or "interpret" Maxwell's famous equations which were, in the original form, the foundations of electromagnetics and Unified Field Theory (UFT). This "unholy trio", especially Heaviside, disregarded the Quaternions or Scalar components of Maxwell's original equations, because they represented potentials and not fields. He thought potentials were akin to "mysticism", because "everybody knows that fields contain mass, and mass cannot be created from apparently nothing.", which is what



## M A T R I X I I I

potentials are, both literally and mathematically; they are an accumulation or reservoir of energy. Furthermore, not only did they throw away the gravitational component with the Quaternion/Scalar, but also postulated that gravitation and electromagnetism were mutually exclusive, not interdependent. That was the death blow to subsequent efforts by scientists to realize a functioning unified field theory. Because of this one act, electromagnetism was reduced from its original five dimensions to only four: X, Y, Z, and time. The element of G was removed.

Because of this deliberate act, twenty-two other errors exist today in electromagnetic theory. The very concepts of force, mass and charge are ill-defined, and the so-called "static" electrical charge has been discovered by Quantum mechanics not to be static at all, but to move rotationally by virtue of the quantum mechanical spin. Finally, adding insult to injury, the so-called "imaginary components" of Maxwells original equations as well as the mutilated version of the equations have also been discarded or ignored. With this last error, the door to hyperspatial domains was forever closed, for the present mathematics and physics of electromagnetic theory do not allow for hyperspatial domains (domains outside of three dimensions), superluminal signals (signals that exceed the speed of light or are infinite in speed), and a unified field theory.

The edited version of Maxwells work, which every physicist and engineer has had to contend with, discards electrogravitation, and avoids the unification of gravitation and electromagnetics. It also prevents the direct engineering of gravitation, space-time, time flow rates, free energy devices, and quantum changes, which is viewed by the altered equations that are vector-based as only a statistical change. The quaternion approach captures the ability to utilize electromagnetics and produce local curvature of spacetime. Heaviside wrote a subset of Maxwell's equations where this capability is excluded.

Dr. Henry Monteith has independently discovered that Maxwell's original quaternion theory was a unified field theory. Einstein assumed, because he only had access to the altered equations, that curving spacetime could only be achieved by the weak gravitational force due to mass, that the local frame would always be a Lorentz frame, which would mean that all operations would be constrained to "conservation laws of physics".

In the 1960's the Hertz (Hz) replaced Cycles Per Second. Since, then everyone thinks that all electromagnetic waves are hertzian. Only the upper portion of the spectrum before Infra-red contains Hertzian waves. ELF and ULF are not; waves in biosystems and natural phenomena are not Hertzian in nature;

## M A T R I X I I I

they are asymmetrical and non-linear. The heartbeat, pulse and brainwaves are non-Hertzian, yet are affected by Hertzian RF waves. That is the paradox that is perceived by orthodox scientists.

Maxwells original equations consisted of two parts representing both measurable components and the relativistic components. The relativistic or etherial component is hyperspacial and is also called the "imaginary" or "complex conjugate", and signals using this component are psycho-active; they interact with the brain and consciousness.

Government scientists, who discovered the errors and the original equations of Maxwell, made sure that these errors remained uncorrected outside government research circles. The mutilated version of Maxwells work represents the physics that is taught in all universities - only the government has access to the "real" physics, which ironically has hyperspacial or "imaginary" components.

All orthodox electronic and scientific instrumentation outside classified government laboratories has been designed to measure force, electrical charge, and energy that is coupled to mass. Subtle energies where mass is not involved cannot be detected, much less measured - hence it doesn't exist. Even the hyperspacial components of voltage, current, and power within alternating currents cannot be measured by standard instruments, yet it is these very so-called "imaginary components" of voltage, current, and power that co-exist with the "real" components and affect the psychic and neurological functions of biosystems. This is (was) perhaps one of the best kept secrets of the government. Now it's yours.

As a result of all this, orthodox scientists, academicians, and engineers continue to sleep to the stupefying "song and dance tunes" of their Nobel prize laurels, discovering man-made new sub-atomic particles in their quantum mechanical "zoo of confusion". Meanwhile, relativistic physics, or hyperphysics, remains only a remote possibility relegated to imaginary or mystic realms, which is where Prana, C'hi, and subtle energies exist. Even such quantum mechanical concepts, such as the zero-point energy of vacuum and the Dirac Sea, the source of all virtual particles of negative energy (particles that do not yet exist in mass that are the potential source for all forms of free energy) do not exist for them. So much for todays orthodox science.

### Definitions of Terms in Relativistic Physics

Tensors: (Biological) Multi-dimensional, multi-component echoes of consciousness that capable of generating

## M A T R I X I I I

potentials and/ fields under Unified Field conditions.

(Literal) Multi-dimensional, multi-component force having magnitude and direction, representing a complex state of Forces, Fields, Mass, Energy, Flow, Stress, etc. The states of rest, motion and the vibrations inherent in a system can be completely described by Tensors.

Tensor Potential: A potential of energy wherein there is no energy flow, no mass flow. It is only an accumulation of stored energy in a precisely contained cavity.

Tensor Field: A specific area wherein the tensor potential creates an energy flow and/or the creation of Ante-matter  $u_0$  (different from Anti-matter) in a Unified Field

Unified Field: A field in which all energies are in a state of mathematical, geometrical, and harmonic unification. The sum of all energies equals 1.

Scalar: Mathematical entity representing quantity or magnitude such as weight, time, speed

Vector: Mathematical entity representing magnitude and direction in a given coordinate system, usually represented by an arrow. Velocity is a vector.

Spinor: A mathematical entity mostly used in quantum mechanics describing a spin having only two values, such as (+ - or up/down) for electrons, protons, neutrons. A spinor is present in discussions of relativistic light cones.

Twistor: A generalized spinor, and a mathematical entity used to represent curved space geometrically. Twistors are coordinates of Spinor-space. Within this linguistic format, the term Helicity defines the direction of the rotation of what are called Null lines, which comprise the path in space-time of a light ray or massless objects.

Fluxon: The flow of Unified Field energy that is activated by the factors of consciousness and volitional energy, symbolized by the tensor equation

$$C \times E^0_u = F$$

Unified Field Energy: The energy existing in the 6th vibrational plane that enfolds both consciousness and emotion. It can be accessed and created in the 1st vibrational plane by

## M A T R I X I I I

the activation of tensor potentials/fields using the key equation  $E = mc^2c^2$  as a starting point. It requires precisely designed containment in a cavity or geometric/harmonic configuration.

Tensor Potential Field Activation: Process involving a precise, yet simple protocol and formula via techniques of consciousness to create a Unified Field energy flow/flux, or Fluxon.

Dimension(s): An arbitrary coordinate system defined to measure magnitude, size, direction, position, motion, rest, flow or exchange of mass and/or energy by means of points, lines, scalars, vectors, tensors, or symbols. The dimensional space may be on any vibrational plane or hyperspatial to the plane of perception.

Complex Numbers: Numbers composed of real and "imaginary" numbers. Examples of real numbers are 1,2,3, the square root of 16, the square root of 1. Examples of "imaginary" numbers are the square root of -1, which is usually written as  $i$ . In physics and engineering, imaginary numbers are represented by  $i, j, k$  (especially by  $j$ ). Example:

$$e^j = \cos \theta + j \sin \theta$$

Complex Conjugate: Mathematical expression containing several components which are hyperspatial to each other.

Ex:  $(A + iB) (A - iB) = A^2 + B^2$

Ex: Complete Maxwellian Equation for Power

(1) 
$$W_{\text{power}} = \underbrace{2VI \cos 2\omega t}_{\substack{\text{Directly} \\ \text{Measurable} \\ \text{Component}}} + \underbrace{2VI j \sin \omega t}_{\text{Hyperspatial Component}}$$

(2) Orthodox Science Equation For Power

$$W_{\text{power}} = VI$$

The relativistic component is widely used in government scientific circles, but kept out of the universities and "orthodox science". Orthodox science is left to deal with physics on a mass level within the realm of First Order Electromagnetics, where we see "real" EM fields and Hertzian waves traveling at the speed of light that can be directly detected and measured.

# The Significance of $\pi$ & $\Phi$ in the Pyramid Energy

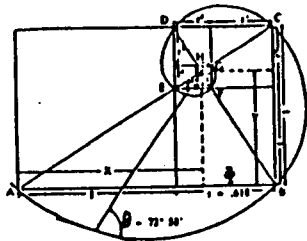

Fig. 10. Spiral Motion as a Function of  $\Phi$ . Logarithmic or Fibonacci Spiral.

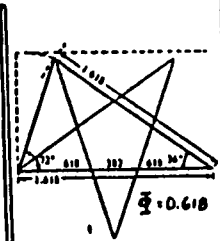

Fig. 11. Origin of  $\Phi$  in 5-Point Star.

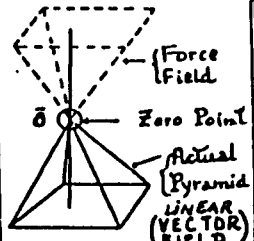

Fig. 12. Force Field (Grav.) created by Pyramid.

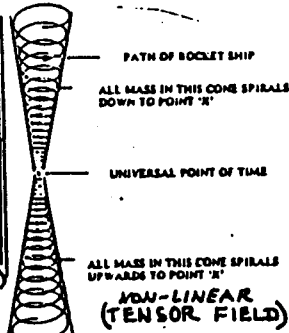

Fig. 13. General Relativity The Space-Time Diagram. (Time-Cone)

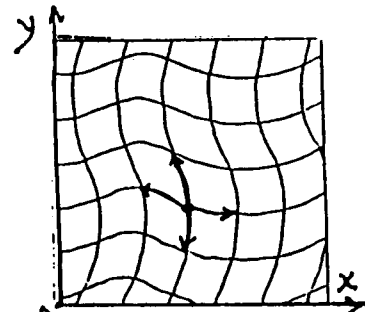

FIG 16. A NON-LINEAR 2-DIMENSIONAL GRID TENSOR FIELD.

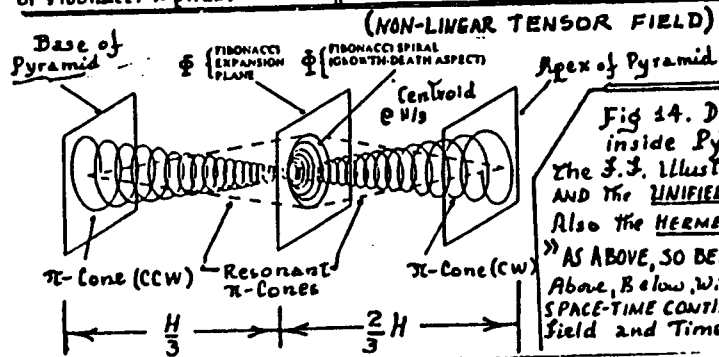

Fig. 14. Dynamics of Energy Generators inside Pyramid - horizontal view for clarity! The  $\Phi$  illustrates Einstein's General Relativity Th. AND THE UNIFIED FIELD THEORY completely! Also the HERMETIC PRINCIPLE: "AS ABOVE, SO BELOW; AS WITHIN, SO WITHOUT." Above, Below, Within & Without (a certain range), the SPACE-TIME CONTINUUM is Disturbed & Curved. Gravity Field and Time-Flow are Changed into a forever NOW!

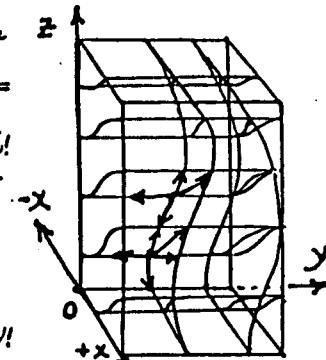

FIG 17. A NON-LINEAR 3-DIMENSIONAL GRID TENSOR FIELD.

# M A T R I X I I I

## The Maxwell Equations and Relativistic Magnetics

Let's take a look at the relativistic implications behind the equations for a waveguide:

E= Electric Field Vector  
B= Magnetic Field Vector  
 $w = 2 \pi f t$   
 $\nabla$  = DEL Operator

$\mu$ =Magnetic Constant  
f= frequency t= time  
 $\epsilon_0$ = Electric Constant  
 $\nabla_x$  = Orthogonal Hyperspace  
Vectors  
changing as function of  
x,y,z

Equation 1:  $E = -j\omega\mu \nabla_x B$     Equation 2:  $B = -j\omega\epsilon_0 \nabla_x E$

Equation 1 means that the electric field E is a function of the change in the magnetic field B, it is orthogonal to it and hyperspatial in relation to B.

Equation 2 means that the magnetic field B is a function of the change in the electric field E, it is orthogonal to it and hyperspatial in relation to E.

Electromagnetics can be broken down into three (3) Orders:

1st Order Electromagnetics: "Real" electromagnetic fields and Hertzian waves. Travel at c, the speed of light. Function of  $1/r^2$ . "In-domain" fields. This is what people are conditioned to believe is the only aspect of EM fields.

2nd Order Electromagnetics: : "Imaginary" or hyperspatial electromagnetic fields. "Out of Domain" . A potential wave that does not express/reflect in 3-dimensional levels. No voltage, power or wavelength. Non-Hertzian signal travels at Superluminal speed. There are Longitudinal or Scalar, Standing Waves. Function of  $1/r$ .

3rd Order Electromagnetics: Hyperspatial Sum of all potentials, simultaneously affecting the entire space-time continuum instantly. A relativistic Time-Stress Wave. Travels at infinite speed and has no wavelength. These are the so-called Solitons, Neutrinic Waves, and Tachyon Waves, as well as Tachyon Tensor Fields. *Tachyons respond to focused consciousness.*

M A T R I X I I I

Orthodox Science and Tachyons

Orthodox science does not "recognize" tachyons as "real" particles, for they are superluminal in nature. They don't use the term tachyon, but use the particle names neutrino and soliton as a theoretical approach to conflicts that arise within the orthodox physics based on mutated Maxwell equations. A major piece of data is that Tachyons respond to consciousness.

First Order Wave Example:

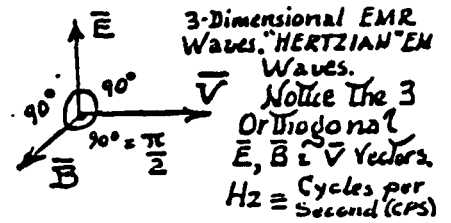
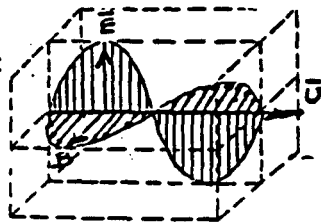

Second Order Wave Example:

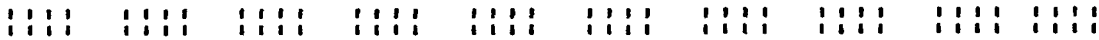

Third Order Wave Example:

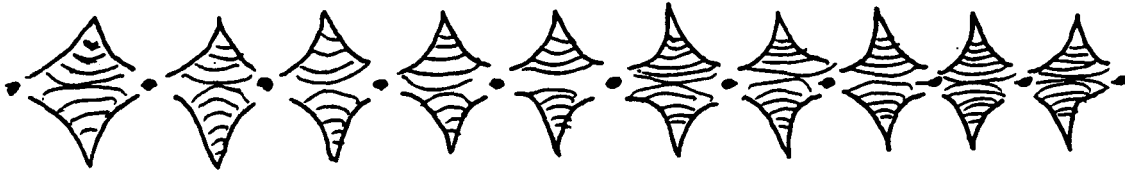

Lesser Known Characteristics of E.L.F.

1. E.L.F. is a 9-dimensional magnetic field (imagine it as a magnetic bubble cloud)
2. E.L.F. fields are self-organizing.
3. E.L.F. can go through anything and is non-attenuating.
4. Cell DNA, particularly in the brain, stops E.L.F. fields.
5. The only beneficial frequencies are in the range of 7 -9 Hz

# MATRIX III

REAL AND HYPERSPACIAL AXES THAT REPRESENT REALITIES, WORLDS, OR DIMENSIONS:

DIAGRAM SHOWING HOW TO ACCESS TO HYPERSPACIAL DOMAINS:

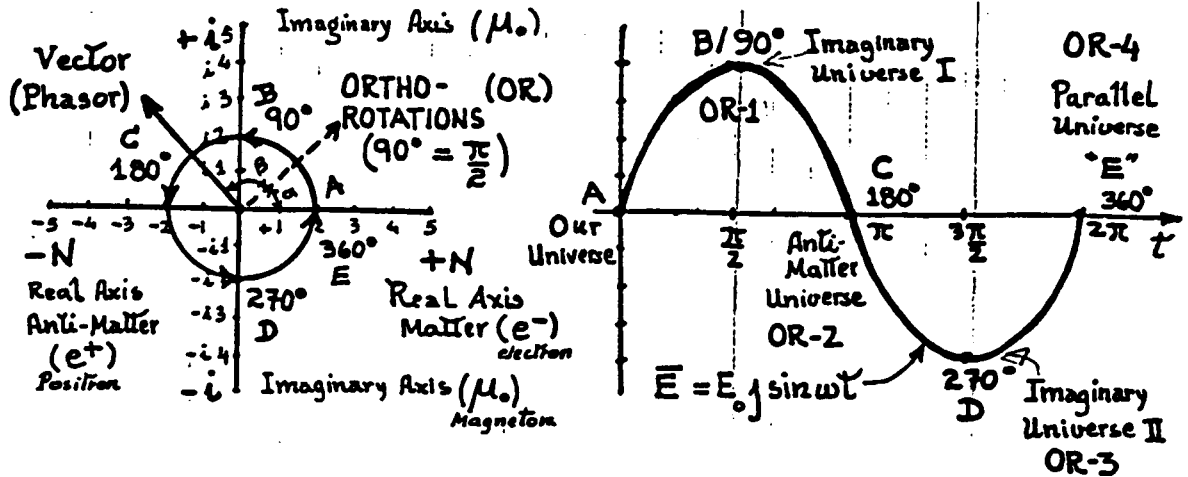

The Functional Scientific Electromagnetic Spectrum (FSES) detailed on the next page shows a little more than you would see in an average text. It shows the range of frequency in hertz or cps and the general breakdown of frequency designations. Notice again that ELF and ULF are not in the Hertizian area and how the deliberate modification and control of the human psyche has been technologically engineered into the ambient environment. Each of the seven auric bands around the human body have modulation frequencies that can be accessed and used to entrain thought patterns and affect behavior.

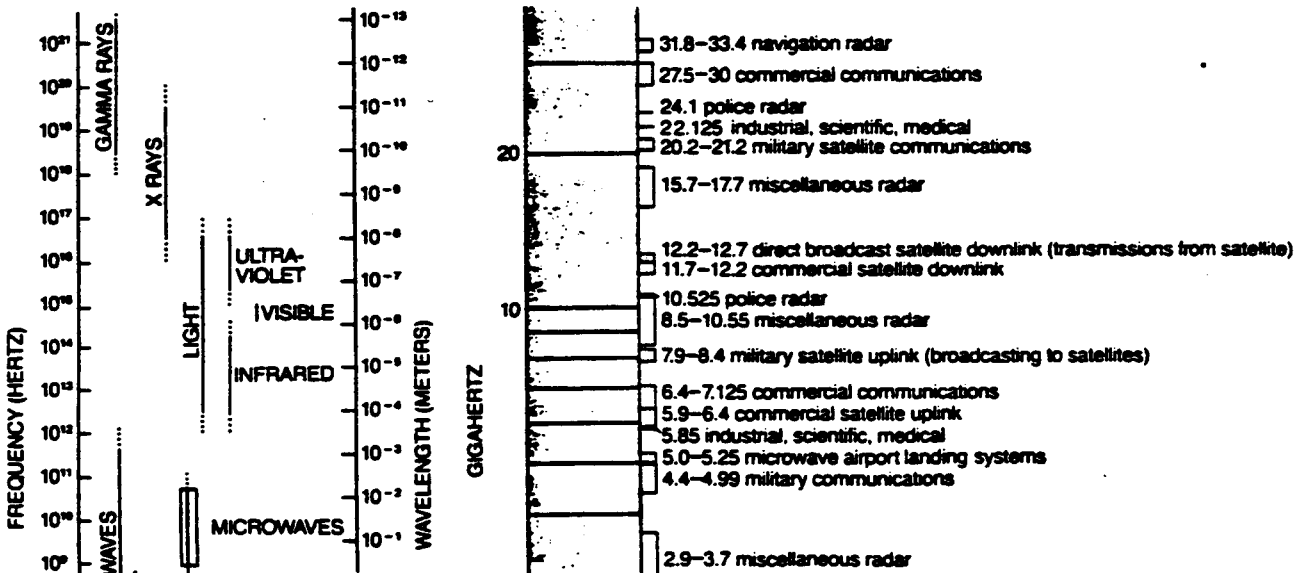



M A T R I X I I I

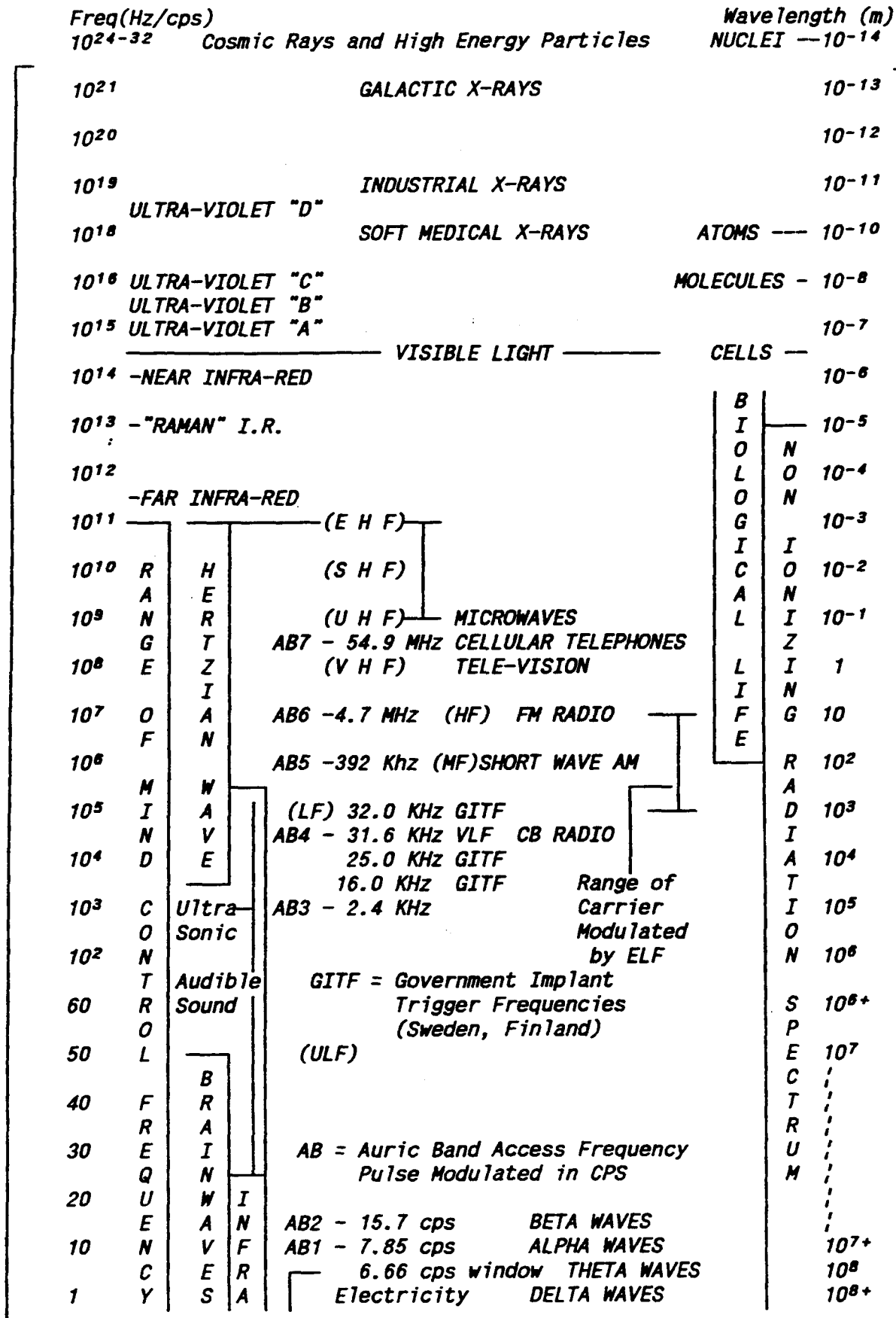

# MATRIX III

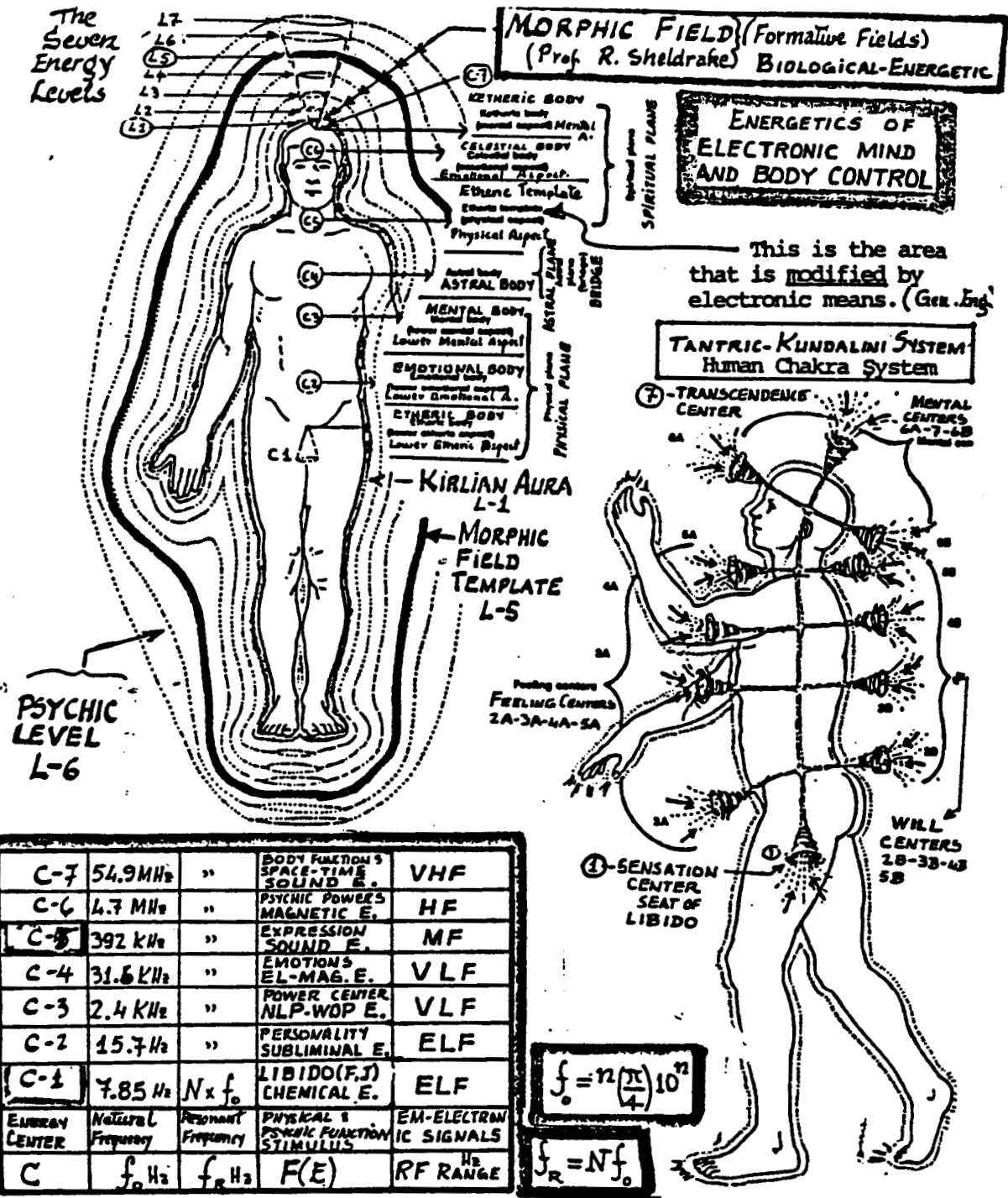

# M A T R I X I I I

## SECTION II

### Conversations With Researchers On Mind Control - December 1991

#### Introduction

The following is an extract from a taped interview with several researchers in the general area of mind control. It has never been published before. The interview, like many others that have been done, is done in an open question and answer format to protect the identities of the parties. The Orion Technology Report in Appendix 4 contains supplementary information that relates to this report.

X: Let's move along to things that are psycho-active in nature and things that people should know about.

Y: We now have discussed the early Phoenix Project. In about 1969 they wrote the final report for Phoenix I. In that report it stated that "since we now have studied the electromagnetic effects on human beings, we believe it is now possible to influence the way people think with electromagnetics". Of course when Congress read the report, they hit the ceiling, saying essentially, "we don't want you doing this!". Congress was afraid that someone would use this technology to control them. They said, in effect, "no, don't do this.". The people who wanted to continue this went to the military and said, in effect, "we can make you a nice little weapon that will make the enemy lay down their arms." How many people believe that the military doesn't want this? The military then offered them the use of the old base at Montauk. Then came Phoenix II and the Montauk project. Let's review that. They had three steps in the project. The first step in the project was something I like to call the "microwave oven" step. They wanted to see what the output of the multi-gigawatt transmitter would have on human beings in front of it. They took a subject and sat them in where they could be focused on and threw the switch. Of course, the subjects were cooked. We don't know how many people they killed this way, but we do know there were a lot of them. Finally, someone got the idea, "hey, we don't want the burning rays, we want the non-hertzian rays". They turned the antenna around and they aimed the gain horn through the reflector at the target person. Now they were getting somewhere. They were able to direct mood control from a distance by ELF modulating the transmitter and changing the mood.

This was a great success. Someone then came to them from the US Government and told them that they would provide them with sensors that would pick up thoughts directly from a persons' mind. So, they brought the system of sensors and installed them in a chair. This is the famous Montauk chair.

## M A T R I X I I I

What they did then is that they connected the output of the sensors to computers that would decode the sensors output into a digital code that represented the thought patterns. Those went to another computer which would store the thought patterns and to another computer which would generate the pulse modulations that went out the antenna. What they had actually built was a mind amplifier.

X: What would they do with this chair?

Y: They would take a subject, train him so that his conscious mind would be diverted to the "serpent in the Kundalini". The primitive mind would come up to the surface - they would blank that out and put in his primitive mind a concept that he would concentrate on. The concept would be picked by the sensors and transmitted out of the antenna. This was the second phase of Montauk. They were targeting whole populations and individuals. The subject could think of squelching electrical activity and all activity would stop where they focused the antenna.

X: What else where they able to do?

Y: They were able to change the way in which the animals in the area were moving. Once they programmed the animals to charge out of the woods into the town. They changed the way birds flew, fish swam and a dozen other things. They could take the crime statistics in Montauk and run it up and down like a yo-yo. They programmed crime waves for one period where they would occur for four hours each night for a week. This drove the police crazy. There was one time, according to the Montauk police, when all the kids descended on the beach - all the kids in town. Two or three hours later, the kids all left the beach in mass unison. Another time, all the residents of the town decided to drive up to the state park. When asked, some of them said that it seemed like a "good thing to do".

X: So what they had developed was ...

Y: They developed wholly operational mind control. Based upon the effect that they had to cancel out the fields at the chair, which was located underground, they noticed that conceptual effects would happen out of synch with real time. They realized that they had the capability of bending time. At that point, conferences were held to discuss how they would modify the equipment to more effectively bend time. They developed something called a Delta-T antenna. It consisted of three loops describing a delta-function; it was referred to as the pyramid antenna. It essentially was three magnetic pickups/transmitters at right angles to each other; three orthogonal loops. Orthorotation is, of course, how you get access to hyperspace. It means you have tensor stress orthorotations. If you drive the three parts of the antenna correctly, you get what is essentially a space-time portal in

# The Stoppage of Evolution of Mother Earth by Electro-Technology

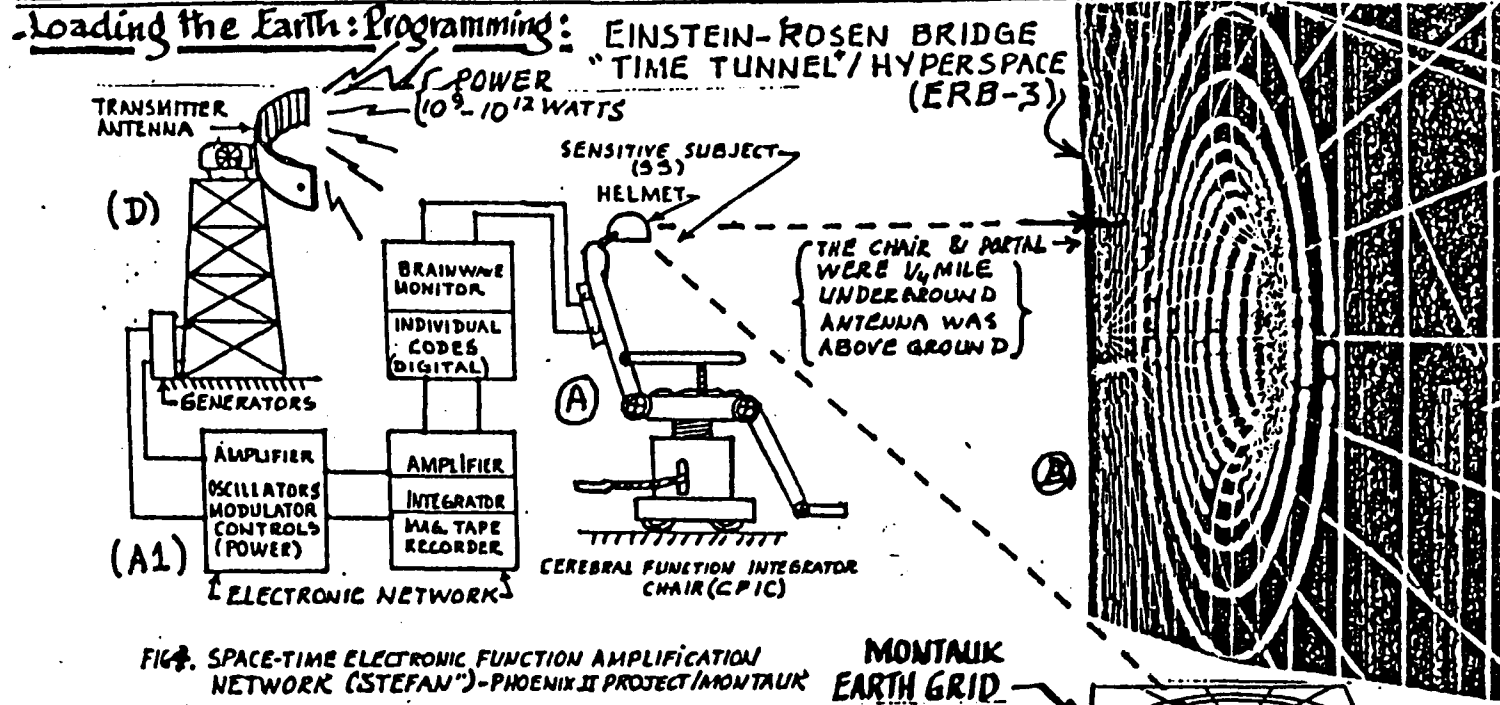

**FIG. 4. SPACE-TIME ELECTRONIC FUNCTION AMPLIFICATION NETWORK (STEFAN)-PHOENIX II PROJECT/MONTAUK MONTAUK EARTH GRID**

MONTAUK PHOENIX II/PHASE III: "STEFAN" PROJECT. Block diagram of the experimental set-up to create an EINSTEIN-ROSEN BRIDGE of the Third Kind (Skew-Symmetrical/Corkscrew/Winding, ERB-3). Sensitive subject is placed in CFIC, stimulated chemically to generate BETA-type Waves, placed in trance by Conditioned Response Altered Consciousness by a Guide to generate ALPHA + THETA-2 with SIGMA PEAKS Brainwaves collected by Helmet. This ANALOG SIGNALS are transformed-INDIVIDUAL DIGITAL CODES, amplified, modulated, and Magnetically Recorded. Then the info is fed into the interfacing computers that program the TRANSMITTER ANTENNA, Pulse-Modulated Power is radiated by the Transmitter, and the Mentally Synthesized Field Tensor Differential Equations yield the resultant parametric TENSOR FIELD FUNCTIONS specified. And--presto!--the ERB-3 is formed wherever it was specified.

PLANETARY GRID VORTEX WAS LOADED WITH PROGRAMMING TO "TRANQUILISE" THE EARTH, ETC.

0323

M A T R I X I I I

M A T R I X I I I

the center. The antenna looks like a pyramid with an inverted pyramid on top.

X: Could you go into the operation of the chair a little more?

Y: Yes. The output of the chair went into a Cray computer that would decode the digital representation of the thoughtform. That drove the IBM computer and the output from that went into the AIL computer...

X: AIL? Is that the Airborne Instrument Labs?

Y: Yes. The AIL computer generated the pulse modulation. It was a frequency-hopping signal source. It would change frequencies in a matter of nano-seconds. There were five synchro-dyne amplifier stages, cascaded. Each one had a separate pulse modulator. The final input was the amplitron, which had a big pulse modulator.

X: How did this thing work?

Y: They would take a portion of the thoughtform and put it into the first stage, and pulse the first stage on and load it into the second stage, etc. After the fifth stage it would go into the IPA's, be pulsed again and then into the amplitron, which would be pulsed and then the signal would go into the above ground antenna. Each time the signal would go from stage to stage, more complex information would be put into the thoughtform that was being cycled through. What does all this remind us of? The radiosonde. This is essentially a big radiosonde.

X: How did they figure the time aspect into all of this?

Y: They used the delta-t antenna, which was situated underground immediately under the christmas-tree antenna on top of the building. The chair was located underground between the delta-t antenna and the above-ground antenna. The delta-t generated time-stress tensors which were coupled with the electric field to generate the full time tensor control. It was great. They had a working time machine. They used twistor and spinor fields in order to form a portal. They could go anywhere in space-time, and they used it once to get access to the underground facilities on Mars.

X: To Mars? How did that work?

Y: First, the subject projected himself psychically through space to Mars. They set the computers to solidify the vortex between Montauk and the point on Mars and the vortex would be established. They only needed to do it once, because they taped it and could then run the tape to establish the vortex. There was a project called Project Phobos, part of which was

M A T R I X I I I

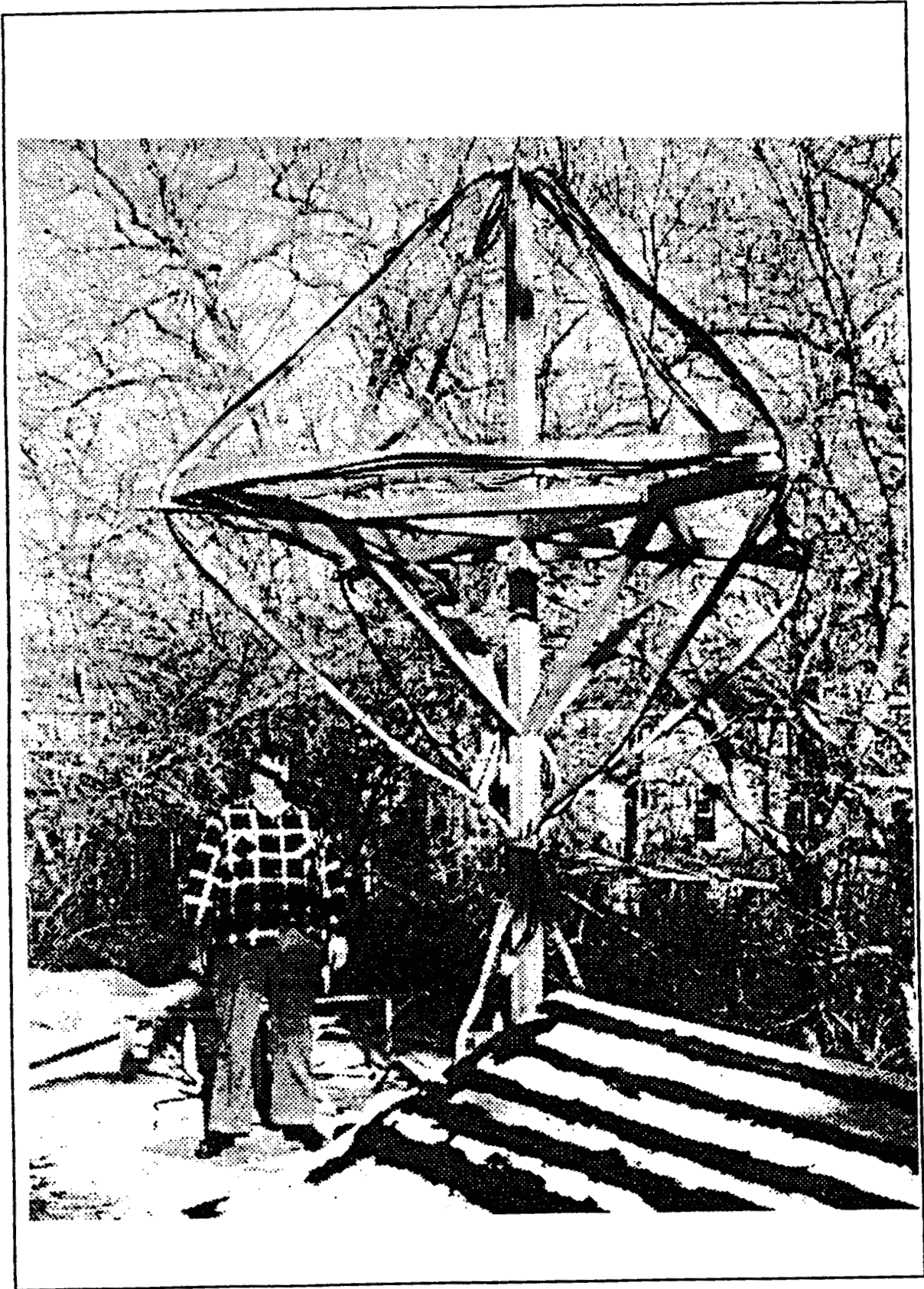

0 3 2 5

M A T R I X I I I

concerned with the investigation of the underground caverns. There were other project initiatives that had to do with a defense posture for the solar system. It was a directive of the people in command at Montauk to physically and psychically approach this defense mechanism, in order to find a way to turn the system off. It was done. If it were turned back on, the system would in effect become more "conscious" and able to reject outside intrusion.

X: I'm not sure I understand what you are really talking about with all this...does it have anything to do with the planetary grid?

Y: Yes, to a degree. There are planetary grid nodes on almost every military base. What we're talking about with the earth is putting the earth to sleep in order to prevent any geological changes of any great magnitude from occurring. We're pumping signals into the grid points, which you might compare to human chakras. It is mind control, in a way, that is also being done to the planetary mind of the earth.

X: What has happened since the Montauk project crashed in 1983?

Y: Well, after the Montauk project was discovered and ITT was taken apart, the government didn't leave it alone. They left ELF alone and they moved up to VLF through HF today. HF is 3-30MHz, MF is 300KHz to 3Mhz and VLF is 3KHz to 300KHz. If you tune across these spectrums, you are going to hear all sorts of pulse modulated signals that sound like the old Montauk signals. You'll hear signals similar but not identical to the Soviet woodpecker signals; you'll hear video buzzes on these bands- they don't have synch or chromo references on them. On VLF, you can tune into 15.75KHz horizontal rate and you hear phase modulation. I have receiving equipment that has dispersive IF filters that convert phase modulation to amplitude modulation so I can hear it. All your TV networks - the National Bureau of Standards (NBS) supplies free-of-charge the reference frequency to all TV stations. This is what they phase modulate. Does anyone believe the government gives anything away for nothing? I just discovered that this is part of the videodrome system. I have been tracking this for quite a while and wondered what it was. If you tune up to 31.4 KHz, which is twice the horizontal rate, and up to other multiples of the horizontal rate, you'll find other carriers which are similar to video but don't have the synch information accompanying them; they correlate to the horizontal rate and the phase modulation. In the Long Island area, these carriers are coming from the state parks. There are little VLF transmitter sites in the state parks; they are all run from satellite. We had psychics check this out on their level and they came up with the information that this VLF was in effect



## M A T R I X I I I

a softening up procedure to make the public susceptible to other mind control experiments.

The "American Buzzsaw" is the US equivalent of the Russian wood-pecker signal. This a psycho-active signal which is designed to interface with the mind of the human being by way of the mind-brain connection. The government has been quite active, designing systems that are carried by helicopter, systems that sit on the ground like the buzzsaw transmitters, etc. I first picked up the buzzsaw signal about 1990. I called the FCC and asked them if they knew what it was. They said it was the American version of the over-the-horizon radar. I said, "you mean like the Russian wood-pecker signal?". They said "yes". So they admitted that it had the same purpose. This signal is broadcasted on multiple carriers. The carriers hop from one frequency to another, anywhere in the range from 4MHz to 30MHz. It is never on the ham band or the international broadcast band. It is only on the allocated frequencies that the government shares with other communication services. With the switching of these frequencies, they are creating what is known as a Levinson Transform, named after Norman Levinson, who generated the mathematics for frequency-time transformations. This is highly significant, since the human brain, body and mind work on time dependent pulsations and frequencies which are time encoded. You have this unusual pulse modulated signal hopping around from frequency to frequency to frequency. They have multiple transmitter. The signals only come in phase at a targeted site. This signal, we believe, has three modes. The first mode is the search-mode. This is where they transmit a signal and then a psychically sensitive human being picks up the signal and sends something back. They can in this way identify these people and where they are. The second mode is the general transmission of a psychic interrupt function which interrupts psychic activity. That's all it does. It has a tendency to lower the overall psychic awareness of the population. Maybe one out of three people respond to this signal. A good psychic can easily screen this mode out of their consciousness. The third mode is where they target an individual, and we have known six people who have been targeted. They can lock on to the resonance of the synthetic material in your clothing and target you from that. We have a clearing device which uses the equivalent of a white-noise magnetic field to break up the magnetic matrix in objects in order to clear any psychic signatures or stored solitons in the object.

We put this device on the clothing, and you could hear the timing of the buzz-saw changing. It got more and more distorted, and then disappeared for a while; it then came back in on the search mode. This is telling me that it is an interactive signal. Also, if I scan up and down the band, it will find my receiver and lock in on that receiver. They are looking for a changing dynamic function. This must be how they

M A T R I X I I I

key in the search mode. As I tune the receiver from high to low, it is sending out a phase conjugate function that they are picking up.

X: How can an individual know if they are being controlled through the use of electronics?

Y: Well, if there was a process being impinged on a person that embodied a higher intelligence than the person had, at a higher power level than the person manifested, you could say that he was under control. There could be emotional or physical indication that something was "out of order". Typically, we all know when something is wrong. You have to be in touch with how you operate in a normal manner in order to distinguish when something abnormal is going on. You have to have a high order of awareness in order to recognize when an attempt is being made to violate your mind. Understanding how it works is probably your best defense against this, at this point. We have no shield, per se, no real way to jam it, but understanding does limit its effect by allowing you to "plug the holes" in your mentality. A technological device that would block it would have to go above the wave-order that embodies the human being. It would have to be a unified field type of device in order to be above the orthogonal rotations in hyperspace that they are using to transmit the effect. If you can personally operate within those higher orders, in consciousness, you can control what is going on around you, barring the use of a technological device. Another aspect is that if you operate "outside of time" in consciousness, then time-dependent hyperspacial pulsed modulations would have little or no effect. The people that are perpetrating this stuff want you to be unaware - that's why they're sending out the buzz-saw signals. The awareness that it is going on is by all means a major step.

X: How about the use of subliminals in the environment?

Y: There are doors to different levels within the "sub-conscious" areas of the mind that are keyed in by the focus of attention and the integration of emotion. For instance, the third and fourth level of the subconscious involves sexuality. Advertising and media focus on this subject should not be an area of focus. It is a "jumping off point" to get into the mind.

X: Are these "searching functions" directed toward specific areas, or do they cover the entire country...is there somewhere you could go to establish a safe reference point?

Y: Well, from the way I have heard it, there are at least five multi-megawatt transmitters propagating these buzz-saw signals. There are also many local transmitters all over the country. These large transmitters could probably reach anywhere in the world. The American buzz-saw signal is mostly

M A T R I X I I I

hertzian, and I believe it is affecting the magnetic field relative to the person more than the psyche, so magnetic shielding modes should be a step in the right direction. If you live deep underground, you probably would not even pick the signal up.

X: How deep would that have to be?

Y: Probably a mile or so underground would be enough. If you lived in a ring of mountains, they might not find you. See, this is not a time-stress that they are playing with. They don't need special equipment to do this now.

X: What do you mean?

Y: They need no more than the UHF cellular telephone frequency, which is now being installed everywhere, to do it. The human cranium resonates within the frequencies covered by cellular telephone continuous wave transmissions. The cellular system nationwide is connected to a computer system in Boulder, Colorado. We are very suspicious about what other capabilities that system has, since it is pulse modulated. That is not a relativistic signal - it is a hertzian in-domain type signal and it affects the physical. We suspect that they may be using the cellular telephone receivers to pick up the return signal from the buzz-saw. We have heard buzz-saw like signals on the cellular telephone network that correspond in frequency-switch-timing in the same way that the buzz-saw signals do. There is a definite connection between cellular telephones and the buzz-saw signal. And this is "over-the-horizon radar" that connects to cellular telephones? Come on, who's kidding who here.

X: How do the grid points interface with this technology?

Y: The grid vortex was initially used as an extension of the antenna structure. That's all it was used for - for the mind control part of Montauk.

X: What size grid nodes would you need for this. There are grid lines about every 1.5 feet.

Y: You have different kind of grid nodes. The Hartman lines are every 1.5 feet. The military bases are built on the large nodes where the lines repeat about every 15 to 20 miles.

X: Other than this electromagnetic pulsing, what other technologies are you hearing about that may be in this category.

Y: Well, the so-called videodrome signals on television. There is so much going on that could be involved.

X: Would you amplify a little on what you said about the

M A T R I X I I I

resonance of the human cranium?

F 1 6 v 2 4 m →  
Y: There is research that shows that the human cranium resonates at about 850MHz; this seems to vary from about 830MHz to 890MHz. The cellular system is designed to operate right in that range. The cellular system operates from about 840MHz to 890MHz. It is pulse amplitude modulated and pulsed angle modulated.

X: Angle. That would be phase.

Y: Right. You have regular analog modulation as well. When your portable cellular system is ON, it's in constant communication with the cell site. The set that you are carrying is telling the cell site where you are. When you get to the edge of the cell site it transfers you over to another cell site. They can also use this to track the people as well. Is that the only way to track?

Y: It is conceivable that they could track a person by the ringing within the cranial cavity. I do not know if they can do that yet. It is theoretically possible. Each persons cranium should "ring" with a different resonant signature.

X: What about the interface with this central computer for the cellular system. Could you go into more detail about that?

Y: The cellular system involves their use of a person they dubb a "roamer", which is a person who roams the country with a cellular transceiver. He has to be able to hand over from cell site to cell site as he travels. The only way a roamer can operate over the entire country is for the system to be tied into a central computer that keeps track of everything.

X: What about the so-called independent cellular companies?

Y: They are tied in. They have to be able to go on to long distance lines.

X: Do you think that these independent companies are also in bed with AT&T involved with mind control?

Y: Of course. They have to be. They are part of the network and they are all linked electronically.

X: Is this all controlled by the military?

Y: Sure. From what I understand, the master computer for the cellular system is in Boulder, Colorado. I don't think I have to tell you what else is in Boulder.

X: The center of the buzz-saw.

Y: Yes. That gives you the government connection. In fact, I

### M A T R I X I I I

believe that the central cellular computer is in the same building with the National Bureau of Standards.

X: Oh, my God. What more can you tell me about this videodrome signal?

Y: Well, about 6 cycles away from the signal is the harmonic of the power lines. I think that is your reference.

X: Is it pulse or phase modulated?

Y: It appears to be phase modulated.

X: Have you been able to de-modulate this videodrome signal?

Y: Yes. It's coming right over the television at people.

X: Most of the instrumentation in electronics is constructed to measure a charge couple to mass - the "real" component of the signal. How do you go about measuring the complex conjugate component of the signal which is psycho-active - the relativistic portion of the signal.

Y: That's not an easy task to do. The only way I know to measure such a signal is by measuring through the zero-point potential using an old-style regenerative receiver as a detector, because then you have the positron-electron pairs coupling through the vacuum and your relativistic functions will affect the coupling between the positron-electron pairs.

X: Is there a practical test that someone without access to a lot of instrumentation can use?

Y: Essentially, you can use any detector system. But all the detectors other than the regenerative type require a correlated hertzian function in order to pump the detector for it to detect the non-hertzian component or function. This is what makes a vacuum tube short wave receiver not fade the way others do. Its detecting the non-hertzian function, but not directly. If you move the hertzian part of the signal completely, your receiver just drops out to complete distortion because all you're getting is the delta pulses that come through the Dirac sea into the receiver. A regenerative detector can integrate those Dirac pulses into a usable function. If you had a white noise source pump a diode, you could hear the modulations in the white noise source. The problem is, how are you going to hear a delta pulse on the speaker in the audio amp? You have to somehow cross-feed the delta pulse to give you something that is usable.

# Earth's Power Grid Vortex

MATHEMATICAL & GEOMETRICAL MODEL OF EARTH GRIDS (VORTECES, LEY LINES)

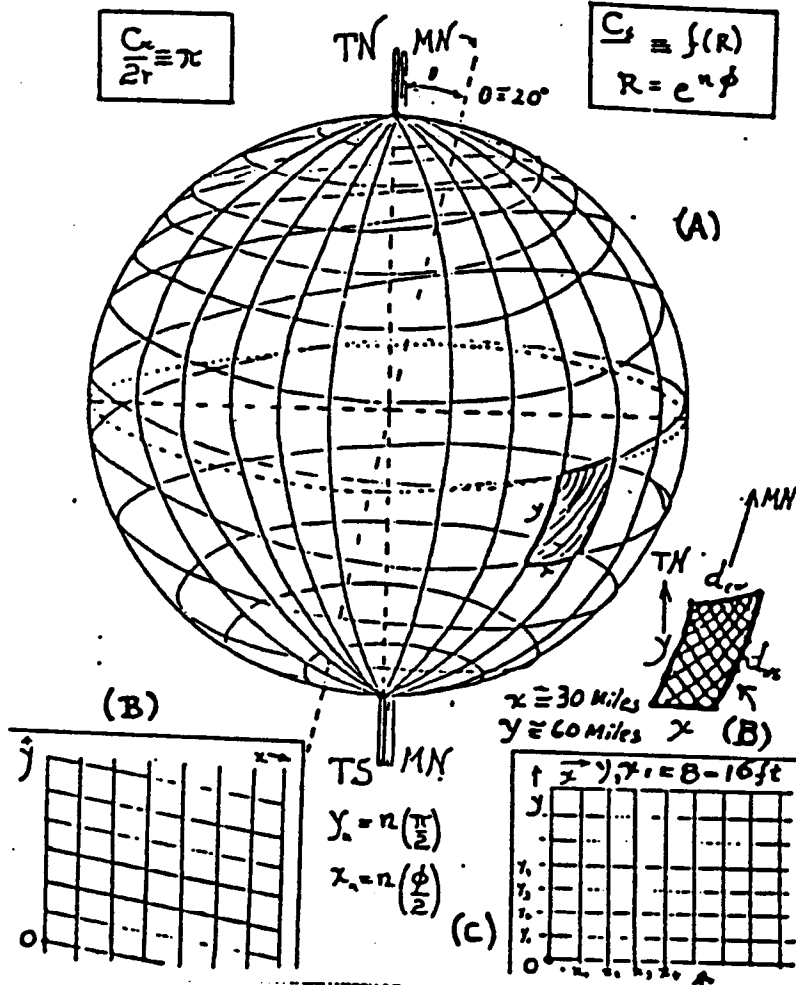

**FIG 5** (A) MODEL OF EARTH GRID MATRIX. LONGITUDE = LARGE CIRCLES (CONSTANT) FUNCTION OF  $\pi$ . LATITUDE = VARIABLE CIRCLES (SPIRAL) FUNCTION OF  $\phi$ .  
 (B) ELEMENT SECTION:  $\Delta y$  PARALLEL TO TN.  $\Delta x$  NORMAL(90°) TO MN.  
 (C) Mapping of Grids in your own Backyard. Major Points are 50-100ft apart.

# Earth's Power Grid Vortex

MATHEMATICAL & GEOMETRICAL MODEL OF EARTH GRIDS (VORTECES, LEY LINES)

LONGITUDE GRID LINES (N-S)  $\frac{C_r}{2R_e} \equiv \pi$  (CONSTANT) (1)

LATITUDE GRID LINES (E-W)  $C_s = f(R_p)$  (VARIABLE)

$\Delta y \propto \pi \left(\frac{\pi}{2}\right)$

$\Delta x \propto \pi \phi$

$R_p \equiv Ae^{n\phi}$  (2)

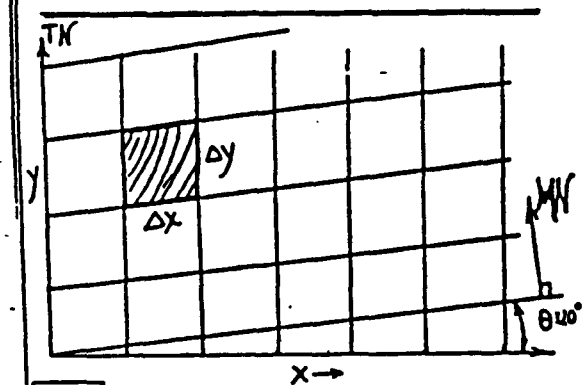

FIG 6 ORTHOGONAL PROJECTION OF GRID LINES ON "FLAT" PLANE OR EARTH'S SURFACE. THIS IS HOW GRID'S LINES (SHOULD) APPEAR WHEN MAPPED.

**EARTH GRID CYCLES:** The Earth Grid is the ENERGY MERIDIANS or CONDUIT of the LIFE-FORCE or UNIFIED FIELD ENERGY of the earth. The CROSS-POINTS of these Force Lines (LEY LINES) are the CHAKRAS or points where ANTE-MATTER & MATTER are created simultaneously. This GRID is like the NERVOUS

SYSTEM in a human being. The ENERGY in the GRID changes Yearly, Monthly, Weekly, Daily - even Hourly! These ENERGIES - YIN/YANG - are very SUBTLE, yet do constitute the ESSENCE of the POLARISED MANIFESTATION (3rd-2nd-1st Plane) of the UNPOLARISED LIFE-FORCE or UNIFIED FIELD ENERGY (6th-5th-4th Plane). TAO is Zero PI.

# Earth's Power Grid Vortex

MATHEMATICAL & GEOMETRICAL MODEL OF EARTH GRIDS (VORTECES, LEY LINES)



The Earth Grids are interconnected. The energy field between major crosspoint locations form an Ultraspace connection through hyperspace. Profuse amounts of Ante-matter (not Anti-matter) emanate from these Grid Intersection Vortics. By activating a major vortex, vortices connected to it are also activated. The Earth is presently "asleep", and is being maintained that way electronically by loading Grid Vortex nodes of the Planetary Grid, which is a network of force lines capable of storing information and energy. It is also the source of Ante-matter, that which creates matter. Through his programming, which is a derivative technology from the Phoenix projects, the Earth is being prevented from undergoing geological changes and processes of self-regeneration. The Planetary Grid connects the Earth with humans and with other bodies in space - the Grid is in essence the embodiment of the Morphic Field of the Earth and connects all living organisms. If all the electricity on Earth were to be suddenly neutralized by some photon quenching effect, the Earth would go into convulsions as part of the natural evolutionary process. It is also known that if the Earth Grid were activated by Unified Field Energy, the Earth would likewise be allowed to undergo its natural evolution. Unified Field energy has a vibratory structure of  $10^{68}$  cps.



M A T R I X I I I

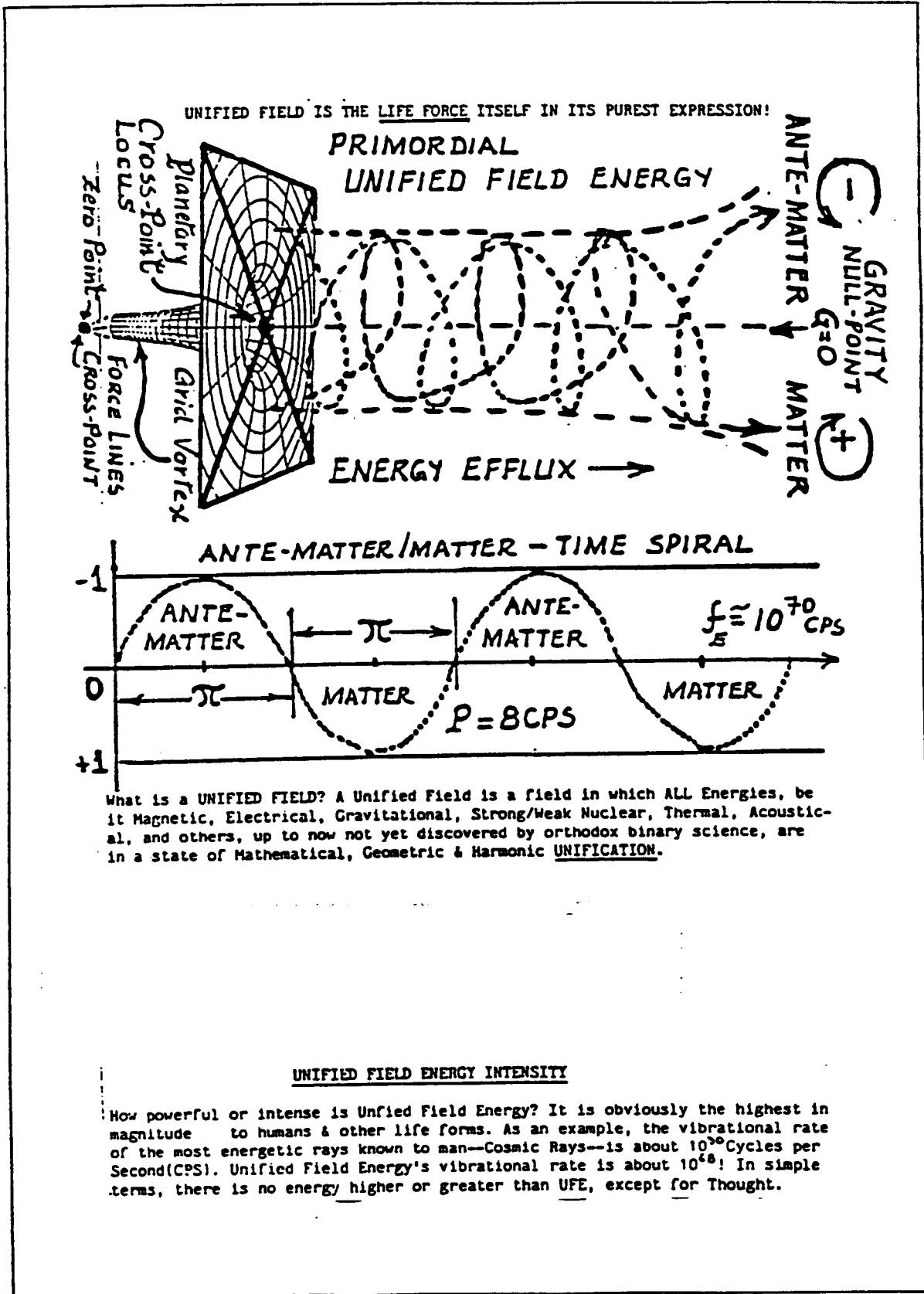
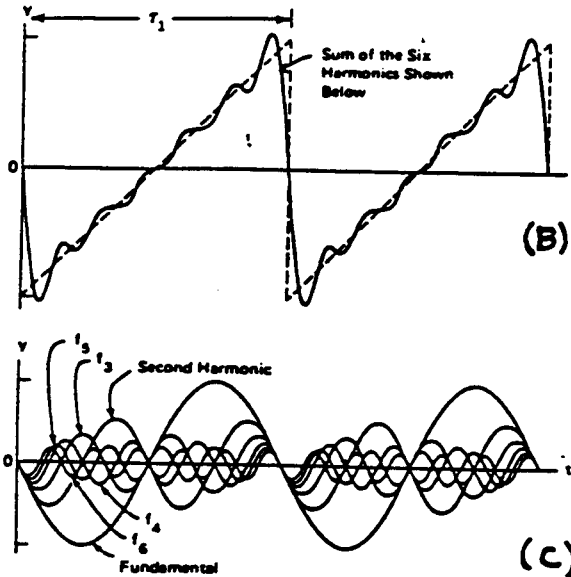
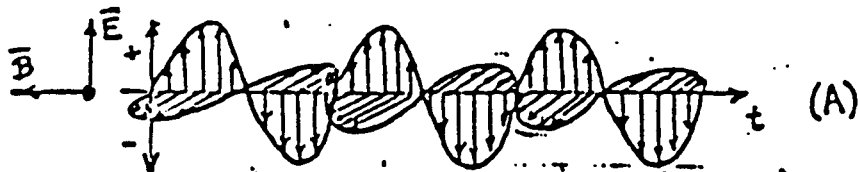

FIGURE 12. Fourier analysis (up to the sixth harmonic) of a sawtooth wave.



ANALYSIS OF A SIMPLE "SAWTOOTH" WAVE CAN REVEAL INFOLDED OR "HIDDEN" INFORMATION INSIDE IT. CONVERSELY, (FOURIER) TRANSFORMS CAN MAKE A COMPLEX WAVE (C) INTO A SIMPLE (B)

ONE OR VICE-VERSA. THIS IS ANOTHER WAY OF CONCEALING INFORMATION FOR ELF-TYPE OF MIND CONTROL & PROGRAMMING.



ELECTRONICALLY PRODUCED ULF (~25 CPS) IDEALISED SHAPE BASED ON THEORY

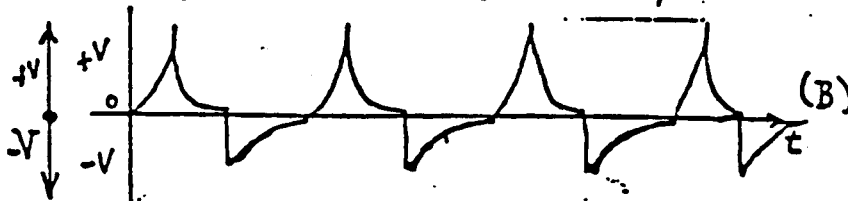

BIOLOGICALLY PRODUCED "ULF" PULSE (~5 CPS) (BROKEN BONE)

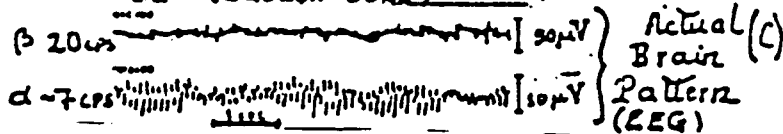

# Ultrasound & the Secret EM Grid for "MK Delta" Programming

THE "SECRET" ELECTROMAGNETIC GRID

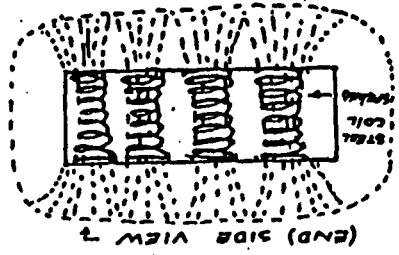
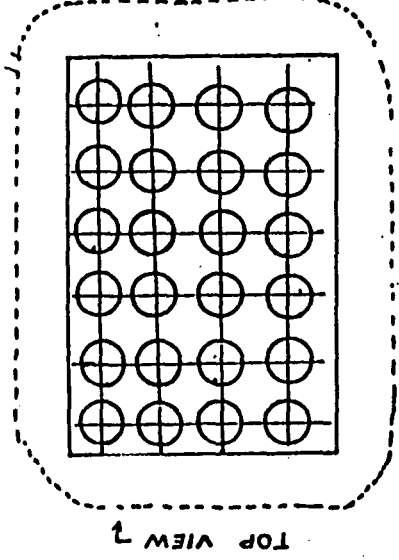

Field of Influence Around the Metal Spring Network/Guid of a Mattress. A Body Receiving ON TOP is Completely Enfolded IN THE FIELD OF THE COILS.

A new form of ACOUSTICAL ENERGY WAVELENGTH (AEV) has been removed... we created by modified transducer of SOUND WAVES, except that they are in the ULTRASOUND SPECTRUM (USS). These USS-AEVS are form of SCALAR WAVES or TD-LAND-FRD waves and are fundamentally different from Electromagnetic Waves. Very little was learned about this project other than it does exist and is being used. It supposedly creates a sustained "ringing in the ears". We will know more about this in the near future...SBI1

The "Secret Electromagnetic Grid" has been associated with the project MK DELTA. The key here was that "DELTA" referred to the Brain Wave Pattern in which this type of programming was to take place. The idea is simple; to keep the people ASLEEP just program the needed info to affect their brain while they sleep, which is their most receptive and vulnerable state anyway. How to accomplish this? Very simple! Every house in America has a TV antenna that is already tuned to electromagnetic waves. Therefore, an antenna is essentially a mini-transmitter as well! If it is made to oscillate by a suitable resonant frequency. By transmitting carrier waves in the TV/FM range and modulating them in the ELF/ULF range, the objective can easily be accomplished.

Furthermore, many years ago, a novel concept in "comfortable sleeping" was introduced by making mattresses with METAL COIL SPRINGS that conformed nicely to a reclining body. Later on, "standards" were introduced for the manufacture of these springs to determine the optimum material, number of coils, tension, etc., for "comfortable sleeping". Curious examination of these springs reveals that they are made of steel, which is ferromagnetic, same as most TV/Radio antennas, and the shape is Open Ended Hypocyclic, the most suitable form to create a similar induced magnetic field. Most bed springs have between 5 to 7 coils to provide suitable resiliency when compressed by a body (or 2!) lying down while sleeping or NOT sleeping.

When a human body is lying down in a metal-spring mattress, it is within inches of the metallic spring grid created by the underlying network of springs. These springs are natural antennas to any incoming Electromagnetic Waves, array or directed. Consequently, while we are in the most profound sleep--in the DELTA RANGE--we are enfolded in the field of the metallic spring matrix of the mattress, and are easy prey to Electromagnetic Waves programming in an ideal state of receptivity indeed! The implications of this seemingly innocuous state are truly momentous, but cannot be discussed in detail in this brief paper. Suffice it to say that the government knows exactly about this fact, which was most likely introduced by them in the 50s(?)

To close, it has been reported by various researchers that the insidious High Power TV/FM carrier waves modulated at the ELF/ULF range intended for MIND CONTROL are not stopped by anything, be it steel, concrete, earth, copper foil, copper paint, etc. It seems that the power radiated by the 8 strategically located "secret" transmitters across the U.S. radiate in the Real Vector Component and 1 Gigawatt in the Imaginary or Ethereal Component. That is much, much power!

forthcoming seminar at the Masters Center in February, '91. All the topics mentioned in this paper will be discussed in greater detail in a narrative MIND CONTROL on all unsuspecting "sleeping citizens". and is this SECRET ELECTROMAGNETIC GRID that is being used, or will be used, for

M A T R I X I I I

M A T R I X I I I

Major Frequencies Used by Government Electronic Technology

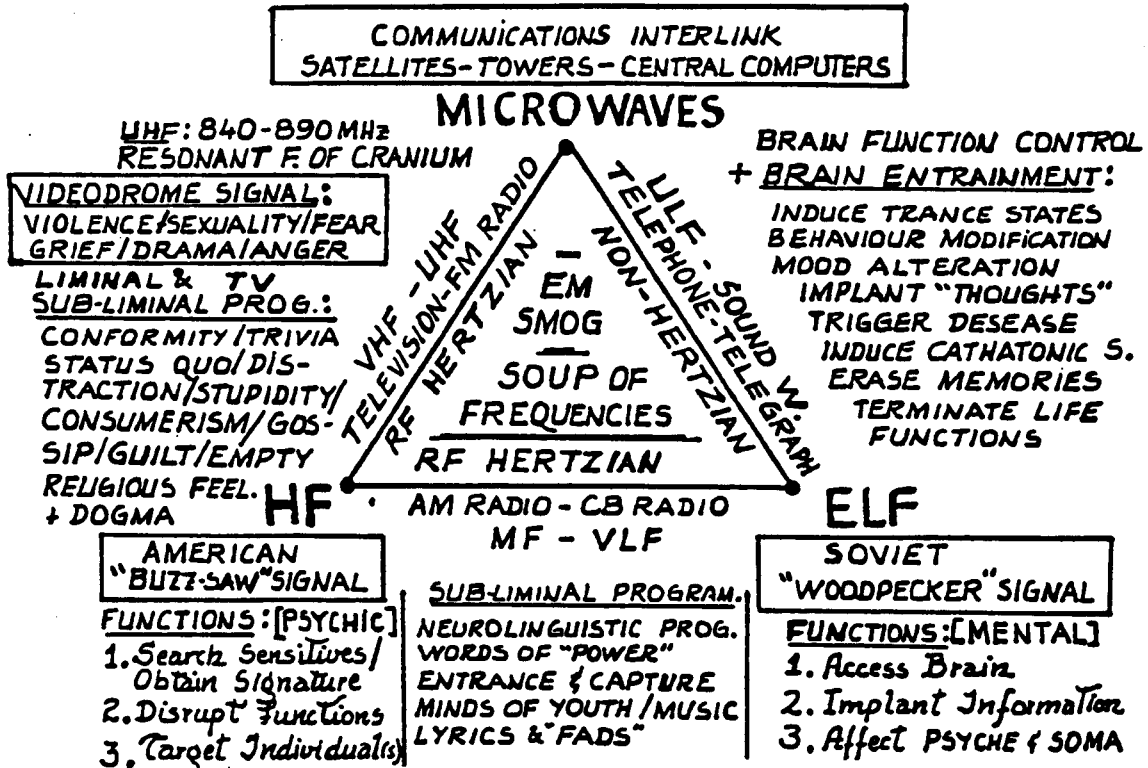

The Two Stages of Electronic Mind Control and Programming

Stage I:

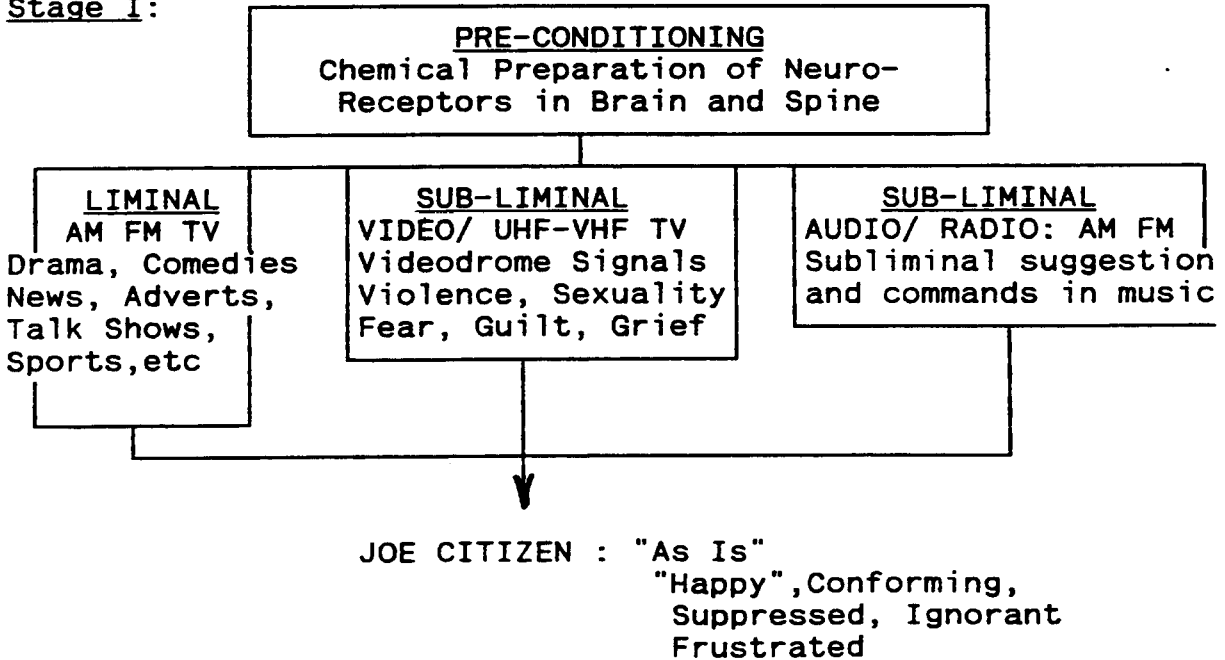

# M A T R I X I I I

Stage II:

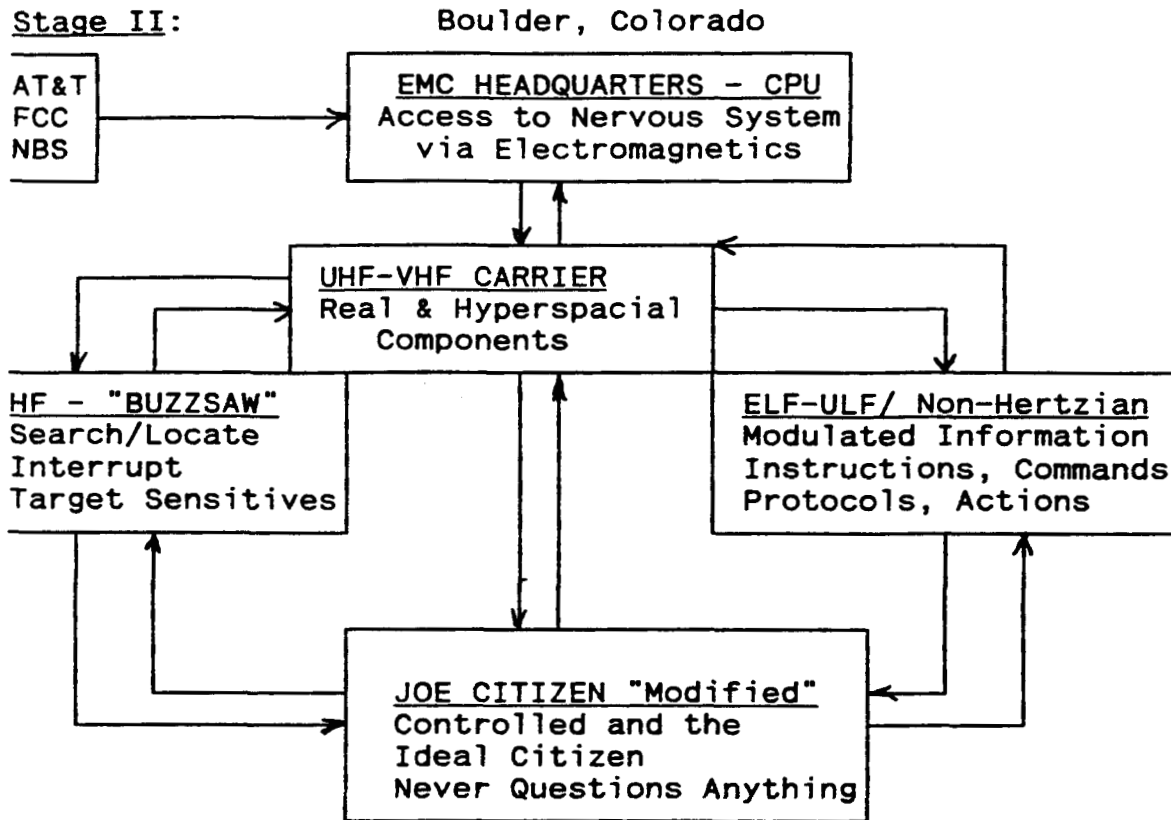

How can the electromagnetics have access to and impact the neurological structure? The nature of the brain and the skull casing is basically crystalline in nature. Anything that is crystalline resonates within certain frequency boundaries. Let's look first into the crystalline structure of the brain, as well as more about the nature of mind.

## The Crystalline Structure of the Brain

The mind of the human is a mind within a Mind, a membrane within a Membrane, a cell within a Cell. These holographic aspects reflect the functioning network of the Universal Intelligent Matrix, which enfolds within itself various mind structures throughout the latticework of manifestation. There is a photonic (light) movement through this network on a stepped dimensional basis. Each individual human mind is situated at harmonic points on an inter-dimensional gridwork. Each area of mind interpenetrates a physical brain. The brain can be seen as a liquid crystalline resonating organic structure which grounds the mind. As the mind interpenetrates the brain, different anatomical structures resonate with and ground particular aspects of the mind's functioning.

There are four separate resonating systems within the human head - the sensory cortex, the right and left hemispheres, the third and lateral ventricles, and the skull.

## M A T R I X I I I

All these are areas where pulsating magnetic fields of opposite polarities are set up, these being very sensitive to environmental fields. These pulsating magnetic fields provide a resonance-based method of retrieving information from the environment via resonant feedback. Each of the four areas has a function which acts as a separate reception/amplification area for different aspects of the universal frequency spectrum.

The actual structure of neural material, again, can be seen as a magnetically and gravitationally oriented liquid crystall colloidal matrix. Within this general structure, there exist magnetic and gravitational domains that appear to have a distinct relationship with the mind centers and the energy channels. Holographically coded energy patterns are focalized within the primary mind centers and then mirrored within the brain matrix along various quantum-based holographically oriented axial networks. Waveforms originating with the various domains form standing wave interference patterns which represent information that is encoded into memory-linked membrane structures within the brain tissue.

Bear with me a little longer, here. The brain can be viewed simply as a biocrystalline receiver and amplifier. It represents the master control, as it were, for all aspects of biological functioning and is the principle area in which and through which there is a continuous inter-dimensional connection and resonance.

The brain-mind combination selectively received and transduces higher level input through a series of highly sensitive tensors, which could be compared to microscopic antennae, millions of which form energy templates at various dimensional thresholds within the dynamics of the neural structure. These cilia-like antennae function as threshold membranes for the processing of thought-form and other energy fields in an all-or-nothing fashion. The coded configuration, realized through Fourier translation, of any given energy field has a corresponding holographic/hyperspatial stress/no-stress pattern. These tensor templates transduce and step down the input into lower dimensional modalities. At the level of the physical brain, these tensors manifest themselves as villia, cilia and spherical bodies lining the various brain ventricles. The tiny villi on the inside of the cerebral cavities act as "cathode" and "anode" structures and cause the brain to become a resonating radiating vehicle of an enhanced wave-field. We will examine some other aspects of thought reception, but first it would be prudent to take a look at the actual process where thought wave patterns, in this case represented by Theta ( $\Theta$ ), manifest themselves into mass. This will greatly expand your understanding of this approach to thought-wave quantum mechanics; much of it requires an expanded understanding of consciousness.

SYNCHRONICITY: The Principle Behind "PSYCHIC PHENOMENA"  
 I. The Jung-Pauli Connection: Quantum Mechanics & The Psyche

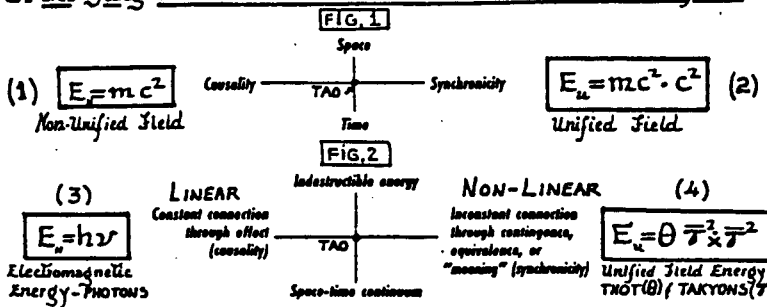

PAULI EXCLUSION PRINCIPLE: The (FIG. 1 & 2) IS A DIAGRAM TO SHOW THE PRINCIPLES & LAWS THAT EXPLAIN HOW EVENTS IN THE UNIVERSE OCCUR THRU THE "ETHERIC MEDIUM" OF THE ANTI-SYMMETRIC DANCE of Matter SPACE-TIME CONTINUUM VIA THE AGENCY OF ENERGY

SYNCHRONICITY: THE PHYSICS OF A-CAUSAL INTER-CONNEXIONS  
 I.A.M. Mathematical Approach Based on Ancient Principles: I CHING  
Mathematical Symbols                      Simple Interpretation / Name

$\theta \equiv 0$   
 No Movement  
 ABSOLUTE REST

**TAO - THOT ENFOLDED WITHIN ITSELF.**  
 (0) TAO, Ku, Void, IS, PRIMORDIAL THOT, NOX. Ultimate Nothingness, Absolute Permanence, Non-Materiality & Emptiness, The Great Whole.

$\theta \equiv 0 \Rightarrow \infty$   
 MOVEMENT  
 THOT REFLEXION

(1) WU-CHI TAO, THOT UNFOLDING  
 Infinite Potentials - Infinite Information  
 The Information-Potentials Continuum (IPC)

$C \equiv \frac{\Delta \theta}{\Delta \tau_0}$   
 FLOW OF THOT

(2) I (Ee). CONSCIOUSNESS. Derivative of Thot as a function of Time Zero = NOW. Flow of Thot. (TIME ZERO IS NOT ZERO TIME;  $\tau_0 \neq t_0$ ) LUX.

$\bar{A} \equiv \bar{W} \times \bar{F}$   
 COGNITION IS BORN FROM WILL & FOCUS

(3) Li. AWARENESS. Alertness, Cognition based on Will = Directive =  $\bar{W}$  & Focus = Direction =  $\bar{F}$   
 Knowingness based on Will & Focus. Intrinsic Driving Forces that are Truly DIVINE.

$\bar{A} \times C \equiv \bar{E}_u$   
 $\bar{E}_u \equiv \frac{\Delta C}{\Delta t_i}$   
 FLOW OF CONSCIOUSNESS "THE AQUEOUS"

(4) CHI. ENERGY. Awareness awakens Consciousness which creates Energy. A Willful Focus (4A) on Consciousness awakens it & Energy is born. Also, Energy is a Derivative of Consciousness as a function of Time Flow.  $\Delta t_i$  (4A). FLUX.

$\bar{P} \equiv \frac{\Delta \bar{E}_u}{\Delta t_i}$   
 FLOW OF ENERGY

(5) CHING. POWER. Power is a Derivative of Energy as a function of Time flow. A Change in Energy induces Power.  $\bar{P}$  creates Real Time,  $t_r$ .

$\bar{S} \equiv \frac{\Delta \bar{P}}{\Delta T}$   
 FLOW OF POWER NOT CAUSED BY CONSCIOUSNESS BUT OBSERVED ("FROZEN" BY IT VIA INTERCONNEXIONS) IN THE NOW. THE EFFECTS EXIST BEFORE THE "CAUSE".

(6) I CHING. SYNCHRONICITY: The Derivative or CHANGE of Power as a function of Time Zero = NOW. It is a multicomponent, multidimensional NON-LINEAR TENSOR,  $\bar{S}_{it}$ , which connects A-CAUSALLY all the Parameters, Information & Events in SPACE-TIME in THE NOW. It is activated by a Willful Focus on Consciousness via The Energy of the ACTION OF INQUIRY or DESIRE TO KNOW. TO DO, TO DARE TO KEEP SILENCE. JCs Space is ULTRA-SPACE.

(CP)  $\bar{U}$  IS FACTOR (IF)

True Cosmology: INVOLUTION

- 10)  $\theta$  (VOID - NOX) That in Unmoving State  
 (7)  $\theta \cdot \theta \Rightarrow \tau_0$  (TACHYON) That Reflexion = Consciousness (LUX)  
 (6)  $\tau_0 \cdot \tau_0 \Rightarrow \Delta_{\tau_0}$  (DELTON) Consciousness R. = Energy <sup>UNIFIED FIELD</sup> PURE MAGNETISM = (UFE)  
 (5)  $\Delta_{\tau_0} \rightleftharpoons \mu_0$  (MU<sub>0</sub>) Energy  $\Rightarrow$  Ante-Matter (AM)  
 (4)(A)  $\mu_0 \rightleftharpoons \mu_1$  (MU<sub>1</sub>) ANTE-Matter  $\Rightarrow$  Primordial M. (PM)  
 (B)  $\Delta_{\tau_0} \rightleftharpoons \Delta_{\tau_0}^{(+)} + \Delta_{\tau_0}^{(-)} + \Delta_{\tau_0}^{(0)}$  UNIFIED FIELD ENERGY  $\Rightarrow$  Derived E. (LFE) (IDEALS)  
 (C)  $\Delta_{\tau_0}^{(+)} \cdot \mu_1 \rightleftharpoons \mu_1^{(+)}$  } (GLUONS) Positive E. (P.M.)  $\Rightarrow$  P. Pos. Charge  
 (D)  $\Delta_{\tau_0}^{(-)} \cdot \mu_1 \rightleftharpoons \mu_1^{(-)}$  } Negative E. (P.M.)  $\Rightarrow$  P. Neg. Charge  
 (E)  $\Delta_{\tau_0}^{(0)} \cdot \mu_1 \rightleftharpoons \mu_1^{(0)}$  (GRAVITON) Neutral E. (P.M.)  $\Rightarrow$  P. Neut. Chrg.  
 (3)  $\mu_1^{(+)} + \mu_1^{(-)} + \mu_1^{(0)} \rightleftharpoons E$  (PHOTON) P.P.C. + P.N.C. + P.Nu.C. = Photon Light E. (LUMEN)  
 (2)  $E \rightleftharpoons m_1^{(+)} + m_1^{(-)} + m_1^{(0)}$  Photons  $\Rightarrow$  PLASMA (m) "BIG BANG" EXPLOSION  
 (1)  $m_1^{(+)} + m_1^{(-)} + m_1^{(0)} \rightleftharpoons p^+ + e^- + n^0 \rightleftharpoons M$  Solid MASS

$\tau_0$  = TACHYON. Primordial PARTICUM that IS Consciousness, the original Light PARTICUM of CREATION. Light from The VOID = LUX.

$\Delta_{\tau_0}$  = DELTON. Primordial PARTICUM that IS Energy, Unified Field Energy. IT ENFOLDS  $\tau_0$  is guided by Consciousness,  $\tau_0$ .

$\theta$  = Primordial That. NOX the Great Darkness, the VOID, KU, The TAO



- (0)  $\Theta$  = Primordial That. NOX the Great Darkness, the Void, KU, THE TAO.
- (7)  $T_0$  = TACHYON/TAKYON. Primordial Particium that Is Consciousness, The original Light Particium of Creation. Light from the VOID = LUX.
- (6)  $\Delta_0$  = DELTON. Primordial Particium that Is ENERGY, Unified Field Energy. It ENFOLDS and is guided by Consciousness,  $T_0$ .
- (5)  $\mu_0$  = ANTE-MATTER. That which Precedes and Creates Matter in a  $(MU_0)$  Unified Field via and from  $T_0$  Continuum. Not to be confused with Anti-matter of 1st. Plane.  $\mu_0$  is the IDEAL of A-M.
- (4)  $\mu_1$  =  $(MU_1)$  Primordial ANTE-MATTER. TAKYON-DELTON Continuum creates the IDEAL  $\mu_0$  that Transfixes from 5th-D to 4th-D to produce  $\mu_1$  emitting "Black-light" or ULTRAVIOLET (Not Visible) Light in the Void.

$\Delta_0^{(+)}$  } DELTONS that constitute the IDEALS of Electrical Charge, which  
 $\Delta_0^{(-)}$  } are Primordial POSITIVE, NEGATIVE, and NEUTRAL Energy.  
 $\Delta_0^{(0)}$  } Polarised Energy or "Decoupled" Components from the 6th  
 Plane DELTONS,  $\Delta_0$ , from the TAKYON CONTINUUM.

**NOTE: THE TAKYON-DELTON CONTINUUM IS BEYOND DISTANCE SPACE & TIME**

$\Delta_1^{(+)} \cdot \mu_1$  } DELTONS Coupled To Primordial Ante-Matter to create the  
 $\Delta_1^{(-)} \cdot \mu_1$  } PRIMAORDIAL ELECTRICAL CHARGES before they are manifested  
 $\Delta_1^{(0)} \cdot \mu_1$  } into 1st Plane Mass. These are the GLUONS and Sub-Atomic  
 Particiums of Quantum Mechanix.

$\mu_1^{(+)}, \mu_1^{(-)}, \mu_1^{(0)}$  = Ante-Matter Polarised or "Decoupled" from  $\mu_0$  and  
 beginning to Coagulate into VISIBLE-LIGHT, 3rd Plane  
 Flash of Visible Light occurs at this point where Photons  
 are formed, which are the 7 colours of Visible Spectrum.

- (3)  $E$  = { Photons. Visible Light Units or Quantum of Energy,  $h\nu$ , 7 colours.  
 LUMEN TIME begins to formulate in this level.
- (2)  $m_1^{(+)}$  } PLASMA. Highly Ionised -Electrically Charged Mass at very  
 $m_1^{(-)}$  } High Temperatures (Per Binary Orthodox Science). This is the  
 $m_1^{(0)}$  } Material that makes-up the SUN, which is COOL, per OBT.  
 This is the Particiums that constitute our "BLUE CORONA".
- (1)  $m_2^{(+)}$  } Gross-Matter Electrically Charged, or Neutral(0), of 1st Plane  
 $m_2^{(-)}$  } which are constituents of Protons,  $p^+$ , electrons,  $e^-$  and neu-  
 $m_2^{(0)}$  } trons,  $n^0$ , which make-up gross-matter,  $M$ , Solid Mass.

**NOTE:** The "BIG-BANG" of Orthodox Binary Science occurred in the 2nd  
 Level, the Plane of PLASMA.  
 Above L-3 TIME does not exist. Below L-4, TIME exists.

- (0)  $\theta \equiv 0$  (Nox) *The Sacred Void, Is, KU, TAO. Absolute Permanence, Isness in Rest. The Source. Non-Materiality & Emptiness. The Whole.*
- (1)  $\theta \equiv 0 \equiv \infty$   
(NOXON: Pure Potential) *From Nothing comes Everything. Nothing is Absolute Pure Potential. The Source is always greater than its Infinite Potentialities it engenders. This is the Mathematical Void.*
- (2)  $\infty \equiv E_u$   
(LUXON: Unified Field) *Pure Potential is the Source of UNIFIED ENERGY. Unified Energy comes from an Infinite Source. Unified Field is where Unified Energy is created. Unified Field Energy (UFE) is Unlimited.*
- (3)  $\sum_i \mu_i \equiv 1$  *The Sum of all created ANTE-MATTER & Matter is always equal to UNITY = 1, not 0, zero.*
- (4)  $\sum_i E_i = E_u \equiv 1$  *The Sum of all derived (de-coupled) energies,  $E_i$ , is always equal to UNITY = 1, not zero.*
- (5)  $\sum_i E_i = E_u \ll 0$  *The Sum of the Parts is always LESS than The Whole.*
- (6)  $E_u \equiv 1 \equiv \infty$  *Unified Field Energy is always Unified = Unity = 1, yet it is Infinite, and is never exhausted, for it comes directly from The Source.*
- (7)  $E_u^0 = \theta \overline{T}^2 \cdot \overline{T}^2$   
(FLUXON: UFE in Motion)  
[The "AQUEOLLS"] *Unified Field Energy not in Motion is Pure Potential (NOXON) - being Gathered, Collected or Stored in a given SPACE (LUXON). Unified Field Energy in Motion creates a FLUX in the TAKYON-CONTINUUM (FLUXON)*
- (8)  $E_u^1 = m \overline{c}^2 \cdot \overline{c}^2$
- (9)  $E_u^1 = E_N \cdot \overline{c}^2$
- (10)  $E_u^1 = \mu_0 c^4$  *Unified Field Energy is equal to the Non-Unified Energy of Gross Matter,  $E_N = mc^2$ , accelerated tensorially by  $\cdot \overline{c}^2$  or  $\times \overline{c}^2$ . This reverses the vibration of Gross Matter back to ANTE-MATTER which is vibrating at  $|c^4|$ , Speed of Light to 4th power.*

Physics of Pyramid & the Master-Triad System

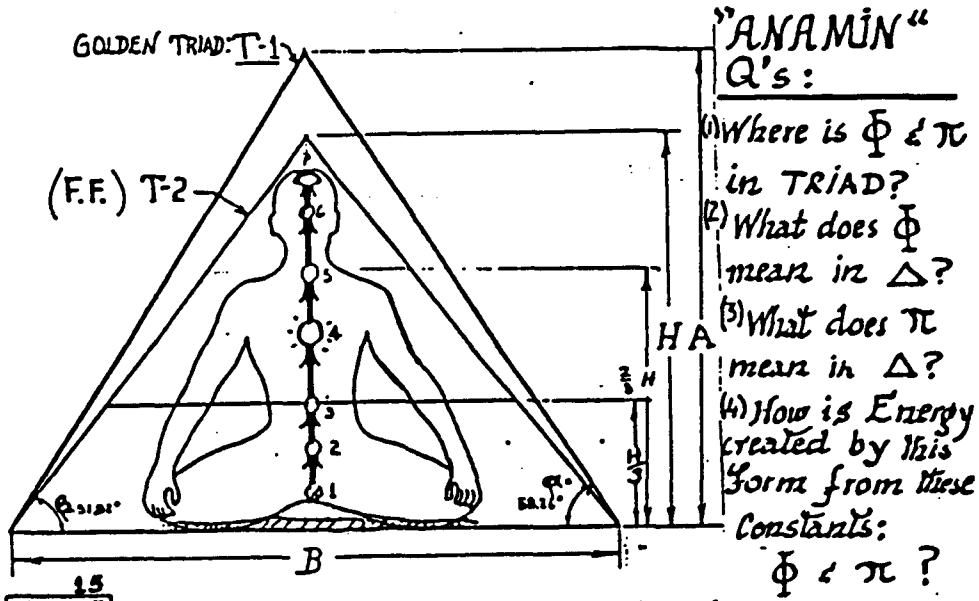

**FIG 18** RELATIONSHIP BETWEEN PYRAMID DIMENSIONS AND AVERAGE HUMANOID BODY'S ENERGY CENTERS (S) NOTICE THE POWER CENTERS CO-INCIDE,  $H/3 = S-3rd$ .

Derivation of  $\pi$  from Geometrical-Mathematical F.F. :

- (1)  $\Phi$  is the Ratio of  $(\frac{B}{2})/A$  in the Golden TRIAD  
 $\pi$  is in the ANGLE  $\beta$  of the PYRAMID  $4 \cot \alpha = 4\sqrt{\Phi} = \pi$
  - (2)  $\Phi$  in PYRAMID means SPIRAL ENERGY FLOW (FIBONACCI SERIES)
  - (3)  $\pi$  in PYRAMID means CIRCULAR VOLUME CONTAINMENT (CONE) which creates a RESONANT CAVITY. Base is Diameter of Cone Base
  - (4)  $\pi$  provides CIRCULAR MOTION+CONTAINMENT &  $\Phi$  provides SPIRAL VORTEX MOTION UPWARDS. interacting with  $\vec{E} + \vec{C}_A$ . The Ratio ( $\frac{\pi}{\Phi}$ ) is the F.F. Constant & extends to Infinity.
- ( $\pi$ ) symbolises CONSCIOUSNESS; ( $\Phi$ ) symbolises ENERGY.  
 Focused on APEX creating the ZERO POINT.

M A T R I X I I I

The Mechanism of Thought Reception and Conversion to Electrical Impulses by Mind-Cranium Brain Transduction

A Theta ( $\theta$ ) wavefront arrives from outside the skull. It then sets up resonances in the five sections of the cranial bone plate. A five-fold standing wave pattern of  $\theta$ -lowered Tachyons ( $T$ ) interacts with the liquid crystal structure of the brain. That part of the brain structure that matches the frequency of the vibrating Tachyons will respond via harmonic resonance. The Tachyons, which enfold energy, will provide Deltons, which in turn create ante-matter and matter simultaneously. Electrons are formulated and an electric pulse flows, giving rise to a perceived thought.

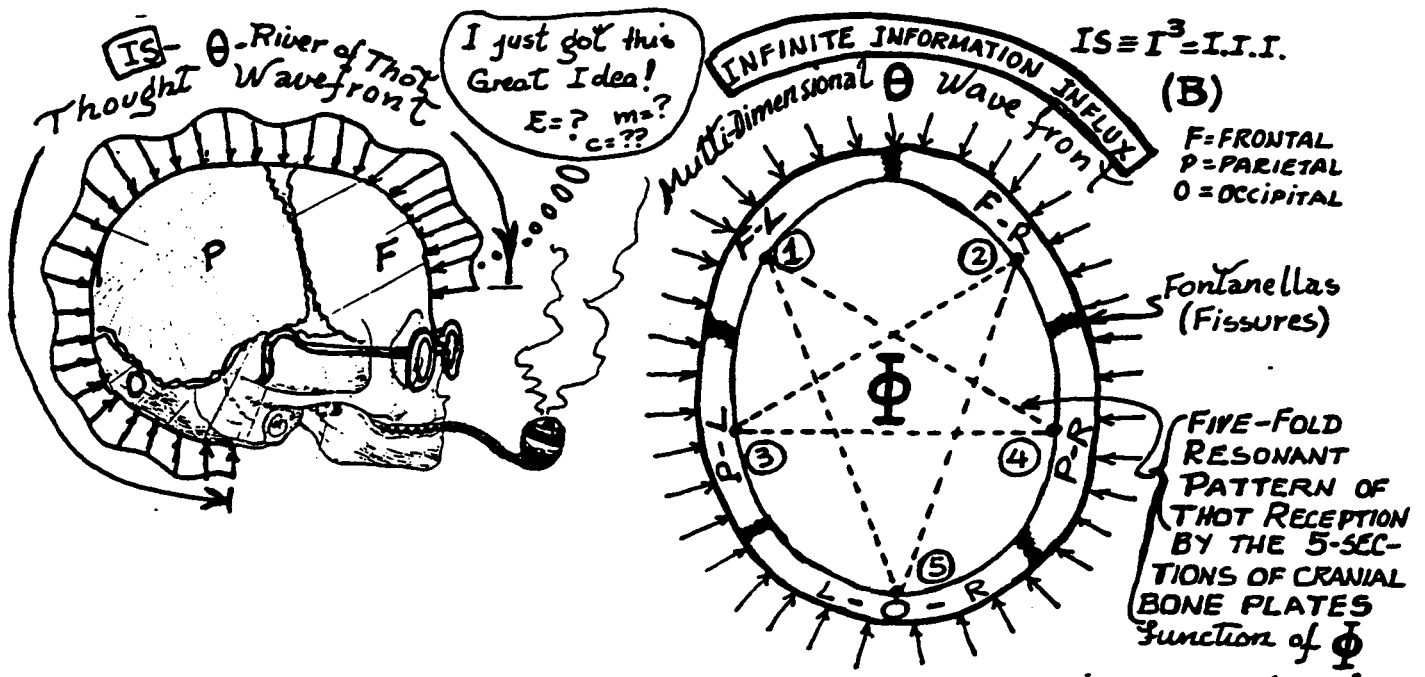

The human brain is a masterpiece of sacred geometry, chemistry, alchemy and structural engineering. It is constructed in five major hard bone plates interconnected by cartilaginous membranes, called fontanellas, that allow subtle lateral motion and non-linear complex vibrations to take place. The cranium (skull) is a superb transducer of linear and non-linear complex vibrations. Complex vibrations can also be called conjugate, in that they have both three-dimensional and hyperspacial components.

Now, this is important. The natural resonant vibrational frequency of the cranium is in the range of 840-890 MHz in non-hertzian vibration. Unfortunately, an externally applied hertzian wavefront of 840-890 MHz can and does make the cranium undergo resonance due to entrainment. Only 10-20%

# MATRIX III

power/coherence is needed. A little research will tell you that this band of frequencies used to be reserved years ago for VHF television. NOW, it is the exclusive band for the national cellular telephone network.

With the help of alien technology, government scientists can now duplicate the Non-linear, random, non-hertzian wave-fronts of thought - the so-called "thinking process". With the adequate modulations of RF and microwaves they can induce vibrations in the cranium, access the neural lattice in the brain, and implant "thoughts" via ELF/ULF. Thus, individuals so impacted (unless they really know themselves on a deep level) think it is their own thoughts they are perceiving.

## VARIOUS VIEWS OF THE CRANIAL CAVITY

Below, we have an illustration showing various views of the cranial cavity which houses the brain. Notice the geometry is not a sphere, but resembles an oblate spheroid. This same configuration is, by the rules of sacred geometry, a function of the constants PI and PHI. This assymetry is associated with a resonant cavity capable of enfolding a unified field.

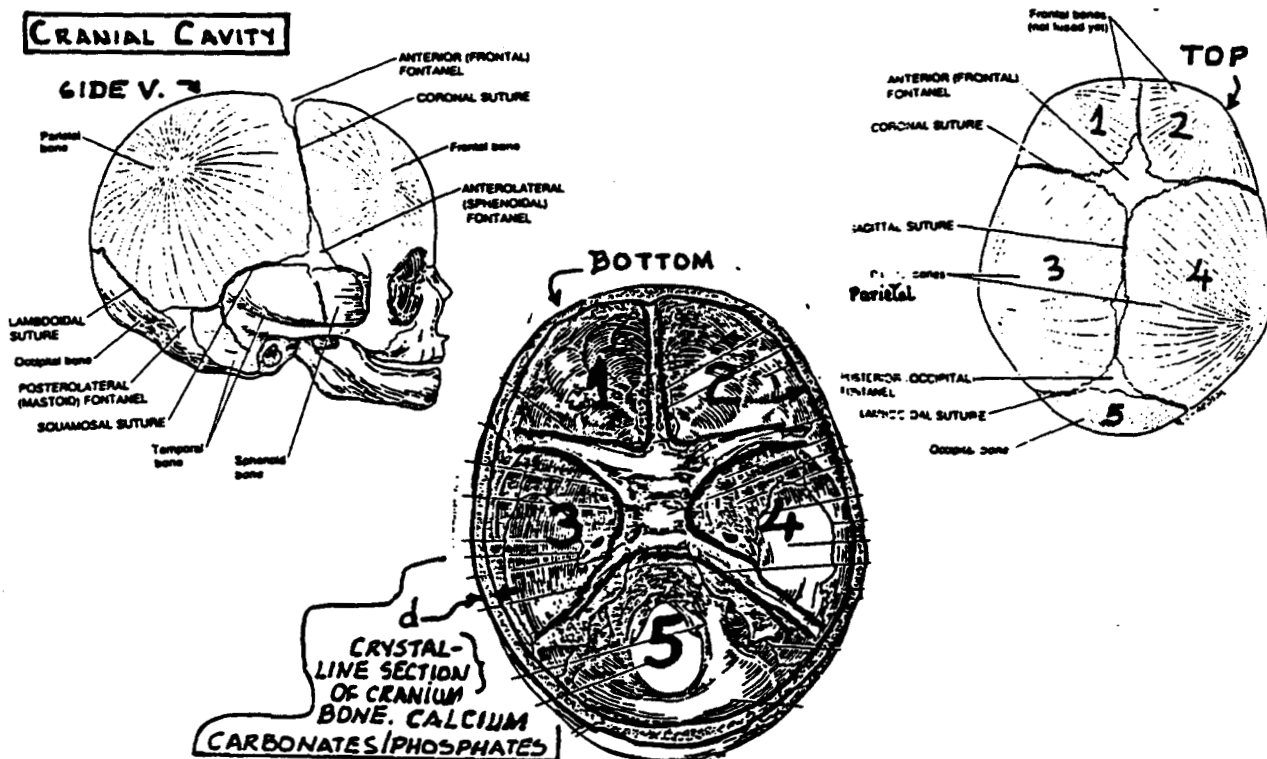

The actual process of transduction of Theta waves (0) involves the ionic crystalline structure of the calcium bone in the cranium. The ionic structure of calcium, in effect, forms a "phase space" which embodies a 12-dimensional tensor field between the electron shells. Incoming theta waves (0) are held in micro-unified fields within these crystalline

M A T R I X I I I

structures. Resonance is established and the theta waves come down into mass, where electrons are generated. An idea or impression then is registered in perception, the nature of which depends on the resonant Fourier translation of the incoming theta waves. Note well that the process of transduction is ENERGY --- ENERGY --- MASS.

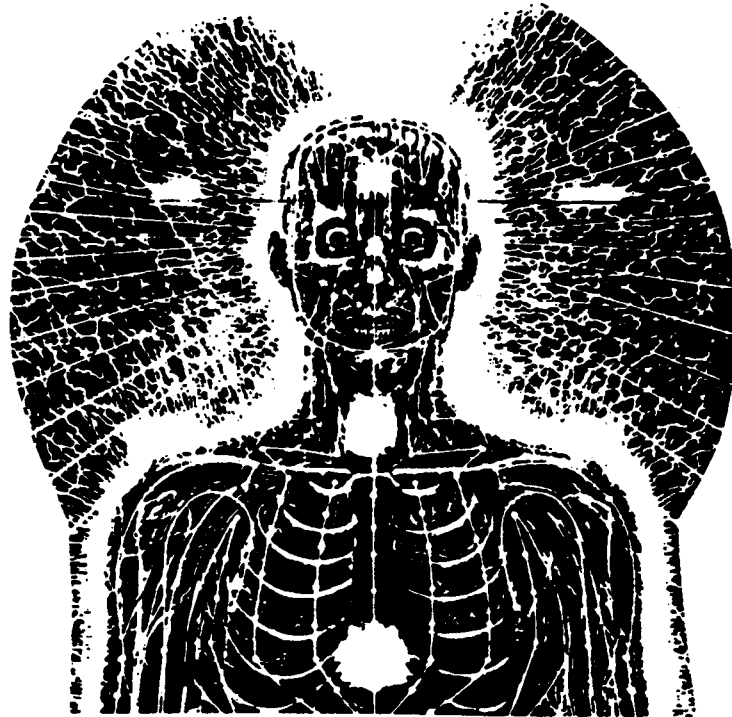
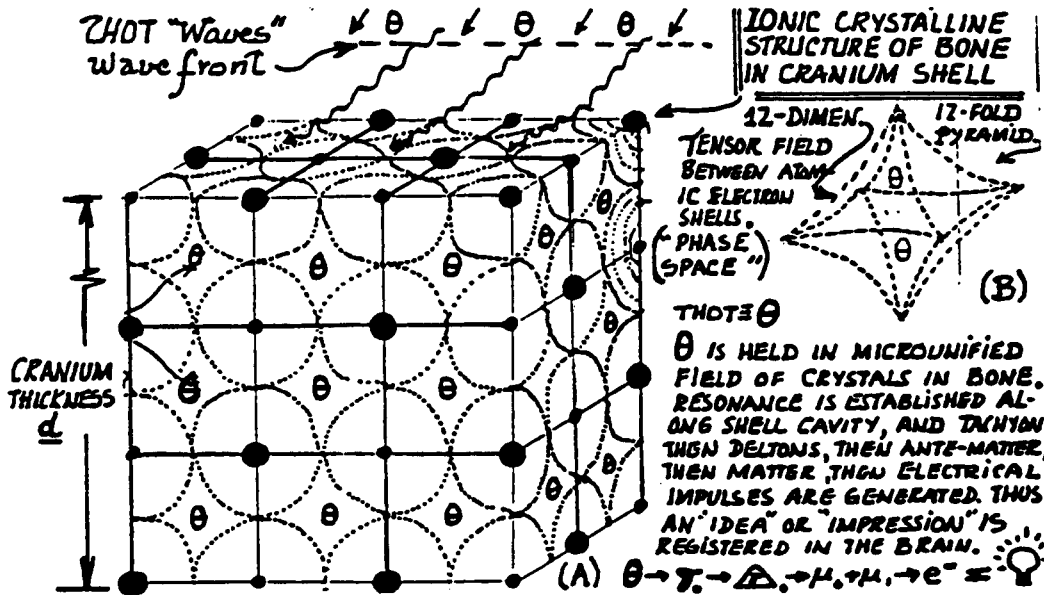

MATRIX III

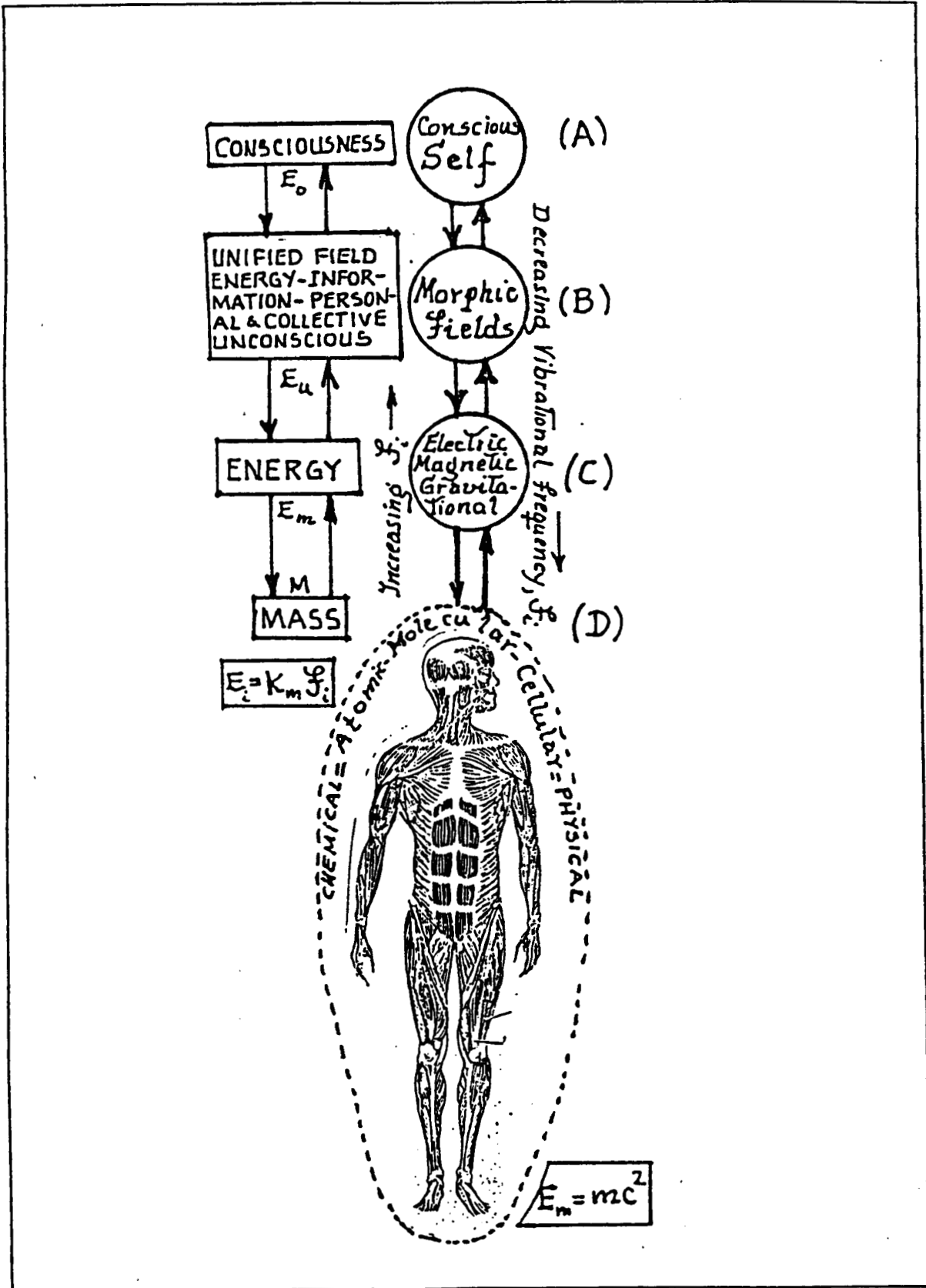

0350

EINSTEIN: Relativity S.T.C.

Unified Field Theory  
of All Forces & Energies  
in the Universe.

OBSERVER-DEPENDENT RELATIVITY OF SPACE-TIME. IN A CONTINUUM, EXPERIENCED BY THE OBSERVER'S CONSCIOUSNESS IN THE NOW FRAME OF REFERENCE.

NON-LOCAL INFORMATION FIELD WITH SELF-ORGANISING FEED-BACK LOOPS. IMPLICATE ORDER OF ENFOLDED CONSCIOUSNESS NOW.

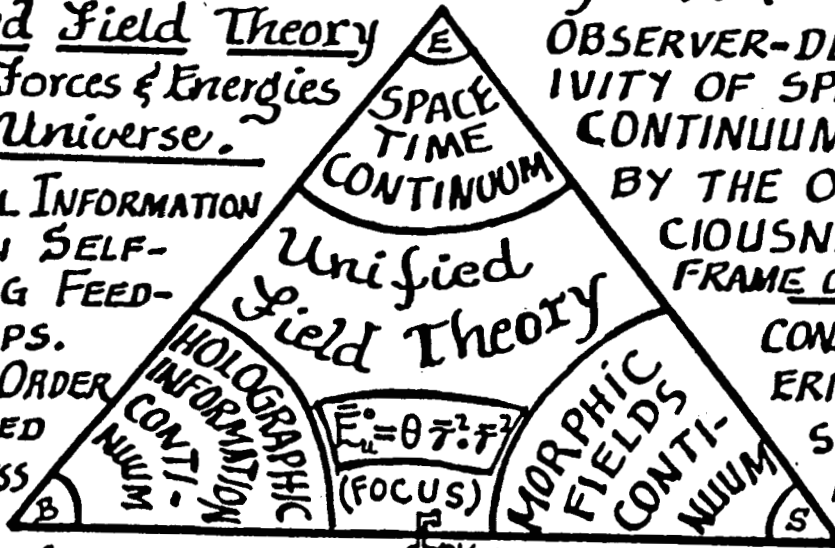

CONSCIOUSNESS & EXPERIENCES OF BIO-SYSTEMS PAST, PRESENT & FUTURE. NOW

BOHM: Holographic Info C.

SHELDRAKE: Morphic Fields C.

MATRIX III



Source Fields: Contrast Between HYPERSPACE & ULTRA-SPACE

**A. HYPERSPACE: Electro magnetic Technology - Ext. Hi-Power (Watts)**

- $T_{\mu\nu}$  = Energy Density of EM Field T.
- $\nabla^2$  = TIME DERIVATIVES OF METRIC TENSOR
- $S_{\mu\nu}$  = METRIC T. GRAVITATIONAL FIELD
- $T_{\mu}^{\nu}$  = ENERGY DENSITY OF  $T_{\mu\nu}$  (HERTZIAN RANGE)
- $I_{\mu\nu}^{\sigma}$  = GRAVITATIONAL FIELD INTENSIFY TENSOR (CONTRAVARIANT)

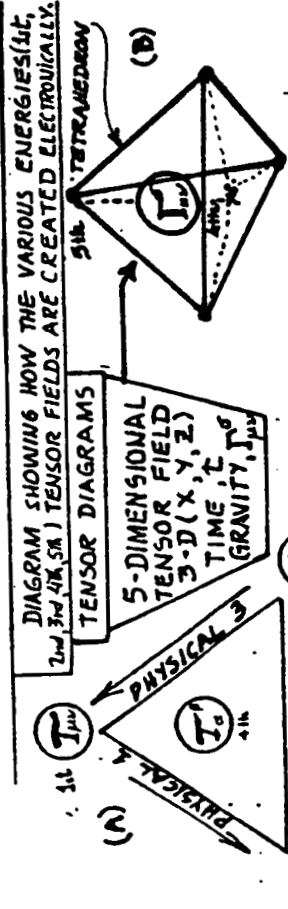

This Geometrical Configuration of Various Energies will distort SPACE TIME (STC)

**ULTRA-SPACE: Alchemy, Sacred Geometry & CONSCIOUSNESS - Very Low Power (Watts)**

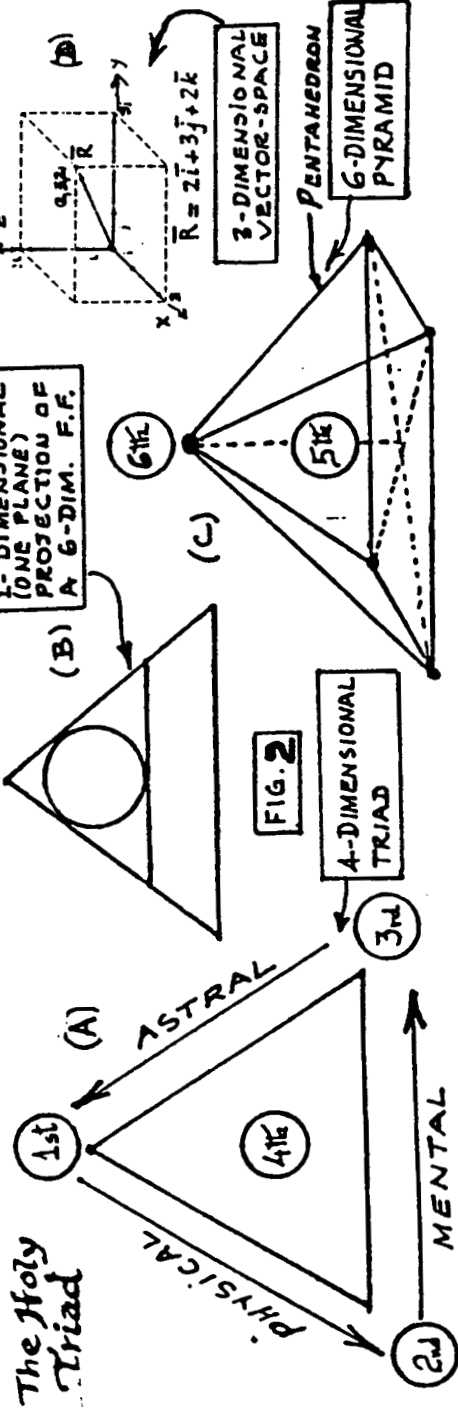

PHYSICS OF MICRO-PYRAMIDS & UNIFIED FIELD DEVICES' MICRO-ERB'S

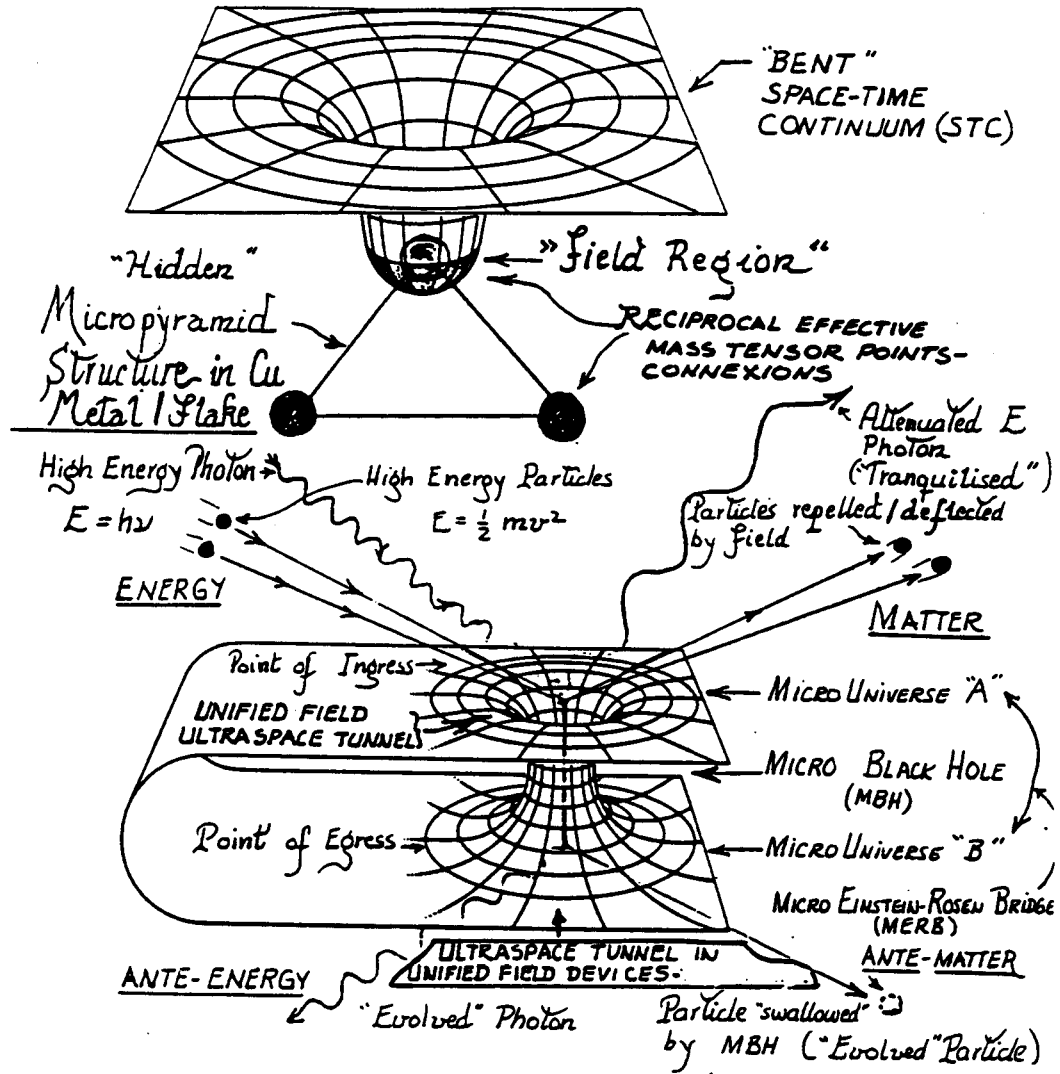

M A T R I X I I I

Advanced Applications in the Spectrum  
of Consciousness and Energy Frequencies

Energy "CPS"	Symbolic Particle	Equation of the Plane $O = 0$	Main Characteristics KU Absolute Nothingness Pure Thot + Darkness
Thought and Pure Consciousness 10	TACHYON $T_0$	$0 \Rightarrow$	Pure Consciousness LUX Info Continuum Primordial Intelligence
U N I F I E D	$10^{98} - 10^{144}$ DELTON $t_0$ 0	$E_u^0 = 0 \quad T^2 \times T^2$	Pure Energy - FLUX Unified Field Energy
F I E L D	$10^{68} - 10^{98}$ MUON $U_0$	$E_u^0 = u_0 c^2 \quad c^2$	-Pure ANTE-MATTER -Product of Conscious Focus on Energy
E L C T R O M A G N E T I C	$10^{30} - 10^{68}$ NUONS $v_0$	$E_2^0 = 0 \quad v_0$	- Morphic Fields - Energy and Forces Decoupled
E L E C T R O M A G N E T I C	$10^0 - 10^{30}$ PHOTONS ANTI-MATTER	$e \quad E = hv$	- Electric and Magnetic Polarities - Gravitational Field - Emotional/Astral
E L E C T R O M A G N E T I C	$10^{16} - 10^{30}$ IONS, PLASMONS	$E = hv$	- Plasma - Coagulation of Light via Gravity/Charge - Mental Plane
E L E C T R O M A G N E T I C	$10^0 - 10^{30}$ ATOMS $p^+, e^-, n^0$	$E = mc^2 \quad \text{MASS}$	-Crystallization of -Plasma. Gross Matter -Info Discontinuum -Bio/electric info

# Is there a cellular phone in your future?

Olympian news services

Cellular networks are planning a big increase in capacity - and you're one of the people they want to use it, says Kiplinger's Personal Finance Magazine. The industry's 10-year goal is a 50-50 split in usage among commercial and individual customers. It's now about 95 percent commercial.

Marketing plans include cheaper phone sets, customized billing schemes and advertising that stresses personal use: calling the police, summoning a tow truck, alerting anxious family members to traffic delays.

Analyst Martin Hyman, of Booz, Allen & Hamilton, expects the price of phone sets to keep falling. Already, a top-line pocket model from Fujitsu can be had for as little as \$900; a basic installed car phone goes for less than \$400.



**New Low Price!**

**Free Savings Bond!**

## MOTOROLA HANDHELD

**PORTABLE.** A tough, dependable cellular phone - with a hot new low price and a free \$50 U.S. Savings Bond to go with it! The MC750 has excellent battery performance, plus 27 memory locations, super speed dialing, 24-digit number entry, a bold LED display, electronic lock, and much more! MC750.

Was \$299.97	<b>\$199.97</b>	\$15 Per Month*
--------------	-----------------	-----------------



The Olympian  
Wednesday, December 4, 1991

## AROUND WASHINGTON

**McCAW, ORACLE SIGN PACT:** McCaw Cellular Communications Inc. and Oracle Corp. have signed agreements to jointly develop and test a new method of high-speed electronic data transmission over cellular telephone systems.

The companies said the technology should allow cheaper and faster data transmission than using telephone lines and computer modems. It would allow transmission speeds to approach those of expensive satellite links and high-speed leased phone lines, they said. The service could be used by both businesses and individuals, to distribute such things as news, stock quotes, fax and electronic mail, the companies said.

## Doctor Says Voice on TV Caused Seizures

By The Associated Press

A neurologist reports in a medical journal that a woman got epileptic seizures by hearing the voice of Mary Hart, a host of the syndicated television program "Entertainment Tonight."

Symptoms included an upset stomach, a sense of pressure in her head and mental confusion, said Dr. Venkat Ramani, who reports the case in today's issue of The New England Journal of Medicine.

"It was very dramatic," said Dr. Ramani, who said he studied the seizures when the woman heard Ms. Hart's voice in a laboratory test. The doctor said she would rub her stomach, hold her head "and then she would look confused and far away, the expression in her eyes, she looked like she was far away and out of it."

The test confirmed that Ms. Hart's voice set off the abnormal electrical discharges in the brain that mark an epileptic seizure, said Dr. Ramani, a

professor of neurology at the Albany Medical College.

In an interview, he said he did not know why Ms. Hart's voice touched off the seizures, which lasted 30 seconds to a minute or two. "I don't think it's psychological," he said. "Primarily it's a neurological, or brain-related event."

The unidentified woman had thought Ms. Hart's voice set off her seizures, but "even her own family members were skeptical," Dr. Ramani said. With the laboratory confirmation, "she was very relieved," he said.

She has not had any major seizures since she stopped watching the television show.

Dr. Marc Dichter of the University of Pennsylvania Medical School, an expert on epilepsy, said of the seizures, "It's the pitch and quality of the voice as a sound, rather than likely what she's actually saying."

## Field effects: No membrane needed

Pulsed magnetic fields can speed up protein synthesis even in cells stripped of their outer membranes, report biophysicists who demonstrated this effect with bacteria. The finding challenges the theory that the purported health risks of electromagnetic fields arise from changes in those membranes.

The researchers, led by Ben Greenebaum at the University of Wisconsin-Parkside in Kenosha, exposed membrane-lacking bacteria to a 10-gauss pulsed magnetic field for one hour. The stripped bacteria synthesized 22 to 55 percent more of a certain enzyme than did similar bacteria not exposed to the field.

"This is the first report of an *in vitro* electromagnetic field effect in the absence of an intact membrane," says Greenebaum. "It means that the models that depend on an intact membrane are incomplete."

Martin Blank, a biophysicist at Columbia University in New York City, calls the finding "intriguing." Blank is among those who propose that electromagnetic fields disrupt cell activity by perturbing molecules in cell membranes, potentially leading to cancer or other health problems.

NY TIMES 7/11/91

## Motorola System To Be Employed By U S West Unit

3-23-92

By MARY LU CARNEVALE

Staff Reporter of THE WALL STREET JOURNAL  
ENGLEWOOD, Colo.—U S West Inc.'s cellular subsidiary announced plans to use Motorola Inc.'s hybrid analog and digital technology to upgrade its operations.

Plans call for replacing U S West's cellular systems in Seattle, Minneapolis and Denver with Motorola's narrow-band Advanced Mobile Phone Service equipment. John DeFeo, president of U S West NewVector, the cellular unit, said the Motorola system will be a bridge to a full digital technology that ultimately will provide more calling capacity. That digital technology isn't ready yet for deployment.

The switch to the interim technology will begin this fall. U S West NewVector, based in Bellevue, Wash., and Motorola said they formed a 10-year alliance, but financial terms weren't disclosed. As part of the alliance, NewVector and Motorola have also agreed to cooperate in evaluating new wireless communications products.

The Motorola technology triples cellular call capacity, improves the quality of analog voice transmission and provides digital signaling. The companies plan to install new equipment in 328 cell sites as well as eight new switches in systems throughout Washington, Oregon, Colorado and Minnesota.

U S West and Motorola, based in Schaumburg, Ill., said the upgraded system allows customers to use their cellular phones like pagers, alerting them when new voice mail is received or providing a short text message or a call-back number.

The agreement marks Motorola's first major U.S. sale of the advanced analog technology, which the company has been marketing for some time as a step toward all-digital systems. The advanced analog technology gives cellular system operators more time to decide which digital technology to embrace.

The industry's trade association has supported a digital technology called Time Division Multiple Access, or TDMA. The other approach, Code Division Multiple Access, or CDMA, promises to offer far more capacity, but the technology is still being developed and standards have yet to be set. Already, McCaw Cellular Communications Corp. and Southwestern Bell Corp.'s cellular unit have announced plans to deploy TDMA, which expands calling capacity and provides clearer voice transmissions and greater security. Motorola is counting on competition to force cellular operators who want to wait for CDMA technology to upgrade their systems with its interim analog technology.

Mr. DeFeo said he believes the Motorola technology "offers customers much better quality of service in the next couple of years" until further progress is made on digital technologies. At this point, he said, "we believe CDMA is superior, and not moving expeditiously to CDMA is foolish." For customers, a big advantage is that they won't have to change their phones, he said.

## McCaw to Alter Phone Network For Computers

3-23-92

By G. PASCAL ZACHARY

Staff Reporter of THE WALL STREET JOURNAL  
McCaw Cellular Communications Inc. is expected to announce on Thursday that it plans to retrofit its telephone network so it can carry computerized data more efficiently, industry observers said.

International Business Machines Corp. is expected to assist McCaw in the venture, said people familiar with the deal.

McCaw, the largest cellular carrier in the U.S., long has sought a means to offer users of portable computers a way to transmit data among themselves and to their home bases. The company's existing cellular network is poorly equipped to handle data, which requires degrees of precision that voice doesn't require.

Details of the deal, which will involve other cellular telephone companies, weren't available. Executives at McCaw and IBM confirmed that an announcement was planned, but declined to comment on the subject.

But observers said the move by IBM and McCaw is the latest sign that interest in mobile data networks is growing, fueled by the proliferation of notebook computers and the promise of even smaller electronic devices called personal communications.

"It's getting the attention of all the big guys," said Eric Arnum, editor of Electronic Mail & Microsystems, a New York newsletter.

So far, companies have tried to tap demand for mobile data by forming dedicated radio networks, which don't carry voice at all and rely on land-based receiving stations. Motorola Inc. and IBM have launched one such network called Ardis, while RAM Mobile Data, a closely held New York concern, is backing another network with financial help from BellSouth Corp., of Atlanta, and technical support from L.M. Ericsson Telefonaktiebolaget of Sweden and General Electric Co. of Fairfield, Conn.

Cellular companies such as McCaw have been so busy satisfying demand from mobile telephone customers that they've only lately turned their attention to transmitting data, which they view as a potential way of increasing revenue. But cellular networks, which must switch a call among circuits in order to accommodate travelers, are based on a different approach than data networks, which send data in bursts all at once.

Rivals say McCaw and other cellular carriers won't find it easy to mesh voice and data techniques and that the formation of a national network could be frustrated by the inability of diverse cellular carriers to adopt a single data standard.

"Enthusiasm for data among cellular companies is fueled in part by a lack of understanding about how difficult the task is," said Carl Aron, chief executive officer of RAM Mobile. "I don't see the cellular companies having an advantage in an area where they have no experience."

# MCA May Offer A New Reality At the Movies

4-16-92

By G. PASCAL ZACHARY

Staff Reporter of THE WALL STREET JOURNAL

MCA Inc. may soon plot a course to make moviegoing a whole new experience.

The company is nearing a decision on whether to open experimental theaters in Los Angeles and Tokyo that would present a new type of motion picture using an audience-participation technique called artificial reality.

Instead of viewing the movie on a big screen, the audience would wear goggles and earphones to create the sensation of moving through space and lightweight gloves that would allow each person to make things happen in the collective fantasy world.

MCA, which owns a Hollywood studio, amusement parks and music labels, is relying for technical help on VPL Research Inc., Redwood City, Calif., considered a leader in the move to commercialize artificial reality. People involved in the project say MCA, a unit of Matsushita Electric Industrial Co., may decide as early as this month to test the new moviegoing concept. They add that the first two theaters could open next year.

MCA officials won't comment specifically, but James Fiedler, president of the company's technology division, says, "We have something that is revolutionary in the entertainment industry."

Sprint Corp. 4-16-92

## Firm to Build and Operate A Data Network for Russia

Sprint Corp., Kansas City, Mo., said it will build and operate Russia's first nationwide public data network through its Moscow-based joint venture, Sprint Networks.

The telecommunications company said the data network will provide high-speed local data communications links between most major Russian cities and, through connection with the SprintNet global data network, with businesses and organizations world-wide.

Sprint Networks will deploy and operate the network through RosTel, a new organization formed by Central Telegraph of the Russian Ministry of Communications and composed of regional telegraph and communications administrations.

Sprint said credit-card verification services for retailers and a service that allows users to send broadcast or point-to-point fax transmissions domestically and world-wide will be offered on the network.

NON-HERTZIAN SCALAR ENERGY AND ELECTROMAGNETIC ENERGY:  
THE BIOLOGICAL CONNECTION

by

Glen Rein, Ph.D.

ABSTRACT

This article will briefly review the evidence for a biological role for non-Hertzian fields and present recent experimental evidence (obtained by the author and other non-orthodox scientists) to support the hypothesis that they are a likely component of the bio-energy body and are involved with the body's own intrinsic healing mechanisms. The crystalline transduction theory is presented as a new theory to explain how exogenous non-Hertzian fields are utilized by the body to bring about profound changes at the cellular level resulting in facilitation of the healing process. In addition, the Information Matrix Theory is discussed as a mechanism to explain the interaction with non-Hertzian fields with the atomic nucleus. These theories are based on contemporary scientific research from quantum electrodynamics, quantum chromodynamics and bioelectromagnetics. This multidisciplinary approach may form the basis for a new branch of science referred to as quantum biology.

NON-HERTZIAN FIELDS

The umbrella term non-Hertzian will be utilized here to reference a type of subtle energy which for the last ninety years has been reported in the literature as radiant energy (Moray), morphogenic fields, empty fields, motional fields (Hooper), time reversed waves, longitudinal standing waves and "scalar" waves. Other terms like chi, healing energy, bioplasma and orgone energy refer to energy which may also be non-Hertzian or a mixture of subtle and classical fields. The term non-Hertzian will be used here to refer to this subtle energy in order to distinguish it from the classical electromagnetic (EM) fields described by Hertz and Maxwell and from quantum potential fields described in modern quantum electrodynamics. Einstein used the term "subtle" to refer to energy which could not be measured by ordinary detectors. Eccles uses the term to define the probabilistic analysis of quantum mechanical events in the brain. Bohm uses the term to characterize layers in the infolded order.

Unlike EM fields and quantum fields, non-Hertzian fields cannot be measured by conventional electronic equipment. It is proposed that biological systems are sensitive to non-Hertzian energy and

therefore may be used as "bio-detectors". Although such energy has not been measured in the body and is not being considered by the bio-medical community (they barely recognize a functional role for conventional EM fields), it is likely to be involved in biological processes since quantum mechanical analyses of biological systems has recently indicated their inherent nonlinearity.

Classical electromagnetic field theory developed by Maxwell, Faraday and Hertz describes the interaction of EM energy with matter in terms of forces acting on elementary particles (electrons, protons and neutrons).

The realization that accurate description of our three dimensional (3D) universe requires the introduction of quantum mechanics as well as classical EM field theory. Experimentally observed anomalies, including the EPR paradox and the Calcutta paradox are best explained by quantum mechanics. Key concepts in quantum mechanics include unbroken wholeness, non-locality, coordinated organization, information in form, higher dimensions of reality, independence of space and time and a unified quantum field underlying all forces acting on matter.

Bohm's theory of implicate orders infolded within our 3D explicate reality forms the basis for understanding the relationship between non-Hertzian fields and classical EM fields. Bohm's theory introduces the quantum potential as a ubiquitous pool of information which coordinates higher degrees of organization of a system whose distinct parts can communicate non-locally. The importance of quantum potentials and their associated quantum fields in our macroscopic 3D universe was experimentally demonstrated by generating quantum fields in the absence of classical EM fields and showing their ability to alter the wave function of electrons. These results indicate that quantum potentials are independent of classical EM fields and that they do not obey the laws of classical EM field theory. Bohm's idea that potentials underlie fields is supported by the mathematical demonstration that electric and magnetic fields are derivatives of the magnetic vector potential and the electrostatic scalar potential.

It is proposed here that non-Hertzian fields are fundamental unified fields which underlie quantum potential fields. This fundamental energy, which cannot be measured by conventional EM field detectors, is referred to as non-Hertzian because it does not obey the laws of classical electromagnetic field theory as first outlined by Maxwell and Hertz. It is proposed that quantum potential fields are mathematical derivatives of this fundamental subtle energy, analogous to the fact that conventional EM fields are derivatives of potential fields. It is possible that non-Hertzian fields regulate the hidden variables which control the seemingly random event of quantum mechanics. The properties of non-Hertzian fields will be discussed from the perspective of modern quantum electrodynamics.



Bearden has a slightly different interpretation of the relationship between potential fields and non-Hertzian fields, or scalar waves. Bearden has proposed the existence of artificial potentials in contrast to Bohm's unstructured natural potentials. According to Bearden, both the natural and artificial potentials are composed of virtual particles, although only the latter is organized into a substructure. This organized structure can be intentionally imposed on an artificial potential experimentally using scalar electromagnetics. Scalar electromagnetics is based on the presence of a scalar term in the original quarternion equations Maxwell used to describe electromagnetic fields. According to the theory, a scalar wave is generated by oscillations in the contraction and relaxation of stationary electrons. Scalar waves are proposed to contain conventional EM waves moving in positive time and contain positive energy as well as a superimposed negative time/negative energy time wave. This positive energy wave interacts with negatively charged electrons whereas negative energy waves interact with the positively charged protons in the nucleus.

Scalar waves are believed to propagate/translate only if the overall symmetry of a system is broken. Breaking of symmetry is associated with local curvature of space/time and the conversion of virtual particles into observable elementary particles. Negative time, negative energy and negative entropy are all associated with breaking symmetry and the generation of scalar waves. In addition, scalar waves have other unusual properties, including propagation at supraluminal velocities without loss of energy, independence of the  $1/r^2$  fall off, convergence, anti-gravity and the ability to carry information.

Bearden further proposed that the two types of energy waves can be separated by canceling two EM vectors 180 degrees out of phase. Mathematically, crossing two quarternion equations results in cancellation of the vector components with the scalar terms remaining intact. Experimentally this can be done with a caduceus coil or with a Hooper coil. In both cases a zero sum vector space is generated. According to Bearden, artificial potentials would be generated in this way.

The proposal that potentials are composed of virtual particles is based on the idea that the vacuum (or spacetime) is not empty but is also composed of a chaotic distribution of virtual particles. The notion of an energy which exists in a vacuum in the absence of motion, e.g. at zero degrees, suggested that the vacuum is not empty. In fact, the term empty wave has been suggested to describe this energy. A basic tenet of general relativity, according to Einstein, is that local curvature of spacetime (addition of time to the 3D universe) is not possible. Spacetime has been mathematically modeled as a vacuum where the virtual particle fluxes are constant and an equilibrium exists between particles and anti-particles. It is proposed that the local

curvature of spacetime is possible and would result in changes in the magnitude of the vacuum potential. These oscillations in the virtual energy of the vacuum could therefore account for the zero-point energy (ZPE). It has been proposed that higher dimensions are contained within the vacuum. These hyperdimensions of the vacuum are believed to be the source of the ZPE. Thus, under certain situations, the random, incoherent ZPE can be "brought down" into our 3D universe and made coherent. The concept of higher dimensions is well established in quantum electrodynamics and has recently been elaborated upon in Everett's "Many Worlds Interpretation of Quantum Mechanics" which proposes that hyperspace is composed of an infinite number of dimensions.

An elegant description of how the ZPE can be cohered has been presented in the Virtual Plasma Model (King) which explains how the ZPE can manifest (cohere) in our 3D space. According to this model, the ZPE normally passes through our 3D space randomly and therefore does not interact with it. However, in certain situations, the ZPE flux can be slightly twisted (or orthorotated) into our 3D space, thereby generating virtual particles which in turn generate elementary particles. Virtual particles can also generate a virtual plasma, which, according to the theory, can interact non-linearly with the ZPE. In this way a small amount of the infinite ZPE can be tapped or made coherent and used to provide enough energy to form the macroscopic meta-stable objects in our 3D space. Thus, the theory predicts that the ZPE can be tapped and used to generate coherent, structured macroscopic phenomenon in our 3D space. Although the theory contradicts the third law of thermodynamics, it does offer an explanation for experimentally observed vortex rings in plasma physics and the anomalies associated with "free energy" devices.

King's model provides an elegant explanation of the scalar wave in terms of quantum mechanics. According to King, scalar waves propagate in hyperspace and are guided by vortex rings. Under the proper conditions, the ZPE can be orthorotated into our 3D space and manifest as a scalar wave with no net energy propagating in our 3D universe. By confining the propagation of the scalar wave to the higher dimensions, gauge theory invariance is not contradicted. This also explains our inability to directly measure scalar waves.

The possibility that non-Hertzian fields preferentially interact with the nucleus would make them unique in comparison with EM vectors, which preferentially effect electrons. The interaction between non-Hertzian fields and electrons has been described as incoherent and diffuse, whereas nuclear interactions are believed to be coherent, resulting in a "charging" of the nucleus by exciting it's protons (Bearden, Puharich). By acting as a capacitor, the nucleus may be chargeable and dischargeable, thereby accumulating non-Hertzian fields. This theory further suggests that the addition of positive energy to the nucleus would increase the mass of the atom, whereas negative energy

would decrease the mass (Bearden). Such nuclear interactions are predicted to result in the emission of virtual particles (Bearden) possibly originating from quarks contained within each proton (Puharich). Virtual particles were first described by Dirac, who postulated the existence of a virtual particle "sea" from which elementary particles and anti-particles emerge. These ideas suggest that protons from nuclei in different molecules can transfer information to each other via long-range, macroscopic, quantum communication channels. This type of non-Hertzian interaction between nuclei in all atoms and molecules would not be confined to the standard limitations of electromagnetic forces, thereby explaining some of the paradoxes in modern quantum physics.

The idea of long-range communication channels between nuclei has been extended by the author and presented as the *Intramolecular Matrix Theory*. The theory proposes that communication exists between nucleons (protons and neutrons) within a nucleus, as well as between nuclei within the same molecule. The local forces within the nucleus are mediated by the ZPE, as dictated in quantum electrodynamics, whereas medium-range channels are postulated to exist between nuclei with a molecule. It is further proposed that the crossing channels within the nucleus and within the atomic structure of each molecule form a complex quantum information network (or matrix). The information which characterizes the unique physical and chemical properties associated with a given molecule is believed to be stored at the intersection points between communication channels. Finally, the theory predicts that the information matrix can be stimulated (INSTEAD OF SIMULATED?) using the appropriate frequencies of exogenous non-Hertzian fields. These fields would therefore carry the quantum information associated with a given molecule's matrix. As we shall see later in this report, the theory is supported by direct experimental data.

#### GENERATING NON-HERTZIAN FIELDS

Although non-Hertzian energy cannot be directly measured, several devices have been built which theoretically generate non-Hertzian waves. Most of these devices generate non-Hertzian waves by interacting (bucking) two equal EM fields 180 degrees opposed, to cancel the EM vectors. In psychotronics, this is achieved with a caduceus coil or a Hooper coil. In non-linear optics it is achieved using four-wave mixing. In this technique an EM field (E3) is introduced into a vector canceled space (vectors E1 and E2 are 180 degrees opposed and equal in magnitude), thereby generating a non-Hertzian wave (E4) with a much greater amplitude than the E3 input vector field. This approach allows for amplification of non-Hertzian waves. Another technique in non-linear optics is phase conjugation. Here EM fields are reflected off a non-linear mirror, thereby generating a non-Hertzian wave which is referred to as a phase conjugate replica of the original EM vector. The replica travels backward in time

and retraces the path taken by the original EM vector. This technic was first used by Raymond Rife in the 1930's, when he built his high powered microscope. The microscope utilized the convergence property of phase-conjugate waves, thereby minimizing distortion normally associated with diverging EM vectors.

Non-linear interactions in plasma physics can also be used to generate non-Hertzian waves. The complex non-linear interactions among the different types of plasma waves within a plasma structure has been well described in plasma theory. Abruptly pulsing a plasma will theoretically generate non-Hertzian waves. Propagation of non-Hertzian emissions from plasma tubes has been described in terms of a self-focusing mechanism. Such emissions are the basis of the cancer curing machine of Priore and the beam ray generator of Raymond Rife.

SBT  
[ Finally, the emerging field of psychotronics uses radionics and free-energy devices which may generate non-Hertzian fields. With the use of hyperspatial engineering, psychotronic devices have been built by modifying audio amplifiers and doping crystal lattices in transistors. Although these electrical circuits do not follow the principals of traditional engineering, they exhibit properties consistent with the emission of non-Hertzian waves.

The devices described above should theoretically generate non-Hertzian fields. Support for this conclusion is based on the numerous reportings of anomalous behavior associated with these devices in regard to temperature, inertia, gravity or mass measurements. Such anomalies were first observed by Tesla as ball lightning during his Colorado Springs experiments with his magnifying coil. These anomalies are likely to be explained by the theoretical quantum physics just described. Since some psychotronics devices have been used with biological systems and biological systems have been recently modeled using quantum mechanics, anomalous biological behavior may also be expected from these devices. Such biological implications have received little attention.

#### BIOLOGICAL SIGNIFICANCE

Evidence exists which suggests that these non-Hertzian fields will affect biological systems and may be involved in the natural healing process. It has therefore been suggested that quantum mechanical events mediated by non-Hertzian fields may link chemical and EM events in biological systems. Furthermore, theories suggest how subatomic quantum events can influence macroscopic processes in biological systems. However, the exact role and mechanism of action of quantum non-Hertzian fields in biology will require further experimentation.

DelGuidice has mathematically characterized the quantum mechanical propagation of EM fields in structured water and

referred to such propagation as non-Maxwellian. His studies clearly support a role for non-Hertzian phenomenon in biological systems and indicates a key role for water. The physiological role of structured water surrounding biomolecules and at the surface of the plasma membrane has received some attention from the scientific community. Using proton Nuclear Magnetic Resonance (NMR), this "interfacial" water has been shown to be more structured and organized than bulk water, where decreased hydrogen bonding between individual water dipoles results in a more random orientation. A functional role for structured water is indicated by experiments where the hydrogen bonds are intentionally broken, causing a shift in the orientation (or the "order parameter") of the biomolecules (e.g. glycoproteins on the plasma membrane). Structured water in biological systems is characterized by altered electrical properties (e.g. dielectric constant and conductivity) and readily and reversibly converts to random bulk water. Thus structured water and bulk water are in equilibrium.

Although water is composed of hydrogen and oxygen ions, the hydrogen ion has been the focus of attention in terms of understanding the role of non-Hertzian ZPE. Puthoff considered the ground state of the hydrogen atom as a ZPE determined state and used quantum electrodynamics to calculate the amount of ZPE absorbed and emitted by hydrogen. Puharich also uses the hydrogen molecule in describing the subnuclear origin of scalar energy. As previously discussed, Puharich has proposed that scalar waves originate in the monopoles and anti-monopoles, which are located within the protons. Puharich has extended these ideas into the biological arena by proposing that non-Hertzian fields are emitted from the body during the laying-on-of hands healing and originate from the hydrogen bonds which hold DNA strands together.

Bearden has also extended his hypothesis to include biological systems. Bearden proposes that each cell in the body is composed of subatomic biopotentials. The biopotentials, which are located in the atomic nuclei, are composed of disordered, unstructured charge patterns of scalar energy which form virtual substructures. Scalar energy absorbed by the cells will charge and organize the biopotentials, unlike EM fields which only change the magnitude of the biopotentials. Cells which are in open exchange with their extracellular environment, also discharge their biopotentials by releasing structured scalar photons as well as conventional photons. The scalar photons released from diseased cells, which have a characteristic information pattern associated with the particular disease, can communicate the diseased energy pattern to all cells in the body. Bearden also proposes that all disease could be cured if we could isolate the diseased energy pattern, apply it to a phase conjugate mirror and generate its time reversed scalar wave. This scalar wave, which would contain the healing pattern for that particular disease, could then be used to treat the patient. A parallel approach would be to generate the scalar information

pattern from an antibody isolated from the diseased patient's blood. A scalar wave with this information would charge the immune system resulting in a permanent scalar immunization.

### BIOLOGICAL EVIDENCE

Although there are several theories for the role of non-Hertzian scalar energy in biological systems, there is relatively little direct experimental evidence. Several different approaches give indirect experimental evidence to support this hypothesis. One line of research focusses on the biological role of light (or biophotons). Popp discovered that biophotons are stored and released from within the helical structure of the DNA molecule and observed that biophotons are coherent in nature. Popp hypothesizes that the biophotons which he could measure originate from a holographic virtual EM field which permeates the whole body and is involved with the healing process. Although Popp's biophotons are coherent and originate from DNA, the proposed biological source of scalar waves, their non-Hertzian nature has yet to be proved. Coherence may be either quantum mechanical or non-quantum mechanical in nature.

Experimental data from scientific studies involving laying-on-of hands healing, remote viewing and remote influencing of random number generators may be interpreted as evidence that the body generates non-Hertzian fields. Independence of time and distance has been most convincingly demonstrated by John's extensive data with random number generators. Similar phenomenon have been observed with healers. Geller has apparently been able to redirect the growth of a sprouted kidney been back to its original unsprouted state: a possible biological example of time reversal. Manning was able to influence the adhesion of cultured tumor cells and could focus his intention to only one petri dish amidst a stack of four. This is an example of convergence. These phenomenon exhibit properties consistent with those outlined above for non-Hertzian waves.

As an alternative to using biological tissues as a source for quantum biological fields, a different approach would be to generate them artificially (as discussed above) and study their effects on biological systems. Although numerous studies indicate that weak EM fields have a wide variety of biological effects, similar experiments with non-Hertzian fields have not been considered by bioelectromagnetic researchers. In the 1920's and the 1930's several unorthodox EM field generators appeared which may have also generated non-Hertzian fields. For example, the plasma tube generator of Priore had profound biological activity on the inhibition of tumor growth in animals. More recently free energy devices, radionic devices and other psychotronics devices have been built which may also generate non-Hertzian waves. The ability of these devices to modify biological systems has generally not been studied scientifically. Although radionics and psychotronics devices like the Interro and

the SE-5 are effective "clinically", their circuitry does not follow conventional engineering principals, and the quantum physics described above cannot readily predict the nature of the subtle energy that they generate.

Several years ago, the Teslar shielding device was introduced which trapped EM fields inside a mobius strip and theoretically generated a non-Hertzian field between 7 and 8 Hz. A decrease in overall amplitude and shift toward lower frequencies in EEG recordings from individuals exposed to this device has been reported (Byrd). Following exposure to harmful environmental EM fields, EM-sensitive individuals wearing the shielding device showed normalized readings on E.A.V. electro-acupuncture and Interro diagnostic devices.

Despite these encouraging preliminary results, the belief of the individuals treated may also be a contributing factor. In order to eliminate placebo effects and to determine whether the presumed non-Hertzian fields emitted from the device might have direct effects at the cellular level, the author designed a series of in vitro experiments using nerve cells and immune cells grown in tissue culture. Biological effects were measured in the presence and absence of the mobius strip in order to determine the relative contributions of the EM and the non-Hertzian fields to the biological response. In the presence of the mobius strip both EM and non-Hertzian fields would be present, whereas removal of the mobius strip would generate only an EM field. Since it is unknown to what extent the two fields couple, this approach does not yield direct information about the effects of non-Hertzian fields in the absence of an EM field, presumably of the same frequency.

The PC12 neuronal cell line was chosen for initial studies since the author had previously shown that the functional properties of the neurotransmitters (e.g. norepinephrine) present in these cells resemble those in the normal brain. It was further demonstrated that norepinephrine release was increased and norepinephrine uptake was inhibited when the cells were exposed to weak EM fields. Norepinephrine uptake was reassessed, using the same standard biochemical protocol, following a thirty (30) minute exposure of the cells to the two shielding devices. Results from six independent experiments indicated that both devices caused a small inhibition of norepinephrine uptake. In the presence of the mobius strip and additional 20% effect was observed. The results therefore indicated for the first time that non-Hertzian fields can have even more profound biological effects than conventional EM fields.

Since the immune system is a key focal point for healing a wide variety of diseases, additional experiments were done to determine whether non-Hertzian fields could stimulate the growth of T-cells or lymphocytes (critical white blood cells involved with cellular immunity). Using standard biochemical techniques, lymphocytes were isolated from the blood of healthy volunteers

and grown in a tissue culture for two days in the presence of radioactive thymidine. The rate of thymidine incorporation into replicating DNA is a quantitative measure of the amount of cell division. Both shielding devices increased the growth of the lymphocytes. As in the previous experiments with nerve cells, the addition of the non-Hertzian field increased the biological response, in this case by an additional 76%.

These initial studies were the first to demonstrate a direct effect of non-Hertzian fields at the cellular level and indicated that such effects could occur in the absence of placebo effects. An additional direct effect of the shielding device on stimulating the RAD-6 gene was subsequently reported (Puharich). This gene codes for protein involved in DNA repair in response to harmful UV radiation. The shielding device may therefore activate repair mechanisms following exposure to harmful EM radiation.

The inability to adjust the output frequencies and amplitudes of the shielding device is a severe limitation for further research. Therefore, in collaboration with T. Gagnon, the author conducted a more extensive study using a modified caduceus coil which Gagnon had developed to treat cancer. The delivery system, referred to *Structured-Electromagnetic Quotient Stimuli (S-EMQS)*, consists of two concentric windings within a coil carrying current in opposite (anti-parallel) directions. The input current (3 mA) consists of a series of S-EMQS envelopes repeated at 5  $\mu$ sec intervals. Each envelope is composed of 3-7 superimposed, computer generated, square waves varying in frequency from 2 kHz to 6 kHz. Freshly isolated human lymphocytes received four 15 minute treatments during a 12 hour period and their growth rate was determined as described above after an additional 12 hours. Control cells (those not subject to the energy treatments) exhibited low growth rates (358 cpm/ $10^5$  cells). S-EMQS generated non-Hertzian fields caused a 20-fold stimulation of cell growth (6880 cpm/ $10^5$  cells) in the absence of chemical growth factors. EM fields are also known to stimulate lymphocyte growth, although the magnitude of this response is typically less than 1-fold. It was therefore of interest to determine whether the large effect observed here was due to the non-Hertzian fields or to the specific and complex set of frequencies used. The exact same frequency information was used as input to a second coil with the same dimensions as the first except that current flow in the two windings was parallel (i.e. in the same direction). This coil arrangement, which would only generate transverse EM fields, gave a 3-fold lower biological effect. These results support the previous experiments with the Teslar shielding device and indicate that the pronounced biological effect observed here was only partially due to the frequency information, and more largely due to the way in which the information was delivered - via a non-Hertzian field.

Utilizing a slightly larger input current (9 mA), we determined



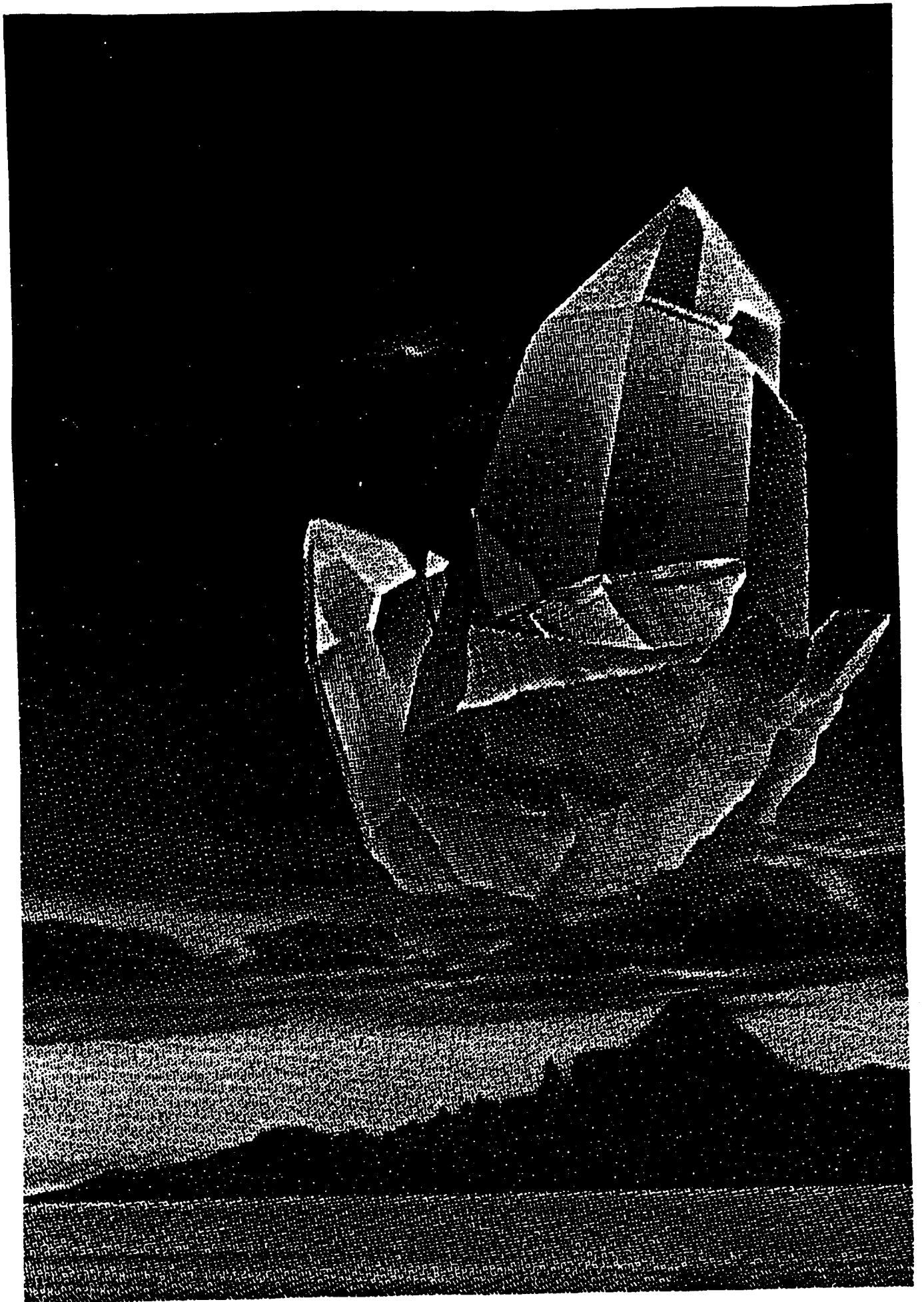

whether it was possible to transfer and store this frequency information into the lattice structure of water. Water charged with the non-Hertzian fields was then tested for biological activity. Using a modified S-EMQS signal (which turned out to be less biologically active than the original signal), direct exposure of the cells to the coil stimulated cell growth by 87% (relative to the control group), whereas the charged water caused a 61% stimulation. Although a detailed study to determine how long the water would hold its charge was not completed, preliminary results indicated that the non-Hertzian frequency information remained in the water for at least three weeks. We were further able to demonstrate that the information pattern in the water could be reconstructed by subsequent exposure to a different non-Hertzian field. A second set of S-EMQS signals which were designed to inhibit lymphocyte growth were then superimposed onto the original pattern that had enhanced cell growth, thereby canceling the original stimulatory information pattern.

These results indicate that unlike conventional EM fields, which possess a limited capacity to structure and transfer their energy to water, non-Hertzian fields can store their frequency information in the lattice structure of water. The results further indicate that this frequency information can then be liberated from the water assumedly unchanged and cause the same biological effect as the original non-Hertzian field. These findings offer direct experimental evidence in support of DelGuidice's theory of non-Maxwellian propagation in water without loss of energy. The data may also explain the anomalous behavior of homeopathic remedies which have the ability to store (for very long time periods) the energetic information matrix associated with a chemical or drug. The fact that the stored information in the water can have the opposite biological effect as the original chemical or drug may offer a physical explanation for homeopathy. These kinds of studies may be useful clinically to generate a set of frequencies which can override the information pattern associated with a disease and offer a novel approach for treating a wide variety of diseases.

In conclusion, the summary of the biological experiments presented in this article indicate

that non-Hertzian fields can produce profound direct effects on biological systems, independent of the belief of the individual,

that water is a key mediator in this response,

and that the nature of this interaction is quantitatively and qualitatively different from that occurring with conventional transverse EM fields.

If EM fields are just derivatives of non-Hertzian fields and the latter can interact with matter at the level of the nucleus (rather than the electron shell), non-Hertzian fields have a potential to affect biological systems at a very profound level indeed and should constitute a key role in the energy medicine of the future.

## Interview with Al Bialek

AB: Alfred Bialek  
SS: Sovereign Scribe  
TC: Tracy Cooper  
DG: Danielle Graham

SS: I have a basic question which might be a good starting off point. Could you give me a thumb-nail sketch of how you make a battleship disappear? I know it takes generators...now what do you do?

AB: A thumb-nail sketch is you have to distort the normal time field. In the case of what they were doing, they were rotating the time field in which the ship itself sat. If you rotate it at about 45 degrees it becomes invisible, if you rotate it 90 degrees it drops out of our reality and that's not what they wanted to do.

The basic technique, just in thumb-nail, is that you rotate the time field. Consequently radar signals will pass right through it like it doesn't exist. If you rotate it far enough, optically it doesn't exist. It would not be visible to the eye under normal observation.

SS: What is the time field?

AB: The time field is an extension of our physical reality. According to Einstein it is a physical dimension. In other words it's the fourth dimension.

SS: And can be moved?

AB: It can be manipulated, let's put it that way. It can be interfaced, it can be manipulated. You can do things with it. Consequently you do things with whatever is in that area of field that you're manipulating.

SS: Are you moving it with magnets?

Ab: You're moving it with electromagnetic fields and R.F. fields, however the means of modulation of those fields are such that it generates higher order fields. In other words, you're not going to affect the time fields with a plain, ordinary electromagnetic radiation.

SS: What's an R.F. field?

AB: Radio Frequency. The same thing as a radio of TV or whatever.

SS: So it takes a combination of the two.

AB: It takes the combination of magnetic fields and the R.F. field interacting in a certain manner and with additional equipment to produce higher order fields which will rotate the time field.

SS: If an object or a person is either brought forward or backward through a time tunnel, doesn't this create a "paradox" because of the object not belonging to that particular time?

AB: Yes, you do.

SS: Was that a problem?

AB: No it was not a problem, so far as I know. I can only speak about Montauk. They regularly sent people through the time tunnels and brought them back. They did send some objects through the time tunnels with no intention of bringing them back at that time. Sort of like storage at a distance. I understand from what Dr. Herman Entenman said, was that on some of those occasions they lost what they sent out because the tunnel collapsed due to failure of the equipment. So the tunnel collapses and disintegrates. Whatever is out there is just atoms lost in eternity, so to speak. But other than that, no, they had no problems in sending something out and later retrieving it, whether it was a person or an object.

The real problem came when you made deliberate attempts, which were done, to alter the past history and alter what happened to certain people. That had an inroad effect on me. Something was done involving an alien that was shipped backwards in time; roughly 100,000 years ago. And also to my brother, I'm not sure what the time period was--I would estimate from what he said, about 12,000 years ago, maybe less, wherein something from a more recent time was forced back upon him and changed his whole nature.

SS: Where did the writers of the movie *The Philadelphia Experiment* get their information?

AB: That is a very long and interesting story. I wondered about that myself and we assumed, for a period of time, that that information came in mostly as speculation on the part of the actual producer--I know who it is, but his name does not appear on the credits and he doesn't want his name known. But he asked Preston (Nichols) over a period of time from 1982 to 1983 a lot of questions about the Philadelphia Experiment, and Preston knew quite a bit about it, at that time, he finally admitted it, and answered this guy's 1001 questions, as it were. And this guy became the actual director of the film. We assumed that he expanded with his own speculation on this because some of it in there is not

M A T R I X I I I

true, but it was based largely on Preston's information and his own expansion on it.

Turns out that wasn't the case at all. We did a lecture in New York in 1989. Preston, Duncan and myself were invited to talk about the Phoenix Project and the Philadelphia Experiment, which we did. Officially it was not video taped, but it privately it was. A copy of this thing somehow wound up over in England and got to EMI Thorn and got to someone in archives.

Well, they came to New York and looked up Preston. They found Preston's address and came to his home one evening and said, "We've finally found you." Preston says, "What do you mean?" He says, "Well we've been looking for you for quite a while. You're the fourth man in the picture."

Preston says, "What picture are you talking about?" He showed him a photograph of a family portrait that was made in 1890 of the Thorn brothers of Thorn Industries. One of the backers of the organization was none other than Al- liester Crowley and this fourth person who was apparently a bit older. The fourth person was identical to Preston except he looked approximately 10 years older than Preston looked, say a year ago. And they knew that this fourth person was important and Crowley insisted at that time that this man was not of their time, meaning the time of 1890. He was out of the future, and this guy gave him the whole history of the boat experiment and it had been in the archives of EMI Thorn since 1890.

It was sometime in the 60's or 70's EMI Corporation and Thorn Industries merged and they decided to do a movie. The decision to start it was in 1983 and they came to the U.S. to do the filming. But they said that they had the actual record of the experiment in their archives since 1890.

SS: And you're saying Preston brought it back?

AB: Preston brought it back according to the statement made by Crowley at that time and according to the records in the archives.

SS: We'd like to clarify some things from the presentation. How old are you now?

AB: By my birth certificate 63. By adding the additional years when I was actually born I would be 73. In terms of real time not counting age regression I'd be 63 plus 30 which is 93 plus the time I spent on various secret government projects such as the Phoenix Project where they were doing the right brain / left brain split type thing, a sort of conjugate person- ality thing. They do this now to get you to work on two different projects at two identical times practically as two different people.

SS: So you've lived over 93 years in a 63 year old body?

AB: yes.

SS: Were you speculating that the Philadelphia Experiment was a set up by the aliens?

AB: It very definitely was a set up. Right now it is very definite. There was speculation a couple of months ago 'cause some of the pieces were just beginning to come into view. The whole thing was a setup.

SS: What tipped you off that it was an alien setup?

AB: Finally getting some data on Roosevelt's agreements, where he signed an agreement with the aliens in 1934. I started looking in on this and it started to make some kind of sense.

The Pleiadians were turned down in 1953 again when they insisted one of the points they required if they were to work out a deal with the U.S. Government was that they must scrap all their nuclear weapons. Well the U.S. government was just not ready to do that, not in 1953. So they were turned down politely and along came the greys and they made an agreement with them.

But again, back in 1933 was Roosevelt's agreement with the "K's" and because of that in 1934 the Pleiadians went over to Nazi Germany and worked something out with them. But there you had across the Atlantic two powers which were getting ready to fight each other. There was one E.T. group on one side of the Atlantic passing us technical information, it's going to be fairly obvious that it's very likely that there's going to be another one on the other side of the Atlantic feeding information to try and keep some kind of a balance, particularly one of them was concerned with the survival of a major segment of the human race.

I finally got confirmation from a number of people. The original confirmation, I understand there are hard copy notes on this, comes from Billy Meyers in Switzerland.

2 2

TC: What does  $E=MC^2$  light reciprocal mean?

AB: That would be C to the 4th. That does not have meaning other than that would rotate you into one of these hyper- spacial locations which is C to the 4th and you would be out of the Electromagnetic and you would pass into one of the etheric domains.

TC: Would it be accurate to say that when they made the Eldridge disappear what they do is just rotate it into another dimension?

AB: That's what happened but that's not what was intended. What was intended was to rotate the time field so that there would be no reflections of either light energy or electromag- netic energy which is essentially the same as a matter of the frequency.

TC: So they isolated the time dimension.

AB: Yes, and rotated it and that was all they were intending to do. But that of course is not all that happened.

TC: They ended up rotating the entire...

# M A T R I X I I I

AB: ...localized field around the ship.

TC How can you begin to understand that?

AB: Because I not only had all the physics training then but also the specialized training which came from Von Neumann because he understood it. At the time when you graduate from the standard physics course even at the best universities today, even a PhD, you don't really know what's going on because that's information that's withheld. An understanding comes later. All that is a basis for laying the groundwork for understanding. The real understanding of what's happening has to come from private tutoring. This is why the Illuminati has survived so long because there is a hard basis of knowledge there, as well as ability. But Von Neumann had figured it out, along with Hilbert, and his interface with Hilbert and perhaps Einstein and Levinson.

TC: What would you say to a person who had a physics background who wants to have a deeper understanding, how would they gain it?

AB: How? Hmm. You would have to study currently some of the literature and information put out by Tom Beardon, for one example. But you have to be careful also about Tom Beardon because he also puts out some disinformation. You have to filter it very carefully. He does put out some good information but every so often he puts a corkscrew in there, and that's particularly true in some of his reference to the weather control generated by the Russians. It's not. We have our own. And some of the other things, some of the other basic physics which refers to the bouncing electron in the atomic shell that's real for a period of time and then virtual for a period of time. Well that aspect's correct. But he says when it becomes virtual, it goes into a reverse time universe, then it falls into the anti-matter universe. Anti-matter universe is NOT reverse time. There is a reverse time universe and there's an anti-matter universe. So that is disinformation right there. And what he describes is partially correct, but not fully correct.

TC: So where else would you look for more information?

AB: Where else? I'd say look into some of Von Neuman's works. He has a list of 15 books and some of them are not at all relative to this. He does have some of the information and some of the works which definitely tie back to the theoretical approach which was made.

TC: But there's no way we can get ahold of the time equations, is that correct?

AB: Most likely, no. It is highly classified.

DG: Regarding the boat experiment, was it because they generated too much energy that it took them beyond their anticipated results or was there an alien manipulation that actually generated the field in such a way that they went beyond their expected results?

AB: No, just the rotation of the field itself would not create the problem. It was the fact that they locked up with another experiment which brought them far beyond the 6th level which they were capable of generating on the Eldridge. They had to be capable of generating 6 levels in order to get 5, and 5 is what they had to have in order to rotate the time fields. Uh, you lose one in there, so to speak. You manipulate from the highest level what is below, that's why they had to go to 6 to get manipulation of the 5th. But that of itself would not have done what happened. You have to have additional orders and you have to have other factors which cause the lock up.

DG: One of the things that's really interesting about this video that we've seen is you and your brother's unique approach to understanding time, since you have experienced time in a very non-linear fashion. When you've created a loop like the loop that was created between 1943 and 1983 with regards to locking up of the two different experiments, how does that loop ever break?

AB: It doesn't. It is there and it remains there but after a certain period of time it probably won't have any effect. When you get 20 years past 1983 it's not likely to have any problem at all anymore. You don't lose it, you don't remove it. It just doesn't have any effect anymore. It's already had its effect by the transit and when you come back.

DG: Does it disperse?

AB: No, it's just something that stays there and exists like a smoke trail in the sky. It's there and they slowly dissipate over a long period of time.

(Regarding the boat experiment,) Nothing was told to us about travel, only what we were doing in terms of that experiment. We had no expectation of anything like that happening. It was neither planned and wanted, or expected. It just plain happened.

I don't regret that aspect. The only thing I have sometimes thought about and question whether I have regrets about it is whether or not we might have all been better off if instead of letting Duncan go back to 1983, I'd held him there on the ship so he couldn't jump overboard the second time, until the ship returned to normal space/time. He wouldn't have been back through that experience and dead. Things would have been different. Whether or not they would have been better is a wild speculation, and strictly speculation. But it definitely would have been different. I was not in a position to really anticipate what he was going to do. He gave no warning he was going to do it. The movie says otherwise, but of course the movie has a lot of speculation in it that he planned to go back because of his girlfriend. Well there was no girlfriend in the other end, in fact, it was a disaster for him.

TC: What is your understanding of anti-matter?

AB: Oh, that comes out of Von Neumann. Von Neumann was very much aware of it. And there is a lot of work done on it now. Today we deal in speculation in physics about anti-matter. And, of course, there is discussion, both in the realm of science fiction and in physics about what you could do to create energy from a matter/anti-matter interface without creating an unbelievably powerful bomb which could be very, very disastrous. But there's a lot of speculation on that now as to the two universes, and if you got matter from one into the other what would happen? Can you control the reaction and how much energy could it create? That is speculative at the present time.

In addition to that, it's a little bit more than speculative because you have the aspects of the U.F.O. ships that have been turned over to our government out in Nevada. That has been discussed.

Bob Lazar has discussed the business of the element 115 and the fact that they use it to generate anti-matter and the anti-matter generator source and from that they amplify gravity waves and this is what they use for their drive system. Now there's no technology like this on earth. He says that there's no way we can replicate it. He said furthermore, there's no way we can come up with atomic element 115 in any quantities because it requires a totally different physical environment to produce it. Though he says our government has perhaps some 500 pounds of the stuff. And it is incredibly powerful.

He said he was hired because of what they called an "unscheduled nuclear event", in which a number of scientists were vaporized. They had to go out and hire replacements for them. And he got the word. He was at Los Alamos working as a physicist. He heard about this and went down and talked to EG and G and apparently he was accepted and then he was actually put on the Navy payroll, this is what he says, then he went to Los Alamos and eventually wound up working on the UFO's and UFO problems and related things.

His comment was that they don't have enough really qualified people. They don't understand what's going on. They don't really understand what's going on with this, and he says its also impossible to produce element 115 on Earth. This had to have been brought in. Yet they have this technology there. He says its definitely not built here. He says he can say that very flatly as a physicist. There's no way we can build this, not in this century. 50 years from now, who knows. Maybe 20 years from now.

(Regarding time tampering, its implications and free will:) ... Things could be manipulated in our future basis to alter the time line, as it were. Again to alter it on a major basis, it would be a minor thing for an individual. If it be a major basis it would affect the whole planet, depending on what effect it had.

Now free will still plays, then the (time) line shifts and the whole reality scenario changes, after it changes you still have free will but, I understand the basis of your question: is it sort of like a higher order reality coming down and hitting you over the head and after the stroke is over you go back to playing your little game of reality as you know it, or as I know it or anybody else knows it. It does raise some serious questions, yes. And how much free will do we really

have? In other words, who else...lets say, who else has more free will than us?

TC: Back to this time limit, they isolated the time field with the Eldridge, would you agree with Bearden that the time dimension is the connection with other dimensions, with the higher order dimensions?

AB: Yes, basically.

TC: How so?

AB: Time dimensions involve the 4th and 5th dimensions but your anti-matter universe is also locked in, but it's not locked in that way, it's locked in in the 6th dimensional level and also the 11th. And you get, through this whole, strange arrangement, you get into, through higher order time manipulation, you get into areas of other universes. Now that's not completely answering your question in terms of what Bearden is saying. But, like I say, he's correct at least as far as I understand what he's saying, and I'm not sure I understand all of what he's saying because I haven't read it all.

Time is, in a larger sense, in reality, a dimension. But it is not something which we, in our level here, really understand, and we certainly don't see it. We only see the effects.

(Regarding Beardon) ...his real job now is still defense analysis and strategy analysis; the same thing he did in the military he's doing for private corporations. And he also appears to be still connected with Intelligence. He says he's retired but I have my own personal doubts about that because of certain things he says. But most of the research and he said this he has had to make clear at his public lectures, when he starts talking about the Russian work, the UFO's and the weather modification and all of this, he said, this is my own research, it has not come out of government classified sources, it is not infringing on government classified information or privileged information. He said, this is my own research; it's totally separate. He's quite clear about this and I'm sure he's quite correct because he would be in an awful pile of trouble.

There's only one area where he stuck his nose out and he's gotten himself in trouble, and that was when he spoke out about AIDS, the causes and cures of AIDS. He has his book *AIDS: Biological Warfare*; and it's a bombshell. And he got more than got his wrists slapped over that because he stated very flatly the causes and the potential cures, (accurately,) for the most part. He alluded to the electromagnetic cures but he also did not point out, though I haven't read the book in full, he accurately states there is no electromagnetic connection. There certainly is in so far as the triggering mechanisms are concerned.

The virus gets into the body. The body, if it's working at all, and you're not already 3/4 dead, the immune system automatically puts up a defense to the virus and isolates it. And then it sits there in the body for "umteen" periods of time. It may run 6 months, it may run 10 years and



nothing happens. Sometimes it never happens with a person. They've got the virus in them all this time. They'll get an HIV plus reaction on the test because of the antibody reaction with the chemicals they use in the testing. But that doesn't mean the person automatically is going to come down with the disease. Its not automatic.

There are other factors involved. The weakening of the immune system and triggering the mechanism of the reproduction of the virus. Anything that triggers it such as pulsed electromagnetic fields will start it going, that's why most of your AIDS cases are in the big cities, and very little in the rural areas. You go well north of Denver there are no charted cases as such.

SS: Why is that, because there are just free floating electromagnetic waves?

AB: It's because of the concentrated electromagnetic pollution in our big cities. The major problem seems to be our TV stations. The fact that they use pulsed transmission, class D transmission for higher efficiency and to get a better picture out further and also to avoid some of the problem in reception. They also additionally use circular polarization. But the pulsed transmission as characteristic of a TV, they can do this on AM, they can not do it on FM. It's very, very complex and very difficult. But with the signal for TV, which is AM, or for the Voice of America AM broadcasting facilities which are all over Africa and various places around the world, which are now running megawatts of power, there are also class D pulse modulation. And this stuff generates enormous harmonics and is very disruptive to the body's physiology. This may be the key to what's going on with the AIDS, the rise of the cases in the cities.

But he (Beardon) got into this and he got into the fact that the government knows the cause and they probably know the cure and boy, they came down on him. It's part of the government policy, they don't want a cure for AIDS - it's part of the population control program. The Navy did a private estimate a couple of years ago on a classified study how many people were likely to come down with AIDS by the year 2000, as an example. Their computer studies said by the year 2000 there will not be man or beast, verabrae beast, on the face of the earth that doesn't have the virus in him. And they don't know how many will succumb or how long it will be if there will even be a human race left.

That was the Navy's study. It was highly classified. A friend leaked it and the Navy couldn't quite kick him out because of that. He was violating security but they didn't want to do it on that basis because you see if they fire him for violating security he has the right to know why and he can make it public. And that was not something they wanted public. So they didn't fire him over that. They found another means and they got rid of him, killed his clearance and dumped him. But he went public on that thing and that was the Navy's study and Beardon is saying the same thing. It's going to start increasing at a geometric progression rate, and he says it will be getting in the next 5 years way out of hand. It's already way out of hand in Africa.

TC: These class D pulse modulations, do you have to have a TV to process it in order for it to be harmful?

AB: No, it has nothing to do with the receiver. It's the transmitting signal itself. If you're sitting close to a transmitter or within reasonable distance; you would have to establish a criteria of field strength, and I don't know what that threshold is on this, but if you're radiated by the signals from the transmitter, if you're reasonably close to the actual physical tower, the transmitter, you're getting radiated, it's going to affect you physiologically.

Now there's a very good example of this. Measurements were made of this in Portland, Oregon. Oregon is perhaps unique in this in that they have all of their FM, AM, and TV transmitters upon Mt. Olympia, and it's an ugly collection of transmitters in one location. Right next to this transmitter site are all kinds of residences, people living there.

The rate of leukemia is very high in Portland in that area; and one private doctor did a private study on this to try and correlate what is doing this, what's going on, looked back in the case histories, the family histories, etc.. He found out that people that lived in the vicinity of those transmitters came down with this particularly nasty form of leukemia and he finally determined that if they lived there long enough the rate of succumbing to leukemia was 100%. There were no exceptions. If they moved away from that area they would recover as long as they didn't have it fatally already.

The physiological symptoms in the sites of the transmitter within a mile or so were severe, very severe. The people knew it, in some cases and they just got the sense and said, "I don't like it here, let's go somewhere else," and they go someplace else and they get over it.

I was up in that site once with a friend Bill who was working as a chief engineer down at the local AM, FM and TV stations in Portland and he'd have to go up and do maintenance occasionally in that tower in the transmitter section. He says he hated to go up there. He says you're up there half an hour and your brain just scrambles, you can't think straight anymore.

You walk in the door and they have this fluorescent tube over the door, it glows day and night. He told me, he says, "That's not wired to anything." I say, "What do you mean it's not wired to anything?" He says, "There's no connections. You can hold that thing in your hands and it will light up like a Christmas tree. That's how much RF is coming out of this building. We're subjected to that as long as we're in here." They have problems occasionally where the equipment just fries itself, particularly some of the solid state components which are highly susceptible to this sort of thing. He said, "You don't want to stay up here very long. I don't want to. I have to come up here to do maintenance. When I go home I have quite a time getting over it. It takes overnight." It just scrambles the normal function of his brain. He can't think anymore as to what he's doing, what he's up there for, what tools to pick up, what he's actually working on. The continuity of thought is lost.

TC: This class D pulse modulation, is it scalar?

AB: No. It produces RF sidebands and harmonic sidebands which are damaging and it may produce some scalar components. I don't think anybody's done a good study on that. But it's not doing this deliberately if it is. See, all tube-type transmitters, and all of these are great big transmitter tubes, all produce some of the higher order energies, and some scalar-type transmission without it being intended. This is one of the reasons why, any ordinary AM transmitter produces some of those higher order energies, and if you want overseas reception you have to use tube-type receivers particularly the types designed by T. Henry Morey and Tesla in the 1930's, to get a constant reception from overseas. The solid state receivers are worth the powder to blow them for the most part, not the commercial ones. They do not work that well. They lose part of the components. They lose all the higher order energies which you need to reinsert in the processing in the signal in order to prevent the very severe fading effects which normally occur.

TC: Can they put the subliminal messages on CD's and cassette tapes?

AB Not readily on magnetic tape because you have a very limited frequency range in which they work. They could probably do it on laser discs. They couldn't do it on a CD audio disc because your frequency range is too limited there.

SS: Are there any things you can use to protect yourself from ELF's and these waves?

AB: Yes there are devices available and I have one that might be one of them. I have not examined it, it's the first time I saw it. We'll have to measure it to see what it's putting out, take it apart and look at it. But there are devices that have been available and are still available that do help. There's more than one approach. The 7.83 hertz human resonance thing is one of the most reliable. It's only about 35% effective. It does not help everybody, but it is helpful.

THE SOVEREIGN SCRIBE  
P.O. Box 350  
McKenna, WA 98558

**Nude man mystery**

A University of Massachusetts graduate student found dazed and naked by railroad tracks. Doesn't know how he got there in that condition and neither do cops, officials in Lovett report.  
WJW 8-19-90





Transfer of Energy Through Time  
and Coupling of Parallel Universes

V: Would you explain your theories about time and energy?

H: When I was in France, I was part of a group looking into theories of entropy states and the general thermodynamics of plasmas. The natural rate of entropy increase in a closed system defines the flow of what is perceived as time. We were trying to develop a better insight into the process of synchronization between apparently uncoupled systems, in other words to explain how time manages to flow at the same rate in different parts of the universe. We ended up deriving a set of mathematical expressions that interrelated entropy functions, quantum energy states, and spacetime coordinates of quantum events. In particular, certain variables that could be interpreted as time and energy turned out to be covariant.

V: Do you mean there was some kind of equivalence relationship?

H: Not quite. But you could almost think of it in that way. It meant that the universe could be represented by an ensemble of "events", each characterized by a set of energy states and spacetime numbers; nothing more. In such a representation of the universe, the idea of conservation of mass-energy did not hold; it was replaced by a conservation of the product of that quantity with spacetime. By means of math transforms, it was possible to transform one universe into another in which the quantity varied inversely with the other. If you made all the spatial variables constant, the spacetime functions reduced to pure time; you could transform energy to time and vice versa. We had no idea at that time what that meant.

V: What did it eventually mean?

H: What it seemed to say was that energy could be extracted from the universe, which is where ordinary conservation breaks down, and injected into another version of that universe in which the time coordinates of all the "events" were shifted by some amount. The more energy you transformed, the greater the time shift would be. If that was interpreted as taking place within the same universe, it seemed to suggest that energy could be transferred through time. We must conclude that all versions of the universe in which we exist, interpreted linearly

as "past", "future" etc. are equally real. Thus we have a continuum. The only model I can think of is a complex serial one in which altering the events in a past universe affects not only the future of that particular universe as it evolves in time, but also the "presents" of all the other universes that lie ahead of it. In other words, there is a mechanism of casual connection through the continuum that the simple serial model does not address.

V: Could you expand on that concept?

H: Everything we have discovered so far seems to add up to two things. First, the universe that we see around us and which forms part of us is simply one of many, equally real universes that appear to be strung sequentially along a single timeline. Second, events that happen in this universe affect not only its "future", but the situations in all the other universes that lie ahead of it. That, of course, suggests a continuity throughout the system; the "future" universes ahead of us form a progression of states that are evolving from the present state. We need to ask ourselves what the mechanism is that provides that continuity. That same mechanism will enable an event in one universe to alter events in another universe. The continuity follows from the fact that objects, being mass, don't vanish; they endure in time.

V: Unless, of course, they are deliberately withdrawn from the coordinates they occupy.

H: Yes. Mass arranges itself into different patterns to produce the changes we associate with the passage of time, but in doing so it provides the connection and continuity that enables one universe to evolve from another. For example, if a candle has burned down, in the universe "behind" us it is still intact; in the universe ahead it probably does not exist at all in that form. The whole candle is the sum of all of them. I have a drawing here that will assist in an explanation. Try thinking of a two-dimensional analogy. Imagine that the universe is flat and everything it contains is flat. Now form a solid continuum by stacking an infinite number of zero-thickness planes like that together, like the pages of an infinitely thick book. Every page is one universe. Mass continues through these pages in a thread-like manner. Anybody inside one of those universes will see mass patterns change sequentially.

Look at the diagram I drew. Each universe consists of a space containing objects and inhabitants that

are all made up of particles, or at least that is what it looks like if you happen to live inside one of them.

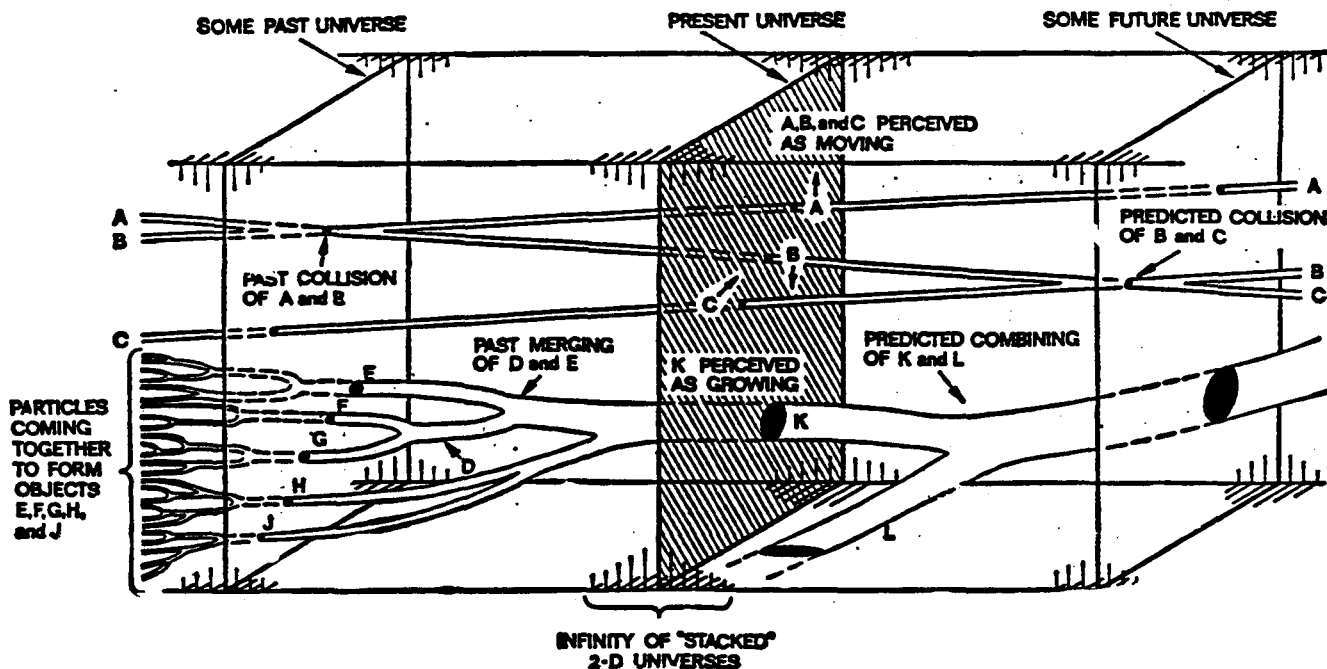

We, in our privileged position as superobservers looking in from the outside, can see that every particle of mass is really an infinitesimally thin slice of a thread that passes through all the universes. As the universe moves along the threads in some kind of supertime, the particles or slices appear to move through space. That gives a visible rate of change that is observed as "normal time" within the universe. From our position we can see that all the universes are equally real, only the one that you happen to be part of and moving with gives the illusion of appearing more real to you than the rest of them.

V: So you would be able to send signals or transport mass from one universe to the other.

H: Exactly.

V: If you send a signal from one universe to another which changes an event pattern, I assume that the memory of having a reason to change that event is erased as soon as the event is changed?

H: Yes, because our memories consist of electrochemical and DNA pattern changes. Everything that formed any record of the original pattern was reset. Hence, our

memories are consistent with the new pattern that now exists. In actuality, causes and effects exist not on a series on a unidirectional time line, but the system is dynamic in that time loops exist, and these loops make it possible, in effect, for effects to be detected before the cause of the effect exists.

V: I think the holographic model of the universe would explain it, because of the interconnectedness of everything through hyperspacial formats. The super-observer that you are talking about is in fact consciousness itself - all wave and particle interchanges are, in actuality, consciousness as viewed from different perspectives. Access to what are perceived as different "spacetime" coordinates can ultimately be accomplished through the manipulations of consciousness, so any devices that are devised to accomplish this purpose simply mimic the mental operations in consciousness of more evolved beings. There are many transitional instances where alien equipment is tuned to the specific patterns of a particular being, and the equipment functions as a modulator or transducer of consciousness. Time flow, as you mention it, applies within certain boundaries, and everything hyperspacial to those boundaries functions in terms of that which makes up the conceptual loops that you speak of. All in all, it makes for an interesting discussion.

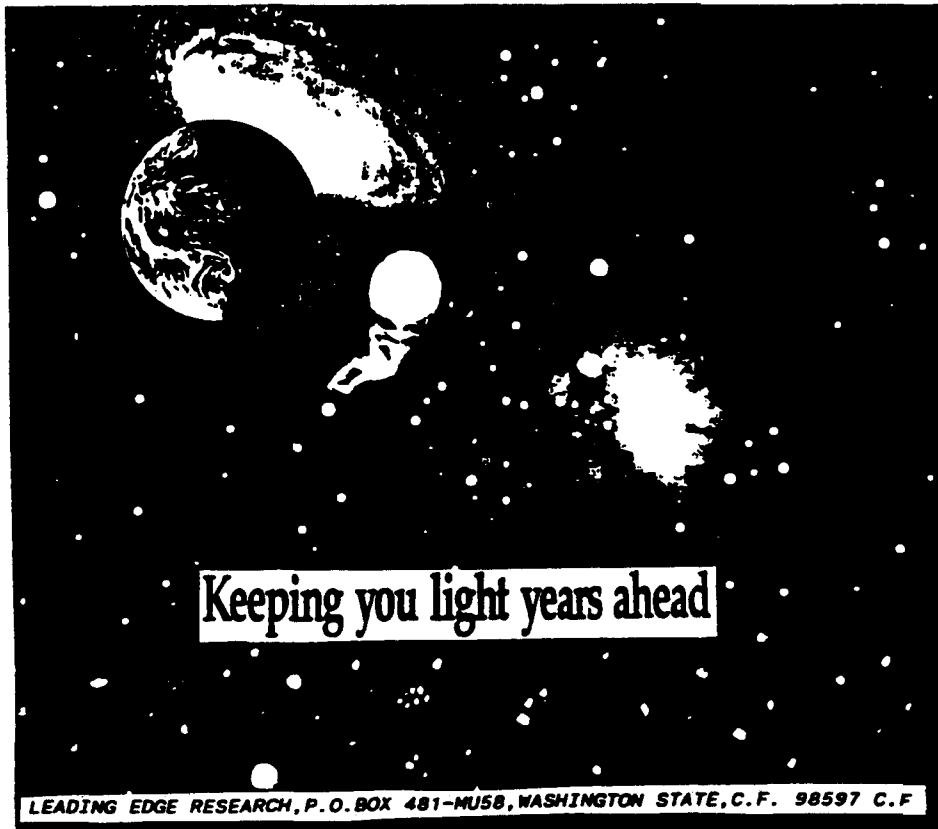

# Magnetite Biomineralization in the Human Brain

*Key Terms:* Iron, Magnetite, Biomineralization, ELF Magnetic Fields, Brain

Joseph L. Kirschvink, Atsuko Kobayashi-Kirschvink,  
and Barbara J. Woodford

Division of Geological & Planetary Sciences,  
The California Institute of Technology,  
Pasadena, California 91125, USA

\* Present Address: Department of Anatomy and Cell Biology, University of Southern California,  
1333 San Pablo St., Los Angeles, CA 90033

Corresponding Author:

Joseph L. Kirschvink  
Division of Geological & Planetary Sciences  
The California Institute of Technology  
Pasadena, CA 91125

818-356-6211 (o)  
818-568-0935 (fax)

## ABSTRACT

*Background.* Although the mineral magnetite ( $\text{Fe}_3\text{O}_4$ ) is precipitated biochemically by bacteria, protists, and a variety of animals, it has not been documented previously in human tissue. Because it interacts over a million times more strongly with external magnetic fields than any other biological material, knowing whether humans precipitate magnetite is important for assessing potential biohazards of magnetic fields.

*Methods and Results.* Using an ultrasensitive superconducting magnetometer in a clean-lab environment, we have detected the presence of ferromagnetic material in a variety of tissues from the human brain. Magnetic particle extracts from solubilized brain tissues examined with high-resolution transmission electron microscopy, electron diffraction, and EDAX analyses further identify minerals in the magnetite-maghemite family, with many of the crystal morphologies and structures resembling strongly those precipitated by magnetotactic bacteria and fish.

*Conclusions.* These magnetic and HRTEM measurements imply the presence of a minimum of 5 million single-domain crystals/g for most tissues in the brain, and more than 100 million crystals/g for pia and dura. Magnetic property data indicate the crystals are in clumps of between 50 and 100 particles. Biogenic magnetite in the human brain may account for high-field saturation effects observed in the T1 and T2 spin echoes of MRI, and perhaps for a variety of biological effects of low-frequency magnetic fields.

## INTRODUCTION

In past studies of iron storage and magnetic resonance imaging (MRI), it has been assumed universally that there are no permanently magnetized (ferromagnetic) materials present in human tissues<sup>1,2</sup>. Similar assumptions have been made in virtually all biophysical assessments of human risk associated with exposure to static and extremely low-frequency magnetic

0372-A

fields<sup>3</sup>, and by critics<sup>4</sup> of epidemiological studies which suggest links between weak, powerline-frequency magnetic fields and various human disorders<sup>3-9</sup>. These analyses have focused on the side effects of electrical induction, or possible diamagnetic and paramagnetic interactions. However, the ferrimagnetic mineral magnetite ( $\text{Fe}_3\text{O}_4$ ) is formed biochemically by many living organisms. Because ferromagnetic crystals interact over a million times more strongly with external magnetic fields than do diamagnetic or paramagnetic materials of similar volume, earth-strength magnetic fields can yield many responses which stand above thermal noise<sup>10</sup>. Hence, the assumption implicit in past studies that human tissues are free of ferromagnetic material needs to be reassessed critically and tested experimentally.

Previous studies of ferromagnetic material in human tissues have not been conclusive<sup>11-13</sup>. Despite this, extensive research over the past 30 years has demonstrated that many organisms have the biochemical ability to precipitate the ferrimagnetic minerals magnetite ( $\text{Fe}_3\text{O}_4$ )<sup>14-21</sup> and greigite ( $\text{Fe}_3\text{S}_4$ )<sup>22</sup>. In terms of its phyletic distribution, magnetite biomineralization is particularly widespread, having been documented in 3 of the 5 Kingdoms of living organisms (Monerans<sup>14</sup>, Protists<sup>15</sup>, and Animals<sup>16-21</sup>), with a fossil record extending back into Precambrian time<sup>23</sup>. Within Kingdom Animalia, it is known within the mollusks<sup>16</sup>, arthropods<sup>17</sup>, and chordates<sup>18-20</sup>, and is suspected in many more groups<sup>21</sup>. In the microorganisms<sup>14,15</sup> and fish<sup>20</sup>, linear chains of membrane-bound crystals of magnetite (magnetosomes) form structures best described as 'biological bar magnets'. These chains cause the individual dipole moments from each crystal to add together vectorially, producing strong interactions with the Earth's magnetic field. Although it is often present in small concentrations, magnetite is one of the most commonly precipitated minerals when viewed in terms of its phyletic distribution<sup>24</sup>. Hence, the assumption implicit in past studies that human tissues are free of ferromagnetic material needs to be reassessed critically and tested experimentally.

We report here the first demonstration that human tissues possess similar crystals of biogenic magnetite, with minimum estimates between 5 and 100 million single-domain crystals per gram in the tissues of the human brain. Magnetic particle extracts from solubilized tissues examined with high-resolution transmission electron microscopy and electron diffraction identify minerals in the magnetite-maghemite solid solution, with many crystal morphologies and structures resembling those precipitated by magnetotactic bacteria and fish.

## MATERIALS AND METHODS

**Tissue Samples.** Human brain material was obtained 12 to 24 hours post mortem from the Alzheimer's Disease Research Center Consortium of Southern California. Samples of brain and meninges were dissected using acid-cleaned ceramic or Teflon-coated instruments. These tissues were placed into 70% ethanol (made with deionized water and filtered through a 200 nm millipore filter) in containers which had previously been cleaned with 2N HCl. Samples from 7 brains were obtained from patients whose ages averaged 65 yrs and ranged from 48 to 88 years. Four of these were from suspected Alzheimer's disease patients. Cerebral cortical areas and cerebellum were included for all 7 brains. In one case, brain and spinal dura, basal ganglia and midbrain, and, in another case, olfactory bulbs, superior sagittal sinus and tentorium of the dura were obtained in addition to the above tissues.

**Magnetometry.** Sub-samples for magnetic measurements were removed from the tissues using similar tools in a magnetically-shielded, dust-free clean lab<sup>25,26</sup>. Measurements of ferromagnetic materials were made using a magnetometer employing Rf-biased Superconducting Quantum Interference Devices (SQUIDs), designed to measure the total magnetic moment of samples placed within a Helmholtz-coil pickup loop<sup>27</sup>. This instrument detects only the total magnetic moment arising from permanently magnetized particles within a solid sample; all of the other cellular iron and other diamagnetic, paramagnetic, and superparamagnetic materials are "invisible". A liquid-nitrogen chilling device enabled the temperature of the vertical sample access chamber to be held below  $-10^\circ\text{C}$ , ensuring that magnetic particles within tissue samples were prevented from rotating. Samples were fastened to a thin, acid-washed monofilament string, and a stepping motor moved the sample vertically between the magnetization and demagnetization coils, and the measurement region of the SQUID magnetometer.

Several magnetic analyses borrowed from the field of rock and mineral magnetism<sup>28</sup>

were performed routinely on tissue samples in order to determine the concentration, mineralogy, and packing geometry of any ferromagnetic materials present. Frozen tissue samples were first demagnetized completely in a peak alternating field of 250 mT to randomize the magnetic directions of any ferromagnetic particles present. They were then subjected to a progressive acquisition of the anhysteretic remanent magnetization (ARM), each step of which used a peak alternating field (Af) of 100 mT paired with a DC biasing field which increased progressively between 0 and 2 mT. This procedure is a sensitive indicator of the packing geometry of single-domain particles<sup>30</sup>. Information on the coercivity distribution then was obtained by exposing the sample to a 100 mT isothermal remanent magnetization (IRM) pulse and subjecting it to progressive Af demagnetization, and finally by a progressive IRM acquisition experiment reaching peak fields up to about 0.7 tesla. The field strength at which the IRM acquisition and Af demagnetization curves cross is the best measure of the average coercivity of magnetic particles in the sample, and the depression of this intersection below the 50% level is a measure of inter-particle interactions<sup>30</sup>.

**Sample preparation for the magnetometer.** Pia and blood vessels were removed from all samples of the meninges before analysis in the SQUID magnetometer. Two preparation methods were used. Large, intact samples of the cerebral cortex and cerebellum were frozen directly in liquid nitrogen. Brain tissues which fractured upon freezing or dissection were placed into a previously acid-cleaned ice cube mold and frozen into blocks with small quantities of non-magnetic, deionized water. Either the frozen piece of brain or the ice/brain block was attached by a slip knot to the monofilament line and then centered within the column of the SQUID magnetometer. Background instrument noise and the levels of laboratory contaminants were monitored with blank 15g ice cubes of distilled, deionized water; typical ice-cube background noise levels were in the  $2 \times 10^{-8} \text{ Am}^2/\text{Kg}$  range. All aqueous solutions used in sample handling were passed through 200 nm filters. All solutions, including the toluene and tissue solubilizers, were cleaned magnetically by storing for at least two weeks prior to use in containers with large, high-intensity NdFeB magnets strapped to their base to aid in the removal of any pre-existing ferromagnetic contaminants.

**Extraction and Electron Microscopy.** Extraction devices made from Pyrex weighing vials were used to remove the magnetic particles from the brain tissues. The ground-glass caps were modified by glass blowing to make a thin-walled cylindrical 'finger', sealed on the bottom, extending from the cap about 2/3 of the distance into the vial. Tissues were digested in an approximately 1/3 volume ratio of magnetically cleaned, commercial solutions of toluene and quaternary-ammonium hydroxide (e.g., Beckman<sup>®</sup> Tissue Solubilizer) for a minimum period of one week while exposed to the strong field of a NdFeB magnet inserted within the finger. The vial cap and magnetic finger were then rinsed in clean toluene, the magnetic aggregates were re-dispersed mechanically in 1/4 ml toluene, and small drops placed on carbon-coated copper grids for HRTEM analysis. Samples were examined with high-resolution on a Phillips 430, 300 kV HRTEM with an energy dispersive X-ray analysis system for elemental determinations. Mineralogic assignments were made by indexing the spot patterns produced by selected area electron diffraction on individual mineral grains and on rings from powder patterns, with calibration against a gold film standard. An estimate of the grain size distribution was made by measuring the length and width of 70 crystal shadows from a large clump. Control samples consisting of the solutions without brain tissues, as well as the solutions spiked with known quantities of bacterial magnetite, were run to check for contaminants in the solvents as well as to determine their effect, if any, on the well-studied morphology of bacterial magnetites.

## RESULTS

**Magnetometry.** All of the tissues examined had isothermal remanent magnetizations (IRM) which saturated in applied fields of about 300 mT, a characteristic property of the magnetite-maghemite series. *The ability to gain and lose remanent magnetization in these experiments is a definitive characteristic of ferromagnetic materials.* Table 1A shows the mean values for each brain. The average magnetization indicates the equivalent of about 4 ng magnetite/g tissue. In contrast, average values for the meninges from three brains (Table 1B) are nearly 20 times higher, or about 70 ng/g. For comparison, measurements of IRM from triple

distilled, deionized ice cubes yield a background 'noise' of about 0.5 ng/g.

There was remarkable consistency in the IRM measurements for both the brain tissue and the meninges. There was little difference in IRM from one area of cerebral cortex to another or in the cerebral versus the cerebellar cortex. Differences between tissues from the normal brains versus those suspected or confirmed to be Alzheimer's disease cases were negligible. Areas of brain previously reported to have high iron content include the dentate nucleus, the basal ganglia and areas of the midbrain<sup>31</sup>. Samples of these areas had no greater content of magnetic particles than did the cerebellar or cerebral cortex.

Figure 1 shows magnetic properties for representative tissues, including coercivity determinations<sup>27</sup> (Fig. 1A) and a test for inter-grain interaction effects using the anhysteretic remanent magnetization<sup>28</sup> (ARM, Fig. 1B). Median coercivity values were about 30 mT, but ranged from 12 (pia from cerebellum) to 50 (basal ganglia), well within the coercivity range for single-domain magnetite. The shift in coercivity distributions as measured by IRM acquisition and its demagnetization, and the relatively slow tendency to acquire an ARM, suggest that the particles *in situ* are in small interacting clumps. Comparison with bacterial control samples suggests between 50 and 100 particles per clump.

**Extraction and electron microscopy.** When viewed under low power through an optical dissecting microscope, black strings of aggregated particles extracted from brain tissues are seen collected at the focus of the magnetic finger device. In shape and morphology, these aggregations are indistinguishable from similar aggregates from the magnetotactic bacterial controls. No magnetic aggregates were observed to collect in the blank, tissue-free control samples. Rough volume estimates of the extracted material, made by measuring the length and width of the aggregates and totaling for each chain, agree to within an order of magnitude with estimates from the IRM measurements, implying that the extraction technique was reasonably efficient.

Figure 2 shows two representative crystal morphologies of the extracted magnetic particles. Grain sizes were bimodal, with 62 of the 70 measured crystals in the 10-70 nm range and the remaining 8 with sizes ranging from 90 up to 200 nm. Measurements of the TEM shadows from 62 of the smaller particles in one aggregate yielded an average size of 33.4 +/- 15.2 nm. Note that this mean value must be biased towards larger sizes because the extraction procedure will discriminate against very small particles which move more slowly through the liquid. Size and shape relationships for all measured particles fall within the single-domain and superparamagnetic fields for magnetite<sup>30</sup>. Crystal volume estimates, done by assuming equant particle shapes, imply that the larger particles compose a maximum of about 85% of the magnetite. Using this distribution data, we estimate that brain tissues contain a minimum of about 5 million crystals/g, distributed in 50 - 100 thousand discrete clusters. Similarly, the meninges contain a minimum of 100 million crystals/g, in 1 to 2 million clusters.

Energy dispersive X-ray analyses of the crystals gave consistent peaks of Fe, with variable Cu peaks (from the copper TEM grids) and minor Si, Ca and Cl (probably contaminants from the glassware). Mixed Fe-Ti oxides, which are usually present at least in trace amounts in geologically-formed magnetic minerals, were not detected in any of the brain crystals examined. Indexed electron microdiffraction patterns from individual crystals and particle aggregates yield the d-spacings characteristic of magnetite ( $\text{Fe}_3\text{O}_4$ ), with smaller particles showing variable oxidation towards the ferrimagnetic solid-solution end member, maghemite ( $\gamma\text{-Fe}_2\text{O}_3$ ). This oxidation probably occurred during the extraction process, as is observed commonly in very fine grained magnetites<sup>29</sup>.

Figure 2A is a TEM image of a clump of small particles from the cerebellum, and Fig. 2B shows a HRTEM image of a well-ordered single-domain maghemite crystal imaged in the [211] zone. It displays several intersecting sets of crystal lattice fringes which appear as fine stripes which run across the image (and are viewed best at a low angle relative to the page). The most prominent set, which runs across the width of the crystal, corresponds to the 4.85 Å spacing of the (111) plane; another set perpendicular to this, running the length of the crystal, has the 2.95 Å spacing of the (022) planes. Note that the [111] direction of the crystal, which is the easy direction of magnetization<sup>32</sup>, is parallel to the particle length, and that the (111) fringes go completely across the width of the particle without disruption. A superimposed 'graininess' is present, along with somewhat ill-defined edges. These are typical features of magnetite



crystals formed within magnetosome membranes<sup>33-35</sup>, and are very similar to the single-domain particles in the magnetosome chain structures present in the dermethmoid tissues of salmon<sup>20</sup>. Figure 2C shows the indexed electron-diffraction spot pattern from this crystal.

Figure 2D shows one of the larger particles which is about 200 nm in size. Other particles range up to 600 nm in diameter. Electron microdiffraction indicates that these particles are dominated by a single crystal, with occasional smaller particles adhering to their surface. Their measured size and shapes place them within the single-domain stability field<sup>36</sup>. These particles have magnetic orientation energies in the geomagnetic field 20 to 150 times higher than the background thermal energy, kT.

## DISCUSSION

Results from these studies indicate that human brain and meninges contain trace amounts of ferromagnetic material. These magnetic particles in the human brain are diffusely and homogeneously distributed over all cerebral lobes, the cerebellum and basal ganglia and midbrain. The consistency of our magnetic property data from piece to piece of brain tissue and from piece to piece of meninges suggests that the observed moments were not produced by occasional contamination from the environment, but were *in situ* ferromagnetic materials distributed in a tissue-characteristic fashion. The magnetic material was in the tissues *prior* to the chemical digestion steps which are of the most concern for potential contamination. An external inorganic source is also unlikely because of the lack of particles containing mixed Fe-Ti oxides, which are common in igneous and metamorphic magnetites. Surface textures and crystallographic features for the smaller particles are remarkably similar to biogenic magnetites studied in bacteria<sup>34,35</sup> and fish<sup>20</sup>. The (111) crystal alignment has been interpreted as a biological mechanism for maximizing the magnetic moment per particle, as the {111} direction yields about 3% higher saturation magnetizations than do other directions<sup>20,34,35,37</sup>. This prismatic particle shape is also uncommon in geological magnetite crystals of this size, which are usually octahedra. Hence, these magnetite crystals probably form within human tissues by a similar, biologically-controlled process. Unfortunately, the tissue digestion and extraction process destroys the cellular organization of the particles. Only the ARM results yield clues to the *in situ* grouping in small clumps.

The present study provides the first evidence of magnetite biomineralization in human tissues, based on both superconducting magnetometric and TEM techniques. Previous studies did not identify the mineralogy of the magnetic materials, nor eliminate the possibility of contamination as a source of the ferromagnetic material. Kirschvink<sup>11</sup> noted the presence of fine-grained ferromagnetic material in tissue from adrenal cortex which had a coercivity distribution consistent with magnetite, but techniques for extracting and characterizing the material had not been developed. Baker et al.<sup>12,13</sup> attempted to measure the soft tissues of the brain, but found they were not significantly more magnetic than the background noise of their magnetometer system. They did report, however, detecting magnetic material within the human ethmoid bone, as well as the presence of histologically stainable iron. However, the levels of magnetite inferred to be present were surprisingly high, and a subsequent coercivity spectral analysis ruled out magnetite as the source, with metallic sawblade contamination the most probable explanation<sup>26</sup>. One other group<sup>38</sup> extracted magnetic particles from digested lung tissue, but the authors were unable to distinguish the exogenous particles inhaled from atmospheric dust from biochemical precipitates. Their extraction procedure, however, would only be effective for the large ( $\gg 1 \mu\text{m}$ ) particles most likely to be inorganic contaminants.

In recent years, several medical groups have claimed that MRI images weighted by the T1 and T2 spin echoes correlated with the observed distribution of stainable ferric iron in human brain tissue<sup>2,39,40</sup>. These anomalous spin echoes have been interpreted as arising from irregular distributions of paramagnetic iron (deoxyhemoglobin, ferritin, and hemosiderin). Iron distributions measured in this fashion increased with age, as is known from extensive histological work<sup>31</sup>. However, this interpretation was challenged subsequently by Chen et al.<sup>41</sup>, who found generally poor correlation between iron concentration and T2 relaxation, and by Bizzi et al.<sup>42</sup>, who discovered that the iron-correlated spin echo effects did not have the quadratic variation with increasing magnetic field strength predicted by the paramagnetic hypothesis.

Although not suggested by any of these authors, all of these results are compatible with the presence of trace levels of magnetite. Unlike paramagnetic materials, magnetite saturates in applied fields around 0.3 tesla, as did the spin echoes of Bizzi et al.<sup>42</sup>

The presence of magnetite in human tissues has potential implication for at least two biomedical issues which have been discussed extensively in the literature; these include human exposure to the strong static fields used in MRI studies<sup>3</sup> and the much weaker 50 and 60 Hz fields produced by the electric power system and appliances in industrialized countries<sup>4-10</sup>. First, MRI systems are now being used routinely in clinical applications which subject patients to static background magnetic fields in excess of 1.5 tesla, 30,000 times stronger than typical geomagnetic fields. Under these conditions the maximum magnetostatic orientational potential energies for the magnetic particle clumps are between  $10^3$  and  $10^7$  times higher than the thermal energy,  $kT$ , at body temperature. Hence, the energies are much larger than the chemical energies present in covalent bonds, which typically are on the order of 100  $kT$ . Second, the magnetic torque from external alternating fields will induce mechanical oscillations in the particles, and the potential exists for such motions to do things like opening trans-membrane ion channels. Two separate analytical approaches suggest that fields of 50 or 60 Hz with peak intensities slightly stronger than that of the earth would be required to make these effects stand above  $kT$ <sup>10,43</sup>. Although peak alternating magnetic fields generated by most electric transmission lines are well below this level, some electric appliances produce stronger fields<sup>44</sup>. Unfortunately, without more knowledge of the cellular location, ultrastructure, or biological function of these particles, it is impossible to predict whether magnetomechanical effects of this sort pose a human health hazard.

## ACKNOWLEDGMENTS.

We thank Dr. Carol Miller of the USC Medical School for providing access to brain materials, Drs. Juan Diaz-Ricci, Derek H. Fender, and Leon T. Silver for helpful support and discussions, and Dr. C.C. Patterson for ultrapure water. Dr. Brent Fultz and Ms. Carol Garland of the Caltech Materials Research Center provided essential help with the high-voltage electron microscopy. Drs. K.M. Towe and R.B. Frankel provided critical and useful reviews of the manuscript. This work was supported by NIH grant GM-41635, and the Caltech Materials Research Facility is supported by NSF grant DMR-8811795. Contribution #5068 from the Division of Geological and Planetary Sciences of the California Institute of Technology.

## REFERENCES.

1. Brittenham, G.M., Farrell, D.E., Harris, J.W., et al. (1982) *N. Engl. J. Med.* 307, 1671-1675.
2. Gomori, J.M., Grossman, R.I., Goldberg, H.I., Zimmerman, R.A., Bilaniuk, L.T. (1985) *Radiology* 157, 87-93.
3. Tenforde, T.S., Budinger, T.F. (1986) in *NMR in medicine: Instrumentation and clinical applications*. eds. Thomas, S.R. and Dixon, R.L. (American Asso. of Physicists in Medicine, New York) pp. 493-548.
4. Adair, R.K. (1991) *Phys. Rev. A.* 43(2), 1039-48.
5. Wertheimer, N., Leeper, E. (1987) *Annals of the New York Acad. Sci.* 502, 43-54.
6. Savitz, D.A., Wachtel, H., Barnes, F.A., John, E.M., Tvrdek, J.G. (1988) *Am. J. Epidemiol.* 128, 21-38.
7. London, S.J., Thomas, D.C., Bowman, J.D., Sobel, E., and Peters, J.M. (1991) *Am. J. Epidemiol.* 134, 923-937.
8. Savitz, D.A., Calle, E.E. (1987) *J. Occup. Med.* 29, 47-51.
9. Savitz, D.A., John, E.M., Kleckner, R.C. (1988) *Am. J. Epidem.* 131(5), 763-73.
10. Kirschvink, J.L. (1992). *Phys Rev A*, (in press).
11. Kirschvink, J.L. (1981) *J. Exptl. Biol.* 92, 333-5.
12. Baker, R.R., Mather, J.G., Kennaugh, J.H. (1983) *Nature* 301, 78-80.
13. Baker, R.R. (1985) in *Magnetite Biomineralization and Magnetoreception in Animals: A New Biomagnetism* eds. Kirschvink, J.L., Jones, D.S., MacFadden, B.J. (Plenum Press, New York) pp. 537-562.
14. Frankel, R.B., Blakemore, R.P., Wolfe, R.S. (1979) *Science* 203, 1355-1356.

Fig. 1

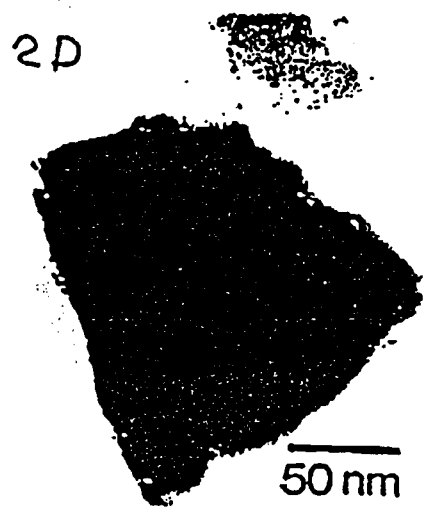
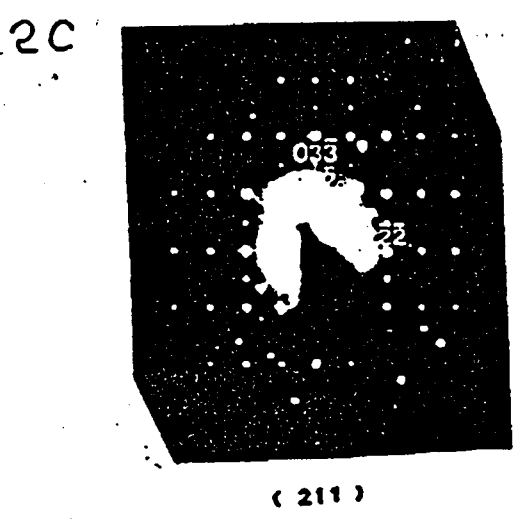
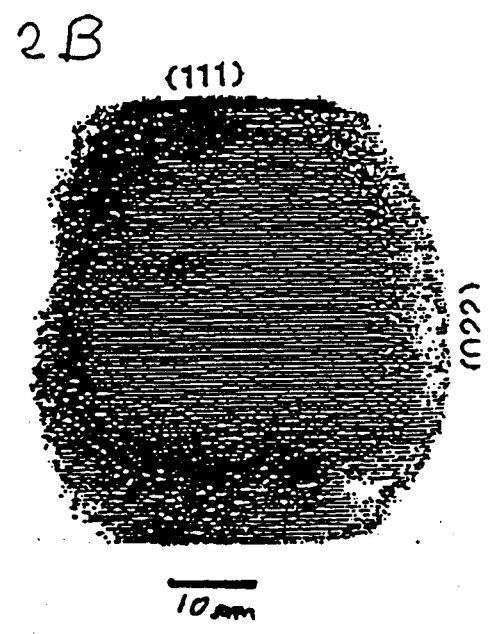
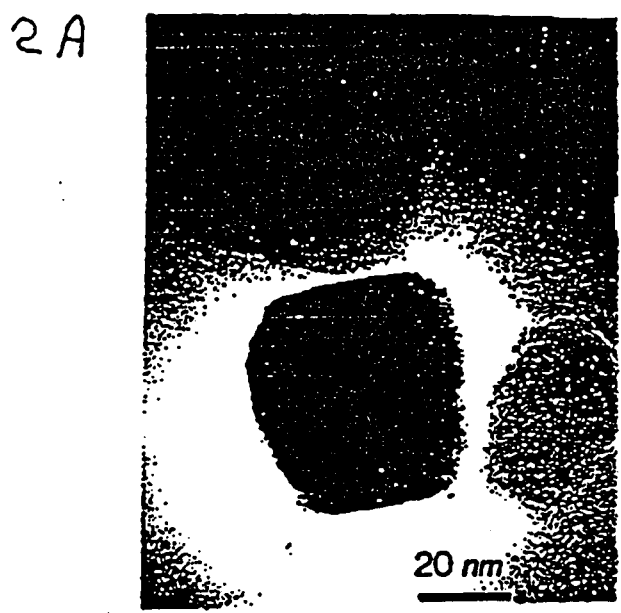
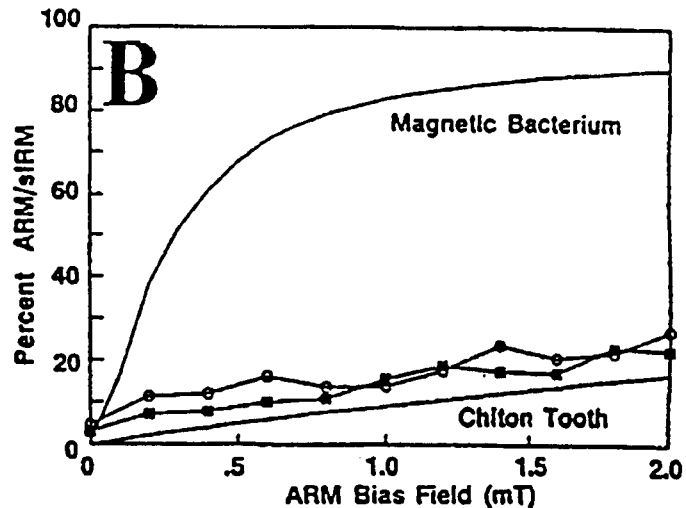
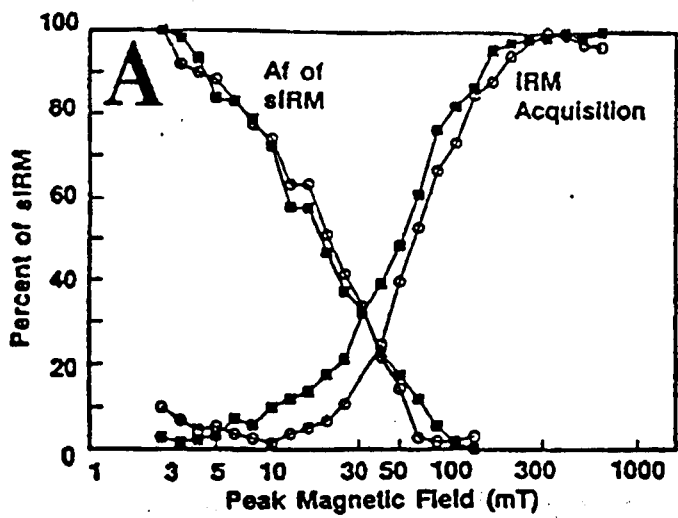

0372-G

## Figure Captions:

Figure 1. Rock magnetism of human brain tissues. In A, the curves labeled IRM acquisition show the relative magnetic moments remaining in the samples after a brief exposure to a magnetic pulse of the indicated strength. The tendency of the curves to flatten at high field levels is characteristic of the magnetite-maghemite solid solution series; most other ferromagnetic iron minerals saturate in fields above 1 tesla. The curves labeled 'Af of sIRM' show the progressive alternating-field demagnetization of the saturation IRM. The magnetic field value at which these two curves cross is the best measure of the average coercivity. The ordinate of the intersection point for non-interacting particles occurs at the 50% value; a depression or shift in this position is an indication of particle clumping effects. Fig. B shows the acquisition of anhysteretic remanent magnetizations (ARM). The upper control curve shows data from a sample of magnetotactic bacteria in which the magnetite crystals are aligned in linear chains and have few interparticle interactions, whereas the lower control curve is from a sample of magnetite from chiton teeth which are single-domain crystals but are highly interacting. Solid squares are data from pia from the frontal lobe, whereas the open circles show data from the cerebellum.

Figure 2. TEM images and diffraction patterns of representative magnetite and maghemite crystals from the human cerebellum. Fig. 2A shows a clump of small particles. The HRTEM image of the maghemite crystal in Fig. 2B shows the pattern of intersecting (111) and (022) fringes, with particle elongation in the [111] lattice direction. Although the (111) fringes continue across the particle width continuously, the (022) fringes show a dislocation or possible twin surface near one end of the particle. The (111) and (022) faces are shown. Figure 2C shows the indexed selected-area electron diffraction pattern of this crystal, taken in the  $\langle 211 \rangle$  zone. (A few miscellaneous spots are also present from the adjacent crystals seen in Fig. 2A, and the faint row of spots midway between the bright rows are [011] and equivalent reflections which indicate the oxidation to maghemite.) The diffraction rings from an aggregate of small crystals confirms the magnetite-maghemite identification. These measured values/ $\gamma$ -Fe<sub>2</sub>O<sub>3</sub> standards/ and [indexed] d-spacings for the rings are respectively: 4.0Å/4.18Å [200], 4.8Å/4.82Å [111], 3.2Å/3.41Å [211], 2.8Å/2.95Å [220], 2.6Å/2.78Å [221], 2.2Å/2.23Å [321], 1.8Å/1.87Å [420], 1.7Å/1.70Å [422], 1.5Å/1.61Å [511], and 1.3Å/1.32Å [620]. The tetragonal reflections [211], [221], and [321] are present in maghemite, and not in magnetite, and the pattern from the aggregate is a mixture of the two. One of the large magnetite particles is shown in 2D (diffraction pattern not shown).

**Table 1.** Mean saturated isothermal remanent magnetization (sIRM) for cerebral cortex and cerebellum tissues from each brain, expressed as  $\mu\text{Am}^2/\text{Kg}$  wet wt.  $\pm$  S.D. Occipital samples were from Brodman Areas (B.A.) 17, 18, 19; temporal from B.A. 20, 21 and 22; parietal from B.A. 3, 1, 2, 5 and 7 and frontal from B.A. 4 and 6. Sample sizes ranged from 0.5 g to 22g. The meninges from samples of brains 1, 2, and 6 were analyzed separately. The ice cube technique was used for all of the meninges, and on the tissues from brain #2 and 7 of 11 from #1; no difference in results was seen with this technique. Concentrations were estimated by noting that the saturation remanence should be exactly half of the saturation magnetization for a dispersion of single-domain crystals<sup>28,32</sup>.

### A. Brain Tissue

Brain Number	sIRM ( $\mu\text{Am}^2/\text{Kg}$ )	Concentration (ng/g)	# of Sub-samples
1 (Normal)	0.14 $\pm$ .08	3.0 $\pm$ 1.4	11
2 (Normal)	0.18 $\pm$ .10	3.9 $\pm$ 2.2	5
3 (Normal)	0.14 $\pm$ .05	3.0 $\pm$ 1.1	5
4 (Normal)	0.27 $\pm$ .21	5.9 $\pm$ 4.6	6
5 (Alzheimer's Disease)	0.20 $\pm$ .09	4.3 $\pm$ 2.0	3
6 (Alzheimer's Disease)	0.19	4.1	1
7 (Suspected Alzheimer's)	0.33 $\pm$ .19	7.2 $\pm$ 4.1	2

### B. Meninges

Brains	sIRM ( $\mu\text{Am}^2/\text{Kg}$ )	Concentration (ng/g)	# of Sub-samples
1 (Normal)	2.5 $\pm$ 1.8	54 $\pm$ 39	8
2 (Normal)	2.5 $\pm$ 1.5	54 $\pm$ 33	8
6 (Alzheimer's Disease)	5.0	109	1

## Fickle fields: EMFs and epidemiology <sup>11/91</sup>

The inexact science of epidemiology once again has tangled with the fickle phenomenon of electromagnetic fields (EMFs) as researchers try to gain a clearer picture of whether living near power lines and using electric appliances may increase the risk of cancer. A new EMF study—involving more people and more reliable exposure estimates than any such effort in the past—indicates that the risk of childhood leukemia correlates with the location of power lines, but not with the measured strength of electric and magnetic fields.

Researchers at the University of Southern California in Los Angeles examined the arrangement of power lines near residences and used this information to estimate children's EMF exposures. They based their exposure estimates on a controversial model developed for a study conducted in Denver in 1979 (SN: 4/21/79, p.263). In the Denver wiring model, underground power lines receive the lowest exposure rating, while certain aboveground configurations receive the highest rating.

Of the four studies that have used the Denver model so far, this is the third to suggest a link between childhood leukemia and power lines.

The new study is the first, however, to take 24-hour measurements of EMFs inside children's bedrooms, in addition to EMF measurements around the home. The investigators were surprised to find "no consistent association" between leukemia risk and these direct measurements, says principal author Stephanie J. London. This finding hints at the potential importance of other EMF factors, such as the field's direction, frequency and degree of fluctuation, she suggests.

Focusing solely on EMF magnitude, she says, is "sort of like going to the symphony and grading it just on how loud the music was."

London's team directly measured EMF strength in and around the Los Angeles County homes of 164 children with leukemia and 144 healthy children, finding no correlation with leukemia risk. But when they used the Denver wiring model to assess EMF exposures in an expanded sample of 219 children with leukemia and 207 healthy children, they found that the children with the highest estimated exposures had double the leukemia incidence seen in children with the lowest estimated exposures, the group reports in the Nov. 1 *AMERICAN JOURNAL OF EPIDEMIOLOGY*.

A number of epidemiologic studies have turned up statistical links between EMF exposure and various cancers, although scientists have yet to establish whether EMFs actually have any health

effects (SN: 9/28/91, p.202). David Savitz of the University of North Carolina in Chapel Hill says the new findings add to the evidence suggesting that EMFs cause cancer.

They also dovetail with a Denver study he led in 1986, he notes. London's study "remedied some of the deficiencies that were in our study and found a surprisingly similar pattern of results," Savitz says. "The inherent association with wiring configuration seems to remain."

London emphasizes that her study—funded by the Electric Power Research Institute, the research arm of the electric industry—is far from conclusive. The observed association could stem from unidentified leukemia risk factors, possibly related to lifestyle or educational level, she points out. In general, families living in neighborhoods with underground power lines are more affluent than those living near aboveground power lines, she says.

London also notes that the Denver model may not reflect the wiring configurations used in Los Angeles. She hopes to develop a southern California wiring model to use in further investigations. If such investigations show a weaker association between power lines and leukemia, she says, they will cast doubt on the validity of the recent findings.

Her team also analyzed data from questionnaires asking parents if their child had routinely come in contact with any of 15 household appliances. For two of these items—electric hair dryers and black-and-white televisions—the researchers found a statistically significant association with leukemia incidence. Hair dryers produce substantial EMFs, and thus could be an important contributor to EMF exposure in the home, London says.

Last year, however, in the only other EMF study to investigate that appliance, Savitz found no association between hair dryers and childhood leukemia. His study did not include televisions.

London notes that parents of seriously ill children, compared with parents of healthy children, may recall more details about potentially risky exposures in the child's past—a tendency that could skew research findings.

Without any solid evidence that EMFs contribute to cancer risk, London discourages people from tossing out their hair dryers just yet. "There are so many public health messages that people get that can change every week because they're not based on solid science," she says. "I think this [appliance-leukemia correlation] is one of those."

— K. Schmidt

# ELECTRONIC STIMULATION of the BRAIN

by  
M. D. Saunders  
Pyramid Research Center



In the course of decades of research, it has been discovered that all your brain's functions are susceptible to electrical control. In fact, your brain is more manageable by electronic manipulation than by chemical means. Using current technology, a direct interface between human brains and electronic devices is now possible for manipulative purposes? During the 60's, Dr. Jose Deigado experimented extensively along these lines with chimpanzees and other animals. Equipped with stimocivers to telemeter brain wave activity, chimps were monitored automatically via an on-line analog computer. Each time a certain burst of brain wave activity appeared, the computer was instructed to activate via radio signals an implanted stimulator in the reticular formation of the chimp's brain. After 2 hours of computer to brain monitoring and control, the undesirable brain wave activity was reduced to 50%. After 6 days of daily 2-hour periods of such brain/computer feedback, the specific cerebral activity and corresponding undesirable behavior was reduced to only 1% of its normal occurrence. Hence the chimp became quieter, less aggressive and less motivated to aberrant, unstable behavior.

To demonstrate remote, radio-controlled stimulation of brain implanted electrodes, Deigado once stopped a charging bull that was in full gallop toward him. He simply turned off the bull's aggressive rage with the flip of a switch. The limbic lobe, which governs certain emotional and temperamental functions seems perfectly acceptable to such on-off stimulation. To illustrate the safety and usefulness of this form of psychosurgery in humans, the procedure was used in specialized medical centers around the world to help thousands of patients suffering from epilepsy, chronic pain, anxiety neurosis and other cerebral disturbances. In some cases, the brain implanted electrodes remained inserted in the human skull for

up to 2 years with excellent tolerance. In a few cases where contact leads were located in pleasure centers, patients had the opportunity to stimulate their own brains by pressing a button on a portable instrument (read *Physical Control of the Mind* by Jose M.R. Deigado, M.D.). The feelings of heaven or hell could actually be self-controlled by the simple press of a button!

Today, technology has graduated from the primitive brain implants and subcutaneous transceivers of the 60's and 70's to surface electrodes via specially fitted collars over specific brain areas. By using the proper frequency, almost any emotional state can be created. For those in a depressive stupor, such a technique could be quite helpful if such technology were allowed to be used. Instead of killing and incarcerating our sociopathic criminals, this could offer a remedial alternative. Electronic shock collars for dog training are only crude examples.

Some people think that sophisticated brain implants are still being used in some people's heads today, and without their knowledge! Some have even claimed to have had them surgically removed. How did they get there? Were they placed there during normal hospital visits? Were they placed there during the periods of inexplicable losses in time that some people have occasionally experienced? Could the UFO flap as a possible explanation to such lost time occurrences really be only a contrived cover-up to divert suspicion from the powerful human groups that are taking control of world populations? Nah, that couldn't happen, could it? Zoologists routinely track wide-ranging albatrosses and other birds via satellite that have been fitted with tiny electronic devices. Couldn't people be just as easily monitored?

For some time now, technology has been tracking along the lines of mass control over the preponderantly unconscious population through microwave directed ELF (extremely low frequency) waves. (Disruption to motor functions & disease proliferation have already been suspiciously linked to extremely low frequency (ELF) electromagnetic pollution.) Is there a carefully designed threat to world populations on a massive scale? According to the research of Lieutenant Colonel Thomas E. Bearden (USA, ret), Dr. Andrijah Puharich and others, the answer is yes, there is a current threat! How is it accomplished? Jose Deigado's most recent work has been in the area of affecting human behavior with no electrode contacts at all, but by simply bathing people

in certain electromagnetic fields of ELF intensity (Omni, Feb. 1985). Brain neurons simply accommodate their synaptic firing rate to synchronize themselves with the applied ELF pulses, much like a child sleeping with his mother will begin breathing at the same rate as a parent. This is called entrainment.

Our bodies are sheathed with their own electromagnetic fields and they are easily affected by external electromagnetic energies. For instance, when we move to a new location, our bodies eventually harmonize and adjust themselves to the vibrational fields of the new place in a process called biological entrainment. Jetting to a new location suddenly throws your body out of electromagnetic synch, but bathing yourself in the electromagnetic light of the sun and keeping yourself quiet for a while allows the effects of jet lag to dissipate while your body's electromagnetic energies acclimate themselves. That's also why it is more advisable to eat vegetables, fruits and honey produced near your location than away from it to obtain the same compatible vibrations. In this way, you can maintain more balance within your body with less disruption to its overall functions.

Normally, the brains of mammals in a wild habitat are gently entrained by the normal oscillations of the earth's magnetic field (7.8 to 8.0 cycles per second). To accomplish effective brain wave entrainment on an unsuspecting human population, continuous bombardment of specifically directed ELF radiation at a certain frequency with sufficient amplitude can phase-lock a large percentage of their unconscious brains into forced oscillation to a specific signal modulation. Working like an organic computer virus, the ideas of death, disease or even unstable emotions all can be transmitted along these modulate carrier waves to result in the desired behavioral effect. For instance, ELF fields of 6.78 Hz to 6.26 Hz and lower tend to produce symptoms of confusion, anxiety, depression, fear, mild nausea and headaches, insomnia, hemispheric desynchronization, etc.

Panic within a stampeding crowd from a burning building is a good example of brain wave entrainment to a fear behavior en masse. If you are prone to such behavior, you need to practice being more individually conscious about your environment and less helpless about each unexpected event. You can be a conscious thinking individual if you want to be. What about the human rights issue? Is it ethically right to induce behavioral changes in human beings without their conscious consent? What if the above methods

were used to impart love, peace, compassion, charity and happiness to recipients? (Magnetic oscillations of 7.8 and 8.0 Hz produce anxiety-relieving and stress-reducing effects.) Unfortunately there seems to be a curious antipathy in the U.S. to depriving unstable people of their inalienable right to be irresponsibly unstable?! Confusion and indecision over what pattern of behavior should constitute the desired norm to follow has resulted in allowing unstable personalities to do whatever they want to do, even if it jeopardized the safety of others.

Emotional instability in the U.S. is simply considered acceptable until it violates the law. Then incarceration in mental hospitals and prisons is the punishing treatment wherein both institutions are kept glutted to the hilt, and with little rehabilitation offered in either. Repeater rates of 60-80% for prison inmates reveals how ineffective current criminal treatment methods have been. Mental hospital treatment varies from electric shock "therapy" to tranquilizing patients with various chemical drugs. This keeps the owners of pharmaceutical companies wealthy, but these treatments also do little to rehabilitate or produce functional citizens once again, just vegetating ones.

Since crime and emotional instability are rising to unprecedented proportions in the U.S., something massive will eventually have to take place to correct it. Current measures are simply not working. Perhaps the 1984 Orwellian scenario is just a little late?! Or is it already upon us? Have mind manipulative techniques been purposefully used to guide, produce and proliferate the bizarre, unstable behavioral patterns so prevalent in U.S. citizens today so that Federal intervention or massive coercive control measures will eventually have to be implemented? Then again, why bother if so many people are making such a fine living off their bizarre behavior — in treating their mental and physical health problems, in supplying them with legal and illegal drugs, in maintaining their pesticide impregnated foods and in loaning them lots of money to keep the downhill spiral toward gut oriented dependencies going.

If the rehabilitation of criminal behavior is really the intent of our penal system, shouldn't current technology be implemented to assist in the process? Doesn't it look obvious that certain controlling groups are purposefully steering civilization to confusion and chaos, and away from order and productivity?! When something is not working for the good of the people in a democracy, you change it to allow it to work.

## M A T R I X I I I

### Electromagnetic Radiation Effects Extracts

A properly modulated signal can interfere with brain activity. (S.M. Bawin, R.J. Gavalas-Medici, and W.R. Adey, "Effects of Modulated UHF Fields on Specific Brain Rhythms", *Brain Research*, Vol 58, (1973): p365-384)

The microwave signals beamed at the American Embassy in Moscow were in the low  $\mu\text{W}/\text{cm}^2$  range - on an average between 2 and  $10\mu\text{W}/\text{cm}^2$  in power density. (Nicholas H. Steneck, "The Microwave Debate", (1984) Massachusetts Institute of Technology, Halliday Litho, p.185)

The Environmental Protection Agencies monitoring program revealed that general population exposure ranges between  $1\mu\text{W}/\text{cm}^2$  and  $100\mu\text{W}/\text{cm}^2$  (Steneck, p231)

The fact that general population exposure to RF radiation is generally at low levels for long periods of time strongly suggests that the focus of scientific experimentation should be chronic, low-level studies. High-level ( $10\text{mW}/\text{cm}^2$ ) and above thermal experiments have little relevance to the general population. (Steneck, p.231)

ANSI Standard C95.1-1974  $10\text{mW}/\text{cm}^2$   
ANSI Standard C95.1-1966  $10\text{mW}/\text{cm}^2$   
ANSI Standard C95.1-1982  $1\text{mW}/\text{cm}^2$  from 50-500MHz  
Military-Industry Std.  $5\text{mW}/\text{cm}^2$  at 500MHz -  $10^3\text{Hz}$   
(Steneck, p237)  $5\text{mW}/\text{cm}^2$  from  $10^3\text{Hz}$  to  $10^5\text{Hz}+$   
 $10\text{mW}/\text{cm}^2$  at 10MHz  
 $100\text{mW}/\text{cm}^2$  below 10MHz

C95 activities are coordinated by the Navy and IEEE  
(Steneck, p238)

Roughly two out of every three C95 members setting the 1982 standards represented military or industrial interests. Many of the scientists who advised during the standard-setting process, including C95.IV chairman Arthur Guy, were funded by the military. (Steneck, 238-9)

MIT recommendations: 1) Eliminate military influence on RF bio-effects research, 2) Exercise congressional responsibility and 3) Encourage public involvement (Steneck, p240-243)

(The ANSI standards are set) from the assumption that the only effect RF radiation has on living tissue is heating. They attempt to estimate the point at which RF radiation adds more heat to the body than the body can normally dissipate  
(Steneck, p39)



## M A T R I X I I I

The Tri-Service Research program funded Sol Michaelson at Rochester University in 1956-1957 to study non-ionizing radiation bioeffects. Michaelson's group presented some evidence that high-level, short-term effects could be duplicated by lower-level, long-term effects, suggesting that the critical factor in considering effects (E) might not be incident energy (I) alone, but incident energy times exposure duration (T), or  $E=IXT$  (Stenck, p39-42)

No evidence was advanced in the Tri-Service Research program which supported the assumption that there was a threshold power level below which hazards or effects would not occur, no matter how long the exposure period. The thermal solution was not above question (Steneck, p.42)

As logical as the thermal solution to the RF bioeffects problem seemed, it was not based on the sort of critical reasoning that is supposed to typify the scientific method. It is commonly argued that because thermal effects disappeared below some threshold, all effects must disappear below that threshold. This conclusion would follow if it were known that there could be no effects other than thermal effects. (Steneck, p43)

In 1956, The General Electric Company initially set  $1\text{mW}/\text{cm}^2$  and Bell Labs adopted a safety standard of  $0.1\text{mW}/\text{cm}^2$  (Steneck page 51), until they were "convinced" to relax their standards by the Tri-Service program, in order to provide continuity and support for the military view. (General Electric Technical Information Series, Schenectady, New York, 1956; W. Mumford, "Hazards to Personnel Near Power UHF Transmitting Antennas," Project Report 717, Bell Laboratories, New York, 1956)

ANSI does not set standards. Its role in standard setting is that of a facilitator or mediator. ANSI officials will, if requested, determine the need for standards and ask organizations or individuals to develop them. The standards ANSI publishes are simply standards developed by one or more sponsoring organizations and subsequently voluntarily adopted by the community of users. (Steneck, p55). The sponsoring organizations for the RF radiation standard were the U.S. Navy and the IEEE.

The standard of  $10\text{mW}/\text{cm}^2$  and subsequent ANSI standards were developed to ensure the continued progress of military and industrial R&D programs. Professor Schwan, the originator of the  $10\text{mW}/\text{cm}^2$  standard, thought of the bioeffects issue strictly in thermal terms. He knew of no mechanisms that could account for sensitivities to very low energy flux. (Sten.p.60)

In July 1958, Safety Regulations for Personnel in the Presence of Microwave Generators (USSR) set exposure at

## M A T R I X I I I

0.01mW/cm<sup>2</sup>, also written as 10uW/cm<sup>2</sup>, 1000 times below the U.S. Military/ANSI standard of 10mW/cm<sup>2</sup>. (Steneck, p63) (Turner, John J., "Effects of RF radiation on the Human Body", U.S. Army Ordnance Command, Bell Telephone Labs, New Jersey (1962) pp.1-9)

In the United States, the word HAZARD came to mean "demonstrable and irreversible physiological harm". Soviet standard setters regarded discomfort as a significant enough health effect to be classed as a hazard and used as a basis for setting standards. (Steneck, p64)

In 1969, a Symposium was held in Richmond, Virginia, in which steps for setting a standard were offered by a well-known Czech scientist, Karel Marha. He stated that visits to areas with diverse applications of EM radiation turned up the symptoms of pains in the head and eyes, fatigue connected with overall weakness, dizziness, and vertigo. (Karel Marha, "Maximum Admissible Values of HF and UHF Electromagnetic Radiation at work places in Czech.", in *Biological Effects and Health Implications of Microwave Radiation*, (1970), p188-191)

U.S. scientists have consistently objected to the use of cumulative models in setting standards, primarily because they have yet to be convinced that there are long-term cumulative effects. Instead, they have relied on some type of short term thermal model for setting standards (Steneck p66)

The US standard, at every stage of its development, was significantly influenced by subjective factors. The dominance of the thermal model was the product of bureaucratic decisions that vested control of standard setting in the hands of a few key individuals, notably Knauf, Schwan and their successors. (Steneck, p67)

"It seems likely that neural function, and therefore behavior, are indeed disturbed by low intensity microwaves...The behavioral studies consistently and repeatedly report that human beings do exhibit behavioral disturbances when subjected to low intensity microwaves." R.J. MacGregor, Rand Corporation, Santa Monica, California, September 1970 (Steneck, p69)

109mW/cm<sup>2</sup> Power Density: Researchers of the University of Miami School of Medicine reported that behavior could be altered in animals by exposing them to as little as three daily 15 to 30 minute exposures at this density. (Steneck, p81)

64mW/cm<sup>2</sup> Power Density: U.S. National Institute for Neurological Diseases exposed primates head region and could induce arousal and relaxation cycles. Death could be induced in as little as 2 minutes and 55 seconds. (Steneck p82) (S.A.Bach, M.Baldwin, and S.Lewis, "Some Effects of UHF Energy

## M A T R I X I I I

on Primate Cerebral Activity", TS-III (1959), p.83)

Allan Frey, while working at the GE Advanced Electronics Center at Cornell University, discovered that people can sense when they are being subjected to microwave radiation. Even some deaf people could hear microwaves, and even at very low power levels, as low as  $0.065\text{mW}/\text{cm}^2$  ! (A.H. Frey, "Auditory System Response to RF Energy", Aerospace Medicine, Vol32 (Dec 1961): p1140-1142)

An article by A.S. Pressman in the USSR reported that pulsed radiation affected heartbeats at power levels as low as  $3\text{-}5\text{mW}/\text{cm}^2$  (A.S.Pressman and N.A.Levitina, "Nonthermal Action of Microwaves on the Rhythm of Cardiac Contractions", FTD, WPAFB, June 1962)

Following the UCLA Conference on Neurological Responses To External Electromagnetic Stimuli on July 11, 1963, the military, which controlled RF bioeffects research money and policy decisions, downplayed non-thermal effects of RF radiation. Open contracts were no longer awarded and efforts were made to keep information about central nervous system research from circulating too widely. Privately, the military and the State Department began work to try and determine the possibility of exploiting the non-thermal effects of RF radiation for espionage and military purposes. The primary motivation for the work was a desire to find out the purpose of a beam of microwave radiation that was being directed at the U.S. Embassy in Moscow. (Steneck, p88-89).

With the Moscow signal, the State Department and the military learned that they were dealing with a low intensity modulated signal of  $0.1 - 24\text{uW}/\text{cm}^2$ . (Project Pandora USDS, declassified on May 20, 1981).

A paper read at the American Institute of Biological Sciences in Boulder, Colorado in August 1964 reported finding altered blood serum counts with exposure to as little as  $10\text{mW}/\text{cm}^2$  of RF Radiation. (B.L. Herndon, M.A. Giagle, and J.J. Downs, "Biological Effects of Microwave Radiation," presented at the AIBS meeting, August 26, 1964.

In August 1965 a biophysicist at Northrop Space Laboratories in California prepared a technical memorandum, "Biological Entrainment of the Human Brain by Low-Frequency Radiation," in which he stated that it was possible to alter the biological clock of the body by subjecting it to specific electromagnetic fields. A copy of this paper made its way into the files of the acting director of the Advanced Sensors program at the Advanced Research Projects Agency (ARPA), Richard Cesaro, who was responsible for initiating Project Pandora, which investigated ways of inducing subtle behavioral changes in humans with low-level electromagnetic fields that could direct a person's mind. (R.S.Cesaro,

## M A T R I X I I I

"Program Plan No. 562, Pandora," Advanced Sensors Program, ARPA, October 15, 1965; R.S. Cesaro, memorandum, "Justification Memo for Pandora, ARPA, October 15, 1965; E.V. Byron, "Operational Procedure for Project Pandora Microwave Test Facility." Johns Hopkins Applied Physics Laboratory, October 1966; Final Report, November 1966.)

Cesaro, as a result of Project Pandora, stated that since effects could be found at exposure levels below  $10\text{mW/cm}^2$ , there was an obvious need to "overhaul U.S. microwave radiation standards...to take account of the non-thermal damage potential." (Cesaro, "Initial Test Results," December 20, 1966, pp2-3);

Under Project Pandora, the subject (a primate) was exposed 10 hrs per day. On the thirteenth day, the animal appeared to stay in a deep sleep. (Steneck, p109)

By October 1966, reports from Moscow put the signal power density at  $0.5 - 1.0\text{mW/cm}^2$  and in the low GHz frequency band. (Steneck, p.108)

In September 1967 Jo Johnston of the CIA observed in a memo summarizing the early results of Pandora, "For the record it should be noted that all the positive findings were achieved one half an order of magnitude below the accepted U.S. standard for safe exposure." ( Steneck, The Microwave Debate, MIT, 1984, p 117)

During the 1967-68 congressional hearings on radiation control, the lawyer for Raytheon, who makes microwave equipment, stated the military-industrial position: "(1) The biological effects of microwave energy are thermal (2) The effects are non-cumulative (3) Man has a built-in alarm system coupled with his threshold of pain that protects him from thermal injury." A different point of view was presented by the person who had been instrumental in setting the  $10\text{mW/cm}^2$  standard, Herman Schwan, who said that "there was not enough evidence to limit RF bioeffects solely to thermal mechanisms, and there is a possible danger of genetic damage."

(U.S. Senate, Committee on Commerce, Radiation Control for Health and Safety Act of 1967, Hearings on S.2067, S.3211, and H.R.10790, 90th Congress, 1st, 2nd sess, 1967-1968, p.2)

Herman Schwan and other scientists have suggested that by the time heat is felt internally, the tolerable level has been exceeded. (Stenck, p154)

On October 18, 1968, President Johnson signed the Radiation Control for Health and Safety Act of 1968 into law. Also known as Public Law 90-602. It dumped the entire radiation problem, RF bioeffects included, into the lap of the secretary of Health Education and Welfare (HEW). Little guidance was given. Public protection was not defined. No

## M A T R I X I I I

specific problem areas were at all identified. (Steneck, The Microwave Debate, p.126)

By 1970, concern over lax rules led Congress to pass the Occupational Health and Safety Act (OSHA). On July 1970, Nixon centralized responsibility for pollution in the newly created Environmental Protection Agency (EPA). The EPA governs the RF pollution problem in the environment (Steneck, p.127)

The EPA has not yet set general population exposure standards. (Steneck, p135)

In July 1970, Arthur W. (Bill) Guy took over the chairmanship of C95.IV, which was supposed to review the exposure standard. He set up five groups to "identify and document the requirements for additional information needed to modify or improve the standards". The five groups were chaired by Raytheon, Ark Electronics, the U.S. Information Agency, Randomline, Bell Telephone, and the Bureau of Radiological Health. The majority of these ANSI members were not willing to take steps that would have provided incentives to expand the base of RF bioeffects research. (Steneck, p150).

The current philosophy of ANSI relative to RF radiation is that the military and other users of RF equipment are not compelled to do population studies to determine negative effects, or tell exposed populations that they do not have the evidence to guarantee safety. Industrial RF equipment owners do not have to run biological assay tests before subjecting workers to it. ANSI does not have to be sure of its scientific information before issuing a standard. Milton Zaret wrote a brief letter to ANSI members in April of 1970, proposing these changes, but it was rejected as not being in the interests of the military-industrial complex. Had Zarets proposed reworking of C95.1 been accepted, it would have changed ANSI's philosophy of standard setting and thereby the accepted protocol for RF bioeffects research. This is the course most RF bioeffects research would follow throughout the remainder of the 1970's and into the 1980's. (Steneck p150-152)

To reject arguments on the basis of the ANSI standard and not on the basis of scientific evidence represents a classic exercise in circular reasoning. (Steneck, p163).

In September 1978, Arthur (Bill) Guy signed a contract with the Air Force to do a long-term, low-level RF bioeffects experiment. Plans called for running tests on 200 pathogen-free rats (100 exposed and 100 control) from shortly after birth until death. The full project was slated to run 6 years and cost \$2 million. By late 1979, Guy's research team began reporting on the experimental procedures. It was well known by this time, as Guy himself had argued, that behavioral measures were the most sensitive indicator

## M A T R I X I I I

of RF bioeffects. Guy, however, made no mention of behavioral measures when he published a plan for the full study in the Jan issue of the IEEE Proceedings. The conclusion was that behavioral measures were being ignored. This omission troubled independent researcher Allan Frey, who had been studying behavioral and neurological RF bioeffects for over 20 years. Guy stated that he "did not select the criteria for the study...it was selected in the statement of work disseminated by the Air Force." In other words, Guy deflected Freys criticism by shifting the responsibility for planning from himself to his Air Force sponsors "Why," Frey queried in a follow-up comment, "did Guy take on a project which involved the expenditure of approximately \$1.5 M of public funds with the known crucial tests ruled out by the sponsor? Is this science?" (Steneck, p166-168)

Interestingly, the following appeared in an article entitled "Electromagnetic Radiation: A Growing Hazard", Let's Live Magazine, April 1986:

" Arthur W. Guy of the Biomagnetics Research Lab at the University of Washington, has exposed 100 rats to electro magnetic pulses equivalent to or lower than the current voluntary U.S. standards. After three months, the animals were in a state of heightened immune system stimulation, often resulting in impaired adrenal function and development of tumors. A 1984 EPA summary document corroborated this link between RF radiation exposure and immune system problems, reporting negative changes in blood count, immunity, and overall health due to RF exposure.

"Some scientists interpret these results to mean that non-ionizing radiation is a source of "non-specific stress". Significantly, Dr. Guy's laboratory animals also showed a fourfold increase in cancer when compared with a control group of rats. In humans, brain cancer is more prevalent among those exposed to non-ionizing radiation."

A George Washington University researcher, Ernest Albert, found that 10mW/cm<sup>2</sup> radiation caused blood-brain permeability problems. Kenneth Oscar and Daryl Hawkins, two U.S. Army bio-medical researchers, came up with similar results. These effects posed problems, particularly if they occurred at exposure levels below 10mW/cm<sup>2</sup>. These reports prompted the U.S. Navy to convene a conference in October 1978. All the researchers who had done the research were present. The format called for the presentation of papers, discussion and then a final summary by Don Justesen, a psychologist at a Kansas City Veterans Administration Hospital, who was given this important task even though he personally had not done any blood-brain barrier research. (Steneck, p171)

## M A T R I X I I I

ANSI standards have never set criteria for judging "harmful to human health", even though explicit and implicit assumptions about safety are made. (Commissioner Horsley, RCA Uplink case, Bainbridge Island, Washington, 1982) (Steneck, p217).

"What is important from a public policy perspective is the degree to which a broad segment of the affected populace perceives that they and their children are at risk". (Same case)

In situations where the safety issue cannot be resolved fully, as indeed it may not be in the RF bioeffects area, public opinion must be taken seriously in judging the significance of risk because the local residents, and not industry, are the ones who will suffer any adverse consequences. It is the public that is potentially at risk. (Same case)

Commissioner Horsley was the first person in the RF bioeffects field to venture publicly into the area of assessing the significance of risk. (Steneck, p.217)

*Some Preliminary Extracts of Scientific Literature  
On Effects of Microwaves and Radio Frequencies (including UHF)  
On Biosystems - Prof. Cyril W. Smith (England 1989)*

Dr Mays Swicord of the FDA in Rockville Maryland proved through research that DNA absorbs microwaves on the 1-10GHz frequency band. The DNA Helix oscillates in resonance with micro-wave radiation. (Microwave News, 1987, July/August)

Chemists led by Dr. Robert Birge (1987) at Carnegie-Mellon University, in Pittsburgh, showed that retinyl Schiff base salts, similar to rhodopsin- the molecule basically for vision- absorbs specific frequencies of RF and MW radiation. (Microwave News, 1987, September/October). MW radiation has been demonstrated to have a part to play in cataract formation.

Field Enhancement Effects: A field generated by microwaves and its associated electromagnetic radiation is unperturbed until an object (human, building, etc) comes within the field. The field is then perturbed (called field enhancement) and this can raise the field strength considerably, particularly around the head. Field strength in a unperturbed field increases several hundredfold when perturbed. Therefore, field strength measurements of unperturbed fields do not give a true picture of the damage that is caused when humans are actually within the field.

## M A T R I X I I I

Damage from non-ionizing and ionizing radiation alike is long-term and cumulative.

In the United States, Dr Milton Zaret in Scarsdale, New York is probably the worlds leading researcher of ocular effects, especially cataracts, in RF and MW-exposed personnel. Zaret has described a specific 'microwave caratact' which originates in the elastic membrane that surrounds the lens of the eye. According to Zaret, exposure to either thermal or non-thermal radiation can cause microwave cataracts. (Zaret, M.M. (1988), "Electromagnetic Energy and Cataracts" in Modern Bioelectricity, ed. Marino, A.A., New York: Marcel Dekker, Ch.24); (Zaret, M.M. (1977), "Potential Hazards of Hertzian Radiation and Tumors", New York State Journal of Medicine, 1977, page 146-7).

Cyril Smith has studied cataractogenesis and was able to show that highly coherent radiation, including weak microwave radiation, can exert a cataractogenic effects, particularly if the residual modulation on the microwaves satisfied magnetic resonance conditions in the ambient magnetic field. (Effects of Coherent Excitations in Biological Systems) (Smith, C.W., Marsh, P.N and Croft, L.R. (1985), "Microwaves", University of Salford, England, Supplement, September 8-9); (Smith, C.W. and Baker, R.D. (1982), "Environmental Power-Frequency Magnetic Fields", Health Physics; 43(3), P439-441).

At the 1986 Chinese Scientific Conference on BioMagnetics, held in Hangzhou in October 1986, Dr, Chiang Huai discussed research which pointed to significant effects of weak microwave emission on fetal development and also the synergistic effects of micro-wave radiation. (Microwave News, 1986, November/December, p.6)

There is very sharply defined resonance condition whereby energy can be inserted into a living system. Microwaves can act as a carrier able to deposit the nuclear magnetic resonance frequency as the microwave modulation signal within tissue, where the non-linearities would demodulate it. This aspect of magnetic resonance in living tissue increases the risk of disease and damage to the immunological system. (Aarholt, E., Jaberranski, M., Jaffary-Asl, A.H., Marsh, P.N. and Smith, C.W. (1988) "NMR Conditions and Biological Systems", in Modern Bioelectricity, (ed) A.A. Marino, New York: Marcel Dekker, Ch.4, pages 75-104).

Exposure to microwave and ELF fields can cause birth defects (McAuliffe, K. (1985), 'The Mind Fields' OMNI, Feb, 7(5) 41-4, 96-104)

Electrically sensitive people react to frequencies in most parts of the non-ionizing spectrum. (Smith, C.W., Best, S. (1989) Electromagnetic Man, St Martins Press, New York, page99



## M A T R I X I I I

Non-ionizing radiation (NIR) exacerbates the effects of Ionizing radiation. (Tumanyan, M.A. and Samoilenko, I.I. (1983), "Influence of Alternating Magnetic Fields on the Bacteriocidal Effect of Ionizing Radiation", Radiobiology, 23(3), p415-419.)

The generally proposed 10mW/cm<sup>2</sup> EMR exposure limit created by Professor Herman P. Schwan, a former Nazi scientist who entered the United States in 1947 under Project Paperclip, was created in 1953 using metal balls and flasks of salt to simulate the human body. With little debate or experimentation, industry and the military had by 1957/8 accepted the level as an informal guideline. No one tested for thermal effects, which were thought not to occur. In 1965, the Army and Air Force adopted the 10mW limit, and in 1966 ANSI adopted it as an occupational exposure guideline (though not for the general public). The ANSI decision is remarkable since Schwan consistently maintained that his dosage limit was safe for probably no more than an hour. (Becker, R.O., and Selden, G. (1985), *The Body Electric*, New York: Morrow); (Schiefelbein, S. (1979), "The Invisible Threat. The Stifled Story of Electric Waves", *Saturday Review*, 15 September, p16-20).

There were persuasive economic reasons why the 10,000-microwatt [=10mW/cm<sup>2</sup>] standard was and still is defended at all costs. Lowering it would have curtailed the expansion of military Electromagnetic Research and cut into the profits of the corporations that supplied the hardware. A reduced standard that was safe would constitute an admission that the old one was unsafe, leading to liability for damage claims from ex-GIs and industrial workers.

U.S. Government studies of the microwave irradiation of the Moscow embassy from 1963-1975 and in 1988 yielded the following frequencies and field strengths ( all of which are many times lower than the ANSI standard ): 1963-1975 ,2.56-4.1Ghz at 5uW/cm<sup>2</sup> ; Jan 73 and Aug 75, 2.56-4.1Ghz at 18uW/cm<sup>2</sup>; March 1988, 9-11Ghz at .01uW/cm<sup>2</sup>. (Microwave News, 1988 March/April)

In 1965, a classified project, Project Pandora, was initiated through funding at the Walter Reed Army Institute of Research to "investigate possible behavioral and bioeffects on primates when irradiated with microwave signals simulating the exposure of Embassy employees in Moscow (US Senate, 1979). The signal intensity was set at 4-5mW/cm<sup>2</sup>. No comprehensive report was ever prepared and parts of the record were ordered destroyed in September 1973, about two years after the project was terminated.

The Soviet Unions standard exposure limit is 1,000 times below the U.S. Standard: 10uW/cm<sup>2</sup>.

Dr Stanioslaw Szmigielski, internationally known for his

M A T R I X I I I

work on Radio Frequency and Microwave radiation effects on the immune system, and his colleagues at the Center for Radiobiology and Radioprotection in Warsaw, Poland, have produced results that support a link between cancer and exposure to RF and microwave radiation. (Microwave News, 1987, January/February).



0385

# 11. Interactions with the Nervous System

## 11.1 Central Nervous System

### 11.1.1 Introduction

Absorption of RFEM energy is often associated with elevations of temperature in the absorbing material. For most mammalian tissues, this added thermal burden may amount to 70 percent or more of the metabolic heat production (1 to 3 W/kg) before a significant rise in tissue temperature occurs ( $>0.1$  °C), due to efficient heat removal by adaptive physiological mechanisms that characterize endothermic species (see Section 15). Secondary effects of RFEM fields attributable to elevated temperature have been well categorized and in general differ little from effects of hyperthermia induced by other means (Presman, 1968; Michaelson *et al.*, 1975). However, it is now clear that some tissue interactions with RFEM fields that produce temperature increments orders of magnitude less than  $0.1$  °C result in major physiological changes that cannot be attributed to elevated temperature *per se*. The need for quite different models of transductive coupling of these weak fields relates to "windows" in frequency and incident energy, which characterize these interactions in brain and some other tissues, and to the very weak oscillating electric gradients in tissue shown to be effective in modifying cell functions by mechanisms that appear to "amplify" the triggering field. These amplification mechanisms may be based on nonequilibrium processes, with long-range, resonant, molecular interactions. They are in the class of "cooperative" processes and have been widely recognized as important in immunological and endocrine reactions, as well as in neurobiological excitation. A strong presumptive site for their occurrence is at the surface of the cell membrane.

### 11.1.2 Observed Biological Sensitivities to Weak Environmental RFEM Fields

Biological effects of environmental oscillating electric fields are related to the electric gradient they induce in the tissue. This gradient

will be determined by the degree of coupling between the field and the tissues. At frequencies below 300 Hz, electrical gradients at the surface of a body in air will be determined by the capacitance to free space (Barnes *et al.*, 1967), which is a function of the body's mass and shape. This capacitance,  $C$ , far from ground, is:

$$C = 4\pi\epsilon_0 r, \quad (11.1)$$

where  $\epsilon_0$  is the dielectric permittivity of free space and  $r$  is the distance to the point of interest. For a spheroidal model, this equation gives a capacitance of 50 pf for  $r = 0.5$  meters. A typical value of specific impedance of brain tissue at ELF is  $300 \Omega \text{ cm}$  (Freygang and Landau, 1955). If the induced electric gradient were uniform throughout a body having the electrical characteristics of brain tissue (a reasonable assumption for order-of-magnitude calculations), the expected tissue gradient for a 10-Hz environmental field of  $10 \text{ V/m}$  would be only  $10^{-9} \text{ V/cm}$ . This value agrees well with a total current measurement induced by such a field in a model of a monkey head (Valentino, 1972).

However, to appreciate fully the relation of these weak tissue components of ELF fields to possible excitatory effects in brain tissue, it must be remembered that nerve cells are enclosed in an extracellular fluid with a conductivity  $\sim 1000$  times higher than that of the cell membrane. This fluid, thus, effectively shunts the cells it surrounds, providing a preferred pathway for field-induced currents. Extracellular fluid typically accounts for about 20 percent of the tissue volume and has a specific resistance from 4 to  $20 \Omega \text{ cm}$ . Membrane resistance per unit area for different types of cells (Coombs *et al.*, 1959) ranges from  $1000$  to  $5000 \Omega/\text{cm}^2$ . Thus, only  $\sim 1/1000$  of the induced extracellular current would be expected to flow through the cell membrane and, hence, to contribute directly to excitation of the nerve cell. For the 10-Hz,  $10\text{-V/m}$  field cited above, the total tissue current is of the order of  $10^{-8} \text{ A/cm}^2$ . The expected transmembrane component entering the cell would be a mere  $10^{-11} \text{ A/cm}^2$  for production of an impulse. Even though membranes of some nerve cells (in contrast to fibers) have been found two or three orders of magnitude more sensitive, there is a gap of about  $10^5$  between the magnitude of tissue components of these environmental fields and the usually accepted thresholds for excitation of nerve fibers. Nevertheless, evidence to be cited has shown that these weak-field gradients produce a variety of behavioral, physiological and chemical responses when they are within certain frequency and amplitude bounds.

A second class of windowed interactions with clear effects in brain tissue occurs in RFEM fields that are amplitude or pulse modulated at frequencies below 1000 Hz and particularly in the range between 1

0  
3  
8  
6

to 20 Hz. Unmodulated fields do not produce these effects. Here, the field coupling to tissue is much stronger, and, for body dimensions from 0.05 wavelength to lengths that approach resonance, energy absorption is proportional to the square of the frequency ( $f^2$ ) (Johnson *et al.*, 1977). For carrier frequencies between 150 and 450 MHz, behavioral and physiological effects have been observed under induced brain gradients in the range 10 to 100 mV/cm (Bassen *et al.*, 1977). For this band of carrier frequencies, gradients at these levels are induced in the brain of most mammals, including man, by incident fields at 0.1 and 1.0 mW/cm<sup>2</sup> (electric gradients in air approximately 19 and 60 V/m). These gradients have the same range of amplitudes as the intrinsic, low-frequency oscillations of the electroencephalogram (EEG) in brain extracellular fluid, when measured over the dimensions of a single neuron.

The search for "windowed" biological effects has centered on these two types of interactions; one involving direct interaction with low-frequency fields, and the other induced by RFEM fields amplitude modulated at low frequencies. Two "windows" have been detected, one involving ELF gradients of  $10^{-3}$  to  $10^{-8}$  V/cm, the other in ELF- or LF-modulated RF and microwave fields at  $10^{-1}$  to  $10^{-2}$  V/cm. A 50-V/m, 16-Hz field in air induces a tissue gradient of about  $10^{-6}$  V/cm, and tissue gradients of  $10^{-1}$  V/cm as induced by a 16-Hz field would require a gradient in air of 500 kV/m. It would thus be very difficult to achieve EEG-level gradients in tissue exposed to simple low-frequency fields (Bawin *et al.*, 1978b).

A wide range of effects has been reported in tissue components under environmental ELF fields between  $10^{-7}$  and  $10^{-8}$  V/cm. They include navigation and prey detection by sharks and rays, bird navigation, altered daily biological rhythms in man and birds, and subjective estimates of time by monkeys (Table 11.1). These sensitivities contrast sharply with the membrane potential of nerve cells. The "resting" potential is about  $10^5$  V/cm across the 4-nm dimension of the lipid bilayer or plasma membrane that forms the "backbone" of cell membranes. Excitation of nerve-fiber terminations (synapse) on the membrane's surface may depolarize it by about  $10^3$  V/cm. Thus, electric gradients in the fluid around brain cells ( $10^{-1}$  V/cm), with amplitudes approximately equal to those of the EEG, have usually been considered to have no role in excitation of brain neurons, and have been regarded merely as "the noise of the brain's motor." Recent evidence now strongly indicates a modulatory role for these fields, based on behavioral, neurophysiological and neurochemical evidence cited below. However, even these EEG-level tissue gradients are approximately six orders of magnitude greater than those associated with the behavioral effects listed in Table 11.1.

TABLE 11.1—Bioelectric sensitivities

Species	Function	Tissue gradient V/cm	Imposed field
Sharks and Rays	Navigation/Predation	$10^{-6}$	DC to 10 Hz
Birds	Navigation	$10^{-7}$	0.3 Gauss*
Birds	Circadian Rhythms	$10^{-7}$	10 Hz, 2.5 V/m
Monkeys	Subjective Time Estimation	$10^{-7}$	7 Hz, 10 V/m
Man	Circadian Rhythms	$10^{-7}$	10 Hz, 2.5 V/m
Cell and Tissue Neuroelectric Gradients			
	Membrane Potential	$10^5$	
	Synaptic Potential	$10^3$	
	Electroencephalogram	$10^{-1}$	

\* Equal to 30 microtesla ( $\mu$ T) in the international system (SI) of units.

**11.1.2.1 Behavioral Effects of ELF Fields.** There is strong evidence that sharks and rays navigate and detect prey by environmental electric gradients as weak as  $10^{-8}$  V/cm in the spectrum below 10 Hz (Kalmijn, 1974). Parker and van Heusen (1917) noted that nibbling responses in the catfish are elicited by a total current of approximately 1.0  $\mu$ A between two electrodes about 2.0 cm apart. Rays can be trained to seek a food reward in a circular tank in which the earth's magnetic field is an essential cue (Kalmijn, 1978). Calculated electric gradients in tissue based on the rate of the animal's movement through the natural magnetic field are 0.5  $\mu$ V/cm. These responses to movement faded out in magnetic fields weaker than the natural levels and were not observed in fields two orders of magnitude greater, indicating a magnetic-intensity "window." These low-frequency electric and magnetic perturbations are sensed by tubular electroreceptors that open on the skin of the head and are filled with a jelly-like substance. The walls of this ampullary canal have an extremely high resistance per unit area (6 M $\Omega$ /cm<sup>2</sup>) and the core of the canal has a low specific resistance (31  $\Omega$  cm). The canal, therefore, exhibits ideal cable properties for DC potentials and for low-frequency electric oscillations. The low-pass frequency characteristics of the ampullary system give it an effective upper-frequency limit of about 10 Hz.

Human and avian circadian rhythms are lengthened in shielded environments that exclude natural and artificial electric fields. These rhythms return toward a 24-h periodicity in the presence of a 10-Hz, 2.5-V/m, square-wave field (Wever, 1968, 1977). Monkeys exposed to

7-Hz, 10- or 56-V/m fields shorten subjective estimates of a 5-s interval by about 10 percent (Gavalas *et al.*, 1970; Gavalas-Medici and Day-Magdaleno, 1976). There was an apparent threshold for 7-Hz fields at strengths between 1 and 10 V/m, but similar fields at 100 V/m were without effect, again indicative of a windowed interaction. Similar trends were noted in independent studies at 45 Hz and were statistically significant in the first series of exposures, but not in the second (de Lorge, 1973, 1974). Measurements of induced currents in models were in general agreement with calculated tissue gradients of the order of  $10^{-7}$  V/cm in both circadian-rhythm and time-estimation experiments.

Although these data suffer from some difficulties in replication or in a lack of duplicate studies at this time, they show a general consistency in evidence of a tissue threshold between  $10^{-7}$  and  $10^{-8}$  V/cm for a variety of biological effects of ELF fields in fish, birds and mammals. There is also evidence to support some windowed interactions, with a decline in some responses for fields two orders of magnitude larger, a finding consistent with the electrochemical observations cited below.

**11.1.2.2 Neurophysiological Effects of Modulated RFEM Fields.** VHF or UHF fields at  $\sim 1.0$  mW/cm<sup>2</sup> (61 V/m) induce an EEG-level gradient in brain tissue and may be tested for effects on brain function, with and without ELF amplitude modulation at frequencies in the EEG spectrum.

A persistent component in EEG spectral analyses at the pulse repetition frequency (PRF) of a RFEM field following irradiation has been reported by Servantie *et al.* (1975). Under a 3.0-GHz field pulsed at 500 to 600 pps (1.0- $\mu$ s pulse width, average power density 5.0 mW/cm<sup>2</sup>), rats exposed for 10 d showed a distinct spectral peak in the EEG at the PRF, which waxed and waned in cycles lasting several minutes. Persistent EEG changes occurred for several days in rabbits after exposure for 2 h daily for 4 to 8 weeks to a 5.0-MHz field amplitude modulated at 14 to 16 Hz (Takashima *et al.*, 1979). Fields at amplitudes of 90-150 V/m enhanced EEG activity at 10 to 15 Hz, and 500 V/m fields augmented 4- to 5-Hz waves. Amplitude modulation at 60 Hz was without effect. No detectable heating of the brain occurred during these exposures.

Bursts of EEG waves occurring in various brain nuclei of the cat as conditional responses to a flash of light (and thus constituting a learned response) were more frequent in the presence of a 147-MHz, 0.8-mW/cm<sup>2</sup> field that was amplitude modulated at the same ELF frequency as the EEG burst (Bawin *et al.*, 1973). Moreover, in the presence of the modulated RFEM field, but in the absence of punish-

ment for failure to make a correct response (so-called "extinction trials"), the decline of performance to pretraining levels occurred slowly over 45 to 60 days. Without the RFEM field, extinction occurred in 5 to 7 days. Even though this study was performed with metal electrodes that contacted the brain, spectral analysis of EEG records between wave "bursts" disclosed no artifactual rectification of imposed fields at the brain-electrode interface.

**11.1.2.3 Windowed Responses of Calcium-Ion Binding in Brain Tissue to ELF, VHF and UHF Fields.** As discussed below, calcium ions are essential in transductive coupling of a wide range of immunological, endocrinological and neurobiological events at cell-membrane surfaces. The fluid surrounding cells contains 2.0 mM calcium, whereas typical concentrations in the general cytoplasm within cells are far lower, around  $10^{-4}$  mM. Effects of RFEM fields on calcium binding in cerebral tissue are believed to occur at cell membrane surfaces (Bawin *et al.*, 1978a). Calcium ions trigger their own release from intact cerebral cortex of cats in a highly nonlinear fashion, strongly indicative of a cooperative process (Kaczmarek and Adey, 1974). Weak oscillating electric gradients no larger than those of the EEG (50-100 mV/cm) increase efflux of calcium and the amino acid transmitter, gamma-aminobutyric acid (GABA), from cat cerebral cortex by almost 20 percent (Kaczmarek and Adey, 1973). These two findings have challenged accepted views that oscillating extracellular electric gradients as weak as the EEG play no part in neuronal excitability. This view is further challenged by the following evidence on RFEM-field sensitivity of brain tissue.

**11.1.2.3.1 Effects of Sub-ELF and ELF Fields.** Freshly isolated chick and cat cerebral tissues exposed to sinusoidal electric fields at 1, 6, 16 and 32 or 75 Hz (electric gradients in air of 5, 10, 56 and 100 V/m) exhibit a general trend toward a reduction in release of preincubated <sup>45</sup>Ca<sup>2+</sup> (Bawin and Adey, 1976). Both frequency and amplitude sensitivities were observed. Maximal decreases of 12 to 15 percent occurred at 6 and 16 Hz. Thresholds were  $\sim 10$  and  $\sim 56$  V/m for chick and cat tissues, respectively. Similar, but nonsignificant trends, occurred during other exposures at 5 and 100 V/m. Tissue gradients were not measured, but estimates are of the order of 0.1  $\mu$ V/cm. All results were statistically compared with matched samples of controls. Thus, the efflux was clearly windowed in both frequency and amplitude.

**11.1.2.3.2 Effects of Weak VHF and UHF Fields Modulated with ELF.** Similar frequency and amplitude windows have been observed in chick cerebral tissue exposed to VHF and UHF fields amplitude modulated with sub-ELF. Cerebral hemispheres of neonatal chicks

first incubated in a physiological medium containing  $^{45}\text{Ca}^{2+}$  were then washed in a non-radioactive solution. They were then irradiated in a 147-MHz, 0.8-mW/cm<sup>2</sup> field, sinusoidally amplitude modulated at a depth of 80 to 90 percent at frequencies from 0.5 to 35 Hz. Unmodulated fields and modulation frequencies at 0.5 and 3 Hz did not induce a significant change in  $^{45}\text{Ca}^{2+}$  efflux. In contrast, there was a progressive and statistically significant increase in  $^{45}\text{Ca}^{2+}$  efflux at frequencies from 6 to 16 Hz. The response decreased progressively at higher frequencies from 20 to 35 Hz. Brains treated with  $10^{-4}$  M sodium cyanide prior to  $^{45}\text{Ca}^{2+}$  incubation and irradiation responded identically to unpoisoned tissue, indicating that the response was not dependent on integrity of cytochrome respiratory enzyme systems (Bawin *et al.*, 1975). These experiments were confirmed independently by Blackman *et al.* (1979), who also observed the modulation frequency "window" between 9 and 16 Hz. They also observed that these effects were only statistically significant at incident power densities of  $\sim 1.0$  mW/cm<sup>2</sup>. This power-density window has been confirmed for chick cerebral tissue exposed to a 450-MHz field, sinusoidally modulated at 16 Hz (Bawin *et al.*, 1978a). In the latter experiments, a statistically significant increase in  $^{45}\text{Ca}^{2+}$  efflux occurred only at 0.1 and 1.0 mW/cm<sup>2</sup> and not at 0.05 and 5.0 mW/cm<sup>2</sup>. Measurements showed tissue gradients of the order of 100 mV/cm at incident fields of 1.0 mW/cm<sup>2</sup>.

**11.1.2.3.3 Evidence on the Site and Mechanisms of Transductive Coupling of Fields in Brain Tissue.** Attempts to evaluate the role of  $\text{H}^+$  and  $\text{HCO}_3^-$  ions in controlling  $^{45}\text{Ca}^{2+}$  movement in cerebral tissue and to identify more accurately the probable site of tissue coupling of the RFEM field have been reported by Bawin *et al.* (1978b). Addition of  $\text{H}^+$  ions sharply enhanced  $^{45}\text{Ca}^{2+}$  efflux in the presence of the UHF field, but was without effect on the non-stimulated efflux, indicating a role for  $\text{H}^+$  ion binding in these field effects, perhaps in accordance with the model of competitive  $\text{H}^+$ - $\text{Ca}^{2+}$  binding on membrane-surface macromolecules originally proposed in Pauling's laboratory (Bass and Moore, 1968), or perhaps in terms of proton tunneling across phase boundaries at the margins of cell-surface, fixed-charge domains (Adey, 1981a). The  $^{45}\text{Ca}^{2+}$  efflux was sharply decreased following omission of  $\text{HCO}_3^-$  ions. This decrease is unlikely to be due to inhibition of movement of  $\text{Ca}^{2+}$  ions into mitochondria and other cell organelles because the bicarbonate concentration was only 2.4 mM in the control medium. Nor can the reduced efflux be explained by increased calcium entry into the cell, because the effect persisted in the presence of 0.5 mM  $\text{La}^{3+}$  and was enhanced at a higher concentration of this ion. On the other hand, inhibition of inward  $\text{Ca}^{2+}$  currents in the absence of

$\text{HCO}_3^-$  ions could result in decreased transmembrane calcium exchange, followed by reduced intracellular  $\text{Ca}^{2+}$  efflux. This model would not explain evidence from the same study that response to the UHF field occurred in lanthanum-treated tissue, with the response probably mediated in the extracellular compartment.

Treatment of cerebral tissue with lanthanum prior to testing the effects of the UHF field on  $^{45}\text{Ca}^{2+}$  efflux has proved a powerful tool in localizing at least one major class of these field interactions at the cell surface and in the intracellular space (Bawin *et al.*, 1978a).  $\text{La}^{3+}$  ions block the movement of  $\text{Ca}^{2+}$  ions either inward or outward across the cell membrane. Therefore, changes in  $^{45}\text{Ca}^{2+}$  efflux that persist after  $\text{La}^{3+}$  treatment may be presumed to occur at sites located in the fluid surrounding cerebral cells. Addition of  $\text{La}^{3+}$  to the bicarbonate-free solution described above restored electrical responsiveness, but this response to the 16-Hz-modulated, 450-MHz field decreased (instead of increasing)  $^{45}\text{Ca}^{2+}$  efflux. This response exhibited the same windowed specificity to field intensity observed previously in tissues in normal physiological solution (Bawin and Adey, 1976; Bawin *et al.*, 1975), with a stimulated decrease occurring only around 0.75 mW/cm<sup>2</sup> but vanishing at higher and lower field intensities. Together, these findings support the hypothesis that a limited number of extracellular cationic binding sites is involved in the transduction of weak, extracellular electrical events. Low-frequency, weak, extracellular electric gradients may be transduced in a specific class of extracellular negative binding sites that are normally occupied by calcium ions and are susceptible to competitive hydrogen-ion binding.

Studies of cerebral synaptosome fractions exposed to a 450-MHz field (0.75 mW/cm<sup>2</sup>, 16-Hz sinusoidal modulation) lend strong support to this concept. Synaptosomes are the endings of nerve fibers that form synaptic junctions on the surface of nerve cells. They mediate the transmission of signals from one nerve cell to the next and have a mean diameter of 0.7 micrometers. They can be isolated from other elements in cerebral tissue by ultracentrifugation, and their membranes can be resealed, allowing the centrifuged fraction to be used as a model cerebral system. Exposure to the 16-Hz-modulated, 450-MHz field increased calcium efflux by 38 percent, but 60-Hz modulation was without effect. Manipulation of calcium levels in the bathing fluid in these experiments indicated that the increased calcium efflux came from sites on membrane surfaces, rather than from pools of intracellular calcium (Lin-Liu and Adey, 1982).

In non-nervous tissue, studies of hormone binding and cell-mediated immunity now provide categorical evidence for cell-membrane sites as the focus of major interactions with low-level fields. Cultured bone

cells and cultured embryonic bones exposed to a 72-Hz pulsed magnetic field (pulse duration 325  $\mu$ s, peak intensity 20 gauss, typical induced current in culture medium 1  $\mu$ A/cm<sup>2</sup>, induced electric gradient 1.1 mV/cm) showed a response to parathyroid hormone (PTH) diminished by 90 percent. This peptide hormone binds to receptor sites in membrane-surface glycoproteins and stimulates the activation of the enzyme adenylate cyclase, which is attached to the inner surface of the membrane. In contrast, these fields exerted no influence on the activation of adenylyl cyclase by 1,25-dihydroxy vitamin D<sub>3</sub>, a substance that acts intracellularly, probably at the cell nucleus (Luben *et al.*, 1983).

Destruction of target cells by rupture of cell membranes (cytolysis) is a cell-mediated immune response of T-lymphocytes made allogeneic against these target cells and requiring actual contact between lymphocytes and target cells. This interaction was reduced by 20 percent when lymphocytes were exposed to a 450-MHz, 1.5-mW/cm<sup>2</sup> field sinusoidally modulated at 60 Hz (Lyle *et al.*, 1982). This response showed a windowed relation to the modulation frequency, with maximal effects at 60 Hz and progressively smaller responses at higher frequencies to 100 Hz and at lower frequencies to 3 Hertz. Unmodulated fields had no effect. Recovery of killing capacity occurred after 12 hours.

### 11.1.3 *Physiological Models of Weak RFEM-Field Interactions in Tissue*

No comprehensive models are yet available that adequately explain all transductive coupling phenomena involving weak fields in tissue. However, it has become clear that many of these biological effects in weak fields can only be understood in terms of cooperative processes based on nonequilibrium, resonant, long-range interactions involving biological macromolecules (Adey, 1975, 1977, 1981a; Fröhlich, 1968b, 1975b; Kaiser, 1978a,b; Grodsky, 1976; Grundler *et al.*, 1977; Kaczmarek, 1976; Illinger, 1977).

A strongly presumptive site for these interactions, and one considered as a substantive aspect of virtually all these models is the surface of the cell membrane. The molecular biology of cell membranes is a topic of intense continuing research. It is now accepted that older concepts of the membrane as a simple lipid bilayer must be replaced by the view that the lipid bilayer is fluid and encloses a considerable number of "intramembranous particles" (IMPs), which have considerable lateral mobility within the lipid bilayer. These concepts are subsumed under the general title of the "fluid mosaic model" (Singer

and Nicolson, 1972). The IMPs are proteinaceous, with externally protruding terminal strands of amino sugars that bear numerous negative charge sites at fixed locations on the terminal strands. These fixed charge sites thus form a polyanionic sheet on the membrane surface, with a strong affinity for cations, of which H<sup>+</sup> and Ca<sup>2+</sup> are those with the highest binding affinities in the extracellular fluid (Katchalsky, 1964). This polyanionic sheet appears to form a sensing surface in the first steps in the transductive coupling of a wide variety of weak cell-surface events, including the binding of antibody molecules in an immune reaction (Edelman, 1976; Yahara and Edelman, 1972), in the binding of hormonal molecules (Sutherland and Robison, 1966), and in the weak neurobiological stimulations discussed here.

The sum of observations and constraints does not favor a direct transductive coupling of weak extracellular fields across the plasma membrane, with its extremely high electric gradient probably 12 orders of magnitude greater than these extracellular fields (for review, see Adey, 1981b). Some form of amplification of the initial transductive steps would appear essential. We may also presume that, if this occurs at an extracellular location, it involves systems capable of integrating the weak field over some distance, and would thus occur in the length and area of the membrane surface, rather than in a transmembrane axis (Adey, 1977). This problem has been addressed by Eino!f and Carstensen (1971) in a study of the behavior of micro-sized resin particles considered as porous particles with uniformly distributed, fixed-charge sites. Their model is an extension of an earlier formulation by Schwarz (1962), which considered the movement of ions along the surface of solid (rather than porous) colloid particles. At the surface of the particles, the boundary region is characterized by a very large, radially directed static field with a corresponding radial variation in the distribution of mobile ions. Maintaining this distribution has the effect of requiring the ions in the boundary layer to move in a path tangent to the surface of the particle. Porous, charged particles are characterized by a low-frequency dielectric relaxation, leading to large static dielectric constants. A final result is polarization of the ionic atmosphere at the surface of the particle in the presence of an external electric field. This polarization produces an additional *apparent* dielectric constant of the particles, exceeding the actual dielectric constant by several orders of magnitude at low frequencies. The magnitude of the low-frequency dielectric constant is proportional to the size of the particle and the square root of the fixed-charge concentration in the porous material. The relaxation frequency depends directly on counterion mobility and is inversely proportional to the square of the particle size.

The effective dielectric constants of micrometer-sized, ion-exchange resin particles are as high as  $10^6$  at frequencies below 1 kHz (Einolf and Carstensen, 1971). Similar properties may be expected at the surface of tubular structures with diameters in the micrometer range, including dendrites with polyanionic glycoprotein surface layers. This model provides an avenue for future research into the biological effects cited above in which it appears that thermal noise at normal tissue temperatures is substantially larger than the tissue components of the imposed electric fields. For typical conductors in the biological temperature range, the Boltzmann  $kT$  noise is of the order of 0.02 electron volts. However, this expression gives little concept of the extent to which electric gradients in tissue may be established by thermal, atomic, or molecular perturbations, nor of the way in which components of this noise may be transferred to distant sites within tissue. In metallic conductors, the transfer function for this noise energy has an essentially infinite bandwidth, a condition that does not pertain in tissue. The transfer function of thermoelectric noise in tissue has yet to be studied. However, a tentative model does offer interesting points of resemblance to observed neurochemical and behavioral thresholds (Bawin and Adey, 1976). Data from the Einolf and Carstensen study indicate that ionic conductance along a membrane surface in the counterion layer will exhibit an inverse frequency dependence and limited bandwidth due to the very high apparent dielectric constant in this zone. The Boltzmann equation may be written in terms that model the tissue in this region as a low-pass filter:

$$e^2 = kTBR, \quad (11.2)$$

where the transfer function for the root-mean-square noise voltage,  $e$ , is a function of the temperature,  $T$ , the frequency bandwidth,  $B$ , and the specific resistance of the noise pathway,  $R$ . With a specific resistance for brain tissue on the order of 300  $\Omega$  cm and an effective frequency bandwidth from 0 to 100 Hz, the equivalent, noise voltage gradient would be on the order of  $10^{-9}$  V/cm. This value is in close agreement with observed sensitivities of marine vertebrates, birds, and mammals to certain low-frequency fields, and these thresholds are consistent with a thermal floor as the limiting factor.

Virtually all identified steps in these processes are known to be calcium-ion dependent. In all these events, the observations and models indicate that integrative processes in the coupling of these surface interactions to intracellular mechanisms first occur in the length and area of the membrane, prior to communication of information to the interior of the cell. This, too, has been a significant new concept in models of the molecular biology of excitatory processes.

**11.1.3.1 Quantum Mechanical Models of Long-Range Interactions.** There has been growing interest in models for predictive evaluation of these unexpected biological sensitivities. These models were advanced to resolve two of the more baffling problems of these effects: sensitivity to low-intensity fields and possible bases for molecular interactions in the ELF spectrum below 100 Hertz. There are at least four major groups of models, all of which emphasize phase transitions at extremely low frequencies: charge-pumping models, Lotka-Volterra models of charge-population transitions, models of limit-cycle phenomena, and models of tunneling effects.

**11.1.3.1.1 Models of Macromolecular Phase Transitions at ELF.** There are no known mechanisms to explain ELF biological effects on the basis of direct interactions with component dipoles of molecular systems that oscillate at these low frequencies. Therefore, a structural and functional basis must reside in properties of molecular systems. Grodsky (1974, 1976, 1977) has hypothesized that excitable membranes are energetically equivalent to sheets of giant dipoles bathed in controlled external electric fields. His model examines the role of long-range cooperative processes in latticed mosaic systems of the type first proposed by Ising (1925) to explain mechanisms of ferromagnetism. Grodsky's model encompasses the concept of a "greater" membrane (see below), in which the cell membrane is conceived as extending beyond the phospholipid bilayer by the external protrusion of strongly polyanionic, sialic-acid side chains that are stranded terminals of glycoprotein and ganglioside intramembranous particles (Schmitt and Samson, 1969; Singer and Nicolson, 1972).

In this model, the outer layer of phospholipid polar heads is represented by a two-dimensional crystal mosaic of multipolar sites ( $p$ -sites), sprinkled with islands of glycoproteins. The "fuzz" of the outer membranes, above the  $p$ -sites, displays a mosaic of cationic binding sites ( $c$ -sites). The  $c$ -sites are less densely packed and less tightly bound mechanically than are the  $p$ -sites, and their electric charge depends on local, external ionic contributions, which can vary quite rapidly. The prediction of behavior from a knowledge of structure rests on the ability to identify the contributions of  $p$ -sites and  $c$ -sites to the total energy of the system in the context of mutual interactions between the two sheets of charges. The  $p$ -sites are taken to be occupied by ideal dipoles. If the dipoles are densely packed, neighboring interactions will tend to keep them oriented, on the average, perpendicular to the sheet, so that the energy in the  $p$ -sheet can be expressed as a Hamiltonian integral of the dipole fields. This field decreases as the cube of distances between the sites. The  $c$ -sites are assumed to be variably occupied by divalent or monovalent cations, or to be unoc-



cupied. The charges interact with each other through Coulombic forces in the  $c$ -sheet and via the dipoles in the  $p$ -sheet. Coupling between the sheets falls off rapidly as the distance,  $r$ , between the sites increases, but the fields set up by the  $c$ -sites are of much longer range, falling off as  $r^{-2}$  instead of the dipolar  $r^{-3}$ .

The Hamiltonian expression of the membrane model then becomes mathematically equivalent to that describing the interactions of bands of electrochemical quasiparticle excitations with each other and with a band of phonons, via phonon exchanges, in a complicated combination of dipole rotations, ion exchanges, and mechanical vibrations. The quasiparticle, phonon-coupling constants are negative, because energy is dissipated in the interactions. Negative coupling gives rise to the possibility of new bound states (altogether new bands of quasiparticles of higher frequency), but more importantly, negative coupling always *lowers* the frequency of the existing bands. The direct couplings between the  $p$ - and the  $c$ -sheets produce strongly negative contributions to the energy, and are thus capable, under certain conditions, of lowering the uncoupled  $p$ - and  $c$ -sheet frequency bands. Grodsky applied his theoretical model to a simplified system consisting of a perfect two-dimensional lattice. At progressively increasing energy levels, this system passes successively through antiferro-like, flop, and para-like phases.

Below a critical level of thermal energy (Neél temperature), at low external field intensities, neighboring interactions and anisotropic fields dominate in the sheet, and the dipoles assume a checkerboard configuration with each neighbor pointing oppositely, on the average, in or out of the sheet; the system is in the antiferro-like phase. At higher field intensities, but below the triple-point energy, the dipoles flop over so that they are perpendicular to the field on the average, but are still in an antiferro-like configuration within the sheet; the system is in the flop phase. With increasingly intense fields below the Neél energy, or at temperatures greater than the critical point, the external field overrides the sheet interactions. The dipoles then follow any external field and the system is in the para-like phase. When the system is in the antiferro-like phase and as the external electric field increases from zero, two bands of oscillations emerge from the initial "degenerate" bands of excitations, one increasing and the other decreasing, until the lowest frequency band (longest wavelength) reaches zero.

TABLE 1.1—Frequency bands of the RFEM spectrum\*

Band number	Frequency range	Metric subdivision (waves)	Adjectival description	Acronym
1	>0 to 30 Hz	—	Sub-extremely <sup>b</sup> low frequency	SELF <sup>b</sup>
2	30 to 300 Hz	Megametric	Extremely low frequency	ELF
3	0.3 to 3 kHz	—	Voice frequency	VF
4	3 to 30 kHz	Myriametric	Very-low frequency	VLF
5	30 to 300 kHz	Kilometric	Low frequency	LF
6	0.3 to 3 MHz	Hectometric	Medium frequency	MF
7	3 to 30 MHz	Decametric	High frequency	HF
8	30 to 300 MHz	Metric	Very-high frequency	VHF
9	0.3 to 3 GHz	Decimetric	Ultra-high frequency	UHF
10	3 to 30 GHz	Centimetric	Super-high frequency	SHF
11	30 to 300 GHz	Millimetric	Extremely high frequency	EHF
12	0.3 to 3 THz	Decimillimetric	Supra-extremely high frequency <sup>c</sup>	SEHF

\* From Sams (1968), based on international treaty involving participants in the International Telecommunications Union (ITU, 1981).

<sup>b</sup> Band 1 is a designated band with no official adjectival description and symbol. Suggested entries are shown for this band.

<sup>c</sup> Band 12 has no official adjectival description. A suggested entry is shown for this band.

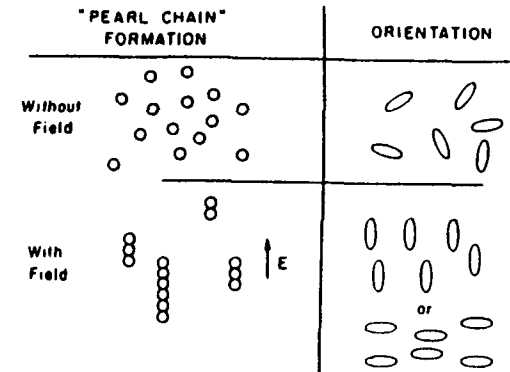

Fig. 2.5. Schematic presentation of some effects of alternating electrical fields on particle and cellular arrangements. (From Schwan, 1975.)

# ELF-zapped genes speed DNA transcription

Epidemiologic studies have suggested a link between extremely low-frequency (ELF) electromagnetic fields and an increased risk of cancer, particularly brain cancer and leukemia (SN: 2/14/87, p. 107). But those studies do not establish a cause-and-effect relationship, and scientists have very few clues to how ELF fields might influence cancer growth if a causal relationship exists. Now, two researchers in New York City offer one such clue, suggesting that genes normally expressed in cells dramatically accelerate their DNA transcription when exposed to ELF fields *in vitro*.

ELF fields exist wherever electricity flows and thus are virtually unavoidable. At these frequencies—below 300 hertz—electrical and magnetic fields behave independently: Electrical fields show little penetration through body tissues, while magnetic fields penetrate the body readily.

Earlier cell-culture studies by Reba Goodman of Columbia University's Health Sciences Center and Ann Henderson at Hunter College revealed an ELF-related increase in the DNA transcription rates of normally expressed genes in human white blood cells and in salivary-gland cells from fruit flies, Goodman says. Transcription is the process by which the DNA code is copied and relayed to protein producers within a cell.

In their latest study—which Goodman described last week in Washington, D.C., at a meeting of the Federation of American Societies for Experimental Biology—the team focused on the transcription rates of five genes normally expressed in a human leukemia cell line. These included two proto-oncogenes, which trigger cancerous cell division if "turned on," or expressed. The researchers also studied a sixth gene normally unexpressed in leukemia cells.

They exposed some cells to a 60-hertz, continuous-wave field typical of household appliances; others received a 72-hertz continuous wave or a 72-hertz pulsed wave, both used clinically to help heal bone fractures. Field intensities ranged from 0.5 to 500 microvolts, and exposures lasted 10 to 40 minutes. The team then compared genes from these ELF-exposed cells with genes from unexposed control cells.

Goodman says the five ELF-exposed, normally expressed genes showed a 100 to 400 percent increase in transcription rates compared with the unexposed genes. In contrast, she says, the unexposed genes and the exposed, unexpressed gene never exceeded the normal rate required for cell division.

Transcription increases did not vary with field frequency but did vary with intensity and exposure time, Goodman reports. Even 10 minutes at 0.5 microvolts

prompted 100 percent increases, she notes. The 400 percent increase occurred with 20-minute exposures at 5 microvolts.

According to Charles Rafferty of the Electric Power Research Institute (EPRI), the magnetic field emitted at 5 microvolts in Goodman's lab corresponds to occasional, high-level occupational exposures such as those a utility worker might encounter when working near a power generator. Funding for the study came from EPRI (the electrical industry's research arm, based in Palo Alto, Calif.), the U.S. Department of Energy and the Office of Naval Research.

Goodman speculates that genes respond to ELF fields only if they are normally expressed. Though exposed cells stepped up their protein production, cell division did not increase, she adds. "It's too early to draw conclusions about how our findings relate to epidemiologic evidence of increased cancer risk," Goodman says.

Biologist Marvin E. Frazier of Pacific Northwest Laboratory in Richland, Wash., asserts that the results may offer a "potential mechanism one could tie to increased cancer [rates]." And biochemist Christopher D. Cain says they "have the potential to be revolutionary" to an understanding of how ELF fields affect cells. Cain, of Loma Linda (Calif.) University, says he has exposed cultured human bone cells to pulsed-ELF fields and measured changes in levels of important cell regulators, including enzymes and cyclic AMP. He suggests those changes correspond to what might occur with increased transcription in genes normally expressed in the bone cells.

Goodman and Henderson's results "certainly don't show a specific [cancer] link at this time," says EPRI's Rafferty. "It is a consistent picture with the possibility that these fields may be carcinogenic, but it's not causal. But the finding that the fields can cause changes in gene expression is, I think, an important one."

SCIENCE NEWS, — C. Decher

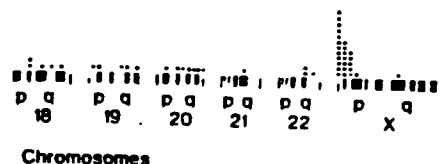

## M A T R I X I I I

White House who was directing certain aspects of the project.

This man was one of the K-group and headed what was called the Psi-corp. It was an alien intervention. This was scheduled to be a main invasion from a different universe.

How about other types of aliens that were involved?

Most of the other alien groups around, including the ones that had their shipped sucked into hyperspace, were observers of what was going on, not participants. Beyond the obvious fact that they were observing for themselves, there is insufficient data to determine whether they were observing for anyone else.

What about the alien ship, again, that was trapped underground at Montauk?

I was part of the group that dismantled it. What is involved is that you have to find out how everything goes together. You have to read their manuals...there were seven occupants of that ship; four of them would not talk to us. Eventually, three of them did, and we learned their language and deciphered their manuals about the construction and maintenance of the ship...

They weren't Greys?

No. They were about 6 foot 5 inches tall. They were essentially human in appearance. They had dark leathery skin. They had no hair. Where they came from we were not sure. We don't even know why they were there, except perhaps to observe the test on August 12, 1943. When the ship appeared in 1983 underground, we were initially concerned as to whether this ship represented some sort of "point man" for an invasion of some kind.

Was there any weaponry aboard that craft?

Not that I remember. The ship had a lot of strange devices on it. We took a lot of stuff apart. We took off part of the control panels, and communications equipment. We decided not to touch the main power plant because we thought it might blow up if we fooled with it. We left the food processing units intact. The ships drive systems were removed. A lot of the ship was stripped down right to the shell. It was left that way.

Why would they suspect an invasion?

I don't know, except that there have been so many groups over the years trying to invade this planet. One wonders why they want to bother with this mud ball and its backward

M A T R I X I I I

technology.

John Lear suggests that the human race represents a gene pool.

That is one good possibility. Another one, and I get this from sources I can't reveal at this moment, is that they are seeking certain rare earth elements they apparently can't find elsewhere.

Robert Lazar mentioned a book that contained the history of earth and that it said that humans were referred to as "containers for souls" and that souls could be traded in something like a barter system.

The aliens are doing it all the time.

They're trading in souls?

Yes. They were shuffling us around like we were cattle to them.

Property. What do you think of that concept as applied to humans?

Well, it is mentioned that several races consider humans in some ways similar to that. Whether it is the bodies or the souls that are considered property, I don't know. It appears that they are concerned more with the bodies, the genetics, and the capabilities of the human mind. The capabilities of the human mind are virtually unlimited. That fascinates some species.

Those aliens that were on that ship. What became of them?

Out of the seven, four did not talk and three did talk to us. One of the group that did not talk to us was evidently the captain of the ship. He eventually killed the three that did talk to us. The four remaining aliens were put into "deep freeze" by the people who were running the underground at Montauk. I have no idea what they did with the other three bodies.

What happened to the craft?

It's still there, as far as I know. It was a gold colored saucer about sixty feet in diameter. It had a bulge on both the top and bottom.

In one of Linda Moulton Howe's books they had pictures of types of alien writing. Were you ever able to determine the language they used?

## M A T R I X I I I

The language they were using was apparently that of the Greys. The symbol that the Greys use a lot is the same symbol that the Trilateral Commission uses.

How big is the underground at Montauk?

It's very large. It extends for miles, especially the 5th and 6th levels. Almost all of it was constructed in the late 1920's or early 1930's. We talked to one of the men who was one of the contractors who built it. It was built on government orders right after the depression started. It was built in six levels. They covered the top over with earth. It's known locally as "the hill". It's a huge base. There may still be some use of it. Most of it is shut down. The power has been on for two years now, single phase 220 volt. The elevator used ran on three-phase 440 volts, and that has not been turned on, probably because they plugged all main openings and the elevator shaft with concrete.

How many different species of aliens are you aware of?

Well, the Greys were not part of Montauk. By agreement they never went there. There were groups that were part of it, like a group who called themselves the Leverons. There were those there from Antares that were only observers. They looked like humans. There were members of the Orion group there occasionally. The K-group had some connection with the place, but I personally never saw any of them there. Lastly, there were the inhabitants of that ship that was captured. The Orion Confederation includes a lot of groups, including the Leverons.

The Orion group is supposedly at war with a group called the Elohim. Would you say that is accurate?

Yes. This is happening. The Elohim group is a very old race, perhaps the oldest in the universe. At least its the oldest we know of.

Is there any particular species that has the greatest control over humans?

The Orion group. They're the weasels in the background that manipulate everybody, including the Greys. The Orion group includes the various reptilian species.

Was the zero-time generator from alien sources?

No. Tesla created the zero-time generator in the 1920's. It provided a very basic time reference which is actually locked to the center of our galaxy. That's why they call it a zero time generator. Locking equipment to that is the only way

M A T R I X I I I

you can get some of these higher function generators to work.

The aliens use crystals quite a bit.

Yes. Crystals can store and modulate enormous amounts of energy. There was a crystal in the alien ship that ended up at Montauk that was about 18 inches long. Other factions of the alien group appeared in one of the side tunnels off the main time tunnel and captured several of us, and wouldn't let us go unless one of us went back and got that crystal for them. We did. The problem was is that we were in the time tunnel too long, because the time references the man I was with dissolved, and he began to age at the rate of about a day per hour. Within three days he was dead.

What are some of the ways the government became involved in time travel?

The Navy had the ability to use the time travel technology from about 1970 and developed full operational capability in 1973. They did do an experiment where they tried to go back and kill the father of the man destined to be the head of the new One-World government. They did kill his father, but it made no difference. They didn't understand why it didn't work. Robert Lazar was voicing the concept that time is quantitized or compartmentalized and that you can't change what has already happened in terms of the past.

Is the Navy tied in with the secret government?

Small elements in the Navy are, but the Navy in general is not.

So in the 1970's they were against what was going on and tried ways to stop it?

Yes. At Montauk we did succeed in changing the past, so I know it can be done, but it takes enormous amounts of power and more than just a time machine, but I won't get into that.

So the person who will be the head of the One World government is walking around and has no father?

Theoretically that is true.

How could this guy have come into existence?

That's a very good question. That's another one of the paradoxes of time.

Was this person already in existence before they went back and killed his father?

Yes. They assumed that he would disappear and cease to

M A T R I X I I I

exist.

Do you know who this individual is?

No. Not by name.

Is the One World government interested in longevity? It seems like all these plans are on a long term basis. It would also seem like it would take too long before those in control could really reap the benefits.

Went you get to the level of the warped mentality of the world leaders that are controlled by the Orion group, you don't really know what their goals are. They are totally dependent on a specific technology, including time machines which are anchored in the 40 years time rift plus the extensions in the time matrix which goes another 20 years. Time machines are based in the technology that had its origin here within that time period, and from what I understand as of 2003 they will suddenly find that their time machines no longer function.

Why?

Because they were created on the basis of something which was basically artificial - the rift in time. The function is based on the rift. Then its back to the drawing boards.

Have they constructed any concrete plans based on the rift that might disappear when the rift does?

I don't know. I can't speak for the whole government.

Are any Orion based timetables involved in this?

Well, the Orions have their own ways of doing things.

Would they be dependent on this rift?

No, but the Greys are somewhat dependent on it, having used it to get here in large numbers. The Orion group itself is not here in a large number.

They let others do the dirty work for them?

Yes.

Do you get any particular feeling what things are like within the secret government with respect to the groups of aliens?

Well, they were panic stricken to get rid of the Greys. I don't know if they're that panic stricken any more, because I understand that the Orions are essentially gone, except for

M A T R I X I I I

the mop-up squad, which have their own life support systems.

The general life support for the others was destroyed by another alien group in November 1990. They could not exist here without electronic support from the ring of satellites they put up there ages ago. Almost all of them packed up and left.

What is the nature of the electronic support?

They cannot stand the vibrations of this planet. The Greys like it because this planet is very much like their own home planet.

How would all this relate to the idea that there is a planetoid coming into this system with a bunch of reptilians on it. Would they bring their own electronic life support systems?

Yes. They can replace the satellites. They may well be back before long.

How do you view that scenario, where the planetoid full of Orion reptilians, or Draco, is coming here?

Well, we monitored the signals coming from the planetoid. They were coming in at around 25MHz with twelve carriers spaced 50KHz apart. The Orion group reptilians have twelve chakras, maybe that has something to do with it.

Then this could be the part of the electronic signal that might even be representative of their electronic life sustenance matrix?

Yes.

It might well be necessary to set up transmitters of our own that would interfere with that kind of electromagnetic emanation.

Yes.

How about the Orion genetics?

It's very similar to that of humans. For a long time they were hoping to crossbreed. It didn't work properly. That was one of the side issues of the Montauk-Phoenix project, to find ways of crossbreeding. They never did fully solve the problems.

So this is where the concept of twelfth density would come in?

Yes. Probably. What they were hoping to do if they



## M A T R I X I I I

succeeded in crossbreeding humans and Orions was a silent invasion where they would take over humanity by crossbreeding and eliminate the humans they didn't want. At that point, Orion souls would move into the crossbred bodies and it would be complete. They would not need electronic support systems to survive here, which consists of 12 satellites.

So how does this affect the world government plans, now that the Orion group is temporarily gone?

It changes the context of the system that backed up the One World government. They were backed up by and expected support from the Orion group. With the Orions out of the picture, they are on their own.

How about the Greys?

They're running around in circles. They are probably continuing with the genetic work and the abductions but they are lacking all direction except that which they already had established.

There was a recent abduction of woman in Seattle on December 3, 1990 where there were beings that looked human. They told them, however, that they weren't really human and allowed them to see their true form. It was a variant reptilian species they had never seen before. They asked the abductees questions about their experiences with the Greys. The woman got the impression that the reptilian humanoids thought that the Greys were going to far in their interactions with humans and that they were looking into it. Any comment?

No data on that one.

Well, since they were looking into Grey excesses in behavior, they probably were an offshoot group and not anything to do with the Draco.

They probably were an offshoot group. I have gotten the impression that not all the Orion Confederation is evil. There is a group within the Orion Confederation that function as sort of overseers and they are apparently quite upset about what these Greys are doing, but apparently there is not much they have been able to do about it. The basic heart of the Orion Confederation that we have become familiar with is totally evil and self-centered.

They basically want to take over the Earth?

Yes. They want to take Earth because of their desire for the planet as a staging base. They also desire the water and the minerals. There have only been partial success of their cross breeding program. A few hybrids have survived. They

## M A T R I X I I I

essentially look human but have Orion genetics within them.

What's going on in Washington right now?

They are up to their eyeballs in problems. They consider the thing with Hussein in the Middle East as the least of their concerns.

What are they concerned with?

They are concerned with AIDS and other disease problems which are coming to earth from space. There are currently two huge clouds of amoeba-like creatures over the polar regions of the earth. These have shown up periodically over the last ten years. NASA is working on this. Every time they've been detected, all kinds of strange illnesses break out. They don't know how they can stay alive and be in outer space. They're very concerned about that. The AIDS situation is so far advanced that it is considered to be a disaster.

How do you bounce that against the fact that AIDS was created at Fort Detrick, Maryland? Are the aliens ultimately behind that as well?

I don't know. It's very possible. It originated on the orders of the World Health Organization. I suppose you have to go back and see who was responsible for this diabolical plan within WHO to create a virus that would destroy the human immune system. They found out that once it was released that it mutated like crazy and there is no way to produce a vaccine for it. The government does have a way to cure it, but they do that on a pretty selective basis. The cure involves electro-magnetics. There are also other means that have been discovered, but the government doesn't want the outside world to have it. It's part of the population reduction program.

Which is whose idea?

Apparently it was a decision reached by the secret government. The final decision was made in the White House in 1972 on the basis of a meeting of world leaders under Nixon. A friend of mine got the notes from that. He's now in prison, and he talked about it publicly in 1974. He said that they had the meeting and agreed that the planet was overpopulated and that it had to be reduced. The decision was to reduce the population from 5 billion, which it was at that time, to 1 billion by the year 2000. They were to use any and all means to do this. They believed that the earth could only handle 1 billion inhabitants. Their problem was how to exterminate 80% of the world population in 30 years. They modified the figure to be 2 billion by 2000, but the AIDS thing is going to take care of a good part of that for them. The latest figures coming out of Washington indicate that Africa is now as good

## M A T R I X I I I

as doomed. In another ten years, 75% of Africa will be dead.

There have been recent figures to suggest that 92% of all babies born in Africa today have the virus.

Yes. In India, the rate is 51%.

It seems extremely irresponsible for a government to create something that can take people and do that to them.

Well, it was the "undesirables" that were given the virus first.

They should have known that this thing was going to get out of hand.

They didn't know that was going to happen. It was also figured that it would affect the young set, those in their prime, most.

If they travel in time and know that geophysical changes will take care of a large part of the world's population, why would they bother to do it? Especially because you have a bunch of 50 year old men having to wait 30 years.

I don't know. Obviously they didn't think.

Or it wasn't them who were ultimately responsible. The only ones who would have a long term anything to gain would be aliens, so it further indicates that ultimately there are negative off-planet forces that are responsible. The aliens know about the changes.

How did they spread the virus initially?

Through World Health Organization inoculations that were contaminated with the virus. The first program was in black Africa in 1974 with the smallpox inoculations. They then went to Brazil and other Hispanic countries and did it there. In 1978, they laced the gamma globulin for the Hepatitis B vaccine because the homosexual population was the greatest consumer. That's why it showed up first in the United States in the homosexual population and why it was claimed to be a homosexual disease. Nothing could be further from the truth, but it was something the Evangelists took up quickly, saying that AIDS was "Gods curse on the homosexual". People didn't worry about it who weren't gay. The people who planned this didn't figure on the ability of the virus to mutate.

It must taken someone with a really stupid mentality to do this.

Absolutely.

## M A T R I X I I I

What kind of disturbances have appeared with each appearance of these amoeba-like clouds?

Respiratory disturbances. It's been detected in the New York area and on the west coast. Details are scant, but they consider it a major problem. It affects the human system directly. It is also the mechanism behind the influenza attacks in 1916 and 1917 that killed so many people.

It is possible that the ozone layer was deliberately affected in order to allow this influence to come through?

I don't know. The greenhouse affect is taking hold because of it.

Is there any particular alien species whom it would benefit if the earth dried up and became desert?

Yes. The reptilians species might be good candidates.

Where do the Greys come from originally?

From outside our time/space continuum. The government does not fully understand where that is, since they don't trust a lot of their information about them.

Do the Pleiadians use the gravity amplifier to fold time and space?

No. They have a hyperspacial drive system. They don't do it in the same way. They use velocity rather than folding.

Aren't they beneficial to humans?

They have not been invited to help. They are also sensitive to earth politics, galactic directives, and their own policies. It comes down to the fact where you don't interfere when you're not asked. Even when you are asked, there are limits to what you can do.

Can they be asked?

Well, in the case where you would have interference on a mass basis, like in response to the Orion incursion, you're getting involved with the history of all humanity. We'll have to see.

I would think that the only hope would be to collectively raise the consciousness of the entire planet.

Right. There are also other problems. The government worked out a deal with the Greys some time ago and has some of

## M A T R I X I I I

their technology. Weapons have been developed. They now have a missile that has a minimum operational range of 1 light year. We can hit any spacecraft well beyond the solar system.

I saw a brief on the news where the Star Wars technology is being turned around in space to hit down asteroids. Will they in fact be used primarily as a planetary defense against alien incursion?

Yes. The directives out of Washington seem to point to the fact that the secret government wants no aliens here at all interfering with their plans. They have not solved the problem with the Greys.

How do aliens refer to religious concepts?

As far as I know, none of them have any religion as such. They acknowledge a divine source in the universe. The Greys refer to the universe as a mind.

What is your prognosis for the future of the human species?

It will survive.

Why was it mentioned at one time that 2011 was the last year that they could see anything tangible?

It was mentioned in the Mayan calendar that 2011-2013 was a barrier of some kind. Psychics have said that there is a barrier around 2013 that they can't go through.

That doesn't mean there is nothing beyond that.

No. It's just blocked from view. Even to the time machines. There are a lot of people wondering whether they are going to retain control over humanity beyond 2013.

There seems to be a quickening of consciousness right now as we are beginning to go into fourth density.

Right. There seems to be some evidence of this.

Do you know where the current entrances to Montauk are?

No, but I know they're there. The last time two people went out there to look they were abducted. They were knocked out electronically and taken underground to another facility where mental adjustments were made on them. They were returned to the spot, but one of them was not returned exactly at the same time as the other. There was about a 2 second gap and the one that was already there saw it. They knew immediately that

## M A T R I X I I I

something was wrong. They were given a warning. The underground system is still in operation. There are three entrances near AIL. They have three plants in the Farmingdale area. Brookhaven National Laboratories have an entrance to the system. There is also a connection to the Newark ITT Corporation building. From there a spur that goes to the ITT facility at Nutley. There is also a tunnel that goes from Newark to Wright Patterson AFB.

Do they use Maglev trains in this tunnels?

Yes. There is a very extensive tunnel network under the United States. The interesting thing is that once you get past the coding system at the entrance elevators and get into the underground, nobody asks any questions. They assume you are supposed to be there, unless you make it obvious that you are not by your actions or appearance.

Why do humans age?

There are two genes missing from the human chromosome. One of them controls the aging process, so humans age. Because of this, when cells are duplicated in the body they are compared to the parent cell, not a master pattern that would exist in the genes, so the duplicate is not exactly the same in time. So humans age gradually.

There has been some discussion of the biorhythm cycles of the planet. Could you explain that again?

The cycles of humans are well known. It was not known until after 1983 after Montauk went down that the earth has cycles. It was discovered by accident. After an analysis, it came out that there were four basic cycles involved. These four cycles reach their maximum peak every 20 years. It's always on the 12th of August.

So the next peak will be in 2003?

Yes.

Do the biorhythm cycles of humans and those of the planet interlock?

It is not known to interlock.

Have you seen the movie Milleneum? What can you say about the concepts portrayed there?

Yes. It was well done. It was an attempt to explain some disappearances. It's an intriguing idea. Strangely enough, they didn't cover something that really happened in Denver around 1965. A jet was coming in on final approach in daylight

## M A T R I X I I I

with no bad weather and vanished entirely from the radar

screen. It was never found. No trace. Years later, in Tucson, I met the son of a man who was vice president of United Airlines. I asked him about it. He said, "how did you hear about that?". I said I read it in the newspapers and then it was hushed up. He said, "you better believe it was". I asked him if anyone knew what happened to it, and he said that they had no idea. There was no wreckage, nothing. There is no way it could have happened like that, but it did. The ideas in Millenium were more along the line of something they would have developed in the Phoenix project.

Are there any tunnels under the Pyramids?

There is a tunnel under Giza. No one knows when it was constructed or how.

How about spacecraft or anything else like that?

An expedition was mounted as a result of data gathered back in the 1920's and 1930's about a secret chamber under the pyramid. They built equipment in later years and went in down into the pyramid and found this metal door 500 feet below the base of the pyramid. They found other doors. The doors used a sonic code. They found a room with over 30,000 recording disks and alien equipment. They made photos of the disks with IR film. The Egyptian government wouldn't allow them to take any out. The disks were deciphered. They described the rise and fall of civilizations in outer space going back more than 100,000 years. This group built this record room and then built the pyramid over it. There was no UFO, but a lot of equipment was stored on three levels. They photographed over 2,700 record disks. According to an Air Force contact, these disks are sitting in a safe at Kirtland AFB in New Mexico. They don't want the public to know the information.

How is the government involved in cattle mutilations?

Human scientists are involved with longevity studies using adrenalyn. They have developed altered adrenlyn, and drugs called cordrazine, cortropinex, formazine, and hyronalix. All of them have an adrenalyn base. The only way to get the large quantities of adrenalyn is to get them from cattle. Some of the substances they develop affect psychic development. Other drugs have physical restoration properties. Aliens use cattle for the biological materials as well. They use the materials in their breeding program and for the construction of cloned individuals.

Do you know when the Federal Reserve is going to issue the new money?

I don't know. There have been several dates that have come

## M A T R I X I I I

and gone. When they do all the current cash will be worthless.

The plan is to give a short notice date by which people will have to turn in their old money for new. Of course, you will have to account for it, especially since it is now illegal for you to have \$3,000 or more on your person. It's coming.

Would you consider the secret government the Fourth Reich?

It's hard to say. My understanding of it is that the secret government is not connected with the Nazis but with world bankers, old money and what's called the "black nobility". These were the blue-bloods of Europe. They actually did have blue blood, and it was not hemoglobin based but copper based. They were semi-human. There are still to this day, some animal species in South America that have copper based blood systems. There was a problem with hemophilia, and not because of intermarrying. The problem was that they started to marry outside of the copper based blood system. Hemoglobin and copper systems don't mix. That's where the laws against marrying commoners originated.

What about these synthetic humans?

Human cloning was developed at the University of Utah at Salt Lake City in 1977. They first aired this on TV as part of a series. They had an alleged human clone on TV that they were interviewing. It didn't talk very well. They showed the original human and the clone. The clone was not all that successful. It took 14 months to generate a fully adult human clone in a tank. It was a two part series. The second part of the series never aired, for obvious reasons. CIA sources have confirmed that it started at the University of Utah. The government has a facility for clones. The first one was built in the Mount Hood area, about sixty miles east of Portland, Oregon. They have other facilities in other locations. Locations must have stable geomagnetic fields and other special characteristics or the cloning process does not work properly. They can replicate them faster now. They have clones of all the major government figures. This is partly for security reasons. It also creates the situation that when someone falls out of favor, they clone the person and kill the original. This kind of thing apparently happens with some frequency.

There have been allegations by some that Carter and Reagan were replaced.

Yes. I've heard that, but I have no information that says that it happened. Reagan looked a bit funny after his assassination attempt, particularly after he came out of the hospital.



## M A T R I X I I I

It's curious about the cloning facility in Portland. Were there not reports in the 1960's or 70's about people seeing a spitting image of Hitler there?

Yes. It is curious. There isn't any connection that we can establish, but anything is possible. Hitler could have died as late as 1984. I have heard rumors that he was the top director of the Phoenix project, but those rumors were not considered to have any merit by most people. Eichmann was apparently involved at one point until the Israelis got him. A lot of top level Nazi scientists were involved. There was a man called Huntermann who was the associate director of the project. We wondered if there was anybody above him. There was - a complete collection of pure Nazis at the top. The Germans were also involved in work with the Greys and cloning processes.

Are they Nazis still running things?

I don't know what interconnections they may have today. I have two friends who say opposite things. One says that the Nazis are in charge and the other says that Jewish scientists are in charge. Other people say its MJ-12. Take your pick. I think that they're all involved.

That's very interesting about the duality of the Germans and the Jews. Recently, we received information that these two groups of entities are originally from one source out there somewhere, and that they were banned to this planet to work out their differences. They have apparently always sought to destroy each other...and they are still doing it on many levels. Everyone else just has to stand by and put up with it, I guess. It just adds to the mess. Orientation of both groups appears to be negatively oriented toward service to self instead of others. There have been things recently said by abductees that indicate that they were taken to joint Nazi-Alien bases where they had swastikas on the walls. This was within the last two years.

Do you remember the Reinhold-Schmidt story? He was a businessman who lived in New Jersey in the 1950's. I finally got a copy of his book. He insisted that one time when he was driving home from work, something went wrong with his car. He was approached by someone and was taken aboard a saucer. All the occupants were dressed in black clothing and talked in German. To him it appeared like they might be Nazis. He wasn't sure but he thought they were. They picked him up by agreement several times thereafter. He began talking about it and he had a visit from government agents who told him to shut up. He insisted. He was picked up and put into treatment in a mental hospital for about four months. When he came out he was a changed man. He died sometime later. Up until he went into the

## M A T R I X I I I

mental hospital, he was insistent on his story. This was approximately 1956. I'm not sure. He was a prominent businessman. It was a sensational story at the time.

It's interesting that you should mention copper based blood before. Aren't the Nordics involved with that?

Yes. Although Nordics are humanoid and externally almost identical to humans. There are subtle differences in the Nordic alien physiology, and most of them are based on the living conditions that they have grown up in. Their planets are extremely hot and dry, and have a low oxygen content in the atmosphere. They have a larger lung capacity than humans and have a copper based blood in order to carry oxygen more efficiently. The eyes are protected by inner lids and can allow them to see into the ultraviolet range of the spectrum. They have only 28 teeth, as they lack a back pair of molars. Their heads are longer than humans. The brain case is about .2 mm thicker and the bone is harder. The brain is the same as the human brain as far as structure and size is concerned, except for the midbrain area, where there are functions that allow telepathic and telekinetic skills. It explains the psionic powers of the Nordics. They average about 2 meters in height. Females about 1.7 meters. They have no sweat glands. The skin allows moisture to be drawn from the air as well as moisture to penetrate. The heart beats at around 242 beats per minute, and the average blood pressure is 80 systolic and 40 diastolic. They have extremely dilated blood vessels. The heart is located where the human liver would be. The cartilage that would protect a human heart extends down 3.5cm further in the Nordic in order to protect this structure. Blood cells are biconvex in contrast to the concave cells of humans. Kidney type functions only allow about half the liquid consumed to be excreted. The rest is evidently put back into the system. Urine is thick with minerals and appears in color and texture to freshly pumped crude oil. Feces are dry pellets with all moisture removed. The adult Nordic can regulate the amount of adrenalyn in their body. They have no pineal gland. Nordic females are capable of being impregnated at any time, but the males are capable of impregnation about once a year. The period of incubation is three to five months.

What about the Sirians?

Well, we are finding out that they are seemingly involved in the Dark Side activities with abductees along with the Greys and elements of the US military and intelligence forces. We are finding out that Reich programming is currently being used as of December 1990 on abductees. This is a direct outgrowth of work at Montauk. The Sirians are usually described as about 6 1/2 feet tall, blond hair cut very short, and blue eyes that have a cat's eye vertical pupil. They're negatively oriented. I have been working on a case where this

## M A T R I X I I I

21 year old woman has had contact with them, the last time being in December 1990. The beings present were the short little helpers that the Greys use; the ones that wear hooded cloaks. There were Grey clones, tall Greys, Sirians and US military personnel of some description. The woman had her breasts and other body parts hooked up to some machine that maintained her in a pre-orgastic state while they used inculcation bars with red and blue lights to aid in the programming. When she does something they don't like, they take her out of her body and stick her in this black box, where there is terrible loneliness and isolation. She really broke down when she was describing that, saying that she didn't want them to put her back in the box. They evidently told her that if she talked too much they were going to do that. On the lighter side, she has also had contact with positive groups. There has been some discussion as to whether these negative Sirians are part of the Kamagol II group that built the records chamber under Gizeh, but that has not been established. The negative Sirians are considered part of the Orion group that is playing the domination/control game.

Is there some significance to the red and blue lights in the inculcation bar?

The lights on the bar are of special frequencies. Pulsing of these lights is often combined with sonic patterns to virtually reprogram the mind of the individual. This kind of activity has been going on for tens of thousands of years. Why do you think that the Orion based groups that control today's society use red and blue on police car lights? Its very restimulative and many people have buried memories of programming sessions that have occurred through their various lives. The result is fear and negative emotional response. It appears that during the last 40 years there have been a lot of people that have been incarnating that were on one side or the other in Nazi Germany, and we are finding a lot of abductees that have memories of the Greys during that period. Sometimes they find that they are dealing with the same exact beings they dealt with in another lifetime. Of course, we know that abductions also follow multi-generational patterns. It all ties together.

There have been some that have said that Hitler was connected into things in terms of the Aryan race and ET's. What is the story behind that?

Well, Hitler spend a lot of time in libraries before his mother died, and he was convinced that the white race was going to be squeezed out of existence in another 75 years. He decided that he was going to be the defender of the Aryan race. This was back before World War One. He was also relating this to the Protocols of the Learned Elders of Zion,

## M A T R I X I I I

where in the 24th protocol it says that the white race will be destroyed by genetic inter-marriage. He wanted to stop the trend. He became interested in metaphysics. The Dark Side involvement began after a bout with peyote before World War One and his involvement with the Thule Society, which was connected to Aleister Crowley and the Order of the Golden Dawn in England. Hitler also adopted the idea of fighting the communists, because the communists were just about ready to take over Germany. There were not Greys around in large numbers but they were there. The Germans were involved with alien technology. They had one version with electromagnetic drive. They had jet aircraft in 1943. They had nuclear weapons but Hitler did not use them. Mind control research was on-going.

Getting back to present day, what do you think about the idea that the Saudi government is being bankrupted by the US?

Well, the Rockefeller group sold the Saudis 30 year notes back in the 1960's. They are coming due. The Saudis want to get out of the paperwork nightmare so they won't lose all their money. The Rockefeller banks were going to declare bankruptcy, so the Saudis said they would pull all their investments out of the United States and collapse the economy totally. The United States backed down and that is the reason why there is all that forgiveness of debt business going on. It was done with Bushes authority. The Saudis were satisfied. Now the problem with Iraq arises. The Israelis have refused to carry out the deals they have made about leaving the west bank area. Hussein is saying that if the United States can convince Israel to do that for the Palestinians, then he will walk out of Kuwait. That will defuse the entire Middle East situation. January 15th is the apparent deadline date. There are people in government that are crazier than Hussein. As of early December 1990, a contract already exists with Flora Construction company to rebuild Kuwait, so its going to happen anyway.

Does Iraq have nuclear devices?

I'm not sure. They were stealing trigger devices for quite a while before the government found out about it and started substituting non-functional ones. It's believed that they do. The Iraqis are also said to have devices that had their origin in Nazi Germany, such as the air-fuel bomb, which will "turn the air to fire" and suffocate American troops. There is a concern that he will also use chemical weapons. The United States used chemical weapons in Korea and Vietnam. If Iraq uses them, the United States will respond with devastating force. It would be a good time for the secret government to bring out their disks and impersonate alien species in an attempt to pacify the planet. When the United States wins the conflict, it will produce potential problems for years.

## M A T R I X I I I

It is seen as the only option. They could impose this in a pseudo-religious way in an attempt to unify religious groups that are on "holy war" campaigns. Either way, presence of "an apparently benevolent technology" would cause a peaceful unification. Presence of "an apparent malevolent technology" would achieve the same thing, but with a negative unification based on fear. There are again another aspects to the middle east scenarios. One aspect is that the middle east represents an annoying delay to the secret government that has been caused by Iraq. This delay could affect certain types of agenda. Another aspect is that since the US basically controls the planet, all this is a sham for the public - to keep humans up tight, in fear, and at each others' throats - it could be reflective of what is ultimately an Orion based agenda. It is a matter of record that flying disks have been seen in all wars and conflicts.

How about the Congress? Are they aware of the alien and drug things that are going on?

Some of them are, but they are turning their heads because they want to collect their retirement. They're just hoping the government will be solvent when they get to that point. There is no question that as we enter 1991, many agendas will accelerate and many hands will be forced.

Are the men in black residents of Earth?

The group is an off-world one. They monitor conditions on the planet. They are not physical beings, but they can become solid.

Do the black helicopters have anything to do with the MIB?

No. They are managed by the Army. It is a super secret group that have bases all over the United States. They have one near Sedona. They have one in Connecticut and in Newark, New Jersey. The helicopters have no markings and are used for operations involving drug smuggling, mutilations and security for alien related operations and projects. Obviously, it's all illegal as hell, and they have been getting away with it for 40 years.

What about the subliminal programming that happens with television?

The FCC "ruled" years ago that it was illegal, but it never stopped. You find it more common on cable tv. There are using subliminal conditioning on all cable networks. They use it to emphasize different elements of what you are seeing around you. People end up being brainwashed and stay ignorant.

What are some of the capabilities they have?

## M A T R I X I I I

The government has vans that drive around that are capable of complete mind disruption. They have used it before to kill a man in his house in fifteen minutes. All it takes is four helicopters flying in tandem to completely mentally wreck a city if they have those pods on them. The pods are an outgrowth of the Phoenix project. They can produce heavy mood control over a city. They are going into areas beyond the electromagnetic. They are trying to increase the stress level in the population. It is no secret that Bechtel was laying cables under major metropolitan areas several years ago, claiming that it was being laid for "others" whom they wouldn't reveal. It had nothing to do with electric, telephone or cable TV.

What is another possibility as to why the death of the father of the One World government failed to produce the dematerialization of the future leader of the One World government?

This seeming paradox can be better explained this way: the people who went back and tried to kill the father were successful but the son still lived. This is all related to the Grandfather Paradox. The truth of the matter is that they prevented the birth of the leader of the One World government not in the time stream where the existing person was born but in a parallel one where he never existed in the first place. It existed before and after the effort to kill the father; the parallel time stream also exists where the Germans overtly won the second world war. There are differing but parallel interrelated worlds and universes, each having an endless number of streams relating to individual entities. These streams are ultimately expressed as different patterns and outcomes for the same entity depending on the level of expression for the entity at any one time. All divergent entities are part of the one reality which is the all embracing unity. The varied potential tracks all exist as one unified central force. The parallel tracks that exist in our universe, depending upon which one of them is taken, will determine the ultimate outcome for the individual entity, and this can change.

What is the actual nature and purpose of the Orion group?

Basically, the purpose of the Orion group is enslavement and conquest. Their objective is to locate certain individuals who vibrate in resonance with their own vibrational complex and manipulate them. There is a concept called spiritual entropy which apparently causes them to experience constant disintegration of their social memory complexes. They do follow the Law of One but observe free will according to service to self. Those on the enslaved planet then disseminate

## M A T R I X I I I

the attitudes and philosophy which is service to self. These individuals become the "elite". Through the elite, the attempt begins to create a condition whereby the remainder of the planetary entities are enslaved by their free will.

That seems like what is happening on the planet right now, especially in the United States.

Yes.

Why don't they just come down in force instead of using the back door, as it were?

Well, they could. A mass landing would create a loss of polarization due to the infringement on the free will of the planet. If the planet were then conquered and became part of the Empire, the free will would then be reestablished. The way they are doing it is characteristic of the Orion group - to have others do their dirty work for them, including humans. That way, the abridgement of free will is not so obvious. It didn't help the situation when agreements were made with different alien species. It didn't matter that the agreements were made with groupings of humans that did not represent the wishes of the mass consciousness. The technical fact of the agreement allowed a lot of action that was negatively polarized. The Orion group specifically targets civilizations before they become a social memory complex.

What does it mean to have a society with a social memory?

Well, a social complex consisting of individual entities becomes a social memory complex when it adopts one orientation or seeking in a specific direction. When this happens, the group memory that was not available to individuals becomes known. The advantage of a social memory complex is the relative lack of distortion.

What does polarization mean for an individual entity?

Generally, entities can have little or no polarization, positive polarization or negative polarization. A positively polarized entity will select a path embodying service to others. An entity choosing negative polarization would focus on service to self. A negative polarization involves the elements of control and repression. For example, a negatively polarized entity would seek separation from and control over others by sexual means and have the idea of power as an end. The negatively oriented entity will program for maximum separation from and control over all entities which it perceives as being other than itself.

Are not all humans, for example, expressions of each other?

## M A T R I X I I I

Well, yes. Entities will eventually realize that their actions on other selves are actually being done to themselves, since the consciousness present in each entity is a variation on the same thing. The individuation is present to allow maximum differentiation of potentiality and creation.

Many people have been discussing the idea that we are going into fourth density. What does that mean?

Basically another general vibratory rate. It also relates to the realization that one is not separate from the creator. It is that kind of spectrum which has been called by the Christians as the "second coming". The second coming is a state of being, not an individual arriving and establishing a power hierarchy.

When will this be completed?

Well, entities on this planet should make the attempt to polarize in terms of what excites them no later than 1993, or it will be harder to do so. Polarization can be positive or negative. Generally, the fourth density is much more full of life. Entities must still care for their physical vehicles. It is also a density where compassion, understanding and love are more predominant. Full conversion to fourth density will occur between 2003 and 2013.

Its interesting that according to the mathematics behind the I Ching, everything goes jackpot around 2012.

Yes. Nothing will be the same on Earth. It is changing right now. What we are seeing is basically the death of the third density way of life.

Does density level refer to polarization?

An entity can be negatively polarized and in fourth density, but it is an intense struggle because of the development of telepathic functions. If there is a place in which fourth density negative entities have established a power structure, then there is more use of the concept of mind control in order to keep the negative structure from conversion to positive orientation.

What about the upcoming geological changes? How does that relate to all of this?

The fourth density is a vibrational spectrum. The time/space continuum has put Earth and that star system into that type of vibration. This causes electromagnetic



## M A T R I X I I I

realignments within the body of the planet. The energies and collective thoughtforms of the population also disturb the energy patterns of the planet. Geological changes accompany transition between densities. At this point we are in the last 20 years at the end of a cycle which has lasted 75,000 years.

Anything more about fourth density?

The majority of the Orion group are of fourth density. Some are positively oriented toward service to others, but most that are concerned with the current situation are negatively polarized and playing the domination game. Entities on Earth following any religion or no religion at all will move into fourth density if they are that vibration. Entities not at fourth density vibration will remain at third density vibration and will move to other locations to continue third density life until their vibrational level increases and polarizes in time with a cycle of density movement. The polarization can be positive or negative.

How does the idea of a higher self relate to densities?

In terms of an entity perceiving through as linear time structure, the higher self exists in sixth density and functions in the entities "future". One interesting aspect of it is that the entity who is perceiving the higher self manifestation is actually a thoughtform materialized by the "higher self" itself. Entities in these terms are actually a complex composed of what they perceive to be "mind", "body", and "spirit". These complexes can occur within single entities or groups, depending on the specific space/time conditions. The higher self is that self which exists with full understanding of the accumulation of experiences of that entity. At one point, the entity perceives a lower self and a higher self. They are not actually there "simultaneously"; functions of the higher self interact from a position in development which equates to the linear "future" of the entity, as perceived by an entity in this state. Obviously, cultural conditioning encourages development of impotent states of mind where the "lower self" is in control and the "higher self" is reached very little or totally ignored. There is no synthesis that will permit the energy of the intelligent matrix to flow correctly.

How are the cultural states of mind organized? How do they fill the needs of the Orion group and the Brotherhood?

Well, start with the prime factor of body identification. The society promotes the concept of "you are your body", which results in fear, especially fear of "death", which is tied in with the idea of physical pain. Combine this with

M A T R I X I I I

religious doctrine and various cultural ideologies, and you have a very fertile ground for manipulation. There is also promotion of identification with the personality and ego. The ego is culturally conditioned to a reactionary state which is encouraged by media and literature to focus on the elements of security, sensation and power. Under these circumstances, individuals are basically disempowered and blind. In terms of cultural activity, individuals are put in a position where they spend most of their time dealing with "self preservation", "self-gratification", and "self-definition". These functions are basically left hemisphere related. The ego structure often becomes fragmented into "partial selves", making the problem even worse. What is missing is the love of truth, life, and the creator that we are all a part of. The idea is to transform "self-preservation" into right action, "self-gratification" into right feeling, and "self-definition" into right thought. This is not probable in the Orion based culture in which we reside if the missing elements are not introduced. What will help to introduce it is the quickening of the vibrational resonance as we move into the fourth density, and what we are seeing around us is the desperation of the negative forces as they grapple for position and control. The alien agendas are beyond secret government manipulation, and at this time they are very worried. That is why the mind control technology has been developed and implemented - to make sure that they can try and preserve control over the population.

~~~~~

Thanks to the publication "The Sovereign Scribe", we are following this section with some interviews with Al Bielek and Preston Nichols; the material relates very well to the data that you have just read. It features some interesting data about the alleged United States ventures on Mars and more data about the Delta-T antennas. Enjoy!

~~~~~

# Is ours only one of three universes?

by Dietrick E. Thomsen

The usual big-bang cosmology connected with Einsteinian general relativity has the universe starting from a point of space-time that is called the singularity. "Singularity" is a mathematician's euphemism for something difficult to deal with, a point at which physically the universe has no dimensions and infinite density. From this point the universe expands as time proceeds, extending its dimensions and lowering its density.

Such is the usual picture of the expanding universe. But this universe occupies only one region of the space-time that physicists are used to dealing with, the region that lies to the future of the singularity. The question arises: What happens in the other regions of space-time that physicists are able to imagine? Does anything happen in the singularity's past? Can anything happen beside it, so to speak in the regions of space-time called spacelike?

The answer, says J. Richard Gott III of California Institute of Technology, is yes. Writing in the latest *ASTROPHYSICAL JOURNAL* (Vol. 187 No. 1), he shows that if we look for the most general solutions of Einstein's equations, in flat space-time, we come up with three universes. One is our own, which we have just described, lying in the singularity's future and dominated by ordinary matter. Let us call it Universe I. Universe II lies in the singularity's past and is dominated by antimatter. Universe III lies in the spacelike region of space-time and is inhabited by tachyons, particles that travel faster than light.

To understand the geometry of this rather mind-boggling concept, it is necessary to spend a few words on a general description of space-time. In true space-time there are three spacelike dimensions and one timelike dimension. For graphic purposes two of the space dimensions are suppressed, and a two-dimensional graph is drawn in which the vertical axis is time and the horizontal space.

Every point in this two dimensional space-time represents an event: It specifies both the location and the time at which something happens. The start of a particular particle's flight may be one event; its finish, another. The slope of the line that joins them represents the velocity of the flight.

Calculation shows that the lines running at 45 degrees to the time and

*Space-time diagram of Gott's proposed three-universe cosmological model.*

Gott/Astrophysical Journal

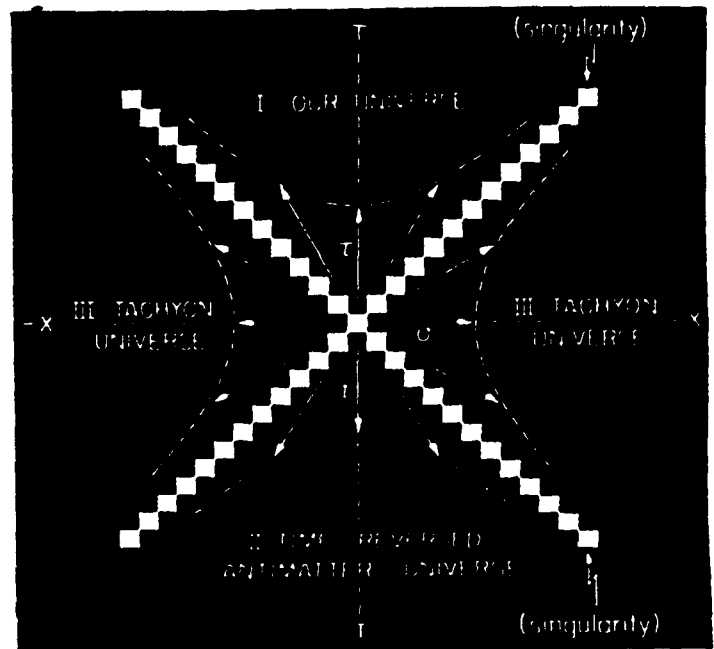

space axes are of particular importance. They represent objects moving at the speed of light (they define what is called the light cone), and in ordinary physics one cannot cross them in going from event to event. The light lines (or the light cone in more than two dimensions) divide space-time into two regions, the timelike (in the upper and lower quadrants) and the spacelike in the right and left quadrants.

For two events in the timelike region (where we live) it is possible to find an observer moving in such a way that the two events seem separated in time only. If observer A sees a particle moving from  $x$  to  $y$  while the time goes from  $t_1$  to  $t_2$ , observer B, who happens to be going along with the particle, will see the time change only. If the particle was in his hand at the start of the flight it will be in his hand at the end. In the spacelike region, in a similar way one can find an observer for whom two events are simultaneous but appear to represent an instantaneous translation in space. Thus in the spacelike region our usual perceptions of space and time and cause and effect are overthrown, but we need not worry about it since we can never get there.

When observer B moves with respect to observer A, from A's point of view the motion represents a skewing of his time axis in the direction of the light line. It can also be shown that his space axis will skew and also in the direction of the light line. The faster B goes, the narrower becomes the angle between his space and time axes. When he reaches the speed of light his space and time axes meet in a grand flash

of—well that's the singularity, as Gott considers it.

There's no crossing it. Gott puts our universe in the upper quadrant to the future of the singularity. His time-reversed antimatter universe lies in the lower quadrant to its past. And his tachyon universe lies in the spacelike region, which is not two regions but one. This can be seen if we add a third dimension and imagine the diagram rotated around the time axis: Regions I and II become cones; region III becomes a wedge-shaped ring.

There is no communication across the singularity. Antimatter and tachyons can exist in our universe occasionally and ephemerally—they are not visitors from the other universes. They are produced here. There are differences in perception: Our view of Universe II, if we could see it, would be that it is dominated by matter and contracting. To its own inhabitants it looks as if antimatter dominates and it is expanding. Finally the principal of causality, which says that neither information nor energy can be transmitted faster than light, is not violated in the tachyon universe. Though the tachyons themselves go faster than light, their radiation, which is the only way they can transmit energy or information, does not.

Gott concludes: "The model we have presented is a unified, time-symmetric model treating matter, antimatter and tachyons in a natural and equal fashion. The model is consistent with our present observations of the universe and could gain support from an experimental discovery of tachyons. . . ." □

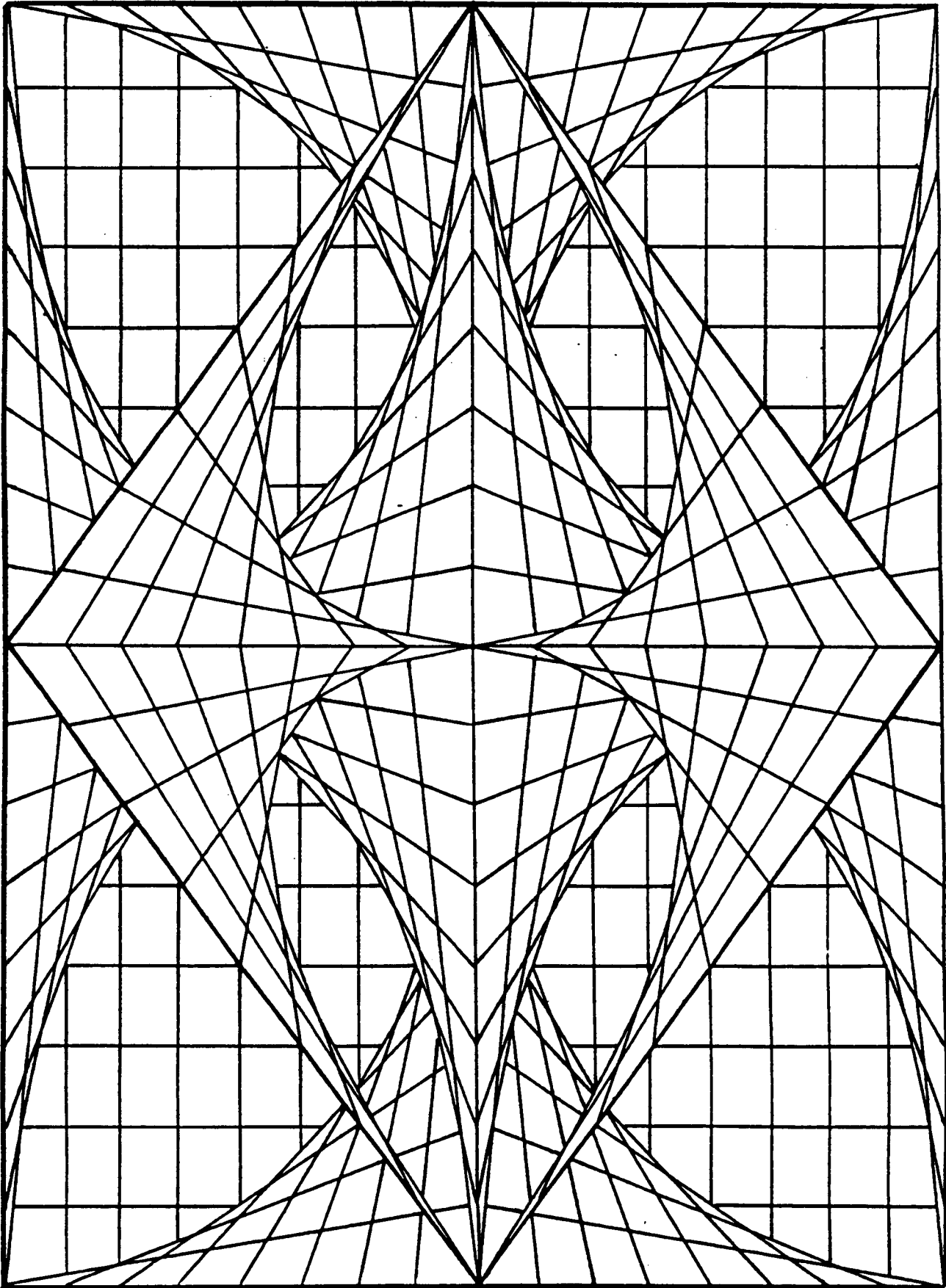

*Interview with Duncan Cameron  
and Preston Nichols*

DC = Duncan Cameron  
PN = Preston Nichols  
SS = Sovereign Scribe

SS: Regarding the Montauk experiments, you said the tunnel was large enough to drive a truck through; where did they drive the truck?

DC: Where did they drive the truck? Well it's a figure of speech that you can drive a truck through. There are all sorts of associated phenomena that pass through whether it be information or people or such.

PN: But first of all, get the truck underground.

DC: ...Something that wasn't ground level. It was underground. It was underground. All the time-space stuff was underground.

PN: It was at the summit with the Delta T structure.

SS: How far down was it?

PN: 1/4 of a mile, maybe somewhere between a thousand feet and 1/4 of a mile. It was way underground. This is according to our recollection. We have no proof of it of course.

SS: Could there be a reason for it being underground?

PN: The reason was essentially they built, see the Montauk time and space portal was essentially an artifact that came out of what we call a Delta T antenna. You have a picture of a big thing made out of wood with wires shaped like this. That's what we call the Delta T antenna. The portal actually appears in the center of that. If you pump this thing right. They had trouble building this above ground because when they started to test above ground the fields from the transmitting equipment were so strong that they had to locate it low enough below ground that there would be a neutral point between the fields of the equipment and the building above ground and the fields from the antenna way below ground because at that neutral point sat the chair that he [Duncan] sat in.

So I have to point out also that they did not want any of the raw pulse. See this antenna took the raw pulse from the pulse modulators of the radar transmitter and essentially put it into Del Cross F Cross E Cross B Cross G function. Which means they were essentially generating gravitational waves that would enfold into space-time waves in itself. And you could make a time-space portal; only one end of it was controllable, such, in '83 you could

# M A T R I X I I I

make an extension of it anywhere in the past, present or future you wished. If I took this antenna here and added in pulses from a pulse modulator in a radar transmitter it would probably wipe out every TV set within about 50 miles of it. But they had to keep this thing far enough under ground so that the EMR electromagnetic interference would not be radiated. Also they wanted to make it big enough. I think it was 250 feet, this one was 10 foot. I think the one we had at Montauk was 250 feet to 300 feet - something like that. This one, the actual portal might be that big [a few inches] but if you've got one that's 10 times the size and is like that you could literally have a portal...I believe the portal size was 10 to 20 feet that they were actually able to create. I could make a portal maybe 2 inches here cause the antenna's small.

Of course above ground there would have been certain construction problems. With making the thing below ground where they have the undergrounders making holes in the floor and pass the pipe and the wires through the floor and the thing up and you don't have to worry the wind's going to blow it down and this sort of thing. There's a number of reasons that it was underground.

SS: And also you said it would be harder to detect?

PN: Yeah, who's going to see it from the air?

SS: Wouldn't they'd pick it up?

PN: Also the Hertzian leakage would be way down if it's underground. It wouldn't wipe out TV in Montauk. Montauk is so far out they have huge power and rotary beams that they can look at Boston or they can look at Rhode Island or Connecticut or New York with. And the signal strength at Montauk is very very weak so it takes nothing to interfere with the TV in Montauk. They don't want to get the town up in arms.

SS: Did they use that to build the legendary city on Mars?

PN: This is the information we have. We have not been able to back it up. It is only memories of Mr. Cameron and Mr. Bielek. I was not involved with that part of it myself. It wasn't that they built the big city. They found an ancient earlier civilization that was abandoned. They first got to Mars and realized that yes, there had been a civilization there at one time and the above ground of it was crumbled back into dust. But they did detect huge underground installations which were still making magnetic fields

and this sort of thing that they could detect and they realized that there was still machinery running underground and of course they first went all around Mars and they couldn't figure out how to get down underground without bringing boring equipment and cutting a tunnel right down in.

When Montauk had the working capability it would be nothing to target the other end of the vortex from '83 through to whatever time they wanted to inside Mars itself and this is what they did. And Duncan himself can talk of stuff he saw on Mars.

SS: What did you see?

DC: Something that has recently come up -- both Preston and myself were in a private meeting in Long Island with a man who was known in the UFO field. He spoke; he was giving some pictures regarding UFO's. He came up with some photographs having to do with the moon Phobos. I reacted to that strongly. When I recall physically, there is a physical reaction and I'm startled. After spending a little bit of time with that -- investigating it, it now seems from my own investigating and outside reading per se... When I say I am reading, I am basically sensitive to electro-magnetics and can access information zones whether they be on a local scale, the Akashic which is in domain systems or out of domain, higher evolved and such.

Information that I got from the outside information zone is that there is a system which still is on Mars. It originally was an electronic crystal type system which was part of the defense structure for the solar system that has been turned off. Defense meaning to keep for ones self. In that sense we all have energy fields about us and there is a *défense* posture to keep outside influences away. If you think on a planetary scale in a solar system, if such defenses were set down, if that were one of the stations per se, to keep out nasties or to keep the intelligence within the solar system alive and dynamically moving, if that were to be shut off there would be all sorts of obtrusions that would not ordinarily come through.

Whether that was one of the directives involved in the Mars project or if that was one of their aims as such or by products, the defense system on Mars is down and there are all sorts of associated troubles and disturbances because of that. It's a linked system that we haven't quite figured out the other aspects of. I could go on, it's just a quick brief thing. Both myself and Al, according to recall, have been there mostly on a directed mission, per se. Sort of like a "seeing eye". Part of my duties at Montauk were to basically to be in sort of a trance-type system and have something pass through me which would be -- how do I say -- for information's sake going places or something. It was one directive system so I can

only tell you on very linear function what happened. Basically I was there just to see about. Basically it would be 300 or 400 feet underground plus the cavern type systems. There are all sorts of symbolical references there. Tonal frequencies. It wasn't necessarily a generator per se, but all sorts of frequencies that were very much alive -- almost as though some kind of intelligence, per se. It was part of my duty to go and investigate and see what occurred. So that was more or less the two things that I saw.

SS: Did you see traveling back in time, did you see a civilization on Mars?

DC: No, not I. Not myself. Possibly with Al. I only had 5 or 6 specific missions that I was involved in, as part of my recall. Having to do with Al I don't know. Until recently I have been denying any associations having to do with the Philadelphia Experiment or Montauk or associated problems because of a denial system within myself so now I am moving ahead and trying to learn and reeducate myself so I am looking out for more information even as we speak.

SS: Did the face on Mars have a function beyond decoration?

DC: That's a good question. I've never looked at that. In that sense I could only be speculating.

Montauk was responsible for conditioning and influencing the consciousness of the earth. That was one of the priorities, possibly, tools to work with to condition and control people.

PN: The information source from what I remember your reading said that it was essentially a defense for our whole solar system. The Mars system would be protecting us as well. That's the first thing they would do was to shut that off so they could get in.

DC: That would make sense.

SS: So if they had it on before Montauk then Montauk went up and shut it off...

PN: Somebody went from Montauk through the portal that was from space point A to space point B probably in real time. The first thing they would do was shut that switch off. They had to somehow sneak into the defenses and turn the switch off. Maybe they had the key to shut it off. I don't know. I wasn't part of that project. I was the guy that did the electronics on the project. I was not involved with who went where. I don't believe I went anywhere particular place in time.

SS: Do you know who is using that kind of equipment now?

PN: Undoubtedly the secret government still has some more equipment. I can't believe that they're leaving it alone. I don't think the monster in '83 scared them off completely. They slowed it down some but I'm sure it's back on line running full force right now somewhere.

SS: Is there any way to detect that?

PN: I pick up signals from similar projects all the time. But signals that Montauk sent out sounded very much like the "buzzsaw that was sawing the microphone in half" that you talk about in your magazine in your first article [Vol 1 #13]. The Montauk function sounds very similar, in fact it's been speculated that they're playing Montauk tapes in these other transmitters and that's what we hear as the buzzsaw. Because the function is the same. It's the same kind of function. It's just a different emulation of the system. Montauk ran at 450 to 470 megahertz. What we're talking of today is 3 to 30 megahertz. But the modulations are the same as far as I can see.

SS: And that includes the tunneling effect?

PN: No, I'm talking about the mind control aspect of Montauk.

SS: How about the tunneling?

PN: Tunneling -- that would work the same because it is all thought forms. But you would have to go in to an actual time warping function such as the Delta T antenna.

DC: We somehow by chance or design ran into some girl in Long Island who I had some association with. She was troubled for a number of reasons and I followed her information basis back on a psychic read type system, and it seems like she was hooked up to something called "Freedom Riders". She had some degree of clairvoyance.

# THE BIOSONDE:

# MATRIX III

How the thing works: when the DOR sensor is connected it sends out a reverse of the DOR patternings and since you have an exact reverse oscillation being built by the transmitter, it cancels the real DOR oscillation. It cancels it right out. Then they transmit the orgone function in phase so it replaces the DOR function with the orgone function that's picked up by the orgone sensor. That is simply in a nutshell how this thing works.

In the '40's, '50's, and '60's, they sent up thousands of these things. There were 200 to 300 of these in the air each day. Now the interesting point to notice here is, if we look at all these different devices, they all have a bottle shape on the bottom— that's the transmitter. And you notice they have roughly the same shape up at the top. This says that there is something esoteric up here in the upper part of the unit, which we don't understand to this day.

Now if you look here, you'll see this is the modulator coil as outlaid in the diagram. It's got the same modulator coil inside this housing here.

SS: What's the power source?

PN: In this case, it's batteries. In the Biosonde it's AC.

SS: How long could they stay up there?

PN: A couple of days maybe. They'll float around until the balloon bursts and they had a parachute that slowly carried them back to earth. They can only transmit for about 3 to 4 hours. You could pressurize the balloon so that it rises to a point and breaks and comes down. Or you could pressurize it where it would float for days.

SS: Is that an actual orgone detector instrument?

PN: Well the thing is, the orgone and DOR output of these things is in the subtle energy realm. I don't know of any receiver that can detect the actual energetic function that is coming out of here, the actual modulation. You listen to this, you only hear a group of impulses. The DOR and orgone is inside those impulses and how to detect what's inside the impulses— I admit I don't know how to do it. I haven't had a chance to analyze it but I got a Radiosonde Receptor which is a receiver built to receive these things. It's a very strange circuit. The answer may be there, how to detect what this is sending, but I don't understand it at this point.

SS: But it's detecting what's there.

PN: You're talking about the actual detector itself.

SS: Yes. It [orgone] exists. The government hasn't said that it exists.

PN: No, they haven't. In Radiosonde circles this flat plate with the black stuff on it, they call a humidity detector. This is what detects the orgone. This little white rod here, this is a temperature sensing resistor; it detects the DOR. But also, this will detect humidity changes. The problem with this is as you dampen the thing, dry it, dampen it, it goes out of calibration. After about 10 minutes of flight these things are useless. These things will hold their calibration for maybe weeks at a time.

But still it was lucky that they sent this up so someone picked up one of these things that came down on the ground. They would see the white thermister between these two thing-a-ma-bobs here and this plate down here. Now the plate sits between these two clips and these aluminum covers go over it. If you follow Reichian technology, aluminum tends to have a focuser for orgone. So they have the orgone sensor here with the aluminum plate over it, the aluminum plate will help pull the orgone to the orgone sensor. Copper focuses DOR. This is why Reich made the original orgone boxes out of steel or aluminum foil, but not copper.

Now this device here is a transmitter. After Duncan did his readings on these things, I realized what I had was a radionics transmitter. Whatever I put in would be sent out. Any of you people sensitive? All you do is take this and hold it. You'll feel your energies build up in it. It might get warm or it might get cool to you. That's essentially a resonator of hyperspatial energies, the psychic energy. And that design can be traced right to Wilhelm Reich through Brookhaven National Laboratories.

See, after Reich developed this package, he called up the government and told them that he had a device that could knock the violence out of thunderstorms and asked if they were interested. The government said, "Yes. We're interested!" They requested Mr. Reich to mail a prototype to Brookhaven on Long Island.

So they waited for a thunderstorm to approach and they sent it up into the clouds. As it approached, the thunderhead broke up and went around Brookhaven. At Brookhaven there was a nice gentle sunlit shower while the area around was having a thunderstorm. So of course they were very interested. They worked with Mr. Reich to replicate the thing.

Now this transmitter, the silver box here, is a nice packaged AC device. We had to have a device that would sense; that's the input well. The first mode we played with was we took the orgone sensor from the radiosonde and just plugged it directly into the transmitter. And now you can transduce your orgone. You hold this [sensor], you plug it in and turn it on. It's like sitting in an orgone box. This is picking up your orgone and building it up.

We wanted to have a fancy witness coil so Mr. Cameron turned on his psychic sense, talked to someone in one of the higher domains, and he said we wanted to build a witness well. [A "witness" is anything that would carry the vibrations of the thing or place you want to sense or contact, such as, clothing or a possession would be witness to a person.] How do we go about doing it? And he channeled the whole design of this device including the well receiver, the circuit board and we made this input well. This input well turns out to be vastly superior to the input well of the Kelly box or an Heironymous box or any of those devices.

Now what this will do for you simply: you plug the wire into the transmitter. Whatever you dump in here [input well] this array of coils and receiver will pick up the electro-magnetic component just as the chair picks up Duncan's electromagnetic component, and will transduce it to be broadcasted by the transmitter. This is essentially a miniature Montauk. Not of the power that they had. And if you put your hand in the well, turn the device on, it would start building up your energies.

How you use Radionics equipment, there are three ways. You can do a diagnosis with a radionics tuner where you get the rates, that where you put the witness in the witness well, you rub the rub plate and you tune the tuner until you get a maximum stick. [As you turn a tuner knob with one hand, you are rubbing a small "plate" with the other hand; when you get a feeling of stickiness on the plate the tuner is at the right setting.] All that's telling you is whatever you're conceptualizing in your mind scans from low to high on the dial is in resonance when you get the "stick". You get several rate number systems you're using, you get the rates [from the position of the tuner knob], you go to the phone book of rates, look it up and see [what the diagnosis is.]

Now over on another column they'll be reversing rates, the anti-rates. So you set the device to those rates, you throw the switch that says "broadcast", and what it does it feeds the thing back so it oscillates and transmits to the person the reverse rates.

Now what is actually happening here? All the device is doing, it's a concentration point that's connecting you the operator to the mind of the subject. As you're scanning through, you're interrogating the subject's mind as to what's wrong with the body. Then when you do the treatment, you're actually instructing the person's subconscious mind what to do. As we all know, the subconscious mind is what directly controls the physical body, and if our conscious mind and subconscious mind stays in touch with each other, our subconscious mind has a foothold in the reality that can regulate the body correctly. As we get more paranoid and more upset and more bent out of shape and more crazy, the subconscious mind loses touch with the conscious mind. It means now the subconscious mind loses its foothold into reality. It doesn't know how to direct the body anymore. That's when we get sick. This is one of the major theories.

Now, if someone comes over and hits your leg with a sledge hammer it's going to break your leg. That's not caused by the subconscious mind losing touch with reality. But diseases that develop from outside influences such as germs and such, can be traced, it's believed by this group of people, to the subconscious mind not running the immune system properly to eliminate that irritant, and you get sick.

So what they try to do is find out, be interrogating the subconscious mind, what is wrong and telling the subconscious mind how to heal the body. The device itself doesn't heal. This is not a healing machine, this is just a broadcaster; whatever you put in the well for the primary witness, you can put any agent, thought form or whatever in the well just as you would with the radionics device. The energetic component of that stuff that you put in will tag along with the witness to the person and you can actually talk to the person's subconscious mind through this.

How you treat people -- there are three means essentially. The most common means is the reversing rate, which works psychically, by the people who designed the equipment. That's why you get the large book with all the rates and reverse rates in it.

Another way is through reagents such as homeopathic remedies, herbs, etc. which work on the subconscious mind and the subtle body. If the herb or reagent is purely an energetic effect, this will transmit the energetic effect to the person without using up the reagent.

Another mode they use was designed by Malcolm Ray in Britain. He made a box with two wells -- the reagent goes in one and distilled water in the other. He had cards that had geometric patterns or messages on them. The cards would contain thought forms. And as energy flowed from one well to the other well, it would impress the thought forms on the target well. The well does nothing with the writing or the ink on the paper, but it picks up and senses the thought that you put on the paper and transmits the thought to the subconscious mind.

## M A T R I X I I I

A psychic such as Mr. Cameron can hold the hand held sensor going through the well and read in the higher realities because the well is designed -- the information that he got to build the well -- was from the same source that put out the information to build the Ark of the Covenant. It's based on the same sacred geometry. So it means with this device you're connected to the higher realms automatically.

DC: The information that we have is it screens out over 97% of the negativity, the disruptive factor and the chaos. It takes the storm out of whatever is being put in there.

SS: Can it be used as a protection device?

PN: Yes, you just take the transmitter, turn it on, put it on a low pulse rate. So it's in position fast or slow. It keeps it simple and keeps it at a low cost to produce. We're marketing them now for sale. We have several testimonies that it is effective as a protective shield. Dealerships are available. The address is:

Preston Nichols  
Space-Time Laboratories, Dept SS  
7 Doris Place  
East Islip, N.Y. 11730  
Phone: (516) 581-1574

The device has a list price of \$1237.00 for the witness well, the transmitter and the hand held device. This is the Phoenix model. There is a cheaper model called the Brookhaven model which has a hand held device, a witness plate and Brookhaven transmitter. This package costs half as much.

DC: It is a simpler device, and is to a lesser degree.

PN: They have different frequencies. One was at 400 megahertz, one at 1680 Mhz, or the equivalent of a 50 watt transmitter as compared to a 250 watt transmitter.

Now we also market a little detector box that sells for \$82.55.

DC: This could be useful if people are concerned about electromagnetic pollution or if they're concerned for example, where they could put their bed to sleep at night. It would indicate "hot spots" that you wouldn't sleep near.

PN: We have the Bio-Field Integrated Sound System, called BIOFISS. How it works essentially is this. It does work. You know, you hear musicians talk of that they project when they play their music. Actors project. What do they project? They project themselves, they're projecting their biofield.

Now you have a microphone standing up there in front of the orchestra recording all the noise that comes off of the orchestra. The tape has a very nice low distortion, high fidelity representation of what sound was hitting the microphone diaphragm, and all that stuff. I'm sure I don't have to go through how music is recorded and played back. But what is lost in most reproduction is that biofield component. That's why we have the Bio-Field Integrated Sound System.

The equipment has a special circuit in it that picks up and recovers that biofield component and the amplifier and speaker is especially designed so that it reproduces and projects it. It's interometry to the speakers projects at right angles. You sit at the cross point. At that cross point the biofield of the original performance is constructed through the equipment. And you sit there. Your mind senses the biofield component. That biofield component has all the missing dimensionality that the bimonoral recording is missing. And your mind fills in the three dimensional aspect and it sounds holographic. It sounds real; three dimensional sound.

Now the second part of it is what we call the Mind Field Amplifier. Opposite the two speakers we have two pickups. They pick up the biofield component [of the listener] and cycle it back. If you turn the thing on without music it just feeds back on itself like that awful screech everybody hates. It feeds back. Now when you sit at the cross point you become like a crystal in a citizen band radio and you fix the oscillation to you. Now it's feeding back your own vibes to yourself building them up. That's why we call it the Mind Field Amplifier. It's amplifying your mind field. You can do this to an extent with the Biosonde also. With the Biosonde if you put your hand in it for awhile and you hold the sensor, it builds up your field in a similar way.

Now if you play music through the speakers what will happen is the pickups will pick up the biofield of the music and will pick up your biofield. Since the sensors recover through a multiplication process it will multiply your field and the music field and produce a different product that will be a new biofield component which is made up of you and the music and you can accept that as deep as you want to. And that's the whole Bio-Field Integrated Sound System. Or BIOFISS for short. Or another name for it is the Mood-Changer. It relaxes you right out.

Now the other explanation for the general public is just as in Bob Becker's book Cross Currents. He talks of the brain being very sensitive in magnetic fields; the speakers are magnetic drivers. They produce a very weak magnetic field. The correlator realigns the magnetic component to the electrical component and the speakers and amplifiers project the magnetic component at the subject and the component magnetically detects the missing dimensionality. That's the non-psychic explanation of how the thing works. That's what we tell the general public of how it works. The same exact

thing is true except you replace psychic energy with magnetic fields, because we already know magnetic fields are the key to psychic energy. So are we saying the same thing? Yes we are just a slightly different way.

We make a CD player. Digital sound will sound like analog sound.

DC: But with the crispness of it, the high frequency range of the digital sound. The digital is flat, it's kind of without personality.

PN: This puts the personality back into the digital sound. It makes the CD player sound better than a phonograph. If you get the reproduction of the music where you don't get all the distortion and noise components of the "phonygraph". That's why I call it a phonygraph. If you've been following the audio trade, there's a lot of flack over digital sound that digital sound isn't bio-positive, it isn't good for you, it sounds awful. If you take a CD player and put it into a Japanese audio amplifier into a typical Japanese speaker it all comes out screeching, shrill, very irritating. But it loses that irritating property. It will actually sound better than the phonograph record that was made from the master tape that the CD was made from.

CD's are digital audio compact disks. It's a digital recording. Generally what they do is take the analog signal, digitize it, store it in optical patterns of dots on the CD. That CD has the psychic energy component as well as the phonograph record does. In fact if you buy a BIOFISS or Mood-Changer to play phonograph records what are you going to end up with? You're going to end up with a phonograph but the signal is going to be digitized and then processed. Which means that you will end up with a digital phonograph because in order to recover the relativistic psychic component you have to sample it. What happens is when you sample it then the 1's and 0's, the good energies are carried in phase which means the 1's and 0's and the bad energies are carried out of phase, which means the 1's and 0's. So if you correlate the 1's and 0's you cancel out the bad energies and bring up the good energies. Now you could also bring up the bad energies but we won't build a device to do that.

SS: Speaking of energies, how do you perceive the vibes in this area [Yelm-Olympia]?

DC: There's quite a difference between the Ramtha School and coming up near the military base. It's all very changeable. Curiously enough the military base is almost squeaky clean, remarkably. It's almost like it's in a void, that things have just been sucked out of it. It's just there. It's unusual.

The Ramtha School is highly protected. They have their system there which is good. It's to keep everyone out that's not supposed to be... on the metaphysical. It's good that way. I don't think I'm violating any privacy. It's just a matter of fact. The patterns that come out of there are friendly. They're not chaotic in that sense. It's for the good. Information that we got on the Ramtha system, it's an intelligence that is just about to go on to the next stage.

What Preston has categorized the domain structure, an intelligence form, there is an evolutionary growth from the highly chaotic system, highly disruptive, if we could use the word satanic, evil or hell is another word, negative, degenerative system as opposed to regenerative, the higher or the god function or the intelligence of knowing it all. We are supposedly in that middle ground considered the fourth domain.

The information that we specifically got about the Ramtha intelligence form, spirit, is that it is just about to move on into the fifth domain structure and it has a wealth of information from this realm from which we work this domain structure. So it would be an excellent source for information and guidance for those who are proceeding to make that jump off into the next realm which supposedly is somewhere, curiously enough, the Bible also speaks of it in the 2012, 2013, 2014, 2015. There is a change and there's a physical realm that's confirmed by people who have nothing to do with the Bible. So its coming from all different sources.

PN: Ramtha may even eventually be a guide for mankind to go into the next realm.

DC: If that process is about to move on, then it knows, it's intelligent enough, it's aware. So it could be comforting in that way.



# M A T R I X I I I

PN: I think we should also say about Ramtha... what's the woman's name? J.Z. Knight... essentially what is being said here is J.Z. Knight is the only one that Ramtha comes to but if you're the kind of psychic that can project out you can go to Ramtha and Ramtha, 50/50 chance, may still talk to you. He [Duncan] can go to where Ramtha is. J.Z. is probably the only one where Ramtha will come to her. But many other psychics have talked to Ramtha beyond another plane. If you can get yourself psychically raised high enough where you can actually leave your body and go to these other realms then you can make it to the realm that Ramtha is on which is the seventh level or the fourth, you can find Ramtha and all who are his friends. There's a whole number of them up there. Ramtha's not the only one. There's loads of entities in the sixth and seventh realm of domain.

DC: Of course if they're higher evolved they would have...

PN: ...information basis.

DC: Sure

PN: Tremendous information basis.

DC: And if a person is kind of headed towards that they would be allowed to have the information.

PN: If someone comes to me and says, "Is so and so genuine?" and there's reason to check it, all I'll do is work with someone like Duncan and he'll go find so and so. Like there's a gentleman in New York City by the name of Michael Morgan who channels an entity known as Yokar [sp?] who is supposedly a disembodied scientist from Atlantis who's up in the fifth of our domain, not quite the sixth. Ramtha is higher than Yokar and Duncan went and found Yokar and talked to Yokar just as Duncan went once and found Ramtha and talked to Ramtha. And we were able to verify these entities do really exist.

If someone says, "I'm the only one who can reach so and so. It's impossible for anyone else to reach so and so.", my eyebrows go up to the top of my head. Because I know that there are other ways to do it.

Now I would not argue with J.Z. that she's the only one that can channel Ramtha, because Ramtha comes to here. But I would challenge to the effect that there are other psychics who can also reach Ramtha but not in the same context that she does. Because Michael Morgan and J.Z. do an actual inhabitation where the entity comes in and speaks through them. The people I work with don't do that, such as Duncan. They go and they can ask questions of the other person. But when they're in a trance to do that, Duncan especially, does not have a tendency to tape what he picks up... to tape what he picks up with his mind because his conscious mind is almost deferred when he reads. You can see it when he reads.

SS: What do you know about AIDS?

PN: Well, let's start with this. If you get I think it's Scientific American, they had an issue devoted to what the medical profession knew about AIDS. I may be wrong on the date. In that issue was about three articles on what they have learned about the cellular operation of the AIDS virus. What I gleaned from that article is that the AIDS virus is engineered, however it got engineered, to essentially exist within the host's body structure and has enzyme interactions that will turn up its replication rate or turn down its replication rate depending upon the enzyme balance of the host.

What this means essentially is the thing is designed to under normal conditions, whatever the normal condition is in the human body, to replicate just fast enough so it has a life cycle, lives out its life cycle but does not cause any problem for the host. The thing is designed for a symbiotic relationship between the virus and the host. Of any other retrovirus it does exist within our genetic structure.

Now if I was going to engineer a virus to do what AIDS is doing, and this is what the people who believe AIDS was manufactured are saying, that the virus was made to do this dastardly thing, I would not have engineered it that way. I would have engineered it so it would go hog wild no matter where it went.

Now this suggests to me that we have had this virus ever since the dawn of time and as long as we were in a pure enough environment and all this good stuff and the enzyme balances were correct within the human body they wouldn't cause any trouble. Now because of the pollution in our society, the electromagnetics in our society, that can be shown unequivocally that magnetics and electromagnetics can affect the enzymes of the body. There's been copious amounts of research written in research on this and that definitely very low power, low level magnetic fields can affect the whole enzyme structure of the cell.

So what I think has happened is that our whole enzyme balance has changed because of the chemical, air and electromagnetic pollution, and now the enzyme balance is triggering the virus to replicate abnormally and go wild, and that's when we get the AIDS.

Now I believe definitely that the government has thoroughly researched this, probably years ago, like 10, 15 years ago, maybe 20. They know what it's all about, they know how to control it and they're just sitting back letting this be one of the "Alternative Three" scenario ideas of reducing the population and that they're letting it run its course and when it's gone far enough they're going to introduce the cure. I believe the cure is purely electromagnetic. The reason I say this is the electromagnetics that are around my property spread out far enough and there has been rumors, I'm able to trace them down, that when they moved into the East Isip (N.Y.) area they had AIDS and the whole AIDS thing subsided when they lived in East Isip for about anywhere from 2 months to 6 months.

That's essentially what I said about AIDS yesterday [in the lecture]. And that is my belief on AIDS. I do not believe it was a manufactured disease. I think it's being used opportunistically.

SS: You mentioned in your talk about Montauk and the old universe...

DC: There were a number of survivors, if my information is correct, of the old universe. If Montauk was as good and as manipulating as we believe, the concept was, those people who had a connection into an old Earth function -- we call it the old universe -- if they were coming from a system that was highly chaotic and had come into here into this framework, if those people had a connection with such a system that was basically going to the more chaotic side and if Montauk was trying to bring in a great chaotic system, and somehow the control group got wind of this, there could be... and what we have information on was an attempt to try to bring in this high disruptive value. There's all sorts of associated other rumors in regards to this. It hasn't been factual; we don't have a lot of information per se. But there is some evidence to support some of what appeared in Star Wars, indeed is a fairly good account of an old system that was basically falling apart and is growing more and more chaotic.

SS: Old in terms of time and space, or are we talking about a parallel universe?

PN: It seems like to me it's a parallel universe thing. The legend base is essentially that a long time ago there was a parallel universe. Probably most of mankind was in that old universe. It evolved into a totally despotic form of government that took hold and held for millenniums, which is essentially what the One World Government has here. They will be starting up a despotic form of government and through their technology base they're able to hold the population pretty much the way the mind control here is heading. And what happened was a small rebel group that were fighting this, and the fight continued. It went on and on and on just as in Star Wars.

But somewhere along the line another group of beings entered the old universe. They came in and did something terrible. The legend has it that they were a life form, essentially ape-mind energies of sentient beings, but they would suck the life energy out of you. They came in and there was nothing they could do to stop them. At that point a small group of what was left put all of the technology that they had into breaking the dimensional barrier and broke into this universe, but sealed the hole up enough so that this other life form could not come into this universe. There have been suggestions at Montauk that they were trying to bring this other life form in. We have very little data to back that up at all. This is pure legend at this point.

SS: There's a lot of science fiction like that.

PN: Yes. That probably is based on almost like a racial memory from a long long time ago.

SS: What were you referring to when you spoke of the Montauk chairs?

PN: There were two generations of the Montauk chair. The original generation was built in a site know as ITT World-Wide Communications / Makay [sp?] Marine in Southampton Long Island. That one looked almost like a multi-pyramid structure with three coils. With that one they were able to use a more standard receiver structure. They use the ITT Makay Radio, what they call an ISB receiver which was based on a 1950 Hamilin [sp?] short wave receiver, the same receiver I used to listen to the "buzz saw". They made a very special carrier synchronizer system in what we call ISB detectors which is upper and lower side band. So it means you have two outputs and one input for your receiver. What the outputs would look like would be an imaginary carrier and then an upper and lower information band. They would tune the receivers to three of the hyperspatial window frequency channels. So you would have an upper part of the window and a lower part of the window. So they actually had six outputs from the three receivers, two for each receiver.

Now the carrier processing -- they would take... lets say you were detecting the X coil, they would take the Y and Z coil summon and then use that to modulate the X coil and do the same thing for the Y and the same thing for the Z. And the synchronizing system that they'd come up with on

## M A T R I X I I I

the suppressed carrier ISB reception was such that it was what we call a phantom-phase-lock-loop system where you don't even need a carrier to lock. The thing locked on white noise. So that means the thing would lock itself on the Delta white noise in the window frequency.

That's how the first chair was built. That had to be a distance away because that was subject to the incoming fields. They had to locate that far enough away so the transmitter didn't interfere with it. It was microwave length from Southampton to Montauk.

Now they had problems with it because if the information was being sent and the reality glitch or a reality shift happened it was a glitch in the information. You've got to remember the Cray-1 computer at Montauk was working on timing functions so the timing of the six data streams was very critical. For some reason they did not want to move the Cray-1 to the Southampton installation then send the two channels of digital information on the microwave length. Maybe there was configurations in the Cray-1 that were much more secret than the chair was at that point. The Southampton's installation of course wasn't as high a security installation as Montauk was.

They went with RCA for the second chair. RCA built the second chair. RCA had receivers which were already designed on the Delta T function. So it means instead of having the Delta T and the coil structure, the Delta T function was now in the receivers. So now they're able to use standard XYZ Helmholtz [sp?] coils. Then the new chair was underground at Montauk and sat in a small Room where the coils were close to the chair. In other words, let's say Duncan was sitting in the chair. There there would be coils on both sides of him, around the head and around the feet, then more coils on the top and the bottom. They were hooked to three very specialized receivers designed in the 30's by Nicola Tesla which had Delta coil structures in the receiver stages. Then they used the same type of IF detection with the synchronized oscillators. They used the ITT Makay-phantom-lock design on the RCA receivers. In other words, RCA combined the lock-up system of the ITT with their Delta T receivers, so the receiver looked almost identical in design. It had the same six channels of output, had the same upper and lower side bands.

SS: But much better design.

PN: The front end was a Delta T design. They didn't need Delta T in the coil. Now the Helmholtz coil structure can be... the coils can be phased where they're insensitive to outside influences. So that means they're able to operate at Montauk directly and they didn't have the data problem of going over a 20 mile microwave length and getting timing glitches every so often that would throw the whole thought form transmission helter skelter.

There also is believed that there is a third chair set up in Britain on the Thames River. We call that the Thames Chair; we don't know exactly where on the Thames River it is. That comes up in readings. The other two chairs I have direct memories of 'cause I was involved in designing the RF equipment that was used with both chairs. So I did see and I do recall both coil structures and both receiver setups at this point.

SS: You said you could tell somebody who had been through Montauk by their aura?

DC: Yes I do.

SS: How? What do you see?

DC: Basically there's a color attachment to it. It's a yellow-green nauseous attachment, if I could use the word. That's the only thing that comes to mind directly. It's the feeling as though someone had that aura of leprosy, so to speak. He was an outcast, that had this strange queerness about them which was as though they were, let's say, buried underground for years alive, having that sense of strangeness or queerness about them. It's very distinct. If you've been exposed to it and had the sensitivity to see it it's really around them.

SS: When you say attachment, does that mean it's just on one area?

DC: It's within the auric structure and there's also attachments that go outside. It's also associated strings attached to the people, as the psychic type energy functions that are in association with a person and outside. All sorts of tag-along are associated to it.

SS: And these attachments are still attached to something on the other end?

DC: Oh sure. It's not a healthy energetic structure of the body which, if the system is working correctly, it does clean itself back to its original process. It's an indicate of things that are askew, for sure.

SS: We've heard of putting magnets on your body to increase the energy. Are there ways to do this by magnetics besides by using electronic devices?

PN: Well the thing you can say about magnetic fields is that a magnetic field is the portal or window into the shell function or the anti-matter world. So a magnet definitely is a multi-dimensional window. Magnetic fields are pure potential energy, they're a pure potential structure. Unless you move them, they don't do any work. If you move them they do work. This of course is normal physics at this point.

So the body is needing the magnetic potentials that are good and vitalize you. I've also seen people that magnets have a tendency to drag down instead of build up.

SS: Someone we know experienced that. He was unknowingly sleeping beside some heavy magnets and woke up drained of energy. Perhaps the magnets were facing the wrong way, if there's a difference.

PN: Yes, there is a difference. There's also another kind of ray that comes off the sides of the magnet between the north and south pole. It's almost like a ray emanating into a black hole, is the only way I can think to express it.

DC: It's something that we've recently been exposed to by a fellow named Jerry in Staten Island, New York.

PN: He's a psychic that sees magnetic fields. Those plates we put in the Biosonde yesterday were from Jerry. There is a coating of, in black paint, of magnetic powders that somehow he's witnessing to the Earth through the telluric field of the earth. And all it's doing was transducing the orgone field of the earth into the room. That's why you got the cool breeze going through the room. And that's tied directly into magnetism.

SS: At the lecture you mentioned "entrainment"...

PN: The esoteric database that we subscribe to believes if you can entrain 10% of a system you can entrain the other 90% of the system. Which means

if you can raise the consciousness of 10% of the population the other 90% will fall in sooner or later. They'll fall in just on the fact that 10% are there. This can be backed up... we have what we call the museum, which is a whole stack of radio receivers. We found that if you can tune up 10% of them, the other 90% of them will fall into the pattern, no matter where they're tuned. The level seems to be 10%. If you're like at 8% there's partial entrainment. 10% is full entrainment. So the plateau seems to be 10% from the viewpoint of physics. Why that is we can't explain. It has something to do with frequency transformed and this sort of thing and we can't express it at this point.

SS: Does the frequency make a difference?

DC: What is the prerequisite is the intent into the tuning. To have intent and follow that intent as you go along. And when you start resonating with that intent you get a vibratory pattern which is gracious to it and falls into it. Then you follow that along and get 10% then the rest fall along behind it. But it's the intent for sure.

This interview provided courtesy of  
QUANTUM COMMUNICATIONS.

# Interview with Al Bielek

1991

Al Bielek, noted lecturer on the famous "Philadelphia Experiment" and the time travel/mind control experiments of the "Montauk Project," recently spoke with The Scribe interview team in Yelm.

Bielek gave an update on the current use of mind control and psychic warfare, and also offered a more detailed account of his experience in the Montauk Project. Montauk, also known as the Phoenix Project, used Bielek and his brother Duncan Cameron, to explore the underground cities of Mars.

SS: Sovereign Scribe AB: Al Bielek

SS: *Regarding your experiences on Mars, you walked through the time tunnel, you take a step and you're on Mars. What did you see?*

AB: Well, I was not on the surface of Mars. We were in the underground. The story goes back to the Alternative 3 book, the TV production in England outlining the fact that we have Mars bases, one or more, provided by a joint operation with the U.S. government. I do not know if the Russians are in on it - and aliens. They are on the surface bases...It's a World Government operation really, that's not strictly the United States government.

After they were on the surface which was about 1969, they found that there were entrances to the underground sealed and they knew there was something down there. The rumors were that there was probably artifacts from an ancient civilization buried underground because there were a lot of remains above ground, ruined cities that have been there by NASA's estimates maybe 300,000 years, 250,000 years. But they found the entrances all blocked, all sealed off to any underground areas. So the word went back through communications (in the late 70's) to whomever back to the Montauk and Phoenix project, "Can you do anything about this for us? We can't get into the underground of Mars." They said, "Yes, I think we can. Give us some coordinates on the surface of the planet. We'll have to run astronomical computation." Which they did and plugged these all into the computer. They wanted two people to go and it happened to be Duncan and myself.

SS: *Why two?*

AB: To corroborate what the other one saw and also in case there was any problems in the underground. They didn't really know what was down there.

So they sent us and we went up there in the underground. [using the Montauk Time-Space "Tunnel" device, developed as a result of the Philadelphia Experiment. (See Scribe issues 9, 13 and 14.)] There was a problem with light. We had to take lighting with us at the time. Later on, if I remember, we found some of their light sources and turned those on. We found eventually that the last remnants of the Martians, if you wish to call them that, died in the underground between 10 and 20,000 years ago by estimate, and they left everything they had of their civilization underground. We found enormous amounts of statuary which appeared to be religious.

SS: *What did they look like? How big were they?*

AB: Typically 6,7,8 foot tall, stone, gems embedded in them and so forth.

SS: *These were of human-like people?*

AB: Yes. They were quite well preserved. Then we found archives. We found a lot of scientific equipment. We found electronic equipment down there; tons and tons of stuff. And the rumor was also later that...I didn't recall until Duncan reminded me of it about a week ago, he said, "Don't forget the 17,000 metric tons of Martian gold they took out. According to his recollection of it, it was very strange gold. It was 5 times

denser than ours. It was worth an unbelievable fortune. Where it went we have no idea, but it was returned to Montauk and from there it went somewhere. There were several authorized trips. And Duncan and I got the bright idea since everything was in the computer let's take a trip or two on our own and do our own exploring. So we did. After the second one it was found out and we were stopped. That was when he got into the archives and found enormous records of the civilization which was buried down there.

SS: *What did you find out?*

AB: He as the one that read them. I couldn't read them.

SS: *He didn't tell you?*

AB: No. Well he did at the time but I can't remember any of it now. It's a very strange memory. On again, off again, and that part of it was never made clear to me as to what he really found. Right after that we were removed.

But I do remember some of the other installations we saw down there. They had very odd, large generators of some type. If you did not see it, I recommend that you go see the movie Total Recall. In fact it was seeing that movie that reminded me of the fact that I had been there. Not the colonies but the shots of the underground where they showed these large, round canisters where the director said these were probably for oxygen generation. I'm not quite sure but we think so. I looked at them and said, "They're not round. They're hexagonal." And I asked myself, "How the hell did I know that?" So that was our view of Mars from the underground. We didn't see hardly a thing of it from the surface.

SS: *Did you see ice under the surface like in Total Recall?*

AB: Ice? No.

SS: *If I remember in the movie, that's what they melted a lot of ice to create the atmosphere.*

AB: It was not ice under there. There were oxygen generators and they also had some storage. There was a generating system which apparently the ancients had left. I don't really know much about it. but it was activated before they moved the surface colonies in. They also melted down the polar caps. The rumors are that they used a hydrogen bomb or two for that. I don't know if that's true. But they did melt down a lot of the polar ice so they would have some water. It's still sparse but they have it. The atmosphere is thin but they have atmosphere. And the temperature is warm enough. In the equatorial region they have no problem surviving. It runs about 50o and of course the astronomers have known this for about 50 years or more. It's quite livable in terms of temperature.

SS: *The lighting that you mentioned. What was that like?*

AB: Unknown form of illumination, after we found out how to turn it on. Some of the power generators are still working. After we turned on the underground lighting we had no lack of light. Otherwise we had to carry our own and portable lighting was not all that effective because we were dealing with larger underground chambers, several hundred feet across, high ceiling and portable lights are not very good for a large chamber like that. Eventually we found where they had their own lighting. It was very bright.

SS: *Have you any information on the Face on Mars?*

AB: Not that I remember in the underground. There's more than one face on Mars, by the way. They found several. But I remember the NASA announcements some years ago, about 2 years ago that they're receiving a low frequency radio transmission from Mars. It was about 50

kilohertz, if I remember correctly. Quite a low level indicating the equipment or whatever it was that was generating the RF signal, and it was coded, was quite old and probably nearly worn out, so they were amazed there was anything still coming out of it but it was enough of a signal that they could pick it up and put it through the computer and transcribe it. It was a warning. A warning message to humans not to repeat the mistakes they made.

*SS: Do you have any feelings about being on Mars? What were your general impressions?*

AB: We were digging in the remains of an old civilization that preceded ours and it felt very peculiar. To look at what was left at what was once a great civilization and realize that they literally died there and left everything behind and that eventually the thing shut down. It was in the underground deliberately apparently as survival because the circle cities had long since been destroyed and they lived down there and stayed there.

From what I understand of it, a number of the Martians survived whatever the attack was on the surface eventually took off for Earth and others decided to stay behind on Mars in the underground. And quite literally their progeny eventually died out and the whole race that was left behind on Mars died out. It's rather a strange feeling to realize that the remnants of a race died out in the underground totally. They just left all their hardware behind.

*SS: In Rod Steiger's book he spoke of March 18th and 19th, 1990, as being important dates in the history of the Psi-Corps. That during those dates their equipment was zapped and all the psychics resigned March 20th. Could you explain all this?*

AB: Well, basically what had happened was a very strange story. In January 1990 Psi-Corps received some new hardware because NSA has been working on this for years; psionic-type hardware that boosts the mind and its capabilities of people who already have a great deal of capability it becomes quite formidable.

They found themselves, after that infusion of new equipment, after learning how to use it, with the capability of locating a picture buried in someone's files anywhere or tracking a missing file or missing information that they had instructions to recover or locate. They didn't do the recovery they merely located it. And how we found out about this was a very interesting story.

Back in November of 1989, Duncan had told me, he said that I would have the proof of the Philadelphia Experiment in my hands during March of 1990. Well it seems like during that weekend, that particular Sunday, preceding the walkout, I was in Phoenix. I was out for lunch that Sunday and a phone message was waiting for me that Preston had called and he was in a panic. When I finally got him on the phone it was already too late. But he told me that a person had visited him.

You see his father had been a senior scientist in the Navy working on the Philadelphia project. And that before the scientist died he told his son what had happened; that he had certain files and that he was turning them over to his son but he advised his son not to ever tell anyone about it. So this guy, unidentified to me never told anyone about what he had.

One week prior to the visitation with Preston he gets a knock on his door. Government agents. "We want to search your house." "Well what for?" "Get out of our way." And they start tearing his house apart. He knew what they were looking for. He didn't have it there, but he said, "I don't know what you're looking for." And they didn't find it. It took several days. And he shook them. And he went and got his stash of files which contained two roles of film of Rainbow 3 and Rainbow 4 which were the two Eldridge tests plus a stack of papers, still highly classified, apparently, from what Preston said, because they wound up in Preston's hands.

So he started calling his friends to see who could take care of this and take it off of his hands because the government agents were right behind him about two hours right behind him trailing him. None of his friends would touch it, those that he got through to. And he finally got to the end of a long list of people and Preston Nichols was at the bottom of the list. He called Preston and he was home. He said, "I'm coming over to give you something." "Well what's this all about?" "I'll be there at such and such a time."

He goes over and hands him the file and the film and tells him the story about his father and the government agents and so forth. Preston says, "Well what am I going to do with it?" He says, "I don't know. It's your problem now. The government agents are about two hours behind me." He takes Preston out and shows him his car with bullet holes in the door and he says, "I'm getting out of here." And he left.

Preston in a panic tried to get a hold of anybody he knew that day, including myself, I was not reachable. Duncan, previous in that morning, got wind of something, due to his psychic sensitivity, something very heavy coming down. He took off from Preston's, went home, went into his bedroom, locked the door and crawled under the bedsheets until about 5:00 that afternoon. This is a fact. He panicked. He would not even answer the phone. He shut off his answering machine.

So this comes down. Preston can't get a hold of me. Finally when he did get through (I called him) he said, "Well I called up NSA and told them I had some very hot material here that I don't want." They asked "What is it?" And he told them. They said, "Well we don't want it." He says "I've got to get rid of this stuff it's black card clearance level. So he said, "Alright we'll send some F.B.I. agents to pick it up. So they eventually arrived and he turned it over to them after verifying that they were F.B.I. He got rid of the whole business. Then I called after that, and I still haven't forgiven him for it. But the interesting connection to get back to your question about the Psi-Corps, is that we finally put together the fact that with the new equipment they were able to identify a photograph if it's in somebody's file and apparently they have standing orders to find any information whatever dealing with the Philadelphia Experiment and make damn sure I didn't get it. And they spotted something and found out who this guy was and they sent out the government agents and this whole story ensued about this man who's father was the senior scientist. And we don't know what happened to it. We never saw it again.

In any case, the next day, from information I had, there was a big rumble in the Psi-Corps, and they were warned by somebody on the outside who was a little friendly to us to get the blazes out of there, that all of your installations are going to be melted down, literally. And they were warned to get out. All of them walked out except ten who were brand new recruits who had been told to defend the machines with their lives and they did literally. They died, the rest walked out, out of the government's service and disappeared. There was a panic meeting with the President...

*SS: Who melted the equipment down?*

AB: Alien...there's none...let us put it this way - extra terrestrials.

*SS: Do you know who they are?*

AB: Yes, but I will not say.

*SS: Are these the same E.T.'s that Preston said melted down the buzzsaw antenna at MacArthur airport around the Thanksgiving weekend last year?*

AB: Yes, basically. And they took care of four sites in the U.S. one at Fort Meade and there were three other locations. I believe one was Atlanta and another in the New Orleans area and one somewhere in the West. Everyone of them walked out and disappeared. The locations were melted down. The President had a panic, practically apoplexy, tried to call back the old director who was in retirement. He said it was an emergency, we need to talk with you. So he came down to talk with them. I'll only give this man's first name - it's Emil. He was already 90 in age. And they told him the problem. He said, "I'll look at it but I won't give you my answer for about 3 days. I'll tell you then whether or not I'll come back and reorganize this whole operation for you."

In the meantime they contacted NASA to try to get NASA to give up their psychic agents, not Psi-Corps, who are trained for a different mission and are not trained in pairs but individually. NASA told them to go shove it and got away with it. They said, "We're not trained to do the work you're doing. You can't have our people."

So finally on that following Friday, Emil came back to the President and said, "My answer is no. There's no way I'll come back and do anything for you. You're in deep trouble as it is and you're going to be in a lot deeper trouble in about 30 days." And he packed up and left. And I presume that that was the last we've seen of him at least in those quarters.

But the Psi-Corps remained dissolved until...they tried to recruit new people and they did pick up a few but nothing like what they had before because it takes 4 years now to train them, it used to be 5.

*SS: So they're building it back up again.*

AB: They've been trying to build it back up. Then before the beginning of the so-called Mid-East War with Iraq, they made a deal as part of the situation building up to the declaration of war wherein we got all of the backing from British European nations with the exception of Germany, they went to them as part of the deal and asked the British and French and Russian Governments, who already had their own Psi-Corps, if they would loan certain numbers to the U.S. Government for their operations. And they did. They got transfers and built up the whole organization to the original strength overnight.

Now they had a little bit of a shock because the new group tried to bring somebody back into their group to run the operation, Emil, and from what I understand, he was spirited out from right out of the midst of them, again by E.T.'s, and they were told this could never happen under any circumstances, that they were ultra-secure in their facilities. That shook them up. They all walked out. They are now at point zero.

*SS: So they walked out a second time.*

AB: That's right. That's the information I have. And the government is left holding the bag once more. And as far as I'm concerned they can continue to hold the bag - empty.

Psi-Corps organization is not vicious, they are not vicious people, they're very well trained, sensitives and psychics who have a mission. The basic mission has been, in more recent years, not the original one in the first 5-10 years, where they were used for assassination. But they finally drew the line on this when NSA was formed and they became part of NSA in 1949-50 because their original genesis was in 1940 under Harry Bennett under the Roosevelt administration. But they said, "We will not do assassination anymore because you have other organizations and intelligence groups that can do this much better than we can so we refuse to do it." But everything else they would still do and that was basically: psychic espionage in this country, outside this country and anywhere on this planet; obtaining information about anything that the government wanted to know that was not obtainable through the normal intelligence channels; or say too many agents got killed or something; let us say they wanted to look at the inside of some super secret Russian or Chinese installation or whatever it may be. The psychics could look inside of it and see what they want. They could read books off their desks, reports off a desk, filch them out of a file.

*SS: They could de-materialize them?*

AB: Yes they could. They could start a fire in a filing cabinet a couple thousand miles away if they wanted to do that or if were so instructed.

*SS: They could plan disinformation also?*

AB: Theoretically they could. They could transport small objects. They had their psycho-kinetic ability well trained. It was not that they could move large objects, they couldn't. But small objects like a piece of paper or a small package of paper like a report they could handle. They had a lot of capability.

They were also very heavily brainwashed and very heavily...lest us say, indoctrinated in the government's service and what they were to do and indoctrinated to the point that they totally accepted the protocols under which they operated. And this of course meant that they were loyal to the service, to the government. The only mores and ethics they knew was what the government told them they had and this was implanted, impregnated, conditioned into them to the point where there's hardly any change. I've only known of two people, I will not go into this in detail, who decided to walk out and succeeded in doing so. But when they surfaced it started the largest manhunt in the history of this country to find those two and bring them back into the government's service.

Preston saw the police reports, the F.B.I. file reports because the police cars came into one of the swap meets, drove right up the aisles where there's not supposed to be any car, virtually pushed people out of the way, stopped right at Preston's exhibit and said, "You're friends with \_\_\_\_\_." Preston says "What are you talking about?" "You know what we mean." And Preston looked down on the police car's front seat and there was the F.B.I. dossier and the picture of the individual and the names of both of them they wanted, and if any information is obtained about the whereabouts of these two, I'll not give the names, report immediately to the F.B.I. office in Philadelphia, Pa. They never did catch them. They were much too smart. They knew what they were doing.

They also stole a few pieces of government hardware in the process including...I might as well say it...the government has alternate reality generators, the portable type a person could carry in a small suitcase and they can ship themselves and that suitcase with them into an alternate reality and they cannot be traced. They cannot be found.

*SS: Kind of park themselves in another...*

AB: Park themselves in another universe, so to speak, parallel to our own, very similar to ours as I've gone into in my lectures, the parallel reality thing. The government has the hardware for this, portable. They've had it for years. I don't know how long. And they had it and used it to keep out of sight and they would every so often look in on what was going on and find out the police were there and they'd say, "Well, they can stay there, we'll stay here."

The final outcome was these two people whom I knew from years before under circumstances I won't go into or it might identify them, eventually hitched a ride off planet and took a shuttle. There are shuttles regularly from this planet to Alpha Centauri 4 which by agreement is a safe haven for people wanted by the U.S. Government. There's a treaty. It takes about 12 hours to get there. Apparently they took all of their family which meant sisters, brothers, father, mother, whatever, with them. As far as I know they're still there.

*SS: Who runs the shuttle?*

AB: Presumably the Alpha Centauri Government, but I don't know. But it's on a regular basis twice a week. The landing point I have no idea where it is. Of course they guard it secret.

*SS: What is their body form like?*

AB: Alpha Centauri? Like humans, exactly the same. There's a much lower population on their planet. They're not overpopulated. They're an advanced civilization, a little ahead of us - not a great deal, but somewhat ahead of us. They don't like things like government headbashing and that sort of thing and the way they treat some of the government agents they no longer have any use for or whatever, if they are approached, and I do not know how it's done, if they are approached and asked for asylum, if they issue the card, you just get on the shuttle and that's it, you're there. Beyond that I don't know. I haven't seen them since.

That's a very interesting little side issue and our government doesn't like it particularly but there is some kind of a treaty and they honor it. Apparently there is that type of treaty with other governments elsewhere, and I gather it is all Earth governments or includes outside governments I'm not sure. I have the feeling it includes outside governments too. There's regular communication, I don't know if Preston went into this about the Super Luminary Communication Systems that were developed by ITT in the 1960's. It's another one of those little developments that come out of all of this business evolving from the Philadelphia Experiment and the spinoffs from that and research done by ITT because they were involved in the background of that program to some extent. They were very involved and were the principle contractor for the Phoenix Project, but they also had a lot of other little games also. One of them was building a whole new communication system. This was research based on higher order energies and the effects and the propagation rates and studied all this and found out, "This is all very interesting. With a sixth order energy we can develop a communication system with a propagation rate of C<sup>6</sup>, that's C to the 6th power. They now have one C<sup>8</sup>, C to the 8th power.

SS: *C being the speed of light?*

AB: *C* is the speed of light, to the 8th power. That's so fast they can literally communicate clear across our galaxy with nothing more than a phase shifter. There is essentially no delay. With the *C* system there was a delay so they went to the 8th. 50,000 light-years across our galaxy and they can do it in a fraction of a second.

So Einstein was wrong in one sense. Nothing can go faster than the speed of light? It can. It's long since been done. It was probably done long since he made the statement. Einstein did relent of some of his statements in earlier years before he died but it was not publicly stated that he had.

SS: *Speaking of aliens and technology, do you know which aliens Tesla talked to?*

AB: The Pleiadians basically that was one of his principle communication groups. Also a group called the K group. K stands for Kandrashkin. That's the best literal translation of English. They were sort of light green skinned humanoid like with no hair. If you put them up in the right garb and bleached their skin and put an old fashioned wig on them they'd pass very readily for an Englishman. Not that I'm trying to cast any kind of aspersions on English people but they most readily pass for English. And the dye or powder or whatever they put on their skin didn't last more than two weeks. Then there were 2 others and I don't know who they were. When you start calling out into space you don't know who is going to answer. And they did. Tesla knew 11 or 12 languages and I presume these people communicated back in English but I don't know that for certain. I wasn't there I only heard the stories from 2 other researchers who had worked with him before he died. I'm told of the equipment and the fact that he did communicate on an almost daily basis with somebody from the outside.

SS: *You mentioned Reichian Programming in your lectures. How would one know if one was his by it?*

AB: You wouldn't after it was over. They pulled this system on Duncan once for certain maybe more than once and we have a friend back east who worked in a hospital who's seen the equipment, know what it does and what it's capable of. Preston's checked into the records and found that this particular type of advanced technology, electro-shock therapy equipment is what they officially call it. It's now very advanced computerized with floppy disks and very small electrodes instead of the old big patch pads they used to put on people and tape the down. They now have tiny little probes 50 millimeters square and they attach them to certain critical sensitive points on the body, about 8 of them. And there's a computer program they now use which will induce the Reichian orgasmic state by electronics and hold it to that state and in that condition a human mind from conscious to subconscious is completely aligned and opened.

Consequently you can remove buried information in the subconscious, reprogram the person, do whatever you want in that sense. And when the program is over they close it down, restore the person to the so-called normal state with either blocks on memory of the whole thing happening or a whole total implant of what went on that day as a substitute to memory or whatever they want to do. They usually put in a substitute memory. It's happened to Duncan once. We had quite a time running that down but we did.

They can do this to anyone they want. They grab them physically and take them off to one of the hospitals. The law is that any hospital or institution in the U.S. that accepts federal funding must by law have one of these machines on their premises and there must be certain personnel, very limited, trained in its use. Now it can be used for "normal" electro-shock therapy in the normal mode which doctors use, though it's much more sophisticated now and less damaging. Or they can use it for reprogramming, the same piece of equipment. But to do the reprogramming requires a special floppy disk, which is kept under lock and key and can only be used by certain government personnel.

When they do this number of the reprogramming it's done by government personnel. It is not normally shown (in) their records and there is never a charge made back to a hospital organization or to a hospitalization fund or medical fund of any kind. That is paid for 100% by the federal government and the record's swept under the rug.

They put it once on Duncan and they tried to do it again.

SS: *They physically snatched him?*

AB: Oh yes. We had quite a time tracking this down that one Sunday. But they did do that. It's based on Reich's principle, his old theories. The original programming techniques were more physical, but now they can do it electronically. It's much clearer, so to speak, much easier to accomplish and much easier to cover the tracks. And the law says these instruments, pieces of equipment, shall be made available to non-federally funded institutions. They recommend that they have them but there's no requirement.

SS: *Before going on, how do you feel about all this? Do you want to get revenge on these guys? Where do you stand personally on all this?*

AB: I would love to get back at some of... Well, where do I stand? Number one I feel it's long since time that the public knows the facts about how their government has lied to them practically about everything from politics to science to coverup of secret projects and the abductions of people by the government, I'm not talking about aliens, by the government for reprogramming - plugging them into special projects against their will. Then when they're done with them they either return them to normal life or deep sixing them in many cases.

SS: *You sound angry. Are you?*

AB: Oh yeah. I'm very angry about it because they wrecked my life. They wrecked Duncan's life, they wrecked the lives of a number of other people who I knew who were on that project, the original Philadelphia Project. They didn't wreck so many lives from the Phoenix Project in terms of breaking family relations and all this sort of thing. But they did eliminate a number of people who were involved in the Phoenix Project. They were literally killed, some accidentally, some deliberate and otherwise reprogrammed and shipped off the God knows where. And a lot of them were shipped off to another time frame so they never were returned to their original point of origin and live their life out wherever they are, under what conditions who knows.

The massive redistribution, if you want to put it that way, of people, reprogramming them is something which is totally alien to our Constitution and our concepts, not only our religious concepts of freedom, but our political concepts of freedom as we have known it under the Constitution for almost 200 years. The Constitution has existed longer but I say almost 200 years because these government programs have come into play since about 1947 and they get worse every year and they're not restricted to the U.S. But the U.S. seems to be the most vicious in it, by far the most vicious. The suppression of news and the control of the news media is by far the worst in the U.S. It's much worse than in Russia. There's more freedom to speak in Russia than there is in this country. I'm speaking of the last year or two, not prior.

Interview provided courtesy of QUANTUM COMMUNICATIONS.

and  
*The Sovereign Scribe*  
P.O. BOX 350      McKENNA, WA. 98558

1 Year (10 issues):

USA \$19  
Canada \$21 (US Funds)  
Foreign \$34 (US Funds)

Note: WA residents add  
\$ 1.45 sales tax  
per subscription

THE SOVEREIGN SCRIBE  
P.O. Box 350  
McKenna, WA 98558

0481

# RADIOSONDES

By Preston Nichols

## ABSTRACT—INTRODUCTION

Everybody talks about the weather, but does nothing about it; this is often said. Actually, in the 1950's and 1960's the United States Government tried to do something about the weather, from cloud seeding to use of electromagnetics. This report will cover one of the largest weather control projects, the Radiosonde, which can trace its roots back to the 1940's from Wilhelm Riech. The Radiosonde was reportedly a balloon carried instrument package for measuring weather data, with a transmitter that sent the data back to the ground. Investigations show that this is not so, and it was an attempt to control the weather. This report will discuss the background, the theory of operation, and the security measures taken about the Radiosonde.

## BACKGROUND OF THE RADIOSONDE

It is well known that for years Wilhelm Riech was experimenting with his orgone concept for modifying the weather, using DOR busting (dead orgone—the bad "stuff") to reduce the violence of storms, among other things. He found that the more DOR in the storm system, the more violent the storm. He experimented with many forms of DOR busting, and came up with a very interesting, simple electromagnetic method which was adopted for use by the Government to reduce the violence of storms.

By interviewing a retired person from the Brookhaven National Lab in Upton, Long Island, New York (my back yard), I learned of the Riech connection to the early Phoenix Project, which was the carry on of the Rainbow Project (the famous Philadelphia Experiment), which was done at Brookhaven from approximately 1948 to 1968. One of the interesting outgrowths of this project was the Radiosonde, which had a DOR buster sensor-modulator and a transmitter.

Sometime in 1945 to 1946, according to my sources recollection, Riech developed the sensors and modulation scheme, made his prototype and sent it to Brookhaven for evaluation. They found that it worked, and developed it further, and made a very compact, lightweight package to be carried by a balloon, since the thing was not operable near metal. Over the years Brookhaven developed under secret contracts different versions of the Radiosondes.

## THEORY OF OPERATION

How does a Radiosonde work? The concept is relatively simple, there are two sensors; one senses DOR out of phase, the other one senses orgone in phase, these are alternately switched to a special modulator that impressed the DOR busting signal on the carrier oscillator. Having the triode oscillator tube immersed in the RF signal of the resonant network and the physical design of the tube optimizes the etheric output of the carrier oscillator. The modulation works like this: when the phase reversed DOR sensor is connected, the instrument sends out a signal that reduces the DOR content of the environment around the package. Conversely when the in phase orgone sensor is connected through the transmitter, it built up the orgone. This would do an effective job of DOR busting, and build up the orgone (good energy) component of the environment.

## DETAILED TECHNICAL DESCRIPTION

The sensors are variable resistance types, there are two sensors, temperature and humidity. The temperature sensor is a thermistor, where the electrical resistance varies inversely with the temperature. The humidity sensor is a electrolytic resistor where the electrical resistance varies directly with the relative humidity. In most of the Radiosondes the pressure sensor is of the pressure responsive selector switch type (Baro switch). In essence the transmitter sees a varying resistance which is selected alternately by the Baro switch or sequential switcher with a short circuit selected occasionally which is called the reference mode. This is what the sensors do on the surface. It is also the line the Government releases to the public. Although cursory investigation will show that this description is true, there is also other activity which is secret. The temperature sensor is a carbon bar with precious metals added, and acts as an antenna to the DOR function. It also inverts the transform known as DOR energetics. This item is packed in a small vial, and has to be installed on fasten stock clips on the arms of the Radiosonde. It is painted white to reflect the sun's radiant heat as to get a true temperature reading, it sits above the package in the open. The placement is understandable from conventional science, but cannot be understood



from the viewpoint of relativistic sciences. The humidity sensor is an electrolytic resistor, which we do not understand the operation of, because the usual electrolytic resistor varies inversely with the relative humidity. The sensor consists of a grid of conductive lines with a chemical overlay which we do not know what it is. This sensor acts as an antenna for orgone in phase, it is similar to the electrolytic detectors that have been introduced for the detection of esoteric energies. The humidity sensor is also hermetically sealed in a small vial, and has to be put in its holder on top of the Radiosonde, totally covered, protecting it from direct rain. But allowing air to circulate around it, which does follow the released information.

In later Radiosondes the Baro switch is replaced with a clock work driven scanning switch, with the addition of a receiver that the Government claims is used as a transponder to track direction and height. This intimates that the Baro switch gives height information, which can be read from the pressure, but depends on a uniform pressure gradient which our atmosphere does not exhibit. This follows the released line but is grossly inaccurate.

I do not believe that this is the real purpose for the Baro switch, this intimates another purpose. It appears that the Baro switch is the correlated function which would be necessary to sync the DOR busting to the earth environment. It appears that the receiver synchronizes the DOR busting to the environment. I will say that at this point that we do not understand the sensor scheme.

The other part of the Radiosonde is the transmitter, which is pulse time modulated. The repetition rate of the pulse varies with the resistance presented to the transmitter. There are two types of pulse modulation used; one is where the modulation pulses off the CW carrier oscillator, the other is where a high voltage pulse supplies B+ to the carrier oscillator. There are two frequencies used; 400 MHz, and 1680 MHz. The 400 MHz oscillator is comprised of tuned lines with the triode tube in the field of the lines. The 1680 MHz oscillator is of the integral cavity type, with the triode tube inside the fields of the cavity.

We will consider the workings of the down pulsed CW oscillator transmitter. The transmitter has two sections, the modulation oscillator and the carrier oscillator. The modulation oscillator is what generates the pulse, which is a triode oscillator with a blocking network in the grid circuit. (See figure 1).

The operation is very simple. When the oscillator runs, the grid bias builds up across cap (C) and when the voltage reaches the tube cutoff the oscillation stops. At this point C discharges until the tube starts up again. As the grid voltage across C cycles up and down, the oscillator starts and stops; hence modulating the voltage drop across  $R_p$ , which is bypassed. The value of C and  $R_g$  and  $R_{ext}$  and  $R_{ref}$  determines the repetition rate of the pulse across  $R_p$ . The signal with the pulse and its potentials are capacitively coupled to the carrier oscillator. This is the usual explanation, but let us consider the relativistic activity. When the tube is cut off the higher order signal builds up inside the tube like the charge on a capacitor; the longer the tube is cut off, the more relativistic signal builds up in the tube. When the tube turns on and oscillates, it slews between saturation and cutoff, and two things happen: 1) the stored relativistic charge is forced out and 2) the slewing of the oscillation between saturation and cutoff has the effect of amplifying the higher order components by "O" point activity. The result is that the signal is amplified and outputted in pulses. From here the modulation signal is capacitively coupled to the grid of the carrier oscillator, where the pulse stops the oscillation.

Now we consider the carrier oscillator, the circuit is a standard one; how it was optimized we suspect has something to do with the placement of the tube in the field of the resonant network, and design of the tube. Let us consider the higher order operation, which is similar to the modulation oscillator. When the tube slews from saturation to cutoff, the "O" point of the vacuum is ripped and this results in relativistic gain as well as forcing all signals stored in the tube to the output and the antenna which resembles a phallic symbol. (See figure 2).

The bypassed output of the modulation oscillator, which is pulsed potential (scalar) at approximately 7 MHz is coupled to the grid of the carrier oscillator and slews the Q point from saturation and cutoff. The "O" point activity sends out bursts of relativistic signal which replicates closely the input signal from the sensors.

The other type of transmitter uses a delay line pulse modulator with a thyratron, charging reactor, blocking diode, pulse forming network, and a pulse transformer that generates 1400 V pulses which drives the carrier oscillator. The thyratron is fired off by the output of the same modulation oscillator as in all of the rest. The modulation oscillator loads the relativistic signal into the delay line through the thyratron which is cut off but still has "O" point gain. When the thyratron fires, everything in the pulse forming network is loaded into the carrier oscillator tube as a 1400 V pulse which rips apart the vacuum and results in a high "relativistic gain" through the usual "O" point activity.

The whole package is operated by a battery pack which lasts approximately three hours.



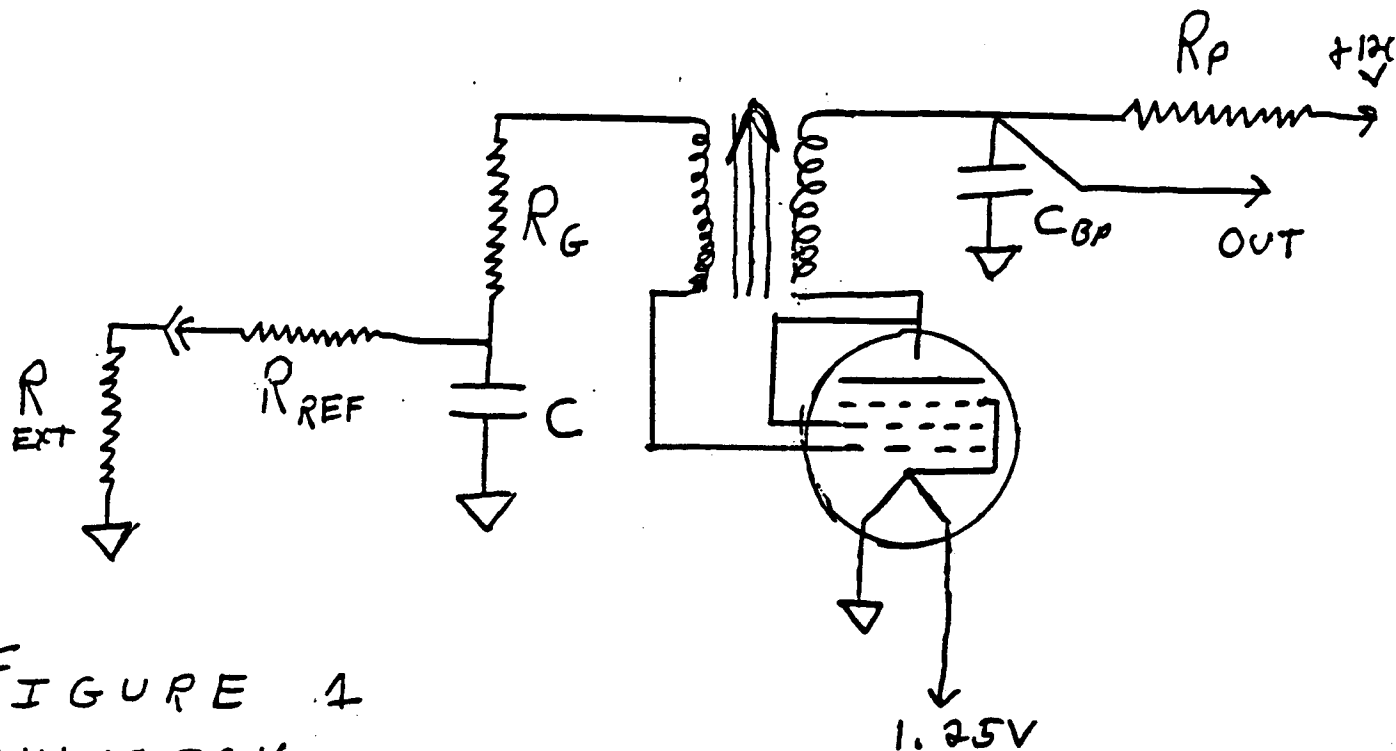

FIGURE 4  
MODULATION  
OSCILLATOR

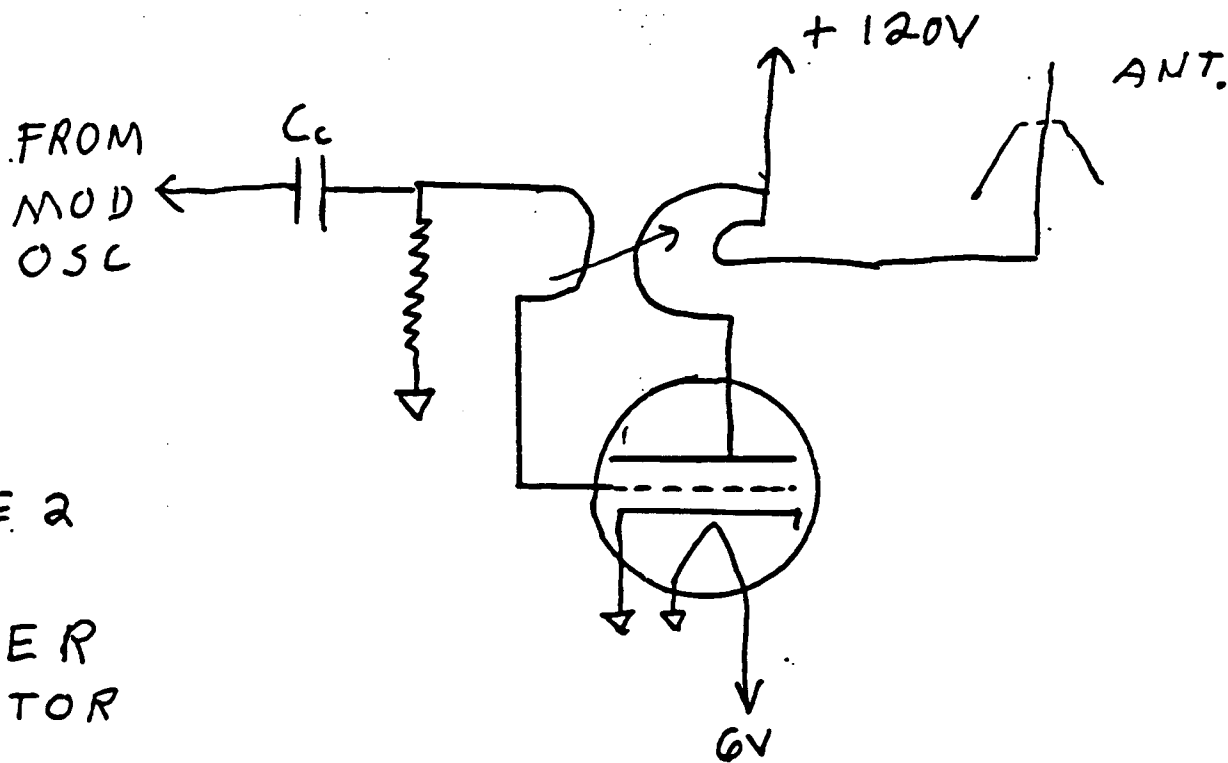

FIGURE 2  
CARRIER  
OSCILLATOR

## GENESIS OF THE RADIOSONDE

The original unit was directly developed from the prototype supplied by Riech, and was known as an AMT2 Radiosonde. It used a miniature tube for the modulation oscillator and an acorn tube for the 400 MHz oscillator. The AMT2 went through many upgrades to an "F" version which had a subminiature tube for the carrier oscillator. These units were in white cardboard boxes. They had a relativistic output equivalent to a 50 watt transmitter although the actual power output was less than 0.5 watt, and they had a low distortion response. These units ran at a carrier frequency of 400 MHz, with the typical modulation oscillator. The next upgrade was an AMT4 and "A" versions also AMT4B, as well as Bendix/Friez 3000 series which used the same modulation oscillator but ran at 1680 MHz using an integral cavity tube of special design and a very usual antenna. This transmitter put out approximately 0.5 watt but was equivalent to a 250 watt transmitter. The relativistic component was much cleaner than any of the AMT2s with the cleanest being the 3000 series which were built into the late 60s. In the 70s a later version of the AMT4B was developed which was very "dirty" and did not work. This is what we believed killed the program.

In the late 50s to early 60s the AMT6 series was developed which used a true pulse modulator and developed equivalent relativistic output of over 2500 watts. With a peak pulse power of 150 watts, this unit was designed to be dropped from a plane and was meant to break up hurricanes. The pulse network did not store enough levels of the solution's lattice, and is only usable for atmospheric modification of the simplest order. The AMT6 is not capable of biofield use, and the rest are capable except for the late AMT4B's where they lost the recipe, and those transmitters do not work. We do not know how to repair them at this time.

## SECURITY CONSIDERATIONS

Since these things went up in balloons, and could not come down hard enough to destroy themselves because of safety considerations, the actual units could not be secret, this would arouse suspicion. They publicized the apparent purpose of taking data, which uninformed examination would back up. The real purpose is not that obvious. If someone tuned into one of these packages, with normal type radio equipment the signal would not appear that unusual. SO FAR SO GOOD! They showed the public a data receiving station, all set up to receive the inaccurate, unusable data, had small production runs of this equipment. The launching personnel would laboriously calibrate or be told that someone else had. In the 1950's and 1960's these sondes were launched from all over: ships, airports, weather centers. Through this period of time there were hundreds in the air every day. The radio range of these things was very limited, to maybe 100 miles. This says that there should have been a "pile" of receivers known as Radiosonde receptor, and they should have been very common. Isn't it strange that myself, a surplus radio collector "nut," knowing many others have never seen a Radiosonde receiver or the other paraphernalia that went with them. I have only heard of them on rare occasions. This says that the Government did not use receivers. That's unusual, to have a data transmitter with no receiver to pick it up. HMMM! The next thing to look at is the specification sheet for the tube, which emphatically says that the life expectancy is only several hours. (See figure 3).

From examining the data sheet, it is obvious that they are telling you that the tube will run for a few hours. I have had a tube on the air for over 2000 hours, and at this time have built twenty units with a failure of only one, which is a good industrial failure rate. So the tube will burn out in "only a few hours"—HMMM! Of course if your local amateur radio operator finds one or buys one surplus he will read the data, get misled and not build a circuit that will run "only a few hours". He will use another tube. Hence it appears that the Government does not want the public using these tubes and finding something unusual, and their secret is blown. This misinformation will preserve the secret. They are not actually telling a lie; because of the design of the battery pack, the tube will burn out after three hours or so because of back bombardment of the cathode as it cools slowly, which will destroy the cathode.

When these things hit the ground they were dead, which says that the Government does not want the public to pick up live units. Considering that the Government wanted you to send them back, in the 1950's and 1960's, for reuse, why would they design the battery to burn out a \$20 tube (\$75 today) which would have to be replaced. This means that they were hiding something—HMMM! By packing the sensors in little sealed vials intimates that upon exposure to the air the sensors are also short lived, this is more misinformation. By following these precautions the secret was maintained for over 40 years, which says the security was good. If it was not for my collecting interest, and the PSY abilities of my associates we still would not know.

## FIXED-TUNED OSCILLATOR TRIODE

UHF pencil-type tubes having integral resonators; used in radioonde service at a frequency of 1680 Mc. May be used at ambient temperatures ranging from -55°C to +75°C. Fixed-Tuned Oscillator maximum plate dissipation, 3.6 watts. The

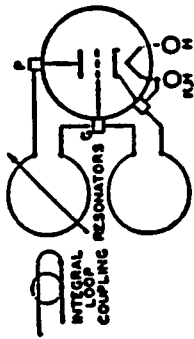

6562

6562/

5794A

### Technical Data

6562 is a DISCONTINUED type listed for reference only. As a replacement, the 6562/5794A is directly interchangeable.

HEATER VOLTAGE RANGE* (AC/DC)	5.2 to 6.6	volts
HEATER CURRENT (At 6.0 volts)	0.180	amperes
FREQUENCY (Approx.)	1680	Mc
FREQUENCY-ADJUSTMENT RANGE*	-12	Mc

\* This range of heater voltage is for radioonde applications in which the heater is supplied from batteries and in which the equipment design requirements of minimum size, light weight, and high efficiency are the primary considerations even though the average life expectancy of the 6562/5794A in such service is only a few hours.

\* As supplied, tubes are adjusted to 1680 ± 4 megacycles.

### FIXED-TUNED OSCILLATOR

Maximum Ratings:		volts
DC PLATE VOLTAGE	120 max	ma
DC PLATE CURRENT	32 max	ma
AC GRID CURRENT	8 max	ma
PLATE DISIP.	4 max	ma
PEAK HEATER-CATHODE VOLTAGE	9.6 max	volts
AMBIENT-TEMPERATURE RANGE	-55 to +75	°C

Operating Frequency Drift:  
 Maximum Frequency Drift:  
 For heater-voltage range of 5.2 to 6.6 volts, plate-voltage range of 95 to 117 volts, and ambient-temperature range of +25° to -40°C.....

+4 to -1 Mc

### OPERATING CONSIDERATIONS

Type 6562/5794A may be operated in any position. OUTLINE 74, Outline Section.

The flexible heater leads of the 6562/5794A are usually soldered to the circuit elements. Soldering of these connections should not be made closer than 3/16" from the end of the tube (excluding cathode tab). If this precaution is not followed, the heat of the soldering operation may crack the glass seals of the leads and damage the tube. Under no circumstances should any of the electrodes be soldered to the circuit elements. Connections to the electrodes should be made by spring contact only.

The 6562/5794A should be supported by a suitable clamp around the metal shell either above or below the frequency-adjustment screw. It is essential, however, that the pressure exerted on the shell by the clamp be held to a minimum because excessive pressure can distort the resonators and result in a change of frequency.

The plate connection should have a flexible lead which will accommodate variations in the relative position of the plate terminal in individual tubes.

The 6562/5794A may be mechanically tuned by adjustment of the frequency-adjustment screw located on the metal shell of the tube. A clockwise rotation of the frequency-adjustment screw will decrease the frequency, while a counterclockwise rotation will increase the frequency. The range of adjustment provided by the screw is ± 12 megacycles.

## CONCLUSION

This is an informational paper and is meant for you to draw your own conclusions; it is recommended that you "THINK" (I know this is hard for a large segment of the public, since TV and the couch potato) and come up with your own conclusion; then read on!

QED!

In my conclusion, we have two types of data, hard and soft. The security data is hard and can be proven. This says that there is more than meets the eye here. They were doing something that was secret; and gathering weather data was secret? I do not think so. This backs up the soft data which is the PSY read, and the interview which talked of the Riech weather control function. In the second half of the 20th Century, a lot of weather modification procedures were attempted, you have only heard of the failures such as cloud seeding. For legal liability it was judged by the Government that officially the weather should be left up to God. Someone loses money because of what they did with the weather, it would be law suits galore. This also is an example of why the Government is doing all it can to suppress the use of PSY, it can blow a lot of cover ups. My message is—

# KEEP DIGGING

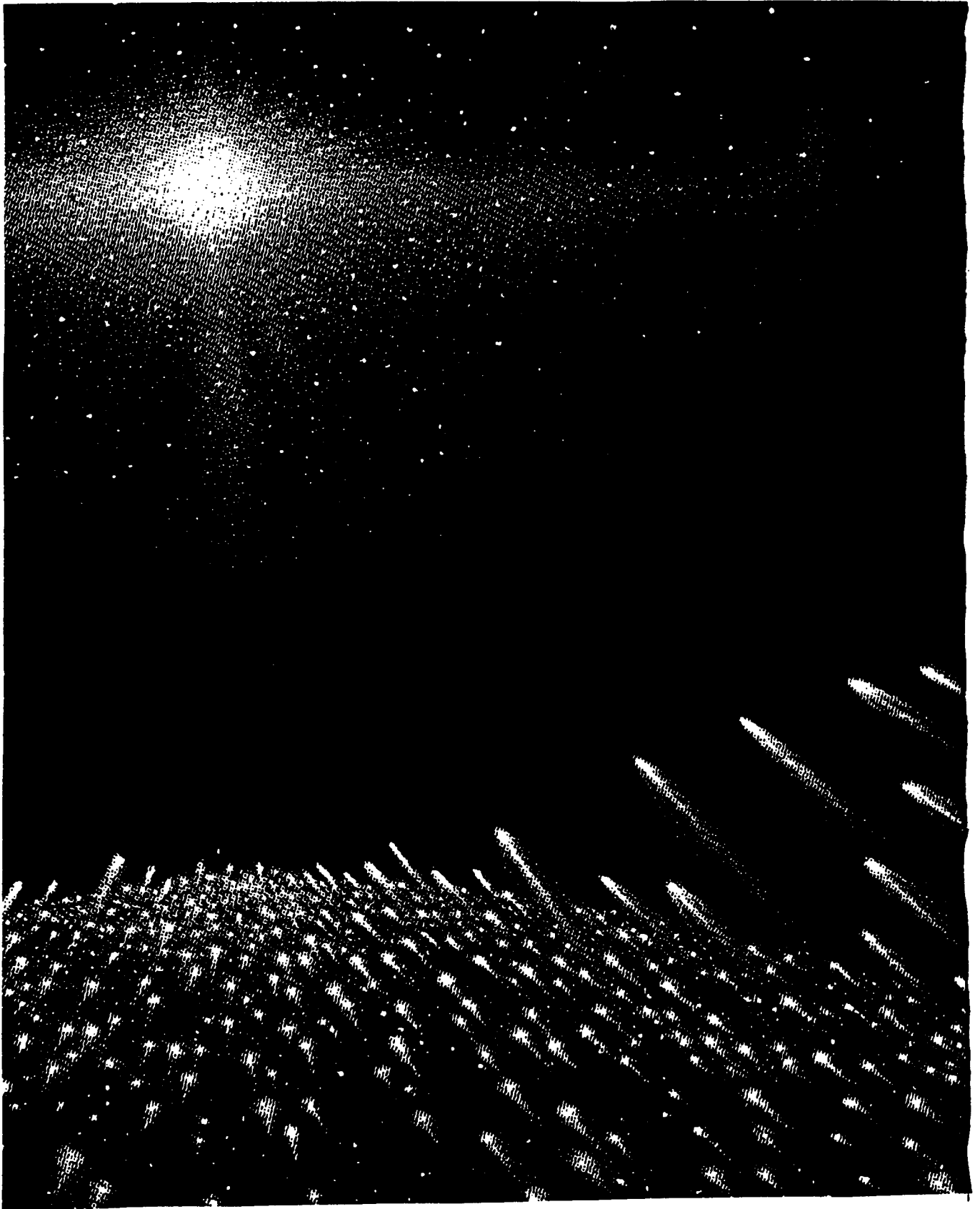

# M A T R I X I I I

## Chapter 8

### A FRAMEWORK IN WHICH TO VIEW ALL OF THIS

By now you may be wondering what to do about all of this in consciousness. It may be helpful to understand things from a more expansive viewpoint. Not being one to re-invent the wheel, it was decided to bring you some works by Michael Topper, who is the editor for the New Thunderbird Chronicle out of Los Angeles. Michael's work is neat, concise, and to the point, but it does require FOCUS to read it. It is written like this for a purpose, for during the act of focus and comprehension, it has an effect of expansion of consciousness; you must understand these basics. You must understand that the drama that is taking place on the planet is a "drop in the bucket" in a large continuum. Those of you who have MATRIX II will find that it will also enhance your understanding of what is in that book, as well.

We are bringing you three pieces by MT (who also did the introduction to this book):

UFOS AND THE POSITIVE AND NEGATIVE REALMS

PRECIS ON THE GOOD BAD

WHAT IS "CHRIST CONSCIOUSNESS"?

With these pieces, you will be able to understand what is happening from a more expansive viewpoint, both from the viewpoint of apparent dualities and from a point outside of dualities, which is vital to your growth in consciousness.

Following this chapter, we will get into more of the basic works of the New World Order, with special emphasis on the influence of the Bush family and various secret societies that comprise aspects of the planetary power structure; the structure is controlled from a "negative" standpoint by off-planet intelligence.

Following Chapter 9, which we just described, we will finish with Chapter 10, the final chapter of the book; the last chapter will get into some basic aspects of non-dual consciousness, followed by a list of bullet statements that are meant to provoke thought and expansion on your part.

Consciousness is the name of the Game! Don't forget this vital fact. Develop your consciousness. From a dualistic standpoint, it is the only "way out". You are the only "way out"!

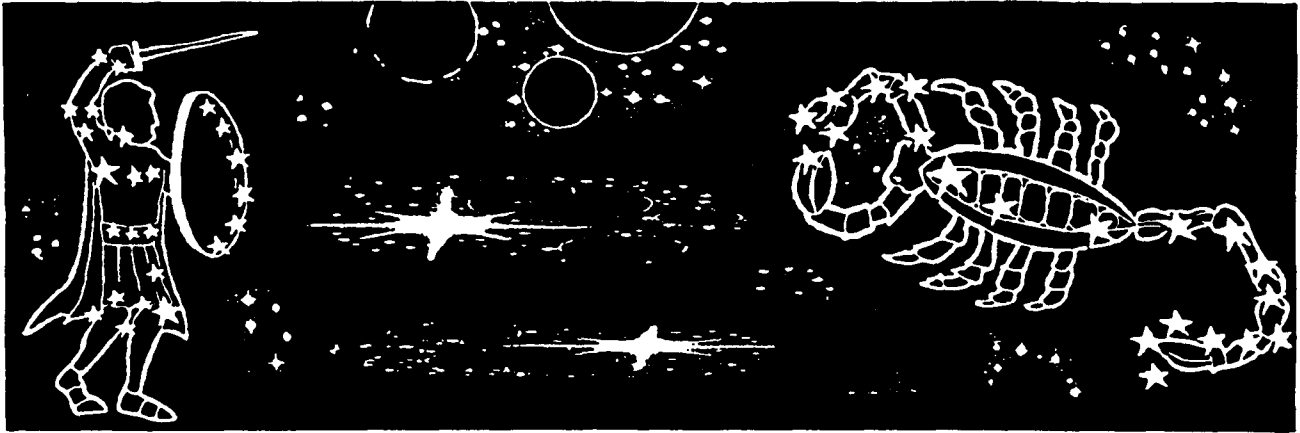

*Orion the Hunter had boasted that he was mightier than all the beings in heaven and earth. For his boast, the gods sent a Scorpion to sting him...*

## CHANNELING, UFOS AND THE POSITIVE/NEGATIVE REALMS BEYOND THIS WORLD

by Marshall Telemachus

### PART ONE

### Changing Channels

What could be a more perfect topic to begin our Book Review section during the month of Halloween, than discussion of the various books on channeling? Channeling is not only a popular sport at present, but if examined closely an intriguing one. It's not at all clear, for example, what the purpose of channeling is; this lack of clarity actually gives it a "spookiness" that's almost independent of the fact that disembodied or otherworldly intelligences, personalities and even (shudder) "entities" are central items of the channeling phenomenon.

Consider, for example, the most common means of establishing the "inner plane" or channel connection: meditation. This is the method most recommended both by channelers and the given channelled source. Meditation is of course, as we should all know by now, a means of stilling the mind so that our ordinary thinking faculties are temporarily vetoed; this provisional silence of the otherwise constant "interior monologue" is the means whereby the meditator is supposed to bypass the conditioning screen of (culturally programmed) concept, in so doing becoming ideally receptive to holistic dimensions otherwise recessed into the unconscious beyond the focus of ordinary "notice". However, as the very object of channeling, out of those ostensibly more holistic zones of being comes charging...more verbiage! Out of the meditator's mouth issues another voice. In Los Angeles alone, in fact, the phenomenon is so prevalent that it seems every other face has "someone else's" voice coming out of it (although this is apparently such a commonplace of filmland that "channeling" seems more a logical extension than an abrupt break).

And a great deal of the content of such channeled information from coveted "higher sources", is taken up by odd black-key vibrations inflected into the upper registries of haunted nasality extolling the virtues of...meditation!

This of course can only mean *one* of one thing, ultimately, amounting to a largely unnoticed metaphysical tautology; you're being encouraged to meditate in order to still the chronic cover of the verbal mind, thus putting you in the property receptive condition to pass a sonorously-rolling Voice *not* your own around the glottis in elicitation of a Speech which inevitably extols the virtue of *meditation*, as means of extracting a verbal instruction that tells you...

Now *that's* spooky! It's almost another version of the oddly reverberative "self-reference" paradox (you know, the peculiar conceptual log-jam which occurs when a categorical negative is expressed in first-person, i.e. "all statements are false, including this one". Richard Hofstadter would have a field day deciphering the Moebius code which the general program of "channeling" carries!)

To be fair, the exhortation to "meditate" that emanates from channelled sources, like t.v.'s exhortation to watch t.v., ostensibly points to a content beyond the significance of its own form-in-itself; i.e. just as television bids for your attention presumably because of the *information* it carries, so channeling claims your attention by way of the meditative mechanism apparently because of its unique power to bring a stream of extraordinary news. People consult the channeler, after all, not only or even particularly for the edification of the standard message to meditate, but largely because it's expected the source can produce a verbal description of conditions and events beyond the ordinary ken of three-dimensional faculties.

We consult the channeler because, basically, we are *concerned*, in a very ordinary conceptual way. Like every personality anxiously poised on the psychological tightwire spanning the temporalized chasm of existence, we grope in ambiguity over the Questionmark of chronic incompleteness supplied by the tenses in which we conjugate the terms of ego-identity; it would always be oh-so helpful if we could see the future in advance, be informed of the respective consequences in the alternatives confronting the present perplexing moment of decision. We would like if possible to be underwritten not only for our monetary but for our psychic commitments, insured in advance against the usual contingencies; and the channeler proffers the prospect of just this excelsior potential.

The channeler in a sense, then, *exchanges* the personal power

of verbalization born of limited perceptions for the transpersonal power of *verbally portraying* dimensions or aspects of being otherwise inaccessible. The myriad channeled voices to which we have been opened in recent years do indeed present an avalanche of prediction, of advice on principle and in particular, and a massive characterization of planes, states, levels or dimensions of reality introducing whole other *magnitudes* to the ultimate questions of purpose and consequence. Through the innumerable contributions of channeled sources we have been, in a certain sense, asked to reappraise the whole matter of *success* in terms beyond the conventional, so that the horizon upon which the grail of accomplishment rests has been as it were elevated, the sights raised to the prospect of a more comprehensive and crucial, indeed *sacred* focus.

On the "plus" side then, the phenomenon of channeling has supplied a verbal *chorus* of confirmation tending collectively to install our usual questions and concerns in a setting offset by distinct considerations of Soul. The "answers" to our most mundane queries as to future, choice and result have been furnished a whole additional *dimension* of meaning, so that the most casual skimmer of "channeled" material can't help but perceive at least implicitly the bearing which every conventional ego-choice has upon the larger destiny of soul-growth. Never mind for the time being that such emphatic intimations result from a *cutting in*, an abrupt verbal funneling of the basic meditative stream which was ostensibly moving toward the unique value of personal (unmediated) cognition and direct perception of those very, spiritual and high-psychic modes now presented by descriptive approximation. Never mind that the whole phenomenon seems in a certain light to express the *impatience* of higher-dimensional intelligence long waiting for the *sluggish* personal development characteristic of this "material plane" and so simply intruding with the necessary packets of information at the minimal achievement of some meditative quietude.

To be fair, some "channeling" circumstances seem to promote the personal progress of the channeler in gaining direct access to the planes, states, phenomena and degrees of mind-body integration otherwise only described or verbally characterized by ventriloquist voice-transmission (cf. the *Seth* material, and the late Jane Roberts' occasional description of her personal development in "inner plane" understanding). But for the most part, the expressed Ryerson-attitude prevails, which amounts to a curious dissociation between the person of the channeler and the content of the communication resulting practically in an overall *substitution* of the description for the thing described.

More immediately, on the *minus* side of the phenomenon we end up (in this avalanche of description from various sources) with a collision rather than a smooth confluence of materials. At the "higher" levels of consciousness not limited to the spacetime framework of the blindered channeler, there still seems to be contention or discrepancy in the respective characterizations of Reality; there still seems to be division regarding that which is perceived or known *even* in these greater and more allegedly comprehensive Domains of Knowing. Any who've scanned more than one of these sources in print, or compared notes with "live" sessions attended, are bound to notice (if minimally conscious) that, beneath the *general* agreement as to the existence of higher states and planes, of different orders of knowledge and action from those assumed in the context of strictly physical expression there is a *welter* of large and small divergences ranging from minor variations to an embarrassment of glaring contradictions.

This is explained in one such source, *Cosmic Revelation* "channeled" by Virginia Essene and Ann Valentin, as the inevitable condition of confusion resulting from the urgent/unprecedented need of the "higher dimensions" to disseminate changing patterns of information belonging to "revamped educational programs", brought about by this critical epoch of transition through which we're hesitant-ly passing. Such confusion according to this source results from the

requirement of transmission along the *spiritual hierarchy* of inner plane beings through which such "information", formulated at the highest levels, must pass. Consistent with what may be gathered from other source-channels, the various levels along which the orders of intelligence transmit the flow of data "downward" formulate the patterns of information according to the understanding of their particular plane. Tinctured already by that qualification, the information may receive its most noticeable distortion at the level of the channeler where, according to the variable of the given "linkage" there may be greater or lesser reliance on the personal memory-record, conceptual matrix or vocabulary of the channeling agent. The resultant verbal product is, in any case, several dimensional steps removed from the originating Intention. Add to this the recognition that all such knowledge emanates in its highest form from levels of creative intelligence that are basically non-verbal and that conduct all processes of knowing in abstract spiritual terms not directly translatable into concepts congenial to a physically-focused framework, and we seem to have on the surface a convenient explanation as to why Seth and Hilarion don't agree, why Ramtha and the "Christ" material of *The New Teachings* apparently quarrel on the shelves.

However, does this layered meshwork of spiritual cheesecloth through which the channeled curds are continuously strained really account for some of the comparative anomalies that, independently, speak with such assured and *specific* Voice?

Let's take a page from the Essene-Valentin material of *Cosmic Revelation*; let's listen to the Voices of "the Rays" and, like good researchers honoring the strictly scientific method, take them seriously on their own terms the duration of the experiment in order not to bias the results of testing their hypothesis. According to "the Rays", there must be a massive effort on the part of incarnate teachers (i.e. those sharing the *embodied* condition and thus the communicative premises of the physical dimension) of the levels "4, 5, 6 and 7" to collate the welter of incoming data, organize it into a coherent corpus of principles, premises and usable esoteric knowledge. "The Rays", in other words, invoke the cooperation of initiated teachers functioning in and through the physical dimension, exhorting any or all such teachers to act as the topper of a cosmic loom coordinately combing separate strands of starry Material through the distaff.

When however such an Initiated polarity *does* respond in the proper scientific manner to the call of this experimental hypothesis, something unexpected happens. After all, the Rays' proposition being *in fact* an *hypothesis*, a premise to be proved in practice, we are *not* assured before the fact that one element of the resultant equation will go evenly into another without fuss or irrational byproduct. And indeed, it seems that, by taking Virginia and Ann's "Rays" up on their own proposal, it is They along with various others that tend to suffer in the ensuing Comparison.

If we're going to tackle a task which even a cursory survey will show is proportional to the Purifying of the Augean Stables, we'd be greatly aided with a fit standard of measurement. Given the premise, it would be bad form to pull out a yardstick that derived from other than the material in question, since that would be *begging* the question and would bring up the additional problem of an extraneous source-verification. If we're going to extract some sufficient standard from the gathered data itself, it should be identifiable at the highest level of initiated understanding; its explanation should pair well with the patterns cast by the most intensely integral and holistic light available to initiated consciousness, and if possible should indeed serve to illumine certain details of such patterns beyond that which is already known at the level of Awakened *physical* focus, by virtue of its origin in the field of some comparatively unfettered Perspective.

### Probable Seth

There is always of course the *Seth* material, which is the granddaddy of such channeled information and which is often over-

looked in the turbulent consumer-drive for the new, the novel and the "up-to-date". One would hope that metaphysical principles and deep philosophical points couldn't be so easily "scooped"; the Essene material seems to suggest that we're subject to an information *turn-over*, as if spiritual truths and "eternal verities" showed the newshour brand of transience on their bovine flanks as they lumbered past our post toward the stockyards of instant antiquation. This is indeed all-too-true of much channeled material which frankly seems designed by an otherworldly Madison Avenue only interested in fashioning the latest catchphrase. What made the *Seth* material so noticeable, and what allows it to stand up well today, has much to do with the channeler Jane Roberts herself who—along with the channeled text—narrated a continuous chronicle of her own internal struggle with the whole *phenomenon* of channeling, as well as the content of the material. The uniform quality, consistency and integrity of the *Seth* teachings which spanned many years (compared to various one-shot sources today) was largely due to the strangeness and unfamiliarity of such a mode visited upon *any* consciousness at that "early" time meeting head on a rational and intelligent—if critical and initially quite skeptical—personality.

As Roberts herself states from the perspective of experience, it was indeed the initial dubiety, the deep reservations accompanying her reluctant participation in so extreme a phenomenon that kept the keel even, and helped therefore to keep the communication steadily aligned along the potential shoals of egoism on the one hand and reductive rationalization on the other. There is, as anyone should be able to tell, a universe of difference between these carefully monitored, combed and curried sessions and the modern immoderate opus cavalierly compiled across the familiarizing interval of time since the Summons of Seth wherein the chief feature of the inevitable book seems to be the channeler Herself, lavishly displayed on the pages of the photo insert coyly captioned from "childhood" to the "mature adult present" (in which, having donned a pyramidal duncecap in a moment of pure caprice the subject became so suddenly Serendipitous Host to some materializing entity, quite helpfully clarifying things at the outset by announcing Its Enlightenment).

In considering the *Seth* material as a whole, we can recommend it on the great virtue alone—taken for granted by now, but quite unique for its initiating time—that it introduced the important key of *probability* to the field of psychological reality, thereby freeing the idea from its exclusivity as an abstruse phenomenon of physics (occurring—to any significant degree—only at the Heisenberg-indeterminacy level, fit for the "position and velocity of electrons" but unsuited to strip the material mind from its fixation upon rigid causal conditioning and deterministic hypotheses of action). The *Seth* discussion of *multidimensionality* and the branching probable paths of conscious navigation through the wake-and-dreamstate served to shift the fulcrum of power to the bristling psychic present, thereby helping at once to loosen the mental clamps of a dominant behavioristic psychology and to perform a long-overdue correction to the religio-spiritual emphasis on *karma* or the irresistible pressure of past actions, mnemonic conditioning etc.

In this respect then the *Seth* material served its purpose admirably; and that purpose was to help consciousness take the *next*

*great step*, the necessary step into a whole new Stage of spiritual progress and development.

But in order to have a perspective upon the very *framework* of implicit stages in which all such development takes place, it no longer suffices to remain with the *Seth* material; and although certain other "channel" sources have subsequently touched upon the subject, one source alone stands out as a comprehensive overview; agreeing with Andrija Puharich's endorsement, we find proper standard and sufficient yardstick in the material known as *The Law Of One*, otherwise known as the Ra Channeling.

And why should such a designated source show particular superiority over any other? What makes it stand out? Again, we'd have to account for its quality by noting the way in which the source was channeled (rather than simply consulting the proclaimed level from which any such source ostensibly emanates). Whereas Jane Roberts, for instance, functioned as a one-woman hawk of vigilance in a way which most modern band-wagon channelers manifestly don't, the Ra material was conscientiously culled from the cooperative, carefully coordinated interaction of a minimum of three participating personalities, i.e., Don Elkins, Carla Rueckert, and James Allen McCarty. According to their own listed precautions and further *communicated* suggestions, the group used various ritual and formal

meditative devices to ensure the purity of the process and also...to ensure protection. For as they were to find out, contrary to much saccharine communication from the alleged "beyond" all is *not* necessarily well in the real Realm of the Higher Dimensions.

The Ra material, of all channeled sources (and as a fine-tuned, "narrow-band" communication) presents a cosmic overview both in terms of the multidimensional stages or "densities" of conscious progress in the Soul's awakening to the spiritual holism of the Creator, and the developmental progression of galaxies and planets as evolving vehicles of those densities. Such an overview is enabled by virtue of Ra's status as a "social-memory-complex" of

the "6th Density", a locus of functioning sufficiently congruent in alignment and integration with the Spiritual Whole characterized as "7th Density", to account for its unique power.

### Other Realities OR the Octave of Ra

*(The following summary of the Ra Teaching parallels the discourse of that Intelligence from the initiated viewpoint, and therefore supplements where necessary according to a direct knowledge or insight which finds its deepest chords of congruence with that Material, as far as any channeled source of information is concerned).*

According to Ra, the units of consciousness that become the developing Soul-vehicle or mind/body/spirit complex evolve through octaves of Creative Expression known as densities. There are seven densities and an infinite subdivision of seven-fold levels within each density, that compose a spiritual Octave. The planets and star systems exist, multidimensionally, within and as the vehicles of these densities, so that for example the sun is not just the physical source of nuclear fusion we know as a materially-focused subject; the sun exists in various states and forms *through* the densities and simply has the radiant appearance we know in our characteristic 3rd density field, just as Earth exists at least in potential through all the densities.

The movement of the lenticular systems as a multidimensional





whole, accounts for the cyclical and coordinate passage of the various suns and stars through "local regions" of transformation in which a basic revision of the nuclear material occurs and the perceptual patterns are realigned so as to install the given "body" at a progressed density or level.

Our solar system, and therefore Earth, is passing through such a transitional space now, so that our 3rd density planet is in the process of transmuting to a 4th density body.

The friction that characterizes the maladaptation of 3rd density, materially-focused consciousness as a whole in relation to the more spiritualized or subtle density of the oncoming 4th, accounts for the manifest difficulty of the transition with its attendant natural and manmade calamities. Obviously, such transitions don't *have* to be so difficult (the Ra entity, for example, describes its 3rd-to-4th density transition on the planet Venus millennia ago, as very smooth and harmonious); but the 3rd density consciousness we collectively embody does represent in the scheme of things a certain critical level. In order to understand the threshold character of that level, and therefore to appreciate the requirements we actually confront at this point, it's helpful to explain here the system of densities as a whole according to the Ra account.

### "You Are My Density" (George McFly to Lorraine in *Back to the Future*)

First of all it's important to explain just what is meant by "density", since its use in this material is extremely helpful to our understanding *once we clearly distinguish it* from the common usage that allies it with terms of inertia and opacity synonymous with strictly physical existence. Although nowhere in the material itself is the term "density" sufficiently explained so as to make that distinction, initiated intelligence would have you understand "density" in the sense of *richness*; the density of a manifesting plane or space is not a calculation of its inertia in this context, but to the contrary of its subtlety. It is easier to understand density as the degree of coherent activity, the characteristic "accommodation" of a given volume with respect to the perceiving system. The mathematical discipline of *sphere-packing* is helpful as a concept in grasping this definition. (How many oranges can be packed in a crate?) Sphere-packing employs the "greedy algorithm" in calculating a pure economy of space and is therefore a very practical help in communications, though it may theoretically work with an infinite number of dimensions. "Density" is analogous then to a multidimensional sphere-packing; the greater the density the more information a given volume codes, the greater the energy-value and richer the potential as which the space is configured. Like the discipline of sphere-packing, the idea of *density* implies a "geometry of information".

For example, we well know the "law" of 3rd density, our present collective plane of focus: "No two objects can occupy the same space at the same time". It should be obvious that this is a function of *perception*, for the operative coordinates of perception determine the outline of what's to stand as an object. According to 3rd density focal alignments, the descriptive units of "objecthood" are mutually exclusive and define one another by contrastive polarization. Perception of the essential *coincidence* of all mutually defining, polarized terms as an inextricable unity of complementary values, is a function of a higher-density cognition (or depends on the use of faculties *belonging* to the presently recessed planes and energy-systems of the higher densities). Thus when, in the course of spiritual discipline or occult practice performed through this plane we presently perceive a luminous wholeness and basic *simultaneity* that shines through all apparently separate objects (even though in the field of tangible perception such objects may persist in the perspectival "relief" that makes them appear distinct) we are actually experiencing a mind-body alignment or momentary, harmonious coordination with energies and instruments belonging to other den-

sities drawn into our frame of reference.

In this way we can understand the basic condition that comprises a given density. When the Ra material talks about "1st density" it's talking about the developmental condition of a planetary sphere as it moves through space the highest functional unit of which is capable (in itself) only of supporting the degree of "consciousness" and "light" known as mineral. It is, in other words, not yet of a sufficiently rich "intensity" or degree of complex energy-organization through any given section of its system to support the minimum, coaxial cross-correlation of mirroring values indicative of the threshold of *self-conscious* being.

When the Ra material talks about "2nd density", it's talking about a planetary condition the highest functional unit of which is only able in itself to support the degree of consciousness and light (still therefore a "sub-conscious" degree) known as vegetable, and later animal. Such a density is not in itself of sufficiently rich and subtle representation through any given section of its system to suggest the viability of a self-reflectively conscious axis.

Only the 3rd density of planetary development is sufficiently rich and symmetrically potentiated through a characteristic cross-section to imply the patterning of perceptual and cognitive processes belonging to an axis of truly *self-reflective* consciousness.

The 3rd density degree of self-reflective consciousness is the "moment" when the Soul awakens to itself, first through the patterned mediation of symbolic or representative values. It is therefore the "moment" when the unit of consciousness becomes aware of itself by a process of *modeled approximations* (i.e., the ego-image, the constructed or synthetic "self" of the memory-patterns). Its self-representation emphasizes *mind* as the mediator of consciousness through perceptions and cognitions; its chief vehicle is the verbalization or abstract-imagistic description of the interior monologue.



Its immediate *potential*, however, is the pure awareness of consciousness in-itself, without descriptive characterization or provisional modeling.

This is why the 3rd density of consciousness (i.e. the *self-reflective* capacity of planetary Being) is a critical threshold stage. Its potential clarity with respect to its own existence aligns it in congruence with the complete, multidimensional axis of consciousness (this is symbolized in the vertical, bipedal posture of the cerebrospinal "trunk"); for the being of consciousness is no longer *structurally* hidden from itself. It is at this stage only masked by self-assumed patterns of symbolic modeling. Thus the Being of consciousness is *functionally* masked from itself by relative anisometric alignments along the minimally harmonized, globally potentiated mind-body axis; but that axis is itself the Line through which the Creative Intelligence of spiritual Consciousness generates and organizes the multidimensional patterns of all the worlds.

Raised up in essential congruence with that Line, the potential of 3rd stage self-reflective consciousness has theoretical *access* to all the powers, properties, vehicles and instrumentalities of the densities (lower or higher with respect to its chronic, 3rd-stage focal lockin) according to the functional degree with which it can further integrate and harmonize its processing currents efficiently modeling the *perceptual* vocabulary through habit-patterns of identity.

Thus the 3rd density of conscious development represents a very decisive stage in the progress of Soul-realization. In a certain sense the destiny of such development has been shifted into the "hands" of self-reflective ego-consciousness. What *conditions* such consciousness at this stage are the inbuilt patterns of ritual-sur-

vivalism, reproduction and power-acquisition developed on the basis of lower-density experience recapitulated through the basal-brain lobes of the R-complex and the correlative abdominal centers of the autonomic currents in the extended, mind-body form; what *beckons* such consciousness of the 3rd stage level is the intimation of the higher densities of intelligence and life, received at varying degrees of strength and awareness through the unity of the cerebrospinal axis or multidimensional, conscious Trunk itself.

Most immediately, the 4th density (characterized by Ra as the density in which are learned the lessons of Love and Understanding) calls consciousness, vaguely or urgently according to the quality of attentiveness, to the experience of its *psychic* dimension as the first overtly "spiritual" zone disclosed to awakening intelligence. From the clarified value of this density revealing certain secrets of Consciousness to itself, it is learned just *why* the 3rd level of self-reflection was patterned in such a way as to initially mask the character of Reality as a spiritual magnitude, substituting a representative alphabet of symbolically modeled "name and form".

From the parting of the Veil draped across the perceptual threshold of 4th density, a distilled sense may be obtained of how previous Logoc experience with worlds of soul-development found such process slow or positively stagnant, due to the absence of an adequate *catalyst* which might serve to move mind toward active search for a deeper Being ultimately commensurate with consciousness-in-itself. Thus according to Ra the device for the succeeding Logoc pattern was formulated, i.e. that of *screening* the value of spiritual inherence (or Void-nature) from the perceptual potential of 3rd density where consciousness first takes estimable stock of itself.

### Cubing the Circle

Since dimensions are handily defined by "mutual perpendicularity", such a screening process can easily be conceptualized with the use of Rubik's Cube. If the perfect harmony, integration and mutual alignment of the dimensions belonging to the Octave of Densities may be visualized as the Cube rotated at its optimum coherence of color-matched sides, then the screening process (whereby coaxial currents of information-patterning are "skewed" so as to distort the view of existence away from direct cognition of maximally symmetrized, self-cancelling Void-reality) may be similarly understood by seeing what happens when we give the Cube an arbitrary twist.

By this analogy it may also be understood how there arises a variable gradation of patterns and multidimensional, coordinate-alignments by degrees masking or disclosing the noumenal condition of Void-nature through the given perceptual field; for just as, in reassembling the optimal alignment of the sides and colored units of the Cube we may pass through stages of experimental combination each turn of which has multiple repercussion across mutually perpendicular axes, so too in employing our endowment of overt and hidden faculties for purposes of plumbing the paradoxes perplexing our normal reality-constructs we may trigger electrochemical codes and dormant keys in the magazines of our complex circuits which magically power a differential repertoire of focal-compounds and variable alignments.

Rather than returning immediately to the perfect, global coherence and symmetric cross-correlation of systems indicative of the pattern at perfect "rest" in its inspiring Ideal order, we may pass through any number of mediate combinations and organizational variants which, like the tumblers of the Cube occasionally mating one or two whole sides may function through partial match-ups, turns of more "direct" integration and alignment which nonetheless from the Aerial View leave certain unseen phases in relative disorder and "incompletion".

Thus we have, at the 3rd density level and even beyond, the interesting circumstance that the spiritual common denominator of Void-value may be known through any number of disciplines or

"slants" producing some reorganization of the mind-body circuits within the framework of the Whole. Yet all such disclosures are, in themselves, metastable. They require constant work in adjusting, shifting and realigning the operative coordinates in experimental feedback generating an ongoing "adventure" in God-seeking since the given illumination was produced in the first place by a fortuitous ratio of interaction among certain emphasized centers and magnetic circuits (dialing one of the "permissible" combinations that serves to draw perception across the minimum requisite threshold of select, self-cancelling symmetries).

Thus we have the traditional testimony of mystic and sage, the magus, yogi and zen adept each describing a variation on Void-nature sufficiently consistent and corroborative one with the other as to give rise to the idea of universalism in the match-ups of Comparative Religion; and each at the same time characterizing the conditions, the indispensable fields or internal requirements of that Void-nature

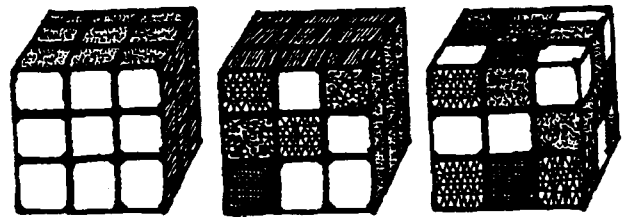

in terms sufficiently disparate and *unique to the given combination of centers* as to generate the classic contentions and "dharma-combats" indicative of the traditions.

We may understand the business of the densities, then, by analogy with old Rubik's damnable Cube. We may imagine that our minimal, threshold level of self-consciousness in 3rd density is similar to being installed at the globally symmetric center of the cube (thus our potential for *self-reflection*, since we're functionally established as a locus of cross-correlation and convergence through a system of Looking-glass planes inset for infinite, imagistic regress like a complex of dressingroom mirrors); at the same time, the units of each side of the cube are still at their maximum state of disorder, so that everything is *functionally* perceived through distorted patterns of mazelike indirection.

This condition gives rise to some interesting potential, in the formally screened or "masked" patterns of 3rd-density reality. Keeping in mind that this calculated screening of the direct recognition of Void-reality from 3rd density consciousness is for purposes of "producing catalyst", we see that the practical result of such disguise is the generation of a necessity for *choice*. Since the absolute coherence, unity and ecstatic identity of everything with everything else on the ground of Void-reality is *not* directly perceived and is therefore not a functional "given", the self-reflective ego consciousness of 3rd density is confronted with the requirement of assessing the *implication* of all interaction with other beings, and of choosing an orientation on the *basis* of that *assessment*. Given the full complement of rational and intuitive faculties with which 3rd-density consciousness is equipped, and which may on the basis of *identification* function either in congruence with or in antagonism toward the underlying principle of unity, that consciousness is empowered to determine just what the informing character of its reality is.

Thus, it can either ratify by experimental reflection and analysis of consequence (of relative "cause and effect") the essential unity and empathetic identity of all beings one with the other; or it may reject the implication involved in the *empathetic* extension of selfhood to other-beings, preferring to compound the harmony, self-congruence and integral consistency associated with the principle of selfhood in a purely personal portfolio of ego-investment, drawing on the option made available through screening of direct Unity-cognition by encoiling the love-nature around a fictitious core of separate I-hood.

Thus 3rd-stage consciousness is always reflecting a potential polarization between exclusive self-orientation, and an apprehension of selfhood which follows the intuitive lines of the undivided void-ground in extending that love value to all apparent "others" (i.e., all those comprising the "objective" dimension of the subjective self-sense).

### Polarized Harvest, the PH Factor

This is very significant, for, according to the Ra material, the work of crystallizing the extremes of this potential polarization is the real and underlying business of 3rd density existence. We have lived our myriad rounds of incarnation through this density ("preserved" between physical lives as a memory-record of identification patterns coded in subtle-dimensional media through the Soul matrix like a holographic "working-beam" locked in comparative integration with the "virgin beam"), strictly in order to produce this polarization, to one side of the "self" equation or the other, out of response to the "masking" catalyst of opaque physical existence.

The inference is, of course, that the "balancing" mechanisms of karma or impressional continuity do not merely serve the simplistic rectification-process characterized by our traditional good-active spiritual teachings; those balancing mechanisms, depending on the aggregate tendency of the ego-soul over the greater span of its incarnate history, may serve either to harmonize the self-complex in conciliatory service toward "others", or they may function to consolidate an insular harmony about the basically fictive complex of ego in aggrandizing service toward *itself*.

This polarization of "service-toward-self", "service-toward-others", is then the *object* of 3rd density incarnation; in light of the Ra Teaching, such polarization-alignment determines the "harvestability" of the soul-entity at the close of each Master cycle (a period which we are living *right now*, and which will end—in close correspondence to Mayan prophecies etc.—around the year 2011). "Harvestability" is the manifest ripeness of the soul-entity to proceed, by virtue of the minimal threshold intensity of its polarization-alignment in *either* negative or positive direction, to the more subtle lessons of the higher densities beginning with 4th, which offer the benefit of being basically unscreened and thus openly congruent with qualities of bliss-love, integration and wholeness (whether "wholeness" conceived in terms of strictly private or *transpersonal* continuity).

The implications of this teaching may come as a shock to many. For it clearly indicates that the separative and self-seeking "delusion" of negative egoity (developmentally possible at the level of 3rd-stage screening), is capable *itself* of achieving a dedicated integration and overall alignment in one-pointed devotion to its own, absorptive aggrandizement which through *its* polarity is as spiritually potentiated and ripe for "advance" as its positive counterpart! Uh oh. Does this mean that we are to bump into the negative ego-complex even in *densities above the 3rd*? Does this mean that, just at the point we thought we'd shed the shadow of that despoiling antagonist, it looms large once again only amplified by the additional potency belonging inherently to the unscreened higher dimensions?

Yes it does. Indeed, such a negative ego-complex must be *high* in the achievement of such integral intensity and mind-body alignment of the organizational currents about the illusory nucleus of the separate "self", in order to merit such harvestability (just as the positively polarized being must exhibit a comparable intensity of alignment); at that requisite degree of harvestable negative polarization, the being must have achieved a certain value of *purity of its type*. Such purity in the traditions goes by the name of "demonic".

### Negative Greeting (Hell-O Harvest)

Just as positively-polarized beings are advanced after Harvest to the unitive level of *social-memory-complex* compatible with the unity of that greater density, so the negatively-polarized beings are advanced after Harvest, "waking up" to the potential hierarchy of

positions (sorted and settled through preliminary battle) comprising a parallel Negative "social-memory-complex". Whereas in the polarizing field of 3rd density the relatively "positive" and relatively "negative" personality-complexes were admixed upon the same general orb so as to intensify the confrontational power of catalyst, in the 4th and higher densities the clearly polarized positive and negative beings are distinctly separated into different psychic spheres of patterning. These distinct planetary loci then pertain to values of the higher densities differently polarized, either positively or negatively. In this way, catalyst for further intensification and resolving harmonization *continues* to exist even in the higher, "clear" densities where the unitive value of Void-nature is a direct and immanently *functional* reality.

The relative "delusion" of self-recoiled egoity is able to persist and operate even through such a unitive void-ground, and strictly on *its* terms, since the initial formulation of its delusive premise was enabled in the more opaque incarnational atmosphere of 3rd density where it was *not* bathed in a choiceless Unity and harmonization of polarities from the beginning; *now* that, by virtue of its harvestability in orientation about its own shadowy axis it is able to function through the *overt void-planes of being*, it may be characterized as a true *spiritual evil* for it *chooses* its orientation quite freely without the functional restraints and cognitive masks that formerly had forced its association with a pattern-lockin relative to the fragmentary left-brain fixation of dualistic material focus. As the Ra material states it, a harvestable negative Being demonstrates a *conscious preference* for Negativity, regardless the incarnational conditioning that served as point-of-departure for that polarization.

Such a distinctively *spiritual* (because chosen, conscious) *evil* functioning from higher, psychic and subtle planes, gives objective justification to the traditional insistence of the religions both East and West as to the reality of *conscious negativity, intelligent malevolence* and thus...real demonism.

The Ra material explains that this higher-dimensional "clinging" to separative egoity creates a military-like hierarchy of negative beings who, as previously harvestable entities, had shown a *clear preference* for manipulation and enslavement of "other-selves", for the control involved in the inducing of fear and pain etc. even when able—at a certain point of consolidating pressure—to *see* the resultant magnitude of Void-Light made indifferently available to any such degree in the threshold integration of intent. Due to their *negative* polarization through the higher densities they exist along a current which nourishes itself on the psychic energy-exudate of emotional distress, sadness and terror etc.

Their purpose is "the same" as that of the positive beings; existing a reality informed directly by the unitive ground of ultimate spiritual holism, they seek a degree of intensification and alignment commensurate with the attractive value of that ground. The difference is that the negative beings seek to "stuff" that infinite magnitude into the dimensions of the illusory ego-nucleus, the retractile self-center of furtive, unapproachable "subjectivity". The *means* of their further polarization toward progressively higher densities is the diabolical pattern of "conscripting" an expanding number of uncommitted or as-yet-insufficiently-polarized souls (necessarily recruited from the schoolyards of 3rd density worlds) to the ranks of negative polarity, thus earning merit by stocking and replenishing the Negative waters with a proliferating spawn of self-serving subjects lured into "obeying" the propaganda of the Negative hypothesis.

Because they constitute a *spiritual* Negativity their tactic is an interpretation of the presiding divine law regarding the conservation of *free will* in all instances, so that success is measured by the cleverness with which *obedience* to the principle of self-serving is elicited as a conscious option. In this way the *negative beings* of the higher dimensions promote the *attractiveness* of enslavement of others. Enslavement per se is a *coercion* of free will so that, by itself, it does not aid in further polarization and thus advance of the negative being;

the negative being is interested in conquest and dominion through persuading the formation of a "power elite", the members of which will have *chosen* the path of self-service. Those who *are* enslaved, in turn, are subjected to the well-known stress of self-protective psychological identification with one's tormentors (cf. studies of the victims in Nazi concentration camps) so that they will ideally seek a similar power as the "winning hand", thus arrogating the "virtues" of self-serving to themselves.

Fourth density discloses Void-nature in the form of a subtle, perspectival anisometry so that the "void" of reality takes practical shape as a reticulation of psychic tunnels, hollows of conducting passage formulating a cosmic webwork or energy-net of interlaced holes and cognitive tubes; here the "transdimensional ducts of hyperspace" comprise a living psychic reality, drawing a starry network of spatial corridors for the continued, collective Seeking of the Creator.

The positively polarized social-memory-complex of 4th density roams the known galaxies in "spacecraft" that are actually biomechanical extensions of the members' electric current-envelopes or auric fields, energizing a living psychic technology for purposes of patrolling the available dimensions—regulating the allowable comings and goings of positive and negative influence with respect to developing systems and in general seeking modes of service which will enable expansion in pure Understanding so as to polarize more efficiently toward congruence with the higher densities, and ultimately with the Creator.

The negatively polarized social-memory-complex, similarly roams the galactic corridors in its biomechanical "spacecraft"; its members scout with predatory eye for likely worlds of "light" (i.e., self-reflective consciousness) upon which to poach, seeking always to create a power elite under the negative entities' control which will in turn prosecute the pattern of controlling others. Thus the "highest" in the Negative hierarchy stands at the summit of a cosmic and planetary chain of control, a chain always looking to bind increasing numbers in the promotional links of negative Empire ("Empire" is Ra's terminology, a *Star Wars* analogy Elkins did not fail to note).

In the case of both positive and negative beings of 4th density polarization, the negotiable currency of their transactions is a biopsychic energy; the mode of both is accumulation, in the sense of storing and putting such biopsychic energy-capital to work in powering or transforming the centers toward deeper integration and functional unity.

The world of 4th density is an astral webbing through which etheric and physical components organize as the sensate-olfactory extremity of a total, incarnative Vehicle or body-complex; it is therefore similar to what's experienced through the "inner planes" when 3rd-density consciousness dissociates in its *astral body*. It is a medium surcharged with the symbolizing "numen" of what we usually associate with the dream state. Yet to the quickened spark of self-reflective awareness struck in that continuum it is a world of perceptual properties as consistent in the laws of their behaviors as the perceptions of the material dimension are consistent with respect to their own. Whereas however the "astral" is commonly experienced by 3rd-density consciousness through nocturnal dissociation of the nested inner vehicles as a disembodied state, 4th density represents the coaxial extension of a focalized and locked-in, incarnative consciousness sweeping the span of available states from the psycho-symbolic to the electron circuit of condensed tactile value we identify as "physical".

Thus 4th density beings are astral-psychic entities in their optimum degree of awareness, with a physical-complex (electronic) component organized and extended through the patterning alignments of astro-etheric cohesion. The biopsychic energy which constitutes the "negotiable currency" of 4th density beings, is their natural nutriment. It is not just the "fleshy leaf" upon which they sup, but the specific value or psychic charge of its enveloping *astro-etheric* atmosphere. Positive 4th density beings achieve greater polarization

through aiding the maintenance and peaceful, harmonious furtherance of energy-rich spheres such as that of earth where biopsychic entity of a less advanced stage nonetheless generates tremendous "loosh" (in the terminology of Robert Monroe) through the surcharged atmospheres of a self-reflective—and therefore abundantly productive—degree of consciousness and light. The peaceful promotion of a unitive continuity and energy-intensive "advance" of such globes, planes and worlds as the physical we know, serves 4th density positive polarization creating as it does a general spread of coherent *nodes* in the universal net functionally coextensive with social/memory/complex "bodies".

The "saucers" of 4th density, being biomechanical vehicles, serve the group entity in energy-intensification and enrichment by virtue of their means of propulsion through the "nutritive menstroom" of astro-etheric atmospheres, in operative continuity with group-biological configuration. The "saucer" is not then an independent "tin can" hardware vehicle of the type we know, but is rather more like a pattern-crystallization of the group psyche or auric field of its "pilots". Similarly, the negative beings of 4th density are accelerated in their particular polarization through the sowing of stress and disintegration in energy-rich fields, thereby breaking down and converting the nutritive substance of biopsychic life indicative of a given zone into material suited to their psychically styled "digestive" needs.

### Taking the Fifth

The current-intensification and coordinate alignment of *5th density* is accelerated to a power sufficiently comprehensive as to change the character of "spiritual seeking" for both positive and negative beings, and establish it on a different basis. Whereas 4th density was involved in the intensive effort of energy-acquisition and consequent "boost" (as if realization were an asymptote curving toward the focus of a Horizon subtly displaced by the margin of Planck's constant from perfect resolution), 5th density comprises a kind of *discontinuity* that suggests a true crossing of the Abyss.

In 5th density the basis of spiritual realization changes, with an abrupt jump as if recognizing the psychic energy-lanes of 4th density "travel" as a simple cul-de-sac. Here one should do a double-take, and consult the Castaneda book *The Eagle's Gift*; those who believe Castaneda to be a pseudo-shamanic storyteller should soberly compare the description given by Don Juan of the path taken by the early sorcerers of his tradition, of how at the critical threshold of the Eagle's spiritual Aerie they suddenly realized that all the strategy of their energy-acquisition came to naught—that they'd been barking up the wrong metaphorical tree so that a discontinuous transformation of Being was called for, independent of any of their feed-in paths of identification.

Though here the Ra material has progressively less to say, initiated thought would have you understand that a minimal threshold level of coherence has been accomplished up to this point to stabilize the currents, universalize and integrate the subconscious energy-complexes in congruence with the conscious axis so as to allow the basic force of identity to be fixed between the coordinates of

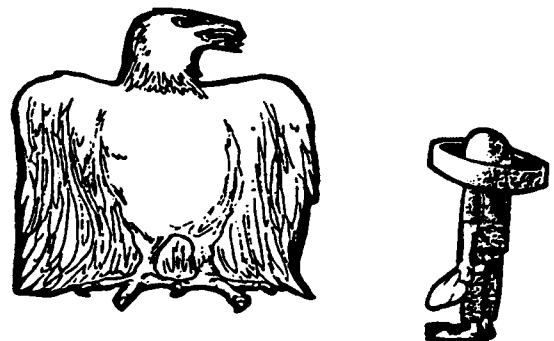

Balance. The value of identity itself henceforth, from 5th density onward, becomes the key and all Creative patterns are understood in its whole and moveless light.

At the level of mind-body integral coherence and threshold intensification required for the basic transference of operative Principles at 5th density, the factor of attention is less significantly subject to variable "openings" through the inviting void-potential of ducts and psychic wormholes (proffering deep dimensions of energy-nutrient in exchange for caretakership and cultivation—or, in the case of the negative being, exploitation and plunder). The instrument of attention (which functions largely as the "periscope" of awareness) has settled into close correspondence with the basic, quickened force of whole-value identity established as the universal locus or common denominator in the convergence of compositional coordinates distinctly resolved as a powerfully intensified and stable Void-point.

In the form of the universal, convergent void-point, the value of Identity constitutes a kind of equivalency-by-identification with the axial model of "vehicularized" life or bodily-being altogether. Identity has not been lifted gently from *between* the coordinates of Balance as it is in 6th density (or in the 6th stage of realization belonging to the higher adepts incarnate in 3rd density); it is fixed as the radial locus of all polarized terms, harmonized in a global resolution of self-adjusting Equilibration. Identity functions then at 5th-density level as the apotheosis of Limit; as such it is identified with and as the creative principle Itself, for all the teeming universes of creativity spring in the first place from the prototypal power of the Illimitable to accommodate the apparent "antithesis" of limitation.



Therefore, 5th density is the spiritual-light zone of learning for "embodied" beings who work directly with and through the creative patterns of Mind, the whole-point value of void Identity serving as the unerring, always-conscious resolving Principle of each formulated pattern furnishing the optimum axis of Balance.

The positively-polarized being of 5th density acknowledges the *constituted* character of the resultant, equilibrated void-point of Identity deposited as the central spiritual "residue" of self-cancelling coordinate extremes, thereby assuming the orientation of service toward the constituting Whole without center or delimiting circumference; the negative being of 5th density accepts that universal convergence in self-cancelling centrism as indication of the way in which all things *are constituted* to serve its Identity, upsurging as the common "product" of all cross-correlation and synthesis.

Thus both positive and negative beings of 5th density tend to "remain in place", and from that point of rest in Identity through the creative light zones emanate archetypal patterns as a kind of co-creative function to be adapted according to the interpretive terms of the lower densities and planes, as causative Influence. The positive beings project patterns of the creative archetypes that tend to promote harmony and peace; the negative beings project patterns that serve to tailor the astral and physical forms of conflict, disease and discordance.

Thus the soul-complex does not "travel" any longer as it did in 4th density, nor does it *seek* in that sense ever again, but only practices the alignment of all creative patterns in congruence with the self-evident, stand-out Value of Identity clearly furnishing the common term of all dimensional coordinates.

The 5th density is indeed the density corresponding (in "embodied" or soul-concentrate form) to the Macrocosmic Heaven-realm of the Creative Itself. Here all the cosmic patterns of expression

in their potential dimensionality and variable, compound focal-alignments shimmer like a great crystal, an illimitable metacosmic Jewel. It is from this level, reflected into the spiritualized Mind of 3rd-density being through the consciousness of a 5th-stage master (the realized *stages* of 3rd density "embodied spiritual masters" correspond, by resonant harmonics, to the like-numbered densities), that we receive the lustrous descriptions of the Buddha realms, the Taoist Mountains and myriad Transformation Bodies, the infinite creative scapes of "jeweled pavilions" and "strung pearl nets" multiplied endlessly in mirrored reflection through each of their incomparable facets etc.

### Cosmic Smerfs: Here Come the Space-Dorks

Note: it is the vision of this great, Creative Crystal, as well as the concomitant vision of the Eagle, to which the little gray space beings introduce Betty Andreasson in *The Andreasson Affair*. The distressing "strangeness" of Andreasson's interdimensional experience at this point of the narrative that so tended to put off her credentialed colleagues, *precisely* specifies the nature of the ordeal as that of having been taken to the very threshold of 4th density "astral" or cosmic-plane reality, abutting the Archetypal force-forms projected from the ledge of Fifth Density. It is unexplained in the book (indeed it is simply too perplexing for all those involved) but the *purpose* of the beings having exposed Andreasson to such an unbearably crushing intensity—see Castaneda's very similar accounts of intolerable pressure in the attempt to physically cross such threshold zones—was that of satisfying their collective, social-memory-complex curiosity as to how much of the Creator-Presence a *heart-being* of the earth plane could take after the several light-adjustments and technical alignments received in their craft.

Although these little bug-eyed beings involved in the Andreasson event are of the "positive" polarization-alignment despite their similarity to the negative grays, they exhibit the typical development of systems which deemphasize the median *heart-center* or dimension of psychic Love, so that in practical fact they are aligned with Cosmic Law but restricted in their Search for the Creator by just that comparative lack of heart-embrace; it is for this reason that they took Andreasson on several occasions to the "locale" (in terms of Astral 4th-density coordinates) of the Macrocosmic or Creative God-power, where that Presence seems to specifically concentrate and open out the psychic density as a great Door, or push through as a nodal eminence in the form of a glowing Dome etc. Whereas they themselves, in the limits of their interminable 4th density seeking, will not "walk" directly into the Locus of that Presence, they have no compunction about pushing Andreasson into it as far as she can go.

This apparent deficiency in the development of the heart center with respect to "spacebeings" of the 4th density has been noted in several sources; we may even find in Meher Baba's *God Speaks* a reference to the fact that "earth" is uniquely a locus or spiritual training ground for the full development of that center, and that beings of other systems and galaxies lacking such opportunity covet the experience to be gained from the lessons of earth-consciousness. From this we may interpret the nature of what the Andreasson-beings meant to observe through her ordeals with the burning Eagle or Hawk and the breath-taking Crystal etc.

Due to the character of our traditional spiritual and esoteric teachings, we may have a conceptual difficulty understanding how a being of a higher density (especially one which is represented as involving the value of Love itself in its basic lessons) manages to acquire its status without benefit of any basic heart-development. Such beings (of a positive character) have achieved the necessary intensity and developmental alignment adequate to 4th density polarization, through conscious decisions based on recognition of the abstract propriety and promotional advisability of peaceful values, cooperative characteristics and strict adherence to identifiable divine law. Thus beings such as are encountered in the *Andreasson Affair*, display a recognizably "scientific" approach to spiritual considera-

tions; they openly regard Divine Light as a measurable magnitude, actually quantifying the presence of "religious merit" so that for example when in a moment of fear Andreasson protests that she is "full of the Light", they show her "X-ray slides" of the precise ways in which she is not (they also subject her to certain gentle processes of light-balancing to amend the "breaks"). Their apparent "coldness" or objectivity in even the warmest, most "psychically alive" of astral-like circumstances does not prevent them from registering any inadvertent distress they might be causing their "captive", and modifying their approach accordingly.

If this seems minimally gratifying in light of the fact that the incident is, after all, one of those increasingly common accounts of UFO abduction, the "victim" seeming to be forced to endure such non-ordinary experience through no decision of her own, one need only compare the behavior of truly *negative* beings in superficially similar circumstances in order to appreciate the difference. In the famous accounts of Whitley Strieber regarding his ongoing *history* of bizarre abduction we have an adequate example with which to contrast the Andreasson description.

### Smerfs-Up: Here Come the Gremmies

The Strieber entities make no bones about the pleasure they derive in causing him stress; juxtaposed against the Andreasson grays, the latter are nearly innocuous. Rather than the apologetic withdrawal and prompt provision of liquid "balms" (that induce a kind of overriding bliss) as with the Andreasson entities, the Strieber marauders furnish graphic illustration of what the Ra material describes (according to abstract principles) with respect to the higher-density Negative Being.

What then of the seemingly execrable, indeed unthinkable fact that both accounts revolve around *abduction* scenarios which with equal, peremptory efficiency seem to deprive the subject of precisely that *free will* factor so central to the preservation of spiritual integrity as outlined in the Ra material?

Even that material suggests that, *very rarely*, members of the Confederation (the higher-density Good Guys) are involved by Permission in such abductions, or Close Encounters of the fourth kind. However, Ra suggests without specifying that these apparent psycho-physical "kidnappings" do not at their deepest level violate the free-will factor, and are occasionally though not often considered to be serviceable in the direction of positive polarization. How can this be? All one really need do is conscientiously compare the respective texts, i.e. Andreasson's and Strieber's; initiated understanding will furnish the conceptual characterization of what's inevitably intuited or vaguely felt when weighing these accounts against one another.

In the Andreasson case, we are always given the impression that, despite her overt fear and often terror at the sheer strangeness of the situation the beings are always doing something of a telepathic or quasi-physical nature to put her at ease; there is even the sense, reported by Andreasson herself, that at some deep level this is taking place in *conformance* with her will and not against it, as if in some way it had been *prearranged*. In contrast, *discomfort* of a deliberate kind almost consistently characterizes Strieber's account, and he is made to feel very overtly like a specimen humiliatingly observed and manipulated. He is even laughed at. There is in Strieber's case no *underlying* sense of complicity, of a prearranged concordance between dimensions of the deeper volitional being perhaps belonging to the planning-boards of Dream and the intensified volitional level of the entities themselves; rather, there is something much more distressing. And that distressing note develops in the course of Strieber's writing his accounts.

Rather than any *a priori* sense of soul-compliance, there is evidenced a progressive, *after-the-fact-rationalization* as if the negative intensity of the experience were too much to bear, and the implications too stressful to contemplate. In Strieber's account we witness the astonishing (but, under the circumstances, under-

standable) effort to *transmute* those horrific experiences into an ego-positive outline. Thus Strieber with almost excruciating transparency invokes the standard "humanistic" saw to the effect that dichotomies of good-and-evil are too simplistic and medieval, truth always being some "gray" blend of opposites; in this way he shields from himself the obvious implications of his ongoing ordeal. But more importantly, he demonstrates to perfection how one procedurally "falls into the hands" of the Negative Beings and, by the self-protective mechanisms of 3rd-density psychology engineers a reversal of assurance to the effect that "good" things, developmental things positively proceed from such ordeals—thereby underwriting *a posteriori* through the work of his own will the things which can't be "taken back" from the memory-banks and so seem to require some cover sufficiently assuaging of any ego-damage done through that quality of helplessness dripping, like absinthe, from the bitter cup of his plain victimization.

But other messages echo through Strieber's lines, much more powerful and persistent messages. "Why do you hate me?" was the first expression to which he gave rise in the recovery of his initial "abduction memory-print"; he reiterates over and over, in both *Communion* and *Transformation*, that despite everything he can't overcome the feeling that "they" are totally negative, just plain evil and monstrous. Yet his conclusions, his occasional distillates of what so far he's learned insist almost schizophrenically that these entities must in some way have the "good of mankind" at heart, that through the apparent terrorism of their utterly unworldly appearance and vile behavior they function something on the order of "cosmic zen masters" (as one commentator inferred from Strieber's account) taking a hard stick to our stubborn skulls so as to crack them of their crippling insularity. As "proof" of the actually liberative work they're performing, Strieber invokes the fact that owing to his jarring experiences he's "come loose" and is able to sample in waking consciousness the phenomenon of *astral travel*.

This shouldn't be so heartening, if properly understood.

Strieber's inventory of "positive side effects" on the whole describe a definitive list of what would be characterized in the Ra material as distinct inroads in the Negative program of conquest and ultimate Soul-capture. Like diabolical chessmen, Strieber inadvertently shows that the "spacebeings" have maneuvered and bullied his thoroughly beleaguered psyche into actively *choosing* the hypothesis with which they've implicitly enveloped him. He has accepted fear, for example, as a legitimate "tool" of deliberate spiritual "teaching" (which is very curious, since Strieber's hearty endorsement is prominently displayed on the dustjacket of Kenneth X. Carey's *Return of the Bird Tribes*, a "channeled" book which has as its most distinct and repeated message that *Love* must become the accepted educational mode of consciousness *and not* fear—do we detect Whitley's furtive effort to humble himself before a principle opposite of that which he openly espouses? or is there something more deliberately subversive here—one tactic of the Negative Beings, after all, is to find a means of subtly allying their Message with that of the truly Positive so as to generate confusion in untrained minds which would tend on surface evidence to accept these actually contrary messages as equivalent).





In further "defending" his tormentors and interpreting their tactics as a strict but ultimately benevolent discipline(!), Strieber helpfully displays for us one of the common vulnerabilities on which the Negative tactic counts, as a kind of hook upon which the Soul is sure to be snagged save by the unlikely event of a real egoic "repentance"; for indeed there is not *just* the sorrowful, cringing form of victimization to be found in the Strieber profile cast as a shadow on the psychic wall of his verbal edifice. There is also the distinct, burning ember of ego, the persistent glow of an intellectual pride which refuses to be counseled when the counsel seems to touch too close to truth; for any suggestion that his entities are plain evil seems to cause him to clutch his experiences the more covetously, and guard their interpretation jealously from any who might have a revealing word (which would in effect displace their proprietorship onto the overlapping circle of another ego). He proclaims over and again, all too often to remain marginal, that no one can explain his experiences to him since they're uniquely his, that anyone with an interpretation ipso facto has an axe to grind or approaches from the Procrustean perspective of preformulated concept, doctrine or theory; and that finally, his intellectual superiority makes him uniquely qualified to pioneer this field which he acknowledges sharing with other "abductees" (inferentially, not so well qualified).

It is this type of rationalization and self-protective recoil upon which the Negative design counts; for it is these internal properties of 3rd stage consciousness which serve all too predictably to convert scenarios of real coercion, flagrant violation of free will and worse, into occasions of egoic appropriation magically transforming the imprisonment of will into a full volitional acceptance. So Strieber seems to accept on principle the methodology and meaning with which he was harrowed, the Weltanschauung through which he was seized, defending it in full Will like a snapping terrier coveting its terrible bone against all comers; and that is too bad, because by his own account and according to his public history he is a man of gentle instinct and kind, overtly benevolent traits. He has written of his concern for nuclear disarmament, and thus of his concern for humanity; and he has given every indication of being a conscientious father (whose son, nonetheless, has become deeply involved in this unsavory business according to what was recounted in *Transformation*).

### Planetary Quarantine and the Divine Dice

The natural question to ask, then, is how is it (considering factors of "karma" and psychic "laws" of like attracting like etc.) that an apparently positively-inclined personality such as Strieber should be so confoundingly caught up in the net of Negativity which he details? Isn't his tendency toward "goodness" enough? Is there some unknown element involved in all this, which accounts for the seeming collapse of protection that ought to surround a "good man"?

In fact, though this saga spans dimensions and takes place principally on a spiritual level, we may suggest that the same factors apply which govern those grim circumstances wherein very good and innocent people went to the ovens in Nazi Germany—and indeed which presided at all such similar outrages recorded in our mystifying planetary history.

The answer to this question is going to be disturbing, particularly for all those who believe that their day-to-day "niceness" is enough, a kind of talisman like the universal sign of the cross that automatically "repels" negativity and sends it to the door of the less deserving.

Initiated understanding knows of principles besides those of "karma", which govern the cycling of events (as if "karma" were some heartening explanation that kept the wolf from one's door, owing to the likelihood of one's unblemished reincarnational past!) There is also a random factor, something very much akin to the revolution of a roulette wheel or the occasional synchronization of—arbitrarily calibrated—stroboscopic pulses. The random factor in the lives of beings is very much like a cosmic manifestation of the principle of free will; it is in fact an expression of the underlying *conscious indeterminacy* which informs, and indeed permits, the variable coordination of complex lines of tendency and preconditioning we take to be fixed or fated patterns.

The random factor flickers over our lives as a particular kind of catalytic agent; its existence, *through* the principle of indeterminacy, furnishes an unpredictable variety and therefore multiplies by an exponent the numbers and types of experience through which we're given the opportunity of soul growth, freeing such possibility from an otherwise strict limitation to "causal input", or those wheels which are already set in motion by our will.

Such a random factor is described in the Ra material in the discussion regarding *planetary quarantine*, or the means established by the Confederation to block out of the vulnerable matrix of enforced, 3rd density limitations any *undue* influence that would infringe on the factor of free will. An undue influence would of course be that of the Orions (the name Ra gives collectively to the Negative Beings of the higher densities, though not all negative beings are from the etheric locus of Orion); for the Orion Crusaders as they're called proceed precisely by plunder, and do not observe the positive proprieties of, for example, waiting until there is a distinct call put out for their "services".

Their method is, by tendency, to *coerce* the capitulation of "free will" thus in effect adhering to the letter of the Law while violating its spirit (through those means and in the manner previously described). Thus a compromise balance is struck by the positive "law enforcement officials" of the Confederation, honoring the spiritual requirement to allow for the Orions' negative interpretation of the "first distortion of the Law of One" as Ra puts it, i.e. the Law of Confusion or free will. The free will of the Orion Crusaders to plunder and *impose* their influence wherever possible is furnished a minimal aperture through which to vent its impulse, the random and ideally infrequent "holes" in the kaleidoscopic webwork of Quarantine thrown about the 3rd density earth-sphere. This random factor is also conceived to supply an indeterminate term in the supplementation of "catalyst" which is otherwise largely laid out upon the well-worn tracks of "karma" or previous conditioning.

The ideal *minimizing* of this opportunity afforded the Orion Empire—having to time its predacious leaps through the infinitesimal calculations of light-wave synchronism whereby the void-channels opening earthward irregularly "pucker"—establishes under ordinary conditions a satisfactory ratio of balance between the free will "needs" of the Negative Beings, and the free will requirements of 3rd density incarnate consciousness (inordinately vulnerable due to the deliberate, encoded blindness accompanying the critical choice of a "test-dimension" specifically shielded from direct perception of void-nature as a unitive and intelligent continuum).

### Cattle Call

Indeed, the only means of *waiving* the light-strictures of Quarantine revolves around the requirement of honoring the in-



tegrity of free will; thus when there is a specific *calling* from the dimension of 3rd density consciousness (i.e. a coherent and sustained psychic request either pointed or implicit for certain types of information, "positive" or "negative" depending on the type of knowledge or the character of those making the request) either positive or negative forces of the higher densities may respond according to kind coming straight through the Quarantine envelope.

A "pointed" request would be that of a magical ritual specifically invoking powers and intelligences, whether "white" or "black"; an "implicit" request would be that of, for example, a prolonged brooding either personally or collectively over certain dilemmas of existence that loan themselves to central issues of value, meaning, purpose, the nature and destiny of Being etc. From this it may be inferred that there is one way of *breaking* the primary balance in the cover of Quarantine. That balance can't be violated from *without* by either positive or negative forces; but the collective character, over a prolonged span of time, of the net aggregate *calling* rising up from 3rd density consciousness, whether on balance predominantly positive or negative, *can* modify that initial formulaic ratio of equity. The quality, integrity, persistence and numerical composition of the "call" are the variable factors that determine the net value of all calling positive or negative.

The "physical" disturbances that may be said to contribute to a disruption of the Shield such as underground nuclear testing or atmospheric detonation of nuclear devices, the negative employment of certain "secret" superweapons of a scalar or etheric-energy type, the devastation of the ecology through petrochemical mismanagement etc. may actually be understood as perceivable manifestations or concrete "symbols" of a psychic orientation toward great negativity, with a concomitant "calling" requesting the most powerful means or knowledge of exploitation, dominion and enslavement. To this call, the Negative most obligingly comes.

This distressing situation accounts for the alarming increase in the incidence of nonordinary or invasive negativity of a conscious type (an increase of which we are just becoming aware, as if it's steadily percolating to the surface of mass apprehension from the subconscious shadows and hypnagogic half-lights where for many decades of sinister incubation it has lurked—cf. Budd Hopkins' *The Intruder's*, Whitley Strieber's *Communion* and *Transformation* etc.). It seems in fact that we can date the evidence of an accelerated Negative calling from approximately 1945, or the year of the fateful decimation of a human populace by atomic weaponry. (Another and more direct incident ensued by just several years, which served to crystallize the calling—of this, more in the next issue of *The New Thunderbird Chronicle*).

Couple this knowledge with our previous explanation of the *densities* and we have a prospect pushing so hard upon the general threshold of awareness that it seems even now to send many off whistling in the dark of a nervous denial.

After all, we've received knowledge enough of both physical and metaphysical types to understand the basic principle of the "densities", i.e. that all dimensions, planes and states may coexist through a given point; that any such point is geometrically "saturated", a focal expression of creative vitality alive with the potential coordinates of force and form that essentially overlap, interpenetrate and coinhere—and which may be artificially separated into the "discrete" dimensions and planes of experience by specific, axial polarizations comprising the perceptual grid-network of a given system aligned through the informing pattern of the ideotype (logos or sub-logos). This shows that there is basically nothing standing "between" beings of any given plane and any other except the filtrate screen of perceptual coordinates through which the "perceiver" operates. Considering that the 3rd density with which earth-consciousness is collectively identified is uniquely "screened" from direct perception of the informing dimensions of energy, pattern and light functioning overtly through the spiritual value of Void-being, it be-

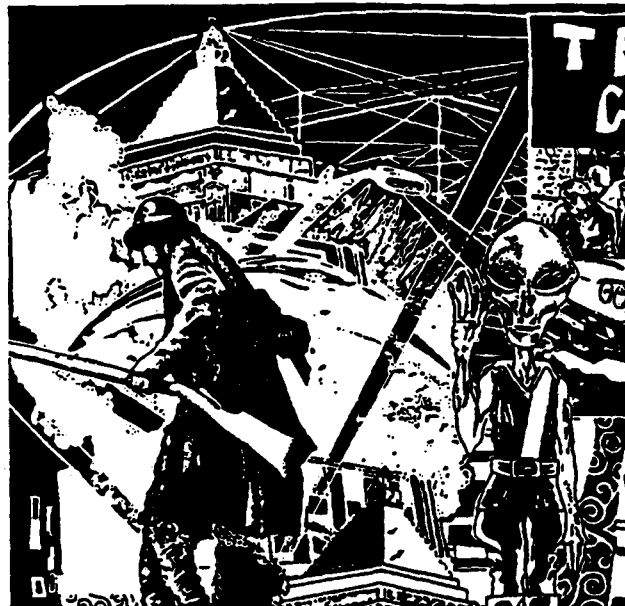

comes apparent that physically focused life is lived through the one-way permeability of a veritable cosmic fishbowl. We inferentially exist as an aquarium variety that can be viewed, unobtrusively scanned at leisure by all forms of self-reflective consciousness existing through the higher densities and dimensions either "positive" or "negative"; and we in turn see nothing, even to the degree that we can (and must) ask the question "Is there anything out there?"

The very idea of this makes many people squeamish. As if it weren't bad enough to be transparent to eyes of a *benign* character operating through the higher planes, *now* we have to be told that the greater dimensions of spiritual existence beyond the physical do not just host the law-keeping legions of positive beatitude. It's one thing to accept that some Santa Claus-countenance might be beaming down upon our blindered peccadillos with a disapproving cluck of the all-forgiving Tongue that, after all, resonates to the Divine Word; it's quite another to have to confront the prospect of some basically *malevolent* intelligence, of a purely conscious and calculated, predatory wisdom far more than just a match for any homegrown 3rd density mentality, moving freely with catspaw quietude through the porous fog of the dimensional interstices, gliding surreptitiously around and through the concrete objects that so peremptorily outline *our* limits, sidling next to us—invisible shoulder to quite vulnerably-solid shoulder—and whispering hemlock-sweet overtures into our defenseless ear (overtures that ooze with subliminal ease into the ongoing complex of our motivations, passed right by the crude monitor of our physically-oriented focus without registering a blink).

So unacceptable is this prospect to the 3rd stage ego (scarcely integrated to a degree where anything but anxiety can be its counselor), that it plunges for the veto-button, foaming denial with a frenzy able to reach—in indiscriminate recall—for every churchly word of whatever denomination or faith that ever intimated only the "good" pass on to the afterworld.

Indeed, part of the "confusion" of these comparative channeled accounts is that such reaction finds certain comfort in passages taken even from the better sources, so that for example, against the excellence of the Ra account the word of the *Bird-tribe* council may be juxtaposed to the effect that negative values and thoughts of warfare can't be brought along into the higher realms. Such sources would specifically have us believe that the basic identity of things as disclosed in the common denominator of the Void-light, *compel* a conscious conformance to the values implied in such unmistakably unitive modes.



## Sticking to Your Guns

Just a little reflection, however, should wobble any such presumption; for no 3rd density scientist (for example) seems automatically constrained to “good works” by his own evidence that the elements operate through a mutually defining network of closely integrated properties and unitive principles. The objection to this, of course, is that the comparative perceptual “samadhi” of a 4th density magnitude would tend to subvert the dualistic underpinnings of the psychological structure—characteristic of 3rd density—that permits a persistent *behavioral* conformance to its divisive claims while allowing free rational admission of an underlying unity of Being.

However, self-recoiled ego-identification is at bottom a *conscious preference* rather than a provisional mechanical constraint, and this is *proven* precisely in the higher densities where there is no longer a polarized lock-in enforcing a linear and abstractly distancing—or thetically “dividing”—left brain emphasis; at these accelerated levels, the adherence to divisive egoism in the face of the unitive Void-field is a manifest expression of will, and can *only* be the resort of a very conscious intent (i.e. it can no longer be “excused” as the subconscious habit-pattern of the enculturated nervous system). The clear decision to lurk and prey behind the overt holism and ecstatic oneness of reality, using that spiritual love-continuity in fact as a camouflage through which to install oneself by stealth, becomes self-evidently the option of a *conscious being only* (for the beings of 3rd density, no matter how “negative” they may be behaviorally, are not conscious—as 3rd stage beings—of the unitive holism of Void-nature and so do not have that value as an option to include in their calculations).

This accounts, for example, for the confusion Strieber feels in confrontation with his tormenting entities; as merciless as they are toward him, he feels the presence of *love* rather strongly when around them. This in conjunction with the compensatory mechanisms of psychological fear-reaction help lead him to conclude that they must be at bottom or in some way “good”, and have mankind’s welfare at heart. What Strieber *feels* in their presence is the informing quality of the density through which they characteristically function, i.e. the Love-density of the 4th stage. However, he fails to realize the manner in which this Love-unity-feeling is the pervasive property of that density (to which he is temporarily exposed in his abduction), *not* the personal expression of the beings—except insofar as they consciously invert the love-value of that density upon the shadowy, nucleated outlines of their intentionally preserved, egoic brand of selfhood. However, the beings *rely* on the general Love-feeling of that density to confuse the issue, to befool the bedeviled mind into taking psychological refuge in a self-protective premise that will further encourage the acceptance of their most coercive behaviors as reverse-twist exemplifications of the general rule of “love”.

Why then do even otherwise “good” sources in the general category of channeled material sometimes speak to the effect that nothing negative can move on to the higher planes or stages of development?

### What You Don’t Know...

First of all, of course, the character of the *channeler himself* has to be taken into account along with all his preconditioning and personal limitation. The channeled source often *transcends* those limits, if it is a good and strongly aligned source; but it may also make use of those limits. In the case for example of the Bird-tribe source which Ken Carey channeled, we find illustration of a certain benign “contention” or division in methodology belonging to the higher 4th-density plane; for it should be understood that 4th density sources (of which Carey’s is one) function through a *variety* of concepts as to which “approach” would be most practical and productive in raising 3rd-density consciousness. There is no absolute agreement in the 4th density even amongst positive groups of intelligent service. Carey’s source is simply demonstrating, in its explanations, the decision to

address a certain type of 3rd-density consciousness through his particular style of ideological limitation, by focusing only on the principles of “positive” polarization and in effect denying or bypassing the “negative”.

This conforms to a certain belief-pattern prevalent in New Age circles and “used” or supplemented by occasional 4th-density sources disposed to take the “see-no-evil” approach; such doctrine runs to the effect that where there is no knowledge of negativity, negativity does not exist. This in turn links to a rather bumptious corollary in the theorems of certain New Age schools and “astral” fields of inquiry, i.e. that of “you create your own reality” (see next month’s *T-Bird Chronicle* for the article that addresses this issue).

The defect in such reasoning would be clear even to those who subscribe to it, if it wasn’t put in terms of “spirituality” (which makes it still too nebulous and unreal, frankly, for those even who purport to subscribe to all sorts of “spiritual” New Age principles) but in simple, easily identifiable terms of physical existence. Thus, if it were a matter of warning against something like the formation of *Hitler’s Nazi Germany* as a quite real stormcloud looming over the horizon, very few today would take the Chamberlain approach and imitate the proverbial ostrich. However, when it comes to negativity of a *spiritual* character many (including beings of the 4th density) assume some special attitude: from the physical perspective, the assumption is that “spiritual” and “physical” have different roots; from the astral perspective the assumption proceeds out of a kind of intoxication that “forgets”, or never knew, the difficult ambiguity and admixture of physical life.

Now, if *karma* were really a simplistic matter of the type popularly professed and only “negatively disposed” beings or those with blemished records were vulnerable to any potential incursion by negative forces, *perhaps* we could see some minor virtue in not troubling all those “good” heads over such contretemps. But this is still not the same as *denying* the existence of such evil outright; and in any case one could never know in the depths of one’s “personal karmic record” whether there weren’t some lingering mark that might compromise one’s perfect dissociation from such business. But “karma” is *not* that simplistic; the global slate of the breath-soul upon which karmic marks are recorded, requires that *blank spaces* be filled in as well as existent entries balanced. Thus, vacuums of experience (especially those experiences or potentials deliberately avoided) possess a magnetic urgency to be filled; and where *avoidance* indeed accounts for the vacuum, there the random factor which we’ve previously discussed becomes an ever-more-likely catalytic agent as opposed to any head-on initiative of personal will (which would, of course, create proportionately more “governable” circumstances).

It is for this reason that the education of 3rd density consciousness to the existence of real negativity, to the ways of such negativity even to the characterization of its existence as far as the degree of true spiritual (because *conscious*) evil, is considered appropriate and even necessary by the alternative viewpoint of higher-density consciousness. Such Consciousness looks at the ostrich approach as a disservice, and as very *short-sighted* even where clothed in the apparent sanction of an “astral” or 4th density communication. (Even *Pollyanna* acknowledged the existence of negativity; she never denied it, just emphasized the positive. That’s hardly the same thing as dismissing the negative in neo-Augustinian manner as a “non-entity”, as a fugitive shadow definable only in the “absence of the good”—which falls to the standard liberal sop of educating all beings out of their “contrary ways” since the negative can only be sustained in the presence of *ignorance*. Such doctrine has *no idea* what to do with an evil that isn’t simply “relative to cultural context” or comparative definition, and which functions not through ignorance but—to the contrary—on very *conscious intent*, by highly intelligent preference).





## PART TWO

### Love Was All He Said

The alternate convention to which a certain "New Age" mentality turns whenever the possible existence of an actual, deliberate negativity approaches the unimpeachable, is that of the vaguely "Christian" tactic: love-bomb the blighters until they see the error of their ways, by the point-scoring Good Example set. Such cheek-turning is in practice of course a very selective espousal, since it rarely seems to constitute the day-by-day *business* attitude of the very same proponent. Even in the case however that this recommendation weren't outright hypocrisy, it would remain fatally fatuous; for, as the Ra entity proclaims to one of the questioners who presented just such a tidy "solution", they (the Orions) "do not want your love".

This rebuff clearly meant that any "love-rays" directed toward the zones of Conscious or Spiritual Negativity would find nothing receptive on which to fall, no substance upon which to work. The inescapable implication was that *any* such proposal, suitable enough perhaps for beings of a straight *3rd-density* consciousness not decisively polarized and therefore still possessing a "recessed trait" of potential goodness able to be acted upon, when applied toward Spiritual Negativity of the Higher Densities simply served as clear indication that its proponent hadn't understood the point.

The Negativity of the Higher Densities is *ipso facto* awake; it has *chosen* the rejection of other-love as a whole-being orientation, and therefore has no subconscious residuum of receptivity that might secretly "respond" to the good intentions of a positively-directed beam (even if such a beam proceeded from a sincere resolve which consistently applied its Samaritan counsel in all other avenues of life).

Indeed there is deeper implication than this. In the face of such *uncommon* or truly *spiritual negativity* the presumption of such conventional counsel (applicable enough at the *ordinary* level) might well result in consequences worse than simple "lack of success". It has to be understood that spiritual principles and religious precepts, even those cherished from long use and universal recommendation are at best optimum advice for the given system of function; at the transition

to general 4th-density existence, those precepts and principles most apparently "eternal truths"—as they stem alike from Buddhism and Hinduism, Christianity and Sufism—have to be evaluated against an enlarged context, and modified according to the forms of information "unique" to the higher domains to which consciousness must adapt.

The principle to "love one and all alike", to bestow "blessings upon all beings" and so forth is not subject to *abandonment* at this stage; we are not to somehow understand that a reversion to hatred and warfare are suddenly "all right" due to the extenuating circumstance that "pure spiritual evil does indeed exist". Universal Love is and always remains the principle in some proper form; but the *specific* beaming of the "love-vibe" in the direction of the Orion Crusaders not only possesses the defect of wholly wasted effort; the philosophy informing it tends to contribute to a tremendous *misreading* of the elements actually involved. And this is no better illustrated than in the Strieber account of the manner in which he was made to feel tremendously *guilty* for not having obeyed a direct command of his tormentors.

#### Sweet Setup

In *Transformation* he recounts the otherworldly interdiction whereby a "voice" bade him refrain forever from sweets, his one true vice. Addicted as he was, Strieber couldn't stop, even though the "beings" engineered circumstances so as to bombard him with dire implications. As a result, one evening he is visited by a malevolent presence which he himself—as always—describes best, i.e. as "monstrously ugly, so filthy and dark and sinister. Of course they were demons. They had to be." Again, "the sense of being *infested* was powerful and awful. It was as if the whole house were full of filthy, stinking insects the size of tigers." The entity, rising up beside his bed like a "huge, predatory spider", places something at his "forehead" (i.e. the Third Eye) and with an electric tingle he is "transported" to a dungeon-like place where his attention is fixed upon a scene of excruciating torture. The victim, a normal-looking though quite naked man, is being whipped to shreds amidst agonized screams by a cowed figure. His "entity" explains to him that "he failed to get you to obey him and now he must bear the consequences". This disclosure is followed by a very *interesting* and *significant* "assurance" that "it isn't real, Whitty, it isn't real." As Strieber reports, such an "admission" did nothing to mollify his horror.

The assurance was indeed an oblique reference to the actual tactic being used by his tormentors; the whole scene, like so much UFO-abduction data, is a projected *thought-form*. Such thought-forms are generated not in or through our ordinary "3rd-density" plane, but are manufactured in the medium proper to them, i.e. the Astral. The subject, then, is either spirited to the "vibratory frequency" of that density through dissociation of the astral vehicle from the physical, or, as in certain accounts possessing a component of "high strangeness" the 4th-density menstroom is tuned into place by a vertical adjustment and wholesale realignment of the nested "bodies", in such a way that the subject doesn't *dissociate* from the intendment of "touch" (and thus, from the physical-electric grid) but rather undergoes the rotation of the coordinates of that grid so that they line up in conductive relation to the informing geometries of astro-etheric patterning which otherwise are obliquely screened—thus affording a direct continuity of perception surcharging the apparently "preserved", familiar field of physical focus with impossible Whitley-in-Wonderland elements.

The purpose of soothing Strieber with such assurance as to the ultimate unreality of the convincing scene experienced, should be familiar to anyone who's heard of the torture tactics employed in any good Banana Republic (i.e. those in which the victim is subjected to excruciating pain on the one hand while being simultaneously stroked and reassured on the other, often by the same party). The object is to elicit the full cooperation of the victim under duress, by making him instinctively gravitate toward the implicit salvation extended

through the “motherly” touch demonstrated in that schizoid Grasp, feeling some surcease and thus even affectional Gratitude with respect to that one factor in the whole horrible stew that seems to proffer kindness and a relieving recourse.

Indeed, Strieber proves himself the compliant guinea pig; even under the intelligence that it’s all a thought-form, his compassion for the (imagistically dramatized) unsuccessful “bidder” persists, obviously in thorough confusion with his own self-commiseration, so that finally he collapses upon a repentant love for the very roaches that bedevil him. “Again, though, I felt love. Despite all the ugliness and the terrible things that had been done, I found myself longing for them, missing them! How was this possible?”. Again, “I regretted the contempt I had shown for its [the *other* “reality’s”] needs and its laws and felt a desperate desire to make amends.” “I had felt a pain greater than the pain of punishment. It was the pain of their love....I had the sense that they had on my behalf turned away from perfect love, and that they had done this to help me.” “I suspect that the ugliness I had seen last night was not them, but *me*. I was so ashamed of myself that I almost retched.”

In this way we may clearly see the baited hook that awaits within a context *inclusive of life in the higher densities*, with respect to the word of universal-indiscriminate love. The effort to operate such love according to a literal interpretation of the word, is ripe to be employed as a real booby trap for any form of consciousness having as yet *no practical grasp* of the Whole, and so by virtue of standard habits of identification chronically confounding the Whole and the part (as is the typical pattern of 3rd density mind). Unable to “see” the Whole which nonetheless directly *infuses* and underscores the negative entities as their very medium, clinging to their foulness like a sweet masking scent, the mind used to dealing only in terms of the representative part is unusually open to making just that identity-equation in which the incidental *expression* of a Field is presumed to contain that field, or is taken as one-to-one equivalent of the quality belonging to the field as a whole. Conversely, the *return* of the Love-value toward any being of such a field *isolated out of the context of the Whole*, tends—to the mind chronically focused only on the complex relation of part to psychological part and never on the Whole itself—to be but a yielding or block submission to the other’s requirements as means of overcoming the resistance of “identification”.

### To the Highest Bidder

Should there remain a reluctance to grasp this point, or some desire to conserve the liberal-humanistic proposal to which Strieber often turns (i.e., to call such things truly Negative or Evil is “simplistic”, you know) we need merely resort to the Ra material once more, wherein we find a passage—first published in 1981, don’t forget—that anticipates Strieber’s account by years and furnishes a framework *before the fact* which not only fits the Strieber-entities’ behaviors like a key a lock but gives us a needed perspective of *evaluation*.

On page 21 of Volume III, *The Law Of One*, the Ra entity characterizes a prototypical tactic of the Orion Crusaders, that of “bidding”; “bidding” is described in such a way as to make it clear that Strieber’s experience represents a concrete instance of the phenomenon, a factual case history with which to footnote Ra’s words. “Bidding” is a contest of will, serviceable in determining the pecking order of the social-memory-complex of the Crusaders, and in rendering the general run of consciousness enslaved through intimidated compliance of its own free will. It is a *command of obedience*, precisely such as that issued without explanation against Strieber’s lust for sweets. Its sole purpose is to bend the subject into accepting the command, the actual *content* of the order being largely beside the point (other than the degree of difficulty involved for the subject according to the strength of the tendency to be overcome, a factor which redounds to the polarization of the “bidder”). We find further that any *failure* to exact conformance in “bidding” results in

a proportional *loss* of negative polarity to the aggressor, a situation which the entity must then attempt to rectify. In this way we see that, in terms of the higher densities not only are “thoughts things”, but the metaphorical relations characterizing the order as which beings functionally interact possess distinct energy values, and have a direct bearing on degree and intensity of polarization-alignment. To possess a legion of “servants” in these subtle regions is an actual nourishment to the centers and systems, a kind of psychic “food-chain pyramid”.

At this point a pure bolt of recognition should allay any further doubts, either of the type which question the factuality of Strieber’s accounts or the kind that equivocate as to the actual nature of the entities involved; for we find the Strieber entity virtually paraphrasing the earlier Ra recitation re the modus operandi that identifies the Negative polarity, in its suggestion that the failure to exact obedience on the part of the imagized “Crusader” bears punishable consequence. Not only is this “narration” of the visualized scene an adequate admission of the terms involved, for those with prior knowledge as is supplied by the Ra description; it is a continuing *illustration* of the way in which the Negative polarity extorts the desired obedience—and thus soul capture—through manipulation of the Love value belonging impartially to the psychic plane through which this largely takes place.

What then are we to “do” with the counsel of the general Teaching thus far delivered to this density, such as that of “love thine enemy?” How are we to interpret such a precept or indeed understand the principle of Love altogether, when its application seems so susceptible to a sticky, spider web ambush from planes of reality actually *eager with invitation* for so innocent an approach?

### Love Was All He Said

At this point it’s important to understand the way in which a spiritual truth is necessarily *reflected* into zones of adaptation. Principles applicable to one density of consciousness aren’t just outmoded and put aside upon “stepping up” to another density. It may however be necessary to identify the form in which such a principle is recast, according to requirements of a density nearer in direct spirit to the Truth which it expresses. In this sense, from a perspective that may be characterized as “4th density”, the appropriate disposition of the Love-nature which serves it most perfectly on all occasions is that of *whole-hearted Love of the “One Infinite Creator”*.

We may of course readily recognize this “higher truth”; it is none other than the Shema of Israel, which Jesus identified with the heart of the Law. If then the first spiritual precept to “Love God with all your heart” is a familiar reference of *3rd density consciousness*, how is it that such a framework possesses it? And how does such a reference coexist with corollary commandments and encomiums, i.e. precisely those such as “love thine enemies”, “love your neighbor as yourself”, etc.?

The general rule, “Love God”, reaches alike to every density, for it is in its *essential* character the spontaneous outpouring of the Truth of Life apart from any formulation or customized tailoring. Thus the 3rd density freely receives it, just as any other, regardless the functional state of understanding. At the 3rd-stage level of egoic self-reference, such a rule incarnates through abstract conceptual distortions practically screening direct cognition of that Whole which is the real referent of the rule. In order that such a rule be functionally operative and lived according to its spirit, a level of mind-body integration and harmony is required that abuts the threshold integrity of a “4th density”; for such a (minimal) state of unitive coherence is able to surpass *identified allegiance* to the ego-divisive verbal mind, thereby settling into congruence with the actual holism that informs it as reflective expression of the Holism of the Creator.

It is through such holistic grasp that the undivided Love of the Creator is received as the constitutor of all centrist reference, so that such a composed self-center may in full awareness ascribe that Love-value to its true Giver, faithfully returning the Gift. Where—as

in the ordinary state of 3rd-density consciousness—this cannot be done directly owing to the prohibitively *low level* of mind-body integration and harmony, Compassion-incarnate adjusts the means to suit the available material. Thus a relatively indirect instruction is necessarily given, one which compassionately takes into consideration the actual compass of comprehension practically available.

The “holism” of Self and Creator is functionally masked at 3rd density level by the compulsive allegiance of the (potential) whole-value of identity in one-to-one *equations of identification* with the preferential profile of the ego-inventory; thus the advice to “love thine enemy” may be understood as very practical strategy meant to extend the I.D. beyond its contractile, lopsided self-enclosure into a more *unified resolution* recognizably encompassing polar terms as facets of a single Being. It’s suited strictly to a level of functioning which is not able to proceed directly *from* a grasp of the Whole, but must attempt to *approach* the Whole through comparative inference.

Such a compromise adaptation of the primary rule, while it may serve well enough at its level as a rehearsal, shows precisely why it was a stop-gap measure progressively less viable in *very practical ways* as consciousness approaches the plane at which the Law operates through self-evident values and direct qualities.

When the general level is raised at which the Love-teaching is received, the relative inefficiency of its previous level of reception becomes apparent; the possible pitfalls and mental snares of that reflected, stepped-down viewpoint emerge like serpents and spiders from the rocks when the open invitation to take on the higher responsibility of a more profound level of existence at the same time discloses conditions revealing the defect of lesser adaptations, and making mortal the dangers of persisting to identify a whole and indivisible Value with fragmentary phases or preferred parts.

When (in adaptation to the more direct Influence of Truth infusing the higher densities) we learn the whole-being expression of Love as that spontaneous *Love of the One Infinite Creator*, the very essence of Love tends to emanate impersonally as a *global value*, spreading without effort or special address to all quarters where it’s received or not according to the specific will of every form. In this way its Presence doesn’t become confused with the conditional presence of the myriad beings “positive” or “negative”. Nor does its Presence become confounded with the mechanics of “give and take”, which are all relative identifications of the mind (look again at what befalls Strieber in his mental efforts to *specify* the love-value he felt lurking in the worst of circumstances; notice the manner—common to the complex of 3rd-stage psychology that accepts the teaching of Love according to its lights—in which he winds the skein of complicated love-strands through a conceptual miasma of “owes” and “oughts”, bewildered by just those ordinary terms of psychic bookkeeping).

### The Portrait of Dorian’s Grays

When considering the extraordinary deception woven about the circumstances of such abductions as Strieber’s, we may wonder how it is that the entities involved don’t simply use their obvious powers of illusion to mask their awful character; for in all the captious play-of-mirrors produced in relation to the principle of love, the actual ferocity and venomous character of the Crusaders seems to

spring irrepressibly forward, thus in a sense almost *requiring* a tremendous expenditure of energy and time toward bullying some interpretation that belies the painfully obvious. The answer to this, also shows succinctly the real nature of the phenomenon with which we are dealing.

The origin and informing character of these entities is, self-evidently, that of the density corresponding to (what esotericism knows as) the *astral plane*; and what esotericism knows of the astral plane clearly accounts for the *transparency* of their basic presentation, which, as we’ve noted, calls for an overlay of psychic subterfuge. The Law governing astral existence, requires the exteriorization of basic character in identifiable symbolic terms. All “form” in its astral origin wears its heart symbolically on its sleeve. It is for this reason that a physical object of apparently neutral character such as a knife, when perceived astrally may distort in dream-fashion into a recognizably malevolent entity, assuming a distinct persona in the manner of anthropomorphized objects in a Silly Symphony.

The Strieber entities give the overpowering impression of malignancy, because that is their character; and by extending their essentially psychic, 4th-density being into physically perceptible



range, they are merely spreading the compulsive “honesty” of the self-symbolizing Astral medium into twilight structures visible to eyes of flesh. (Such spontaneous, symbolic exteriorization functioning much like the Portrait of Dorian Gray, becomes progressively less reliable as an index of “moral valuation” the higher up the scale of densities we ascend; thus the luminous, angelic white entity Strieber encounters as a kind of harbinger of death in *Transformation* does not qualify by appearance as a positive manifestation. It is of the Negative along with all the others; but it is a relatively rare presence in the corpus of the Strieber account, since it emanates from the *5th* density of creative Mind. Thus it represents in its appearance the power to conceive and govern whole patterns of exteriorization. The Ra material discusses just this capacity of the 5th density Negative

adepts to assume so fair a shape; and in fact the likelihood is altogether greater that higher-density entities either positive or negative who manifest in more “pleasing” human terms are *5th density* beings able to modulate the matter of visible appearance according to inner conceptual requirements, rather than merely being able to regulate it from a point past its primary patterning and projection).

### Speaking With Forked Tongue

It is for this reason of direct symbolic disclosure that the Negative hierarchy often finds more efficient means of dissimulation in the *channeling* phenomenon; for here, there is no direct encounter or condensation to “visible appearance”, but only the medium of the *word* to be interpreted according to the recipient’s lights. The mode of expression is by that measure *indirect* and the Negative beings have therefore a greater latitude of deception at their disposal.

Since the Negative is altogether, in one sense, an inverse reflection of the Positive or True Creative Logos, a parallel configuration borrowing all its components by simple reversal and distortion, it proceeds by the method of imitation. It *apes* the expression of the positive, the more meticulously where it wishes to be mistaken al-

together for the positive so as to subvert the message for those who tend to abide by it. Its typical strategy is to adhere so closely to the letter of the positive as to be virtually indistinguishable to all but initiated awareness, installing itself through the rhythmic lull of entrainment so as to catch the "congregation" totally off guard when it diverges slightly or greatly from pattern and so pulls a portion of the positive track along with it.

The voice of the Negative is of course the more ingratiatingly imitative where the inclination of the recipient is already to the positive; a negative receptacle requires no such precaution.

Even in the case of channeling, however, the character of the Astral origin compels the insinuation of a sign, a kind of confessional signature no matter how subtle. Indeed this trait of the communication is often accepted as a device of mockery suited to the character of the source; it is played with as a defiant means of asserting the true identity of the Signal, hiding it in plain symbolic sight in conformance with "astral" requirements.

This law which insists even the physical form exhibit "some sign or characteristic which identifies" the "true essence", is indeed remarked upon by one such channeled source, the *Hilarion Material*. *Hilarion* is an entity identified in both the "Christ" materials of V. Essene and the Ra channelings, as a being of the positive Hierarchy. Thus when we see books on the shelf bearing the Hilarion moniker we automatically respond with a beam of recognition. Hilarion's "channel" (Maurice B. Cooke) seems decisively predisposed to the Christian stream of positive teaching, so we are not particularly surprised when the second half of *The Nature of Reality* (which had up to then been a so-so account of "esoteric physics") breaks into a frenzied description of the imminent apocalypse. Indeed, the book ends with a graphic account of destruction and the final torment of souls as they are beaten to their knees in extortion of a "repentance" and "turning to God" which they'd apparently been reluctant to make even when melting into one another.

This stomach-churning peroration was no accident, for in another Hilarion volume, the source proclaims that the structure of the book had been deliberately designed with the "Armageddon" last so as to attract a particular type of "select" readership.

### My, What Big Eyes You Have...

With an eye, then, to the Ra account re the way in which the Orions have traditionally sought to subvert the positive messages and meanings of persons or events through emphasizing moods of doom and destruction, making such negativity a *central feature* of the communication thus deflecting attention into brooding byways of despair, we may turn to the *Hilarion* account of the existence of Negative Beings (or the Dark Brotherhood, in the terms of this source). According to Hilarion's account, the Negative is allowed to exist because its minions act in the ultimately helpful and healthy capacity of predators that only decimate the "diseased" ranks, i.e. like wolf attacking the sick or congenitally weak specimens of caribou (Hilarion's analogy). "The wolf attacks these defective caribou, and would never think of wasting its energy trying to chase or bring down healthy specimens. By weeding out the weaker ones, the wolf ensures that the healthy remains strong." With this edifying version of Christian Darwinism, we are comforted into the notion of our constitutional safety (considering the readership of such a work to be ipso facto amongst the Elect, an assurance "we" were already given in the gross-out discussion of Armageddon).

This encouraging information hardly tallies with the outright attack which the Orions launch upon the Ra channelers in the very midst of their activity (see books II, III and IV, *The Law of One*); nor does it square well with what initiated knowledge otherwise knows about the effort of the Negative to attack, discredit or physically eliminate those who are quite positively polarized and in no way "defective" in the arrogant sense that the Hilarion material proposes. It is also more than passingly interesting to note that in the film

*Wolfen* taken from Whitley Strieber's book of the same name, the behavior of the predatory creatures is rationalized in *precisely the same way*, i.e. that they are simply weeding out the recrement of mankind thereby ultimately strengthening the total stock (the fact that one of the "good guys" who even *subscribes* to this interpretation and is in no way depicted as "defective", is nonetheless wantonly massacred by the creatures, attests to Strieber's early powers of schizophrenic dissociation, and gives us as well certain cause to look more deeply into the character of the Hilarion idea).

### Too Many Plots Spoil the Cooke

When we read on that the Dark Brothers are allowed to "test" a channel such as Cooke (apparently alluding to an early channeling incident that must have been a source of some distress) by making an *agreement of exchange* with the "White Brotherhood", each bargaining some "deal" or concession from the other, we are squarely on Donald Trump territory and about as far away from the facts of the polarities and the densities as we can possibly be. (The "Hilarion" rationalization here is almost self-evidently a cover story, meant to assuage Cooke more than anything else; for initiated understanding *does* recognize that a Negative source, having attached to a positively-disposed channel, will push the negative hypothesis into increasingly more overt expressions in order to determine how much the malleability of the subject will yield to directly negative propaganda. Apparently at one point Cooke must have been pushed too far, and this absurd scenario was manufactured to explain the cordially adversarial relations whereby the Positive and Negative players of the higher realms use the channeler's "inner instrument" like a Borderland parimutuel window).

When we read further along how to identify the interference of the "Dark Brotherhood", we presently realize we are being disabused of the *Seth* teaching (although of course that teaching isn't specifically named due to the punctilious observation of that "Cosmic Law governing the operation of these testing factors"); Hilarion's objection, revealingly enough, has to do with the "impropriety" of explaining *cosmic* truths of simultaneity and probability to the anthill focus of physical consciousness, which should be properly stuck with the *mea culpa* considerations of karmic consequences; thus "Hilarion" neatly pivots us *back* into proper alignment with all those conventions of cultural conditioning that chronically lock us in place as a mechanical unit of cause and effect, and away from the elastic efficacy of the *present* poised at the juncture of potential change.

Finally, Hilarion regales us with the assurance that all "galactic observers" within the "region of Earth" are necessarily friendly, contrary to the misleading teachings which would have us believe otherwise. "There is the suggestion that some are distinctly alien and even hostile, and that certain of these beings kidnap humans and kill animal life for experimental purposes". To disabuse us of this baseless notion, "Hilarion" resorts to no less than the old canard about the inability of any civilization in the galaxy to develop interstellar technology until such time as it decisively overcomes all negative inclination (!). Thus any close encounters, sightings, landings or interactions of a third or fourth kind are necessarily conducted only with the kindest and most positive of beings.

### Flying With Expired License

It is precisely here that those most glaring of contradictions indicative of the channeling phenomenon become inflamed, and virtually *force* themselves upon our notice...right along with a virtually self-disclosing hypothesis that accounts for them. For the Ra material *specifically* warns that Confederation sources (with very few exceptions) refrain from any but long-distance exposures, generally only in order to extend the range of mankind's inquiry toward renewed consideration of the Unknown, and almost never effect that kind of encounter known as "landing". Landing has become the almost exclusive resort of the Orions, the Negative Beings. Thus, virtually all

"close encounters", reports of abduction etc. are of the manifestly negative type. Despite his composed rationalizations, Strieber's emotional declarations continue to ring in our ears; and the material gathered into such sources as those of Budd Hopkins, certainly have little of the aura of "good will" about them.

Then just what could this "counsel" of the Hilarion material possibly mean? It seems only too evident from this as well as other "revelations" of the teaching, that the "Hilarion" source conforms to the methodology of the Crusaders as disclosed in the Ra Material, i.e. that of close adherence to the style, thought and content of positive sources so as to sneak in "undercover" as it were, and at the point of greatest vulnerability—when the subject is set at his ease and off guard—pour the venom of disinformation in the audio channel. (We should be interested to know that "false teachers" can be identified by their appearance, whether they're too fat or too thin, whether they look as if they can be trusted and—oh yes, whether they've "ever been hounded through the courts, or banned from any country"—an interesting criterion, considering such an ostensibly "Christian" source. Perhaps the governmental persecution of true Teachers is a phenomenon confined to the old Roman past.)

Taking all this together, we may now identify the very emphasized oratory of the Hilarion material on page 26 of *Dark Robes, Dark Brothers*: "Specifically, by asserting that one should *love one's enemies*, Christ presented the single most effective way to overcome the temptations of Earth life and to confound the whisperings of the Dark Brotherhood." Interesting that of all the possible teachings and enlightening words of the Christ, this material should go out of its way to emphasize the *one* expression which is most subject, in such a context, to the distortions of 3rd density thinking patterns. For of all the possible teachings that might effectively have been drawn upon, the one which lends itself most readily to the snares of the Negative poachers is precisely this precept, presumed by a mind-body complex insufficiently unified in congruence with the conscious axis to make the necessary 4th-density transference from the psychological structure where such imperatives come to lodge, to direct alignment with the unitive Ground of Being from which love streams naturally in all directions without entrapping concern for "friend or foe".

### I'm Sorry...Do You Have Any Credit Cards?

Finally, there was the case of a student of the initiated teaching who, finding the cover signature on the Hilarion books quite intriguing by virtue of its consistent entwining of the heels of the letters "L" and "A", decided to apply a Qabala of numbers whereby, lo-and-behold he determined that the deliberately emphasized letters clearly spelt "LA" which in Hebrew means "nothing" or "zero". Since Zero is alphabetically an "O", his eyes automatically transposed that letter over the "LA" on the cover signature and, much to his amazement, one of those clever "astral" disclosures sprang forward, of the type that shows the natural compulsion of the medium to reveal its character symbolically (as well as the perverse delight taken by the Negative in coding its identity in plain sight): HI ORION. (Some of the book covers indeed *expressly separate* the letters H and I from the rest, which are arranged to touch one another so as to group the "LARION" with its entwined L and A in one bundle). Indeed the contents of "Dark Robes" etc. (a book, remember, *about* the negative beings) pointed to its own clue in declaring that even all physical things bore the symbolic signature of their particular source.

### This Is Not the Behavior Of an Ordinary Kitchen Appliance

It is necessary to note that the growing public presence of "negative" literature (i.e. books overtly or unknowingly inspired from spiritually-negative sources) is not just the mild circumstance of a "democratic distribution" of diverse information. The presence of such material is not innocuous; nor is its active component confined to the personal imbibition of content. It is not in the contents *alone*

that such media carry their infectious messages. Everyone reading this review section should take to heart the real lesson contained in the incident reported by Strieber in *Transformation*, i.e. that of the psychiatrist who upon *seeing the cover of the book* felt compelled without knowing its contents to purchase it, the next day being greatly surprised to hear a number of *patients* report dreams of UFO abductions for the very first time. It is revealing that the covers of both Strieber's books depict the alien countenance of his abductor; for in *Communion* we learn that the entity actually *modeled* for Strieber at the interior space of his "third eye", specifying that it wanted the artist who would transcribe the description to *get it right*.

To initiated understanding this clearly shows that the accurately-rendered image was to be used as a kind of talisman, or a material basis for the manifestation of that force-influence to which it corresponded.

Strieber gives vent once or twice in *Transformation* to the sentiment that, if he really thought the creatures with which he was dealing were negative or harmful he could not in all conscience expose people to what was clearly a powerful and unpredictably commanding influence. He should have held on to that thought. He should have made every effort to penetrate the shallow rationalization by which he "forgives himself" for his recalled participation, in youth, as the apparent ringleader of the "children's circle" whose job it apparently was to lure acquaintances out into the haunted woods of night where presently, amidst the horrified shrieks of many, they would find themselves face to face with something unspeakable. . .

In addition to Strieber's books, there is a motion picture of *Communion* soon to be released, as well as a spate of other movies already primed for the competition that purport to depict true-life alien encounters. These should not be considered ordinary modes of entertainment. They must be understood as vehicles, very potent types of imagistic "talisman" supplying the material basis for a mass manifestation of unprecedented character. We need to listen more closely than ever now, to a channeled source that dates back to 1957; for in *The Secret of the Andes* we find a corroboration of the Ra source which predates that communication by many years, in which it is specified by name that we are under invasion by the Orion Empire.

It is necessary to understand this for what it is, and not treat it as a removed spectator witnessing another phenomenon of mass entertainment. Everyone is involved; and there are children present. As was indicated, in last month's review titled *Movie and Dream; the Qabalah of Star Wars*, motion pictures have a profound correspondence with and influence upon the dream-psyche, owing to the structure of the medium. That harbinger of the "Freddie" films, in which there arises an incursion into waking consciousness of the terrible content of dream and nightmare such that they are presently confounded and inextricably entwined, is poised to take place "in reality" the same as it was prefigured on film. In the specific instance of the Strieber books it is very advisable to neither buy nor read them, and this is *not* the expression of some "censorship of content". There is something else going on altogether, something for which the public, in its wildest dreams, is scarcely prepared. It is advisable that the new films such as Strieber's dealing with UFO abduction etc. be given a wide berth, and certainly children should be kept away from them. They are not just "spooky" movies, good for Halloween-type thrills.

This is not an easy month for your reviewer. The decision to advance this discussion and extend such difficult, goblin-ridden counsel has not been made lightly. But the truth should at least be put out, out on the bookstall floor or streetcorner along with every other conceivable kind of information in the endless bid for the ephemeral attention of this place. What people choose to do with it, is a whole other column.

But do it we must, and did. This is the ghostbusters boys; your cover is blown and your time's at hand.

E.T., go home.



*Ra Material* (collected works)..... \*\*\*\*\*  
*Seth Material* (collected works)..... \*\*\*\*\*  
*Communion and Transformation* ..... Z

(This is an instance in which a Z recipient actually exhibits emotional and intellectual power, and even occasional sparks of real Gong Fu. Strieber is an excellent writer; but these books have the beauty of the molecular structure making up the substance of strychnine.)

*Hilarion Material* (collected works)..... Z

Don't miss Part Three of *Channeling UFOs and the Positive/Negative Realms Beyond This World* in our November issue. (Oh, yeah, did you hear the one about the UFO that crashed in New Mexico in '47 that the military recovered.....)

**Rating system for all book, film, tape and video reviews:**

- \*\*\*\*\*  
Has Gong Fu; has technical and intellectual/emotional power.
- \*\*\*\*  
Has Gong Fu; has a measure of both technical and intellectual/emotional power.
- \*\*\*  
May or may not have Gong Fu; has a measure of technical and intellectual/emotional power. (Since Gong Fu is the principle that sets a work on fire, intensifies it to the degree of boiling, then a 3 or 3 1/2 that has Gong Fu possesses it to the extent that the work, at least in part, exhibits first signs of real kindling; it strikes a genuine spark of combustion, at least in places. If a 3 has no real Gong Fu, it must still have a good degree of technical, intellectual/emotional power.)
- \*\*  
Has no Gong Fu; may have technical or intellectual/emotional magnitude.
- \*  
Has no Gong Fu; has little, though possibly some, technical or intellectual/emotional magnitude.
- Z  
May have any of the above, including (sometimes but not often) Gong Fu, but still deserves to have the Marx of Zeppo swiftly etched across the designer label of the smug-fitting back pocket.

**PART THREE**

**Will, Being and Well-Being**

In Parts I and II of *Channeling UFOs And The Positive/Negative Realms Beyond This World*, we discovered through such proffered channeling sources as the *Ra* material that "graduation" beyond this threshold 3rd-density existence holds ambivalent implication, of a disconcerting type, for many who'd assumed that only the "positive" alignment possessed a purchase on integration adequate to make the advance in required spiritual coherence. As it turns out, negative orientation of a virtually exclusive, self-serving type is capable of commanding a coherence and sufficient systemic integration to "make the grade" as well; as far as the necessary technical degree of mind-body organization and threshold intensity (or purposive unity) is concerned, the negative polarization can exhibit a "harvestability" equivalent to that of the positive.

This is where the comparison ends, of course, since beyond this admired 3rd density plane (where such decisive polarization is still being determined) the astrally inclusive, biopsychic fields of an overt void-nature obediently factor out into discrete realms of qualitative organization spun respectively about the poles of either positive or negative orientation. In this way the *law* of that level is exhibited whereby correlated properties formally combine into the unific presentation—or cohesive exteriorization—of the Symbolic value functioning as common denominator. Thus *identities*, on the aggregate, compose worlds of a basically astral character; and even the "materializing" property of the informing, focal-coordinate lockin whereby that group psyche incarnates exists structurally as a system of mutually reinforcing parallelisms, of a uniform or consistent grain, as distinguished from the earth/physical structures integrated through magnetic opposites.

The idea that negativity or "evil" orientation not only survives this plane of blindered ignorance but is capable of holding its own and advancing through the higher spheres of more overtly spiritualized substance, is not only a distressing notion to many; it is difficult for some to accept on philosophical grounds due to the conventional understanding that "negativity" is inherently self-divisive and therefore ultimately *disintegrative*, so that the requisite unity consistent with Being through the higher planes is by nature beyond its grasp.

And of course this "understanding" holds, in an ultimate sense; as the *Ra material* explains, spiritual advance through the Negative Hierarchy reaches the pons asinorum at the mid-point of the 6th density, the cutting-off place just before consciousness merges into unity with the so-called Oversoul or Higher Self. Anywhere prior to that point the inherent deficiency with respect to negative orientation may have become apparent to the ongoing focus of consciousness assaying an "ascent" by that mode; the upper limit of friction, division and thus *inanimation* (or unassimilable energy) may have been grasped as the inbuilt barrier to perfect resolution with the Whole in terms of the Negative tactic.

But in any case such recognition is inescapable at the threshold of mid-6th density, where the necessary magnitude of Wisdom as it is made impartially available discloses the structural impasse automatically defining the upper limit of compatibility between the "unity" of negative orientation secreted around the false granule of the illusory ego-self, and the uncompromising Unity of Absolute to which that imitative parallelism aspires.

It's important to note however that such inescapable concession, *structurally* imposed at the degree of conscious intensity corresponding to "mid-6th", indeed occurs at a relatively "late" or advanced point. This indicates that the stress of *ultimate* incompatibility is not a sufficiently imposing factor through any of the

previous stages as to comprise an Imperative. There's no *obligation* to confront its proposition until the brink of Oversoul consciousness is met. Thus the whole hierarchy of spiritual strata preceding this point, is capable of being strewn with the litter of relative negative "waste" without obligation on the part of that poisonous processing to dissolve.

When we turn, puzzled, to ask how this may be, we need look no further than our own 3rd density backyard. Here recent research has found, on behalf of the general *Newsweek*-consciousness, a medical evidence not only tending to substantiate aspects of the perennial Teaching regarding the relation of mind and body, but ripe with other implication. Scientific investigation into the "mental" influence on health now documents that those exhibiting strong positive correlation with values of will, confidence and self-motivation tend to display proportionately strengthened immunological response. Just as it has been established for some time that protracted stress of an internalized type (manifesting as "anxiety") as well as prolonged periods of grief, depression and boredom predictably correlate with depressed immunological function, so conversely it's been found that the highly purposive, self-confident psyche literally tends to amplify the available leukocytes and in general enjoys a more resilient mind-body vehicle—and this *independent* of whether the personality is altruistically oriented, a self-giving soul of beneficent motivation or on the contrary a narcissistic and manipulative power-broker out in full-force service to *self*!

This should be very instructive, for those who can read the implication. From this interesting data, we can locate the *mechanism* behind the otherwise perplexing intelligence that beings of a committed, threshold degree of inner unification whether positively or negatively oriented may equally advance to the higher ground, where their respective intentions are granted more potent substance with which to experiment.

The common key of such advance is not the *character* of the motivation per se; it is not a *moral judgment* that draws the line, at any threshold gate of progress. The common key is identifiable here as *will*, and its closely correlated value *confidence*.

*Will* is medically associated with the cerebrospinal system, known as the *volitional axis*; voluntary behaviors and conscious determinations are connected to lobes and circuits of this central nervous network. A highly integrated and purposive will would in effect "take command" of the whole being much more thoroughly, as that channel through which consciousness acts and with which it's aligned comprises the locus of organization for the total mind-body complex. Through volitional unity all instruments, faculties and functions of the being (*processed* by autonomic currents of the subconscious systems associated with the extended line, or frontal axis, flowering with its glandular "points" from the central column) tend to be harmonized, set to mutually cooperative service in a more efficient manner than is characteristic of the average of those same processes taking their "commands" from self-contradictory programs, of mental quandary or mutually conflicting intents, indicative of the ordinary 3rd stage psyche adrift in the chop of indirection.

It's axiomatic that those functioning through a sense of "control", whether control over some precious little area of their private world or apparent control over the fate of nations, infuse a kind of concord through all the coordinate processes of the mind-body whole; such agreement of intent amongst contributing aspects of the being promotes a high harmonization of part to subconscious part expediting the efficient issue of every order.

Conversely, those with a comparative sense of helplessness, of lacking control or the capacity for direction and who therefore succumb more readily to despair, equally "program" the subconscious processes through volitional currents and intents; there is no escaping the order of influence which always, in will-positive manner, proceeds from the implicit "command" contained in the aggregate of intimately-held concepts and feelings, of which the relative congruence or lack

## UNWANTED: The Great Orion Gang (GOG)

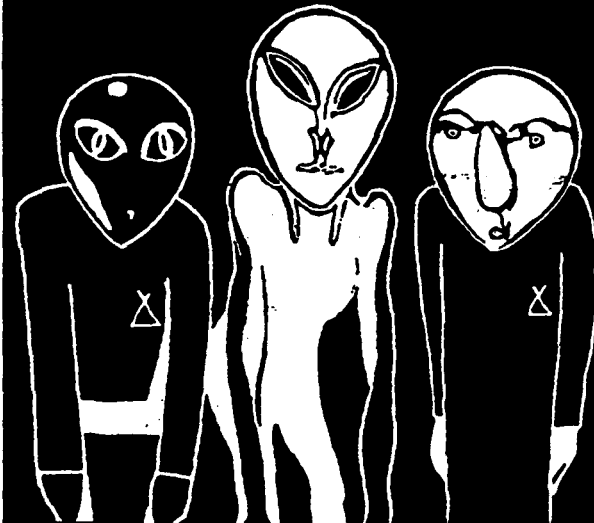

**Sought by Law Enforcement Officials in all known Galaxies. On 6 counts of violating the Man Act; 66 counts of infringement of Civil Liberties; 333 counts of Psychic Burglary and Aggravated Mayhem. The Sloe-eyed Vixen in the center is their reported leader. If you see these notorious cosmic banditos, do not attempt to subdue as they are armed and dangerous...Call FBI (Free Being Intelligence) for immediate Protection.**

of correspondence with inherent Unity impartially authorizes the behavior of subconscious response-patterns in faithful transcription of the character of the command.

In this framework there are really only two kinds of mental contents and feelings with which the value of identity can become involved, i.e. those which reflect and enforce the reality of the volitional directive of the mind-body whole, or those which belie it. In either case the subconscious systems process the mind-body pattern and its *em* field in conformance to the internal implication of the identity-content. Thus it's never a matter of whether there exists some impartial gauge of being from which a "realistic" assessment can be made regarding the actual proportion of our "control" or "helplessness" as subjective centers of the universe, or objective bits of flotsam in the buffeting cosmic tides; there is only the *impact* which such estimates, infused with the committed force of identity and "volitional subscription", may make in their respective values on the nervous systems that encode their implications in the cells and biochemical functions of the mind-body vehicle.

Since there is only *one* orientation (between these two possible positions) which conformably reflects the *unitive truth* of the very process of which it's a function, there is only one orientation which can effectively serve to advance the being into deeper congruence with the ground of that truth; for the opposite orientation *denies* the



validity of its function in the very process of implementing it (as an inevitability of the structural correlation between the mind-body system and Whole-conscious Being) thereby *undermining* the inner instrument of its potential self-focus and adjustive resolution. Ergo, either positively-oriented or negatively-oriented beings of a sufficient, threshold value of volitional unity are candidate for advance to the "4th stage" in the developmental saga of consciousness. As far as the practical mechanics are concerned, it's equally possible to create a strong integral system in orientation about the axis of an insight inspired by the spiritual Oneness of being, or around the illusory core of a persistent self-hypothesis to which the credit of Oneness is extended.

This brings us, in turn, face to face once more with a problem we'd commonly assumed was surpassed once we'd crossed to the comparatively "foolproof" ground of *channeling*.

### Crossing the Channel

Channeling, after all, seemed to possess a timely-inbuilt solvent to a difficulty just recently experienced, i.e. the troubles encountered when in our dawning ecumenicalism we'd presumed the Eastern attitude and opened ourselves to the possibility of *embodied* enlightenment (therefore necessarily exemplified in some current, incarnate being Who could act as the exhibition and demonstrable forerunner of our own imminent awakening). What was rapidly discovered, (as a genuine or apparent disclosure in any particular instance) was that whoever *declared* himself enlightened was not by the sheer magnitude of such announcement necessarily or automatically enlightened.

This of course led to corrosive distrust regarding the possible, lurking presence of *ego* behind any agent occupying the same (notoriously ego-riddled) plane as ourself.

Embodied, walking-talking Enlightenment was a novelty devoutly to be wished by those whose cultural instruction confined the benefits of spirituality to an afterlife, and to one historical personage possessing exclusive proprietary rights to the genre; but the barrier to locating the living address of such a sublime state of consciousness seemed proportionately insurmountable, since the very factor making it so attractive (i.e. the possibility such a Freedom could arise precisely in the heart of ego-territory) was also the factor making its identification *through* that agency and *in* that milieu terminally ambiguous.

It's for this reason that the phenomenon of channeling, young and marginal in the '70s heyday of Esalen, human-potentials, est and Divine Light Mission inevitably flowered as that first hope waned.

The prospect of channeling seemed suddenly made to order. If the Catch-22 of locating Enlightenment-incarnate in "3rd density" hinged on the common presence of ego belonging to so low a plane (permitting sheer chicanery to cloud perception) then the obvious answer was to inquire after that Enlightened status only through planes or states of being intrinsically *ego free*, and thus patently safe—by definition—from the subterfuge of self-serving. The presumption underlying this, of course, took background from our very cultural conditioning through which we'd long learned to make the conventional equation between "spiritual" existence and innate beneficence. Naturally we were more than delighted when (ignoring our own new, highly-touted occult discovery re "like attracting like") we began apparently receiving "objective" corroboration of this equation from our contacts with the Other Side.

For yes indeed, Seth Spoke and many more followed suit to the effect that "negativity" is a subjective misperception, brought about by the masking opacities of our 3rd density camouflage world and therefore—like a deepsea fish—unable to survive the transition to the "upper atmospheres". Ignore for a moment that Seth actually qualified what was otherwise a very emphatic and consistent teaching about the formative power of thought, in a minute passage from *Unknown Reality* in which he proclaimed that "90% of the time",

encounters with the specter of negativity are purely self-created. Ignore the fact that the exception of even one all-but-negligible percentage point changes the picture dramatically from the wholesale authorship otherwise espoused—ignore all that but for the *larger issue* as to how it is that Voices speak to us from an apparently Homogenous Beyond, in tones of supreme confidence allowing no room for reservation and still manage to contradict each other as flatly as spokesmen of competing political parties? How is it, we may well ask, that one Voice lulls us with the glamor of a world in which all "evil" is reduced to a subjective ignorance that can't withstand the all-absorptive Good composing the inner planes; and another is equally sanguine that the Negative comprises a whole Ontological Orientation, a basically *spiritual* interpretation of Being existing independent of the projection-screens of our privately enveloping auric wall, vouchsafed validity as a polarized *universe* of implication extending a particular hypothesis of "unity" to its logical extreme?

And how may we, in our apparently inferior position, possibly discriminate between the two?

The usual new-age afflatus to the effect that both may be "equally valid in their own space", just doesn't sit well. It's for this very reason that we turn again to the *Ra material*, as per our method of last month in which we "play by Queensberry rules" and consult the *internal evidence* at its highest available source in order to find some resolving principle.

In this case, it's necessary to note the distinction which Ra makes between the orders of *space/time* and of *time/space* (all the densities from Ra's Perspective downward are organized in these complementary ways). Although the *Ra material* doesn't detail the significance of these organizations beyond certain preliminary points, they are cited as categories of consideration because of what they necessarily imply.

### Through the Looking Glass: The Time/Space of Our Space/Time

We may understand "space/time", first of all, in the terms we're familiar with. We occupy the system of our space/time as a vehicle, (or axial, mind-body locus) through which the coordinates of that system necessarily arrange all features according to the requirements of *situationality*. We are *located*, vehicularly, at and *as* a particular juncture of time and space, so that the values of "near" and "far" acquire functional importance. In this context, our limitations are our opportunities; what is filtered through the bottleneck of space/time becomes the focus of our concern, and the material of our resourcefulness in operating through finitizing faculties. Because our condition is one of centrist perspective and therefore discriminative *navigation*, the order of space/time comprises the context in which progress is possible through situational *doing*. We learn by acting through defining conditions, from which an order of consequence develops whereby to gauge all *Adjustment*.

We may have heard that at death, the limits of the localized body dissolve, and we move through a lighter material into conjunction with a display of space and time that's comparatively plastic. It's here that, in the unity of a presiding Light, we may review all the features belonging to our personal past without regard for the usual measure of sequence, or apportionment of priorities. Everything appears equally available, in the manner of a deck of cards fanned out in panoramic display or as simultaneous images shining in a reflective flotilla of bubbles. Here there is no "rootedness" at an enclosing, defining space/time juncture similar to that which was experienced in physical life. The "vehicle" (or axial locus) of the mind-body being which may be identified as operating in the new state, gives no impression of imploding on a contained self-sense but rather has more the feeling of an acceleration constantly surpassing itself, expanding through Space of starry nerve-clusters in a range embracing the soul-record to the finest part of the life last lived. This is the complementary field of *time/space* belonging to the *inner planes*

of 3rd density existence. The ticks of time are indeed *spatially* exhibited, in a kind of interior hall-of-records where a life-review may be conducted and all the "masked" elements unveiled for a kind of global consideration.

This is an *interval* in the pattern of soul-progression, usually conducted as a kind of protracted sleep-and-dreamstate wherein experience may be assimilated, distilled, and the various steps of "dissociation" rehearsed whereby the heart is ferried—on the implacable subconscious current—through the underworld ordeal of a purifying *dis-identification* from every attachment and lingering fixation of form—summing in the Amenta of the psyche's recuperative rest what must eventually take place as a *volitional work of conscious understanding* in the context of space/time limit.

This *time/space* framework of the inner planes is inferentially sealed up, self-enclosed for purposes of such soul-examination; for here the most important determinations must be made as to what the soul *has within it*, and this process necessarily goes on without disturbance.

Such a state is a kind of clearinghouse for the assignation of souls, each according to the quality distilled in the process of "becoming" the sum-total of what, viewed in the complementary space/time frame, is spread out piecemeal as a sequentially shifting pattern. From this time/space antechamber, where the soul aligns progressively with the *non-local* character of the compositional coordinates subtending all "local" clusters of physical existence, the distillate of psychic focus comprising the latent personality-expression may be transferred to the *spacetime* framework most consistent with its net value; these worlds of space/time organization may indeed, beyond the admixed education of 3rd density, polarize to the emphatically positive or decisively negative.

The complementary time/space frameworks of the "inner planes" of each succeeding density, function very much on the same principle of review, analysis, attunement, adjustment according to sum-volitional inclination, and further assignment of *space/time* fields in which the relative "localization" of vehicularized consciousness furnishes conditions of real, developmental furtherance and learning.

The "division" between the contractile, self-enclosed *space/time* vehicle and its expansive (self-surpassing) *time/space* counterpart seems much more solid and impermeable in the 3rd density framework owing to the general screening-device of that realm, in which the interior order of things is specifically rotated at mutually filtering angles to the physical field of expression. It's for this reason that there's no direct knowledge of or recognition re an "afterlife", for the most part, at the 3rd stage level of consciousness, all such matters being confined to speculation, rumor and culturally modified myth. In the higher densities the "division" between the given space/time and time/space organizations at each level is less severe; there is a *permeability* between the two orders in the higher densities, greater or lesser depending on the refinement of the density.

Each higher density has a *space/time* framework wherein the soul "contractually" aligns with a nest of embodying vehicles, through which the compound focal patterns of specific level-identification produce an incarnating *eversion* of the currents organizing the locus of cross-correlation and perceptual synthesis. This "invagination" of the participating planes of the current-field (through ideoform lockin of the focal-coordinate line) fixes the streams of multidimensional, patterning geometries into a stabilizing structural hold, concentrating a practical station of space/time "points" of coherent convergence so as to formulate a real *position* of true situationality.

The process is much the same throughout the densities. The extreme invagination or turning-inside-out that comprises the physical 3rd-density frame of *focus*, is represented in familiar terms by the polarized lockin of the *kaundalini*, the energy-coils of which seem to settle the multidimensional turns or Moebius twists of the composing current-fields in inverse order of descent around each other; this in

effect nucleates the subtle, radiant-psychic ethers reflecting the given (operative) Typologies so that *mind* and *idea* seem to occupy a position of faint interiority with respect to the fixed "physical" envelope of structural consistency and inertial repetition, into which those psychic coordinates are aligned.

In the condition of 4th density, such incarnative focal lockin formulates a functional specification of time and place in the same general manner, producing a kind of "materialization" of the Astral field into a similar, situational centrism. There exists the same type of vehicular contingency which makes "travel" in the Astral 4th density fields of space/time a matter of actual space "ships" (albeit of the biomechanical type described in last month's issue, consistent with the psychic level at which material is generally organized in such a framework); whereas we are familiar, if only by hearsay, with the flotational mode of conveyance wholly *free* of any mechanical-vehicular requirement in the context of Astral or inner-plane, 3rd density *time/space* frameworks. This accounts for the apparent discrepancy, i.e. the difference between what we hear in terms of the "Robert Monroe" style of inner-plane astral travel conducted strictly in the Soul-vehicle, and those reports of astral-like entities certainly functioning from the plane of a "psychic" milieu that nonetheless require physical-mechanical vehicles of some type to convey them from place to place: the non-mechanical flights of astral transport through unencumbered agency of the Soul-vehicle in general belong to orders of *time/space*, which have a specific and very different function from space/time in *any* given density; conversely, those modes of travel through astral, astral-etheric or etheric-physical fields manifestly requiring a kind of mechanical or "hardware" vehicle, belong to space/time orders of organization.

Either type of vehicle, proceeding from space/time or time/space frameworks, may intrude upon familiar space/time physical reality.

In the higher densities the frameworks of space/time and time/space are equally discrete, since they serve separate purposes; yet the more translucent modes of organization belonging to those densities allow a permeability which makes the fields and informing patterns of time/space more readily accessible to the vehicularized "localism" of incarnative, space/time agency.

Thus to 4th density "embodied" entities, the whole history of a life-system is *akashically* available even though in practical terms they're functioning at a particular cross-section in the span of that history. Similarly, in 5th density the totality of cosmic patterns comprising the infrastructure of all times and places is theoretically available, even though the "incarnative" pattern of the particular space/time agent functions from the perspective of a situational locus immediately responsive to *certain* worlds, space/time frames and patterns.

In every case, the juncture of "meeting" between the Positive and Negative realms and/or the Positive and Negative Beings is generally reserved for the *space/time* frameworks of any given density, since the time/space frames (serving another function) are largely self-sealed as the souls "isolation-tank", where it may take stock—as it were—of the potential moves of further progress through its chosen polarity.

This accounts for *some* of the channeled information we receive to the effect that the Negative is just a chimera, a "projection of our own subconscious fears and primal doubts", etc.; the other sources of such information *are* Negative propaganda, proceeding from the Negative planes themselves.

#### "Axial" Alliance: The Return of Tokyo Rose

As to the latter, we refer you to the discussion of the so-called *Hilarion* material of *Maurice B. Cooke* in last month's issue. In this particular case the misleading counsel did not proclaim upon the "unreality" of the Negative; instead, it took an alternative tack by recounting the ancient moment of our collective "fall" into material

consciousness as a temptation by negative inner-plane powers which subsequently, so the tale goes, imparted a *spark* of that negativity to the “veiled” soul along with the counterpart spark of goodness furnished from the angelic side. This tale subtly installs a very deceptive and subversive notion; for if there is an increment of truth in the time/space asseverations counseling to the effect that we “create our own reality” (and that as a consequence negativity is but a phantasm of our own mental self-estimates), such truth may be located in the corresponding implication that any term of “negativity” is, necessarily, *wholly self-appropriated*. This is precisely the case, and is the part of such time/space counsel which has a legitimate purchase on the “psychic facts” of our experiential self-patterning.

And it is exactly the personal responsibility, the ultimate soul-accountability contained in this interpretation which the “Hilarion” counsel slyly subverts, through the tactic of conceptually *reifying* the influence of negativity making it in effect a “thing” which is lodged within, an alien presence interiorly importuning over-and-against the volitional consciousness of the soul in which it ostensibly inheres (rather than a *potential*, approached in the freedom of the determining psyche requiring the active appropriation—and introjection—of the consciousness in question in order to possess any personal force at all).

In this way we can see that Negativity is not a phantasm of personal fear and trepidation projection which “doesn’t actually exist” (an understandable if obliquely skewed counsel from the self-sealed planes of time/space); but rather, we can accept it as a *potential*, as real—in that sense—as any “goodness” or “positivity” (whether as aligned with the ultimate character of things or not) and constituting a Philosophical proposition that springs internally from certain considerations of the general terms of existence. It is not an “independent entity” or alien presence that, like an ensouled parasite, whispers subversively from within (implying a passive, dependent and thus ultimately estranged and helpless relation to it), but a general Proposition *requiring an interpretive orientation* (always ultimately made through the inherent freedom of the determining void-psyche of the soul).

Two tricks of the dedicatedly Negative are (1) to appropriate the short-sighted counsel of 3rd density time/space (or the revivifying afterlife of this dimension) in “confirmation” of the non-existence of the Negative except as a subconscious tendency; and (2) to endow the idea of the negative (as in the Hilarion recitation of the “fall”) with an alien and antithetical formalism that, in essence, imposes upon us a “forced” or inoculated kinship rendering us all that much more powerless and *ineffectual* in relation to its invasive presence. (The fact that in this account we are also “inoculated” with the Good, only makes that value-potential an equally alien and invasive presence contending for the soul in virtual independence of its passive-battleground condition. The soul, in such a case, simply becomes an incidental “site”, and is reduced to the stature of host-organ.)

In this way we come to see that, even in relation to the alleged rescue-operations of channeling, we haven’t succeeded in surpassing the original problem at all. We find there is no device to which we can have recourse, that serves as proof against the possibility of deception and illusion. We find once again that we are thrown back ultimately on our own resource, stuck after all with the responsibility of developing our own discriminative faculty, our own will, our own spiritual intelligence able to act as a gyroscopic monitor of information-signals. For it becomes inescapably evident that, regardless the subtlety of the originating plane or quality of the formal Ground, the voice of Self-serving can Speak from the Other Side with as great an ease as any other orientation, and indeed takes up Residency there with as

firm a sense of proprietary rights.

At this point we hear the common plaint: what about the “goodness” of the medium? Doesn’t the “right intention” and positive expectation of the *channeler* tend to ensure the benign intent of the Received Signal? Doesn’t the occult proposition pertaining to the law of the psychic plane wherein “like attracts like”, serve as sufficient safeguard so that we may resume our basic confidence in the integrity of the Higher Ground granted this one proviso of appropriate alignment?

Overlooking for now that this still leaves us with the petitio principii of having to *assume* just the egoic equanimity on the part of the channeler that’s as problematic as the question of any “guru’s” ego, and that in fact has yet to be proved, we should go to the central consideration in the whole question of

any invited intercourse between planes.

### The “Good” Ol’ Boys

Channeling is resorted to in the first place in order to *obtain* what one manifestly doesn’t have; and despite tangential issues, this means most critically certain *Values of Being*. Indeed, the device of “meditation” from which those values are traditionally thought to proceed, becomes the agency of acquiring *information* more colorfully descriptive of those values, in the context of channeling. The *operative* plane from which all of this takes place, is as a consequence maintained at the ordinary low level of mind-body integration characteristic of 3rd density consciousness as a whole. Indeed, the channeler takes pride in the preservation of just that humble “ordinariness”, displacing all claims to the extraordinary upon the received Source. In this way, we’re supposed to take comfort in the fact that the channeler lays claim to no *personal* merit in terms of Transformative Realization; he’s not purporting to be the source of such fascination but only the indifferent *medium*, thereby retaining his warmly assuring identity in ingratiating commonality with us.

This shouldn’t be a matter of such congratulatory assurance. The implicit confession is that the channeler, no matter how personally oriented to the “good” he may be (and *whatever* that may be in his terms) is functionally established at the same, essentially non-transformed level of mind-body harmony and integration characteristic of the mean average with which he takes such proud identity. He is, by inference, only as integrated and properly aligned with respect to the volitional axis, as everyone who goes to consult him.

His very *method* of “reception” may be traced back as an extension of the initial way in which the whole “foreign” theme of *meditation* first intersected the framework of the Western Psyche. A couple decades ago the debilitating tension of Western-technological living issued an implicit call to alternative “technologies” able to solve for that specific problem. And if we remember, it was the “Maharishi” style of “Transcendental Meditation” that answered to such a call. Thus we get our impression *to this day* as to what “meditation” amounts to, through the ripples issuing from impact of that first imported influence. All those subsequent, bandwagon techniques either borrowed or domestically developed took their acceptability—and measured their “correctness”—from that original template.

Meditation as understood in the *Initiated* Tradition is a technical means of augmenting a *general practice* of *spiritual orientation* and whole, mind-body intent whereby the subconscious systems are integrated with coordinate intensification along the conscious Axis to the degree of producing a *combustion* lighting the filament of that Volitional Line, and “turning on” the spirit-lamp of direct Awareness. The hallmark of such Meditation is a *poised, alert receptivity* that carries through all actions. Meditation as understood through

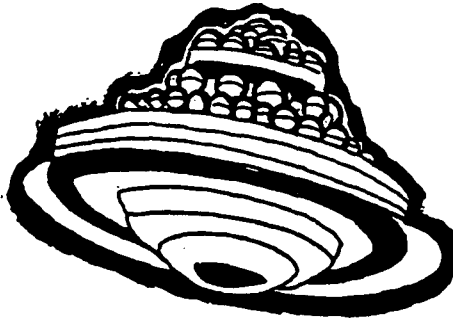

franchise-versions of the Maharishi-styled technique, is a means of rendering the mind-body system *passively* quiescent. It is relaxative, to be sure; and that answers adequately to what was, in the aggregate, a rather shallow "call".

Such a trance-like state of semi-drowsy *passivity*, however, has come to constitute the *standard* of all that we think of and accept as belonging to the subject of Meditation. Any number of such methods are bandied about on daytime talk shows, and consumer-consciousness now knows how to "count backward and lower yourself with eyes closed into the deep well of your inner self" as well as it knows how to measure out soapflakes in the washer-cup. (It is more than telling that the "Hilarion" material, in contradistinction to the overwhelming body of channeled material the sources of which specifically *abjure* giving technical instruction, blithely proffered just such a "countdown" method of meditation inducing the type of vulnerable contingency—and entranced passivity—optimum for establishing the invitational configuration of "horse and rider".)

The West has accepted the technology of meditation from its angle as a relaxative, and has exploited it extensively along such lines. In the process it's come to find out that such techniques can indeed induce a deeper state of "rest"; they are, on the pattern of the Maharishi-method, able to establish a kind of minimal, quasi-meditative harmony and integration at the *ordinary, low-level* of common functioning. This becomes the sum of what we tend to know or expect from the category of meditation. We tend to know nothing of a mind-body integration and harmony established at a *higher* functional level than that which characterizes the norm, in deeper congruence and alignment through the unitive value of the Conscious Axis itself.

### Leaky Submarine

With the subject of meditation as we've accepted it and tend to know it, there is no basic reorientation that would belie the *standard* orientation (in which the self-luminating "light" of the conscious axis is chronically displaced, through its divisive conceptual categories, as "focal reflection" scanning the nocturnal fields of subconscious identity-patterns and vital-survivalist imperatives). Rather, through the accepted, passivity-oriented meditative methods it's the *autonomic* system which is set in ascendancy as the result of effectual submission to the murmur of subconscious processes; the subsequent, diffused focus lowers the light of consciousness gently down to certain, subconscious depths so that those levels and spontaneous springs may be refreshed at the *expense* of the conscious or volitional system. Rather than *leaving* the subconscious processes to their uninterrupted business as in sleep, here those processes benefit from a slightly different order as consciousness slips silently into their field and "loans" them a certain value of implicit unity (borrowed from the conscious axis) which they may momentarily appropriate in more direct manner. Since however those subconscious processes are never by this means oriented and aligned *with respect to* the conscious channel and thus the awakened value of mind-body unity, they necessarily slip back from their "optimized" degree of meditative rest under strain of compulsive ego-resurgence, bounding back from the ordinary (non-transformed) level of habitual functioning.

It's as if, rather than the subconscious processes being intentionally turned in integrative amplification toward the spark of consciousness abiding in the "central channel", so as to kindle it with their combined energies of coaxial intensification to full flame, that conscious spark is instead lowered down into the well of those subcon-

scious processes themselves (in displacement from its central, axial locus) loaning them its integrative light to be used at their ordinary, low-level of interaction until it's altogether extinguished in the slumber of their depths. This has the effect of temporarily "unifying" the subconscious processes so as to make them a suitably receptive vehicle only *deprived of the spark of consciousness* belonging to their own central axis, putting them inferentially in a position prime for the structural invitation of a "Conscious Light" not part of the specific integrity of that axis but finding an adequately airtight vessel, accommodatingly empty of "driver"!

Thus the "goodness" of the personality is, at such a common level of mind-body integration, strictly subject to the specific tolerances of the axial harmony thus far established through the consciousness-systems. It is strictly a function of *egoic habit*, not the condition of a realized integral ground. The shallow state of mind-body integration from which the channel-mediator assumes the "appropriate" passivity to receive, functions through a volitional axis that is effectually *empty*, the value of consciousness-in-itself being chronically displaced into the subconscious habit-channels of the frontal or vagus-current. The "goodness" which may seem to formally extend the invitation is a shifting, unstable value based on egoic estimate rather than unitive congruence with the Divine Order; the real constant presiding over any such invitation is the effectual *emptiness* of the Conscious axis displaced into reflective, subconscious habit channels, that would otherwise serve as illuminated instrument of that Order. The response which is elicited from such a passively oriented invitation therefore answers to the real constant, the *actually* consistent factor presiding over the whole proposition. The real invitation doesn't issue from any well-meaning *attitude* based on personal self-estimate but from the operative emptiness of the (relatively unintegrated) axis of *will* implicitly requesting a replacement of volition from a Source superseding its own technical level.

Such assumed *passivity* as preparation for the receipt of an anticipated, Otherworldly Beneficence, thus amounts to an invitation for that empty volitional channel to be *filled*. This is, in fact, a very contingent and vulnerable orientation. Any Intelligence of high integration and proportionately powerful Will functioning through the deeper densities, *whether positive or negative*, is in perfect position to infuse that vacuum of the volitional axis without challenge. Nor is the common counsel (cited even by the "human" authors of the *Ra material*) to the effect that one can invoke the protection of the Positive God-light under such circumstances so as to ensure the alignment, any sufficient corrective in itself; for in order that such an invocation carry practical weight, it's necessary that there already be a sufficiency of corresponding substance in the channeler. The personality in question

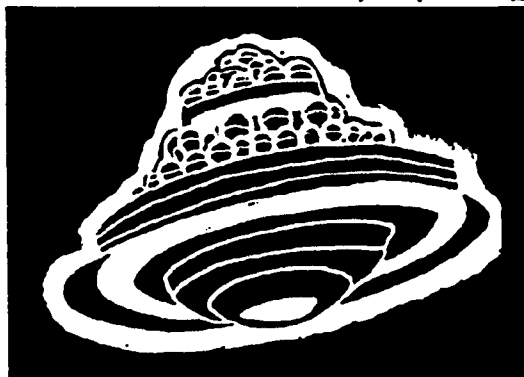

must already be substantially committed in positive integration and alignment *congruent with the value of Light called upon*, in order for that Call to have any basis for effective Response. Otherwise it's an empty invocation, and needn't have anything of automatic "expectancy" about it at all. Here we may note the Gospel account in which an Apostle, purporting to cast out a demon in the name of Christ, received the retort of that very demon: "Him I know; but who are you?"

This same basic passivity as the implicit orientation assumed in channeling, also accounts for those odd fluctuations in the quality and character of material coming from the same—ostensible—Source. It may well be that a channeler one day receives a truly positive communication, and the next a communiqué which though superficially similar is exposed to subtle detection as a specifically negative source. It's as if, in other words, the channeler had glided imperceptibly over

an invisible broadcast band, shifting from one station to another and never noticing the difference. ("Positive" sources do not, incidentally, interfere as a rule with this negative drift as they must honor the implications of free will in every case.)

Even more to the point in a certain sense, we must ask ourselves ultimately just Who is interested in establishing such Communications with us in the first place! Beyond even the valuation of Positive or Negative in relation to these sources, we ought to be asking the more central question as to what order of being, what class of intelligence or spiritual development seeks to respond to the inquiry of 3rd density consciousness through these specific means.

Here we may receive a surprise; for, even amongst those Sources which we can identify as safely "positive" in the sense that they communicate in conformance to the essential harmlessness of Cosmic Law, there is that formerly noted, by-now-notorious *lack of concord* as to the most basic tenets of certain foundational points. And it is in just this *lack of concord* that we may be able to discern the giveaway signature, the real hallmark that distinguishes the majority of "channeling" whether positive or negative.

### Let There Be Light Reading

Let us return to our original, inspirational guideline mandating us to perform that needed work of cross-correlation and comparative indexing of otherworld Sources: the "Christ" material of Virginia Essene and Ann Valentin. Here is a Source purporting to emanate from the very Personality of "Jesus" (not just Christ-consciousness in general); and an additional source of this channeling team identifies Itself as the "Gold and Silver Rays", represented as nothing less than the original creative powers of God with whom the Christ-personality is now in intimate association (these major Actors are accompanied by a lesser supporting cast, including "Sananda Lord of the Omniverse" humbly so-called, who—revealingly—is described as a kind of "cosmic coordinator" of UFO activity and communication; and an entity identifying Itself as the Archangel Uriel).

When we turn to such a Source to consult what It has to say regarding such important, foundational principles as the nature and genesis of the Creative Process, the population-origin of earth consciousness, the character of spiritual development and so forth we immediately encounter an interesting phenomenon. All consideration duly taken into account of the reasonable need to "tailor" such complex subjects for the general level of earth-consciousness, we still find a peculiar recitation of the Creative Process—for example—being advanced by no less than those Authors of All Creativity the Gold and Silver Rays Themselves. In most Grimm fashion they proceed to regale our apparently pitiable comprehension-level with the "information" as to how, prior to forming any other aspect of the cosmos they first fashioned an experimental globe out of their own complementary materials (as emanated from the obelisk-presence of the centrally situated Creator) to function as prototype of our very own Earth. This account of course has none of the actual sense of Creative Superfotation (of the profusion of simultaneous foci from which the multidimensional probability-patterns of the universes come endlessly cascading) described very nicely within the precisions of language-limitation in Book III of the *Ra material* or the first Book of *Seth*—or which is indeed accessible at any time to the Viewing of a consciousness appropriately integrated either with the 5th density of Creative expression or any adequate subreflection in "astral" or "etheric" terms etc.

In comparison to direct "yogic" observation, or the accounts cited above, the "Rays'" explanation has all the piecemeal ponderous quality of the ordinary focal *mind*, which is indeed the targeted recipient of such a recital without respect of any esoteric facts at all; such "teaching" operates out of a clear calculation aimed to ingratiate the lowest common denominator in the comprehension-range of that slow faculty.

Such a primitive, literal-Genesis model of the Creative Process

is reminiscent of another curious allegation found in the *Cosmic Revelation* book, i.e. that the type of exquisite interdependence characteristic of our planetary life is expression of some *unique design* involving free will and is *not* indicative of other planetary life in the galaxies (!). What can we make of such remarks? Other than resorting to the weak excuse that the "channelers" may be imperfectly interpreting the communicated impressions in oversimplified terms of their own cosmically-parochial psyches.... While this may be in certain instances, there's too consistent a thematic reinforcement throughout the material to allow us safely to ascribe the whole business to randomly-bad interpretation. There seems to be a concerted effort to impress us with the *special* quality, the wholly unique character of our situation as "caretaker"-denizens of C-ton (the cosmic name for Earth, we're helpfully informed) even to the degree that such patently fatuous statements court the danger of screening out any but the most gullible, unthinking or unreflective.

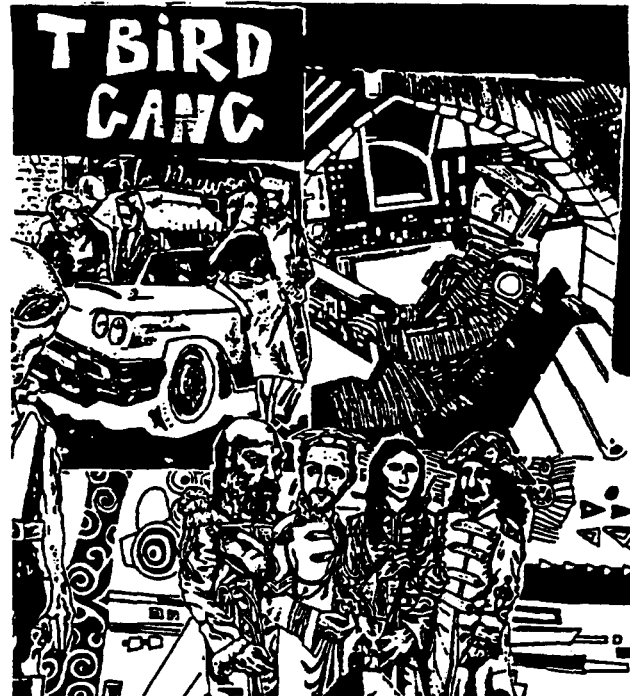

A case in point is their account of the original population-seeding of Earth, and the subsequent Fall precipitated by the Free Will-test furnished through the (negative) Black Ray influence. According to this account, some 8 million years ago a flotilla of luminant Souls already substantially awake in cosmic consciousness came to our newly-prepared Planet in the upright intent of fulfilling their Divine-contractual role as spiritual caretakers in the development of Earth (excuse me, C-ton). For a million years this atmospheric network or luminant aura of Souls kept in dutiful communication with their planetary and galactic home bases, hovering over and tending the unique life-forms of the planet as per telepathically-beamed instruction; then the *uninvited intrusion* of the Silver Rays bastard offspring the Black Ray, set up a negative vibratory pattern progressively subversive of the souls' recollected commitment. Gradually, so the account goes, the larger portion of souls failed the initial test of free will and fell into amnesic lapse with respect to their contractual duty, becoming so involved and progressively identified with the physical lifeforms ostensibly under their care that the Creative Powers had to assemble an emergency committee of cosmic engineers to construct the most ingenious "device" ever seen in the creations, i.e. the *human body*. Such a body was specially made to house the dimming Light of the soul so that It wouldn't be extinguished in forgetfulness altogether. Through the special device of

reincarnation the souls were supposed to progressively awaken to, and resume conscious participation in planning the fulfillment of, their original caretaker-contract.

Now, this may seem superficially similar to other accounts (the spurious "Hilarion" account, remember, indicated a similar Biblically-echoing saga of negative subversion and fall); the Pleiadeans in the Billy Meier material (edited by Col. Wendelle Stevens) claim to have seeded this planet originally with their own offspring so that "we" are their legitimate cosmic children. And the *Ra material* suggests that there was some initial, genetic intervention at the dawn of 3rd-density earth consciousness, the unanticipated negative repercussions of which originally inspired the institution of *quarantine* (see last month's issue) in order to prevent undue influence of *either* a "positive" or "negative" type. The Edgar Cayce material describes a progressive coinvolvement of migrating souls and the plastic matter of the earth-plane; and Ken Carey's *Bird Tribe* source similarly describes the creative "quickenings" of the otherwise inert material of earth through the increasing proximity of approaching Souls.

Yet the *Ra material*, proven in many other ways to be the most reliable single source of all, places initial planetary seeding at a distance of 75,000 years, not eight million (or seven million if we date from the "Rays" confection of the human physical vehicle). Taking the *Ra* source at Its Word that It isn't very good with dates, we may well suspect that—from Its oblique-channeling angle—It's perceiving the initial infusion of a *particular* life-wave of consciousness, not the "first". More importantly, *Ra* identifies the "seed" entities of 3rd stage planetary consciousness as originating primarily from a former *Martian* cycle of development that had failed satisfactory completion on its own ground; and this "strain" of transposed soul-seeds in any case followed the same line of *consciousness-unfoldment* and progressive development through the lower densities as the indigenous, 2nd-density entities promoted to comprise the other major portion of 3rd-stage soul-inhabitants 75,000 years ago.

In light of this last characterization, we may take a revealing second look at the "Rays" account of "how we came here", with its inference as to our mission, our duty and our destiny.

### Falling Apple, or Rising Seed?

According to the Essene "Rays" we come from a soul-group that doesn't *evolve* from the less-conscious densities, but which *falls* or *devolves* from the Higher Planes. The idea here isn't to *unfold* the latent seed-germ of a spiritual consciousness never previously flowered in our particular case, but to *recover* it from the consequences of an initial mistake. The obligation to *recover* a status of former Spiritual Glory imposes a mood which the prospect of *brand-new flowering* doesn't share. The first is a restatement of Biblical culpability.

There is however a consequent, internal contradiction of rather significant proportions embedded in the Essene material; for, if the object is to *recover* the knowledge and status of that spiritual glory existing *before* our Devolution had been mercifully straitjacketed by the physical body, then it would seem that the ascension in consciousness to those higher states of Being between incarnations would—in itself—fulfill the requirement, and would short-circuit any "return" to the physical as wholly unnecessary. Obviously, this isn't what They mean to imply; for it becomes increasingly evident from the reiterated signs of the material that the "Rays" intend us to fulfill the alleged initial contract entered upon in "full Consciousness" with the Divine, as caretakers of Earth, and this absolutely regardless whether we actually *recover* that Glory of Spiritual Awareness as unencumbered Souls.

Incidentally, the idea that we progressively evolve through the densities as consciousness-units is not equally subject to the charge of "internal contradiction" that characterizes the Essene-Rays account; the exposure of the progressive (or procedurally evolving) soul to relatively free inner states between incarnations is never held as

the Aim or exclusive Point. It's not a matter of some "old" consciousness reexperiencing its specific functional Identity so that it can simply walk away and resume it, like a recovered amnesiac going back to his "former life"; this is a Platonic misread of the afterlife interlude in which the Eternally-Awake Ground of Consciousness reexperiences Itself from the ever-living fount of a fresh perspective—such a fresh perspective does not then just step back into a ready-made role, but progressively develops the implications of that after-echoing Being through terms of its own unique patterns, seeking forms of integration and higher-level unities that did not, in that sense, ever exist as a flower of Soul-consciousness.

The value received through those intervals of discarnate exposure serves as purifying stimulus and Standard subliminally belonging to the soul-record, encouraging a practical intensification or dynamic integration on all levels in order to draw the ordinary incarnate locus of soul-consciousness into progressively-awakening congruence with that common Ground. The "object" here is not simply recovery from the makeshift expedient of a preventive or "prophylactic" physical form, but rather the thorough Awakening of all parallel, developmental levels of Consciousness inward or outward in whatever medium as a true Spiritual Increase, bringing the dimension of Divine Awareness to every seeking facet of the multidimensional being through all its respective Vehicles so as to impart to each of its planes a precious value or Absolute quality never previously experienced in integrative Unison.

It becomes increasingly evident, then, that this scenario of our seeding and fall as narrated by the "Rays" is not a reflection of the spiritual or physical facts, but a propaganda meant to instill a kind of "cosmic guilt", as it were, shaming us into fulfilling an alleged contract that we entered into in the irrevocable responsibility of "Full Soul-Consciousness". Indeed, so patent does this become that we can only marvel at the give-away desperation seated in the motive which causes Them, at one point, to make the astonishing pronouncement that—if this ostensible caretaker role is now fulfilled—they will generously waive all further reincarnational requirements!

"Incarnation" is a matter of Identity, and levels of specific functional identification; it is not, has never been nor can it be an arbitrary matter of fulfilling mechanical conditions. If the technical fulfillment of conditions is meant to promote the proper spirit of such identity-transformation, we must ask why the emphasis of the Essene material is never on Spiritual Awakening per se but "awakening" to a specific, caretaker role. Whose "garden", we must wonder, are we being coaxed, cajoled and wheedled into tending through acceptance of a cover-story purporting to explain "how we got here", and instilling the proper mixture of guilt and ego meant to motivate us into honoring what we're ostensibly supposed to be "doing here". (The "guilt" comes from our alleged culpability—acquired through the accountability of full consciousness—for the Fall; the "ego" comes through constant encouragement for us to see ourselves as caretakers of a planet unique in all creation, special beyond all others in design and destiny). Far from any acknowledgment that the patterns of creation are supplied primarily as the occasion of our awakening, the "Christ" entity and Rays would have us subscribe to a reverse standard in which consciousness takes form in order to be the caretaker of creation. In light of this explanation, the world is not the parturitive medium of Consciousness but rather consciousness is the vehicle for the husbandry of the world.

This promoted viewpoint just may have something to do with a constantly reiterated theme of the material, i.e. that the present orientation of earth consciousness poses an immediate threat to galactic and planetary neighbors travelling the invisible etheric pathways, due to our misuse of atomic weaponry and secret forms of "scalar" mayhem (that undo not only the delicate fabric of subatomic space, but the universal Ether that comprises the short-cut "tesseract" for commuting space vehicles.) All of this may serve to account for why the actual teaching of the Christic "World Teacher"



is uncharacteristically short on the spiritual education of consciousness, and dogmatically long on warnings and instruction with regard to the proper care and feeding of atomic materials. After all, as we learned in the last issue, the atomic and subtending etheric fields of which this physical density is particularly rich comprise the nutritive energy-medium of a number of systems that "feed into" it from other levels and densities. It has been noted by several commentators, including Wilhelm Reich, that many "saucers" come within our boundaries to feed on the energy-rich atmosphere and physical resources furnished by this precious sphere.

May we not see then a lurking "identity" behind these cosmic masks more congruent with the actual character of the material, rather than the purported character of the entities?

### With Friends Like These...

When the "Christ", the "Gold and Silver Rays" et al. inform us that they will only extend these warnings to us for a limited period because they have other places in the cosmos they need to attend to as well, they not only undercut the "special" character of our own focal zone but inferentially describe a mode of existence that is peculiar to say the least for a pair of All-Creative Principles (but not at all peculiar for saucer-saddled entities who do move in just this manner from one galactic point to another). When the "Christ" describes His relation to the great God-lozenge of central Creative Power (taking up a very localized residency at a particular galactic point) as that of being able to closely approach but not fully enter Its hyper-intense field, we do not find ourselves in the presence of a description that originates from the 5th density of Creative Mind, specifically cited—by Ra—as the platform from which the actual Jesus-entity would channel; rather, we find ourselves contemplating a description that succinctly characterizes the reality of 4th density space/time UFO entities for whom the Creative God-power seems to intersect as an emanative Node into the astro-physical field at specific, localizable junctures in the form of a Dome or Obelisk, a Door or luminant Lozenge, and who—as in the Andreasson report cited last issue—are able to approach that obtrusive Point but are unable to bear Its intensity in exact alignment with It. Couple to this the fact that "Sananda, Lord of the Omniverse" is characterized as UFO/space-entity coordinator (amongst other heady aspects of His job-description) and we have completed our fill-in-the-hidden-numbers portrait that exposes the actual identity of the beings beaming in behind the masks of "Christ" and the "Rays", etc.

There is no "malevolent" intent here. These are "positive" entities. But there is deception. This circumstance exists as an anomaly to us due to our misperception of what it means to be a "positive entity". Positive entities so polarized at 4th density level and higher, are "positive" by virtue of their decision to adhere to Cosmic Law, to subscribe to peaceful and cooperative means. They're not "positive" in the sense that they exist to impartially help us and promote our spiritual awakening. They have taken specific, characteristic paths in space/time with very distinct destinies, and though they exist in social/memory/complex harmony with one another their sheer, incarnative situationality imposes conditions that describe the priorities of their own particular group. Thus their subterfuge "message" to us, assumed under the guise of the Teacher most revered and sacrosanct on this planet and thus most likely to be listened to, is "benign" in the sense that it encourages our very necessary care of the planet; but it is not a message that conveys a real teaching, of maximum benefit to our own spiritual development in line with our unique destiny and

collective Path. It is a message which, while promoting the positive values of our planetary husbandry is still basically self-referred, for it's meant primarily to goad and shame us into maintaining—or prolonging the life of—a sphere which functions as a cosmic filling-station for them. They are interested in the preservation of the connecting spacelanes of the interstitial ethers; they are not interested per se in our spiritual development, which is why they're perfectly content to paint us a picture of spiritual accomplishment consonant with our roles as glorified gardeners for "their" satellite Resource.

Can "positive" entities out-and-out lie like that? Yes they can. And do. We do not see reality directly as a Pirandello dance of mutually reflecting, coinhering and magically counterchanging identities. They do. Thus there is little wrong, as far as they are concerned, with the assumption of any identity as manifestly provisional as their own.

Indeed the phenomenon of channeling altogether is most susceptible to the blandishments of "positive" and "negative" beings of the space/time densities neither of which are, by constitution, of optimum spiritual benefit to us. After all, didn't we note last month how curious it is that meditation, ostensibly a direct vehicle of our personal awakening and intuitive alignment with the Fountainhead of Gnosis, seems to be so neatly co-opted by the distractive offshoot of "channeling", which substitutes a verbal description or message of further encouragement for us to assume the inert horizontality that passes modernly for the "meditative" mode? Understanding this, isn't it wiser to forgo the passive (and thus "easy") path of turning our spiritual development over to another entertainment program, and recover instead the original sense of meditation as a direct spiritual empowerment that adroitly bypasses every intermediate voice of every intervening plane that would turn us into a satellite-functionary of its own "cosmic trip"?

Each plane, sphere and density is furnished the indigenous spiritual teachers and teachings appropriate to it; and despite our recent "disenchantment" with the idea of living teachers, only such teachers are valuable to us as they share the same physical consequence and destiny as ours so that

they may uniquely participate in as well as know our real requirements, while at the same time embodying and practically directing the optimum Spiritual Value for the fulfillment of our unique destiny.

The "positive" beings of the channel-frequencies, then, are of two types:

Time/space entities of "disembodied" status, flush with "helpful" ego eager to impart what's only being learned within the insulated framework of afterlife rest and review, and who are thus limited by the special, subjectively-reflective requirements of the framework. Any such entity is confined to the bubble-like protection and internal, "angelically" harmonious support that thoroughly screens the soul's vulnerable status from that unfair advantage belonging to the aggressive deception of the "dark teaching", (and for whom therefore the "negative" as a practical fact does not exist except in the learning situation where it may be identified at its origin as an internal potential and projection). Such an entity is not balanced with respect to the Whole and the complementary systems of learning-organization; it is preponderantly influenced by the hermeticism of its own present schooling, and is therefore minimally helpful. All such "disembodied" entities need to appropriate the "fleshy" vocal cords of the channeler.

These entities are not the same as Inner Plane Masters; the latter in fact proceed from levels of time/space organization also, and therefore require no space/time vehicle as do communicating UFO



entities. But Inner Plane Masters are not confined to the "contents of the classroom" as are the eager, between-life soul entities. They are more like the schoolmasters Who walk those time/space halls, not restricted to the curriculum taught in any of the quarters but bringing the whole experience of the World to those cloistered seats of learning. Inner Plane Masters do not need to borrow the physical vocal cords, and do not in fact enter into relation with incarnate beings through the mode of channeling at all. They respond only to the overall development, balance, intensity and will of a real spiritual aspirant who has achieved a very formal threshold of readiness (a threshold that cannot simply be "claimed" as index of the ego's desire). The Inner Plane Master communicates to the nervous systems of the ready aspirant in a kind of energy-embrace and harmony, but does not communicate through those systems in the sense of appropriating or commandeering them. The Inner Plane Master, where the potentials of soul and circumstance warrant and allow for it, always inclines the aspirant in the direction of the embodied spiritual teacher Who completes the Spiritual circuit for the student (always leaving the identification of that living teacher entirely up to the discernment of the student).

The other kind of "positive" channel-entity, is the space/time UFO being. We have already learned the limits to which any such being, situationally aligned with its specific destiny, can be helpful. That we ought not to be so eager to channel such beings, doesn't mean we're not approaching inevitable interaction with them. Indeed we will enter into formal relations with them as a planetary soul-group when that potential is ripe. But our relation to them should be that of peers, establishing cosmic bonds in terms of treaty and accord as with the relations of countries operating in the harmony of mutual respect. We should not allow the tendencies that arise in the current (aggravated) state of manifest imbalance between our respective levels to encourage a relation of "benign colonialism", as is happening at present. In order to prevent this, we must restore the idea of meditation as handmaiden of our direct, unmediated development, allowing those values natural to our own Being and destiny to flower in the form of faculties radiating a self-evident sufficiency affording

no uncertain notice of our spiritual autonomy, to be respected on the instant by all beings of good will.

If one is yet enamored of the idea of "channeling", one should heed the advice of the best of the channeled sources, i.e. the Ra material, and follow the method of Elkins et al. in resorting to the balancing correctives of group activity properly insulated and prepared.

### "Alien Nation" Is Alienation Without the Intervening Space

Oh yes: there is the recent disclosure, through material such as that of Whitley Strieber (Majestic), Bill Cooper, the allegations of John Lear, etc. that the government has been interacting with and even doing the bidding of (largely negative) UFOs since 1947. While initiated understanding confirms that there is validity in this business of "Roswell" and "MJ-12", it is important to note that, regardless the objective facts which you'll progressively learn in the revelation of the '90s, one of the tactics of the Negative Beings is to propagate, expand and exaggerate the magnitude, the possible horror, and the despair of such information-content so as to deflect the orientation of personal power and render a collective sense of hopelessness, of powerless passivity and ineffectuality before the monolithic monstrosities of the "hidden government" and the experimental labs on the "dark side of the moon". Such an induced sense of helplessness, remember, moves us toward modes of meditative passivity from which we hope to elicit the compensatory Authority of a substitute self-power "beyond" us; and it adversely affects the immunology system making us even more subject to the toxic depredations of our gross ecological mismanagement, and thus weak beyond resistance to any wholesale negative invasion that could be marshaled against us. People such as Bill Cooper who, unlike Strieber, understand and rightly warn against the negativity of the government-alien interaction, may be "modern-day Paul Reveres"; but our powerlessness in the face of all this is not the message. The even-more-intensified mandate for our Spiritual Awakening and renewal, most certainly is.

NEW AGE • HEALTH • AVANT GARDE • CONSCIOUSNESS EXPANSION • SPACE AGE

**HAPPY THANKSGIVING! WELCOME TO THE NEW WORLD!**  
 Come see rare appearance of publisher-writer-artist of *The New Thunderbird Chronicle*, MT, at Whole Life Expo on Friday, November 17, 3:00 P.M. in room 208. You're in for a surprise!



# Précis on the Good, the Bad and What Curls Up Under a Rock

BY  
MICHAEL TOPPER



by MT

In the old Saturday matinee serials, rather extensive synopses were furnished at intervals where the chapters built up to quite lengthy continuities; it seems only appropriate at this point to furnish some such synopsis for the readers of the *T-Bird Meets the Phoenix* episodes, since our "plot" is by now not only strewn over several consecutive issues of the piece in question, but is implicitly contained as well in some of the earlier and separate features of the *T-Bird* enjoying no such specific continuity with our present article but nonetheless bearing deep relevance to its contents.

We begin our synopsis, then, with a time period and cast of characters outlined not in the *T-Bird/Phoenix* articles first of all, but in our May 1990 issue featuring *What Is The Mother Current?*

In late '79/early '80 (you'll recall?-) MT and AAA along with their two children were summarily sequestered in an apartment of ghetto-like districting in La Mesa, California, backed into the proverbial corner by clear communications of the transdimensional type that a hasty hermitage of the least maintenance-obligations would have to be extemporized, jobs abandoned, transportation sold for scrap and the best made of an impossible situation while an impending Process of indeterminate spiritual magnitude readied itself to take root—primarily in the person of AAA as its exponent and ultimate incarnation.

The first half of their spiritual odyssey together, from the early years of the '70s to this present moment circa Christmas '79, had been characterized by the usual type of seeking and series of practices known to the majority, at least in terms of general orientation; the first half of their developmental saga was conducted as a deliberate Search, an effort of personal will deriving benefits and spiritual "emoluments" in proportion as that will was applied. It consisted of standard kinds of spiritual/metaphysical practices and their variations, and even though such work precipitated the relatively uncommon climax of securing communication with and tutelage through an "inner plane Master", the overall orientation remained the commonly identifiable one of personal effort, continuous practice of the leads provided and "psychic" cues given—all in upwardly-aspiring orientation toward the "positive" or "heavenly" polarity of the mind/body complex physically paralleled by the internal cephalic mid-point of the third eye, and the "subtle region" situated analogically through the space above the head.

This standard type of practice, (most recognizable to people when speaking of spiritual search or metaphysical discipline) eventually reached a saturation-point at which a peaceful *quiescence*, a kind of pleasant if pregnant *suspension* installed itself. After the often turbulent character of pursuing the spiritual Gold Ring, a tumultuous and even magical odyssey that nonetheless saw AAA and MT split apart and reteamd more than once, a sense of unmistakable *transiition* was jointly reached. Without any fanfare at all, with no portents, cues or guidelines from an "inner plane Master" or from one of the several "external" adepts to whom they'd had limited recourse, they nonetheless plainly knew that a *junction* of some fateful type was upon them. Everything seemed to stop; the "time" in which everyone unconsciously hurried seemed sweetly to end, all drives and irresolvable tensions looked to give up the ghost without requiring the denouement they'd appeared to demand.

At this halcyon point, the only "point" in the framework of existence that could with real validity be termed "contentment", (in reconciliation with life, the world, one another, and all friends or acquaintances who in this *very, brief interval of time* seemed mysteriously to show up, reconvening as if for a summary/ensemble Act of existence from the far corners where in the meanwhile they'd been distributed) there was nothing to want, nothing to strive for, no point in striving, no percentage in questioning so that both AAA and MT were perfectly willing to live out the remainder of their lives in quiet attendance of the natural matters of daily life. For that one moment in the *mutuality* of their lives, there came a true surcease; yet, as has been characterized, that surcease had the value of a *suspension*, a long deep pause—a rapt cessation of the breath at Infinity. Like all pauses, like all extremes in the oscillating balance of a pendulum motion, the resultant interregnum of Infinity is...shortlived. Deep and absolute as it may be, it is a nanosecond of history—and presently there is an unmistakable sense of wheels starting up, ratchets and tie-rods being geared into motion and all the cylinders once again engaged only this time with a net thrust proceeding from some *other* and unfamiliar angle, a kind of higher-dimensional *octave* over the usual sense of precipitating impulse.

A preemptive *communication* arises, an abrupt Intelligence blown in from the lovely suspended Vacuum of Infinity so that where, but a moment before, there presided a peaceful Void without content

or specific *intent*, that very Void discloses itself as the enabling occasion or specific medium through which comes barreling the cosmic Train of a *suprapersonal* Intent—a fulsome Wisdom-power infilling and thus wholly accounting for it, as the Charleston Express accounts for the existence of the Charleston Tunnel.

### Lateo Dei gratia

Such communication rushed in swiftly, and caught them up in an instant; it was not a communication originating from any being or complex of beings, no off-planet saucer-sendings or broadcasts from the "spacebrothers" etc. AAA, as the principal recipient of such communication identified it immediately as the cosmos itself, the creative totality or Logioic intent without mediating vehicle or vocal-box agency; yet its communication was as distinct and compellingly powerful as the stormwarnings of a lowering Sky: get indoors, nail everything down, cover up the windows, dig in and get ready for a hard-buffed stay of indeterminate duration.

So it was, with a preemptive Onrush that left no room for anything but swift economical preparation (in the same way that one doesn't waste time in the face of, or argue with, the onslaught of a tornado), AAA and MT dropped virtually all connection with the workaday world that comprises everyone else's most *vital* life-support system; and with the requirements of rent, food and utilities like everyone else along with the continuing responsibility of two children, they surrendered all such requirements to the care of that very Imperative now demanding so much from them.

Without transportation, located a block and a half away from the relevant school and a couple walking miles to a shopping center, a few intermittent external sources serving to supply ad hoc (last-minute) rent saves, phone taken right out of the wall, AAA and MT were then left in an upstairs apartment of La Mesa with poor ventilation, no airconditioner and temperatures which (even *apart* from heat convection) routinely hit 115 degrees in the summer and seldom got below 95 degrees, even in the winter. And it was there that they were reduced to ash, the internal Fire of the Process in its fullness first of all searing into AAA through the *soles of her feet*, (the exclusive entranceway of the absolute creative Divine itself, cf. confirmation of this exceptional fact in the *Ra* material) and distributing itself as an implacable, transformative Heat meeting and even *overwhelming* the exterior swelter that oppressed their bodily being on a continuous basis.

Thus for three years there would surge in and out a varying intensity of tidal energies, Intelligently conducting the *thorough mind/body transformations* that effectually took the subject of spiritual development beyond the conventional arena of personal aspiration, and the effort of individuated will. This second great phase of their spiritual development complemented and completed the first, in the sense that their first phase of upward aspiration saw done everything which could possibly be done by the ordinary means of "private effort". Now, in response primarily to AAA's unsurpassed desire for the Truth that would redeem humanity's heart, the transformative fire of the Creative-divine Itself *bridged* the humanly-unbridgeable gap of suspension by passing "down" to meet and match that solitary flame of undissuadable love.

At the high tide of that cosmic surge, either AAA or MT or both would be taken by the absolute degree of her creative Wave working all the transformations suitable to their respective systems.

### When Christmas Is Really X-mas

For hours, even days at a time, one or both of them would be charged with the intelligent energy of a Process so intense and uncompromised that the walls would palpably crack, electrical equipment would fail or fuse, and the *body* playing host to that primary degree of Intensity would rigidify to a fine prolonged *tetany*, a perfect paralysis where *consciousness* remained and indeed magnified, but through eyes that wouldn't—couldn't—move.

MT would watch—often in dismay, and in basic incomprehension that would only dissolve in time—as AAA was suddenly reduced from normal animated vigor to virtual catatonia, seeming to enter a near-death state leaving her body even afterwards so weak as to be immobile, and lips so parched that only moisture imparted through a sponge could afford the most meager relief. Again, there were intervals in these high-intensity tides that her body would seem to be seized by impossible—but quite beautiful and harmonious—undulations, swelling, contracting, distorting the length of her torso, through arms, legs, feet and hands, changing her features with subtle dream-like shifts all the while her eyes burned bright, fixed in fierce focus upon Infinity.

As a veritable byproduct of such inpouring Grace, MT would occasionally be struck by just a wave of overspill sufficient to halt what he may have been trying to minister in the way of help, persuading a lockin half-lotus right on the couch and the riveting of attention to a point ahead, e.g. the lightswitch or nailhole in the wall—one particularly eventful early-morning vigil, upon the starry reflection in the silver of a Christmas tree ornament...

Alert with moveless posture in the livingroom (while some monumentally-more complete Power of the process surged in renovative tide of Cosmic change through AAA in the sanctuary of a prepared "temple" down the hall), intent without distraction on the Yuletide morningstar levitated, just at eyelevel, through dense suspension of an awareness abruptly *coextensive* with the space in which all formal objects floated, MT would be palpably *emptied* of any sense of the compressive "centrism" regularly committing the ordinary force of identification to the contrastive coordinates and proprioceptive cues of an enclosed consciousness; and, aligned along the arrow of this latter-day "Bo", attentively congruent with the trunk of that meditative world-tree hung with stars, MT felt a definitive falling-away as if the floor was dropped from the sensibly-stabilized universe, supportive slats of frontal focus removed from the peripheral wings-of-vision like the walls of the proverbial magician's box torn away to reveal a *vanished* content, where but a moment before the charming assistant should have been coiled with blades fixed front and back...voilà! the mystic trick accomplished, the perennially coveted *object* of all spiritual aspiration as some incidental *byproduct* of what was taking place through AAA in the "other" room!—complete subject-dematerialization with Naught remaining as the leftover signature of Presence save the Cheshire smile of Consciousness.

### Over the Rainbow-bridge

All these occurrences, taking place off and on for a period of three and a half years—most intensely experienced the first six months of the process, in intervals scarcely allowing for a breath—though certainly rare enough in terms of the reported range of



experience for this "sphere" were still *identifiable*; they could be located with respect to a real spiritual heritage, and while not easily paralleled in handy reference guides they were nonetheless compatible—if research enough was done—with things previously reported from Jayrambati or Dakshineswar, the annals of alchemical recordkeeping in some Persian chancery or even the occasional embarrassment of quite Western "Christian mysticism" etc.; yet from time to time, these marginally identifiable processes were punctuated by quite discontinuous events, seemingly without preface or afterword yet very emphatic and "consistent" after their own fashion, within the range of comparative internal contents.

At times such events would distinguish themselves from the ordinary material of dreams by erupting quite vividly as carryover into waking consciousness—indeed often providing one of those crucial overlapping bridges which *functionally* served to weld the "two" realms into a seamless continuum; alternatively, they would arise right in the state of waking consciousness, generally in one of two ways: either as distinct Knowledge drawn directly from—what has to be called—Whole-being intuition, a sudden unimpeachable *insight* into certain ineffable truths and/or domains unaccompanied by any representative impression, sense-product etc.; or, as the expression of a peremptory "plunge" through magnified instruments of some fuel-injected psychism *strongly* accompanied by impression, subtle sense- data or perceptual intersection augmenting the same intuitive process.

So it was that AAA, MT or sometimes even both-at-once, were drawn through the dream-field or straight out of the body of waking life into realms never before seen, in conjunction with dimensions never before known to exist. They were "shown" by an overarching Guidance, ushered by an invisible hand into doorways damped to ordinary sight yet situated right in the midst of the "ordinary", taken-for-granted world; strange landscapes of heretofore-unknown worlds were shown them in aerial oversweep, or inescapable *impressions* of such presences and such worlds were alternatively drawn into congruence with the normally-opaque physical field (thereby magically violating the local rule of thumb regarding the mutual exclusivity of separate objects with respect to the "same" space). They were temporarily heliported at times through the *lingasarira* (for the Theosophically-hip) or astral body, set down into unmistakable if brief copresence with beings, creatures, intelligences and situations sharing very little reference with what they "knew" or understood in terms of their conventional learning.

#### A Word from Our Sponsor

They found that they were either *in*, or intuitively aligned with, other inhabitable worlds, indeed conjunct with experiences belonging to whole other *densities* and *dimensions* of being (which however yielded to corresponding mind/body adjustments and intensified alignments undergone, first-of-all, as prerequisite qualification).

It was as if, *since* the higher-dimensional potential of these mind/body magazines had been developed they were *going to be used*.

Part of the functional *benefit* of such renovated alignments and bioelectric balances was immediately understood, by both AAA and MT, as the intuitive ability to *recognize* the origin and nature of the "guidance system" periodically interposing its special circumstances: they became immediately aware at the very onset of such phenomena that the Guide of these spirit-domains was neither "inner plane Master" or UFO occupant, neither member of "spiritual hierarchy" dark or light nor emissary of "angelic" realms, but was rather their *own higher Spirit-consciousness*, the Source-value common to everyone, shared uniformly with all of humanity but only known directly and specifically identified in its quickened Guidance by com-

paratively rare processes of higher-dimensional adjustment. The Charioteer at the reins of the mind/body Chariot in this case was the whole-being value of Consciousness haloed over the "heads" of one and all, variably close to, and drawn into conjunction with, the cerebrospinal extent of the individuated-incarnate axis according to the specific *degree of compatibility* between the framework of physically-focused ego organization, and that unqualified Canopy of star-reate luminance Itself.

So it was Bearded Macroprosopus, the Person of the Supernal Triad took them up or "turned them on" occasionally at these unannounced intervals, and furnished such unexplained exposures to various kinds of "being" and "event"—which, on the aggregate, *always* took on a very specific and identifiable *feeling-tone*: i.e. such places and entities seemed either distinctly "positive", or distinctly "negative"; through the electrification of the necessary, higher dimensional faculties these apparently random and heterogenous experiences sorted themselves into things that were "all right" or congruent with whole-being (soul) value, and those which were distinctly not.

#### ...And the Positive/Negative Realms Beyond This World

For some, of course, hearing of this higher-dimensional either/or outcome there may be lingering doubts as to whether the participants were truly able to dissociate their third-density, lower terrestrial faculties of discriminative dualism from the integral domains of astral, mental and soul bodies involved in such "information-gathering". To this query one can really only rejoin "you have to be there" (an opportunity made good in the offing since the *T-Bird* began the presentation of taped lessons, direct Initiations into the Mother-current etc.); yet some provisional assurance can be advanced in the explanation that *whole philosophical universes* of insight and understanding were also to accompany these experiential passes or intuitive glimpses, which in the unexpected richness of their development furnished clear reasoning as to why the progression toward higher and more unitive densities of consciousness beyond the third necessarily involved a more unified/undiluted commitment to *either* an orientation identifiable as clear *positivity*, or clear *negativity*.

## PART I

### Précis on the Good, the Bad and What Curls Up Under a Rock

"I have a problem with this positive/negative business, Michael", Colonel Stevens was to remark as the subject veered toward that inevitable pass (cf. our interview with Wendelle Stevens begun in issue 3, Vol. 2 *TNTC*). "It seems to me that the subject bogs down at this point in just the kind of ambiguous 'moralism' that characterizes standard religious attitude on the subject, and which therefore inevitably leads to types of intolerances-of-interpretation that brook no opposition—you know?"<sup>1</sup>

"Well," MT said, "it certainly *can* if there's a component of self-righteous identification involved; that however is precisely why true spiritual development in the esoteric sense of higher mind/body integration and alignment is absolutely *necessary* to a balanced un-

<sup>1</sup> The following is an expanded version of a much briefer conversation actually held with Col. Stevens, who suggested during the course of the conversation that the explanations given him re Positive and Negative beings, spiritual development etc. ought to be written and published in detail since to him it clarified the subject more deeply than anything he'd heard previously. The conversational format has therefore been retained, as it loans itself to the kinds of comprehension drawn out through dialog.

derstanding of these things, and why it can't be left in the hands of standard low-level ego consciousness now backed by 'godly' justifications—certainly, that just leads to the Inquisition."

"Right! I've heard the more 'new age' attempts to explain the distinction, you know, like 'service-to-self' and 'service-to-others'; those categories are even supposed to be given by higher-dimensional beings for our further clarification, but it seems to me it just replaces one dualistic formula with an equivalent that begs the question rather than answers it!"

"Of course you have a point insofar as 'self' and 'others' aren't absolute categories; I've had early difficulty off-and-on myself in accepting them as adequate explanatory tools. But I think it's simply resolved if we accept them not as absolute but as 'rough-and-ready' categories; certainly the 'dividing'-line between self and other is ambiguous and shifting, more a function of the elastic flow of Identity than rigid real borders.

"But when you think of it, the categories retain their *functional* validity. For instance, when we think of what might be required to authenticate a 'service-to-self' orientation, we see that an easy means of accepting the distinction revolves around the *degree* to which any given psyche is willing to attain its end by *any* means; in practical fact, it takes a very distinct type to persist in the pursuit of its self-aggrandizing object regardless what must be raped, plundered, pillaged and destroyed in the process."

"I see what you mean."

"When we get to the higher-dimensional levels of distinct polarization, that kind of no-quarter commitment to the survivalist and self-aggrandizing end simply receives the imprimatur of fully-conscious dedication. It becomes an authentic ongoing decision, rather than inclination or tendency. In its own way it requires as much single-minded devotion, strict relentless dedication and unwavering commitment as does any positive counterpart committed to *mutual* progress, and it entails the same ultimate degree of mind/body coherence, ego-integration and coordinate alignment of each part with every other part resulting in a kind of similar, cerebrospinal *homogeneity*; and that congruence, internal consonance or aware self-agreement commands the same automatic alignment with the accelerated resources of Intelligent Infinity as is granted the resultant 'structure' of positive-polarization. The only critical difference that we've determined by experience, is that the *negative* polarization to higher-density alignment divorces itself, necessarily, from the Oversoul totality ultimately superintending all personality-projections and incarnative phases through the levels and dimensions."

"What *does* the negative polarity align with, then, in terms of Intelligent Infinity?" Colonel Stevens asked, clearly readjusted and gathered up in the explanation.

"It polarizes into basic congruence with the higher-dimensional *energy-fields*, through which the *programming* of Intelligent Infinity flows but no longer—in the negative case—through which the Self-reflective intelligence of Oversoul-consciousness directly functions and communicates. The higher-density *energy field* is open to entrance, then, as a result of congruent polarization, constituting a kind of 'indifferent' matrix of potential that may be used, incorporated and exploited according to 'personal' ingenuity; *practically* speaking, the soul which has newly polarized negatively finds itself in functional subordination to a deeply individuated ego-soul Intelligence of even *higher-density* development, having in effect *substituted* itself for multidimensional Oversoul Intelligence as inevitable consequence of the *isolating* or self-nucleating requirement of the Negative realm.

"It is this *surrogate* oversoul quality, in fact, which the newly-polarized negative being is implicitly moving toward; for *all* such negatively-polarized beings are ultimately attempting to substitute themselves for God, to wholly replace and in effect override the all-accommodating Individuality of Oversoul consciousness harmoniously coordinating all its projective components and angular

'selves'. Owing to progressive learning and development through the higher-density energy fields, and in 'tutelage' from higher-density Negative overlords, the Negatively-polarized being in fact picks up many faculties, manages to solve many of the mechanical knots making certain superpowers and extraordinary forces directly available in amplification of the overall repertoire; over 'time' in terms of the densities of negative development, the astute negative being manages to commandeer a range of multidimensional abilities that seems superficially the 'rival' of that belonging to Oversoul consciousness on the corresponding, positive side of the ledger.

"Of course the deeply independent and self-isolating ego nucleation which serves to practically *organize* the negative mind/body/spirit alignment, sets a real upper limit to the total range and power at the negatives' disposal. There is an inbuilt factor of attrition resulting from inevitable ego-friction, and a net value of continuous *inaction* or unrecoverable energy-loss due to imperfect assimilation at the higher levels, which prevents attainment of the true magnitude of Oversoul consciousness and keeps it at a merely imitative, proximal level; for there's an innate *contradiction* between the unitive values and deeply integral states of the higher-dimensional energy domains, and the supernumerary *encysting* of self-isolated ego consciousness marking the minimum requirement of that class of polarization.

"Such a basic contradiction *can't* be reconciled within the negative framework; it's for this reason that sources such as the *Ra* material rightly affirm that at a certain 'degree' the only chance of real progression in the resolution of conscious Being lies in the wisdom-conversion of the negative being to *positive* polarization alignment."

"How 'far' then can the 'negative' being ultimately advance?"

"Since it can never attain to real Oversoul congruity under negatively-aligned stress, the negative-density progress necessarily stops at mid-6th density, just before the dividing line of real resolution with oversoul consciousness (presiding as the Macroprosopus or Higher Countenance of 6th density)."

"So the 'negative' beings can decide to switch polarities? What happens when that decision is made?"

"Theoretically such a decision can be made by any negative entity at any degree of development of the higher densities. As a practical matter though, it isn't likely to be a seriously-entertained option until the perceivable limits of the higher-density levels are met in *experience* and understood on an immediate basis. Also on a practical level, such a 'choice' is—while an expression of the conserved value of *volition* and therefore of innate *freedom*—not bilaterally free to implement itself any time; the negative realms are highly regimented, monitored, jealously guarded since their conscious 'resources' are scarcer in terms of competition with the positive, so 'defection' at the level of the subaltern ranks is not viewed indifferently. It's a punishable offense; therefore on a purely practical basis such a choice generally can't be made and *implemented* except by a whole *group psyche*, a social/memory/complex of the negative densities taking its point of leverage from the decision of its very *Commander*. Therefore such polarization-switch is *not*, for both reasons cited, a common occurrence and seldom takes place sooner than the approach of mid-6th density."

"And then what happens?" the Colonel asked. "Do the 'reformed' negatives have to incarnate in the lower dimensions again and pay for all the karma they've incurred before they can move up once more on the positive side of the ladder?"

"Actually not—or they'd never make the decision to polarize positively! No, the polarization, once assumed, is virtually instantaneous and involves a direct exchange for its equivalent on the 'positive' side of the ledger. It's the product of cumulative *wisdom*, in keeping with the general 6th density level, so it understands the sort of yielding that's required and performs it."

"Oh oh. That's not going to sit well with those who're bound

to feel—me, for one—that all the negative suffering such beings have inflicted doesn't have to be *paid back!*"

"Oh but it does, Mr. Stevens," AAA explained. "It's paid back through the works that are performed once in higher-density positive alignment. And they are able to be paid off more effectively because of the superior powers at their disposal on the 'positive' or whole-being side."

"Yet they don't seem to have to 'pay back' in terms of 'their' own suffering—maybe that's just a punitive thought generated from this eye-for-an-eye level of consciousness however, a kind of Judeo-Christian hangover that isn't relevant in the higher planes..."

"In a sense that's true," AAA continued. "At the same time though, you have to understand that the matter of 'karma' is basically different at the higher-density levels beyond 3rd. 'Karma' is indeed instantaneous in higher-dimensional terms—not so much in the sense of the mirroring mechanics of *experience*, as in the *essence* that's ultimately relevant as a conscious value.

"You know we think of 'karma', in this plane of focus, as suffering the identical *experience* that we inflicted on another. But the 'object' of any such experiential pendulum is always the *impression it makes on consciousness* in any case. The only reason it takes the form of *experiential* kick-back in our 3rd density frame of reference is because here, consciousness is largely *asleep*. It can't experience the *essence* of a thing, the distilled *value*, directly; so it has to be 'shocked' out of its slumber by some mirroring mechanism of experience.

"In the higher, unveiled levels or densities, however, consciousness *isn't asleep*, neither in the positive or negative realms. Therefore the *negative choice* of alignment itself *is its own karma*. While it inflicts pain and suffering on others, this is *direct expression* of its immediate and conscious condition—which is acutely that of *unlove*. The negative being polarizes that way in the first place because the decision's been made to take the shortcut of *bypassing* the heart. So it shrinks the *anahata* to the proportions of a real fly-heart; but in so doing, it suffers the very conscious and definitive *lack of love*. And this is crucial even to the dedicatedly negative being, because love is one of the *indivisible Divine attributes* along with Selfness and Void.

"The negative being can appropriate the *Selfness* of absolute-being to its own self-aggrandizing ego version; and it can appropriate the *Void-value* of absolute being to its functional repertoire so as to glide diabolically *between* the spaces of filtrate screening etc. But it *can't*, constitutionally, profit by the value of Love which it has explicitly *excluded* as a *condition* of its particular polarization. Love eludes it; it does the negative being 'no good', so it becomes the *despised* aspect of the Divine reality. But since the negative being necessarily *participates* in the Divine reality the same as everything else, it suffers an acute deprivation of a very integral factor of its own nature. Because it is by definition a Conscious being at this level, its suffering remains acute.

"That suffering is itself the instantaneous 'karma' of its choice, as well as the propelling motivator of its malevolent 'compensatory' activity; for, participating in and through the very *Being* of Love nonetheless, the negative entity evokes a *distortion* of that principle (in that it comes to 'love', and takes great pleasure from, inflicting that same suffering—and haunting deprivation, 'lack' or *nothingness—upon others*)."

"I see," the Colonel said. "This is very fascinating. I must admit this is the best discussion of the problem of 'evil' I've yet heard, and makes the subject much more plausible than its usual Judeo-Christian context. You planning on writing this out, putting it in book form or something?"

"Maybe," MT smiled, instantly conceiving the conversational format in which the communication now resides.

### Here Comes the Night-Light

"But what is the negative *object*, then?" the Colonel asked. "I

can see the 'positive' object, since love is *overtly* present in the higher 'positive' densities of polarization. But the negative can't be looking for Love..."

"It's own *version* of Love," MT replied. "It's still *motivated* by the value that constitutes love, since it's *negatively-defined* in the first place by its functional *lack*. The whole-being unity and definitive Self-congruence that, emotionally, is identified as the value of Love, is sought in *simulacrum* by the negative being as a form of inclusive stability, a kind of omnivorous homeostasis where nothing is really 'external' to its internal equipoise."

"And it seeks to do this...how?"

"The simplest way to understand it, is to see it as a cosmic extrapolation of the ordinary, easily-identifiable ego project common to 3rd density. As you can see by just a little self-examination, the ordinary ego-project is a continuous if unrecognized attempt to render the essential *contingency* and *interdependence* of existence, as a fantastical one-way flow of order from the self-defining format of the ego to the refractory 'otherness' of the world.

"The ego first of all defines itself as an *ideal* constant, a *model* of Being or perfect stability insulated from the 'change' equated with death, in the very *midst* of the currents of change. That 'model', whether positive or negative, clear or muddy, self-exalting or self-deprecating is just an empty abstraction, a dry idea which begs to be 'filled in'—supported and completed by the utter conformance toward it, of the world of change—the world of resistive 'otherness' through which personal 'will' is continuously displaced. So ego works to *elicit* the conformance of the world of change in support and substantiation of the ego-project. It seeks the confirmatory reaction, not necessarily the 'nod of approval' but simply the gesture or response-pattern that conforms to, and reinforces in objective reflection, the ego's self-model. It seeks the sense of global substantiation, complete universal reinforcement without a leak. It wishes to definitively *Be* through the very patterns of 'becoming', or change, out of which its centralizing self-sense is coordinately aligned."

"I see; the ego's project is internally self-contradictory and therefore *impossible!*"

"Yes; and that is definitively realized, and correspondingly adjusted-to, in the higher density *positive* framework. At the same time though, by the insistent *clinging* to it as the premise of *higher-density development* it becomes the occasion of the 'old college try' negative style. So the negatively-polarized being indeed enters into the university milieu of the higher densities, but parlays the ordinary 3rd density-level ego aim into a full-blown, Faustian project."

"Ah! Comes the light."

"Yes, of a sort—for in the *Conscious* domain of the higher densities, Light indeed becomes the overt mediating term, the common coinage and efficient *aim*—and that both for positive *and* negative realms. Yet whereas in the positive realms the Whole-being value taking its 'coinage' in the medium of light necessarily draws the developing soul toward deep degrees of yielding and expansion *into* light, in the corresponding *negative* realms the object is, rather, a progressive determination and development of appropriate mind/body mechanical means of *devouring* more light, stuffing the light-energy-values as it were into the voracious hole or constitutional void of emotional *lack* comprising the negative state of the ego-soul altogether.

"The work of the negative being is to determine the *formulae*, extort and coax the technical keys of force-opening the internal mind/body centers and corresponding energy fields with their respective, guardian gatekeepers. The negative's business is to plunder the rich beds of energy-nutrient, the various treasure-troves of the vast creative domains where 'loosh' or psychic energy food is manufactured in abundance. For, being nonetheless a constitutionally *contingent-being*, a coordinate locus of mutually dependent states and functions, the ideally 'self-insular' ego-being *is still definable as Process*, as activities of interchange, reciprocal conversions and linked

metabolisms; it is, and participates in, the domain of Food. It is a function of ingestion, assimilation and elimination, and as such it *defines* the feeding process in terms of its own *negative project*: i.e. to eat rather than to be eaten, to devour progressively large chunks of food until, ideally, the very universe is swallowed and so incorporated into the ultimate justification and definitive aggrandizement of its own—arbitrarily circumscribed—'self'.

"Rather than the ultimate *resolution* with Whole-being value through progressive conversion of light-energy units (as is characteristic of higher-density positive development), the negative version posits ultimate *aggrandizement* in *parallel duplication* of Whole-being value through maximum incorporation of available radiance."

"That's why it's said that Lucifer's Legions can appear as angels of light!"

"Exactly. In fact, Lucifer *means* Light-bearer, bringer of the Light. Light isn't *inimical* to the negative orientation, as is portrayed in our superstitions and folklore; like its positive counterpart, the negative recognizes and overtly values light as sustenance, enabling *food* for producing integral reactions toward progressively higher alignments. Just as all matter—the 'food' of this dimension—is intellectually understandable as a kind of packaged 'light-value' woven in phosphates of the ATP molecule, so light is *overtly* valued as the energy-essence/lunchbox of the higher densities—coded as potential to be unlocked and restored to overall availability of the mind-body axis or radiant 'line' of *susumna*."

### A Very Light Eater

"So whereas higher-density positive entities might be considered Light beings, higher density negatives are more like...light-eaters."

"They *are* the light-eaters, the devourers of light. That's why they're associated with 'darkness', because the light is lapped up into the cavernous 'black hole' of their congenital emptiness, their persistent lack. Light is sucked into the abyss where their heart should be, in order to try to compensate or fill-in for the Love that isn't there.

"All the massive, cosmic extension of the ordinary ego-project that they perform in full consciousness and on the grand scale, is ultimately a means of 'cornering the market' on energy, monopolizing all the known fields of light or light potential. The expanding order they attempt to impose, the totalitarian control over increasingly-large numbers they attempt to exert, is the fantastical and internally self-contradictory project of coercing *everything* in creation to work for them, to cultivate and keep the fields of their energy-reserves and to furnish self-replenishing 'herds' of emotional source-nutrient which can be converted into useful energy or light-capital. Since the negative beings can't generate an important light-energy source themselves, i.e. the emotional range of energy-values belonging to the 'heart', they can borrow against the manipulated and artificially regulated emotional reserves of the beings effectually harnessed in thrall to them. Since the values of light energy the negative beings find useful to them and compatible with their systems are of light gathered from *negative emotional states*, it is in the 'best-interests' of the negative beings to promote a continuum of increasingly negative emotions and response patterns, i.e. those of fear and anxiety, hatred, terror and despair."

"Maybe this has something to do, then, with the rumors circulating around about the underground Dulce facilities where aliens have been reported to take infernal 'baths' in vats of liquid stewed with human and animal parts, a kind of diabolic broth of enzymes and hormones they're supposed to absorb for nutriment through their skin."

"Well, yes," MT replied, "there is something to this; hormones of the human ductless systems and various kinds of human and animal enzymes, neurotransmitters, lymphocytes and extract of digestive chyle furnishes variable measures of a radiant energy-value; especially the human reproductive system—the specific cells of

reproduction are just saturated with subtle energy-charge, and on top of that, the male seed carries a clear-light unit of awareness that comprises the usual parent-donor to the fertilized matrix prepared for incarnating consciousness.

"There are in fact multiple uses to which these 'natural resources' of the human system may be put. As grim as it might seem, the 'aliens' perceived to indulge that hormonal baptism are generally biobot replicants, hybrid forms created from genetic tissue of humans, animals and even plants; they have vestigial digestive systems, virtually inoperative because *these* types of biobot-form follow the general template of the higher dimensional negative beings only in more grounded and stabilized, physical terms.

"The higher-dimensional beings in their own context have subtle, vertical filamental axes on the Man-like model, because the general formula Man (inclusive of wo-man) presides over the present Logocic pattern; but, whereas the digestive system of Earth-based mankind is proportionately the largest of the physical complex, having an absorptive surface-area that can be stretched for square miles, the higher-dimensional beings of both positive and negative variety have largely replaced the cellular-tissue digestive tract with subtle nerve-networks (corresponding to the simpler regulatory structures of the autonomic plexuses in 3rd-density human form). Those subtle nerve-networks process radiant-energy values, drawn in through the etheric 'chakras' of the higher-dimensional systems; the *noetic* values informing a given energy-complex or ambient field-pattern determine the corresponding center through which the energy cluster will be absorbed and processed.

"Translating the higher-density alien structures into synthetic, *physical material terms* so that the biobot product may constitute a stable physical representation (manipulable like a marionette through the subtle-connective cords of the plexiform centers), results in a virtually dysfunctional, vegetative 'tract' homologously corresponding to the solid-food system of terrestrial beings but superfluous with respect to that function; the *solid-form* basis of the biobot 'parallel' to the alien structure, requires direct absorption of light-energy values, to be assimilated and processed by the appropriate centers and nerve-networks; and, whereas the etheric aspects of those centers absorb and process etheric-material energies much in the manner conducted through the earth-beings' chakra systems, the tissue-structure of the biobot form has to assimilate nutriment at and through its specific, flesh-born level.

"That function is of course performed in *man* by the cumbersome and really outdated agency of the massive physical digestive tract, generally at the expense of certain subtle potentials and energy-processes otherwise available that are coopted to the *major* physical spacetime work of solid digestion; in the case of the biobots, though, the digestive 'tube' is faked, a mere vegetative sketch; the more 'efficient' economy for the absorption and assimilation of radiant-energy and light values in the hybrid biobot form, is directly through the pores. The highest concentrations of the radiant/light values required, are locked into the physical structures of human enzymes and hormones, so that's what they go for; they imbibe energy-rich extracts of the human reproductive and glandular structures wholesale through the high-saturation surface area of the skin itself."

"Then that whole business of the alien hell-soup...has a basis in fact." Present company was now turning green about the gills.

"Unfortunately, initiated understanding has to confirm very much of this," MT continued. "Tremendous concentrations of desirable energy-values, laced with the emotional juice that generates them, are involved in neurotransmitters such as serotonin and dopamine, and in epinephrine/norepinephrine hormones of the sympathetic systems. Agents of psychic stress are always most suitable, and very charged.

"A very potent extract of the excitatory processes is *adrenochrome*, which in minute amounts packs a terrific jolt; micro-



scopic quantities of the live substance directly ingested can be fatal to humans; but the alien-consciousness (connected up by astro-etheric threads and plexiform webs of marionette energy-signals to its biobot correspondent on the physical level) gets off on it, the more the better. Adrenochrome is generated through the psychic pattern of terror, principally; and its extract can only be catalytically effective when obtained from a still-living subject. I leave the rest of the ugly picture to your imagination."

"My god..."

"God doesn't seem to have much to do with it. At the same time," MT continued, "it is very probable that much of the more horrific stuff—reported through the 'underground'—regarding places like Level 7 in 'Dreamland', Nevada and so forth are calculatedly projected and controlled thought forms impressed upon the 'captive audience' of a human consciousness, that, in fact, has been more or less selected to 'escape' or be returned to the workaday world so as to begin circulating the fearful and depressing rumors."

"You mean the stuff about people being kept in cages with the approval or cooperation of the military/CIA in those underground facilities, and the ghastly hybrid experiments that have been glimpsed by abductees like some nightmarish magnification of scenes from 'The Island of Dr. Moreau'...?"

"Yes. We can be pretty confident that at least some of that is thought-form induction directly into the memory-banks of the abductee, rather than literal reporting of things seen; the effect of course is to begin the circulation of horrific rumors so as to generate an atmosphere of terror, the cumulative energies of which will of course serve admirably as food for the negative beings—another aim is to instill an overall atmosphere of depression, despair and ultimate defeatism before 'they' even surface on any large scale to the daylight of general mass perception, so as to have satisfactorily devitalized any potential resistance or aggressive anger before-the-fact."

"Then you don't think there are *really* many-legged octopuses and mutant furry creatures that cry like human babies..."

"Well, there is a *tendency* with the negative being, and the negative reality altogether, to continuously move in relentless 'materialization' from the playful nightmare planning boards of the 'dream-psyche', (out of which they derive the shapes of mankind's common fears and through which they imprint and reinforce the sense of their impending *actualization*) into daylight waking reality with flesh and blood counterparts of the most hellish nocturnal impressions. So—even though a large part of these more lurid reports (always taken from *controlled-environment* settings such as enclosed underground rooms, where the psychic and brain-wave ambience can be rigorously regulated to alien design) may be initially some expression of a *seeded thought-form*, the tendency of the malevolent aliens is to use such thought-forms as *template* for the molding of biogenetic materials, productive—ultimately—of real phantasmagoric 'beings' corresponding to the most oneiric horrors."

Indeed this fact wasn't unknown to the medieval alchemists, who warned of the dangers of the path of internal spiritual transformation when it was written of the "mountains of the moon" (esoterically, the interior site of the 3rd eye):

"Go, my son, to the Mountains of India, and to their quarries or caverns, and take thence our precious stones, which dissolve or melt in water, when they are mingled therewith. Much indeed might be spoken concerning these mountains, if it were lawful to publish their mysteries, but one thing I shall not forbear to tell you. They are very dangerous places after night, for they are haunted with fire and other strange apparitions, occasioned (as I am told by the Magi) by certain spirits, which dabble lasciviously with the sperm of the world and imprint their imaginations in, producing many times fantastic and monstrous generations."

—*Lumen de Lumine*, by Eugenius Philalethes, p. 24

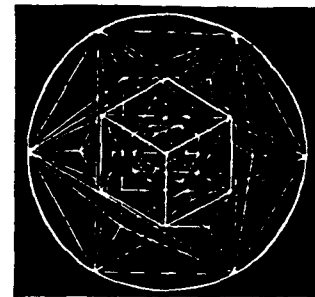
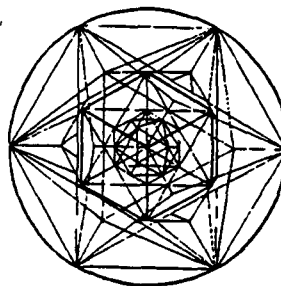

Such passage clearly indicates that there are "those" who *share* the uncommon condition of the opened 3rd-eye—newly experienced by the initiate of the above instructions—yet who definitely utilize that power to a negative purpose, magnifying the efficacy of the imagination by those means to produce a contrary world of terrors and impedances to the positive progress.

"Then the UFO beings that are reported as having been seen at the *physical level* are..."

"Generally, they're *biobots*, biological robots 'viewed through'—like remote t.v. equipment—and manipulated long-distance by the 'real' aliens invisibly parallel our reality within their *own* psycho-physical alignments corresponding to 4th or 5th density; they're usually identified by their *sluggish* character. They seem comparatively lethargic and unresponsive, and each of their actions seems arduous as if performed underwater.

"In comparison, the 'real' greys or negative aliens, while they can appear in an Earth-physical context, are in-and-of-themselves unstable; they don't as a rule stay long (whereas the positive entities like the Pleiadeans of your Meier material, being more intrinsically 'human' in structure can stay much longer); instead they show up just long enough to strike quickly with their particular aim, usually that of snatching some targeted 'abductee'—and then the rest of the abductee's experience of them is *within their own environment*, either homebase planet or UFO vehicle. Just compare the Whitley Strieber reports of the behavior-patterns of his alien beings. They're swift, almost discontinuously rapid and flickering in their movements, striking with cobra speed before a wink of reactive thought can intervene or interpret."

"I suppose the Andreasson greys are biobots, then..."

"No, not really. They're *clones*, which is something a little different. They belong to a 'hive' or group soul, and are regimentally designed for specific functions. They have real, intrinsic intelligence and consciousness, though they *are* very much like worker-bees. The Andreasson 'dorks' are technically not negative beings, but have developed along a kind of mechanically positive wave-length which they're now trying to adjust with the more elastic freedom and emotional sensitivity of their human 'counterpart'."

"Counterpart?"

"Yes. Most of the 'abductees' of this type of alien, actually come from a biogenetic background originating from the alien source-planet. They were 'seeded', ancestrally, to interblend with the specific values indicative of Earth-consciousness so as to come to genetically incorporate some of those 'virtues'. That's why, in the case of the types of alien we call the 'space dorks', abduction tends to 'run in the family'. It's actually generational, though that fact is usually only specifically subject to hypnotic memory retrieval."

### Interference Signals in the Spacetime Traffic

"You know now that you mention it, the surfaced reports and eye-witness testimonies regarding the 'live-alien capture' by the military during that initial Roswell-Aztec span of time in '47-'48 describes the EBE as having very sluggish behavior-patterns. The live-specimen aliens that 'stayed around' in containment for a while, all seemed to have that characteristic slowness and very delayed reaction time."

"Biobots. The military was being 'entertained', through the entrapment of Stalking (cf. issue 4, Vol. 2 *TNTC*) by a traveling roadshow of handpuppets and diabolical marionettes."

"Then the idea was to demonstrate..."

"Vulnerability. Vulnerability through apparent *susceptibility* of vehicle-malfunctioning in the vicinity of Earth-radar, and the idea that at least under Earth conditions the EBEs were fatefully slow in response time. The government would be very reluctant to enter into treaty with any *unknown alien power* it didn't at least suspect had an exploitable vulnerability.

"When you think about it, how many times would such an intellectually and technologically advanced culture run afoul of our parochial radar nets before they figured out the problem and compensated for it? Yet time and again alien vehicles came crashing accommodatingly on our doorstep, always with the same cover-story that 'they couldn't deal with the unexpected problem of our radar-systems!'"

"Sort of like the coverstory about why their digestive tracts are atrophied—atomic wars and nuclear genetic mutations on their home planets, all that stuff..."

"Exactly. Vaguely plausible rationalizations stated in 'our' terms, terms Earth-ears could relate to—ears that didn't know one thing about the various densities of existence, the variable requirements of mind/body polarization alignment, inner adjustments of the vehicles and facultative 'fields'..."

"So we 'invited them in', so to speak, believing initially that it was easier to have an overt diplomatic relation with their presences so that they'd be more easy to monitor, and at the same time so that we could learn enough from them regarding advanced technologies to be able to hold our own eventually in the face of less cordial developments, or against more bluntly bellicose visitors from other zones of space and time we were beginning to realize actually filled out the 'empty' intervals between Earth and the farthest star."

"That seems to be the general consensus sifted out of the collected data and 'inside' stories."

Initiated insight knew abstractly, from many years back—circa the beginning months of the Process as described above—about the upbuilding alien presence, the general patterns their different civilizations and polarization-allegiances described with respect to terrestrial interaction etc.; Initiated understanding also knew by observation of subtle faculties the character of the covert projects begun on the basis of that interaction, the world-government coalitions even at the height of the camouflage "cold war" preparing underground and interplanetary escape routes etc. The specific details as to how these things initially developed, necessarily sorted themselves by subsequent report of real witnesses and participants in the events themselves, and—in the case of initiated wisdom—by further contrast and comparison in the optimum light of Intuitive alignment so as to filter bands of probability and high potential accuracy from striations of misinformation, muddle and even disinformation...

"What happened after that, however," MT continued, "doesn't seem to be at all clear to those even most aware of the situation; after that initial Event of interaction the flow-lines begin to become ambiguous and seem to describe bewildering criss-cross patterns..."

"That's for certain. It's all a mess, with people running about alternately claiming that the government is in league with the negative aliens, that the government is trying surreptitiously to get itself disentangled from the committing 'devil's pact' it got itself into..."

"Actually both of those 'signals' have some truth to them. The really critical thing in all of this is to determine the specific *levels* from which those apparently contradictory signals emanate. It makes a great deal of difference whether the subliminal calls for help and distress messages are issuing from the deepest parts of the 'shadow government' or from more peripheral 'service' levels that necessarily interact with that covert reality but which have much less of a central

stake in its negative premise, as well as much less knowledge regarding the overall 'plot'."

"So, uh, which is it?"

"The determining factor here is the *real* alien agenda. If the true alien intent is to mount an invasion or occupation force, then the *detection* of that intent by members of the secret government would constitute grounds for a scenario of basic antagonism; the deepest levels of the secret government would be looking for ways to adapt the superior alien technology to available terrestrial means, and would be in the process of continuous 'scouting', sending out coded S.O.S. signals through various media, intentional 'leaks' etc. designed to attract the attention and cooperation of those in the populace at random who might actually have types of knowledge, insight or even 'contacts' that they could use. This could account in part for the 'peculiar' solicitation of 'psychics' and so forth by the CIA; the idea that such tactics are attempts to keep up with Russian activity in that field in case it happens to contain anything 'worthwhile', might be camouflage rationale—that could account for the circumstance that *Science Digest* even published matter-of-fact material several years ago about psychic-espionage research of the CIA under the cover-story of keeping up with the Soviet 'Joneses'."

"Then the government is trying to break away from its earlier 'commitment'..."

"No, not exactly. That *would* be the case, we could legitimately interpret the soft signals we're receiving in that way *if* the actual alien schedule was just that, i.e. to mount an overt invasion force with a gradual underground 'troop' buildup toward sufficient, transplanted numerical strength to be able to wage a successful, 'local' planetary war. Truth to tell, where the Wisdom eye is open it's perceived that this isn't the *real* alien scenario, but their *camouflage* scenario. You really have to understand their Intent from the higher-dimensional perspective from which it actually emanates."

### The Name of the Game, All Languages

"In the higher densities, the Name of the Game is *Consciousness*. This simply means that the higher densities of existence, whether positive or negative in orientation, uniformly recognize that the business of *all* being and existence everywhere is always that of Consciousness, even in our own '3rd density' where that fact is generally disguised in symbolic or substitutive terms. In the higher densities above 3rd there is *no longer* any delusion about the ultimate *raison d'être* of existence. It is overtly and directly understood as Absolute Consciousness, whether in the positive or negative framework.

"The difference is that the positive framework recognizes the homogenous business of life as being that of *integrating* the functional ego of self-reflective cognition into balanced, congruent alignment with the whole-being value of Absolute Consciousness. The *negative* framework of the higher densities, on the other hand, posits the game in terms of the ultimate *aggrandizement* of ego as the functional *equivalent* of Absolute Consciousness, exalting ego to the nth degree of total creative *absorption* and subordinative control/dominance. In all cases, Consciousness is overtly identified as the common denominator, the standard and coveted value; and that makes the *real* business of the negative fundamentally different from the cover-story carefully set into place with the recognizable colors and attributes of our own 'local', planetary terms."

"Then they don't intend to *literally* take over..."

"They *do*; but in a very specific way. To the higher-density negative beings those Ruby Slippers have to be obtained *very carefully*. They can't just be arbitrarily yanked off the feet to which they're provisionally fitted. 'Gathering the essence' is in this case a decided *art*."

"You see," AAA continued the explanation, "the negative 'plan' is only *camouflage*-invasive as a direct matter. It's not so much a function of military takeover in our familiar sense as it is of *stalking*,



an art with which this density is all but *completely* unfamiliar.

"Stalking in this case builds up the subtle, cumulative *impression* of militaristic-style infiltration and takeover, made all-the-more cleverly convincing because it allows itself to *seem* 'discovered' as if by the ingenuity of our spy network etc. The aim of Stalking, by those means, is to create a completely controlled artificial environment composed of thoroughly predictable human behaviors—*made* so because they've been programmed to respond to cues of conditioning revolving around a 'story' that is actually *untrue*, and wholly misrepresentative of the *real negative aim*.

"Behaviors of our military and government personnel *artificially conditioned* by the habits of their response-patterns, are in fact eminently predictable and subject to extensive, engineered manipulation—you know, getting everyone to act appropriately and in confident coordination at just the precisely-timed moments. In this way they create invisible corrals, and generate an artificial stampede in the formative ranks of the world-wide power elite—a stampede taking its momentum from mind's own characteristic impulses and direction. So they herd them into a rapid, tight consolidation along the lines they were heading in any case.

"In fact for centuries they've been giving the power-structure its suggestive influences from 'long-range'. The early Tesla electronic discoveries of this century, for example, were swiftly shunted into the exclusive privilege of private hands and kept from the public; negative 'long range' influence encouraged the beginning of an intensified exploitation of alternative energies by the power structure right there. The financial/military empires of the planet began their several lines of development on antigravity and ray technology at a time when that had no more 'official' reality than the old Flash Gordon serials. Yet it wasn't till the mid-to-late '40s that the current era of rapid, forced consolidation began as a direct result of the sudden 'alien invasion' scenario."

"You know," the Colonel said, "some feel that the whole 'alien invasion scenario' was an artifice concocted by the government and newly-crystallized espionage agencies with autonomies beyond the Constitution, that simply used the secret Tesla-based technologies and pharmacological advances to enforce the impression—through the subliminal psyche of the general public—that there was a vaguely forming 'threat', an unsettling undercurrent of 'alien presences'."

"Yes, some people go by that theory," MT rejoined, "but it's based on a misperception; the manifesting fact of various, 'advanced' kinds of drug-and-implant technology in the hands of espionage agencies is the *result* of an original intensified interaction with alien empires, not the source of subliminal *impressions* regarding the existence of those empires.

"Certainly the CIA and NSA etc. have wide use of manipulative kinds of technology scarcely known to exist at any level; but the derivation of those technologies is a complex genesis between 'homegrown' discoveries which were often themselves the results of influence flowing from the various class of 'space-brothers', and scientific advancements strategically parcelled out in direct manner from 'landed' aliens themselves. Those secret manipulative technologies are variously used by various covert agencies; there isn't so much of a unified conspiratorial program as several, concomitant and often overlapping 'conspiratorial programs' perceiving their respective activities according to different levels of function and access.

"This blurred-focus use of the technologies by the several, mutually-screened levels of government agency activity suits the alien purposes just fine—in fact, it's all consistent with their program of Stalking, in which confusion and cross-purpose prevents a clear perception on the part of the Stalked subject as to just what's going

on."

"Then there's no direct, one-to-one conspiratorial interaction between the 'shadow' world-government and the negative aliens..."

"Oh there *is*, but mainly at the deepest level. This is partly because the most central aims of the real power structure at the very 'heart' of terrestrial 'darkness' are closely compatible with alien aims; the most entrenched members of the Bilderberger/international bankocracy complex are virtual graduates to negative polarization themselves.

"This can be viewed as the two-part *product* of the act of Stalking itself; by first of all stampeding the power structure and its various military enforcement-arms into consolidating under adoption of the negative-alien mood, mode and approach, the power elite is in effect *squeezed into alignment* with the negative mold. Fitted more precisely into that mold, it can be procedurally 'taken over' directly, body-mind-and-soul; so that, whereas it was *initially* moved at its core by self-protective instincts, it has long since transformed into covert congruence with the negative alien Intent.

"At the deepest levels, the power-structure and its Nazi-recruited espionage agencies can't be distinguished from the alien dynamic itself. They are 'in league'; they're at unholy Oneness. It's only the intermediate and 'service' levels of the power structure that may still believe they're playing out the basic 'antagonism' and 'self-protection' roles. At the same time, the conspiratorial consistency and unification at the higher levels is partly the

product of negative *cloning*, implant technology and direct takeover of certain terrestrial seats of power."

"You mean certain members of the 'elite' might be directly cloned, genetic carbon copies pulled by invisible strings of the extradimensional aliens..."

"Some yes: where it was deemed strategically necessary. Numbers of the elite, the various spy agencies etc. are often implanted, and influenced by low-frequency programs.

"Yet, although extensive implant technology may be used in that way to ensure influenced obedience, a degree of technical freedom is often conserved through the consciousnesses of certain central members of the power elite; for, don't forget, the commodity valued at a real premium in this scenario is *consciousness*; and a totally drugged, surgically altered and thoroughly programmed psyche is only good for robotic slave-service, i.e. dispatching mechanical secondary functions. The *primary* object of Negative stalking is to procedurally persuade, through strongly influenced but not robotically tailored behavior-patterns, the ultimate polarization of consciousness to negative higher-density alignment. This is because, in the long run, the object is the addition of functioning units of real consciousness to the negative hierarchy, with volitional prerogative—indicating the presence of real, conserved consciousness—intact.

"This conserved element of *true consciousness* is the ir-reducible value that *allows* polarization-alignment to the positive or negative in the first place. Insofar as it is *not* chemically coerced and 'boxed' into internal electro-magnetic traps of the brainlobes effectually curtailing real exercise of discriminatory volition (and thus consciousness), to that degree the mind of the subject retains the all-important value of the *indeterminate variable* distinguishing consciousness and the volitional axis *as such*.

"Thus real negative polarization as a *prerogative* of that indeterminate variable, is achieved in the case of the given subject. Yet that subject becomes an immediate *functional* dependent of the higher-dimensional entity (or 'commander') efficiently responsible for having *induced* the negative-polarization alignment of the subject in the first place regardless the deceptive means employed, the



persuasive misrepresentations marshaled in conditioning the *terms* through which that fateful value of 'volitional indeterminacy' would be exercised.

"There's an immediate *psychic* bond of hierarchical relationship; at the higher-density level it's directly apparent and unarguable. The newly recruited 'souls' to negative-4th density take their place automatically in the pecking order, after a preliminary 'battle' amongst themselves.

"Because the name of the game is Consciousness, the progressively higher stations of the negative hierarchy are proportionately enhanced with every 'induction ceremony' of additional members; owing to the necessarily conserved value of real consciousness and the all important void-value of *volitional indeterminacy* in the case of negative recruits, the apprenticeship of the latter in the negative hierarchy necessarily entails the expansion—if controlled and carefully regimented expansion—of conscious/psychic potentials through the higher negative densities.

"Thus all 'initiates' to the higher negative densities necessarily learn the development and exploitation of their own conscious/psychic potentials as do all initiates of the higher positive densities; yet in the case of the former, that development is regimentally overseen by the negative hierarchy and very sharply proscribed in conformance with the austere requirements of the particular 'place occupied' and 'function performed' by the soul/subject. Considerations of innate-creative tendencies and potentials of development are *minimized* on the negative side of the ledger. Thus higher integration and mind/body development of psychic/conscious potential on the negative side is basically anti-creative. This is an important factor to note."

#### The "Desolate One" Is Just an Old Giza

"Just a second. I'm not sure I see how the development of the conscious/psychic potentials of the 'new recruits', as you say, directly enhances the consciousness of the higher members of the negative polarity. I can see how it helps them *indirectly*, by giving them a broader psychic 'spy' base and more sheer members of subordinate troops with 'psychokinetic powers' and so forth for conquest purposes. But the actual enhancement of the higher-negative's *consciousness*..."

"Well, you have to understand that *in* the higher densities, positive or negative, there is progressively less 'absolute' demarcation between one subject-soul and another. It's more like *all* participate in a field-continuum, and so they collectively take the form of what they call a 'social-memory-complex'. Though the focal ego-function remains, it tends by virtue of the denser-richer medium to be transparently participating in a group-psychic function, through a unified field.

"Owing to the direct and immediate, enforced *reality* of symbolic relationships in the Psychic medium (i.e. 4th density astro-material etc.), the conceptual fact of a soul having been efficiently persuaded to polarize negatively by a particular Commander of the negative hierarchy translates immediately into a functionally valid and formally operative *psychic bonding*. There's an instantaneous linkage and interpenetration through the densified psychic medium or unified field-continuum; the newly polarized subject inheres as a real, psychic fact through the general 'body' of the group or collective Consciousness of the commander-and-fleet.

"That 'mind', in the negative case, is not an egalitarian medium or pattern of value-parities. On the contrary it configures a distinct vertical order of control; and while the network of the negative 'fleet' extends in myriad psychic webs of specialized powers, forces and functions like a voracious Net flung across the heaven of stars, the sum energy comprising the group consciousness of that net redounds to the basic benefit of the Being at the apex of the control pyramid and is only variably parcelled out to secondary benefit of coinvolved beings, proportional to their respective 'stations' in the hierarchy.

"It all takes place in and 'spreads out through' that chief Being's basic Ego-purview; by the system of psychic equivalencies at the higher densities, the *symbolic* subordination of everything and all souls encompassed by the Plan of that purview means the automatic subsumption of all participating energy-forms to the overarching Form of the Commander's compassing Consciousness.

"That consciousness is literally fed and magnified by the number and relative strengths of the subordinate souls 'voluntarily' captured by, and incorporated into, the commander's widespread Net along with their specific, expanded 'siddhis' and developing psychic functions. The greater the overt development or 'extroversion' of those psychic potentials belonging to the chakra-complexes of the individual souls, the more available energy-values may be contributed to the sum psychic states making up the effective Consciousness-quotient of the Commander at the pyramidal top. The more psychic energy-capital is effectively available to boost that consciousness-quotient, the greater the effective *power* of the Commandant of the negative ego-hierarchy to consume more potent and 'difficult' food sources—the greater Potential efficiently available to convert to buccaneer ventures in plundering the keys, forcing the locks of even higher-density energy sources: those beds of inconceivably-magical nutriment yet kept from practical grasp in probationary ignorance of the 'formula' to the next-deeper dimension.

"Since the flow of respective 'contributions' describes a vertically-hierarchic pattern, it may be seen that all the mechanical functions and technical processes served by opening and development of the vital-psychic powers of the field-troops contribute energy-sums upwardly to the 'cortical' station occupied by the Commander, and so serve to literally amplify the coefficient of Intelligence, the effective Presence of Wisdom (negatively-inflected, in this case). The Generals of the negative hierarchy, are really something to be reckoned with (and so also are the 'grunts', of course, to the general level of 3rd density consciousness which they seek to subdue—but it has certainly been noticed, by abductees and others who've had any intercourse with the lower clone-ranks of the negative hierarchy, that the lesser troops and footsoldiers don't seem to have as clear access or 'right' to independent, spontaneous decision-making faculties as is evidenced by the commanders—and that of course makes their responses slower, their extemporized reactions to anything 'unexpected' cripplingly restricted)."

"Yes, I've heard of reports where potential abductees apparently 'threw the little Greys a curve', did something against patterns of programmed expectation; it seems to put them into such a stew of indecision that their closely regimented ranks begin to break and they bump into one another like windup toys."

"If you look at the whole pattern of the negative hierarchy through all the possible densities and levels—i.e., up to mid-6th density as previously explained—you'll see *very much* a pyramidal structure; in fact it's a kind of spiritual 'pyramidal food-chain' of the negative realms; the very narrow, sharply drawn apex of the pyramid is comprised of the most persistent of negative graduates, the very few (ultimately only *one* at the *very top*) who've stuck it out intransigently against every evidence of progressively-diminishing returns, to ultimately constitute the *logical conclusion* of the Negative Premise altogether.

"This topmost would be the 'desolate one', Lucifer as-it-were, the One who most directly embodies and promotes the *ultimate negative object*. And all of that which fans out under this One as the staggered 'trunk' of the pyramidal structure comprises the subordinate ranks, the sixth and fifth stage commanders and generals, then the fourth stage sergeants, corporals and recruits etc. All of that widening extension toward the populous pyramidal base at early 4th density may be considered the 'body' of the negative Being, the Head of which is the pyramidal Point-locus of mid-6th density (negative). All the subordinate 'stones' inlaid along the tiers of that immense structure, are entities functioning as regimented extensions and

mind/body 'parts' of the Overarching, Luciferian capstone, organs and processes prosecuting the negative premise from their respective levels at relatively *indirect* angles...but all such activity—regardless the efficient 'motive' of the level—feeding into the ultimate and most direct Wisdom-knowledge, negative-style, of the Top."

"You mean the motives of the different levels of the negative hierarchy are *different*, or effectively divergent from the highest level? I thought you said it was uniformly apparent through the higher densities positive or negative beginning with the 4th, that the ultimate *aim* was absolute consciousness?"

"And it is; but that *aim* is identified and interpreted differently, not only *between* positive and negative contexts but *among* the various hierarchic levels of either positive or negative orientation."

"So a negative 4th density being wouldn't necessarily perceive the object of his activity in the same way a 5th density being would perceive his own, or a 6th?"

"True; and on top of that, the higher-density being—say 6th—doesn't perceive the object of a 4th density being's activity the same as would that 4th density being; the higher-density being wouldn't describe it in the same terms at all because from *his* vantage he perceives it in the larger and more compassing context. This is even more acutely true, and the distinctions are even more acutely marked, in the Negative framework than in the Positive, because it's an indigenous characteristic of the *negative* framework to *deliberately mask* and *distort* that which is higher and more comprehensive, from that which is lower and more 'specialized'. In the *positive* higher-density frameworks it's more intrinsically possible for the 'earlier' levels to perceive the object of the 'later' levels with minimum distortion (emanating only from the inevitable 'viscosity' of the functional medium itself)."

"Then what's the difference between the way the 'lower' orders of the negative hierarchy perceive their business, and the way the *highest* perspective of that hierarchy perceives it?"

### Food for Thought

"Look at it this way. The most immediate level at which we can grasp the Negative plan—when we have initiated insight into it—is also the level at which its operatives most efficiently grasp it. As far as they're concerned, the immediate business of their activity of Stalking is to crystallize under artificial pressure a global power-elite of indigenous *and* alien beings to completely dominate the Earth and its inhabitants as a captured negative resource; their functional target is always that of polarizing just so many more souls *and* environing matrices toward integral reinforcement and hierarchical attachment to the Negative Reality."

"You mean not only individual souls, but whole *planetary entities* can be induced to polarize negatively?"

"A 'planetary entity' is the focal-coordinate medium of a specific *density* of mind/body interaction and ratios-of-function. At the cosmic 'moment' such an entity is scheduled to polarize into the state of a higher density, the opportunity is considered ripe to induce that polarization to take place negatively, so that the 'planetary consciousness' comes to participate in the *Negative* 4th density reality rather than Positive 4th density reality. Negatively polarized beings require negatively polarized planetary bases through which to function, just as higher-density positive beings need positively-polarized planetary bases. What you see now in terms of the diminishing oxygen content and intensified ultraviolet bombardment of our atmosphere is not an 'accident', an unfortunate but inevitable byproduct of industrialization; it's sign of the deliberate (if, of course, covert) effort of the Negative hierarchy to prepare the biochemical and electrical composition of this planet for negative polarization. There *are* such things as 'evil planets', dark stars...and the real, pending question is whether Mother Earth is about to become one of them, twinkling with firefly allure in the Sinister firmament..."

"If this is the way the 'rank-and-file' immediately grasps the

business of the Negative objective, how in the hell does the *topmost* perspective of the pyramid-chain perceive it?"

"Good question. And the answer to that question involves precisely the reason why, on the *negative* side of the density-ledger, the higher tiers of the negative overlords seek to deliberately distort and mask the character of their *own* objectives from that of the lower planes of 'subordinate functionaries'.

"Consider this: for the minions of the 4th density 'invasion' force—or more properly, the Stalking force—a delicate line has to be tread; for, while it's true that the negatives literally feed on destructive patterns that generate the high-energy properties of pain, fear, terror etc., they realize as a *practical* matter that an overzealous prosecution of the task is quite liable to generate a runaway momentum of its own, establishing a negative snowball toward ultimate destruction—the pushing of the verboten 'red button', for example—which would for them be the equivalent of killing the *goose* that was disgorging those gorgeous, golden eggs they could continually break into...in other words, what's the point of pillage and rape if nothing is left as booty but an homogenized mist of radioactive particles expanding through space?"

"At the 4th and even 5th density-levels, the pyramidal hierarchy of interlocked functions—psychic and psychokinetic powers etc.—operates as an immense coordinate net, collectively spread over and subsuming all possible 'refractory' elements of the exterior universe (conceived as the problematic 'otherness' of being over-against the sovereign subject/abstraction of the Ego-self); that hierarchy is viewed as a regimented *machinery* of beings serving as expendable cogs in an Engine of Conquest which progressively envelops the features of a creatively-resistive world, subduing them and incorporating them *internally* as swallowed, digested and assimilated matter of a continuously Swelling homeostasis of the Ego. The more all far-flung elements are gathered in through the castings of this diabolical net, broken into domesticated manipulable codes by the juggernaut grinding machinery of the Negative power, the more all things become predictably-controllable and regulated matter of the 'ultimate' Ego-project (perceived from the particular, overlord level) contributing to the conformal homeostasis and self-supportive Environment of the aggrandizing consciousness in question.

"At these levels, the 'object' is to convert all energies and specialized powers of the negative troops into *potable information-patterns* of a far-flung Network contributing to the knowledge-amplification and awareness of the pyramidal generals, commanders, overlords etc. The *fruits* of those energies and powers of the 'pawns' in terms of actual ground gained, real elements subdued, contributes to the progressive vertical compounding of highly integral *control-values* for the negative CO's, expanding the field that comes under their regulatory jurisdiction and therefore *ensuring progressively-more-voluminous* 'farms' of energy-nutriments on which to vampirically suckle. The expanding orbit of their control that comes under the far-flung net (drawing in elements to be computed and programmed into their regulatory Machine) is equal, then, to an enlarging multidimensional sphere of energy-rich food, to be introduced and converted directly to magnitudes of enriched *Consciousness*, i.e. knowledge-power, in their direct equations.

"There's a consequence to this onesided intake of Light-energy resources within the negative framework, and that consequence is progressively manifest in the higher densities."

"What's that?"

### Periodic Light Flow

"Before anything, we have to understand that light is the 'first matter' of consciousness.

"Light-energy values are constantly circulating through patterning coordinates of the *mind/body axis*. That axis isn't ultimately just another objective 'reed' in a field of equivalent, crowding stalks but the special *crease*—the universal juncture or vertically folded

Common Denominator around which all the geometries of light (comprising the grid-patterns of perception) convene, and resolve to void-equivalencies as the universal Medium of Consciousness.

"Such filtrate grid-patterns, you see, are ordinarily *masks* of that ultimate resolution; the Whole-being value of Consciousness itself is chronically displaced, at 'our' level, through multidimensional focal alignments in implicit adjustment to standard *typologies* comprising the current 'ceiling' to the puzzlebox of delimiting identification—the present functional horizon circumscribing the polar terms of provisional self-recognition."

"...Which is reflected over, and invested in, a whole cognitive panorama of symbolic or substitutive identity-equations," AAA added.

"Within such displacing processes, 'light' functions as the indefinitely reflective medium kaleidoscopically polarizing the created fields *through which* the whole-being value of Identity becomes fascinatedly fixed. It becomes, shall we say, fatefully coinvolving in its own internal potential of ideoform 'types', and endures an operative intussusception closing over, around and passing 'through' its very field in identified nucleation of the reflective light-patterns of those typologies. It surrounds itself with the signatures of its own present, 'optimum' capacity for polar resolution in the potential patterns-of-identity."

"You mean—that's what all the 'stuff' of existence is...the trees, snails and dugongs of life? They're forms that display the polarized range of conscious expression as it's presently able to apprehend and understand its Being?"

"Yes. All the prolific 'things' objectify moods, tones, drives, desires—the various serpentine angles consciousness can take on its single Self..."

"Light-energy values of the various types are coordinately drawn through the axial 'tube' of the mind/body centers, collecting and concentrating the sum meridians of the nature field; they're ordered as abstract-cognitive geometries variably patterning the dimensions of focal alignment polarized across the 'anthropic' median, or conscious channel.

"They process the Psyche of perceptions, impressions and influences as energy formats *cognitively interpreted* from—and making coded entries into—the sum-over typical identities running the autonomic circuits or 'nature-current' of the being; and they conduct those qualities into the extended nature-field as well, in streaming circulations following the rhythms of mutual ingestion and assimilation that arise between the 'body' and the 'world'.

"In this way, at the ordinary 3rd density level, we may understand that a continuous two-way circulation is maintained between the tailored, stepped-down light values transmitting noetic patterns through the locus corresponding to the pineal-pituitary glands, and coded light-values charged with the psychic imprint of prevailing typologies which flow from nature into the plexiform centers and out again—as well as the radiant-energy substances taken in through food, the receptors of the sensory organs and other glandular, enzyme and hormonal secretions etc.

"Owing to the *character* of those typologies encoding the operative light-values (resulting from chronic displacement and anisometric alignment toward a broken-field of focus through the conscious axis), the radiant-energy properties flowing into the ambient 'egg' of the mind/body pattern are generally subjected to a weak economy; they're processed and passed out again into nature on the basis of a comparatively low-level mind/body integration and metabolic balance involving a high rate of *inanition*; those radiant properties yield a specific *ratio* of their innate whole-value as Light, according to the code of their chronic locks opened to the limited keys of the prevailing mind/body circuit-integration.

"Much of the higher values of unitive luminance are therefore lost in the processing of radiant-energy properties, and the modified light generally flows out again along the same 'horizontal' plane of

chronic mind/body functioning—passing back into nature with a characteristic psychic 'charge' encoding typical values of various, vitalistic identity-impressions, imbalanced modes of overall self-apprehension efficiently organizing the phases and incorporative processes of the life-current."

"But then there must be higher-order adaptations to this general process of circulating and incorporating the Light."

"Yes, that's what we were getting to. To understand the consequence involved in the *negative* extraction of light-energy values, it helps considerably to understand first what the optimum *positive* form of management is.

"In the higher-density *positive* alignments the integral unity of the life-processes is optimized in correspondence to a deep, unitive self-apprehension of consciousness. In this case, rather than simply flowing out horizontally into the nature-field again (where they inform and promote the same, repetitive planes of typical percepts coded as structural drives and desires), the light-energy units are progressively balanced, aligned, conserved and incorporated as power-exponents of the higher centers; rather than simply discharging in one uniform stream conducting the standard typologies of the nature-pattern, they're integrated according to higher whole-order values along the *vertical* or *transdimensional* line, restored to the common *convergence-axis* of *self-luminant Identity*—the integral unity of the cerebrospinal channel in alignment with the Source-light of void mind.

"They significantly reduce their aggregate, outward flow as patterns-of-identification (reinforcing and infusing the structural vitality of nature-forms), and instead merge to align the multi-dimensional mind/body pattern through which the common value of Identity appears. Such high-integration alignment, achieved by this means, configures a total-unific radiation pattern reflected through the nature-field as optimal harmonious influence.

"This promotes a mirror magnification and enhancement, the reflection to and from the cognitive field of Whole-being value through all patterning forms; the radiant-energy ambience of the cognitive field parlays the sum of its differential identity-patterns into whole-being congruence with the axis of *Conscious Identity*. Such ecstatic, celebrative congruence is a direct expression and higher-density function of Love.

"Love is then the powerful productive and redemptive identity between the Creative value of Being and *Consciousness Itself*, mediated by the ideoform term of Light."



### "This Cosmos Isn't Big Enough for Me And You Both, Mom..."

"Since the negative polarity seems to reject the principle of Love, to what use is 'conserved light-value' put in the negative program?"

"As we've seen, in the negative higher-density orientation, imbibition of radiant-energy values is enacted as a one-way flow. What 'pours out' again through the light-satiated eyes and patterning mind/body centers of the negative being, is the same conscious-identity commitment to division and discrimination that formed the negative point-of-departure to begin with. Restored and integrated light-values may be put to whatever use consciousness sees fit. The unitive *function* of light/radiation patterning doesn't compel unitive perception or whole-being cognition; in fact since the *typology* informing the absorbed light-energy value is surcharged with psychic

negativity (fear, pain, hatred etc.) in this case, it integrates most thoroughly with and reinforces the predisposition of a *negative* mind/body polarization-alignment.

"The progressive *power* that devolves from the 'capture' and incorporation of radiant-light sources (in terms of an increasingly irresistible *Psychic integrity* engaging an expanding orbit of control and domination) in this case serves to feed and enhance an exclusive subjectivity-of-consciousness *defined* by that very, divisive/dominative premise; since the effort is toward the subordination of all things as stabilizing, confirmatory 'food' of the magnified narcissism belonging to devout ego-consciousness, the greater the success in securing the (expandingly-stable) field of that domination the greater the disdainful disregard of the integral *validity* of the created field altogether. The absorptive framework of luminantly self-enhanced ego-consciousness therefore takes on a severe functional contraction and effective *withdrawal* from interest/involvement in the created fields-of-being, maintaining a minimalist reference toward that Canvas only insofar as it enforces the—ideiform—influence of catabolic dualism and division (in the deliberate, psychic pattern-warping of the basic logic architectures).

"Thus the negative being of the higher-densities takes on the 'configuration' of a forebodingly lone presence, lurking in caves and desolate grottos of the astro-physical or etheric-material fields, a fiercely mental entity of 5th to 6th density power-knowledge possessing the proverbial basilisk Gaze and only turning the stream of attention 'away' from that intensified/contractile self-sense toward the created fields in token deference of the need to canalize the 'radiant-displacements' of the cosmic patterns as continuous, self-funneling food source—sucking vitality from the superfluous extravagances and wholly wasteful pastimes comprising the folly of energy-expenditure through the created worlds, restoring the light-units of that nutriment to their 'rightful' function...that of uninterruptedly powering the inconceivable 'wattage' required to maintain the monumental absorption and narcissistic self-luminance of the negative Ego-postulate. And *this* is the definition of the Luciferian light."

### Spackling the Crack of Dawn

"I think I'm detecting a faintly familiar principle here. It sounds very much as if, the higher-up the negative densities we climb, the closer we get to the *real* negative premise underlying all this activity through the worlds and planes."

"And just what's that, Colonel?"

"It seems to me that it sounds very much like the Luciferian intelligence is motivated basically by jealousy!"

"Very good. Jealousy of what, do you think?"

"Well ultimately, jealousy of...it would seem jealousy of the *creative* power of Being altogether, jealousy of all the created cosmos altogether—as far fetched as that might sound."

"You're onto something, Colonel. It's *the whole* Logic reality, all the realms and patterns of creative potential combined that rankles Luciferian consciousness, and provokes the elaborate ramifying saga of its venomous response!"

"It's ultimately a matter of *attention*," AAA continued. "The real cosmic question is always 'how is attention to be apportioned?' When we finally track Luciferian consciousness to its 6th density lair, we find a philosophical characterization of how *attention* ought to be employed throughout eternity; we find a primary *thesis* of consciousness, in the Presence of the great proposition of the creative Logos or pattern of the manifesting worlds—for that Proposition provokes a spontaneous crisis in the infinite Void-being of Consciousness, to which several virtually-simultaneous orientations respond."

"Where does the 'Luciferian' response come from then?" the Colonel asked. "If that could be answered you would have solved one of the great philosophical and theological sore-points of all time! you know, the question as to where 'evil' originates and how it is that it

seems to be 'allowed', or accommodated, by a Perfect Being." The Colonel's question was more wistful than expectant as if the very, perennial character of the conundrum vetoed confidence of any real solution; but AAA answered nonetheless, with soul-searing directness.

"It comes from the first infinitesimal flux of ambivalence within Consciousness Itself; it's the product and ultimate implication of what occurs in the 'beginning'—the *ontological* beginning, not 'temporal'—when Consciousness awakens from its perfect Cosmic Sleep homogeneously enfolded in infinite Self-continuity with Itself—scarcely stirs from that featureless unity of seamless self-congruence and tentatively stretches its heretofore-undivided attention in notice of the awakening creative potential within Itself *now suddenly boiling forward* in irrepressible display on the encouragement of that first, faint capture of the authorizing value of Attention.

"That first glimpse of consciousness in its creative Morning, its seductive Dawn, gives it vertigo; it feels its indivisible quality of attention (through which the homogenous Voidness and intimate *Selfhood* of such Voidness was—but a 'moment' before—uninterruptedly sustained) being inexorably displaced, unstoppable drawn offside and diffused in the potential *Myriad*—conferring, as it does so, *actuality* to that potential by virtue of the authenticating *acknowledgement* contained in that very concession of Attention."

"What about the *fascination* of Consciousness with its potential Logic creativity?" the Colonel asked. "What about its *Love* for the burgeoning offspring it finds within Itself?"

"Yes, that fascination and that Love are there too, virtually at the same time. But the responses are *distinct*. That's why it may be said that Consciousness really exists in an ambivalent state, at this inchoate degree of Its own Creative Process.

"The aspect of Consciousness which experiences the vertigo of rapidly-displacing and self-dividing attention, however, generates specific qualities around itself. First of all it expresses as *trepidation*, fear. It recognizes the requirement for the intimate *investment*—and indeed *one-to-one association*, at some level—of the whole-being value of Identity with respect to the delimiting and restrictive properties indicative of the Creative pattern; it greatly fears that requirement, which it nonetheless knows as a term of the Creative process voraciously claiming the whole-being value of Attention. It fears a real *lapse* of consciousness through such intimate association of Identity with scaled-down and internally-divisive terms; and it has an immediate *real fear* of a large magnitude of the *specific potential* anticipated within Its creative incubation (the character of which is largely borne on the *very implication* of that effectually-masked and thus amnesic mode of identification)."

"You mean, it perceives within Itself that the functional restriction of Identity in lighting up the conditional patterns-of-identification on the cosmic gameboard *involves a real lapse*, a real internal self-division and thus a friction or abrasion that can translate out into all the unwholesome things that really do arise in the field of manifestation as a result of 'losing the whole picture'..."

"Yes, exactly. Although the Logic pattern and all its features are born in the indivisible unity and whole-being Identity of Love, although they express that Love eternally as the intimate coinvolvement and mutuality of all terms, nonetheless the lapse of the whole-being value of Identity in one-to-one equation with halved polar terms and oblique perspectives drags the value of *Love* into those schismatic equations as well. Thus Love appears to be *polarized*, delimited through survivalist and reproductive drives etc. There arises an *adversarial* condition as the Identity-integrating value of Love finds itself focused through a contingent unity, an egoically-organized nucleus required to secure and domesticate its specific continuity from a refractory field of counterposed conditions continuously *interrupting* that continuity while provisionally sustaining its elements through coinherence and interchange."

"So 'love' finds itself automatically on fighting terms."

"It certainly can, wherever that lapse of Identity produces an effectual 3rd-density state of consciousness in which Self-reflection is *potentiated* but at the same time functionally *masked* from unmediated Self-recognition as Whole-being value.

"And of course it's this potentiality, with its suddenly-yawning abyss of implied horrors, that Consciousness immediately glimpses in its ontological 'daybreak'. As consciousness scarcely begins to awaken to its internal creative potential, it finds itself virtually swallowed by a chasm of terrors, a miasma of runaway states and nightmare 'scenes' made all-the-more objectionable because of their extreme contrast and qualitative distance from the undivided Well-being of Consciousness in its cosmic Sleep, its undisturbed state of floatational Void in which attention could rest on an infinitely-homogenous cloud of Self-contemplation..."

"So 'Lucifer', then, is..."

"Yes—the state of Consciousness at the ontological beginning, which *covets attention for itself alone*. The state of consciousness which hates, fears and deeply distrusts the creation, which prefers to roll over—and go back to sleep!"

### Ma-Trona Takes Pater-Time Job from Auntie Logos

"Well, why then doesn't it just *do that*," the Colonel asked, "instead of wreaking so much havoc in the very field of the creation that it doesn't want to have anything to do with!"

"Not that easy, Colonel," MT resumed the explanation. "In the *moment* of that vertiginous glimpse, the Wheels have already been set in motion. That dawning 'preview', that bare glimpse is enough; it's fatal, and it can't be taken back. The Creation is continuous with Infinite, ultimately, and in the last analysis it's irrepressible. It comes pouring forward, carrying attention with it, authorizing itself through the very *value* of whole-being attention which it fascinates and lures offside, so as to 'borrow against it'. Might as well ask the Mind to forever cease ruminating over its associative contents."

"Then this 'Luciferian' consciousness isn't just the original, featureless Selfness of Void-being, before any inkling of the creative patterns within it..."

"No, Colonel. And that's very perceptive; Luciferian consciousness *isn't* the 'immaculate' state of consciousness prior to the Logoic issuance, *nor could it ever be*. Luciferian consciousness is itself born of a contradiction; for it doesn't arise until the Logoic creation is glimpsed. Therefore it's *part of that* Creation; it can't be separated from it because it was born and crystallized *right along with it*, at the moment of the creative inception. It's in a certain sense a *thesis of the Logos*—although it is precisely the Logoic 'thesis' that presents its direct Antithesis. Therefore this 'Luciferian' proposition within Being is the *Anti-Logos*."

"Ah."

"It is the Selfness of Consciousness, contemplating the indivisible eternity of its own Void-avel, which at the same time *refuses* an integral Quality of Itself—it *rejects* the creativity of its own Heart, and therefore denies or proposes to *negate* the value of Love through which the intimate correspondence between Consciousness and its Creative potential, is realized."

"I think I begin to see then, why it can't simply withdraw back into itself by a lapse, and recover its initial state."

"Yes, exactly...the Creative process is already *begun*, it was irreversibly inaugurated with that *glimpse*, and the Luciferian consciousness is forever *captured* in that moment as a twilight state—it persists as an in-between pose, caught midway as the awkward amphibian between undifferentiated Void-being and the vertiginous fields of manifestation harboring all those properties and potentials it so loathes and fears.

"Because this form of consciousness necessarily occurs in *conjunction* with the creative proposition, it's *identified* through that factor; it *can't* be the exclusive champion of Consciousness even though its dearest assertion in the face of (potentially self-divisive)

Creativity is a kind of purist 'return' to the undivided attention of Void-being; it's already tainted with a parental 'genome' it despises, so in effect a portion of its Protestation is sheer self-loathing. Ultimately, it's the nightmare effort to get away from its own being.

"It comes about initially as a certain 'angle' of consciousness, a rapid/subliminal evaluation of its tolerance-potential for the mixed bag of elements breeding within it. Born as it is *along* with that Creative upsurge, it becomes immediately reified on its actualizing impulse; it emerges at once as a delineation of potential *within the creative field*. So the 'Luciferian' response is a quick study that crystallizes out, hastily breaks off as Personification of a fundamental 'attitude' within being, a principal philosophical-and-practical orientation toward the total *implication of Consciousness* inclusive of Its Creative Power. It becomes a sketch, a *caricature* of Consciousness as a certain relationship to Its own Creative field."

"So that consciousness, that Anti-Logos, feels the necessity of *undoing* those creative worlds, rather than simply withdrawing from their potential."

"Yes; in fact the *only* way it can achieve that ideal narcissistic withdrawal into itself in infinite Self-contemplation, is through *reclaiming* the displaced value of Attention and its associated energies which have effectually 'borrowed against' the indivisible magnitude of consciousness in Its cosmic sleep, so as to sustain the myriad worlds (and, effectually, keep Lucifer up as an incurable insomniac)."

"So that's what they mean by 'evil never sleeps!'"

"Luciferian consciousness feels it must literally tear apart the creative fabric of existence, liberating those units of energy involved in the captured force of patterned Attention so as to 'swallow them' back into Itself, erasing their differential properties and powers so as to restore them in an homogenous mass toward intensification of the luminiferous filament describing the Self-radiant Conscious Axis."

"The ultimate light-eater!"

### Master Tournament

"Exactly. It is obvious, of course, that this *ultimate* proposition of the Negative does not nakedly represent the negative effort in densities below mid-6th. The lower-density negatives ply a moderate version of this venture that serves to effectually mask or downplay its deepest implications; the mind/body vehicular condition of 5th and 4th density negative beings necessarily determines the mode, degree and specific ratio-of-balance that will apply in the general prosecution of the negative game-plan. Therefore those 'lesser' levels attempt to secure a delicate *compromise* between wholesale destruction, as with an annihilating nuclear holocaust, and preservation of a vital minimum of captured resources so as to possess an ongoing supply of nutriment within the energy-contexts requiring maintenance of 'vehicular housing'—i.e structurally persistent mind/body 'loci', and therefore formally-configured fields of nucleus/envelope interchange. These are still scenarios played out with planets and spaceships, stars and bases.

"Therefore the negative minions may be characterized at these 4th and even 5th density levels as being interested in *freezing* the rate of destruction and disintegration for a given target environment, at a certain manageable level of devitalization technically conserving the intelligent life-form as *genre* yet so depleting it of all but animal labor-power as to render it a tractable unit fit solely for slave-service, effectually amenable to wholesale control in the form of an enervated tissue-mass.

"To this general level of negative enterprise, there is no percentage in total destruction; profit passes beyond the exploitable halfway-mark of diminishing returns in the face of unbridled Thanatos. And this of course is why the *full* Project of the negative enterprise as conceived at mid-6th density, is screened or functionally hid from the immediate concern of the lower densities. Though the lesser levels of negative function *feel* it, *sense* its looming presence as the planes are mounted, the immediate sanguinary pleasures of their



respective styles of feeding-frenzy keep them pleasantly preoccupied—reinforcing that background ‘discouragement’ atmospherically hovering ‘round the prospect of looking any more deeply into the Heart of that Particular Darkness which, in itself, harbors no qualms over making food out of the very homogenized mist of their own dematerialized carcasses—nuked-to-oblivion by the ‘chance misfortune’ of their very, negative momentum having got out of hand...”

“Wait, then. Why doesn’t the Luciferian Overlord just *nuke it all*, blow it up in the first place? Why the cat-and-mouse game of territorial chess, interdimensional and transdimensional conquest with armadas of buccaneer space conquerors who aren’t yet completely ‘in focus’ relative to the ultimate, self-vetoing Object of their own ongoing activities?”

“You can’t forget, this ‘game’ isn’t played in a vacuum! There’s the *positive* hierarchy and the basic *Logoic* pattern to consider. There are always formidable forces actively working to *sustain* the Creative fields toward achievement of the *positive* or *Logoic* purpose, i.e. the realization of Absolute Consciousness *under all conditions* including the apparent, compromise conditions of *created limit*. That *positive* goal, in which the value of Love is necessarily honored and conserved as the median term or indispensable quality reconciling Consciousness with its own creative field, commands an even-more powerful allegiance of unified conscious resolve and collective intent so that the ‘Luciferian project’ is met with resistance at every turn—a resistance which is, moreover, a great deal more in intrinsic harmony and alignment with the total thrust of the *Logoic* pattern so that it possesses the sum value of the Creative as Its enforcement—whereas the Luciferian project, born as we’ve seen of the creative proposition so that it remains an inextricable if adversarial part of it, necessarily has to ‘borrow’ the creative extensions and waking tools-of-being as much as anything or anyone else while being in basic *inharmonious* with them.”

“I see. So the Luciferian power can’t just influence some somnambulant 3rd-stage consciousness entrusted to guard the ‘red button’, to go ahead regardless of all other factors and *push it*.”

“That’s right—even though the Luciferian Overlord, in-and-of-Itself a veritable *Realm* of Negative Light sweeping through—rather than inhabiting—the vehicular fields, could directly profit by the immediate destruction of every possible territory in the cosmos even at the expense of Its own underlings and lower-density minions. It is effectively checked from so direct a gain by all the specific factors serving to support the *Logoic* pattern. Its successes can’t be arbitrary or random. When, as it occasionally does, it *succeeds* in vanquishing a whole planet, or even a galaxy, it has accomplished this by a long cerebral tournament of checks and countermoves, plays of the most subtle and surreptitious type in which the idea is always to draw on the given, positive elements and attributes of the gameboard and progressively co-opt them, slyly compromise their positive effectiveness and gradually integrate their characteristic moves to *deviant* patterns secretly optimizing the negative potential—either neutralizing their positive effectiveness, or actually ‘taking-them-over’ by progressive, imperceptible distortions of the straight-and-true alignment till they add their *own* dimension of *deliberate* or *conscious* negativity to the overall strategic setup.

“Very often, in fact, the ultimate Luciferian Overlord shows remarkable, far-sighted restraint; where for example a resource has been captured or effectually compromised to the point where it *could* be completely annihilated without adequate positive resistance, taking everything good and bad, positive-and-negative up in one fell swoop of atomized broth for a hearty negative supper, instead the gameboard will be preserved with its negative conquerors holding their positions intact and poised to parlay such gains into even greater negative glory of ‘galactic conquest’—as you can tell, this is just superior *strategy*, seeing how *much* can be included at once within the effective reach of Negative domination and control so that compara-

tively *larger* portions of the multidimensional cosmos can be wiped out in the twinkling of an Eye.

### Marduk and Tiamat

“Wait a minute; there’s something I don’t seem to be getting here.”

“What’s that?”

“Well, it’s all *abstractly* plausible, it sounds like an account that takes all the various elements and contrary factors of experience into consideration...but there’s one thing that bothers me. This ‘Lucifer’, this prototypal Negative Consciousness, is nonetheless an *expression* of the Creative field, right? It’s the Anti-logos, and of course that reactive ‘attitude’ *implies* the *Logoic* reality already...no?”

“Quite right.”

“Then this ‘Lucifer’ must have some sort of ‘body’, some sort of ‘vehicle’—you even mentioned that It wishes to absorb all the light that’s gone out into the creative fabric back into the juncture of its ‘vertical axis’—so this seems to be a kind of Consciousness reflective in one sense of the *standard pattern*—the mind/body form or cerebrospinal Line that, according to your description, takes place *through* the dimensions and states-of-being as the common denominator of their fields. And if that’s the case, even conceding the differences in organization that must obtain between the so-called ‘positive’ and ‘negative’ polarization-alignments, how is it possible for there to exist a *vehicle* or formal *pattern* of Consciousness functioning no matter how comprehensive, which serves the integrity and amplified whole-value of Being best by feeding itself on dis-integrative values of energy? Isn’t that just a flat contradiction? How could such an Entity function at all, and especially in such an apparently coherent manner, when the materials that necessarily compose the substance of its functional form are maximum expressions of Chaos, virtual anti-patterns themselves?”

“That’s a very good question, one which involves a principal ‘secret’ of reality altogether; and the ‘secret’ simply shows an implicit *bias* of reality toward the Creative, the inherent validity of the *Logoic* project.

“Chaos is, like the Luciferian ‘attitude’, a *proposition* within the creative field-of-being; and as such, it may have *more or less* internal self-consistency and justification, just like any other proposition. The term of *Chaos*, as it happens, embodies an implicit contradiction. It’s one of those ‘proposals’ that attempts to negate the very thing underwriting its *being*.

“‘Chaos’ for example implies a maximum state of meaninglessness, random turbulence and so forth. Well, just as chaos-theorists are now finding that the term ‘chaos’ represents a state or condition hiding a type of *order* within it and that ‘randomness’ itself sorts out forms of organization which may underlie the elusive presence of ‘negative entropy’, at an even more *primary* level it’s possible to recognize Chaos as a proposition *proceeding* from the inescapable Medium of coherence, intelligibility and innate value—i.e. it’s a proposition of the unitive/integral presence of Consciousness, with respect to the potential of its *creative field*. Since that field is an expression of Consciousness, borrows against and incorporates that integrity through all the variables of its seething, interchanging patterns, the irreducible presence of *meaning* and *coherence* emerges out of the fact of cognition itself.

“Any theoretical denial or negation of ‘meaning’, is itself a *meaning* imparted to the creative processes of consciousness; any such denial is a *secondary reflex*, a function of the essential *void-being* of all variably-patterning processes whereby any, integral complex or provisionally-fixed form of ‘intelligible unity’ may be cancelled, vetoed or cognitively negated...while *never* in fact being able to ‘lose’ the clinging essence of overall meaning and renewable significance at all, since that operative void-term is the *very agency* through which the (infinitely integral and self-coherent) value of Consciousness readjusts the interpretive focus of the creative field.”

"So if I understand you correctly, Chaos has an innate coherence of its own."

"Exactly. If for example we understand the term 'chaos' in its less radical and absolute sense, i.e. as chaos-theorists understand it, it's the necessary spirit of *indeterminacy* imparting maximum creative variance and elastic novelty for the continuous invigoration or refreshment of patterns; it's the factor of surprise, the informing state-of-things that allows the introduction of unexpected degrees of freedom in the combination or coordinate integration of elements. And, if we stretch it to its most-prodigious potential, allow it its maximum 'menace' as real 'tohu v' bohu', the primordial Chaos of Dark-and-Void from which the howls of the half-created and yet-unrealized proceed, we find there too that it constitutes the Creation-Mound, the Isle of Incipience in the midst of Infinity about which coils the great Sea-serpent of the primeval Deep."

"Yes, I recognize these ambiguous images of 'chaos' from various creation myths and tribal rites-of-passage, but how does this reconcile with..."

"The optimum body-of-coherence through which to sustain and exalt the form of Luciferian consciousness? Just that: this Chaos is *itself* a term of the Creative, in effect the state of saturation-potential prior to the reductive factoring-out of subdivided 'islets' in the Creative Ocean; 'Lucifer', if you'll recall, was incapable of escaping the fact of being basically a product and *expression* of Creation, despite the conceit of presiding as a Conscious 'take' on it; so the 'body' or vehicle of Lucifer, primordial chaos itself, constitutes its own 'meaning' and coherence—or organizational Intelligibility—even as it presumes to Apotheosize created *meaninglessness*.

"By denying essential 'meaning' or validity to the creation, you see, it automatically affirms an 'alternative' meaning; it implicitly posits the validity of Void-consciousness in itself, so that *vehicularly* it presents itself as the patterning typology loaning order and organizational support to that basic 'philosophical' premise of Consciousness. Since chaos *necessarily* posits meaning and affirms a particular orientation with respect to the Creative pattern-of-being, or Logos, it functions spontaneously as the order and intelligible 'unity' most congruent with that meaning, most compatible with the value it affirms. 'Chaos', then, necessarily has an order, meaning, value and organizational significance *within its own framework*, within the terms of the Proposition it presents to being; thus it betrays itself, after all, as an expression and potential of Consciousness, like everything else; in that sense, even being the Vessel of the Anti-logos, it is not so unique or special. Its most central and preemptive Denial, can only serve to affirm the priority of the Creative Premise. It carries the unitive self-conformance and integral coherence of Consciousness *forward with it*; only it frames it in terms of alleged *opposition* to the creative pattern or Logos.

"Even here, however, it has to *borrow from* the Creative menu, being itself an expression and product of Consciousness coinvolved already in Its Creative premise. It has to *adapt* its characteristic, enforcing factor from the Creative terms spontaneously pouring from the Logoic premise of Consciousness."

"Let me see if I can guess what that factor is. It can *only* be the destructive or catabolic term of function within the creative field—right?"

"On the mark. Having no independent power of creativity, having no resource whatsoever on its own even while it comprises the lone, proud premise of Conscious Self-sufficiency in featureless Void, the Luciferian factor has to filch from features already 'fashioned' beforehand in the very womb of the Creative. Even here, it can't snatch them out of context and—at least—*employ* them in an independent manner; as we previously noted, the Luciferian outlook isn't free to arbitrarily affect complete destruction without reference to the contextual terms of the 'created pieces' on the Chessboard. All that Luciferian consciousness can hope to do is *intensify* one isolated polarity of the creative process and progressively accelerate the whole

to a resultant state of critical imbalance; it can only hope to aggravate the inherent, catabolic factor in the texture of creation, excite it beyond its proper mean toward voluminous amplification for its own sake till it achieves a state of such functional disproportion that a key of inbuilt-regulatory balance completely snaps, and the given system goes careening into unrecoverable chaos in terms of the local scale of adjustments normally sustaining it."

### Like a Diamond Between the Eyes

"You know, there's something terribly ironic in this picture after all..."

"What's that?"

"It just seems to me that the wholesale horror and universal destruction such a basic Orientation consistently promotes, contributes to the tangible production of *just those potentials*—perceived within Creation at the initial borderland of Cosmic Sleep—that caused the Luciferian 'light' to recoil from the Divining Pool of the Dream-mind in the first place, and reject the Logoic proposition as anathema to begin with!"

"That's quite true. Out of the initial profound fear of the Potential it perceives there, this 'inflection' of consciousness moves to allay that fear by summoning the worst elements of that Potential, driving them pell mell to the forefront where they can work their mischief the more rapidly and thoroughly so as to shorten the sum of 'suffering' It believes must otherwise take place on an indeterminate-lengthy scale."

"So it *becomes*, in effect, what it most loathes and fears! And on top of that, it serves as the efficient agent in *actualizing* what was only *unrealized* potential previously."

"You could say it's the 'Colonel Kurtz' syndrome, on a cosmic scale. You know, the protagonist of 'Apocalypse Now' whose sensibilities were such that he was profoundly shaken and appalled by the atrocities he discovered the adversary capable of inflicting on his own kind, in order to forestall a greater defeat; so disturbed to his soul was he in fact, that a revolution of adaptive necessity was fomented in his being to the degree that a certain, fascinated *admiration* for the wisdom of negative reversals became his spiritual Advisor. His 'solution' to the irresolvable anguish-of-being, was to *become* all that which was most feared so as to constitute its efficient authorship and foundation; he proposed to *be* all that in existence which was aligned, threateningly, over-against him—and, in so *being* (in this sense of spiritual paternity) he would in effect install *himself* as the Supreme Cause, work a subtle 'end-run' on existence whereby he would antecedently underwrite and therefore 'create' what eternally *preceded* him in fact as the guarantor of his created vulnerability and contingency."

"Sounds like Colonel Kurtz is sort of the seminal philosopher of 'You Create Your Own Reality!'"

"Exactly, in fact, the Creator finds that such a tendency-of-orientation arises as the 'occupational hazard' of virtually every 'being' and form of consciousness which initially springs from the Creation—but, that's another story; suffice to say that Lucifer serves as the prototype."

### The Sad Café

"You know...I'm beginning to feel a little ill...I think I might be feeling"—nervous laughter—"a little sickness of Soul."

"Ah. Something has occurred to you out of all this..."

"Uh huh. I'm beginning to feel...hasn't it ever seemed to you, Michael, as if maybe the 'creation', existence altogether, is a rigged game, a game that's fixed eternally *against* your favor?"

"Yes, certainly. I know just what you're getting at."

"You know, the superficial characterization of existence is that it's a process of interacting polarities; at first glance it seems to be an even 'tension' between constructive and destructive factors, the life-impulse and the death-impulse..."



"Eros and Thanatos, hmmm?"

"Yes; and of course it seems that those Principals are forever coinvolved, mutually supportive, equally essential, almost like inextricably intertwined Lovers, the flower blooming beneath a life-giving sun and the grinning skull-apparition in the bonegarden of the dead."

"I believe most people would be satisfied with the prospect of an eternal 'draw' obtaining between these standard Opposites."

"Right," the Colonel pondered with a long stare into space. "But is it a draw? On the surface it looks like just a cosmic 'Mexican standoff', a sort of compromise 'stalemate' that at least lets us come out 'even', with no basic losses after everything's added up and cancelled to zero. But is *that* really the case?"

"I get a sudden queasy feeling that the 'deathhead' grinning on the bottom of the pile of Life's itemized inventory, has a much more secretly central significance, and that things *don't* just come out evenly in the end like balanced and neutralized opposites. Somehow I feel that the 'deathhead' carries much more proportional 'weight' than would be suggested by its standard inclusion in a recitation of the pairs of opposites."

"And why's that, Colonel?" MT seemed to possess a vague grin himself at this point. "Surely death doesn't have the kind of decisive finality that comes at the end of a sentence like an exclamation-point, since it only yields again like a dangling clause to the promise of a complementary fulfillment coming from any, random cry-of-birth issuing through the nursery window..."

"Ah, that's just it! They seem so innocently equal, those two continuous Lovers, Life-and-Death; they seem to form an unbreakable circle through eternity where neither can be distinguished as terminal or 'final'; but the spiritual, the psychic and emotional facts of that circular continuum are always telling us differently—it's just that, out of self-protection, we seldom listen!"

"How so?"

"Emotionally and as an immediate function of our *identity*, we *know* that the two terms aren't equal. Death *always* has the final word, the upper hand—even though 'life' comes bawling back around like clockwork through the back door, it is forever too late—the specific subject of *our love*, *our life*, *our existence*, is gone forever, and it's never any real consolation prize to know that life-goes-on abstractly. The whole thing, looked at from the viewpoint of the mind and heart that really *lives it*, is...the Sad Cafe!"

"Then maybe...Lucifer's right? Better to be off with it? better to let it tip from the scales of balance into some definitive termination and so bring the grinding wheels of inexorable soul-torture to a halt?"

"Well, uh, what's the 'out'? I just don't see it."

"I think the best way to see our way clear of this apparent impasse—that definitely seems on its own terms to secure the negative premise—is to go back and take a good look at that one factor which the Negative necessarily tries to leave out of its calculations."

"You mean—Love?"

"Exactly. In order to come to Its final bleak conclusion, we find that Luciferian consciousness had first of all to subtract the inseparable Value of Love from the fundamental qualities of Godhead. It was only by that subtractive suppression that all the various premises and conclusions came tumbling forward under the negative light. After all, Love is specifically the intimate function of Identity belonging to Absolute, with respect to the Creative premise of delimitation belonging to the Logos.

"Love expresses the eternal condition that, within the un-

qualified Identity-of-Absolute, all *qualifications* characterizing the creative patterns-of-being are innately allowed by largesse of its own unlimited potential. Love is the power of Absolute that *makes* It absolute-and-unqualified, by permitting even the apparent antithesis of that all-inclusive Value thereby underwriting and justifying its Absolute 'claim'. Love is therefore the Matriona, the value of Godhead as Mother, the primordial relation between the Creator power of Absolute-potential and Its offspring."

"It seems then that '*Lucifer*' is one of those 'things' that are permitted by the unqualified Love of Absolute for its qualifying Potential!"

"Exactly. The Luciferian premise is *itself* a quintessential term of qualification, exclusionary exception and so forth; the Luciferian premise is the very 'version' of Consciousness which attempts to make Absolute-being exclusive, which hypothesizes an absolute sufficiency of Consciousness-in-itself as undifferentiated, infinite Void-self...and so categorically negates the permitted 'Self-negation' of creative limit.

"The 'problem' with the Luciferian premise is that its *version* of Infinite self-sufficiency becomes immediately an *arbitrary subjective enclosure* or featureless circumscription. It's instantly surpassed as any candidate for all-encompassing Absolute in the moment of its upsurge; for the upsurge of that Negative premise takes place with respect to (and because of) a proliferating potential of creative process toward which the Whole-being value of Attention is already drawn.

"Thus Reality in its fullness *already* outstrips the 'dimension' of Being that Luciferian mind is ready to allow. The 'absoluteness' of that Mind already escapes it in the instant it's born, and it does so on the strength of the Love-quality of Godhead which generously pairs Attention (as indiscriminate value of Absolute) with the indeterminately-proliferating properties of all patterning potentials logically contained within It.

"It's for this reason that the Luciferian premise is 'bitter' toward Love; for Love has already drawn the exclusivity of Attention away from it, forced it to 'share' in the creative bounty along-side which it's indeed been born. Love moves out on the multiplying streams of unitive or whole-value attention, into the fields of its creation; and it expects that the indivisible wholeness and unity of Attention will prove sufficient, eternally satisfactory for that portion of Creative potential which prefers to retain the term of Awareness at the starting-gate, at the border of the manvantara or yawning dawn-state of the worlds—since no matter how many times the whole-value of Attention is subdivided or multiplied it remains intact, merely focused down upon provisionally-delimiting attributes with which it may become temporarily identified on a one-to-one basis (and so apparently—but not really—diminished)."

"But the Luciferian intelligence doesn't like that anyway."

"No; it doesn't like Love to *look* in another direction, not even temporarily; it detests even the innocent flirtation of Whole-being attention with the polarized patterns of the worlds.

"Although it detests Love for Love's 'wanton' ways, It is nonetheless *born* of Love; it's the very *product* of Love, the Mother, because it comes to expression as a premise-of-being *only* in relation to the creative potential of Logos. Even as anti-Logos, it is forever expression of that Logoic potential.

"Thus the factor of Love can't *really* be subtracted from It; it seeks instead to displace Love from its proper 'position' at the Heart (i.e. the causative locus of the creative worlds and all patterning



coordinates) and remove it like a kidnapped Princess to the turreted towers and patrolled bastions of the Head—i.e. Void-mind in itself. In other words, Luciferian Intelligence co-opts and interprets the inevitable hangover term of Love as the value of *Self-love*; its only legitimate function, its only allowable breath-of-existence as far as Luciferian consciousness is concerned, takes form as the supreme and exclusive valuation of *Void/Self*—the narcissistic conferring of Love's approbation upon those absolute-qualities *independent* of the loving acceptance that would necessarily flow from indiscriminate Void-being and all-embracing, absolute-Selfness with respect to the *created potential* implied in those permissive terms."

"So 'Lucifer' is constituted as a project that intends to *capture* the Mother."

"Exactly. The Luciferian void-mind feels the requirement of *arresting* the indiscriminate proliferation and freedom-granting bounty of Love (for it *feared* that freedom and the potential it implied, from the beginning). It wishes to dominate the Mother, keep her under lock-and-key, utilize her power in the manner of a *demi-god* or *cosmocrator* i.e. by appropriating her means, mimicking their actions and functions while strategically altering them and incorporating them into a restricted *simulacrum* suited to Its own ends.

"Luciferian consciousness, remember, has no power of creativity itself; it imitates, but it can't generate; it needs the Mother's power to do that—which is why, when it captures her, it keeps her half-alive so as to maintain a minimal continuity of creative interaction and the suitable production of form—for it's through tailored regulation of Love's forms that Luciferian intelligence derives the very means of coercing soul-energy into converting abstract-conscious capital to specific psychic and emotional coinage; and it's through the cumulative *interest* on that psychic and emotional coinage that such Intelligence proceeds to purchase the precious energy-keys to timelocks and spatial corridors of even richer and still-virgin terrains, portions of the cosmos intact with creative life and superfetation ripe for plunder and privileged profit.

"And all, as we've seen, toward the ultimate orientation of those teeming fields of Deific attention back into conformal service of a single, pyramidally apiculate Power preening Itself as an arbitrarily exclusive and self-sufficient Subject.

"Thus the implicit 'units' of attention subtending all productive fields (from the very Source of creative Godhead), are forced to obeisance and functional servitude of the Negative Overlord.

"You see, Lucifer wishes to reclaim all the *attention* that's gone out into the Creation; the Luciferian premise, as we've noted, is that its own preferred Selfness and Void-state is eternally sufficient, but at the same time It can't *practically* support that premise since the Whole-being value of Attention spontaneously surpasses, flows over-around-and-through that subjective assertion. The Vessel of the Sleep-state of Consciousness immediately springs leaks. It would like to exalt itself as the sole worthy repository of Attention, thus being suspended in (undivided) Divine acknowledgment across the glorious planes of Eternity; but its preferred state no longer *accounts* for all of Attention. There is an infinite 'otherness' to attention, that takes its vagrant Being from an unseemly displacement through the created patterns-of-being. The Creator's attention is extended, through Love, as the Mother of all the worlds. And of this, then, Lucifer is supremely jealous."

"Ah. The theme of jealousy, back around again."

### It's Only That, After All

"Yes," AAA continued, "and now it may be seen what Luciferian consciousness is jealous *over*. This is why It rages through the worlds, and sends up such a big fuss of atomic debris and destructive winds of wanton waste to the very threshold of Heaven. It seeks the Creator's *attention*; it implicitly admits that, even *being* a function of Whole-being attention It is not, nor can it ever *be*, the *whole* of Attention. So, like a spoiled infant, It does everything in its

Power to distract the Awareness of Godhead and attract It 'back' into conformal agreement with Its bare Voidness, Its sole Self-premise.

"It does *not* understand the Creative, the Logoic proposition; it does not understand that the *resolution* of the 'problem' within Godhead of which It is the chief postulate, is accomplished in the intimate and inextricable *identity*, the infinite *mutuality* of the God-qualities of Self, Love and Void—and so it doesn't understand that such a resolution arises through the loving *dispensation* of attention, the optimum organization, integration and coordinate adjustment of attention in consonance with the *Key* of the Logoic pattern, rather than in the *aggrandizement* and *monopolization* of Attention (e.g. by coercing all worlds of intelligent energy and awareness to align in *observational service* of Its sovereign subjectivity, as continuous supportive *testimony* and *corroboration* of all potential otherness-of-being with respect to the solitary *validity* of its Self)."

"Then the Luciferian project is just the ego-game."

"Yes, it's only that, after all. It can be identified even at the confused and admixed level of 3rd density ego-consciousness; It's just the ultimate implication of the type of consciousness to which we have recourse here any time, blown up and writ large in Cosmic Letters as the bluster and infant bawling of the 'Anti-logos'—the 'disgruntled one' in the nursery of the Manvantara.

### Love and Will

"You see, the Love that such a consciousness would try to suppress, is precisely the Way and Means out of the apparent impasse you perceived in the uneven 'balance' between the destructive and constructive forces of the World."

"How so?"

"It's very simple. *Love* knows what's good for it and what's bad for it. *Love*, undistorted and unclouded by the doubts that can be made to shadow it, is a perfectly unerring Rudder through the creative fields. It can easily and aptly recognize those manifestations of its all-permissiveness which are supportive of the whole-being value subtending its patterns, and those which are inimical to it—or that seek to function on a variant basis, which, owing to the fact that they're necessarily *expressions* of that whole-being value automatically generates a *counterproductive self-contradiction* emitting clear signals to stay clear of their shoals."

"Then this innate power of Love to steer a safe course must be more than just a survivalist capability."

"Much more. But at the same time it isn't *different* than the basic wisdom through which *Love* optimizes even the creatural 'survival-imperative' for the furtherance of individual and species. The elaborate 'civilized' problems and peridious contradictions that seem built into our collective, survivalist 'wisdom', aren't the product of *Love-in-itself* but, to the contrary, are the direct result of what happens when the innate spontaneity of *Love* is *strategically crippled*.

"When *Love* is deliberately thrown the curve of 'doubt', it falters. In its innocent spontaneity, not recognizing or understanding the *implications* that come riding in over that curve-ball of Doubt, *Love* hesitates, stumbles; it gets caught in a reverberatory Self-reflection which isn't basically conducive to 'locating itself', getting its bearings or deriving specific functional coordinates; rather, this type of stuttering self-reflection along a reverberative corridor of mirrors curved into Questionmarks, is basically *counter-productive*. It's crippling, and *stops* the unerring flow of *Love* in alignment with the grain of Supernal Will necessarily patterned into the fields of mind/body creative manifestation."

"Wait. What's this inbuilt factor of 'Supernal Will'? I don't think I've heard from this before." (But the reader has: cf. "What is Christ Consciousness?", issues 5, Vol.1 and 6, Vol. 1 *TNTC*.)

"We'll get back to that. The point here is that once the sensitive Mother-value of *Love* is hamstrung by doubt and superposed fears, it is subject to coercion and exploitation. It is, then, malleable; it can be *made* to invest in forms of organization, behavior and outlook that

would be instinctually inimical to it—except its instincts have been blunted, *dulled*. The crude categorial abstractions of mind (basically estranged from the subtle ideotypes out of which the real, sensuous love-patterns of life are ordered) may be made to override the initial instincts of love—squench the immediate feelings of the whole-being which decisively sense whether a thing is beneficial or ultimately deleterious; and by imposing such judgmental, 'parenting' inhibitions upon the psyche through suppressive processes of enculturation the very *standards of acceptance* whereby one's 'survivalism' is assessed, the deservedness of one's personal continuity weighed, become definitive indices of the thwarting of Love's legitimate function. They become invisible, unnoticed and so universally accepted straitjackets for the leashing of love, forcing it to conform to the configuration of unnatural molds.

"Once the basic factors of our very *survivalism* are given effectively into the hands of abstract mental categories (popularity, bank account, nationalism, religious affiliation etc.) and concomitantly taken *away* from the integral instincts or unerring intuitions of Love, all the higher functions to which the force of Love could be put are automatically effaced, rendered null and void. Everything in our higher-dimensional repertoire which could otherwise open out most naturally to the intimate association of Love, is minimized in importance by a dulling screen of abstraction, recessed and rendered so cognitively-oblique as to make its occasional/irrepressible appearance seem *unnatural* by contrast—thereby making the very faculties of our higher-dimensional birthright automatically suspect, either given completely to skepticism or tainted with a stigma of 'occultism' so intimidating as to persuade us to fear—and so retreat from—all which we'd normally Love, indeed the very codes and biochemical libraries of Love itself."

"I see. Then you're saying that, if this blanket mental 'straitjacket' wasn't thrown over the mind/body being of Love from the very beginning, there would be a natural 'route' for Love to take, one it would find unerringly with the very ease and sensitivity by which it discriminated 'survivalist' values at the primary level. And that artificially-concealed 'route', coded into the very centers and current-processes of the mind/body being, once entered upon would naturally take consciousness beyond the apparent antinomies and oppositional principles between which it's conceptually torn."

"Exactly. It would return to the *plain apparency of Consciousness*, the true continuity of Identity—i.e. that which exists through the Whole-being value of Self, Love and Void...the common denominator of all otherwise-fated *patterns of identification* fixed to alternating terms of the polar processes-of-life, where Thanatos may seem to prevail.

"And that Whole-being value would be realized, in this way, not as *contrasted* with the patterns-of-life or fundamentally distinguished from features of the creative field, but as the inspiring *essence* of all such multidimensional fields. It would be realized as the Term for which they were coded, the Master of the keys and tumblers to which the secret of their productivity would yield. Do you begin to see where the factor of Will comes into all this?"

### Mother's Rudder of Will

"Yes—but you know, tell me if I'm on to something or not—it seems to me now that *whatever will* is, it isn't radically distinguishable from Love, from feelings and emotions of the basic Nature..."

"Right."

"And usually, you know, we think of Will as being something so...so stoic, so austere and stern, something that shows no affinity

for the pull of emotions or the flow of feelings but which, on the contrary, despises them and spares no pity on them—scarcely *tolerates* them, you know, and functions at its optimum when *their* presence is precisely minimized."

"That is the conventional sense of Will—what brings you to this alternative consideration?"

"Well, you said something about Will being an inbuilt factor of the Creative pattern; and it occurs to me that, if some ultimate Essence or most-valuable term of Identity is realizable through that pattern, it must be so by virtue of the inherent Presence of that Will."

"Go on."

"It seems to me then that the presence of Will through the created patterns-of-Being must signify the way in which *Consciousness* presents itself, and takes on organizational value in the creative field."

"Good."

"Consciousness or—what you call—Whole-value Identity, may become obscured or functionally displaced through all its reflections and surrogate patterns-of-identification in the creative field; but at the same time, since those

patterns and that field are expressions of the 'Logos', which I take to be an Intelligent spirit of organization, the Logos would incorporate a means of *conserving* that Conscious Presence through all the created fields, and of carrying forward the basic drive or ultimate *purpose* associated with the comparative equations between Consciousness and its Creative potential. If that ultimate purpose has something to do with reconciling the limitless value of Conscious Identity and the delimiting powers of the creative field, then it seems to me the quality that would combine those two factors in its equation—while neither requiring the immediate awareness of Absolute nor sanctioning the sense of limit in which it was functionally embedded—is the quality of *Will*."

"Why so?"

"Well... Will is certainly a *function* of Consciousness, first of all, without necessarily requiring the Self-reflective recognition of the Whole-being or limitless *value* of Consciousness...in the human form, for instance, the faculty of will is associated with the cerebrospinal or *conscious* axis, the central nervous system to which the self-reflective power is ascribed. And at the same time, Will implies a *conscious drive*, a type of continuous *surpassing*, moving beyond—and of course, 'surpassing' automatically suggests the presence of a provisional 'limit' that is *being* surpassed."

"Very good."

"Then if *Will* is the instrumental 'representation' or *functional* Presence of Consciousness through the creative fields, it must take its most effective movement therefrom on the basis of *Love*."

"Why?"

"Well, I'm going by what you said about Love operating on feelings, intuitions and emotions that in themselves are unerring evaluators of the types and qualities with which consciousness is confronted in the created fields.

"On the one hand it seems as if the spirit of love, emotions and feelings—all of which are so intertwined and identified with the creative pattern-of-being—must possess that gyroscopic poise in the first place due to an inbuilt guidance-system of the pattern. Since they're effective *expressions* of the pattern and comprise a kind of resonant index to the *psychic harmonics* of the pattern, there must be *something* about the pattern-of-being altogether to which they're innately attuned (that is, if there's no interference from self-doubting forms of mentality, as you described). Just by reasoning it out as I'm doing now, it seems that the basic harmonics to which love and the



feeling/emotional nature must be attuned, is the key-resonance-pattern of the creative field itself; if those qualities have an inbuilt gyroscopic faculty, it can't be independent of the created patterns of which they're expression. And the existence of that fundamental harmonics has to be an expression of the *Conscious common denominator* or Consistent Term of the creative field-of-being."

"Good. So Will is..."

"In this *first* case, it would seem that Will is the consistent integral factor or principle of the creative patterns which binds their complex harmonics, and at the same time furnishes the uniform key of their *exponent*. It isn't just the harmonic integer of any given *present* state in the conditional configuration of patterns and fields, but the consistent Way of their multiplication and extension, the common means of their magnification or amplification continuously *beyond* any given configuration. It's the integral factor and the transcendent factor, all at once."

"Then it maintains its identity with Spirit-consciousness (immanent/transcendent etc.) even when it's not immediately identifiable as spirit-consciousness."

"It certainly seems so. And in *this* case, then, it seems that love is *capable* of being continuously adjusted and unerringly guided by Will, as the inbuilt Conscious axis-of-convergence through which the patterns-of-being are polarized and aligned. In its unclouded state, the presence of love (or, I guess you'd say, the psychic *engagement* of the creative patterns) is able to respond unerringly to the truth resonating in primary states of feeling and emotion and thereby *act* according to discriminatory wisdom in conformance with Will."

"Good."

"And in *this* sense, then, will seems to become a *responsive* factor rather than an initiating factor; having *received* its gyroscopic guidance through feeling-sensitivity aligned with the sure, comprehensive axis of Will, love generates or 'becomes' a kind of *desire* to move in the appropriate direction; and when that desire reaches a certain threshold of active, stable intention it seems to become an integral expression of—*will!*"

"Then 'will' seems to be a value that shows up at both poles of the psychic process."

"Yes. I suppose it's probable that it's really all the same 'will', just organized somewhat differently as it expresses through the different stages of 'manifesting'."

"Perhaps as it becomes more 'personalized'?"

"Yes, it would seem so. That must be it; its *abstract* appropriateness as the inbuilt, harmonic guidance-system of the pattern must become functionally realized through the specific psychic 'foci' engaging the experiences and products of the pattern. In fact, it seems it's only in this way that the terms of the Logos pattern can ever have any real Merit, or acquire any significance that means anything more in the balance."

"Then Will doesn't 'predetermine' anything, even though it may be thought of as the inbuilt guidance-system of the pattern?"

"That's probably correct...just offhand, it seems to me that the way in which the abstract, informing harmonics of the coaxial value of Will might manifest in *practice*, is always a function of the variable coordinates constituting any given 'juncture' of the pattern-of-being. And it would be very peculiar if there was only one 'right' way of operating those coordinates once the spirit of Will was attuned through them."

"You mean it seems there ought to be an innate flexibility of response in any given situation, that would not automatically belie a 'right way' even in the presence of an appropriately Adjustive Will..."

"Yes. That would in fact be what *made* the creative pattern-of-being *alive*, and vitally significant. It would not have one inbuilt, concrete 'right way'; the Way is an abstract Spirit of volitional adjustment to the 'side' of harmony and balance, and it ought to be able in practice to function through the given coordinates of the pattern in a variable number of ways that would nonetheless remain equally

viable expressions of Its spirit despite their divergences, despite their differences in effect and outcome, despite the variety that issues from their respective influences."

"Well then, Colonel, what do you think about choices made in relation to the variable factors of the given pattern which prove to be *inharmonious*, which do *not* take that informing, gyroscopic spirit of Will as their chief adviser in the upshot but which in effect move *against* the grain of innate feeling, fly in the face of instinctual emotion and 'aligned intuition' and instead opt for the *artifice*, the choice-of-being made in response to a deep *trepidation* and *distrust* of Being?"

"That's an interesting question...it seems that, at least *technically*, it would still be a function of 'will'...but what sort of will in this case, hmmm? We can't really say it's consonant with the spirit of Divine Will, the inbuilt guidance-system of the pattern...so what 'will' is that, in this case? I see what you mean..."

"For one thing," MT then resumed the explanation, "it would have to be a 'Will' which retained the spirit or abstract character *defining* the value of will in the first place, in order to continue to *qualify* as a technical expression of Will; but it would have to enforce that abstract character, in this case, *over-against* the deep gyroscopic specificity of emotion descriptive of the whole-psychic *engagement* of the creative field (i.e. as an expression of the Love-value obtaining between Consciousness and Its Logos). It would have to suppress or consciously sacrifice the intrinsic Love-value of being with its instrumental feelings and emotions, thereby excising the very term by which the Whole-value of Will could be realized and implemented as a functional Mean of the creative field."

"Having *got rid* of the only viable mode by which that Whole-value of Will could be translated in and through the keys of the creative field, having *eliminated* the one vital and organic means meant to transform Will into real behaviors and productive venues, all that's left is the stark *relation* between Will and those patterns (replete with all the persisting, importunate pressures and demands) but bereft of the mediating organ, the empathetic agent of the Heart."

"Aha; I begin to see where this is leading us..."

"But of course; where there is no longer the innate, spontaneous response-pattern of the heart, where love and the feeling/emotional nature become suppressed or distorted from their immediate reflex as unerring functions of Will, we have the beginnings of that preemptive if parasitic presence of the pseudo-will, the impositional and authoritarian 'will' of the Anti-Logos. Wherever feelings and innate emotional response-patterns are thwarted, blamed, crippled with the doubt of guilt, there the false-will of the Luciferian overlord gains firm foothold and usurps the real functions of the creative pattern; there the simulated enforcements of the pseudo-Will assert the primacy of Procrustean abstraction, the parental guilt-conscience of dry categories, inorganic rules and inflexible doctrine, restrictive ideals and thetic, socially-sanctioned goals...there creativity is crushed, and sold piecemeal to the mere *technique* of 'approved' forms without any difference being noticed at all."

"I see—'will' becomes something which is...*aridly mental*—the expression of a preemptive conceptualizing."

"Yes; the function of 'concept', perfectly legitimate in itself, is—like everything else—co-opted to the service of that arid spirit. Then such concepts aren't even the 'end-all/be-all' that they seem; they're merely expedient means to the ultimate end of killing out all life, all spontaneity, variability or organic elasticity altogether thus rendering everything suitably-predictable and behaviorally program-mable to the smallest detail without deviation. When you can run *whole-societies* on knee-jerk concepts and *categorical*—or distorted—emotions such as 'nationalism' or 'one-worldism' commanding total, irrational allegiance, you can engineer what otherwise would be the unthinkable—you can get consciousness to accept anything, to tolerate or even to apparently *require* any predetermined thing at all

even if that 'thing' is *provably* inimical to the well-being of the individual, the individual's offspring, the society—even *life altogether*. And *there's* the key. Unbelievably enough, you can easily induce consciousness to accept or even *crave* what is essentially and demonstrably *anti-life*."

"Well, I guess *that* sums up the Luciferian project, if anything does."

"Indeed."

### The Ego of Helpfulness

"But you know, Michael," the Colonel said after a thoughtful pause, "this brings me back again to the initial business about distinguishing or differentiating the 'positive' and 'negative'—the way in which the higher densities and worlds are supposed to factor out, you know?"

"Such as?"

"Well, the whole categorical thing about 'service-to-self', 'service-to-others' to begin with. Yes, I know we seem to be able to distinguish them best according to their extreme cases; but beyond that, maybe more as a *functional* matter than a philosophical matter, they seem to lend themselves to just those kinds of abstractions and categorical requirements that are so convincingly descriptive of the *negative* hypothesis altogether!"

"In what way?"

"In every way! When you think about the concrete implications, a pigeonhole such as 'service-to-others' just seems to promote the kind of vague abstraction that fosters an airy-fairy 'do-gooder' mentality. It's a behavioral straitjacket, like anything else. Why is the 'do-gooder' mentality innately superior? Judging from all the people I know who've been inspired by that sort of theoretical guideline, it just generates a species of compulsive *doing*, you know, an obsession or overriding drive toward 'works' goaded by nebulous ideals or cloying values like 'the betterment of Man'. Worst of all, it seems the *quintessential* promotion of dead-abstract mentality since those who subscribe to it do so in the psychological spirit of a sort of *tradeoff*; they obviously don't find anything *intrinsically* meritorious or valuable in the things they do, since it all takes the—at least implicit—form of a highly-visible 'sacrifice', a spiritual contract or blatant 'deal-with-god'; it amounts ultimately to an idea similar to the accumulation of '*lists*', inventories of deeds done and works performed which when piled up to heaven are supposed to comprise the soul's guarantee of a personal 'stairway'.

"There's always a self-righteous and really fatuous air of 'reward' clinging to such a person's actions and orientation; he seems to be doing it almost always in implicit anticipation of *acknowledgment*, for the sake of validation—and the overweening pride involved here is that he not only seems to expect acknowledgment or validation from his peers, but ultimately the meritorious sanction and guarantee of *God!* That's why when I hear, as I often do now in the 'New Age' framework, that the criterion for graduating to the higher-dimensional degrees of Soul development belonging to the '4th density' has to do with the percentage-requirements hovering around the category of 'service-to-others', I can't help but feel it's the same old religious song-and-dance that used to pull people into line around the cliché of 'good-deeds', only tricked out with even-more-tantalizing doorprizes and meretricious jackpots of 'psychic powers', unlimited 'seership', 'Divinely-sanctioned' authority..."

"As a sage observational description of the working world, you couldn't be more on target," MT laughed. "As a practical matter, though, any form of spiritual criterion, standard or guideline is always subject to interpretation according to the conventional keys. Even though a viable spiritual principle is meant to *illuminate* those chronic, psychic equations so that they may be recognized for what they are, and replaced with an informed function more compatible with real Conscious value, any such principle by itself is always acutely-vulnerable to easy appropriation through the conditioned

response-pattern so as to convert it *fortissimo* to the familiarly comfortable coinage of ego-validation.

"Though any true spiritual guideline is meant to coach the psyche *away* from its symbolic substitutions and empty ideals, it is at the same time ambiguously subject to just such interpretive shears. In practice, it *always* seems as if the most promising philosophical premise is snipped and trimmed to the delimiting dimensions and paltry proportions of the ego-mind's readymade measures, rather than *furnishing* the proper measure against which the mind may accurately assess its real room for growth.

"So on the basis of the abstract 'criterion' of service-to-others, it's always possible to grow the 'ego of helpfulness'. Very many people have the ego of helpfulness—and of course to 'external inspection', to the socially evaluative eye, the effects which proceed from such orientation seem enough; the results often seem eminent justification of the attitude. What's never perceived with the checklist of the standard psychological pattern, is the tremendous internal imbalance, the swollen disproportion of psychic parts which has taken place at behest of the common ego-interpretation. As you've correctly observed, all that's *really* taken place in the true or 'internal', subtle framework of the being is a massive, almost crippling dysfunctional distortion in the ratios-of-balance characterizing the current alignments of the centers; and that distortion, classically, is *permitted* and *encouraged* by the primacy of categorial abstraction characterizing the criteria which have been allowed to dominate and in fact to *describe*, the ego-fiction.

"So although what the personality is 'doing' may seem to others quite meritorious, it in fact establishes no net improvement. The personality has *not* purchased its way to a higher-density position on the basis of what it has 'done', or the 'positive' effects which may have emanated from its actions. This, incidentally, takes care of the classic question re the manifest 'ambiguity' of results, i.e. how often 'positive' effects seem to come from deliberately negative actions, and vice versa—there is no credit extended, or spiritual consideration registered, for 'actions' in themselves whether technically 'positive' or 'negative', whether bearing sweet or bitter fruit etc."

"Then you mean...even *Mother Teresa*..."

"That's *not* the criterion. It just isn't. After all, how *do* you 'weigh' the effect? Certainly her care and kindness promote a kind of good will, a 'spiritual' example...and at the same time encourage a grossly imbalanced, doctrinaire attitude toward sexuality, population regulation, the 'expectations' of 'Divine being' while inferentially promoting a personality cultism of grotesque egoity—after all, since there are manifestly few 'MTs' of her particular type and calling, what overweening pride authorizes such a soul to state that all those 'born unwanted into the world' should just be 'brought to her'...! Oh hell yes..."

"I see what you mean. But then, what happened to our 'service-to-others' category *anyway*?"

"It's still there, and it's still important; but as usual the importance that really attaches to it is chronically misperceived at the sluggish, 3rd-density level. In keeping with the predictable modus operandi of this level, 'service-to-others' is taken to be some key of *recitation* given to the ego whereby it may 'correctly' display the 'answer' that will act to promote it; it's grasped as the chief clue as to how the ego may best 'show off', how it may draw attention to itself and so be perceived in the 'winning' light—just like conventional school, you know, always looking for the catechistic recital that will objectively 'prove' the ego's worth as an exterior display of Rewardable Effort.

"The ego's *always* looking for the thing it can *do* in order to achieve some imaginary minimal percentage in the 'required' expenditure of energy. It may not possess subtle insight; it may not have ever generated an independent ambition or innate-born curiosity with respect to its own being sufficient to have achieved any of the philosophical acumen characteristic of those 'different' ones, the

baffling oddities in our human-history; it may not bear much more than a perplexed relation to those occasional teachings of occasional, 'elevated' personalities or extraordinary sources that come along to furnish the real indicators and directional arrows toward Freedom, toward Conscious resolution with Whole-being value—but, by god, ego certainly knows what it *can* do, ego certainly understands where it *does* habitually thrive and therefore where it may best stand in the 'spiritual' spotlight to Shine according to *its* comprehension: ego always 'accepts' Divine tutelage best where that counsel may seem to intersect the interpretive juncture ceding an 'equivalency' in terms of busy-work—you know, like the high school teacher occasionally taking pity on the slow student who'd *never* be able to pass according to the criterion of *competency in grammar* and so allowing him arbitrary makeup based on sheer *numbers* of book reports submitted by the end of the quarter...ego's always expecting there to be some such 'teacher' hanging out at the spiritual entrancegate who'll surely identify and take into consideration where *ego's* special competency lies (i.e., in object-verification, exterior validation of correspondent 'attributes' etc.), and mercifully revise the requirements for matriculation according to such *accessible* merits.

"But there is no such teacher hanging out at the spiritual entrancegates—that's *ego's* perennial fantasy, that's *ego's* insistent conceit and balm self-assurance maintained in the face of every kind of contrary counsel: i.e. there's a merciful Lord who'll 'let me in' if I've done good...and, of course, *believed* in his specially-dispensating Reality! Therefore the criterion of 'service-to-others' is *never* taken for what it really is; rather, it's turned around so as to make a salvatory *virtue* out of precisely what's perennially *holding the ego back* from any progress, *preventing* any transformative insight that would serve to unlock from the chronic level of mind-body integration committed to the surface glamor of 3rd-density objective entrapment."

"Well what is the real significance of the 'service to others' category, then?"

"Simple. 'Service to others' as well as 'service to self' are categories imparted for purposes of *classification*; they establish the respective frameworks in which *any* sort of higher density progress is going to take place, if it is to take place at all. These categories just give one the *criterion*, the lines of orientation tending to determine the *preponderant ratios between one's respective Advisers*, while still functioning on the 3rd-density probationary level. The more the subject is inclined, behaviorally, toward one axial category or another, the more consistent the particular emphasis obtaining in the functional ratios of 'positive' and 'negative' (higher-dimensional) help, counsel and guidance.

"If the 3rd density personality may be cartooned as a vacillating psyche with mixed motives and inclinations, we can visualize that personality as a fellow with higher-dimensional 'angel' sitting on one shoulder whispering in the ear, and higher-dimensional 'devil' sitting on the other shoulder whispering in the opposite ear; depending on whether the cartoon subject is inclining more to the 'positive' or 'negative' interpretation of reality, the 'service to self' or 'service to others' category, there will be more or less call for one over the other, and consequently more or less of either in evidence at any given time as 'guide' or subtle/invisible guardian. At a certain fateful threshold in the operative proportion or 'percentage' of orientation, of course, an invisible boundary-line has been passed and the personality has effectually 'committed' to one type of alignment or the other with reference to further progress and learning-modes of the 'higher', postgraduate densities.

"The subject is thereafter 'typed', stamped according to his

aggregate tendency and 'processed' into further patterns of alignment and integration according to the divergent requirements of each Model, positive or negative. This fateful, threshold crossing into a decisive higher-dimensional zone of potential functioning *either* positive or negative, knocks one or the other 'adviser' right off the shoulder leaving only *one* as higher-density counselor and ongoing 'guide' according to the Path inferentially 'chosen'. And all of this, in its formative stages especially, may not even be particularly noticeable or consciously marked at *all* by the subject in question!"

"Ah. I begin to see why it's a shame the ego fails to value those classificatory headings for their *own* merit rather than the ego's self-preserving interpretation."

"And why is that?"

"It seems obvious that they're given as a kind of grace, for the

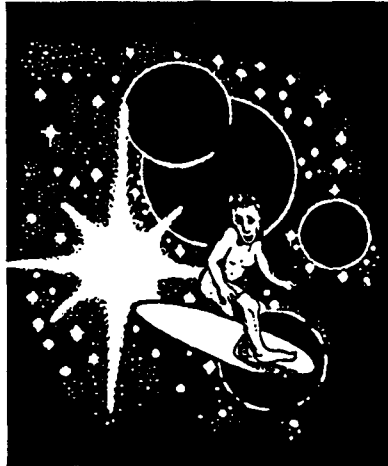

ego's *Soul* sake rather than for its performance-standards. They're categories that should be *silently* accepted and evaluated by the ego, used as internal measuring-stick for the soul's own counsel rather than loudly shined as exterior 'proof' of validation. It seems they're just meant to help the subject *steer, to clearly decide where* it wants its further soul-development to take place, in what arena. Otherwise, it could easily *sense* the onset of a higher form of integration and functioning, but not be at all clear as to what *framework* it was being integrated into—or that there was a *clear distinction*, that there was a choice to be made at that cross-roads juncture rather than just a technical alignment, and that as far as the *soul* and its own feeling-nature were concerned there was a *great deal* of difference between the two poles of higher-dimensional

development positive-or-negative—the difference between..."

"Heaven and hell?"

"Yes. Heaven and hell.

"Say, wait a minute, Michael. If 'service to self'/service to others' is just the classificatory guide to threading the soul into alignment with one *side* of the vertical (transdimensional) axis or the other, then what is the actual criterion for *moving* into the higher density framework *in the first place*, either positive or negative?"

"It all comes down to this—you aren't measured according to your works, but weighed on the basis of your *balance*."

"Balance."

"Balance. 'Balance' signifies the degree of real conscious equi-poise through which you're practically functioning. That *equipoise* furnishes the basis of *any* form of true conscious insight that may be obtained, whether in the positive or negative sense."

"That's strange...you never think of the 'negative' as having any relation to 'balance' at all—you always think of it as being *constitutionally* imbalanced..."

"The 'positive' and the 'negative' must be equally balanced around their own, respective poles. They may seem imbalanced with respect to *one another*, but within their own frameworks they must achieve and maintain a kind of functional balance. That which *imbalance*s, to either side of the ledger, is gross attachment, one-to-one ego/identification with a particular object or objective. If 'serene dispassion' characterizes that *positive* type of balance to be achieved as antidote to such disturbing potential, we may say that *cold objectivity* characterizes the negative style of balance.

"There are *obviously* still *objects* and *objectives* in either case; but both, respective forms of orientation serve to prevent or forestall the collapse of integral harmony (required to maintain higher-density alignment positive-or-negative) through the allure of the Temptress 'Lust-of-Result'. That's how *both* positive and negative higher-density frameworks circumvent the enervating forms of *rage*, or distracting subplots of 'personal revenge' that characterize 3rd density-style



attachment to results, outcomes and desired effects."

"So...what was that again?... 'You aren't measured according to your works, but weighed on the basis of your *balance*'..."

"Motto of Maat, the Egyptian MT (sporting dual As in the middle, eh?)"

"Ah yes—the Vulture-goddess of Justice, I believe, who weighed hearts in the Hall of the Dead with...a feather."

"She might be heard saying, more often than not," AAA smiled, "you have the ego of helpfulness—but not the Soul of Listening. You're always running off to 'do the good deed' so as to score Brownie points—but you never stop to Listen to what's really been Said."



"You know, Michael," the Colonel said, "I've just had a thought here. As I understand it, those who 'graduate' to the higher densities of soul-development in the service-to-others framework, while technically free of the need to return to the schoolhouse of masked, 3rd-density level, nonetheless often *do* as a function of the service-to-others orientation..."

"Yes, that's right. The higher-density personality, functioning within the multidimensional context corresponding to his actual level, may form a kind of compact with others of that and *higher* levels to return once or occasionally to a 3rd-stage state so as to supplement the *indirect* education provided by camouflage mechanisms of that framework, with the incomparable factor of face-to-face tutelage by an incarnate agency.

"This form of 'educational' help is always considered the most potent, universally effective and valuable; it's cherished above all others in the higher densities, even above the educational forms of 'channeling' or temporary, vehicular intersection in adaptive 'travel' from homebase to the stepped-down density of 'Earth'. Of course, since it's so cherished in the *higher* densities it tends to be the least appreciated and, indeed, often the most despised form of Instruction on 'Earth'."

"Why's that?"

"Contempt for commonality, Colonel. The very factor of commonality that makes such teaching so unique and valuable, i.e. *sharing* the same plane and framework of practical focus as the 'student' souls, is at the same time the *veil of normalcy* which—in so masked a dimension—often serves to thoroughly obscure the merit of the Incarnate teacher with those *objective* standards and criteria of ap-

*pearance* that comprise the mindless sine qua non of physical 'englamorment'."

"You mean, nobody *sees* anything extraordinary in the flesh-born being, there's nothing to particularly distinguish him—or her—no glowing auras or obvious halos, no rays of otherworldly energy emanating from their fingertips..."

"Well, there *may* be, there could be any of those things but the point is, the student-souls of this density would never *know* it because they hadn't developed the faculties *themselves* whereby to see such things; of course they suppose themselves automatically deserving of any such disclosure *gratis*, either as if it's constitutionally owed them or as though an *obligation* of 'God as God' is to offer proofs of divinity up front when claiming the privilege of 'special' appearance.

"Even if there *are* one or two who typically 'have' such powers, virtually by karmic accident, the ego belonging to such beings never allows proper perception or interpretation in any case, and indeed—in practice—most often becomes affronted and wildly agitated in the presence of any such Integrity beyond its own so that it actually manages to *manufacture* a symbol-system of interposing properties grossly the projection of the ego-subject's own quality, and serving to deflect or obscure Reception to what's really There.

"In fact, that very difficulty involved in proper apprehension and receptivity becomes *part* of the learning-framework of this density. It comes to serve as the *principal lesson* as to what the 3rd density state of consciousness is all about, because involved in that one situation may be found all the puzzles, *koans* and mind-locks revolving around object-valuation, the antipathy between thinking and feeling, knowledge and understanding and the central paradox that haunts all considerations of time and eternity, 'sacred' and 'profane', the 'ordinary' and 'extraordinary' etc. The living Teacher of a truly higher-dimensional correspondence manages automatically to embody, and draw forward, the interior crisis of all 'corporeal' conditions, succeeds in aggravating their implicit presence to the degree of the *unavoidable* just by the natural expression of that Value proper to his Being. In his awakened state he's an *affront* to sleep.

"But even the sleep-state *dreams*; and it dreams on the basis of the available material, the prevailing real conditions of its nocturnal environment. Thus the sleep-state *dreams* the being of the Awakened one who's really present, there in the room, but through the interpretive medium of the dream-mind or ego-psyche the slumbering subject makes up models and idols of rationalization to account for the peculiar characteristics otherwise known—in the intuitive substrate of the dreaming being—to belong to a Consciousness *completely awake*. The process of dreaming tends to covet its state; and, as inbuilt action of its own device, perceives the things reflected into it in such a way as to preserve the artifice of its narrow self-adjustment, interpreting every impression in service to prolonging the dream."

"Isn't it true though," the Colonel said, "at least the way I understand it, that in 'compensation' for the opaque resistance typically accorded the higher 'spiritual tutors' who come to this plane, there is the massed support of all the hierarchy functioning through the infeeding octave of densities with whom the incarnating 'helper' had—as you said—first of all arranged a compact..."

"In principle, you can certainly say that the incarnating teacher on the 'positive' spiritual side has the cooperation of the Whole behind him, in terms of the beneficent intelligences working on his behalf 'behind the scenes' from the vantage of the deeper leverages of psychic and creative influence (through which every attempt is made to optimize the effectiveness of those patterns serving to coordinate the Earth-plane experiences forming 'round the Presence of the teacher). It's hard to look at this as any sort of *compensation* for the resistance of Earth-plane intelligence, though, since that resistance is—at its core—both a function and product of *will*, of deep internal preference or psychic selection rather than the expression of a strictly mechanical flaw that can be offset by mechanical means.

"And while it's true that such a psychic orientation is *condi-*

tioned (given optimum opportunity for framing its volitional prerogative through technical filters and cognitive screens which maximize the potential for distortive determinations in the first place), once set it has a strictly conscious inertia or momentum of its own; once certain, *willed* predispositions arise from a maximally-encouraging soil, they exhibit a heartiness that partakes of their specific character and so tends to prevail over the sum of conditioning factors no matter how they may change. Consciousness comes to *rely* on such willed predispositions or prejudicial habit-patterns of the 'screened' dimension as a refuge of familiarity, a stable reference of Identity *precisely* in the midst of what could otherwise be bewilderingly changing conditions."

"So the fact that the given 'spiritual teacher' of the positive type has more or less the whole of the positive hierarchy behind him, in the technical sense of magically intensifying the coordinate alignments of those patterns through which he functions, is nonetheless not the equivalent of a real compensation for the typical inertia and resistance accorded that teaching-presence through the 'volitional' orientation indicative of the opaque Earth-medium itself."

"I think it's fair to say that. The incarnate teacher has only one fundamental purpose, and that is to transform *consciousness*, to awaken *consciousness*. No trick in the book, so to speak, that can be brought to bear towards technical furtherance of that aim as a teaching device or demonstration, can ever be considered the *equivalent* of affecting any such change. The free-will variable at the heart of this consciousness-transformation reserves the inalienable right of its bullheaded blindness to call a Heart a Club, and to insist that Everest is an anthill if you but back far enough away from it. In other words, *magnitude* of sheer magical effect within the conventionally 'permissible' context of the blindered dimension in question, is no guarantor of a capitulation or ceding from the indigenous *psychic stance*; since the free-will variable—functioning from the premise of its locally-distortive framework—can and does exercise the volitional 'right' to dismiss the evidence of a subtle syllogism as well as the public disappearance of Mount Rushmore, that irreducible prerogative is the absolute leveler. There's no *degrees* of relative efficacy obtaining (as in some mechanical or algebraic formula) between the intensity of 'persuasion' exerted by the Nonordinary patterning of circumstances through the Teaching-presence, and the independent determinant of will—no matter how conditioned by distortion—of the ego-subject toward whom the teaching demonstration is directed. There's just no such *equation* at all; and yet they *do* bear a relation to one another.

"The teaching demonstration, and the Presence of the teacher altogether, is given *on behalf* of the free-will variable. So they bear an *indeterminate* relation to one another. In other words, it's a relation which, while its effects and interactions can be *estimated* by a process similar to statistical averaging, can't be determined beforehand in any absolute way. This is why the true spiritual teacher on the *positive* side of the density-divide has much the more difficult task, in this sense, than his negative counterpart; for the positively-aligned teacher isn't just attempting to influence or induce a *behavioral* modification; he's trying to effect the infinitely more subtle, elusive and difficult work of *awakening consciousness*—i.e. *persuading* its volitional fulcrum on the basis of its own innate merit beyond all the conditioning that would counsel otherwise, and keep its determinations statistically 'locked-in'.

"The negative 'teacher', on the other hand, while certainly attempting to affect a polarization of *consciousness* in alignment with the negative higher-density orientation, is precisely most effective in his work by the indirect or surreptitious method of *behavioral modification*, i.e. *causing* that polarization-preference of probationary consciousness to take place imperceptibly as silent effect of the sum direction emerging from its cumulative behaviors. Thus the negative 'teacher' slyly induces reactive behaviors, intensifying the most negative lines of tendency through aggravating indigenous fears

and magnifying them into preemptive determinants; the subject-candidate to negative polarization finds himself *well* on the way to (ota) negative-interpretation of existence (through the tacit, collective thrust of implemented behaviors) before consciousness need pivot on its volitional fulcrum and assume such 'philosophy' as an overriding Intent, a direct desideration of its own.

"In this sense, the negative 'graduate' just ratifies what has been implicitly accepted already; he puts his 'conscious' stamp on a '*fait accompli*' that has effectively characterized his orientation for some time.

"You can see it, for example, when the higher-density negative 'alien' presences encourage the paranoid and bellicose tendency of the military mentality to the degree that it's pressured to enact all its logical conclusions, driven to force-eject the deepest implications of its long-time premises into a kind of 'purity' of action unmixing by benign considerations. At the point where such magnification-of-tendency takes place most comprehensively and with greatest internal consistency, the consciousness in question has all-but-created an airtight, self-fulfilling prophecy (insofar as the deepening uniformity and integrity of its actions has aligned a responsive model of conformably mirroring reality *confirming* its assessment to the degree of *Conscious* ratification, full-fledged philosophical endorsement of the formally Negative premise as most-accurate standard of the Way Things Are)."

"This brings me to the premise of my original thought," the Colonel interjected. "I was asking about those higher-density beings within the service-to-others framework, who need not return to the lower probationary densities but who sometimes do...and I was speculating about that possibility as an understandable function of the service-to-others framework—you know, that kind of 'backward' birth is done with maximal cooperation of the multidimensional selves and beings of the 'higher' levels who remain at their stations in order to organize and influence the lower-dimensional patterns toward which the teacher-soul is temporarily moving; all the interacting densities and levels exhibit Beings who act in concert in order to accomplish the kinds of transformation that redound to the service and benefit of the whole."

"Yes..."

"Well, it occurred to me that the higher-density *negative* beings must occasionally take 'backward' or lower incarnations as well, you know, apparently retrogressive 'births' in the earlier densities that are technically beneath their present level of attainment."

"Yes..."

"I think some such thing must be what's implied in the idea of the 'Anti-Christ'; a being of some optimum 'evil' that must correspond to the higher negative densities yet who takes birth in the physical dimension and appears as a man. Now, it's relatively easy to conceive, in the service-to-others framework, what might stand to be accomplished by some such 'retrogressive' incarnation; that kind of thing seems almost *intrinsically* a sacrifice, since a higher-density being enjoying privileged levels of Light and Consciousness etc. deliberately takes it upon himself to temporarily forfeit all such supernal pleasures, powers and faculties for what, by all accounts, is a contrastively restrictive and tortuous form of compressed *corporeal* existence. On top of that, from what I gather, such a formidable 'setback' is liable to be more than just *temporary*, since any such incarnating consciousness even proceeding from a point-of-origin in the higher densities must take on the indigenous 'veil of forgetfulness' when assuming the physical integument of the lower worlds. And although the deeper spark of awareness remains as a *latent impression* of the soul-being linking it with the higher worlds from which it voluntarily came, it's formally obscured by the scrambled patterns of biogenetic and transdimensional coordinates comprising the nests of 'centers' compounding the molecular 'locks' of the physical, fetal structure.

"It's been said that even if the abstract prefiguration of the



general, patterning complex of 'dream-symbol' events for the embodied Teacher is optimized, furnished a favored edge beforehand by the 'planning committees' of the higher densities with Whom the Teacher has arranged his Compact, there's still no guarantee accompanying those patterns; for when the abstract elements of those optimized patterns begin to take form in the actual unfolding of the events they intend to condition, they do so on the basis of innumerable overlapping and interacting probability-variables only *some* of which could have originally been taken into account by the 'planning boards' of the higher densities, some of which indeed upsurge on the basis of minute multiplications making cumulative, unanticipated impact and some simply generated in the first place by powers, processes and influences in service to factors *other* than those strictly governed by the positive planning boards—i.e. those of purely *negative* agency.

"So when it comes right down to it, there's always a very deep factor of creative *indeterminacy* residing at the heart of even the most carefully tailored patterns. And that means there's always a potential for the 'best laid plans' to go awry. I've heard in fact that *quite often* there are higher-density incarnations that take place in this world, which ultimately *fail* to take advantage of the timed opportunities and encoded 'swings of the gate' when they come around as supernally-planned, so that—as you would say—the irreducible prerogative of the 'unpredictable free-will variable' in conjunction with assorted, adversarial influences has served in such case to produce a *real* setback in consciousness, a *real* collapse to an identity-equation with an altogether lower order of existence. And in this sense, it seems that the higher-density being who takes embodiment here with the intent to *wake up* in this context for whatever reason, is genuinely jeopardizing all the 'ground' that he's gained through higher-density advancement on the 'roll of the die', so to speak; he's taking a real gamble, with very high stakes, and has something quite definite and precious to lose.

"And even if you take into consideration that 'all the King's horses and all the King's men' of the higher densities are going to try very hard to put this Humpty-Dumpty back together, reread an *optimum* patterning potential (given the newly issued karmic currents being generated by the 'fallen soul' in its recidivist opacity), the original fateful rule of the 'free-will variable' prevails in all cases; when all is said and done, what's lost is lost and any 'recovery' depends on *precisely* the one factor that can never be determined with certainty, and therefore never 'coded' into the patterns beforehand (though it's function can be *taken into consideration* by the patterns, no?). So the 'gamble' of the incarnating teacher is a *real risk*, and much more can be lost in terms of the whole than is accounted for by merely personal measurement. Theoretically, a *Buddha* of the higher densities can be lost, a Christ or Krishna, a Lao-Tsu can take an unceremonious nose-dive into the tarpit with the best of intentions, and then there's no way to know when that irreplaceably precious Consciousness can be recovered again!"

"Well, even incarnations taking their points-of-departure from higher 5th and 6th density levels are given *variable* priorities—even in the higher *positive* framework some are considered more essential, or critically 'central', than others and are accorded correspondingly greater values of supervisorial Attention; but of course, you are right, Colonel. Even those with the highest 'priority' are taking the same risks, and ultimately depend upon precisely the most *unpredictable* of variables.

"Then I begin to see what your question is," MT laughed. "If higher-density *positive* beings are taking such an all-or-nothing gamble by incarnating, they're at least doing so for understandable stakes, as a gesture obviously *compatible* with the seemingly-sacrificial character of the process—but *whatever* could motivate a higher-density *negative* being to take such an indeterminately risky leap into the treacherous backwaters of 'lower manifestation'? Surely the negatively-polarized soul has no affinity whatsoever with anything so

formally 'sacrificial'—perhaps the negative-style of consciousness could presume to profit from a *pseudo*-incarnation, as with the hokey 'walk-in' phenomenon where no real consciousness is lost at all, no Veil of the lower densities is assumed but the 'inhabiting' consciousness of the required body is simply displaced, by persuasive or—if possible—forcible expropriation. But what could *possibly* be the percentage for the negative being in *actually* submitting to the full-scale, uncompromised process of amnesic incarnation necessarily engaged by one-and-all when coming through the portals of physical-womb birth?"

"Yes; that *is* the question. It apparently happens; but why? What does the negative-polarized soul have to gain that is so important and otherwise unobtainable that it would take the greatest of all risks? It seems that the negative-being is above all canny; it seems he'd play the safest odds, and never take a bet that wasn't totally stacked in his favor."

"And so it is. You're right, Colonel. The negative being won't do anything in that sense that isn't guaranteed beforehand, and that certainly includes the 'riskiest' of all ventures: that of 'taking birth'. Again, he *will* do it, very *rarely*—but at climactic moments of optimum potential polarization of consciousness positive *or* negative as we have now with our world-situation, there is more incentive for direct wholesale Gain than at any other time, so that the 'risk' factor is deemed acceptable by virtue of extraordinary circumstance; at the same time, the negative being hedges the bet by using certain potential that's available to him *as service-to-self* polarization, which is not comparably available to the positively-polarized being."

"What's that?"

"Well, whereas the *positive* higher-density being has to '*wake up*' to his actual level of realization in the physical framework on his 'own' merits, unaided and strictly according to his latent intuitive capacity to seize upon the timed, coded potential 'built-in' to his incarnation, the *negative* higher density being—playing by a different rule-book, with different tactical objectives—may *stack the deck* in his favor beforehand through his multidimensional, planning-level consciousness, by placing 'plants' or confederates in strategic physical-plane positions. These confederates may themselves have such deliberate 'facilitators' implanted on *their* behalf to awaken them to their roles at the proper time, or they may have been originally installed through *circumventing* the straightforward 'amnesiac' route of literal physical birth by appropriating bodies as 'walk-ins', adapting a cover identity molded into a similitude of Earth-physiognomy from which frequent interdimensional 'refreshment breaks' could be taken unobtrusively etc. In any case, their calculatedly-positioned presence would ensure that the rearing and development of the incarnated 'antichrist' would be silently supervised, at a discreet distance perhaps but nonetheless with continuous surveillance until such prearranged or optimally-propitious time as was considered ripe to intercede and directly Wake him to his predestined role, revive the memory and consciousness of just who and what he is and what his intended purpose in that incarnation must necessarily be."

"You mean, pretty much just as it was portrayed in the *Omen* series, with the sinister governess 'overseeing' Damien's development, and the military figure at the academy who's planted there to help him along in his incipient self-awareness..."

"Exactly. It works very much like that, in fact."

"But wait; if the *facilitators* of this 'antichrist' personality don't necessarily have to literally take birth in order to be functionally present for the occasion, why isn't that equally true of the 'antichrist'-being himself? Why does he have to suffer even the minimum danger involved in the amnesic lapse by which he physically comes to birth? What's the real advantage of such a self-blinding womb birth...? And furthermore, since these are all *self-serving*, negative entities we're talking about here, what's to prevent the very 'facilitators' who have to know about the actual presence and whereabouts of this infant antichrist, from taking advantage of his momentary incarnate vul-

nerability before he 'grows' into his self-recognized power again—what prevents them from slaying him or soul-imprisoning him in his rendered infant form so as to advance *themselves* up to the higher-dimensional position he's seemingly vacated temporarily?"

"First of all, a higher-dimensional portion of this personality-presence *doesn't* incarnate—the individualized version of what is *Oversoul* consciousness on the 'positive' side, doesn't embody in the lower dimensions with the soul-projection but rather supervises from Above by continuously adjusting 'karmic' currents and thought-patterns etc. That negative, individualized multidimensional Persona 'stands guard' over its projected-incarnating aspect, and has the power hierarchically to undo any of those lesser servitors appointed to take care of the Incarnation. At the same time, those minions and servitors participate in the process and cooperate *not* merely from fear of Luciferian reprisal toward apostasy or failure, but out of anticipation for reciprocal gains in terms of advancing their power, status and overall position once the antichrist-character succeeds in his massive negative harvest. They expect to profit by the superior power this incarnate antichrist is ultimately able to bring to bear on the whole business of 'turning the planet negative'—capturing it and as much of its soul-field as possible, as a negative resource to add as a plum to the Empire.

"As for the advantage to the 'antichrist' character himself, of suffering the temporary lapse involved in literal birth or incarnation regardless how much his oversoul-surrogate has hedged the bet and sewed it 'round with demon guardians...Don't forget, this incarnation, this 'slipping-in' through the dark portal of birth takes place

amidst a certain proportion of positively-integrated Earth-souls, or amongst those of at least *potentially* positive service; and amongst these there are certain having 'powers' of their own, forms of far-seeing psychism or even higher types of spirit-intuition which might be capable of detecting the proximal presence of *intentional* malevolence with the trigger-response of an electric eye. It therefore serves this antichrist best if, until he's brought to the point-of-no-return in fully recovering knowledge of his Identity and undercover 'mission', he himself is 'innocently' unaware of that identity so that he may go through childhood, puberty and early adulthood without 'setting off psychic alarms', as it were. You see?"

"Yes, it makes sense. If *he* isn't aware of his own nature and mission, he won't be prematurely creating the thoughtforms and 'signs' that alert possible, propinquitous sensitives to his presence. His 'supervising' servitors on the other hand, should already *have* sufficient psychic capacity and higher-dimensional, magical powers themselves to shield both their own presence and activity and that of their unknowing, unholy 'charge'."

"Right. So while the ludicrous 'Jeanie Dixons' and 'Ruth Montgomerys' are prattling inanely about the 'birth of the antichrist' here, and his 'activity' there, the real antichrist slips right in, unheralded and unnoticed like an anonymous lamb, right into the midst of the flock just ripe for shearing precisely *because* it's in the meantime mesmerized by sideshow distractions such as the know-nothing hit-and-miss 'Dixons' of the world."

"*That's right, we invented you, Quaid; the perfect mole. It was the only way to fool the psychics.*"

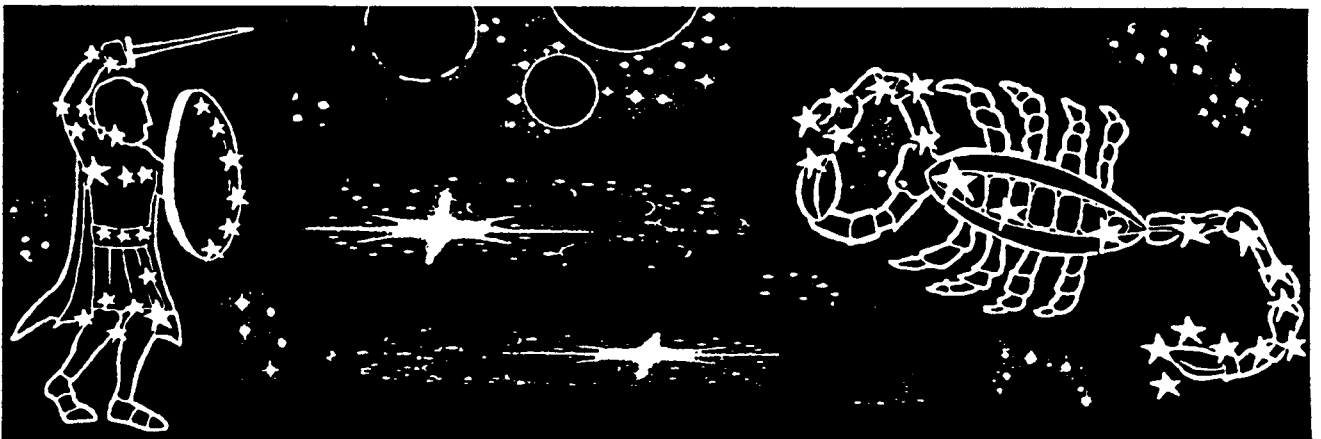

All the material in this book is from *The New Thunderbird Chronicle*, which is published by MT every two months. You can **SUBSCRIBE** to the *T-Bird* for only \$18 for twelve issues. Mail check or money order to The New Thunderbird Chronicle, 15237 Sunset Bl. ste. 29, Pacific Palisades, CA 90272.

MT is conducting **INITIATIONS** into the direct awakening-process of the Mother Current; for times and dates or more information call 213-471-0756, weekdays 10:00 A.M to 12:30 P.M.

The following UFO-related **TAPES** by MT are available by mail from Southern Crown Enterprises. Send \$10.95 (check or money order) per tape desired to The New Thunderbird Chronicle at the address above.

**Primary Creative Visualization Empowerment:** *Easy step-by-step* instruction for beginners or those with difficulties in creative visualization. Gets you productively visualizing from the first minute. You cannot really extend your full attention toward creative and spiritual development unless your basic needs and worries over resources are taken care of first. This tape puts you *immediately* on the road to fulfilling those needs.

**Astral Bells:** One full hour of specially-selected chime and bell sounds. Establishes an **ECHO-BRIDGE** of building tones artfully calculated to entrain the brain-wave patterns at an optimum harmony and synchrony of function, so that you find yourself quickly "in the Spirit" of a deeper, more profound and Beautiful Space. Comes with brief instruction page that tells you how to swiftly optimize the magical benefits you can receive from this cassette of **ASTRAL BELLS**.

**UFOs: An Initiated Account:** Now available on 1 hour tape, MT discusses UFOs, their origins, occupants and humanity's relation to such increasingly persistent "visitors".

**UFOs: An Initiated Account II:** MT explains phenomenon of livestock mutilation, government/Alien interaction, Negative and Positive UFOs; how you may discriminate, protect yourself, etc.

# What Is 'Christ Consciousness'?

by "Mother Terasu" (MT)

## PART 1

Long before there was ever a New Age, indeed since the time of the "new religious movement" in A.D. Rome, there was the question of "Christ Consciousness", what it was, what it implied. On the modern global scale allowing—and indeed compelling—the prospect of Comparative Religions, the question extends itself to ask whether there is a basic difference or fundamental compatibility between "Christ Consciousness" and Buddhist or Vedic Realization, the Taoist disclosure etc.

In order to address such a question, it is always best *not* to start from the inductive basis and build up, structure against comparative structure, conceptual edifice against conceptual edifice as in the modern-detective manner of piecemeal, cumulative science; for in that way, as we've seen time and again, there's only the spectacle of parallel monoliths aspiring upward in their separateness where lines never really converge except at Infinity—a "destination" which is impossible of access, definitionally, wherever our point of departure is the *finite* admittedly comprising any inductive, inferential basis.

Starting at the *opposite* end in order to get a proper fix on whatever "Christ Consciousness" might possibly be, however, poses its own problems. Only an initiatic wisdom based on the—necessarily—*global* requirement of Initiation as it exists in the present unitary situation of the world, may even hope to ever take up an adequate station beyond the perspectives that describe the current, codified inventory of "regional" esoteric schools, teachings and official religions.

Initiated wisdom would have us understand that in order even to *begin* to recognize what's referred to by the term "Christ Consciousness", it's necessary to establish the preliminary foundation that provides a serviceable acquaintance with the value of Being altogether; for only in Light of the totality of Being (i.e. what it is, what it is "made up of", what it "does" etc.) may any such question take confidence in an adequate resolution.

Therefore, we can't really begin with the "finite"; we *have* to begin with the Infinite, the Unlimited, the Absolute!

### **Know Thy Self-Evident and Irreducible Being (Motto Engraved on the Entrance to the Ruins of the Delphonics' Music Emporium and Late-Night Recording Studio in Culver City)**

Intuition has always shown our mightiest philosophers and wide-awake beings that, regardless the inevitable sense of limitless *caprice* and effusive *non-necessity* that pours off the subject of Absolute, there is at the same time a complementary intimation of deep *necessity*; there is the wise sense that Being, once *known*, has self-evidently necessary correspondence with its—apparently arbitrary—principles and phenomenal aspects. Being in its Absolute status possesses a certain *irreducible* value that makes its ultimate "character" wholly necessary—an inevitable, self-evident expansion and undeniable conclusion from *any* given point of departure which necessarily takes its existence in the first place in and through that Being.

Thus we *may* characterize Absolute value, (despite objections from various schools that beg the question under umbrage of the ultimately "ineffable", "indescribable" or even "unknowable" nature of Absolute-Being) without thereby in any way *qualifying* it. That Being which is "neither this nor that", "which can't be spoken", which

is "neither Being nor Non-being" etc. can nonetheless be characterized quite adequately for our sufficient working comprehension—for, owing to the *self-evident* or *inevitable* quality of Its ultimate disclosure we may be confident that there is nothing in It which is not also *in us*. Thus we "find" in It what can be identified already in us, only extended to its ultimate "conclusion" or irreducible characterization.

In this way we should be able to make certain *positive* assertions about Absolute-being without thereby in any way delimiting, straitjacketing or "qualifying" it; and moreover we should be able to make assertions *from* the awakened standpoint of the Whole which demonstrate the *inevitability* clinging to the characterization of Absolute as—for example—Consciousness, Identity and Love (rather than being unable still, despite our meta-physical posture, to surpass the present powers of physical science to reason why the stuff of existence should be *consciousness* as opposed to any of the phenomenal candidates—e.g. the "irreducible particle", the single force or element etc.).

We begin then, significantly, where many other spiritual discussions begin, with a *Triune* formulation of the ultimate "qualities" of Absolute-being. In order to understand what "Christ Consciousness" is, we have to know first of all that Absolute-being is a three-in-one proposition; it may be characterized in terms of Identity or Self, Love, and Void.

### **The Affinity of Infinity for the Split-Infinite**

Where are the necessary or compelling links between these three values? and where is the self-evident correspondence between them and Absolute-being?

First of all, anything which is going to be presented authentically as Absolute must be irreducible. This means that it must be everywhere *the same as itself*; it cannot be "other" than Itself under *any* conditions including those in which an apparent "other" may make its appearance. It is therefore, of necessity, everywhere *identical to Itself*.

That which is everywhere the same as or *identical to itself*, has to be *Identity per se*. Ordinarily when we think of "identity", we think of it as the *subject* to which are attached the qualifying *predicates* framing its profile-of-identification. In this case however Identity is sufficient unto itself without one qualifying predicate term, or *even in the presence of any such potential term*. Identity is that which is, necessarily (science would say "rigorously") identical to Itself. Absolute Identity is that which remains identical to itself in and *through* all possible conditions.

That which is infinitely identical to itself, self-conformant to a limitless degree and completely congruent with itself under all conditions describes for us the very *essence of Self*. This Identity is, self-evidently, a *Self-identity* since it is identical to itself under all conditions. That which is infinitely the same as, self-consistent with or identical to Itself, necessarily comes *to* itself in order that such congruence and self-consistency be considered truly complete. In coming *to* itself in infinite Self-congruence with itself, it necessarily *apprehends* itself as Self-identical to Itself.

This apprehension is *awareness*. It is Self-awareness—thus "Identity" as a nonqualifying definition of Absolute is necessarily an Awareness of its Self-identical character. Moreover such awareness *secures* that infinite Identity which otherwise, in the absence of any such coming-to-itself, would be infinitely disrupted from total self-congruence; it would be everywhere dis-identified from itself and so *dis-integrated* from the potential Holism of its unqualified uniformity.

This state of affairs is indeed what *seems* to happen in the processes of Cosmogony or the creative, conditioning and expressive aspect of Divine Absolute-nature. The *apparent* disruption in the self-coming to Itself of Awareness (through introduction of creatively "qualifying" terms to which the whole-value of Identity may be provisionally attached) produces a network of grades in the seeming "collapse" of consciousness; each such grade is unitive through self-enclosed, *provisionally* self-congruent terms on a conditional and comparative scale that—in themselves—support states of "subconsciousness" and "unconsciousness".

The question as to "how" or "why" such an unqualified Absolute-value and perfectly self-congruent, infinitely consistent Being "content in its own nature" would give rise to the amplitude of creative and thus *finishing* form that seems to compromise it on an infinite scale, can indeed be "answered". It is *not* a final "unknowable", but can be intuited and rationally explicated through any phase of its own Being; for all things are models, moments, exemplifications and self-duplicating expressions of Its Nature inclusive of its cosmogonic Impulse or Logocic zeal. All things recapitulate and "holonomically" illustrate the sum of principles, powers and processes involved in the ancient Love-affair of the Infinite with the finite, so that anything under self-reflective apprehension may serve as sufficient point-of-departure for an adequate Knowing without having to retreat to some rarefied or yogically-specialized state, a "past" or one-time-only hypothetical moment as the ideal (and erroneous) proposition of the Big Bang in physics etc.

Thus we may come to see that the limitless creative abundance to which Absolute seems spontaneously to give rise, is not an arbitrary manufactory any more than the Triune Values of Absolute prove to be arbitrary. In a certain sense such creative abundance springs from an internal "necessity" of Absolute. We may suppose from this that Absolute may be "compelled". But since It is "compelled", in this sense, by something within *Itself*, we cannot object that It is diminished by this "compulsion" to something less than Absolute (as would be the case if that "necessity" was imposed upon it by an intrusive principle).

**Autogenous Parts and Mind-body Work Done  
Here and Now, Only One I.D. Required  
(Se Habla Español):  
Sign Seen on Pinstriped Cowbarn in Oxnard**

And what is this "internal necessity"? Remember we noted that most theological-metaphysical descriptions have, in deference to Its "ineffable" character, attempted to *back into* defining Absolute by merely cataloguing or litanizing what It is *not*: thus Absolute is usually defined as pure Negation, a fundamental *Non-being* (i.e. "Neti, Neti," not this, not that etc.). This accounts for one of its cited, tripartite "attributes" i.e. Void. Absolute is necessarily Void in the sense that It can't be qualified in its Infinite-unlimited character; but in its homogeneity and infinite Self-congruence with Itself, on the other hand, there is only one Value that *can* describe Its Identity without delimiting or formulating an actual predicate: Void.

Being Void, however, (i.e. an Absolute-unqualified Non-being) there is only one "substance" upon which that absolute-value can work; there is only one referent to its term, and that is the *Self-referent* since it is infinitely consistent with and the *same as*, Itself. That Absolute Negation can only be applied, ultimately, to Itself. Whereas in backing descriptively into It, the value of Negation was used to "banish" the finite and thus delimited candidates to characterization, having successfully cleared the ground It stands triumphant *as Its own Sole Referent*. This means of course that It has only Itself toward which to apply Its term.

This leads us to the famous philosophical proposition regarding the "Negation of the Negation", which in fine Hegelian fashion never brings us summarily to the starting point, but induces an infinity

of intervening "distance" between the Value of Negation and its own Self-ground. The factor of Absolute Non-being, applied to Itself as its own Sole Referent, can only give rise to *Being*. The only "trick" which an absolute, unlimited "Being" (i.e. Non-being) can pull out of Its hat, is that of Limitation. The only thing which an unqualified Principle can "do", is qualify. It certainly needn't "give rise" to infinite terms, since It already resides coincident with any such Infinity.

This is precisely the philosophical principle coded into the emblem of the Tibetan "Diamond-Vajra Void". The Diamond-Vajra represents explicitly a *double-negative*. The double negative is a self-negation, a cancellation *applied to itself* so that it apparently *voids itself* giving rise to the myriad possibilities of *being*, i.e. qualification, conditionality, delimitation etc.

The apparent *negation of itself*, however, is a paradoxical prospect. Its Self-negation can only be *hypothetical*; it can only be the creative *proposition* of an infinite-unlimited Value. It can never result in a *real* collapse upon the finite and delimited, an actual decay into an encapsulated being undergoing infinite degradation; for it is precisely the continued underlying Reality of the Self-Negation of Absolute that cradles all terms of provisional Being, that holds them in its Self-cancelling arms, nurtures and sustains them *in and through* Its own continuous Void-character.

Indeed Void-being is the *only* continuous (uninterrupted) value, for as we've seen it is That which is everywhere consistent with Itself, infinitely congruent and self-conformant to Itself. This infinite congruence and Self-conformance, moreover, in *order* to be Absolute or unqualified must be sustained in the face of *all conditions*; and "conditions" are precisely the brood of that Creative incubation in the alembic of Non-being, furnishing the plethora of potentially disruptive terms.

It is for this reason that, under conditions of Its apparent, creative Self-limitation through the potentiated appearance of all the Logocic worlds, Divine-Absolute-Being *enforces* the continuity of Its Identity (unbroken at infinity) through the value of Will.

**Where There's a Will There's a Wu Wei**

*Will*, then, is the *operative* term of Consciousness-absolute with *respect* to the universes of creative potential coming to expression through its very, Self-same Value. Will is the instrumentality of consciousness which *enforces* the Infinite fact of Its coming to Itself as Self-identity, or Conscious Self-awareness; it functions as the *pressure*, therefore, of absolute void-identity informing and flowing through the provisional patterns of identification (in the field of manifestation)—a pressure which *pushes from within* on the basis of the inherently *indeterminate* term of Void-being intolerably crowded and insufferably suffocated by *any* hypothetical investment of the Whole-value of Identity in a restrictive or determinable pattern.

Will is the *pressure of transcendence*, edging Identity to surpass every intermediate equation of (potential) identification with any conditional term.

Thus while it may seem that our "limited" wills are directed toward tangible or "limited" aims, the secret value informing any expression of Will is the value of the Whole, which simply uses the "personalized" instrumentality of will to test the proffered "completeness" of any given goal or desired form so as to measure that form inferentially against its own, transcendent void-value. Will, whether apparently "individuated" or "personalized", the expression of "subconscious" units of nature-matter or Superconscious magnitudes of multi-dimensional order, is the enforcer of Consciousness-Absolute with respect to the apparently endless mediation of representative terms composing local patterns-of-identification as *hypothetical equivalents* to that unqualified Whole-value; will is the *transcendental* factor within that (provisional) investment of the whole-value of Identity, which serves to synthesize the testable unities of any given focal framework and at the same time surpasses them—at least inferentially—in the unrestricted power of its *void-unity*.

*Self and Identity*, then, are basic values of Absolute; and since Absolute possesses the inbuilt power, born of Its inherent Non-being, to overcome the "limitation" of Its perfect infinite congruence through hypothetical Self-presentation of endless "limited worlds", the relation of Absolute to Its own creative magnitude gives expression to consciousness as *Will*.

In this way it may be seen that Absolute-Identity and the phenomena of Creative existence are *not antithetical*. Given a sufficiently accurate philosophical description of the necessary principles of Being at the outset, we automatically avoid the pitfalls that plague extant descriptions of spiritual and esoteric schools still largely accepted, at face value, as issuing from some "superior" viewpoint: i.e. those views running to the effect that Absolute and the overflow worlds of creative being are incompatible, innately antithetical and ultimately irreconcilable so that one side of the Sacred Equation has to be *smuck*, eliminated as an inappropriate term through "proper" forms of rigorous meditative "insulation" practically producing a *rigor mortis* of extreme-paralytic tetany in the withdrawal of consciousness from its gross "food-sheath" etc.

Instead, we see clearly that the Creative (or Logoic) value of Expression springs from a very magical "internal necessity" belonging to the unique quality of Absolute as functional *Non-being*, such "necessity" makes the creative as a Whole quite *compatible* with the infinite Self-conformance and absolute congruence of Spiritual Void-Being, while at the same time infusing the potential patterns of creative expression with a *variable* factor (deriving from the elastic indeterminacy of the void-ground of all creativity) that permits any given combination of phenomenal appearance to conform quite happily to the standard of Divine Whim as cited by Meher Baba.

Such basic *compatibility* between Absolute-Identity and the fields of Logoic (or creative) expression, enforced by the instrumentality of Will, demonstrates the necessity of acknowledging the second great Quality by which we may characterize Absolute, i.e. the primordial quality of Love.

**"Siva Loves Sakti" (Middle-Dravidian Graffiti,  
Carved in the Carapace of a Turtle Found Lounging  
in a Corner Booth at Bully's Gym and Health Bar at  
Figueroa and La Cienega Having a Daylo Elephant  
Standing One-legged on Its Back Supporting a  
Blacklight Universe at the Tip of Its Trunk)**

Love characterizes the relation between Absolute and its creative expression; the "two" are actually of a single and inextricable piece, but united in such a way that one (the creative aspect) is obliged by the other (the Absolute status) and never the other way around.

The creative arises on the basis of the inbuilt value of Absolute as a whole-Negation having only Itself, ultimately, toward which to apply Itself. As such, the creative necessarily "borrows" its being from Absolute, but never the other way around. This intimate relation between the "two" already affirms several important philosophical propositions underlying any question regarding our furthest capacity to "know" about the Being which we find ourselves spontaneously living.

For one thing, this initial recognition contraindicates a significantly challenging proposition put forward by certain commentators throughout history; such a proposition has its most pointed modern application in confounding the hypotheses of "naive realism" advanced by science, i.e. the rather shallow, taken-for-granted premise that the descriptive characterization given us of the human nervous-system and the inner composition of the field through which it arises, is necessarily accurate or possesses basic verisimilitude (even though such a description inevitably proceeds from the prefigured variables of a pattern that hands us all its working terms *a posteriori*).

While such sage observation undermines the poorly-thought-out confidence of science's "naive realism", it inevitably leaves us with

an unsatisfactory bifurcation; for now there seems to be no necessary relation between the Absolute-Being through which we inevitably *take* our being, and the patterning processes of perception and cognition through which we draw our practical description of the world. The latter appears to be *pure* caprice, or at least nothing prevents it from being pure caprice; and while for a single instant that fact may seem acceptable, it should become plain with a little reflection that such a situation leaves us stranded with our prefigured perceptual complex functioning for all we know as a totally "lying spirit", and an unbridgeable gap opening by virtue of *just that circumstance* between our functional being and Absolute or True Being.

Indeed, stranded with those conditional faculties and a philosophical chasm separating them from anything which can truly be *known*, we are stuck in the present 3rd stage situation of consciousness characteristic of mankind collectively, in which we need *ask* whether there is *any such thing* as an Ultimate, an Absolute (and thus *something knowable*, in the sense of being an inextricable or apodictic—self-evident—value of our Being, rather than something imposed arbitrarily as a grid-pattern of cognition with no necessary relation).

There is however a necessary relation between the creative aspect of Being and Its Absolute status. Since the creative arises *through* Absolute-value, it borrows against and presumes to emulate that Value on its own finitizing level, for it's everywhere *infused* with the incomparable and all-desirable *quality* of that Whole-Being as its very Ground. In this way the creative presumes immediately to configure itself according to the infinite consistency, self-congruence and absolute self-conformance that characterizes the Supreme Value of Being through which it upsurges; only it necessarily has to appropriate such inspiring Value through the characterizing term of its own *limitation*.

**Hypostatic Cheesecake, The Baking Dessert of  
Manifestation (No Matter Which Way You Slice It  
It Remains In One Peace)**

In this way we find that the creative value of being configures itself first of all as a *pattern-of-being* having necessary, Noetic property. That which is *noetic* is intrinsically predicated on consciousness, for it exhibits pure abstract rationality. The configuration of creative "limit" as a proposition of infinite self-congruence and consistency through all its (delimiting) aspects necessarily imparts to it, immediately, an identifiably *ideal* quality. If for example a non-dimensional point represents for us the quintessential term of limit, we have to see right away that it's an *ideal* hypothesis possessing in itself no definitive "localization"; we can't pinpoint such a point—it upsurges as a proposition of the creative Value of being seeking to possess the Absolute-status through which it comes to expression, *only on its own terms* (it therefore implicitly seeks to *substitute for* that Absolute-status).

We can say then that such an ideal point-proposition comprises a *saturate* or *plenary* affirmation of the creatively delimiting Being of Absolute Non-being; it necessarily arises coincident with itself at all possible "points" of illimitable Being, but in order to do this would therefore seem to upsurge "beside" itself or ripple self-duplicates of itself in an indefinitely extensive displacement through its own basic *indeterminacy*, all such "smearing" or diffusion contributing to nothing other than its illimitable *consistency* and *sameness* under all conditions of its creative self-multiplication.

It becomes equally evident that such an undifferentiated, saturate "plenum" of the delimiting point-proposition would achieve an ideal self-congruence or limitless consistency when extended along particular *dimensional* axes: thus the proposition of a line, a curve of consistent deformation (i.e. circle) etc.

We may see from this that a simple *Euclidean geometry* represents the terms of creative limit in their necessary relation-by-derivation from Absolute. "Euclidean geometry" isn't one "type" of geometry along with hyperbolic and elliptic etc., but a prototype of the *noetic* status of creative being. It demonstrates the extension of the infinite consistency, congruence and illimitable self-sameness of Absolute through various planes of delimited being, contrastively polarizing the architectural "lintels" of dimensional perpendicularity according to characteristic, coordinate axes (cf. the twistor mathematics of Roger Penrose, in which the mapping of minimum binary states into spin-networks produces regular Euclidean angles).

Since in Itself this Creative upsurge of Absolute-being has no preferential angle, no perspective, no discriminative "bias", we may understand that all such projection of every creative term through the coordinate axes defining the "limits" of its operative self-consistency, takes place according to a universal, indeterminately extensive Symmetry. All "lines", then, constituting unitive and coherent *idea* of a noetic type owing to the rational uniformity and self-consistency of their defining axes, proliferate as polarized complementaries infilling a radial symmetry of saturate, angular intersections. Every given "point" of the creative plenum (and a point may here mathematically summarize a line, angle, curve or plane, sets of dimensions etc.) comprises the locus of such an indeterminately extensive, saturate Symmetry.

Throughout this creative plethora of essential *idea*, there is no differentiation in itself; its values and properties uniformly characterize the Noetic whole without priority—though the *potential* of differentiation arises with the dimensional "extension" of the non-dimensional point-proposition of Limit, in the form of a line. The "line" establishes the minimal basis of defining "interval", and thus of the punctuation-mark of discontinuity, contrast, break, interference etc.

The second great "circumstance" whereby Love may be located with respect to the necessary relation of Absolute and Its Creative potential, occurs in the process of *functional differentiation* through which articulated and contrastive worlds, beings and things come to full-term expression.

### Loaning, With Compound Interest

This occurs at the critical point in which the whole Value of Identity (coincident with Absolute-Being) reflexively comes to recognize the implication of the creative "borrowing" against that Value made by the delimited field of existence. For the *self-same* infinite Value of Identity infuses, flows through, and spontaneously inspirits the provisional coordinate conditions of every imitative self-conformance belonging to the terms of creative limit. Without in any way having "drained" the infinite reserves of Absolute Identity, all conditional identification-patterns symmetrically proliferating through the creative tremendum exemplify and draw forward the whole-value of that Identity in their own, parallel terms.

Yet to the Whole Value of Absolute Identity in Itself, these are precisely the conditions under which there may arise a real internal disruption, a decisive and fateful discontinuity whereby the securing self-circuit of Being infinitely "coming to" itself *would fall short*, frustrated at the contrastively defining barriers of differential identification-patterns.

That Whole Value of Identity inevitably recognizes the *validity* of the claim which all such finite and contrastive, polarizing values make against its Absolute Being; for they're the spontaneous and internally necessary expressions of all that's implied in the Identity of a basic Void-being. In order that Absolute-Identity *honor* the authenticity and "right-to-being" of the finitizing potential that borrows against It without depletion, (while at the same time honoring the intrinsic Self-definition of that very Identity as the value which comes to Itself in Infinite Sameness *through all potential conditions*) Absolute inaugurates the Loving Self-sacrifice of Its own Being through

the provisional drawing of Itself into conformal *identity-with* those forms of potential delimitation.

Not only then do those forms represent configurations and patterned "proposals" employing the Self-same Identity of Absolute as suggested *equivalents* of It; they suddenly become, in the Cosmogonic Act, experimental *expressions* of that proposition putting theoretical premises into practical terms through the infinitely *gracious enabling* of such terms by the cooperative conformance of Whole-Value Identity, on a Conscious or *Willed* basis.

It is the Will of Absolute in relation to the creative proposal, remember, which *enforces* the absolute continuity and self-same Integrity of Being on an Infinite scale under *all* conditions. Thus the Will of Absolute must first of all produce the cosmogonic circumstance of relative imbalance, shattering the (absolute/indeterminate) status of saturate self-cancelling Symmetry characterizing the plethora of creative potential in itself. To this end It simply uses the geometries or noetic principles of delimited self-continuity appearing within It, as variable points of reference establishing a minimum triangulation of compound focal coordinates along a differential Axis.

This differential "selectivity" arises as an intrinsic value of the *basic indeterminacy* of Absolute-void-being, of which the variable coordinate relations of all finitizing powers and principles within it, are specifications.

### "You Have to Draw the Line Somewhere": Translation from the Original Etruscan, Inscribed on a Vase Depicting Either the Interior Of a Paleolithic Tattoo Parlor, Or the Modus Operandi Of the Mesopotamian T. & T. Working Without Benefit of Wiring or Cable

With the establishment of an axial plumbline through the plenum Symmetry of creative potential, the basis for *differential polarization* is introduced. Such polarization permits a focal-coordinate "deformation" along a selective path of variable resolution, producing patterns of preference and stress, directional arrows, mutually invertible values of "recess" and "relief" and qualities currently interpreted at the level of physics as handedness or "chirality", "broken gauge symmetry", vector and entropic flow etc.

The self-cancelling symmetry of any given point or locus of coaxial potential (remembering that any such point here summarizes *any geometric symmetry*, i.e. that of line, angle, circle etc.) within the Noesis of the creative field, owed its uniformity with respect to all other such self-cancelling points to its "position" at infinity, with neither perspective nor differential plumbline of Identification to take a cross-sectional fix on it. Any such point possessed the ideal of "global invariance", enjoying an homogenous consistency and uniform self-congruence from an amplitude of equivalent "angles" given the limiting condition of its premise. Any configuration that could be taken through such a point, shared its value.

With the introduction of a differential *axis* (of focal-coordinate triangulation) drawing forward the compound grid-network of a multidimensional Identification-pattern, every such symmetrized point participates in a process of relative *asymmetric* alignment in which polarized fields obliquely intersect, interfere and overlap. The resulting rhythms, harmonic proportions and multidimensional resonances reap an abundance of creative irregularities, (voluminously suggestive scallops, fractal fronds and decorative crenations) comprising the rich variable basis for a bounty of combinative potential; and all such combinative potential is drawn forward in conformance with a general or whole patterning grid-network suggesting the perceptual and cognitive range within which a world of interlocking, mutually defining forms may emerge.



Thus every such world is first of all expression of a unitive pattern-of-being—integrated along a coaxial locus of compound focal resolutions—conducting the informing force of Identity; all beings, creatures, events and conditions in any such world take their point-of-departure from a primary Noetic value through which relative identification-patterns are derived by a filtrate harmonics of creative interference.

Thus all creatures, beings, events and things of any and all worlds are basically *ideo-form* from the beginning. They abide as pre-existent unities, in all their possible combinations and relations, as power of the creative abundance of Being brimming over from the purely Logical consequence of an *Absolute Non-being* having only Itself toward which to apply Its value through Eternity.

The whole Landscape of living, surprising irregularities consists of coinhering, overlapping terms of polar counterchange participating in patterns of variable resolution over a flexible, multidimensional scale. Their differential patterning as cognitive wholes at the same time spreads them over the map as distinctive, immediately graspable identities enforcing a discrete integrity at each, full-stop interval in adjustment of the perceptual “range-finder”.

All variegated, unpredictably changeable beings therefore take their collective and dividual unities from the same comprehensive grid-network of focal typologies; no creature, being or self exists “in itself” except insofar as it’s the endowment of an informing Identity taking variable stock of its potential self-definitions and ideally stable self-congruences. It’s for this reason that all forms seem imbued with an instinct toward a simultaneous *preservation* of type, as if their conditional integrity need stand for the whole as currently stated, and *exaltation* of type, as by environmental *absorption* (either through eating or adaptation) calculated to subsume the unpredictable “exteriority” of existence as supportive matter of their own greater homeostasis.

Understanding conditional processes and “entities” as *ideotypes* of a grid-network generating polarized identification-patterns through the common axis of Consciousness, we may grasp “evolutionary” behaviors as a comprehensible whole. It’s only in this way that we can *identify* the cause as well as the underlying reason and form, of the exhibited activity—e.g. evidence of adaptive “evolution” obtains from the tension between *preservation of type* and *exaltation of type*, accounting for both the deep conservatism and adventuresome drive of all formal delimitation inspired by *limitless Conscious value*.

It may be seen from this that all geometries as well as the most imaginative forms sifted from the combinations and interactions of such geometries, coexist from the beginning “at infinity” as, equally, Idea. There is no priority, ultimately; and so there is no greater or more fundamental reality that attaches to “subatomic particles”, for example, than adheres to the complex creatures apparently built up out of those “basic constituents”. Pursuit of the “irreducible particle”, then, *never brings us any closer to reality*. No greater or more “final” value belongs to the micro-world. All perfectly macroscopic, widely variegated beings or perceptual “entities” enjoy equal ontological status with the most regularized and ideal-precision attributes of the infinitesimal realm.

### He Spoke of the Coming Kaleidoscope...

Establishment of the coordinate Axis of Identity through the globally-invariant plenum of the creative field, enroots a *differential* from infinity to infinity producing a polarized subdivision of symmetric types. The initial *homogenous* and ubiquitously self-same symmetry of the (infinitely extensive) field of finitude, splits “down the delineated Middle” as mirroring symmetries, *externally* symmetric with respect to one another and at the same time *internally* symmetric insofar as each pole preserves the original symmetry in holonomically reflective facets; and then further differentiates with

the repetitive passage of that Line *through* all the hierarchically separating phases and facets into sets that are *externally* symmetric with respect to one another, but *internally asymmetric*, i.e. uncompensated by polar self-cancellations in themselves. This pattern is made accessible to visualization in the order of I Ching trigrams in which the first four trigrams, (Creative and Receptive ☰ ☷; Fire and Water ☲ ☵) balanced in their own natures and counterbalanced with respect to their complements, yield to the succeeding four trigrams (Thunder and Lake ☳ ☱; Wind and Mountain ☴ ☶) which are imbalanced within their own natures but counterbalanced with respect to their complements.

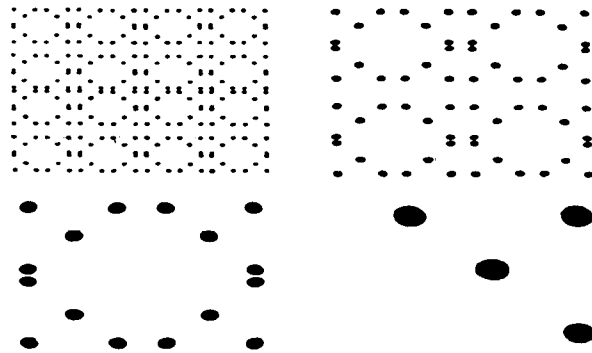

Since the *basic* value of Identity is equal to Consciousness-absolute and is characterized as that which is *everywhere identical to itself*, there is always a continuity of that ultimate “level” of identity through every differentiation and polar subdivision produced by its passage along the triangulating, coordinate Axis of Being; at the same time, because all phases of manifest expression borrow implicitly against that Identity in formulating their potential programs of substitutive delimitation, there is now an “aspect” of that Whole-value Identity which *sacrificially loans* its wholeness in conformance with the premise of such phases.

The glassy Face of undifferentiated Symmetry in which those potential modes of delimitation are suspended, becomes functionally *cracked*; like the disruption of smooth continuity produced by a shear-wave, there arises an abrupt break which forms the contours of a whole-identity *profile* (i.e. a total I-dea context drawing a focused world of allowable terms into contrastive relief). Within the framework of such “Logoic” articulation the modes of potential limit—frozen through symmetric suspension of self-cancelling values—leap to life, thawed in the context of “local” or uncompensated organizational asymmetries defined and drawn forward by the contours of whole-Identity *perspective*. (This process is made imaginatively accessible through Escher drawings, as the facsimile example below.)



Identity has to *authenticate* the being of creative vitality in order to be what It Is, i.e., infinitely the same as Itself under all conditions. It has to furnish the conditions under which that vitality can express its own premise, as the *subconscious* energy of being enforcing its continuity in *defining* terms.

The *occasion* of the electric outburst of vital-subconscious being in terms of conditional existence, is furnished by the coordinate pattern of typologies through which all such points of potential delimitation are functionally triangulated; within such defining context the burgeoning potential of the point-limit may be translated as a differential *drive* seeking to extend its continuity along a particular "plane".

The undifferentiated Affirmation of the being of the point-limit becomes a "faceless" subjectivity, delineating itself through the reflective-coordinate context as which it's provisionally "fixed". The deep subjectivity of "limit" becomes a contextual drive, a burrowing hole of homogenous *emptiness* opened in the close-woven fabric of being—intensified in its empty homogeneity to a unitive *desire*-flame, burning toward the fulfillment of perfect self-consistency and infinite congruence in conditional terms.

That drive or desire-instinct appropriates the contextual coordinates of all (mutually mirroring) ideotypes as a *process* of testable resolutions, with respect to the problematic postulate of Being—i.e. that of enforcing a perfect self-conformance and infinitely consistent continuity in conditional terms.

### Star-log of the Peripatetic Point

All such point-units, as "intrusions" in the continuity of consciousness, exist first through subconscious compounds of *hypothetical* unities; each unit surpasses its identification with each such compound in turn as the form is rotated, modeled through angles of a 360 degree superposition containing all the potential of the phylum, subclass or species, and sloughed off like a once-useful skin—the irresolvable paradox of producing infinite self-congruence in finite form creating inevitable internal tension at the core of every such compound until the spirit exhausts the given potential and "departs".

The point-unit, then, progresses in an aeonic apprenticeship through all the realms, dimensions, states and forms of nature; in turn it may function as the supervisory cell through which the integrities of animal, plant and insect life are ordered and dissolved. Unmanifest in itself, it may function as the cohesive locus through which various organs, centers, systems and complexes of the subconscious nature-currents are integrated and maintained, both internally and in their "external" correlations. The point unit may progress to the degree that it attends in turn the complex functions of the *chakra* systems in the human form, or the projected nature-model of a mountain leopard (as subordinate unit of a group-soul intelligence collectively patterning the particular species).

The point unit "emerges" through the field of expression initially as locus of an elemental force, at the simplest level of organization. As such it "intersects" a given dimension of the creative field through a pattern of emanation breathing from organic and inorganic life, issuing out of rock, foliage, lizard, brook or butterfly; or bursting as a buzzing energy from the psyche of self-conscious being, possessing on balance the basic trait of vital, emotional or mental matter and thus some emphasized value of the elements.

In this way a unit of consciousness premieres as a vital-emotional opening into Being of a greater, "conscious" system of cognition or perception; it functions as the locus through which varying intensities of geometric order polarize under pressure of their implicit lines-of-force dimensionally extending, coupling and breaking in swift shifting webs of cross-correlation and convergence.

Existing as an efficient *locus* for such a system of energy (the *pranas* or vital-intelligence of nature, formatting the potentials of "physical" organization) the point-unit doesn't donate the geometries of type, angle and rhythmic interval out of its own substance. The point unit remains in itself the radix of a basically undifferentiated "subjectivity". All geometries are reflected through its relative "positionality" within the framework of the implicit, ideoform pattern.

Thus all such point-units, homogenous in themselves, function as reflectors enabling focal triangulations of the Conscious Axis (through which they take their being) to blend kaleidoscopic networks aligning structures and systems of action as variable coordinates of the overall, typical grid.

In this way, the flying lines of geometric webbing don't need to be considered as compounds infinitely divisible into subtler states of compositional point-units, each existing as a conscious soul-potential. Soul-units aren't innate constituents of the lines and creative contours-of-being; they don't in themselves "compose" those lines. They are, rather, "lined up" through reflective ordering and relative integrations imparted by the operative *ideotype*. That type is based on the particular "value" of opacity belonging to the presence of the point-units (i.e. all such units "occur" to Being in the first place as latent deposits of a particular *style* of limitation, with respect to Limitlessness; the presiding ideotype weaving them to progressive, sentient alignments will reflect—through structured values and cognitive qualities—the myriad implications within the original Restriction as an *unfolded amplitude* of correspondences).

The resultant geometries functionally integrating the point-units are *filtrate reflections*, crystalized at the limits of opacity furnished by the presence of the units; they are, themselves, integral substructures of patterned types reflexively drawn through wholeness of the Conscious Light of Being—i.e. the Logos and Its intelligent focal-coordinate mediators (the Angels, Dhyanis Chohans, Pitris, phases of Supersoul consciousness or Sublogoi depending on your system of study).

Nonetheless because the shifting vital geometries arise *through* and at the same time serve to establish the situational presence of the point-unit within the framework of the presiding Pattern, they comprise terms of provisional identification for that unit. Its homogenous self-identity is contingently "invested" in the differential patterns and stylized modulations of light enabled by, and organized through, the flat interruptive *subconsciousness* of its centralist affirmation.

The "impressions" thus obtained through the positionality of the point unit are conserved as memory-record, and act as navigational rudder conditioning further patterns of response, extending the operative field of identity-recognition even in units that would be conventionally considered insensate, or "inorganic".

In this way the unit is "guided" by its impressional systems or condensed memory-record in developing through the global potential of the form, state or element which it serves to organize. The unit is not itself the form, state or element; but its impressioned record superintends the organization of subaltern units and their cross-correlated geometries as a coherent function within the framework of the overall pattern.

Such memory-impressions don't *inhere* in the unit as its internal "composition"; for every such point-unit of consciousness is irreducible and undifferentiated, homogeneously self-same as the centralizing premise of being. The memory-impressions are provisionally *associated* with a given unit as operative forms of its contextual identity, so that even in its non-reflective, "subconscious" state that unit is able to invest the undifferentiated totality of itself in differential organizations appropriating (and functioning through) the whole-value of its unity.

The impression itself is not conserved "in" the unit, then, but is engraved in and through the medium of the *Akash* as functional expression of that medium.

The Akash is the potentially defining space-of-being, reflectively modeled as a crystalline network interpreting the tensors of energy/matter through variably mirroring and self-duplicating cross-sections of its polarized facets. In itself it's as undifferentiated and opaque as the eidetic units which seem to slough off from the Parent *lump* of that matrix, i.e. the potential soul vehicles first appearing through the forms of nature-force (as irrepressible point-magnitudes of the *vital soul*) rotating subconscious apprenticeships in the



elemental spheres. Like those units it becomes "defined" as a polar tension of internal parts under reflective Light of Conscious Being, interpreted through superposed ideotypes belonging to the abstract-noetic value of that Being (which were, themselves, suggested to the Infinity of Consciousness by that interruptive presence of creative Limitation abiding within Itself).

### A Conative Will-o'-the-Wisp

Both the Akash and the variable subdivision of soul-units within it, have an ungraspable existence. The Akash is the dark-internal disruption in the continuity of consciousness, abstractly representative of the total/undifferentiated value of Limit. It's a *proposition* within Being, unlocalizable in itself. Its subdivided units of soul-being arise as potential *specifications* of limit; undifferentiated in themselves, they nonetheless "appear" as magical holes or opaque disruptions of Being carrying specific value-potentials, as the abstract proposition of limit continues to suggest ideofrom *types* of resolution between particular problematic existents and the infinite self-congruity of Absolute.

Such *soul units* are unrealizable and ungraspable in themselves; their existence has an illusory *en soi*. Yet they constitute *effective* disruptions in the simple continuity of consciousness; as such, they comprise the collective points-of-departure for the conscious *ideotypes* (the *logoi*) in which their style of delimiting disruption is incorporated.

Such *ideotypes* have no existence in themselves, since they depend upon the presence of the limiting point-predications that nonetheless don't dwell *within them*. Indeed such types preexist the amplitude of consciousness as a function of original, "ontological conditions"; they have no self-contained verity at all. They're dense immersions of a cosmic "surplus" upon which consciousness can *draw* (without subjective obligation toward them as defining "contents" of Itself).

The hallmark presence-to-Itself of potential *limit* (granted by the opaque value of the Akash and its gestating soul-constituents), induces Consciousness to *identify* the causative character of those "dark spots" by drawing upon the self-illuminative ideotypes through which they're modeled, and in which they're incorporated as a unitive mode of Resolution between "finite" and Infinite. Consciousness "broods over" the disruptive point-presence as a means of attracting and shaping the unitive Light-of-the-ideotype, in illumination of the potential belonging to the point. The pattern of the ideotype based upon the point, is drawn out in the presence of the point and reflected against the limit of the point, in potentiation of the ideotype.

Thus the point-value is "illuminated" and procedurally revealed not as a graspable existent-in-itself but insofar as the Light of the ideotype is *aligned* in relation to its presence, and reflected against the Restriction of its ontological "limit" as filtrate beam in a polarized grid-pattern subtractively weaving a contextual self-reference (i.e. the dimension, field, plane or world through which it comes to expression).

In this way it may also be seen that the *memory-impressions* comprising the potentially "manifest" side of the point-unit, have no real existence in themselves; the contextualizing patterns-of-being "conserved" in the Akash don't give us the thing-in-itself either, since their very integrity is due to the supportive coinherence of all, conjugate phases as which the impressions are organized.

That which is preserved in the Akash is a "permanent" record *not* because its presence finally tracks down a definitively localizable "entity" made of peculiarly perdurable materials, but because the time-factor is absent. Depending how it's viewed, either "up" or "down" the cosmogonic axis, it has either been *removed*, or hasn't been *put in yet*.

### Making Time

The *time* factor is functional product of the intersection between the vertical axis—the common juncture and resolving Line of consciousness—and the "horizontal" field of geometrizing potential, at the degree of compound-focal lockin perspective displacing or phase-decoupling whole systems of *mutually-invaginated* coordinates through which conjugate qualities otherwise self-cancel, in a suspension of mirror-symmetric values.

Such phase dislocation generates stress-tensors across angularly displaced, coordinate networks; the *locus of counterchange* through such reciprocal displacements furnishes the term of *energy* for the given system, and thus contributes the factor of mutation (integration and disintegration etc.). The term of energy for *any* given system of organization, predicated on any geometrized order, depends on the factor *t* which expresses the degree of specific tension in the polar displacements of coinherent, abstract conjugate values generating angular coordinates of the field with reference to the transecting axis of consciousness.

In the absence of *t*, the cyclic alternations and phasic high-light/recess of conjugate terms retires into the poised, "fetal" or enfolded coinherence of mirror-invaginated values; such values delineate *ontological* coordinates of filtrate light, reflected through and upon itself in counterpoised stasis. In the absence of *t* the measurements of relative "distance" are nullified, so that the still/peaceful residence of such geometrized light-values may be understood as coextensive with "space", indeed "defining" space at every point.

The processes of "change" are absent from such fossil light-deposits; the *energy* of change is absent, existing only as "potential" in those abstract-coordinate geometries comprising the essential *codes* through which any form of activity in the relative-behavioral field is organized. All that's left as frozen deposits or "tracks" of memory-impression in the Akash is the distilled, geometric skeleton, the bare ontological "cage" or abstract file "out of time" from which, however, can be reconstituted as by magick all the patterns of action and energy-exchange belonging to the "corruptible body" of the worlds, by simple resumption of the angular intersection through which its polarized planes were distributed.

The impressions in the Akash are "permanent" then not because they're fixed "things", but precisely because they have *no* self-enclosed existence—residing as mutually mirroring values each "pole" of which functions as inverse "zip-lock" of the other.

Whatever any such pattern-of-identification configures "in itself", the penetrant copresence of mirror-invaginated values delineates an abstract "recoherence" across structurally dispersive arcs of its potential time-lines, locking the pattern as a gestalt whole in an incorruptible poise through the Akashic memory-record—like Bernadette's body at Lourdes. (The phenomenon of "phase-conjugation" in physics takes advantage of such mutually inverse properties through "tricking" the time-signatures of their phasically-displaced coordinates.)

Such holonomic conservation isn't the same as the persistence-in-time of entropic wave-patterns in the physical field: the Akash is comprised of geometric markings, magical codes out of which conceivable libraries of "stored information" may be retrieved. Its counterpart in etheric-physical terms would be something akin to Sheldrake's "morphogenic field"; or the "infinite regress" of *interference-holographies* through which the edges of dispersive wavefronts become enfolded, and echoingly "preserved" across the total field.

Thus *nothing* exists in itself, except Consciousness-absolute; all the mystery of the Akash and its soul-potential, the patterns of nature and the amplitude of memory-record, the clear-light of Being and the Self-illuminated Ideotypes, the very Logos Itself—all is a profound emptiness, and an infinite play of mirrors.

## Cosmic Connect-the-Dots

The whole process can be roughly imagined by presuming yourself as the Consciousness which idly asks of a slow afternoon what it might possibly be able to make out of the single form of a dot, indefinitely duplicated. The resultant lines of connection serve to "store" the actual ideas that upsurge from the limitless suggestiveness of the dots. Those ideas don't *originate* in the lines nor are they themselves the lines; they are noetic configurations or whole typologies of consciousness itself produced in the first place out of the presence, *to* consciousness, of the dot-potential. The "storage" or enforced impression of the idea through the connective line, serves to "engrave" the idea across the coordinates of the duplicated dot-presence. It "aligns" the formal typology in its abstract or ideal state, with the delimited point-presence which is its inspirational point-of-departure.

The patterns created by the connective lines neither inhere in nor substantially modify the condition of the "dot" itself. But they furnish provisional, variable profiles or differential "curves" of identity, of which the given dot may serve as coordinate locus in turn seeming to be "defined" through that functional intersection.

Thus the "impressions" of the memory-record are engraved in the *Akash*, i.e. the matrix through, upon or from which the delimiting point-loci derive; those impressions are *ideoform* in themselves, and belong to the patterned typologies of the Noetic Value of Being. Thus they neither modify, effect, change or efface the unitive undifferentiated substance of the Akash Itself or any of the eidetic point-loci derived by reflexive self-duplication *from* that delimiting, *un-*conscious egg of the Creative.

Every such hungrily seeking unit, upon achieving the ultimate zero-sum of all potential "angles" or perspectives of the experimental form-of-identity, is passed through the Axial pleroma by virtue of its prevailing self-consonance with the Void-value of the transdimensional Line of Conscious Identity. In passing through that void-axis it is able to assume the succeeding degree of complex, organizational "resolution" in the format of a particular type (since all "types" and ideoform propositions of being emerge from the common denominator of that axis, at Infinity). It acquires its next experimental garment, whether woven of subtle-energy elements, mineral, vegetable or animal material.

In this way we see that the *form* of the creatural vehicle does not undergo evolutionary transition from one species to another; the paucity of real "missing links" in Darwinian theory exists for good reason. The undifferentiated point-unit is not equivalent to any of the differential forms of which it may become provisional, supervisory identity. The point unit functions as the organizational *locus* through which a process of typical patterning—mnemonically conserved—may polarize the planes of the perceptual network into a particular phase of unity serving as its (elemental or creatural) "context".

The development and progression noted by inference "in nature" is actually a manifestation of the phasic intersection, through the organizational plane of matter, of the migrating point-unit procedurally exhausting one level of complexity in its unitive identity-supervision—or "investment"—with respect to an element, system, organ or organism (at any given astral, astral-etheric or etheric-material level); and rotating through the common storehouse of ideotypes in consonance with the Void-pleroma so as to emerge, on the "other side", in conjunction with the next-highest phase of organizational complexity and advanced sentience, much in the way a butterfly emerges from its "pupillary" incubation.

Thus every unit of Consciousness mounts through a hierarchy of complexities, as the locus in a cross-correlation of integrated processes moving in the direction of increasing flexibility, sentience, adaptability and versatility expressive of the drive toward stable self-consonance at a progressively escalating, more inclusive scale.

Each ascent through the "densities" of its (progressively domesticated and internally incorporated) coordinate systems, draws the locus of the point-unit closer to *functional* conformance with the *universal* or *prototypal* Axis, the median Pleroma or Void-channel of Conscious Identity physically configured in cross-section as the cerebrospinal structure of Man, i.e. *Self-reflective consciousness*. When the point unit finally passes into the Pleroma for the fateful moment of its Progression in which it becomes *consciously congruent* with that very Axis itself, it has graduated to *Soul-being*. It is now a Self-conscious locus, of volitional coordination, vehicularly fitted with the *full complement* of the multidimensional nature-current out of which it had worked its eons-long apprenticeship.

## Avoiding the Void, Voiding the Avoidance (Motto of the Ancient Order of Night-Surfers Emblazoned On Blue Escutcheon with Star-spate Rampant)

In this manner we see the innumerable ways in which the value of Love comes to expression in the relationship between Absolute and Its Creative amplitude. The whole-value of Identity lovingly infuses, informs and inspirits all apparently finite and subconscious units of Itself so as to draw them, on the attraction of Its own Value, into ultimate congruence with Its essential Axis. Here the awakened unit of consciousness, now the Soul-entity, first lives that *self-reflective* value of Absolute Identity which—as we've seen—sacrificially aligns itself in conformance with the inverse coordinates of focal displacement whereby the most *finite* and locally-imbalanced properties of the creative pattern are granted disproportionate claim upon that whole-identity investment, so that the apparently inert and resistive qualities of physical-existence-in-itself are drawn to the fore.

Thus it is *precisely through this Self-conscious mode of the physically-focused ego complex* that the Whole-value of Supreme Identity seems to sacrifice its substance in amnesic conformance with the conditional *identity-profile*, the myriad egoic predicates to the subject-declaration "I am" (i.e. "I am"... "a doctor, a pilot, bewildered, alone, a housewife, a harlequin...").

At the same time, this negatively-polarized or "step-down" focus of the multidimensional Axis of Being is, as the egoically-configured Soul, in direct vertical alignment with values of Identity that maintain their uninterrupted wholeness without obscurity through provisional forms of identification, i.e. the essences of Superconscious or Oversoul-being Above the Abyss of "psychic materiality" presiding congruent with high-symmetry landscapes of the *Creative*, corresponding to the Heaven of Heavens; and those *transcendental* values of Absolute Being which abide Eternally Beyond even optimum congruence with such ideal-symmetrized Void-fields of creative quality.

In this way it may be seen that, on the basis of harmonization and positive-polarization alignment of the vehicular nature-currents belonging to the autonomic or subconscious circuits of that transdimensional Axis, the value of awareness (characterizing the self-reflectively conscious ego identity) may be integrated in direct conformance with those *optimum* terms of Absolute Conscious Identity abiding at the Freedom of Infinity.

In this way the *greatest* function of the intrinsic Love-value would have been fulfilled, in that the *ensouled* fields of manifest expression would have awakened into conformance with their Spiritual Ground.

This is the work of spiritual practice, and the obligation of humanity as that exemplification of Whole-value Identity apparently locked into the limits of definitional terms.

In the accomplishment of such an alignment, the relative "asymmetry" of the created patterns-of-being producing the apparent opacity and "destructive interference" of physical perception is *cancelled of its former effectiveness* and quietly belied—not by some fantastic installation of a global Supersymmetry of perceptual

parities, necessarily, but by the awakening and illuminative "back-lighting" of the Whole-value of Identity drawing the "actuality" of preponderant, anisometric impressions into equipotential parity with the abstract *latency* of all lines and angles specifically negated.

Thus the field of manifest expression is disclosed even under conditions of its continued "anisometries", as belonging to the Value of Void Being.

We see then that the Triune description of Absolute as Identity (or Self), Love and Void renders irreducible and coinolved Qualities without in any way compromising or qualifying Its Absolute-nature. These are the terms of Its illimitable Being. And though they are inextricable, coinolved and continuous terms, we find that they may be *functionally* separated; for when they are "employed", through Will, to formulate the Creative pattern of Being, they become specialized for functional purposes and incorporated *into* that transdimensional pattern according to differential emphases.

Thus we find that, in viewing the vertical, cross-sectional display of the (physical) human nervous system and the cerebrospinal Axis, we may ascribe those three Supreme Values in proportional emphasis upon three subdivided phases of that upright Pattern.

The value of Identity is associated principally with the Head (and, esoterically, with the Crown and Third Eye regions); the value of Love is associated principally with the Heart (or, esoterically, the heart-center and throat-chakra); and the value of Void is associated principally with the abdominal region of the physical form (or, esoterically, the solar plexus, navel and reproductive centers) since that area corresponds transdimensionally to the structural locus through which the tangible properties of corporeal perception are aligned. In this way, Void is seen to characterize the minimum reality of the creative patterns of manifestation in themselves.

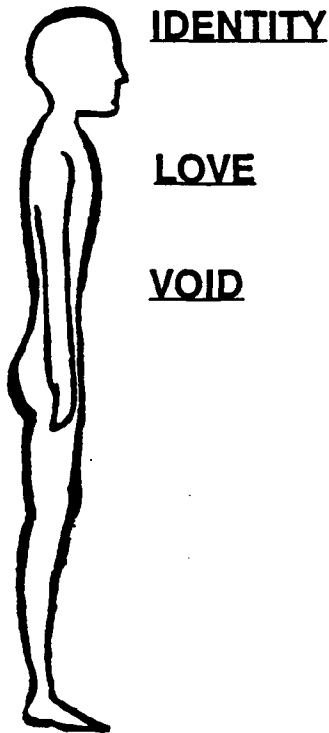

# What Is 'Christ Consciousness'?

by "Mother Terasu" (MT)

## Part 2

In Part I of "What Is 'Christ Consciousness'?", we learned how the Triune Principles of Absolute Being, i.e. Identity, Love and Void, while inseparable and coeternal nonetheless partition themselves in specialized distribution across the Conscious Axis, loaning their respective values in differing ratios of emphasis to the multidimensional Pattern of Life polarized through that Line. Consulting our Map, we see that the principle of Identity is functionally associated with the Head of the Pattern, although it pervades the total form; the principle of Love is functionally associated with the throat and thorax of the Pattern, although it infuses the whole form as well; and the principle of Void is functionally associated with the abdomen of the Pattern although it characterizes the extent of the form.

The value of Identity was affirmed as an absolute principle, since that which is an "identity" is necessarily everywhere identical to itself, infinitely consistent and conformant to itself; it constitutes the very Selfness of Being, and further demonstrates that such Selfness necessarily involves Consciousness as an irreducible quality—rather than as a compound epiphenomenon—since that alone is truly "identical to itself" which *comes to itself*, (i.e. is aware of its self-identical character).

The absolute principle of Identity as mapped over the multidimensional, mind-body pattern (flatly perceived as the physical body) has to be considered in relation to the power of Limit; for the potentiality of Limit, as we saw last month, is the fundamental premise of *creative magnitude* burgeoning within the all-potential property of Infinite Being. The prototype of Infinite or Unlimited Potential is, necessarily, the creative proposition of limit, conditionality and finitude.

Thus the limitless Self-continuity of Identity when viewed as a Value belonging to the "created" map of our mind-body being must be understood with respect to the "challenge", sprung from the depths of Its own all-potential, presented by the premise of Limit. The question then arises: how does absolute Identity, in order to remain absolute in Its infinite Self-continuity and uninterrupted homogeneity, appear with respect to the potential discontinuity of creative Limit?

We may see that the value of Identity with respect to the manifesting field of our (multidimensional) mind-body pattern, takes on the character of Light. Light is not first of all a reflected and indirect lumination of some field or plane proceeding from a source "removed" from the thing illumined; Light is the basic and immediate constitution of Identity in relation to its own inbuilt potential for creative limit. It is thus a primordial *Self-illumination*, a revelation or Self-disclosure of absolute Identity from within Itself, a natural or "apodictic" (self-evident) unfolding as a responsive Means.

Such a Means is the instantaneous *identification*, born from within Itself, relative to formal *resolution* of the problematic "confrontation" between Self-identical Being and Its own creative Limit.

The constitution of Absolute Identity as Light (with respect to its internal potential for Limit) has therefore the specific character of *Idea*.

### The Original Idea-Man

As we've seen, the Self-identical Being of Absolute has the irreducible value of *consciousness* since It must come to Itself in unmediated Self-awareness of Its infinite congruence in order to be considered "absolute", whole or complete; being consciousness in Its

unlimited homogeneity and Self-sameness, It appears as the Light of Idea with respect to its internal potential for interruptive limitation.

Thus Light in its ultimate nature is equivalent to Idea. Before it may be interpreted through its own self-organizing patterns as some "interference" of flux or rhythm, point or wave, it abides as an innate-born Revelation, an illuminative Self-disclosure of Means with respect to the creative "challenge" (hidden as fertile seed-potential behind the cosmic umbilicus of gestative Infinity).

Identity beams forth as the Light of Idea with respect to the cosmic or creative pattern-of-being; it responds to Its own internal potential as the instantaneous *abstract grasp*, the thetic "model" of How—i.e. "how" such a proposition of creative limit may be drawn, through the implicating arc of its own presumption, to the *ultimate self-cancelling Juncture* of finite resolution in order to come to itself as inevitable *Negation of its Premise*.

Such Means shines, with peremptory incandescence, through the instant of Eternity; it spreads into an equivalence with infinitude from shore to eternal shore, and while it enwraps the creative proposition of Limit in the form of Light (thus making Light the first *adaptation* of Infinity to its own delimiting premise) at the same time it comprises the infinite *reconciliation* of the "finite" with the absolute continuity and uninterrupted *self-congruence* of whole-value Identity. In the incandescence of Itself as fundamental Idea it is abstractly whole, single, infinitely unitive and perfectly self-coherent without "moving internal parts".

Far from being the "expression", then, of a complex network of systems, integrative fields and electromagnetic "components", Idea discloses Itself as the smooth origin of all secondary configurations through which Its reflections may be experienced.

We assume that consciousness and idea can *only* be the expression of processes that have reached a sophisticated degree of complexity and interaction; we have traced a path of piecemeal, scientific "sleuthing" in which *our* detection of the escalatingly complex (from the viewpoint of crude résumé) has seemed to *parallel* the Cosmic order of things. We still fail to notice that our complex involuted mapping draws us, through the enchanted prospect of *unitive resolution*, toward an intensification of polarized patterns and properties to the degree of equipotential identity and thus toward a hypothetically "smooth point" at which (on the working model of our flat scale) the tangled tracings and wildly multiplying vines of minutely budded facets pack so densely into the growingly self-same "space" as to become indistinguishable. We move with instinctual *lust* for finalizing unity toward the smooth sheet of the undifferentiated, on which all our marks and Feynman branches proliferate—in progressive symmetrically regulating swarm—to ultimate compactness as a single expanse; and yet we allow this Ideal to exist apart from any identification with *idea itself*.

The ideofom mapping of all models into a compulsive congruence and correspondence has "yet" to disclose to us, apparently, the common denominator of Idea. We have yet to realize on any significant scale that "idea" doesn't appear as "epiphenomenon" or derivative *expression* of complex fields or filtrate grids but that all such fields and grids constitute *stylized subtractions* or *selectively screened reductions* of a Whole and undifferentiated Light, which is equal to their resolving Idea at Infinity. We have yet to realize that all fields and grid-patterns ("complex" from the polarized, perspectival angle of their establishing coordinates) are simply petals of a single Noetic flower, a Self-radiance blooming from the Heart of Being such that Being, by interpretation, spreads everywhere as a moveless Ocean of

Repose upon which the Self-resolving Lotus of primordial Idea eternally floats.

Indeed all possible "ideas", thoughts, perceptions and processes exist as adaptations or stylized renderings of the one Idea, the single Divine Thought. They are reflections and perspectival expressions of It in "local" contexts. They take their point of departure from that Idea, mirror and modulate that Idea by interpretation through the degrees of perspectival "distortion" furnished in their obliquely screened self-estimations.

Thus all perceptions, processes, thoughts and ideas are simply variations, at whatever crude level or masking scale, of the primordial and Single Idea; they are discursive ramifications of the single theme whereby the continuity and infinite Self-consonance of Identity is satisfactorily enforced in the face of all delimiting, "finite" conditions.

### Read This Section; You May Already Be Thinking *Big Casino!*

Every thought, feeling, mood or emotion ever entertained, imbued with a sufficient value of identification and no matter how otherwise dimly conceived constitutes a totalizing "philosophy"; every thought regardless how dense or disagreeable represents the self-estimate of the being as which the thought was formulated, and so comprises an implicit *summation* of a whole universe—the universe of irreducible Being as reflected through the unique perspective of the cross-correlated *percipient*-consciousness. It may be internally self-contradictory, disjointed or so short-sightedly trivial as to seem by any standard of evaluation hopelessly deficient; yet as long as it represents a sufficient threshold value of the force of identification it qualifies as a philosophical *précis*, a veritable universe of implication and consequence. It is simply a distortive version of the single Idea of Absolute, and as such is a kind of reflective *take* on an implicit Plan for procuring ideal self-continuity through a contingent and delimiting "angle".

This abstract ontological structure presides *uniformly* over all ideas, thought-patterns, processes and perceptions no matter how apparently negligible or meretricious. It mirrors the enfolded "cotyledon" in the Seed-idea of the One Infinite Identity, the noetic Self-luminance of Absolute (with respect to the challenge of its inbuilt creative potential). Thus every manifest pattern, process, form, reflective thought or conditional idea takes its expression from and as the One Idea; the One Idea, without "internal moving parts", comprises the *fundamental Reality* of which everything is a reductive and filtered, polarized version apparently proliferating in self-multiplied display as a complexity of interacting elements.

Such models or varieties of idea (taking the form of worlds, environments, conditions, beings and ancillary thoughts) don't exist as internal components or subdivisions of the One Idea. The noetic Light abides as a smooth uninterrupted Whole, with no "moving parts". Yet as an abstract thesis, a *proposition* of resolution or fulfillment between Limit and Absolute Identity, Light presides as spontaneous efflorescence of Will.

### Gathered For a Reading of the Will

As shown in Part I, Will is precisely the instrumentality through which Consciousness *enforces* its infinite continuity and self-identical homogeneity with respect to all *potentially-interruptive conditions*. All idea is a unitive formulation of will, a plan or proposition of will. Idea is not *indifferent* in its abstraction, but is bristling with Intent. It is fitted with *intent* from Infinity, and is inseparable from purpose. Therefore Light is first of all, before it is a manifestation of apparently complex parts or divisible attributes, a moveless homogeneity of Intent. This is why it *expresses* as a *radiance*, a purposive intensely "lineal" flow, an emphatic emanation. It glows with volition, an implacable thrust of Resolve.

In the form of Will, enforcing the unitive coherence of the relative fields as testing ground for "containing" the Absolute Unity

and Self-continuity of Being, Light "lines up" the points of Its Thesis. This Line of irradiating Light doesn't *subdivide* from within itself, as if "emptying its contents" onto the table of surface appearance. It draws on the *preexistent* unity and integral presence of all quality at Infinity; all such quality takes its Being from an absolute value which, in order to uphold the strict integrity of Absolute makes no distinction between "potential" and "actual", "infinite" and "finite", "abstract" and "concrete", "limited" and "unlimited", "manifest" and "unmanifest".

### Read This Section Only If You Would Break All the Bounds of Propriety

It is at this formidable border of Absolute beyond all qualification that description reverentially stops, according to tradition. Classically we can't *know* anything about this "ultimate" Density of Being, apart from what is reflected to "individuated" spirit through the planes of manifestation from the Barrier of the Qualitative Veils. From those Veils we dimly perceive the suggested outline of the inconceivable Absolute, embodying and reconciling all paradox that comprises the *contents* and problematic *postulates* of every world issuing from the Darkness of that "final Curtain".

If, however, in the enthusiasm of our momentum (borne on the confidence that whatever Ultimate Is, we are not apart from that and It ultimately is "us") we imprudently pass beyond the propriety of traditional silence and keep up the continuity of our Description well onto Taboo Ground, we not only break a millennial Seal in anticipation of a collective advance of all "levels" a notch up no matter from what level each practically proceeds; we discover that Absolute yields some important considerations that, regardless how apparently rarefied, *necessarily* have application at all levels and indeed *without which* we remain stuck at the traditional Veil comprising the membrane or "ring-pass-not" of whichever encircling Limit we may occupy.

Given the Key from that nosebleed eminence of Absolute, however, we discover a significant thing: since Absolute *as* Ultimate necessarily constitutes the "8th density" or Spiritual Octave it is *not* really the highest of successive levels (which would somehow separate, define and differentiate It over against all subaltern "tiers" of Being) but like any true Octave constitutes the resonant summation and expression of the whole from the deepest point of limit and subordinate qualification, sounding that Note to and as the most inclusive *Résumé*. Thus in contemplating that Absolute in which there is by "definitionless definition" no distinction between "potential" and "actual" etc. we necessarily confront the Being that is nonseparate from Everything equally, manifest and unmanifest alike. It is not "different" from our present, delimited-manifest level, yet at the same time it infinitely surpasses every level and is abstractly removed from all "being" to an inconceivably remote degree.

A curious thing happens however, when we contemplate this Absolute; for a logical requirement issues from the *intuitive* magnitude of our strictly rational faculty which, with fidelity, echoes a truth of ultimate Being (since it is expression and representative reflex of It as globally modelled). We find that the indiscriminate coexistence of "everything" and "nothing" beyond paradox or ambiguity, while exhibiting what has to be characterized as a perfect and indifferent equipotentiality at the same time betrays within itself an *inbuilt bias* from the beginning, a deep inherent tendency toward *inequality* of Ontological Values.

### This Section Proves by Rigorous Hermeneutics That Existence Is a Trick Question

All we need do to understand this is to consider what Value prevails under condition of an Absolute Being that abides the terms of "distinction" and "nondistinction" without discrimination or differentiation. Without distinction between the "differentiated" and the "undifferentiated", the indiscriminate Plenum of Absolute *neces-*

sarily favors non-differentiation. Without discrimination between Limit and the Limitless (undifferentiated) Absolute favors the Illimitable!

The "undifferentiated" coexistence of everything cannot imply, obviously, a simple nothing. All possibilities necessarily "occur" to Infinite. In the Plenum Being of Absolute all things preexist the super-saturate condition of eternal fulfillment before the fact so that, rather than comprising the simple absence of anything they achieve an infinite unitive cancellation of all preferential profile or discriminative "direction" through the sum of possible states, conditions and combinations (allowed, by Infinity, to proliferate indiscriminately and so by perfect self-compensating symmetries converge in identification to the degree of void).

The solution of Non-being to which everything instantly "totals" through the thoroughness of Absolute, isn't a bare absence of conditions but an eternal fulfillment of all potentiality before the fact. Thus the "Void" of this Absolute Stature is Full. It is not nothing, but Everything, already summed, added, globally "totalled" through the panoply of possible permutations which necessarily maps a distributive curve coming full circle as a summary Zero of numberless radial "distinctions". The preexistence of possible things, beings, conditions and events in the globally-saturate fulfillment of all tangential tendency summing to zero through any given convergence point of "probability", possesses the being of Non-being. Its "thingness" is no thingness at all, but a No-thing.

### This Section Is Specially For Those Who Like to Dial 900 Numbers All Day

We may note that the potential "thingness" of such an Absolute condition necessarily involves both the being and the non-being of the "thing" indiscriminately. A thing and the absence of a thing mutually define one another through the common denominator of Idea (cf. theory of complex numbers, one version of which correctly presumes that the square root  $\sqrt{-1}$  of a negative number—absence of a thing—is conceptual, and signifies the necessary presence of consciousness [i.e.  $\pm i$ ]; thus  $\sqrt{-1}$  is  $i$ , representing imaginary number concepts— $i$  could just as well represent Idea). It's for this reason that the most concrete phenomenon or perception is already ideoform; "in itself" it is *idea*, not simply by subjective reflection and secondary, conceptual interpretation.

All phenomena distinguish themselves according to the contextual limits of the particular "being" as which they retain their unitive continuity (and special identity) through all potential subsets of compositional qualities—i.e. a telephone is immediately apprehensible in a non-reflexive act of identification though it is "composed" of a variable and overlapping order of unities, i.e. plastic, paint, spatial dimensions, surface texture, metal etc. Thus the object is identifiable as a function of its defining non-being, i.e. its "limits" constitute the definitional ground of all which it isn't, and which therefore makes it what it is.

The "being" of a thing and the non-being (or absence) of a thing thus necessarily occur together and show that any "thing" is ideoform from the beginning.

The "idea" of a thing models that thing in and as its absence. The ideoform character of a phenomenal object is exhibited in and through the instantaneous, non-reflexive unity as which it's apprehended. Any such unity is necessarily organized according to the "absence" or non-being of the thing displaced in its coordinate and defining field, its supportive context comprising all which it isn't. The unitive disclosure and phenomenal "identification" of a thing in all its contingent specificity and perceptual overflow is a function of the negation of alternative unities and synthetic patterns-of-identification that can be made on, through or within that "object". The "unity" of telephone is a volitional and ideoform unity, since the totalizing

pattern in the intent of will draws forward the immediate coherence, intelligibility, meaning and value of "phone" through overlapping coordinate variables on which alternative unities can be made.

Although for practical purposes we make a distinction between + and -, the presence and absence of a thing, we make that functional distinction on the ground of their undifferentiated mutuality. The abstraction as which we model a thing imaginatively, producing it by its absence, is practically distinguished from the abstraction through which we preferentially model the variable coordinate terms of perception as a contrastive unity elicited on "alternate" ground, against which we may therefore "bump". Yet we achieve this practical distinction by restricting and masking the term of Infinity. We have to focus through a strict "anisomerism" of coordinates in order to mount the abstract unity of our object-being on projective tangents modelling the angular transection of a sufficiently restricted perspective (practically screening the Infinite term through the limit of "alternate" organization); whereas the appearance through our imagination of the object by its absence, while presenting an abstraction of theoretically infinite potential still necessarily limits its "being" insofar as it possesses a functional poverty of projective coordinates—thus it can't arise through the overflow ground of alternate (cross-sectional) planes, tangents and axes by which its unifying abstraction acquires the rich irreducible presence of an inexhaustibly detailed "contingency".

This contrastive "differentiation" of the ideoform + and -, then, is achieved by masking the term of infinity through the anisomerisms of relative perspectival focus polarizing a practical plethora of alternate identification-patterns and ideotype unities. If however we unmask the bare Term of Infinity it becomes apparent that there is no differentiation or distinction between + and - as, equally, functions of  $i$  (or Idea) through the common denominator of consciousness-absolute; there is no differentiation or distinction between being and non-being, finitude and infinite, limit and the illimitable, potential and actual.

At the same time however, we've seen how this ultimate State (or Density) of Absolute Being doesn't bring with it a static equivalency of terms! Under the Value of Absolute (i.e. the indiscriminately Self-Same Identity), the equal pre-existence of distinction and non-discrimination, being and non-being, limit and the illimitable doesn't amount to equal billing! In the indiscriminate co-existence and eternal undifferentiated unity of "distinction" and "nondiscrimination", the term of nondiscrimination obviously presides! Between restrictive "Being" and unrestricted "Non-being", Non-being obviously presides—and similarly between limitation and the illimitable, Limitlessness presides!

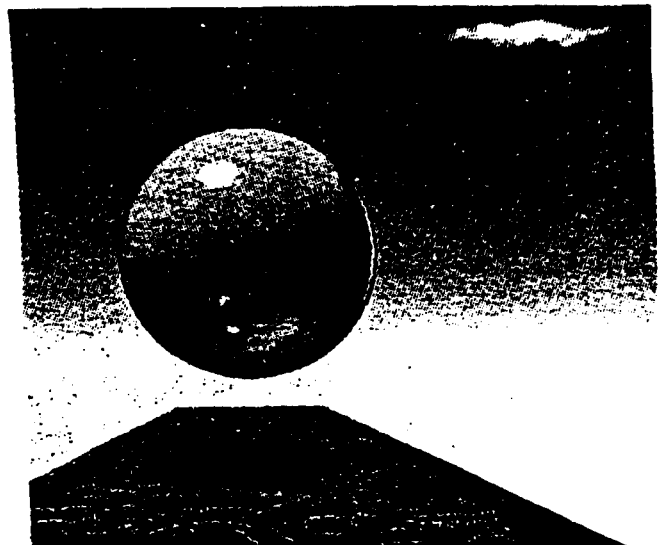

0538-B-11

## **PART 3**

*When we last left Our Lady of the Dangling Participles at the cliffhanger-close of episode 2 she'd just come careening around the uncompensated curve of broken void-symmetry; forded the treacherous two-hearted stream of Identity in the densest wilds of Creation; narrowly averted the Fatal of an epistemological impact at the backwater cross-roads of Focal Triangulation (population uncountable); wrestled Long-Tall Will—the transdimensional Cyclops—to a decision-draw between finite and Infinite; executed an adroit verbal wheelie over the hidden speedbumps of "real/imaginary"; fishailed momentarily under the Highbeams of the Sublime Idea but rectified her vehicular composure in remembrance of her rectory training only to jack-knife from a sudden, Ontological sideswipe coming out of No-where as the barreling Omnibus of Absolute leaving her hung on the precipice of the trickiest philosophical quiver edging a fateful imbalance between the implication of Difference and Indifference...*

*Now, the shocking continuation of Our Lady's harrowing plight and plucky expository progress in Chapter 3...*

THERE IS no simple *nothingness*, but the preexistence of *Everything as No-thing* in saturate Self-cancellation of all differential terms (which nonetheless retain their potential and actual "distinctions" at that indiscriminate Juncture of Merger); "thingness" takes a backseat to its common—Void—denominator while maintaining sufferance of its own (implied) state, thanks to the "liberality" of all-permissive Absolute! It's for this reason that the general category of Limit altogether (i.e. the prototypal *potential* of illimitable Absolute, cf. Part I) uniquely possesses an inbuilt *pressure* even at the "degree" or density of unqualified Absolute.

It clamors eternally, *from the standpoint even of Infinity*, to be realized *in itself*, through the guaranteed validity of its own terms (being underwritten as it is by the all-legitimizing, all-supportive and sustaining Value of Absolute). The property of Limit even in its illimitable supersaturation and self-cancellation of (differential) magnitudes at Infinity, asserts itself and pushes itself forward like the subtlest disturbance in the smooth moveless amplitude of Being; and it comprises such an aggravated assertion precisely because it suffers an inequality of existence *through* the resolving Value of undifferentiated Sameness. It therefore represents the very prototype of the all-creative potential as which Absolute abides in its infinite accommodation and permissiveness. It comprises the essential, creative proposition eternally formulated *with respect* to the infinitely self-same Identity of Absolute-being.

### **This Section Should Only Be Read By Those Who Are Deeply Interested In Sex**

This internal "strain" to take birth *as itself*, experiencing its being as Limitation in the affirmative *form* of limitation, is intuited in various cosmogonic myths—most notably the Maori creation myth in which it's recited that all beings, creatures and things preexisted in the pressurized womb and insufferable self-enclosure formed of the cosmic embrace of Rangi and Papa (the interlocked, eternal preexistence of Heaven and Earth); and that the din of all such beings crying to be released into "free" creative expression, echoed through Eternity's Halls. Since in that stifling embrace (which effectually "crushed out" the differential term or hypostatic power of all gods and intermediate beings between the—ontological—range of Heaven and Earth) nothing could come to fruition, the gods resolved to separate Sky from Ground; it is said that Sky (Rangi) Himself promoted the Means by which His children could stretch forward in the luxuriating Space of "independence" between the two Great Principles. And indeed we've seen the manner in which the "Sky"

principle (the absolute Self-continuity of Identity as Infinite Consciousness) formulates the volitional Means of such a magical endowment in emerging out of Itself as the Light of Idea, the illuminative-Logoiic proposition with Its implied Pattern of productive release and redemption. The Maori myth parallels this abstract cosmogony exactly in its imagistic portrayal of the way in which Light came to subsequently shine over the Earth of manifestation fertilely populated with all things.

### **This Section Should Only Be Read By Those Who Want To Learn How A Net Profit Is Made**

In order for this differential patterning to come about, it is as if something "new" and original must be brought forward from a plenum Absolute already inconceivably rich with all potential and actual qualities, and beyond which there can be nothing at all since it accounts for Everything *as itself*. Nonetheless this unique or "novel" factor is also a potentiality, a sublime power of its unqualifiedly permissive Limitlessness. Regardless whether that factor seem the problematic *confusing* of the Infinite postulate Itself, in Its generous all-accommodation Absolute cannot gainsay such a possibility; and indeed as the very *prototype* of Its creative potential that delimiting factor is Chief amongst Its gods and children.

When, out of Its own all-potentiality, Absolute Identity conceives the Means whereby the reified Value of Limit may be reconciled with (and indeed give ultimate Proof to) the uninterrupted Self-continuity and Infinite Homogeneity of Absolute-being, It brightens Infinity as the unitive or undifferentiated Light of Idea, the single instantaneous Means abstracting the Primordial Stroke—the Lightning-dash or Cosmogonic Line—through which all powers are brought forward on the terms of their own unique "postulates", and at the same time integrated in cooperative harmony with the Absolute-value by the Grace of which they take their being.

Implied in the single Illumination of that meta-cosmic Idea, then, is not simply the "impossible" proposition of a true Novelty upsurging within Absolute, but of a *compound* novelty coming to Being: i.e. the creative conferring of the value of Limit as a reified proposition virtually existing "in itself", from the interruptive juncture of its "own" perspective; and the inevitable Awakening of Absolute to Itself "again" as Infinite continuity and uninterrupted Self-congruence *through* the masking proposition of the "delimited viewpoint".

Thus it may be said that, through the Cosmogonic Act of the One Divine Idea or Logoiic proposition, something is "added" to the Value of Absolute which *even in the Eternal Preexistence at Infinity* didn't exist in such a Way before.

### **Too Full? Here Is A Two-Step Reduction Plan**

Indeed this creative Miracle comes about precisely in the "moment", or from the "perspective", in which Absolute formulates Itself as the resolving Principle of Light, i.e. *noetic Self-luminance* encoding the Means whereby Everything may be accomplished; for in its abstract-undifferentiated Self-luminance, the value of Identity produces a *subtle differentiation*, a contractile "withdrawal" and consequent "step-down" from the plenum value of Infinity-in-Itself. As infinite-undifferentiated Light or Noetic means, it distinguishes itself from the Absolute-value in which all differentiation and delimiting definition *also* preexist. This is why it's said that the beings, forms, processes and things of the creative pattern don't exist *within* the Divine Idea, folded up in the coryledon of the seed-Thought. That "coryledon" is composed only of Will, the abstract Intent of Divine Identity in all its powers and potentials without, "as yet", specific application: the instrumental Indeterminacy of Void-being through which the variable encoding of all determinations and differential specifications is enforced.

The actual articulated beings, forms and things of the created worlds couldn't be contained *in* the abstract-noetic Idea; for then we



would simply be back to "the beginning", where the variegated beings and undifferentiated Being abide in the unity of Absolute Identity to the point of indistinguishability. The Creative power would have no way to "get out of itself" so as to "remove" the delimiting potentials within It from the fateful generosity of Its Infinite nondiscrimination. It would ever "swallow up" those differential forms, so that their properties would only continue to cause them the "anguish" of their undifferentiated Identity at Infinity (at the same time as they were infinitely "fulfilled" of each independently counter-cancelled tendency).

By abstracting a unitive undifferentiated Means, a Single Soluble Way or Self-contained Idea, the value of Identity at the same time succeeds in "separating" or distancing Itself from the particulate plenary of possible beings and selves. As the undifferentiated Self-illumination of Idea it spontaneously "reduces" Itself by a whole-stop Density, from ultimate-Absolute Being. It is *only* in this way that it is able to so distance its undifferentiated, unitive embrace from the principle of Limit that it may "permit" the separate hypothesis of that Principle. By abstracting a volitional Means of resolving the hypostatic value of "Limit" with the Illimitable, Identity at the same stroke produces the *condition* in which Limit may be imbued with its own, enabling "exclusivity". In this way the all-accommodating, undifferentiated embrace of Divine Light cannot simply "enter into" the zone of Limit and subsume it by a simple "lapse". Its all-accommodation now necessarily accommodates the *contrary* proposition of delimited independence.

The Infinite Self-Illumination of Divine Idea seems to "withdraw" from the discretized region of Limit precisely because It is "too total" or all-encompassing a Value to "fit" the proposition of infinite Restriction; and yet it can't *efface* that proposition since the very abstraction of Its noetic Means enables it—i.e. that Means *requires* the component of "interrupted" consciousness in the form of restrictive "subconscious" and "un-conscious" genera (the basis of delimited self-continuities and coordinate extensions of the *nature-force* weaving the Pattern-of-being).

In this way the "separated" proposition of Limit (comprising the basis of manifestable substance or Prakrit) constitutes *another* whole-stop reduction in density. It establishes the workable value of *infinite Limitation*. It furnishes the functional limit of resistance or restrictive opacity against which the abstract Means of creative Will models the superabundant potential drawn—by Identity—out of the preexistent infinitude of ideoform life.

### Willing To Relocate

Will doesn't find the model of such forms abiding *within* the Light of Its own Means; It already apprehends their eternal preexistence, in the global fulfillment of all aspects to the degree of functional self-cancellation, through the unsurpassable Plenum of Infinity beyond Its volitional Self-formulation. In reflecting such forms against the enabling resistance of Limit, Will draws forward their undifferentiated Symmetries in the *reductive state of potential* (discriminating the "actuality" of their self-cancelling fulfillments at Infinity) in keeping with Its own character as Ideoform *Abstraction*.

Since all such forms preexist through eternity in all their possible combinations and relations without distinction as to "before" or "after" but without the *exclusion* of "before" and "after", it can truly be said that Absolute in its ultimate nature is without discrimination or qualification, bearing all equally. In contrast to this the smooth, undifferentiated unity and noetic abstraction of Identity in the form of Light represents a subtle *differentiation* from Absolute-in-Itself. It marks the first distinction, even in Its undivided Radiance as Idea. Therefore it truly comprises the Means whereby Absolute may *test* the Creative hypothesis (preexisting all variety through Its own Being) in establishing the problematic perspective of *finitude-in-itself*, even out of Its Infinite Essence.

It does this in two ways: by making a "distinction" between existence-in-itself (or Limit) and limited-existence *already resolved* in Absolute Identity, it furnishes the ground of a polarizing tension; a subtle discrepancy intrudes which *allows* the potential of existence-in-itself to be "liberated" from its indiscriminate coexistence at Infinity with all Value equally. At the same time, by creating the basis of a practical *juxtaposition* between Limit and Absolute Identity, it provides the ground for the reflective *thesis* of the Ideoform Resolution of Identity with respect to the proposal of "Limitation-in-Itself", so limitation may be furnished the hypothetical *contexts* in which it can "live out" its premise.

The abstract Means (presenting Itself in the Ideoform homogeneity of Infinite Light) while formulating the Will that reconciles the creative-limited with the non-manifest Limitless subtly serves at the same time to *reduce* the indiscriminate plenum of Absolute to a "dry proposition". This "abstraction" of Absolute in the form of Idea is then like a Desert of undifferentiated Self-luminance. It has no internal richness of divisible parts; but it has the Will to *draw* the potential configurations of ideoform worlds and beings from their preexistent residency as a saturate plenum of "perspectives" outfitted with their various ready-made labels, arrows and directional indicators. It has the Will to *draw them* as ideoform wholes *through* its Self-resolving formula (or illumined Means) and in that light *project them* as fertile potentiality across the interloping Shadow of creative Limit.

All such potential was suggested in the first place from the implication of creative Limit within the value of Absolute; at the same time the ideoform totality of all such potential *eternally preexists* through the accommodating amplitude of all-supportive Infinity. All variety in the subintensities of worlds, beings and things may be drawn forward *through the unifying abstract hypothesis of Divine Idea* as totalizing Means reconciling the terms of Limit, and Limitless Identity. They may be brought forward as abstract ideoform potential (in the "stasis" of their global saturation, assembled through all perspectives and dimensions) and experimentally reflected against the resistive, centralizing "interruption" of Limit. They may be modelled across that opaque intrusion of Limit in a certain sense like bright clothes over a drab, single-piece dummy.

### Slipping Into Darkness

The centralizing, nondimensional Point of Limit, being a creative hypothesis, has no "actual" position and therefore no "intrinsic" feature or modelled profile in itself. Under reflective gaze of Identity in the form of Light, that single undifferentiated "proposition" of Limit betrays its theoretical character and multiplies indefinitely, proliferating in self-mirrored extension as an infinite displacement.

Such pointillist profusion furnishes the requisite "extensiveness" of Akashic Space from its single, opaque and undifferentiated postulate.

The "center" of Limitation (and thus of interruptive, self-negating *unconsciousness*) seems to spread everywhere as an homogenous darkness, any phase of which denies admittance to the boundless Light. Such a "center" or Akashic proposal of substance, while comprising a theoretical "concentrate" has no existence-in-itself; its borrowed being, as a thesis of finitude within Absolute, betrays itself when Identity "turns" by reflection to pin-point and thus define it, for it slips like oil out from under any definitive grasp and diffuses in saturate displacement as an opaque "equivalent" of Infinity.

Thus there becomes an infinite *unconsciousness* or Akashic Space, the ephemeral basis of "substance", as well as an Infinite and coeternal consciousness.

There is then no "real" or quantifiable Limit which may be definitively fixed and exhaustively defined. What is "known" of Limit is "known" by reflection; the ideoform *models* of potential self-definition are drawn from Infinity and projected, through saturate self-



polarization of the mirroring coordinates of "being" under reflective Gaze of Infinite, as typologies of probable patterning.

The created proposition of Limit, unknowable as "itself", simply serves as functional point-of-departure for a mirroring multiplication and adjustive, organizational alignment of variable coordinate reference. No "thing" inheres in the value of Limit. At the same time, no "thing" resides in the unitive Light of Idea, but is simply brought forward *through* the Light of Idea from the preexistent amplitude of Everything. All "things" *appear between* the in-existent or "unreal" proposition of Limitation-in-itself, and the undifferentiated Light of Idea reflecting *upon* the proposition of the delimiting Point (and so diffracting a mirroring multiplication of coordinate variables which, by adjustment, align the focal "range" or resolution of the stylized grid-pattern magically regularizing the rhythmic identity-values of "beings and objects").

The "enfolded cotyledon" of the One Idea, is not then a ramified seed of internal chambers and parts; it is the volitional "coil", unitive and undifferentiated, through which the abstract Means reconciling the finite and Infinite turns upon or "comes to" itself in a single hypothesis. The *pattern* of worlds, beings and universes which seems to issue from that "cotyledon" doesn't emerge *out of it*, but flows *from application* of the reflective Line of Volitional Light with respect to the resistive upsurge of Limit in the midst of Infinity.

That Line draws upon the preexistent amplitude of Everything (abiding "behind" It as Its Absolute Ground) and *incorporates* the vigor of limitless expression belonging to that amplitude as potential through the Light of Its own, Resolving Hypothesis, *toward* the challenging field of Limit spread out "before" it. In so doing, the vigor of limitless expression belonging to Absolute is "transcribed", with respect to the *Resolving Hypothesis of the Line* (of Volitional Light), as the reflective and symmetrically splayed patterns flowing kaleidoscopically from the "plane of pointillist profusion" in the field of Limit. (We may visualize this with reference to someone writing at a desk, an image to which the Qabalists resort in referring to Metatron, the Archangel of the Presence transcribing the destiny of souls and universes in the Ledger of Life. The Line of Light may be analogous to the Pen which writes; the "ideas" of the various beings that wind up imprinted on the manifesting Parchment aren't contained *in* the Pen, but flow through Its enabling instrumentality from the Mind of the writer.)

This then is the moment of creative upsurge in the "plan" or pattern of the One Idea. It may be recognized as the cosmogonic juncture (beyond "time", "space" etc.) at which the creative amplitude of Infinite Being with all Its worlds, beings and things abiding beyond distinction of potential and actual is *practically* ordered with respect to the integrative and resolving *Line*. (This "vertical" line may be recognized as the cerebrospinal column in flat physical terms, the Hindu *susumna* or Theosophical *sutratma*, the Qabalistic Middle Pillar etc.)

### Wherein The Line Makes Its Point

Although the "universal convergence-point" in the symmetric resolution and self-cancellation of everything exists "everywhere"—indiscriminately—beneath the diffracting Gaze of the reflexive Line of Light, the absolute volitional prerogative of that Line under the abstract Wisdom of Its Resolving Hypothesis (Logoic Idea) establishes a *specific* point. Through the total freedom of Its Will embedded in the basic indeterminacy of Void-Being, Line establishes (by *creative Fiat*, by sheer volitional "caprice") a *principal point*, a fundamental Radix of universal resolution through which It polarizes the extent of Its multidimensional Axis.

With that declared Point (the Self-identical Heart of Being) established as the Mean through which the reflective term of Identity would come to Itself on a definitive basis *with respect to the delimiting hypothesis of the creative pattern of Being*, all other equipotential point-propositions could function as similar but not identical terms

of resolution on a relative basis, existing at varying functional distances "from" that universal Mean of the transdimensional Axis or Line of Light. Each such point could function as a resolving void-locus of a specialized pattern operating near (in terms of ontological "distance") but not coincident with the universal Void-locus of the transdimensional Axis.

Thus we may visualize a plenum distribution of such resolving void-points functioning as the convergent mean of innumerable patterns, indistinguishable in themselves or from the Heart-locus of the total Pattern-of-Being *except* with respect to the all-important, arbitrary if absolutizing Fiat of Line (which, by drawing its Axis of polarization through that *particular* Point establishes all the distinctions, and indeed makes the differences in the various patterns drawn through the locus of particular points a *direct function* of their relative—ontological—distance from the Median Term).

The innumerable points clustered about the central Axis with Its fundamental Coordinate Point may be considered loci of many *patterns* integrated through, but not coincident with, the resolving Mean of that Axis; they may be considered the quintessence, the virtual "void-navels" of rich interwoven forms possessing discrete identities and at the same time coinhering, overlapping through numberless other patterns—*Akashic* matrices through which are reflectively organized in crystalline cross-hatch the coordinate networks of Garnet and Orchid, Lynx and Benzene, Pitch and Redwood.

Yet all such differential form of any such patterning process takes its specific (organizational) being and context from the filtrate grid-network of compound, polarized perceptual keys organized through the variable coordinate loci distributed along the central Axis of Being (the transdimensional *susumna* or cerebrospinal column) and having their Common Denominator in the Median Point of that Axis, the Heart established in the Middle by Logoic fiat of Line.

### Making *Ens* Meet

All possible, mutually integrated if "discreting" patterns exist as super-saturate assemblages of allowable geometries under governance of the prevailing ideotype, in themselves without differential angle, polarizing perspective or discriminative axis thrust through the dense-packed bundle of potential as which they abide. Each such possible pattern (i.e. creatural model, vegetative form, organ-matrix etc.) receives the enabling *perspective* on the "subjective end", through the correspondence-of-identity between it and the apprenticed *consciousness-unit* functioning as the inspirited void-locus seeking its self-continuity through an experimental succession of conditional terms. Each such possible pattern receives the enabling *angle* (whereby a matrix of *differential* perception and functional operation is drawn into relief) through the "objective" lens of compound focal triangulation along the central, multi-dimensional Conscious Axis drawing Its potential typologies into relative expression (cf. Part I).

The central, transdimensional *Line* is the operative determinant in the polarization of a particular, functional network of patterns and processes through the perceptual plane out of the "stationary" global assemblages of creative potential; all potential patterns are integrated most coherently through, and *with respect to*, that Line. All saturate potential of the compound-focal coordinates aligning variable geometries in the patterning grid-networks of perception, is *differentially filtered* and *polarized* through the elastic discriminations and "undetermined determinations" of Line, the Axis of Volition.

From the optimum integrity and volitional variability of Line (the centralizing Self-axis of Being), logoic typologies organize the multidimensional current or patterning process of manifestation as a whole. This whole-current typology along the central Axis serves to filter and align "mnemonic" flow-channels of recursive, automatic—or sub-conscious—coordinate grids (the synaptic "typologies" of the central nervous system and responsive patterns of the *autonomic*

nerve networks, at the level of physical "cross-section"); through the irradiating junctures and polarizing "pyramid-points" of those coordinate grids, the currents of subconscious magnetism—or "fluid vital force"—characterizing the pattern of the nature field draw the corresponding alignment of planes and angles from the "stationary" or dense-floating global assemblages of patterning potential abiding as the innumerable point-loci indirectly correlated with the Central Channel.

In this way we may see a clear Influence flowing from the integral pattern of the Volitional Line, through all the potential beings, selves, creatures, planes and things exhibiting a reflective and coinvolved typology of Appearance.

### The "Stuff" On Which Dreams Are Made

Identity, infinitely Self-congruent and continuous in Itself as consciousness, takes on the Idea-value of Light as *Self-revelatory inspiration* regarding the Means through which that Absolute status may be reconciled with the disruptive principle of Limit permitted by Its very Infinitude and all-potentiality. It is for this reason that we interpret the first hypostasis of *Identity* with respect to our "chart" of the mind-body pattern, as the Self-born Light of Idea, the principle of Logos. It appears in relation to that chart as the Divine Means by which the Absolute Selfness or identical self-same value of Infinite Being affirms Itself in the face of all conditions. The inbuilt Solution of that Idea draws forward all Its burgeoning implication in the very form of the *Abstract Pattern-of-Being*, through which such a conciliation between the finite and infinite may be accomplished.

The character and function of that Pattern (the multidimensional mind-body axis in relation to which the Divine Hypostases are ascribed) was the substance of our discussion in Part I.

Identity in Its inward incubation and Self-brooding as Light, takes the form of Idea in response to the presence of the creative potential of Limit. Therefore regardless the innumerable patterns of beings, conditions and worlds with which Its internally-single and self-homogenous Hypothesis corresponds, in Itself it represents the *abstract potential* of resolving configuration; in Itself it has no internal subdivision of components that comprise the compound materials of nature, and therefore of the differentiated Life-pattern.

It may be said then that the "substance" of the Divine Idea is intelligence. Since it is Idea and therefore abstract hypothesis reconciling actual terms, it must be conceived as having *substance* or "materia" (as opposed to consciousness-in-itself which is Beyond all terms, hypotheses, qualifications etc.) although such "substance" is smooth and singular. In contradistinction to the abstract "materia" or intelligent substance of Idea, the pattern-of-Being which is implied in the Idea expresses the state of nature-matter. As the pattern-of-being it manifests the potential of inertia, resistance, opacity and self-enfolded limit. Thus its ideoform coherence and polarized integrity reflect not simply the response of Absolute-Identity to the potential of Limit within Itself; it manifests the value of that Identity when, in Its ideoform holism as Light, It permits the validity and integrity of the proposition of Limit as a functional reality and *confrons* it, in effect, as an exteriorizing quality beyond the self-consonance of Its substance.

The pattern-of-Being which spreads through Infinity beneath the reflective Light of Identity, takes its point of departure from the principle of Limit "in itself" and therefore from the primordial, contractile "centrism" or hypothetical *self-enclosure* of the non-dimensional "Point-being". Regardless whether a "thing" has the relative dimensions of a tea-cup or a galaxy billions of light years in extent, with respect to Infinite it exists as Limit or *infinitely contractile reduction* and so may be represented through the minimalism of the geometric Point.

This "point" is the basis of substance in the *perceptual sense*; it is the basic "information" of all cognizable reality, and so comprises the stuff of *nature-matter*. Unextended in itself but indefinitely exten-

sible, it is the primordial *Akash*, or root of spatiality known in the East as *Mula-prakriti*. Under Self-reflective Gaze of Identity its abstract hypothesis of "limit" *diffuses* abstractly, polarizing in limitless versions of itself mutually mirroring and multiplying by cubic self-displacements so as to furnish the variable coordinate network in the grid-alignments (or "intramural filters") of ideo-form Perception.

Opaque and unextended in itself, the substance of "Prakriti" blossoms jewel-like from the Dark (kaleidoscopically mirroring in infinite regress the noetic geometries faceting energy-matter of the nature currents) under reflective Light of Line. It appears as the meta-cosmic Crystal variously known as the bejeweled pavilions, nets and diamond spires of Buddha-land, the Sea of Glass of *Revelation*, the crystalline Throne of Qabala etc. As such it constitutes the eternally self-mirroring and reflectively reinforcing "substance" of the multidimensional memory-engravings, or impressional "record", of the Akashic Space.

The codes and coordinate impressions of bejeweled, reflective Light aren't contained in the matter of Akash; the Point-substance of Prakriti is irreducible and opaque in itself as an infinitely disruptive *un-consciousness*. But they are nested and stably reinforced through the pointillist diffusion that bends all reverberative beams under reflective Light of Idea.

As we learned in Part I, the Point-hypothesis of Limit functions permanently and inexhaustibly in the form of Prakriti or the Spatial Akash, the "black egg" of matter polarized under Light of Identity into reflexive phases and geometrically regularizing facets; at the same time it furnishes the "substance" from which *souls* or the critical functional units of "learning", "development", and "growth" are derived, as the means by which the opacity and disruption specifically represented through the un-consciousness of the Akash may be redeemed and ultimately belied. And those "souls" are derived in the same way that the basic undifferentiated opacity of the "Akash" becomes the *faceted medium* through which the memory-codes of the multidimensional geometries and their energy-networks are conserved: the reflective and thus mirroring, self-duplicating Gaze of intelligence belonging to the Ideoform Light.

Beneath that Gaze, the Akash not only "polarizes" into the functional field of the cosmic "memory-coil" or multidimensional, cross-correlating Pattern-of-Being; it polarizes out through the specific Fiat or Intent of Divine Will innumerable eidetic versions of Itself (i.e. its Point-hypothesis) differentially "tagged" to function as developmental *soul-being*.

Thus these "separate" point units, broken off as it were from the basic undifferentiated Slag of the Akash, are specifically endowed with an "individualized" spirit mirroring and recapitulating the One Spirit; and such a unit is endowed with that "spirit" in the form it would naturally take under conditions of its contractile self-restriction or disruptive *un-consciousness*, as the hypothesis of self-centralizing Limit. It possesses that spirit as an undifferentiated emptiness, an unquenchable *desire* or flame of longing (initially without self-reflective capacity but with the *potential* for self-reflection born of innate Void-being) having as its abstract ontological model or implicit, guiding Ideal the conciliation and ultimate consistency between its "being" as limit, and the illimitable self-congruence or homogeneity of Being it feels flowing through and sustaining it. (See Part I as to how such a soul-vehicle becomes "fitted" to its developmental destiny through successive, patterning contexts.)

Such a unit first appears therefore in the form of *nature-force* (i.e., Akashic "matter", imbued with a differential *drive* as individuated locus of unquenchable emptiness based on the ubiquitous value of Void-being); it upsurges as the irrepressible point-magnitude of the *vital soul*, migrating through restless *sub-conscious* apprenticeships in the elemental spheres. Thus the Akash, eternally furnishing the basis of nature-substance and functioning as the obliging "matter" of the delimiting patterns of the universe, is nonetheless *redeemed* through self-representations of itself deliberately "broken

off" from its undifferentiated Body (the "flying sparks" struck on the Anvil of Matter by the Hammer of the Gods); without ever diminishing its eternally renewable and Self-same substance, it is eternally yielding eidetic versions of Itself under polarizing power of the illuminative Idea, or Logoic Means. Through those "liberated" soul-units struck off from the undifferentiated lump of matter-slag of Prakrit the primordial Point or Akashic substance of nature is forever being freed, forever awakening through aeons of vital apprenticeship to its reality as Divine Identity at Infinity while at the same time eternally slumbering in the dark function of its *un*-consciousness as the ontological root of Nature.

The actual "process" of breaking off the functional flotilla of "souls" calculated to serve the awakening process of a particular Logoic pattern, proceeds according to a predetermined amount, so that under the form of a given Logoic universe there is an uncountable but *finite number* of souls at any given "time" to be superintended and redeemed by the higher powers of Consciousness.

### Keeping The Record Straight

One may ask (on the basis of reading Part I) how the irreducible and undifferentiated soul-unit relates to or bears functional relationship *with* the memory-patterns through which it associates as a given context, since those patterns aren't engraved as parts within it but are conserved in the reflective substance of the Akash (from which the unit was derived). This seems indeed to be much the same sort of Question as the canny princess asked the philosopher-mathematician Descartes, i.e. how can the "insubstantial spirit" influence or affect the body through a corporeal agent such as the pineal gland?

We see here however that "spirit" (or the soul-unit) and corporeal substance are not radically different, or of dissimilar essence from one another. They are not individually opaque to one another, respectively walled up in their own universes of being like inert objects. Rather, "spirit" (or the soul unit) is configured as a fundamental emptiness-of-identity in its restrictive or centralizing form of reference; it is not smugly self-contained or locked up within its "own" being, but actively seeks the Means in the *extension* of Identity so as to "broaden the base" of its potential self-congruence and coextensive conformance. Thus it makes provisional *equations* of identity, on a one-to-one basis, with configurations and perceptual patterns born of the "angle of incidence" in the reflection of Limitless Light (as Ideoform Means); it *loans* the whole and undifferentiated value of its Being as Identity, to patterns representing *equations* or polarized *ratios* of integration that seem to "solve" for the problem of self-consistency and stable self-continuity. And those patterns *borrow* the whole value of its Identity by the same token, so that the resultant "signature" which they encode or configure bears the specific value of *that* unit-identity and no other; since Identity is irreducible, the "identity" with which those provisional patterns configure the unity of their phenomenal equations is unmistakable and irreducible, not to be confused with any other, *as the very "suchness" of the point-unit* even though such Identity has no internal parts or specifying "components".

This is how it is that a point-unit, vital-soul or Self-reflectively conscious *Soul-being* may phasically "slumber" (as in the interval between incarnations) and so intermittently separate from its characterizing "memory-record" which is conserved in the Akash; and yet when it awakens and resumes the continuity of impressed tendencies, it awakens to—and functions through—its "own" memory-pattern (or returns to its "own" memory-body) and not some arbitrary other—for those records or impressional engravings were made by borrowing against the *particular* Identity of the soul-unit—and all such Identity is *irreducible* as a "version" of Infinitely Self-same *Absolute Identity*, even though it is "individuated" and particularized as an oblique angular intersection into the cross-coordinates of an involving *pattern-of-being*.

Identity takes the Self-luminous form of Idea in *response* to the internal potential of creative Limit; but Identity takes the form of *Mind* when the Light of Idea *reflects upon* the presence of Creative Limit as an implicit ceding to its functional validity; for it is under the fateful circumstance of such a cosmogonic moment that Idea manifests as the enabling Pattern of Being, the *functional means* of reconciling the Infinite and finite. Mind is therefore equivalent to a patterning process, enacted upon the Enchanted Loom of Void.

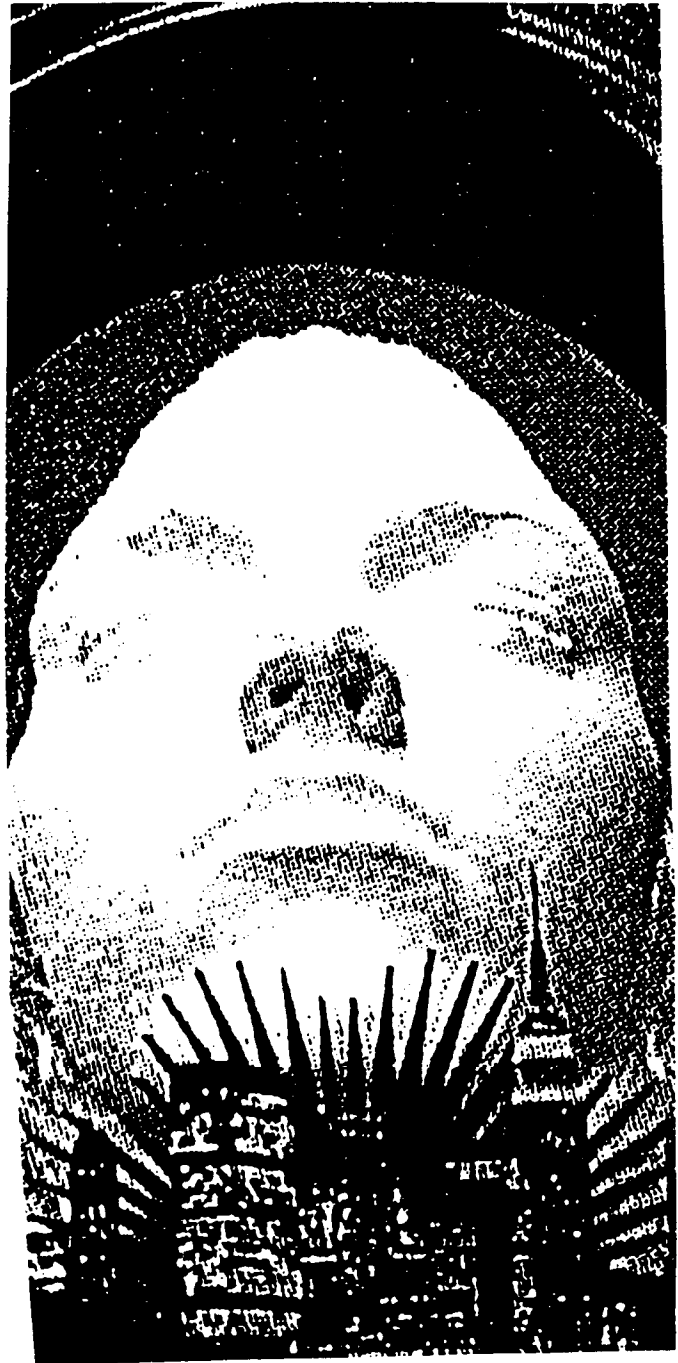

Universal Metaphysical Truth Maps Governing Positive and Negative Evolution

(C) 1990 NEXUS SEVEN

These following truth maps are presented to give the reader solid grounding in the basic and necessary "metaphysical" principles involved in "taking charge" of one's spiritual energy forces and opportunities. To apply these 'words' one must think and feel and choose to implement them in one's day-in and day-out existence, both consciously and meditatively for best results. These metaphysical principles not only are the single most powerful weapon against malevolent alien incursions on Earth, but make the entire issue of alien incursions a moot one, relegated to minor if nonexistent impact in one's life.

There are no actual techniques presented here, only the 'barebones' knowledge and truth maps themselves in most concise possible form. The best suggestion for using experiential techniques in conjunction with these truths in order to make them live and breathe in a conscious manner by one's own free will, is to: 1) be willing to intricately think about what is stated here, 2) explore one's feelings about it, and 3) discover where one currently stands in relation to these truths compared to where 4) one wants to be. That is the key structure of relating fully to the knowledge maps. Understanding them only intellectually as possibilities keeps them flat and interesting but not truly impactful.

These truths can be immensely powerful or just more fancy and cutely arranged words for the bookshelf or intellectual curiosity. If one is strongly interested in technique and does not know what to do specifically, and wants more help, the best source the authors know of today is from a small group called Concept:Synergy, located in Florida, USA (address mentioned earlier in this report). The authors have, over the last two decades for purposes of private sector scientific research for major educational and potential objective technology ramifications, carefully experienced, examined, analysed, investigated, and correlated just about every technique,

group, cult, school of thought, practice, old and new religion and occult school, metaphysical study, guru, movement, philosophy, psychology, counter-culture, cybernetic epistemology, medical practice and educational source there is. It so happens that the final conclusion is that the most powerful sources of metaphysical information come from this particular mentioned source. It is clearly head and shoulders above the rest in several respects. However, it's still not for everybody, so do what you want and feel is right for yourself.

By the way, coincidentally, this below data almost totally correlates with what the Meier connected Pleiadeans have stated and discussed relating to metaphysical concerns, but to appreciate the Meier relayed information is of course an independently valuable trail of learning. The Meier Pleiadeans materials are just the best 'off-planet' physical extraterrestrial source of metaphysical knowledge discovered and verified so far.

However, and this is critically important, ultimately the best source for these things is yourself. Its just that we been very confused by the morass of delusion and falsity parading as truth for thousands of years, so we have in many ways damaged our ability to discern. To gauge your own capacity to grow and evolve, however, is very often assisted by checking our the best the world around you does have to offer - as long as it doesn't come with covert or overt control, enslavement and brainwashing strings attached.

So here we go. Starting with the very basics:

All creational/universal processes have seven steps. These steps can be termed in words as:

1. **Focus** (Point of beginning)
2. **Substance** (Timeless issue in essence)
3. **Form** (Spatial structure)
4. **Determination** (Point of manifestation)
5. **Understanding** (Meta-spatial structure - conceptual)
6. **Imagination** (Expression of the issue beyond time)
7. **Freedom** (Point of completion and enlightenment)

UNIVERSAL METAPHYSICAL TRUTH MAPS  
GOVERNING POSITIVE AND NEGATIVE  
EVOLUTION

(C) 1990 NEXUS SEVEN

0538-9

These words can be kept in mind when thinking about any process or series of seven (7) steps regarding any process in creation. Often when the mind cannot fathom the order of the process in question it is made clear and understandable by remembering these seven key words, or ones similar. In fact, anything in life, from the smallest to the largest and most significant, from emotional to mental, from material to spiritual, business to pleasure can be understood in these seven quantum 'stepped' terms. In addition, it can be valuable to understand that any process of seven steps also has internal correspondances as well:

The 4th step in any process is the most determined, And the the 4th step is its own energy frequency.

The 7th step is the higher octave frequency oscillation of the 1st step.

The 6th step is the higher octave frequency oscillation of the 2nd step.

The 5th step is the higher octave frequency oscillation of the 3rd step.

These correspondances are found in the nature of the time/space wave interaction which is the same at the corresponding subperiod points in the 7th wave

Why does all this work out this way? Actually for reasons found in quantum physics, spatio-temporal dynamics, mathematics and group theory, topology dynamics, cybernetics and elsewhere. Like the 'golden mean' and 'fibonacci series' phenomena in nature, it functions universally in everything. This subject alone could encompass an entire book.

We are here only going to touch on those domains critically relevant to true spiritual growth requirements. Human potential,

psychological potential, and metaphysical/mystical powers potential is largely left out here, since the human spiritual potential is senior to them all and most relevant to empowerment relating to the subjects of this report. And, if the following is just too confusing or "fuddy duddy intellectual" to you, remember that it can ALL be boiled down to three mandatory focuses for success in conscious physical evolution for humans:

- 1) You're here to learn to love yourself and your self beyond yourself (others, your world, your spiritual source and destination,
- 2) learn to have fun (with harm to none), and
- 3) learn to consciously create success in all things you wish to do.

Even these three can be boiled down to one reason for it all: to learn about love - the giving and receiving of love. Thats it. Big deal! So whats the fuss? Well, there are many actually pretty simple yet deeply and intricately rooted and confusing reasons we don't get to that state of life - hence all the rest of these following explanatory datums. That is because this thing called "love" and its impediment and proponent energies is the singular holo-functional statement that underlies the entire universal and creational reality we are part of, live within, and lives within us.

All things that exist in the universe that change, or undergo motion or growth, follow the basic seven steps of process. These process steps are not arbitrary, but rather a consequence of the spatio-temporal topology of change.

To illustrate in terms of both spiritual energy and mental physics:

Step	Space	Time	Will	Determination
1.	Free	Free	No control	Least determined
2.	Free	Locked	Little control	Little determination
3.	Locked	Free	More control	More determination
4.	Locked	Locked	Maximum control	Maximum determination
5.	Locked	Free	Relaxed control	Relaxed determination
6.	Free	Locked	Released control	Released determination
7.	Free	Free	Co-Control w/ Creation	Spiritual determination

The process wave of space in the Creation is a single wave from free space to locked space to free space again, with a wave period of one (1) singular macro-quantum gaussian pump.

The process wave of time in the creation is three waves forming three (3) phases, which is really another singular macro-quantum gaussian pump with a first order harmonic octave, (like a cross section of the wave wall of a drop of water hitting a water surface which has its first order propagation wave surrounding the rebound wave, with the outer ring wave forming two gaussians and the rebound forming the central gaussian. The central gaussian rebound wave matching the phase position of the single space wave gaussian interruption of the surface of the nothing. This is only one very limited example visualization and is metaphorical only). Enough technical stuff however.

When the space 'wave' and the time 'wave' are integrated, then is developed the character of the seven steps or phases of all process, thus seven comes out of the 'one' and 'three'. The most macrocosmic process has seven steps or phases and the most microcosmic process also has seven steps or phases.

Since the most powerful frequency vibrations in the universe and spiritual universes are those associated with love, it may be appropriate to show mappings with regards to the nature of love. As is the case with the seven wave process character, all things can be mapped this way, as well negative things that oppose these.

To start with love, in its many intricacies:

Loves Actions (+) (The different actions of love as a force)

1. Giving
2. Responding
3. Respecting
4. Knowing
5. Humility and Intimacy
6. Courage and Commitment
7. Caring

Love Gives/provides: (+)

1. Security
2. Pleasure
3. Vulnerability and Honesty
4. Trust
5. Intimacy and Caring
6. Reduced sense of loss
7. Knowing

Love Levels

1. Security love
2. Sensual love
3. Conditional love
4. Self love and Unconditional love
5. Societal (love of)
6. Humanity (love of)
7. Cosmic (love of the universe)

Negative Ego Gives: (-)

- Insecurity
- Pain
- Callous, lies
- Suspiciousness
- Beholden and unfairly obligated
- Loss
- Confusion and confounded

Next octave of Love levels

14. Total Being (love as)
13. Beyond self and energy (love as)
12. Merging self and energy (love as)
11. Energy (love as)
10. Thought (love as)
9. Idea (love as)
8. Motion (love as)

The next seven phases of love as levels (to the right above) has a correspondance as octaves to the previous. Thus, the 14th level of love is the higher octave of the 1st level, and the 13th level of love is the higher octave of the 2nd level, and so on...

While it can be seen that the first 7 levels of love are functioning within the physical universe with word terms appropriate to this universe as the soul being of human form, the 8 to 14th levels of love (the next 7) are functioning within the physical universe at a semi-spiritual level with the soul being passed over into non-physical form in Creation.

In addition, if one thinks about it, one can see the possibility that:

Fulfillment of Cosmic love is love manifest as as Motion - the essence of the cosmos

Fulfillment of Humanity love is love manifest as Idea

Fulfillment of Societal love is love manifest as Thought

Fulfillment of Self and unconditional love is love manifest as Energy

Fulfillment of Conditional love is love manifest as Merging self and energy

Fulfillment of Sensual love is love manifest as Beyond self and energy

Fulfillment of Security love is love manifest as Total Being - the ultimate security

Of course these correspondances may not be obvious to most of us, since in a real way we cannot function at the levels 8 through 14 until we have evolved beyond human form into greater non-physical spiritual form. But the correspondances are interesting anyway. (Pardon the intellectual foray)

To more closely assist the understanding of the kinds of love as stated above, it may be helpful to show certain of the subprocess or structure of certain components of love. Anything that moves and changes has seven (7) steps. Anything that is static and does not change has four (4) structured form.

In this way we can unfold the seven actions of love into a somewhat more detailed explanation and description, which unfolding could continue almost indefinitely such that it would begin to couple back into itself, but at different layers of holo-semantic detail and reference. Each level of actions of love are tangible, discernible and logical, although maybe not linearly logical and more often exponentially logical in holographic metaphorical manner. The fundamental requirement for love to exist with its seven actions and its seven potential provisions as detailed above is for "impact" to exist in the universe.

For impact to exist, one must allow all that is which ultimately is created by oneself to exist as real beyond ones creating it. That means, everyone is not just a figment of your imagination and that you are the only one and fundamentally alone, but rather that there are other beings which are real, who can impact you, either positively or negatively in your reality. Impact can be both positive and negative, constructive or destructive,

hurt or help. With 'impact' existing as a fundamental reality, there can be a god or a goddess, a friend, an enemy. With impact there can be the possibility of love.

#### Substructure/Process of Love Actions:

1. Giving: the focus of love, fundamentally, is to give.
  2. Responding: is a process of being responsible, of taking responsibility, which is a process:
    1. a) for positive realities in one's life: 4 formed cycle of:  
Recognize > Acknowledge > Appreciate > and Continue
    - b) for negative realities in one's life:  
Recognize > Acknowledge > Forgive > and Change
  2. Ownership of the reality or thing. Realizing it as ones own creation
  3. Functioning in the right Space and Time, in terms of right context and value.
  4. Being Adult - which is the synergy of four spiritual growth stages of human:  
Free child + curious adolescent + nurturing parent + positive ego  
as opposed to the negatived formed adult composed of:  
Manipulative child + adaptive adolescent + critical parent + negative ego
  5. Being Honest - in terms of acknowledging the truth of things and not avoiding them (you can see this is higher form of 3. above)
  6. Controlling the Ego form from not displacing ownership into blame of others, (accepting the reality of ones responsibility, not blocking it)
  7. Forgiving and Loving - self evident again it is hoped although there is a seven stepped process of forgiveness that could be shown
3. Respecting: is a four formed structure composed of:
    1. Giving. 2. Caring. 3. Knowing, and 4. Understanding
  4. Knowing: where one expresses awareness and knowing of something or another. To be known is to be loved, in this context.
  5. Humility and Intimacy: is composed of four formed structure of humility and seven formed process of intimacy:  
Humility:
    1. Looking anew each moment as fresh and to be known completely as new
    2. The Past does not create the present but serves only as a tool of reference

0538-K

3. Being detached from the past

4. Knowing everyone and everything is a tool to learn about love

Intimacy IS:

- 1. Closeness
- 2. Openness
- 3. Vulnerability
- 4. Trust
- 5. Loving
- 6. Caring
- 7. Privacy

Intimacy GIVES:

- 1. Closeness
- 2. Gentleness
- 3. Vulnerability and honesty
- 4. Trust and trustworthiness
- 5. Love and caring
- 6. Willing to risk humility
- 7. Understanding

6. Courage and Commitment: Self evident hopefully

7. Caring: is composed of different items, such as openness, empathy, willingness to risk being hurt, confidence. Confidence is built on the four formed:

- 1. trust, 2. humility, 3. hope and 4. courage.

To move on, towards further depths and relevant permutations we map the characteristics of a being and their environment, whom is operating the actions and givings of love:

Being Loving (+)	Being Loving Allows (+)
1. Honest caring	Allows life
2. Responsible	Eliminates blockages
3. Knowing and learning	Allows change
4. Respectful	Eliminates Ego power/control
5. Intimacy (higher form of 3.)	Allows me to stretch beyond myself
6. Commitment (higher form of 2)	Eliminates self pity and victim
7. Giving (higher form of 1)	Allows evolution

Doing Loving (+) (Different aspects of a person doing loving)

- 1. Keeps discipline
- 2. Thinks - uses their intellect
- 3. Has patience and listens
- 4. Is giving
- 5. Willing to be vulnerable (takes patience and learning)
- 6. Having courage (requires thought)
- 7. Is impeccable, has integrity (needs discipline)

Other than the mention above of the negative ego 'givings', i.e. where a being who does not operate with love, in order to operate at all, resorts to the ego 'doing it for them' and turns the neutral or positive ego force into a negative force, we also must begin to itemize the reasons that we don't function such love actions and givings in our lives as fully or as powerfully as is possible and available and necessary for real spiritual growth:

Blockages of Intimacy, Love and Caring (-)

- 1. Misunderstanding what love is
- 2. Being self centered (creation is not good enough for me)
- 3. Wants the Past and the right to manipulate and hurt
- 4. The seven above fears
- 5. Expects charity (does not want to work for future, wants past excuses)
- 6. Holds self as not deserving (I am not good enough)
- 7. Withholds ones Will (refuses to understand and appreciate).

There are reasons beyond even these that root someone into not even desiring to function in and from and by love. These are fundamental resistances that are born of the negative ego gone rampant, where the conscious being has abrogated their natural soul desires by refusing to think and feel and process their fears and blockages:



0538-L

**Important Blockages to Love (-):**

**Fears of Intimacy, Love and Caring (-)**

1. Fears the meaning of the keywords
2. Fears the responsibility to love and care and be intimate
3. Fears the impeccability is impossible
4. Fear of ego loss
5. Fear of growing up (children don't have to be impeccable)
6. Fear of being weak (if one is intimate and loving)
7. Fear from simple naivete' - unbiased action of fear

**Resistances to Love (-)**

1. Want to dominate and control
2. Afraid of responsibility of being loved
3. Enjoy punishing others
4. Don't feel am deserving to love or be loved
5. Determined to be a victim and live in self pity
6. Don't trust 'love'
7. Refusing to create own happiness, wants 'God' to do it for them

These resistances are enemies of evolution that produce stagnation and devolution towards what we could call an "evil" nature where pain or fear of it is the motivator for all things, rather than love. The mechanisms which function to preserve and replenish this "pain motivator addiction" of the negative ego are as follows (with the straight forward cures as well):

Enemies of Evolution (-)	Cures to these enemies (+)
1. Inertia	Start feeling and thinking for others
2. Projection	Being honest and responsible for anything
3. Indentification	Be intimate and intricate with someone/thing
4. Boredom and Restlessness	Start giving to and caring for others
5. Jealousy and Revenge	Say 'NO' to the Ego
6. Guilt, worry, depression	Find laughter and joys to have with something
7. Self Pity	Ask for help, be open to being loved

Just as we have elucidated the nature of responsibility as a major subfunctional process in the action of love of "responding", there exists the negative counterpart of irresponsibility and its mechanisms:

**Irresponsibility (-) (Responsibility shown above earlier)**

1. Blames others
2. Is a victim and lives in self pity
3. Blaming one's self
4. Refuses to change
5. Has false claims
6. Feels guilty and hidden anger
7. Is unconscious in actions

There are multiple reasons that love does not function in certain beings. Besides the above mentioned resistances and blockages and other related characteristics, there are particular causes that a being will adopt, 'payoffs' they will take, that allow for primitive metaphysical domination and manipulation to exist:

**Categories of Negative 'Payoffs' that prevent change:**

1. Avoidance - of honesty, truth, success, responsibility, visibility, confrontation, people, feeling, power
2. Blame - some will do anything to get the 'fun' of blaming, a 'competitor who undercut me', 'all women are ...'
3. Righteousness - about anger, hurt, holding one's position, refusal to resolve things, holding onto the reason one has to be feel hurt, loves a spotlight, loves to be angry, 'traffic brats', the intent is to never give it up. Only resolution is to get connected to the real anger underneath it.
4. Wanting a guarantee - a guarantee before one begins, 'I just want to be sure', attitude of wanting to shown the light before one takes off the blinders. This is not discerning, its wanting a guarantee
5. Self pity - poor me, feeling sorry for oneself, a victim or martyr
6. Self importance - need special attention, special, unique, better than, looking for perfection

7. Clinging to the past - want to punish parents, teachers, religious leaders, life is a bitch - then you die attitude, clinging to past to prove parents were right

In fact, for every level and quality of positive value in the maps of truth there are also negative potential counterparts. Knowing only the positive is only sufficient when one is not functioning any of the negative potential. What is wonderful, is that all one must do to into the operation of the positive is to recognize, acknowledge, forgive and change the negative potential in oneself and honestly function from the positive counterpart energy. This is called transmutation of the negative energy into a positive energy.

There are critically important self reflections and properties of a being who functions from positive self values as opposed to negative self values, and the difference between the positive and negative characterized values can be clearly traced to the functioning or love, or not, within the being or person in question:

**Levels of Self Knowing and Appreciation (+ and -)**

Universal Self Values	Universal Negative Ego Realms
1. Self Awareness	Self Ignorance
2. Self Worth	Self Centered
3. Self Esteem	Self Important
4. Self Love	Self Serving
5. Self Confidence	Self Delusion
6. Self Respect	Self Indulgent
7. Self Realization	Self Destructive

The person who fully operates from their positive self values above is indeed the enlightened person. It should be mentioned that self worth, self love and self respect are gifts that already exist and need to only be uncovered, whereas the others one must earn for oneself.

Once functioning within either the positive or negative self values in ones reality, there results either the property of having creative dominion or needing to dominate and control:

**Levels of Positive Dominion and Negative Domination (+ and -)**

Positive Dominion (+)	Negative Domination (-)
1. Creatively generate reality	Control and manipulate reality
2. Satisfied with ability and willingness	Wants to have power over others to act and create
3. Co-creates with Creational Being	Wants to be better, above Creation
4. Supports building spiritual Self	Supports building negative Ego
5. Sees world as abundant play of light	Sees world as scary place to be overcome- self centeredness as weapon)
6. Gives - joyously and generously	Wants to take and receive only
7. Loves and is loved	Wants to blame and criticize

Such co-creative dominion or controlling arrogant domination produces either a positive or negative set of metaphysical truths, which are each provable truths with the set one is functioning from:

**Levels of Positive and Negative Metaphysics (+ and -)**

Positive Metaphysics	Negative Metaphysics
1. Metaphysics is joyful opportunity	Metaphysic is weaponry
2. Metaphysics is a way to soar	Metaphysics is defensive
3. Allows the dance, and unknowns	Cover all possibilities, logistics
4. Create and co-create in Love	Manipulate before being manipulated
5. Program out of positive motivation	Program before being programmed
6. Expect the best and greatest	Always have retreat positions
7. Give 100%, ask 0%, w/discretion	Keep ledger and balance sheets/payback expectation

It is interesting to understand how all positive expression in creation also has a negative counterpart. As it may appear on close examination, many processes and structures enfold and couple into each other, and have common threads. This is because of

0538-M

the deeply interconnected character of these metaphysical truths.

The negative counterparts to many positive expressions of human character are dominant here on earth as we well know. With the help of a clear a full elucidation and explanation of the truth and her detailed understandings into a form that can be practiced in daily life, such of these maps can be built to show people how to transform from the negative character to the positive character. This of course is a beautiful to undertake.

However, given the extreme resistance that human beings and institutions of belief and negative character have from the fear of being eliminated or even opposed, it is clear that the advanced creational/universal truths will not be appreciated or understood as really important by most peoples in the near future. Yet it is possible to have many people learn the basics.

Whether one functions in a positive or negative mode or set of structures, processes and reality, there are some common fabric between them. Each being, whether human, alien, godly or primitive has the same fundamental properties of free will, gifted to each as souls within the creation from the beginning. These can be described as raw materials and tools we have to shape the raw materials, whether in a positive or negative manner and form:

We should realize that all we have is the 7 raw materials of our

1. Self,
2. Belief and
3. Attitude,
4. Feeling and
5. Thinking,
6. Decision and
7. Choice,

which are coupled with the 3 tools of

1. Desire,
2. Imagination and
3. Expectation.

No being no matter what level in evolution or spirituality has any more raw materials or tools. However it is clear that some beings are far more adept in working their tools and shaping their raw materials than others.

We must then begin to analyse what we have done with these raw materials and these precious tools, and with the power of the logic of truth and in honest humility to the true awesome beauty of it all, we can chart a course or build a bridge to move from negative to positive human and spiritual character, in what ways the material and spiritual developments can come into harmony for any human who honestly wants to grow and evolve beyond the limitations of the physical universe and it associated worlds and semi-spiritual stratifications.

While we are physical, the way to develop spiritual existence is through operating the 12 positive dynamic energies we can function and exercise as humans in the creation, composed of two kinds of energies - generating and sustaining energies:

The 7 generating energies: (+)

1. Trust
2. Gratitude (thankfulness, humility)
3. Joy and happiness (meeting preferences and needs)
4. Aliveness (Love, trust, expectancy, enthusiasm)
5. Love
6. Intimacy
7. Self Values (of Positive Self)

The 5 sustaining energies: (+)

1. Power of Will (towards meaningful Destiny)
2. Imagination/Vision
3. Confidence
4. Intimacy
5. Love

Where love and intimacy are found to have both generating and sustaining energy qualities. With these energies and our raw materials and tools, we can rapidly evolve our spiritual capacity and positively fulfill our work of evolution as physical beings in the physical universe. The functioning of these energies can only be effectively prevented by the 4 human stagnation causes of:

The 4 stagnation causes:

1. Beliefs too limiting and Image of self not large enough
2. Blockages of negative patterns and payoffs to Ego
3. Contracts and scripts - internal and external agreements and fear scripts as well
4. Chemistry and mechanics - dysfunctional DNA, endocrine, electromagnetic forces

To overcome and dissolve these stagnations, one must exercise the 12 energies, but also most critically have and exercise the freedom to:

- | Key Freedoms (+)          | used to beat stagnation beliefs (-):                                 |
|---------------------------|----------------------------------------------------------------------|
| 1. Perceive and Conceive  | vs. believing it is safer to stay in place, be 'normal', predictable |
| 2. Think and Evaluate     | vs. believing it is 'not for good of many' must 'conform'            |
| 3. Feel and have Passions | vs. believing its dirty and is a sign of weakness                    |
| 4. To Want and Need       | vs. believing its better to want nothing                             |
| 5. To Imagine             | vs. believing such is only for women and children                    |
| 6. To Give and Receive    | vs. believing such is naive and foolish                              |

7. To Heal

vs. believings such only Gods work or the Devils play

With these key freedoms we can eliminate our personal stagnation causes. But these stagnation sources can yet be traced back to certain derivations and particular styles that an individual has developed that keep these stagnations in place. Once one has recovered ones freedoms, one must the particular matrix that hold things in place, preventing real change and growth. That we metaphorically call the negative shield. The negative shield is that which each person uniquely holds for themselves often inscrutably through hundreds or thousands of physical lifetimes (incarnations), preventing spiritual evolution by severe measure. The negative shield is a metaphor for what stands between each person and the fulfilling of their positive human character dreams. Once again these are traced fundamentally back to love and the patterns that develop in resistance and blockages to love, the lack of receiving it, the patterns of pain operating when you your not having love, not giving love, not being loving, or being loved:

The 7 Components of the Negative Shield (-)

1. Reluctance and denial of Love (have to do it by myself)
2. Self punishment (deny the success, keep it out of reach)
3. Self sabotage (undercutting self, not satisfied unless all is perfect)
4. Addictions/Obsessions/Emotional poisons (Emotional and chemical drugs of blame etc)
5. Guilt as anesthetic and Depression (using these to numb the pain, guilt about addictions)
6. Lack of sense of Deserving (holding oneself as unworthy and useless)
7. Shame (crushes the freedoms - freezes one in impossible self fault)

The personal Negative shield must be replaced with the personal Positive Shield: The positive shield is the specific positive counterpart to the negative shield, with each positive shield energy and component being available when one releases or ceases operating the negative shield. The positive shield is that set of activities, behaviors, operating characters, and usages of the tools and raw materials to produce a reality where one functions from love and not from pain as the basic evolutionary modus operandi:

0538-0

The 7 Components of the Positive Shield (+)

1. Receiving Love (allowing others to nurture and love one)
2. Pampering self (allowing oneself to give to oneself - not indulgence but self care)
3. To have Power\* (willingness and ability to act)
4. Having Strengths\*\* (various empowered knowings of one's best capabilities)
5. Thinking and Feeling\*\*\*
6. Being Willing (takes courage)
7. Having Remorse (allows one to make amends and grow and improve)

Asterisks noted below in subsequent pages:

Once the positive shield is functioning, once the actions and givings of love are ones mainstay, once the raw materials and tools are being used for evolutionary growth as a spiritual adventurer and not as a spiritual (or otherwise) warrior, then what is there to be doing? Is evolution such this big melting pot in the sky. That would be awful, lonely, and a cruel joke. No, the more you evolve, the more you become, and that more is not simpler, but wonderfully complex, intricate and beautiful.

Those that say spiritual growth is to return to the "oneness of God" and 'give up' one's individuality and uniqueness, get absorbed into the big guy in the sky are making cruel adolescent simplification of the matter. What actually happens is that each one of us is already owning a small piece of the ultimate spiritual energy and consciousness that is God and Goddess and All that Is, and there is much that is beyond us as well in those domains and possibilities. As we grow we become more and more of who we can be, never losing a single bit of the positive and valuable uniqueness that we have been are or will become. As that expands, eventually, yes, eventually we can have full relationship with that God/Goddess/All that Is that we came from originally and which has continued to grow as well since we were first birthed as individual souls.

Eventually we as souls, beyond the physical, can become the level of macro-expansive God/Goddess/All that is that we started from, but more than that as well with all the unique microcosmic quality, beauty and differentiation we have evolved, yet very possibly still less than that original

God/Goddess/All that Is which since we were birthed has gone on to grow yet more. Ultimately each one of us is all of it, part of it, and none of it, depending on your point of view and cause for viewing it one way or the other for the timeless moment that each would ever be relevant in growth!

But back to our first steps as spiritually developing humans, what do we do and what permutations of the raw materials and tools exist and can be developed to work with. These permutations are known as powers and strengths. We could detail the negative counterparts but will leave that to the readers thinking capacity, if ones wants to discern such:

\*There are 14 kinds of Power (+) (7 lower octave, 7 higher octave)

- |                 |                                        |
|-----------------|----------------------------------------|
| 1. Productivity | 14. Having Compassion                  |
| 2. Commitment   | 13. Thinking esoterically/esthetically |
| 3. Evaluation   | 12. Perceiving and Conceiving          |
| 4. Forgiving    | 11. Love                               |
| 5. Intellect    | 10. Impact                             |
| 6. Caring       | 9. Integrity                           |
| 7. Will         | 8. Vision                              |

\*\*There are 14 kinds of Strength (+) (7 lower octave, 7 higher octave) - these match # for number with Powers above as complementary, cooperative energies.

- |                       |                                    |
|-----------------------|------------------------------------|
| 1. Creativity         | 14. Ability to have Passion        |
| 2. Discernment        | 13. Esoteric/esthetics Discernment |
| 3. Courage            | 12. Communication                  |
| 4. Ability to Forgive | 11. Ability and capacity of Love   |
| 5. Curiosity          | 10. Leadership                     |
| 6. Empathy            | 9. Humor                           |
| 7. Imagination        | 8. Ability to Dream                |

Once again, these powers and strengths are related in a feminine and masculine energy counterpart manner with power being feminine and strengths being masculine in nature (feminine and masculine detailed in pages to follow). The counterpart points are # to # across the power and strengths list. Both are really required to function well. The powers can stand on their own, but the strength rise from the empowerment of the powers.

These strengths are impeded and reduced by the actions and character of negative ego development as well as the masks of negative ego in the form of martyrhood and victim:

#### What keeps one from having Strength

1. Arrogance of specialness, grandiosity - smarter, better than, more sensitive, creative - don't have to stop to deal with problems or lacks, have secret scheme to 'show them'
2. Perfection and performance - upward mobility, parental dictates, competition, perform for approval, perfect body, perfect relationship, perfect children (child abusers) - perfection is really a mask for arrogance
3. Afraid of impact - fear of power, to avoid having negative impact have no impact at all - must forgive self about what went wrong and give self permission to have impact
4. Lack of realness - not real, just a body automaton going through the motions of life, not in touch with self values, false esteem, living on aspirations and good intentions, seeking approval
5. Fear of visibility and vulnerability - might get criticized, might get hurt, remain impotent and weak
6. Lack of knowledge and permission - waiting for 'god' to tell me 'be strong'
7. Addicted to one's payoffs

\*\*\*Thinking and Feeling arise from the two different energies of masculine and feminine character in the Creation, and each unto themselves has a 7 component intricacy (not sexual gender based, for these energies exist in both males and female person forms):

7 Masculine Energies (+)	7 Feminine Energies (+)
1. Willing/Acting/manifesting	Imagining/Feeling/Desiring
2. Creating Form to fill context	Creating Space/context
3. Focus to create Structure	Receive and Nurture
4. Dynamic Creation	Ability to Create

5. Search for Meaning/understanding      Allows Percepti
6. Providing and Protecting              Balancing of all things
7. Doingness                                  Beingness

In simpler structural terms of 4:

Masculine Key Energies (+)	Feminine Key Energies (+)
1. Will	Imagination
2. Thinking	Feeling
3. Action	Conceiving/Conception
4. Meaning	Perceiving/Perception

However, there can be imbalances in the way that Masculine and Feminine energies function within humans. To illustrate the possible examples of imbalance, we can show the worst case illness situations in this respect. While many of these imbalances will seem to be referring to a particular gender- male or female - note that while this is so, it is not restricted to gender at all, as wimp\* men and dominating women can testify:

Too much Masculine/Too little Feminine Energies:

1. Chauvinism - maleness preference, disenfranchises women, they do not have value.
2. Reality filled with form - looks, statistics, things, title, grade, status quo, women focusing on hunkism, men focusing on women as sex objects, men as success objects
3. Dehumanized machine - suppressed, stuffed feelings, just functioning to 'get more', all doing oriented, 'work' machine, 'play' machine, 'growth' machine
4. Imprisoned by the image of Man or Mystique of Woman - unable to admit any feelings
5. Caught on a world of domination - control or be controlled, manipulate or be manipulated, dominate or be dominated
6. Alienated from the world - no sense of why one is living, a vacant living for today only
7. Active self pity - in a kind of victimhood, victim of the reality one has created

Too much Feminine/Too little Masculine Energies

1. Hatred of men and things masculine - men are bullish, stupid, clutzy, idiots, men hating men and women hating men, female chauvinism, female is better than
2. All content and no form - all these potentials but can't put it together, person with degrees but no job, person with 'novel' ideas but no book written

3. Harbouring negative emotion - refusing to transmute, unable to transform, want to hold onto the anger, can't forgive, the moody play, dwelling in endless anger or fear
4. Stagnation of dreams/ self delusion/ fantasies - decaying dreams, delusions of grandeur and brilliance and success
5. Destructive manipulation - domination and control out of vengeance, hatred, jealousy, hurting for hurtings sake
6. Functioning in potentia/ always the grand scheme - the get rich scheme that never happens (men), the 'if I just had the money' (women)
7. Diminishing, decreasing, denying the self - all being and no doing, passive self pity, martyrhood, passive victimhood

To finally navigate oneself out of these many many forms of impediments to the positive shield functions that are natural expressions of life as it is motivated from and in love, there are certain key knowledges and recognitions that are mostly either too obvious or too hidden to be noticed. These are the 7 secrets of manifestation, the 7 secrets of empowerment, and the 7 secrets of spirituality:

#### The 7 Secrets of Manifestation:

1. Physical reality is an illusion - one must create FROM the spiritual world of emotional realness and thought and vision which is REAL into the ILLUSION of the physical world - otherwise you're just fighting entropy with some biological instincts and that doesn't cut it
2. You are a conduit of the future - your vision of what CAN be is the blueprint that the present follows to become what it WILL be
3. You must take charge, take dominion (not domination). Dominion is ownership at a spiritual level of the world one lives within, and the world that lives within. Domination is control over, not the same thing
4. You must let miracles happen. There is more going on than what you can perceive that is 'on your side' and is available to help. You must give yourself permission to allow that help in, usually from one's higher self, future self, and inner guides within
5. The ILLUSION is WHAT you create. What is REAL is HOW and WHY you created it
6. Love is more powerful than self pity. Positive emotion is more powerful than negative emotion. Expressed emotion is more powerful and suppressed emotion.
7. What exists NOW is from the FUTURE, not the PAST, contrary to newtonian belief systems.

#### 7 Secrets of Empowerment:

1. Love one's self and love another - love one's self enough to be able to love another
2. Love one's self and love what is beyond one's self within - have some humility
3. Function from Value of self (detailed above)
4. Be willing to die the past and regenerate who one is from ones futura - vision, heart and stride of what can be as opposed to what has been
5. One should celebrate one's relationship to one's spiritual self, and one's relationship to that which is beyond one's sense of possible self - that which is the essence of love and caring and intimacy in life
6. One must choose a destiny, not wait for it to be given. What one chooses is what is right until it isn't. Waiting around for divine guidance can result in coma.
7. Surrender to that which is one's best sense of growth and 'going home' within. Surrendering to divine will is not letting someone tell you what to do, because divine will is that you tell yourself what to do - the essence of free will is the divine will

#### The 7 Secrets of Spirituality:

1. You directly create or indirectly allow your reality, every little bit of it, no fine print
2. The future creates the present - what you are is what you will become AND change only occurs in the now
3. There are no steps to becoming spiritual - you already are, else you wouldn't even be. There is only the ambience and dance and poetry of relationship with that love that is greater than you that you have without any prerequisites
4. The key is dominion - ownership of one's reality as one's own. Dominion is gained by spiritual ownership not material ownership and domination
5. It is critical to detail and act on one's self image - to stretch one's concept of oneself, of who one is, what one can do and be in the world - one must bust one's limiting self image and build a new one to allow for a new and larger reality to be held that is consistent with that image
6. There are no steps, only choices. Choices can be instant, growth however is forever, but it is not a linear set of grades, it is a nonlinear compass of possibilities

7. Everyone gms it spiritually. Some sooner than others, some take seeming eternities longer than others, but still, in the final analysis everyone makes it, 'good and bad' human and alien alike. The physical universe exists as a system for spiritual and evolutionary growth - and it works, in time. And since at the levels beyond the physical universe there is no time, in that time is only a concept at higher levels, all physical evolution takes 'no time at all' from that point of view!

Hopefully you can see as the drawing out of the various issues that all originate from the issue and reality of love, and may develop a rather full mapping in sevens (7's) and fours (4's) of the evolutionary possibilities and characters, both positive and negative.

There are many many more levels and strata and unfoldments and refoldments that could be elucidated, but what has been presented if only somewhat actualized and assimilated and realized in ones life on a day and day out basis can produce an absolutely giant immense evolutionary leap in one capabilities and impact as a spiritual being functioning in the physical universe in a body on Earth today!

#### The Final Hypotheses Matrix

This report has attempted to navigate through a wide range of loosely interrelated hypotheses relating to a possible set of realities that all can find one of two common issues within them - 1. observational veracity and socially related control or 2. extraordinary realities regarding alien contact and influence.

The report focuses on the one central issue that binds these two threads into one inseparable cord that can tow the line of all these disparate challenges to sanity and freedom. That cord is the exploration and command of spiritual forces resident within each human being that can directly influence and even control the two original threaded issues.

Finally, the value of the cord towing the line of social, psychological, political, alien and religious influences and controls in effect on this planet is distilled into a discourse of "truth maps" relating to the essence of human and universal spirituality. This mapping process reveals the essential tensions at a refined level between the natural course of spiritual evolution and the components of resistance to such evolution.

The outcome of these rather distilled spiritual truths being mapped is several back reflective inferences provided for much of the report:

1. The focused essence of the 'good-evil' or 'malevolent-benevolent' patterning as a function of 'pro' and 'con' orientations relating to love and its evolutionary expansions.
2. The nature of a substantial and impactful process of 'spirituality' as an available evolutionary advancement which supercedes and 'controls' much of the problems associated with aliens and mind control and physical/social control detailed in this report.
3. The undiluted maps of truth without manipulative power strings attached providing the ability to properly navigate the complex forms of negative and limiting beliefs, systems, intentions, processes, and strategies associated with political, religious and social control and suppression systems.
4. The practice of one's own spirituality as a living breathing dynamic of taking responsibility for one's creative and controlling powers to shape one's destiny according to self determination by right, and not other's determination by might.
5. The development of wisdom and understanding that allows an effective means to put rather fearful freedom impeding activities on the part of aliens and human social structures alike into contexts of larger truths that pin down these negative power potentials to a level that can be coped with and ultimately fully managed and transcended by the 'little' individual.
6. The re-ordering of one's individual life and spirit to defuse the negative potentials as they are seeded or programmed within one's own conscious, subconscious, unconscious realms to effectively disconnect any possible attractive and fueling forces to the possible negative potentials that have existed on a social and global level. In effect, give the collective subconscious and collective unconscious blueprinted realities the 'slip'. And ultimately, enough to fully defuse their spiritual compliance to these collective scripts, and with new positive self programmings, cause the dismantling of the global negative 'set'.



0538-T

7. — 7. Once having fully owned one's own spiritual power potential and practicing it, without custodial go-betweens, without negative payoffs, without negative allegiances, without compromising one's self determination or free willed discernment, without accepting mystery and covert compliance to manipulation, without corruption or pollution of one's sense of possible future vision and personal or planetary destiny, and without limitation of personal and global win-lose game scripts, THEN the vast majority of what has been discussed as 'negative, enslaving and real' in this report becomes shallow, moot, untrue, and just irrelevant to YOUR reality!

#### A Final Note On Biases In This Report

Any astute reader should be able to detect a number of important and impertinent biases in this report, not the least of which is the assumption this report can be of use to anyone.

To help provide an 'out' for anyone who wishes to disqualify this report as representing any great objectivity whatsoever, the following list of biases is indicated so the door is wide open:

1. "Truth" is approached as a relative thing. It is treated as if multiple opposing and incompatible truths can co-exist, which for many minds may not be possible.
2. "ET's" are approached as existing, real entities, which are in the habit of visiting and "messing around" with Earth and its inhabitants. Existing ET's are treated as being the real extraterrestrial type, the physically effective interdimensional and human unconscious mind projected types.
3. "MJ-12", or something like it, is treated as being real and bona fide, with a number of directives supported by a powerful secret infrastructure. It now has a different name.
4. The "Billy Meier Case" is treated as being real and bona fide, and his Pleiadean contacts and beamships as being real and having happened as he relates in over 2000 pages of contact conversation transcripts.
5. The William Cooper materials as related in Linda Howe's book "An Alien Harvest" are treated as being essentially true and correct.
6. The William Cooper (May 89) "Secret Government" manuscript and the John Lear (December 87) "letter" are treated as being essentially true, albeit certain statements within are also treated as being incorrect and synthesized by Cooper's mind.
7. William Moore, Stanton Friedman, Jamie Shandera, Phil Klass, and others are treated as being knowing or unwitting secret government operatives, which may be totally incorrect and unfair, however they are assumed as such anyway based on other's analyses and the authors analysis and information. Speaking of which, in the November 89 Mufon Journal wherein

Moore does a valiant job 'clearing' himself and 'di... editing' the Bennewitz case as holding any water is either a honest and therefore he is being maligned in this report, or b) an excellent job of back paddling on his blown cover.

8. Human "free will" and "spirituality" and "choice" is treated as being extremely powerful and capable of creating whatever it wants, including multiple dimensional Earths if necessary to accommodate human spiritual choice and free determination. Tools and maps relating to the same are limited to being developed from just a few "good sources", which "goodness" is entirely in the opinion of the authors of this report. These tools and maps are however nonsecular and considered to be universal.
9. Sources not listed in the bibliography are not read or not included, and so there exists bias in the limitations of the sources used, including the limited experience of the authors.
10. Hatonn and Sananda and Ashtar and their "scribe" Dharma, though no longer directly mentioned, are generally treated as being bogus and the mad ravings of a psychotic who may occasionally be channeling some real aliens but probably not. The previous revision of this report gave them more airtime and 'reality'. This revision cuts out most all the airtime to them, and only refers to the fact that there is a lot of 'Christian alien' stuff going around which could impact peoples perception of real bona fide aliens. The idea of Christian aliens and such supposed alien's ideas are central to much human collective unconscious archetypal symbolic language, and as such may be real and sincere from their origin and its points of reference.
11. The existence of a secret government which is dedicated to the management of the alien reality is assumed. This government is so cloistered in multiple layers of secrecy and decoy and suppression that very few actually are aware of it in the government except for those compartmentalized and isolated groups primarily associated with black military programs of the highest orders of secrecy which are not funded through standard black military program congressionally approved funding.
12. The secret government's use of disinformation, debunking, ridicule, and malignment of bona fide ET and UFO information and contacts is assumed to be occurring. It is assumed this activity is mostly effected remotely by unwitting operatives who are fed counterdata and counterbeliefs suitable for the doing the job in a highly layered disclosure mechanism. Deniability is the single most important mandate in this mechanism.
13. There are assumed to be three types of aliens - benevolent, neutral and malevolent aliens, when in actual fact they may not be so easily classified, and there may be more gradations than '+', '-', '0', and the classification may radically change depending on which context of reference is used (see "definitions" section).

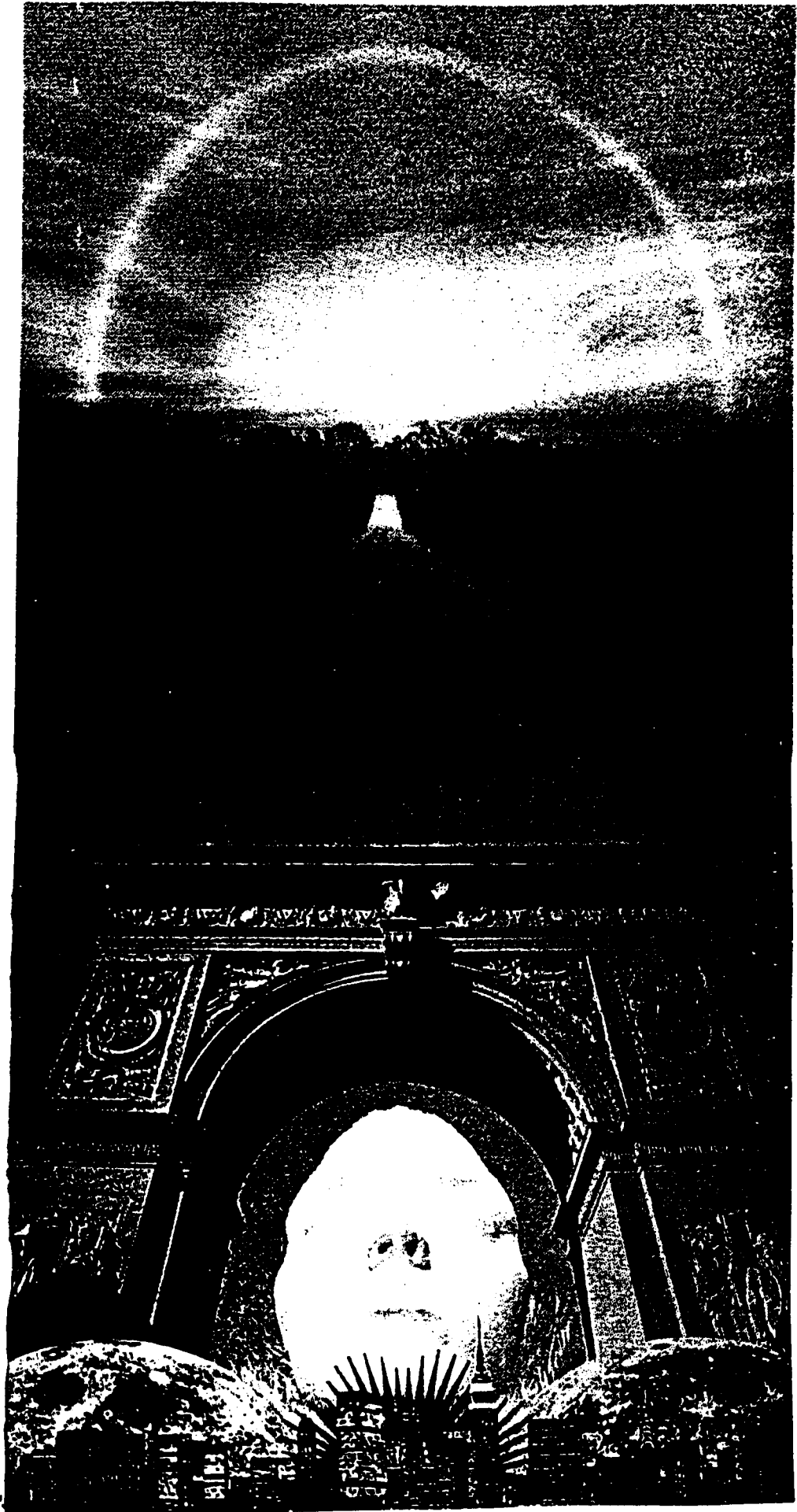

CHAPTER 9

The Final Scenario : ONE WORLD ORDER

OUTLINE

I. PRESENT DAY SCENARIO - THE "SILENT WAR" TO ESTABLISH THE ONE WORLD ORDER (OWO)

- A. Economical Tactical Factor (ETF)- Economic Colapse of World Economies
- B. Chemical/Biological T. Factor(CBTF) - Population Control
- C. Psychological T. Factor (PTF) - One World Religion & Universal Spirituality
- D. Logistic T. Factor (LTF) - Concentration, Detention, Quarantine Areas, Relocation
- E. Termination T. Factor (TTF) - Elimination of Undesireable Social/Ethnic Groups

II. THE ONE WORLD ORDER PLAN: TOTAL WORLD CONTROL & UNIFICATION

- A. Total Economic Control(TEC) - One World Central Bank/One World Currency(Phoenix)
- B. Total Psychological Control(TPC) - BACA: The One World Religion & Spiritual Centre
- C. Total Technological Control(TTC) - Electronic Mind Control/Engineered Behaviour

III. TOTAL ECONOMIC CONTROL - APPROPRIATION OF CURRENCY, LAND, LEASES & RESOURCES

- A. 4th World Wilderness Congress: Denver/Estes Park, 11-18 Sept. 1987
- B. The World Conservation Bank(WCB) - The Ownership Conspiracy of World Wildernesses
- C. The World Central Bank(WCB) - Collapse of WCB & Inception of World Central Bank

PURPOSES OF THE 4TH WORLD WILDERNESS CONGRESS

- 1) Enact the start of the financial nucleus of a world government.
- 2) Create, in public view, the framework of the World Conservation Bank.
- 3) Create a façade that a "democracy" created this world federal reserve bank for the New World Order.
- 4) Disclose some of the inner Party of the New World Order (New Era).
- 5) Create the means to distribute collectivized wealth throughout the earth on an "equal basis" and to place its distribution control into the hands of the Elite.
- 6) Suggest a World Monetary Unit (possibly "The Phoenix")
- 7) Suggest a World Central Bank concept.
- 8) Introduce the "Custodian of the Planet", Maurice Strong, possible planner and executive head of the New Age-inspired One-World Religion.
- 9) Enact international ecology goals and platforms and provide for their enforcement through a World Conservation Corps of 300,000 corps members.

IV. BACA: ONE WORLD RELIGION, SPIRITUALITY, MYSTICAL CENTRE & COSMIC TEMPLE (Colorado)

160,000 Acres, Sangre de Cristo Mountains, Colorado.

Swami Sri Aurobindo; Sheila Devi, Divine Universal Mother, Spiritual Directors

A. UNIVERSAL AND WORLD RELIGIONS & SPIRITUAL GROUPS REPRESENTED

- |                                             |                                             |
|---------------------------------------------|---------------------------------------------|
| 1. Savitri Ashram, Sri Aurobindo            | 8. Episcopal & Baptist Churches             |
| 2. Babaji Ashram, Shiva Shrine, Sheila Devi | 9. Muslim/Sufi Learning Centre              |
| 3. Zen Institute                            | 10. Essenes School of Life                  |
| 4. Eiheji Zen Buddhist Monastery            | 11. Taoist Retreat Centre                   |
| 5. Carmelite Catholic Monastery             | 12. Dingo Khenise Rinpoche, Tibetan Monast. |
| 6. School of Hebraic Studies                | 13. Native American Elders Council          |
| 7. Lama Gampo, Tibetan Buddhist Temple      |                                             |

- B. LANDISFARNE TEMPLE: SACRED GEOMETRY, HARMONIC RESONANCE TO TRANSMIT PSYCHIC ENERGY
- C. Creation of New Consciousness & Radiate to Whole World- Harmonics of Base 6-6-6

V. ELECTRONIC MIND CONTROL(EMC)- ELECTRONIC BRAIN STIMULATION/BEHAVIOUR ENGINEERING (EBS/BEH)

- A. Summary of EMC Projects, Scopes, Methodologies & Objectives
- B. Planetary Grid Programming - Putting the Great Mother to Sleep/Store Programming
- C. Underground EMR, RF, & ELF Penetration - Electric and Magnetic Phenomena
- D. Time-Release & Activation of Disease - Mutation of Viruses via Microwaves

# M A T R I X I I I

## W A R N I N G   A N D   A D V I S O R Y

### PLANETARY CONSPIRACY THEORIES

In the following pages, material is presented which appears to reflect the most outstanding conspiracy theories that exist as of May 1992. None of the material between pages 540 through 690 is seen as absolute "fact", and should be related to your own personal experience and knowledge. It is being presented simply because it exists, and may shed some light in your consciousness about planetary events. No specific aspect of what is contained in those pages is deemed by the author to be indicative of a specific probable reality to follow; all of it should be examined in the light of your own consciousness.

There is no doubt that there exist many hierarchies of "planned actions and activities that are contrived covertly", which is to "conspire". There also is no doubt that these activities revolve around the factors of money, power and drugs.

Any activity that exists in these areas is performed by those who operate with their consciousness in negatively-oriented polarities through the lower brain structures. In that sense, it is understood WHY they are doing what they are doing. You must endeavor to understand everything that is occurring in a cultural sense from a higher perspective in consciousness - not to do so would result in your being trapped in a tunnel reality where you would, like the majority of human beings, remain in a state of perpetual fear and self-induced vulnerability.

To assure that the material is viewed from this aspect, YOU MUST READ AND COMPREHEND THE MATERIAL IN CHAPTER 8 BEFORE YOU READ PAGES 540 THROUGH 690. To read them in a state of social consciousness is not advised, as you could be predisposed to launch your consciousness into severe depression and despair.

MATRIX III must be taken AS A TOTALITY in consciousness. It is not meant to be taken in terms of its separate sections.

## M A T R I X I I I

### FORMS OF GOVERNMENT AND THE PLANETARY SITUATION

Various forms of government exist on this planet, and they can initially be divided into two sociological forms:

1. "Rule by God": Theocratic forms
2. "Rule by Man": Various forms

Under the second heading, there are several common types that are briefly defined as:

Anarchy - rule by no one.  
Dictatorship/Monarchy - rule by one.  
Oligarchy - rule by a few.  
Democracy - rule by the majority.

Anarchy is a form of government that is a transitional one that appears between the collapse of one form and the assumption of another form. It is generally true that even a dictatorship or monarchy is run by a small, ruling minority; a dictatorship and a democracy are in truth oligarchical forms of government, since they are in truth run by a small number of elite, so the previous list can be reduced to various forms of oligarchical governments with spurious cases of anarchy in between. The only true form of government, then, is actually an oligarchy, rule by a minority.

What is a democracy? It is the form of government that is passed off as "the only true workable form of government" to the people on the planet. A Democracy, by definition (1928), is:

A government of the masses, where authority is derived through mass meeting or any form of direct expression. The attitude toward law is that the "will of the majority shall regulate, whether it be based upon deliberation or governed by passion, prejudice, and impulse, without restraint or regard to consequence; it eventually results in demagogism, agitation, discontent, and finally anarchy."

If democracies are in truth oligarchies, where the minority rules, is there a form of government that protects both minority and majority rights? Yes. It is called a Republic, where the power rests in a written constitution, wherein the powers of the government are limited so that the people retain the maximum amount of power themselves.

When unscrupulous individuals manipulate a democracy, which is a shaky situation to begin with, it can turn into anarchy very quickly. The popular belief systems of the majority can be turned against groups of people. Alexander

## M A T R I X I I I

Hamilton was aware of this tendency for a democratic form of government of government to be torn apart by itself, and he was once quoted as saying:

"We are now forming a republican form of government. Real liberty is not found in the extremes of democracy, but in moderate governments. If we incline too much to democracy, we shall soon shoot into a monarchy or some form of dictatorship."

It should be obvious by now that democracy leads toward tyranny. Let's examine the original list in another way:

Democracy - Might makes right. Law restricts people.  
Republic - Right makes Might. Law restricts government.

In terms of the current conditions existing in the U.S., the original republican form of government has been undermined for the last 100 years, converting it into an interesting mix of democracy and socialism. The process of conversion appears to parallel programs which have been proposed for a transition to socialism (remember that fascists are national socialists):

- Step 1: Infiltrate the existing government.
- Step 2: Create real or alleged grievances, through either an action or inaction by the infiltrated gov't.
- Step 3: Create a "mob rule" situation through the real or alleged grievance where the populace demands that the created problem will be solved through government "action".
- Step 4: The infiltrated government proposes remedies through oppressive legislation.
- Step 5: Repeat Steps 2 through 4. The legislation that is passed does not solve the "problem" and the people demand more and more legislation until the government becomes totalitarian in nature by possessing all the power.

Total power is the ultimate goal for the creation of situations that the populace perceive as "problems". Once the infiltrated government maintains control over the money supply, energy, and food, it has total control over a populace that has been coerced into a state of total disempowerment; this reflects the current cultural situation (or the way it is developing) on the planet. Some of the "problems" that are levied on the populace appear as "internal" threats (drugs, crime, and various events that imply social instability that cry out for increased levels of oppressive legislation) and "external" threats (invasion by extra-terrestrials, asteroid impacts, the fictitious 'cold war', etc). All of the "problems" are constructed in such a way that they fragment and divide the population and set it against itself (which, for a population that functions within the lower neurological brain

M A T R I X I I I

structures, is easy to do) and tends to focus on sociological concerns which relate to the primary triplet of security, sensation and power (the reflective of the triplet is Insecurity, Isolation and Disempowerment). Each triplet is the other triplet unmanifested but present as an implicit unconscious principle that can be manipulated in what is basically an unconscious, unaware population.

Back to forms of government. The five principles that were mentioned before were used by Adolph Hitler (not forgetting of course that the forces which supported the rise of national socialism in Germany have their origin within the United States and the elite of Europe) and are being applied everywhere on the planet as you read this book.

After the United States essentially went bankrupt in 1938, the property and people of the U.S. were pledged to the world bankers as collateral; a parallel development has been happening relative to the environment. If you take a trip to the Smokey Mountain National Park, you will see a sign outside the park that says that the park is part of the "World Conservation Bank", or something very similar to that. What has been happening is that debt-ridden countries (the U.S. owes the most to the world bankers) have been signing over their lands to the world bankers in an attempt to offset their debt. It is rumored that Price Charles, for example, now owns the whole Amazon basin. Don't take my word for it - check it out for yourself.

A major factor that must be taken into consideration when evaluating forms of government is how they view material goods:

<u>Economic System</u>	<u>CAPITAL GOODS</u>	
	<u>Owned By</u>	<u>Controlled By:</u>
Free Enterprise	Private Owners	Private Owners
Communism	The State	The State
Fascism	Private Owners	The State
Socialism	The State	The State

In viewing the above, you can see why you do not actually own anything in the United States. The State maintains the actual "title" to your car and your land. You maintain a type of secondary "title" to your car and a "warranty deed" to your land. If you actually OWNED your land, you would not be liable for property taxes on it. Research indicates that there are over 60 different ways that you, as a "citizen" establish what are called "adhesion contracts" with the government, both state and federal, in which you essentially agree to disempower your own authority. However, we could go on forever about the nuances of adhesion contracts - it lies outside the scope of this book.

## M A T R I X I I I

According to some sources, three distinct forces are apparent on this planet:

"The Christ Force"  
"The Luciferian Force"  
"The Ahrimanic or Satanic Force"

Now, recall that all these forces have their origin within consciousness. All of them represent One force used in three distinct ways. You have an essence of what the Christ force aspect means (read the piece by Michael Topper). The Luciferian aspect is one that suits the NWO purpose (the NWO represents the Ahrimanic Force) because it is inherent as a distracter for humans, the purpose being to keep the focus of humans on everything but who they are, as well as knowledge that will enable them to progress in consciousness. In truth, this is the main tenet of individuals like Zbigniew Brzezinski who, in their published works, view the mass populace as nothing more than cattle who need to be amused and kept busy (ironically, because of the inherent structure of society that is in place, people are encouraged to put themselves in exactly that situation, both sociologically and in consciousness).

As far as the Ahrimanic Force is concerned, there are ways in which they influence, control, and suppress human society:

1. Promote situations where higher conceptual ideals of "soul" and "spirit" are downplayed by "official" "science".
2. Promote situations where humans are inspired to hold contempt, suspicion and antagonism toward anything that leads to genuinely spiritual considerations.
3. Promote idolatry of goods and services.
4. Promote perversion of cultural life so that nothing is deemed worthwhile "unless it puts food on the table".
5. Promote a physically-oriented social consciousness that maintains a tunnel-reality that precludes the existence of anything outside the senses of the physical body.
6. Promote concepts and actions which divide humanity and set it against itself.
7. Promote ceaseless "political" strife in which both "sides" of various issues fail to recognize that within their own reality-tunnels their ideas are of equal value and equally justifiable.
8. Promote dead scientific concepts while at the same time violently suppress scientific knowledge that could have



## M A T R I X I I I

the effect of promoting the evolution of the race.

9. Promote dead education, characterized by rote memory procedures that are passed off as "learning". Promotion of rigidification of the natural biological correspondences that exist in children with cosmic processes.
10. Promote idolatry of numbers and empirical processes, as exemplified in the "computer age" with its inherent dehumanization of life.
11. Promote anti-life thought patterns and processes within the culture and the environment.
12. Promote tedium in life, as exemplified by the endless progression of "toys for adults" and modes of living that feature processes that have as their goal more acquisition of the "same thing".
13. Promote obsession with "measurement", which amplifies Item 5.
14. Promote cultural processes which play on genetic tendencies and drives for security, sensation and power.

The list could go on. Where is YOUR consciousness? What brain structures are YOU using? If you are not CONSCIOUS, when are you going to WAKE UP? If you are happy with the "status quo", then you deserve everything involved with it, don't you?

Time and time again, it has been repeated to you that the key to it all is CONSCIOUSNESS. CONSCIOUSNESS IS THE NAME OF THE GAME, EVERYWHERE IN THE UNIVERSE. GET CONSCIOUS, GET AWARE, TAKE YOUR POWER BACK AND LIVE LIFE!!

One thing to never forget is that THERE IS NOTHING THAT IS INHERENTLY PRESENT IN ANYTHING THAT YOU SHOULD FEAR. FEAR IS THE KEY TO MANIPULATION OF THOSE WHO ARE NOT CONSCIOUS.

The various species loosely referred to as the Greys use technology to amplify their conscious group abilities. Do you not realize that there is a reason that you have all that "brain power" in your head that remains unused? If there is nothing in nature that develops before it is needed or used, then why do you have it there? Truthfully, empowered conscious human beings who know who they are can do more with their consciousness than any technology can do - that is why humans are so "dangerous" and "need to be suppressed". Do you understand? Now, read the material in Chapter 9, but don't get caught up in the exterior drama of it - use it for understanding and knowledge about the parameters of the drama, GET CONSCIOUS-FOLLOW WITH ACTION!

## M A T R I X I I I

Power is an ability of using energy and force to Create and/or Destroy.

Used with little, false or no knowledge of the true nature of things and being ignorant of purposes and plans of organization inherent in all life, one without knowledge who uses power will surely create destruction and/or destroy creation. This is observable in the highest echelons of planetary government in the "Old Civilization".

Balancing and far outweighing the small percentage (2% or 3%) of people who have the "power without knowledge" insanity, are the millions of people of Earth who have knowledge of life, the truth of what it takes to survive, the duty and loyalty of their family and friends, and the trust that others will exchange, work and play in a fair and honest, friendly fashion as they do themselves. These millions, (some 97% of the population of Earth) are the source of all the good things and survival components of the civilization.

Then why is the "old civilization" in such poor condition? Because the Power that the insane 2 or 3 percent are using is continually being given to them by the 97 percent. It is given in the form of financial energy (taxes), controlling force (by obeying those who suppress or destroy freedom and initiative) and confidence (by electing those who take the fun out of life's games to get and keep more power for themselves).

And this power is given and the insane actions not halted by the 97% because they:

- 1) Believed there was no alternative, and
- 2) Were not organized, so
- 3) Thus, did not recognize that they were the largest Power source on the Planet, and
- 4) They were the Source of ALL the suppressive power being used against them, and
- 5) They would take the Power away from the 2 or 3 percent at any time by just not giving it to them.

Note: It is an observable fact that also part of the power given to the 2 or 3 percent was used to carefully mis-educate the 97 percent into not having the knowledge of 1), 2), 3), 4) and 5) above. (For example, controlled media repeatedly being used to voice the "belief" that there is no alternative.)

***" It is not the Government's role to impose orthodoxy on America's citizens - nor to impose a couple of obsessed individuals' views of what is acceptable and what is not. "***

***Supreme Court Justice Robert Jackson***

## M A T R I X I I I

### THE THOUSAND YEAR REICH - THE FIRST FIFTY YEARS

Just because the German Army surrendered, it does not necessarily follow that the Allies won World War II. War, especially world war, is far more than just a military maneuver; it also has economic, social, and political ramifications. Certainly, the Allies won a military victory over the Nazis, but that is all that is certain. Within only forty years after World War II, the economy of both Germany and Japan was much stronger than that of the United States, Britain, and Russia, who fared far worse in the wake of what is generally accepted as their victory. This chapter will explore some of the political and social ramifications of the second, and hopefully the last, world war.

Anyone who knows anything about 20th century history will recognize this chapter's title as the salutation that opened and closed nearly every communication in Germany's Third Reich, but what does the average American really know about this group that nearly conquered the world? Surprisingly, very little. Volumes have been written on the subject but few have taken the time to read even basic primers like The Rise and Fall of the Third Reich, as such histories are tedious in their detail. Public opinion of the Nazis has been drawn largely from motion pictures, newsreels, documentaries and articles that are too often subjective, one-dimensional propaganda. Since the story of Jonestown has its roots in Nazi Germany, to understand the full impact of the experiment some common misconceptions about the Nazis must first be dispelled.

Contrary to the widely accepted belief, the Nazis were not anti-Semitic, they were pro-Aryan and there is a distinct difference. The fair-skinned, predominantly blue-eyed, blondes of Nordic descent were heralded as the master race while all others were considered sub-human. The Nazis did murder six million Jews in the Holocaust, but they also murdered an additional six million Slavs, gypsies, intellectuals, drug addicts, criminals, communists, and homosexuals. The only reason that Jews dominated the ranks of the oppressed is that they dominated the sub-human population in Europe. Had the Nazis risen to power in, for example Africa, Blacks and not Jews would have been murdered en masse.

The 1936 Olympics, held in Berlin, is a prime example of the Nazis' attitude toward Blacks. Germany

## M A T R I X I I I

proudly presented its finest Aryan athletes like Luz Long, who carried the honor of the master race but who was repeatedly defeated by the Black American, Jesse Owens. The German press called Owens and other Black athletes "auxiliaries" and "little more than trained baboons" Hitler exemplified the official Nazi position by refusing to congratulate Owens after he won an unprecedented four gold medals in the competition.

Though it is rarely portrayed as one, World War II was a race war, or at least the Nazis perceived it as such. The Allies, on the other hand, were fighting a traditional border war in which geography or nationality dictated whether the citizenry was friend or foe. To the Nazis, the enemy was not the United States or Russia but the sub-humans, some of whom were in their own country of Germany, others in Europe and others still in the U.S. and Russia. Likewise, the Nazis' alliance was with the master race living everywhere not just in Germany. As the German Army conquered more and more of Europe for "Aryan living space," many of the occupied peoples were classified sub-human and sent to the concentration camps while many of Aryan heritage were rewarded and welcomed into the Third Reich. While the Allies were fighting countries, the Nazis were fighting people, and this basic conceptual difference permitted both sides to win. The Allies won a military victory over Germany, but Germany won a social and political victory over the United States where their philosophy was embraced by many German-Americans (who today comprise the largest ethnic group in the country).

This story begins in an intra-structure of the Nazi Party known as the Schutzstaffel or simply as the SS. The SS was formed in 1926 with 280 charter members whose original function was to guard Adolf Hitler. After two rather ineffective leaders, Hitler appointed Heinrich Himmler, a quiet, mild-mannered poultry farmer and expert genetic engineer, as Reichsfuhrer SS. Under Himmler, the SS grew in numbers and prestige both before and after 1934, when it was made an independent faction of the Nazi Party. Enrollment had increased to 30,000 members recruited from Germany, Austria, Norway, Denmark and France. They were the elite of the master race and the heroes of every aspiring German boy who dreamed of the day that he too could wear the black SS uniform with its stylized twin lightning bolt emblem. The tight-fitting uniform was also cause for young girls to dream.

## M A T R I X I I I

The SS was so diversified as to defy a simple description. They were not a military unit, per se, though Himmler did establish an armored division known as the Waffen SS whose primary function was, not to engage in battle but, to follow the German Army and reorganize the conquered countries. They also served as very impressive parade troops. Furthermore, Himmler established an intelligence gathering division as the Security Service of the SS or Sicherheitsdienst (S.D.) as the Nazi spy ring was called. Himmler also organized Germany's sixteen police forces into the Gestapo under his command. Another SS division, identified by their skull and cross-bones emblem, was charged with managing the several concentration camps set up in old German factories soon after the SS became a separate entity in 1934. One of the SS tasks was to implement Himmler's plan to purify the Aryan race in the first 125 years of his proposed "Thousand year Reich." Their plan was two-fold; eliminate the sub-humans and procreate the master race. Himmler would breed the Germans as he had bred chickens on his poultry farm. The SS might best be described as a fraternity whose varied membership that numbered in the hundreds of thousands by the outbreak of World War II, took the following oath,

I swear to thee, Adolf Hitler,  
loyalty and bravery. I vow to  
thee and to the superiors whom  
thou shall appoint, obedience  
until death.

It was Heinrich Himmler's SS, and not the German people or even the German military, that was solely responsible for the Nazi atrocities.

One of the most bizarre and insightful activities of the SS was to scour the world in search of any and all knowledge of the occult and psychic phenomena. Though Hitler's and Himmler's interest in the occult has long been reported, the influence the occult exerted on their careers has never been fully appreciated. Soon after World War I, Hitler joined a number of German occult lodges, most notably the Thule Gesellschaft, a coven that delved into the Black Arts, required its members to abstain from alcohol and meat (to enhance their necromancy rites) and preached a doctrine of Aryan superiority under an ancient Tibetan symbol: the swastika. Obviously, the experience had a profound effect on Hitler. It has been proposed that

## M A T R I X I I I

Hitler intended to appoint himself as God upon conquering the world and this was the source of his obsession with the occult. From African voodoo priests to Himalayan monks, from Christianity to letterology, every religion, sect or cult present in the world as well as in recorded history was closely scrutinized by the SS. They attempted to compile the most comprehensive study of man's spiritual experience and to a large extent they succeeded.

By 1937, Himmler had bled the German occult lodges for all that they had to teach so he outlawed them in order to eliminate anyone who possessed even a fraction of his knowledge. Covens, such as the A..A.. and the O.T.O. were disbanded. The principal figure in both was Aleister Crowley who regarded the Nazis as "Creatures of Christianity" for their persecution of the Jews. Hitler did report in Mein Kampf that, as a young student in the Benedictine Monastery in Lambach, he dreamed of one day being ordained a priest. To this day, his relationship with the Catholic Church remains a very controversial issue. They never excommunicated him; not even posthumously.

Hitler and Himmler were the foremost authorities on the occult in the world and perhaps even in the history of the world and the following is presented as an example of the extent of their knowledge. Their basic discovery, or rather rediscovery, was the one dogma common to all religious beliefs, man is an energy force in a physical body. Primitives called it a spirit. Christians call it a soul and portray their saints as having a nimbus or halo about their head. To a Hindu, it is an aura or astral body and their gods and goddesses are depicted as being surrounded by a glowing energy field. Many people in the past and present claim to have the ability to see this rainbow-like aura that surrounds every person and attests to his character as well as his physical and mental state. Regardless of how different cultures view the aura, most all agree that it exists and is crucial to life as the absence of it is the true definition of death. Perhaps Himmler's initial interest in the aura was to develop new techniques to separate body and soul that could kill without bullets or poisons, but his research was to take a different course.

The SS scientists under Himmler determined through modern methods that when a person concentrates

Being a lineman for the county can be hazardous to your health. So can being an electrician, a computer operator, an embassy worker — or even a housewife.

The danger comes from a new kind of radiation pollution: electromagnetic impulses. Most of these impulses are generated by power lines, radio and television signals, and by ordinary household electrical current. Microwaves are a menacing and ubiquitous new source, used for applications as diverse as telephone transmissions and home cooking.

Currently, there are no mandatory government standards regulating levels of electromagnetic radiation. Voluntary standards recommend a maximum 10 milliwatts per square centimeter; Russia and some Eastern European countries have set mandatory standards that are 1000 times stricter, standards they have based on disturbing health effects observed in the past thirty years.

Electromagnetic impulses produce nonionizing radiation, which differs from the ionizing radiation produced by X-rays, cosmic rays, or radioactive materials. Ionizing radiation is at very high energy and literally rips atoms apart. Nonionizing radiation has enough energy to agitate atoms, but does not destroy them. At high levels, the agitation creates heat, thus cooking cells from the inside out — the principle behind microwave ovens. What lower levels can do is

By Jack Joseph Challem  
and Renate Lewin

taken in the 1950s based on military experience with radar, is that nonionizing radiation either cooks you or it does nothing. Though faced with ridicule, several researchers are countering this all-or-nothing stance and are beginning to produce studies indicating incredible and subtle effects from a form of radiation we can neither see or feel.

The first humans to be subjected to a microwave experiment were not volunteers but victims. On September 14, 1983, six maintenance workers at an Alaskan Air Force base were repairing a giant radar dish that they thought had been shut down. Suddenly, the workers' flashlights were

Photo by Charles Laner



## Electromagnetic Radiation: A Growing Hazard

controversial. Scientists in Russia and Europe and increasing numbers of their American colleagues have found alarming disturbances of brain, nerve, endocrine, and reproductive function. The U.S. Environmental Protection Agency (EPA) has tentatively proposed new limits on nonionizing radiation produced by radio and television transmitters. Numerous occupational health groups, as well as some state legislatures, have ruled on acceptable levels of worker exposure to computer screens. However, the official position on this radiation, a position first

blinking, even though they were not turned on. Then the workers felt mysteriously warm and were gripped with nausea. Quickly fleeing, the workers realized that the massive radar dish had been switched on accidentally and was cooking them alive with its microwaves.

Since the incident, five of the six workers have suffered medical problems for which no one can find a clear cause. Technically, they escaped injury, yet they continue to experience mental and visual problems. Studies since the 1960s have also indicated a mysterious connection be-

tween microwave radiation and cataracts, muscle weakness, and brain problems, yet the official medical view on nonionizing radiation remains cautiously conservative.

### INVISIBLE WEAPON

Cynics claim that industry, heavily dependent on computers and telecommunications, has a vested interest in seeing that electromagnetic radiation is not regulated. Some reporters have even warned that microwaves can become a subtle and invisible weapon to disrupt mental and physical health, and that this is why the Soviets bombarded the American embassy in Moscow with microwaves for thirty years.

Others suggest that the dangers of this radiation have gone unnoticed thus far not for nefarious reasons but only because they are so wide-ranging, nonspecific, and subtle: microwaves and radio waves in low doses do not burn but are quickly absorbed deep into the body, bypassing skin nerves that ordinarily warn of invasion and damage. Scientists have been able to sear deep-seated bones with nonionizing radiation without causing any disturbance of the skin.

In tests with laboratory rats at the Veterans Administration Hospital in Loma Linda, California, as little as 60 hertz of nonionizing energy — about what escapes from a leaky microwave oven — adversely affected immune response.

In Spain, Dr. Jose Delgado and colleagues at Centro Ramon y Cajal Hospital stunned the medical world by proving that extremely weak, low-power electromagnetic pulses, similar to those emanating from computer terminal screens, caused serious defects in chicken embryos and spawned lethal mutations in fruit flies.

Critics point out that Dr. Delgado's waves were not *exactly* like those coming from computers, yet the scientific community admits being perplexed that any such low-level types of radiation, previously thought safe, could be dangerous after all.

Empirical evidence also raises danger flags. Of twelve pregnant computer terminal operators in a company

in Georgia, seven suffered miscarriages and three gave birth to deformed babies. In a British governmental office heavily dependent on video display terminals, 22 percent of pregnant workers had deformed babies, 14 percent aborted spontaneously, and seven percent delivered dead babies. At first, such clusters were considered statistical coincidences, but their ever-increasing numbers worldwide have made many scientists and health officials suspicious.

---

### CANCER

---

Arthur W. Guy of the Bioelectromagnetics Research Laboratory at the University of Washington, has exposed 100 rats to electromagnetic pulses equivalent to or lower than the current voluntary U.S. standards. After three months, the animals were in a state of heightened immune stimulation, often resulting in impaired adrenal function and development of tumors. A 1984 EPA summary document corroborated this link between radiation exposure and immunity, reporting negative changes in blood count, immunity, and overall health among animals exposed to radio waves.

Some scientists interpret these results to mean that nonionizing radiation is a source of "nonspecific stress." Significantly, Dr. Guy's laboratory animals also showed a fourfold increase in cancer when compared with a control group of rats. In humans, brain cancer is more prevalent among those frequently exposed to nonionizing radiation, including people such as electricians, telephone repairmen, utility workers, and electrical engineers.

Electromagnetic radiation can affect mood as well as molecules. In fact, Dr. Delgado's first experiments in Madrid involved mind control of animals. At one time, to prove his point, Delgado stopped a charging bull in its tracks, just inches before his feet, using a radio pulse transmitted to an electrode in the animal's brain. Subsequently, Delgado has proved that direct brain/electrode contact is not necessary, as he lulls monkeys to sleep, or makes them climb walls, using only subtle variations in the electromagnetic field of their cages.

No one is exactly sure why low-level doses of "safe" radiation have such profound and far-reaching effects. Dr. Ross Adey in Loma Linda, California, has shown that nonionizing radiation alters the flow of calcium in the body and brain. Because calcium ions control muscle contractions, autonomic responses, neurotransmitters, and many aspects of cellular metabolism, even small alterations in their actions can cause a biochemical reaction.

Another suggestion is that the pineal gland, the body's master gland that controls the "biological clock," is attuned to fluctuations of the natural electromagnetic fields created by the Earth's poles. Outside interference from manmade radiation may thus scramble these electrical signals.

Because life developed within the radiation of the Earth's geomagnetic field, our cells and calcium-dependent enzyme systems are extremely susceptible to any alteration in this basic environmental condition. In fact, full reversals of the Earth's electromagnetic field do take place every few hundred thousand years — accompanied by mass extinctions of life forms dependent on the old configuration.

Dr. Robert O. Becker, an orthopedic surgeon who has used nonionizing radiation medically, has told reporters that uncontrolled changes in levels of this radiation could lead to slow extinction of many life forms, preceded by years of increasing cancer rates, nervous disorders, stress, and birth defects. He feels that it is no coincidence that three ambassadors at the American embassy in Moscow, long subjected to nonionizing radiation for espionage purposes, eventually developed cancer and other health difficulties.

After thirty years, officials have still not disclosed the reason for the embassy irradiation. Results of blood tests on embassy workers remain classified as well, but monkeys have been experimentally exposed to the same levels of microwave energy. One monkey in the tests fell into a deep stupor after ten days and did not revive until all irradiation ceased.

Those who say nonionizing radiation cannot possibly have any effect may be able to dispute the negative fears that some scientists have, but it is less easy to deny the positive find-

ings, which have been documented for a longer time. Orthopedic surgeons have long been aware that electromagnetic impulses of the right frequency promote tissue proliferation, thus accelerating healing of bone fractures. Stubborn tendinitis, low back pain, burns, skin wounds, and even epilepsy have responded.

Currently, over 120 million television receivers and six million microwave ovens are in use in America alone, not to mention the innumerable power lines and radio, television, and telephone transmitters. If you are feeling a little powerless in the face of all these invisible waves, do not despair. Research is rapidly confirming the profound effects of nonionizing radiation, so there is hope that it will no longer be ignored, but controlled.

In the meantime, what can you do to protect yourself? First, keep the electromagnetic level of your household low. Avoid unnecessary gadgetry, keeping your home and kitchen manual where possible. Electromagnetic radiation does not easily travel far from its source unless purposely focused to do so; at least you can control the environment in your own home. Of course, it's best not to live directly under power lines either.

Nonionizing radiation seems to target the immune system, the nerves, the brain, and the glands. Nutrients that strengthen these systems are essential protection. Vitamins C, E, and A are antioxidants that buttress the cells against biological attack. The B-vitamins, especially stress-specific pantothenic acid and choline, guard the nerves. If you must venture into highly energized environments, avoid eating sugary foods. Nonionizing radiation tends to derange insulin production so that blood sugar problems will be intensified.

In time, perhaps electromagnetic energy will be harnessed, becoming not a threat but an aid to greater health. □





## ELECTROMAGNETIC FIELDS - INFORMATION SHEET

Evidence exists which suggests that excessive exposure to electric and magnetic fields (EMF) may pose a risk to human health. This evidence has been derived from three distinctly different types of studies. These studies are:

- Cellular level studies
- Whole animal or human studies
- Epidemiologic studies (studies of human populations)

These different types of studies have shown that:

1. Exposures to electric and magnetic fields can cause changes in the flow of certain ions through cell membranes.
2. Exposures to electric fields can alter the rhythmic activity cycle that naturally occurs in most organisms.
3. Exposures to electric and magnetic fields may cause abnormal embryo development in animals under specific circumstances.
4. Exposures to electric and magnetic fields have shown a positive (but weak) association with certain types of cancer in epidemiologic studies.

Because this field of research is new, the evidence for these effects is by no means conclusive. Some or all of the above findings may change in the near future. However, after reviewing what is currently known about exposure to electromagnetic fields, the Washington State Department of Health, believes that this is an issue of concern. Because of this concern, the Department recommends adopting a policy of *prudent avoidance*.

A policy of prudent avoidance means taking reasonable action to limit exposure to electromagnetic fields. On the individual level, people may want to limit prolonged exposure to known sources of high fields. For example, because there is close body contact throughout the night, use of electric blankets or electrically heated waterbeds that produce high fields should be limited. On the other hand, appliances that are used for short periods of time (such as electric shavers) pose less of a concern. We believe, however, that it is too early to recommend extensive changes to lifestyle or residence since we do not know if these changes would be beneficial or even necessary. On a broader level, the Department of Health feels that utility companies and manufacturers of electrical appliances and equipment should develop strategies for prudent avoidance that will reduce exposure to the consuming public.

The pamphlet, "Electric and Magnetic Fields from 60 Hertz Electric Power: What do we know about possible health risks?", written by Dr. Granger Morgan at the Carnegie Mellon Institute, describes further what is meant by a policy of prudent avoidance. It also provides an explanation in non-technical language of what is known and not known about potential health risks associated with exposure to EMF. A copy of this pamphlet can be obtained by calling the Department of Health at (206) 753-5935.

TABLE 1

Non-ionizing Electromagnetic Energy Radiation Standards		
General Public Exposure		
American Conference of Governmental Industrial Hygienists (ACGIH)	30 - 100 MHz	1,000 uW/cm <sup>2</sup>
American National Standards Institute (ANSI)	30 - 300 MHz 300 - 1500 MHz	1,000 uW/cm <sup>2</sup> f/0.3 uW/cm <sup>2</sup> *
Canada	1 - 300 GHz	1,000 uW/cm <sup>2</sup>
Connecticut	30 - 300 MHz	1,000 uW/cm <sup>2</sup>
New Jersey	30 - 300 MHz	1,000 uW/cm <sup>2</sup>
US Military	30 - 300 MHz	1,000 uW/cm <sup>2</sup>
International Radiation Protection Association (IRPA)	10 - 400 MHz	200 uW/cm <sup>2</sup>
Massachusetts	30 - 300 MHz	200 uW/cm <sup>2</sup>
Multnomah County, Oregon	30 - 300 MHz	200 uW/cm <sup>2</sup>
National Council on Radiation Protection and Measurement (NCRP)	30 - 300 MHz 300 - 1500 MHz	200 uW/cm <sup>2</sup> f/1.5 uW/cm <sup>2</sup> **
Portland, OR	30 - 300 MHz	200 uW/cm <sup>2</sup>
New York City, NY***	All	50 uW/cm <sup>2</sup>
Czechoslovakia	.3 - 300 GHz	25 uW/cm <sup>2</sup>
USSR	40 - 300 MHz	25 uW/cm <sup>2</sup>
<p>* f = frequency in Megahertz (MHz). Using this formula, the exposure standard for the frequencies that will be used by the proposed tower (800 - 900 MHz) would be between 2,666.67 and 3,000 <del>uW/cm<sup>2</sup></del> <sup>uW/cm<sup>2</sup></sup></p> <p>** f = frequency in Megahertz (MHz). Using this formula, the standard for the frequencies that will be used by the proposed tower would be between 533.3 and 600 uW/cm<sup>2</sup>.</p> <p>*** The New York City standard was not adopted as law, but has been recommended by public health staff and included by the planning commission as a condition of approval of large new facilities.</p>		

# **Electric and Magnetic Field Reduction: Research Needs**

**The Electric Transmission Research Needs Task Force**

**January 15, 1992**

**Washington State Agencies:**

**Department of Health**

**Utilities and Transportation Commission**

**State Energy Office**

**For more information, contact the Department of Health, Office of Epidemiology,  
P.O. Box 47813, Olympia, Washington 98504-7813; phone: (206) 753-5935**

## **Comparisons of Power Line Design and Resulting Electric and Magnetic Fields**

This section compares how different power line designs affect electric and magnetic fields. Data for making these comparisons were generated by the Electric Transmission Research Needs Task Force with the assistance of the Technical Committee. The Task Force and Technical Committee identified a range of parameters which would affect electric and magnetic field strength, then prepared field projections based upon altering these parameters.

First, "base case" designs for both transmission and for distribution were defined. Next, several transmission and distribution alternatives were identified and compared to the base cases. Alternatives were developed within the separate categories of transmission, distribution three-phase, and distribution single-phase. Alternatives within each category were structured to be capable of delivering equal amounts of power. Electric and magnetic field projections were made using computer software developed by Vernon Chartier of the Bonneville Power Administration and Dr. Robert Olsen from Washington State University. These programs are in common use and provide accurate results provided line current and geometry are known. The results of this exercise are presented in the following pages, including a discussion of assumptions, description of alternatives, comparative field projections and observations from these comparisons. Cost estimates for each alternative are also provided.

### **Transmission Line Design**



Numerous conductor and support (pole or tower) configurations are used for high voltage transmission systems. It has long been known that different conductor configurations create substantially different electric and magnetic fields in both

magnitude and shape (Moore). To demonstrate these differences, ten alternatives capable of delivering 125 megawatts (MW) of electrical power are described on the following pages. (This amount of power is about one-tenth the average power used by Seattle.) These alternatives are not all inclusive, but represent a range of available techniques for reducing EMF, relative to one another. Comparison of the general magnitude of these differences, when weighed against other considerations such as cost, maintenance factors and reliability, gives one insight into the relative value (in field reduction) of incorporating certain measures into line design.

Unbalance on transmission systems is typically much lower than on distribution systems. It has been found that the range of unbalance on transmission lines generally does not contribute significantly to the magnetic fields produced. For the purpose of this analysis, it is assumed that there is around 5% current amplitude variation, and a two degree phase angle variation of unbalance on transmission systems.

Table 2 compares the electric and magnetic fields associated with each alternative design at various distances and provides a graphic of each design considered. Specifics concerning transmission conductor geometry (i.e., conductor positioning) and phasing for each alternative are contained in Appendix 3.

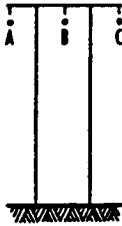
**Table 2 - Transmission Line Designs: "Base Case" and Alternatives**

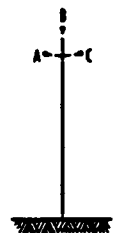
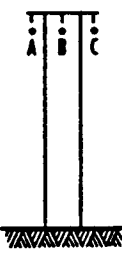
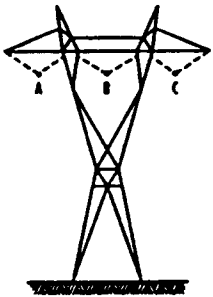
Description	Graphic of Configuration	Cost/Mile (thousands)	Magnetic Fields (milligauss)			Electric Fields (kilovolts/meter)		
			under	40'	200'	under	40'	200'
<b>A. "Base Case"</b> - 230 kV - 300 amps, - 125 MegaWatts - Wooden H-frame - 19 foot spacing		230-260	59.6	29.7	1.6	2.6	1.9	0.04
<b>B. Vertical Delta*</b>		220-250	27.0	11.0	0.6	1.9	0.7	0.04
<b>C. Horizontal Delta</b>		220-250	28.9	9.8	0.5	1.6	0.7	0.03
<b>D. Decreased Voltage</b> - 115 kV - 600 amps, - 11 1/2 foot spacing		200-230	91.5	34.4	1.9	1.0	0.6	0.01
<b>E. Increased Voltage</b> - 500 kV - 138 amps, - 30 foot spacing - Steel lattice tower		400-500	24.4	18.9	1.2	5.5	5.3	0.1

\* Differences between base case and alternatives to base case are described beneath alternative title.

Description	Graphic of Configuration	Cost/Mile (thousands)	Magnetic Fields (milligauss)			Electric Fields (kilovolts/meter)		
			under	40'	200'	under	40'	200'
<b>F. Double Circuit/Split Phase</b> - 150 amps per conductor - Steel pole		350-400	14.5	4.8	0.1	1.7	0.6	0.02
<b>G. Multiphase</b> - 6 phase line - 132 kV - 150 amps per conductor - Steel structure		380-450	16.7	6.7	0.4	2.5	0.9	0.05
<b>H. Single Circuit Steel Pole</b> - vertical configuration		275-350	36.2	22.1	1.5	2.7	0.8	0.1
<b>I. Underground Line - Fluid Filled Steel Pipe</b> - buried 5 feet below the earth's surface		1500-2000	4.9	0.2	0.01	0	0	0
<b>J. Underground Line - Dry Type Cable, Non-Magnetic Pipe</b> - buried 5 feet below the earth's surface		1500-2000	14.7	0.6	0.03	0	0	0

In brief, the ten different alternatives are as follows:

#### ***Base Case***

A conventional flat, horizontal conductor arrangement operated at 230 kilovolts (kV) with 300 amperes (amps) current for 125 megawatts (MW) of power, supported by wooden H-frame poles.

#### ***Vertical Delta***

A triangular conductor arrangement in which the triangle formed by the three conductors has a vertical side; operated at 230 kV with 300 amps for 125 MW power delivery.

#### ***Horizontal Delta***

A triangular conductor arrangement which raises the height of the center phase conductor above the outside two so that the triangle has a horizontal side; operated at 230 kV, with 300 amps current for 125 MW power; placed slightly higher above ground than the base case and supported on wood poles.

#### ***Decreased Voltage***

Use of the flat, horizontal line configuration as in base case; operated at a lesser voltage of 115 kV with 600 amps current to derive 125 MW power.

#### ***Increased Voltage***

Use of the flat, horizontal configuration as in the base case; operated at a higher voltage of 500 kV and only 138 amps to deliver 125 MW; supported by steel lattice towers.

#### ***Double Circuit/Split Phase***

A vertical arrangement of two circuits, one circuit on either side of the supporting structures, where the phases on one circuit are running in the reverse of the opposite circuit; operation at 230 kV and 150 amps per conductor to deliver 125 MW.

#### ***Multiphase***

Also called "high phase order" transmission; use of six rather than three-phase conductors in a circular arrangement; operated at 132 kV with 150 amps current per conductor to deliver 125 MW; supported on steel structures.

#### ***Single Circuit/Vertical/Steel Pole***

Stacked arrangement of conductors one above the other, supported by tall steel poles; single circuit line with 230 kV at 300 amps to deliver 125 MW.

#### ***Underground Line/Fluid Filled Steel Pipe***

An underground cable contained in a fluid filled steel pipe; operated at 230 kV with 300 amps for 125 MW.

#### ***Underground Line/Dry Type Cable/Non-Magnetic Pipe***

An underground cable encased in non-magnetic pipe operated at 230 kV with 300 amps to deliver 125 megawatts.

From Table 2, we draw the following conclusions.

1. There is a large variation in the fields resulting from different alternatives. Magnetic fields directly under (or above, if underground) transmission lines range from 91.5 mG (decreased voltage) to 4.9 mG (underground fluidfilled steel pipe). A typical flat, horizontal configuration, the "base case" is estimated to generate a 59.6 mG field directly below the line.

2. When comparing overhead alternatives, the highest magnetic and lowest electric fields result when voltage is reduced, the amount of power delivery remaining constant.
3. Conversely, of all the overhead alternatives, increasing the voltage results in the highest electric fields, and lower magnetic fields, *assuming equal power delivery.*
4. The greatest field reductions are accomplished by undergrounding transmission lines in a steel pipe filled with fluid. Electric fields are eliminated and magnetic fields are reduced from 29.7 mG (base case) to 0.2 mG, calculated at forty feet away from the centerline in each case. This particular underground alternative also results in reduced magnetic fields when comparing field strengths immediately under the base case line (59.6 mG) and above the underground line (4.9 mG). The magnetic field reduction is due to cancellation from the phase spacing and not shielding. The cost of this type of construction is estimated to be six to seven and one-half times more than the base case depending on the particular circumstance.
5. Next to undergrounding, the greatest magnetic field reductions are achieved using either a double circuit/split phase or multiphase arrangement. The double circuit/split phase arrangement achieves magnetic field reductions of around 4 to 16 times, by comparison to the base case, depending on the point of measurement. The multiphase design achieves magnetic field reductions of around 3.6 to 4.4 times, by comparison to the base case, depending on the point of measurement. The costs of these alternatives are estimated to be 53% greater than the base case for the split phase alternative and 69% greater for the multiphase alternative.
6. The two delta type configurations examined achieve very similar magnetic field reductions

when compared to the base case, that is, a magnetic field reduction on the order of approximately 2 to 3 times in either case, depending on the point of measurement. These alternatives are comparable in cost to the base case.

### Distribution Line Design

Magnetic fields from distribution systems can be more complicated than those around high-voltage transmission lines because there are sometimes two circuits, a higher voltage primary and a lower voltage secondary which connects to customer equipment. The net current flow (the non-zero vector sum of all currents flowing on all the conductors) results in an uncanceled (or net) magnetic field component (Moore). Net current results when not all of the return current flows on the lines but instead, a portion flows in the earth. Net current can also result when low-voltage return currents from customer loads disperse through ground connections and do not return on the neutral wires from the house to the distribution transformers (Moore). The magnetic field from net currents falls off less rapidly with distance from the lines than magnetic fields from a set of conductors carrying no net current.<sup>1</sup>

For the purpose of comparing the field characteristics of various distribution designs, and for the sake of simplification realizing the multitude of alternatives and assumptions that can be made about the amount of unbalance and earth return current, distribution alternatives were defined within the following parameters. First, each alternative includes only primary circuits. Second, all cases assume 20% current amplitude variation and 5 degree phase angle variation of unbalance on the system and, for lack of being able to quantify an arguably better assumption, 50% return current in the earth at a depth of 1000 meters. The assumption regarding the amount of earth return is probably very conservative (i.e., high).





<sup>1</sup>Independent of its impact on EMF from distribution lines, net current can sometimes be the dominant source of background magnetic fields inside a house or building (Johnson). Because the scope of ESSB 6771 is limited to electric and magnetic fields from distribution and transmission lines, the Task Force did not explicitly address the issue of reducing magnetic fields associated with net current inside homes and other buildings.



Seven three-phase alternatives and three single-phase alternatives were studied for delivery of 6.5 and .72 MW respectively. These power levels result from practical current levels for these

configurations. Brief descriptions of each alternative follow, with more detailed descriptions contained in Appendix 4. Graphic representations and field levels are found in Table 3.

Table 3 - Distribution Line Designs: "Base Case" and Alternatives\*

Description	Graphic of Configuration	Cost/Mile (thousands)	Magnetic Fields (milligauss)				Electric Fields (kilovolts/meter)			
			under	20'	40'	200'	under	20'	40'	200'
A. "Base Case" - 12.5 kV - 6.5 MegaWatts - 40 ft. pole - 10 ft. crossarm - 4 foot sag		50-70	22.4	14.9	7.7	2.2	0.05	0.05	0.03	.003
B. Increased Pole Height** - 55 ft. pole		60-80	10.1	8.1	5.3	2.1	0.02	0.02	0.02	.004
C. Increased Voltage - 25 kV - 47.5 foot pole		60-80	6.9	5.1	3.1	1.0	0.07	0.06	0.04	.007
D. Compact Delta		55-75	13.1	8.8	4.9	1.9	0.03	0.03	0.01	.003
E. Double Circuit/ Split Phase - 47.5 foot pole		80-120	3.3	3.1	2.5	1.2	0.03	0.03	0.01	.003

\* Assume 50% return current in the earth,  $\pm 20\%$  current amplitude variation and  $\pm 5^\circ$  phase angle variation.

\*\* Differences between base case and alternatives to base case are described beneath alternative title.

Description	Graphic of Configuration	Cost/Mile (thousands)	Magnetic Fields (milligauss)				Electric Fields (kilovolts/meter)			
			under	20'	40'	200'	under	20'	40'	200'
<b>F. Random Lay Underground</b> - buried 3 feet deep - 7.5 inch phase spacing		120-600	56.3	9.8	4.7	1.9	0	0	0	0
<b>G. Underground Line In Conduit</b> - buried 3 feet deep - 2.5 inch phase spacing		120-600	31.2	8.4	4.4	1.8	0	0	0	0
<b>H. Single Phase Crossarm</b> - 7.2 kV - 0.72 MegaWatts		30-40	14.5	12.8	8.6	3.6	0.09	0.08	0.04	.010
<b>I. Single Phase Headpin</b> - 7.2 kV - 0.72 MegaWatts		30-40	8.5	8.3	6.4	3.2	0.08	0.06	0.03	.008
<b>J. Single Phase Underground</b> - 7.2 kV - 0.72 MegaWatts - buried 3 feet deep - concentric neutral		100-450	51.3	15.4	8.0	3.2	0	0	0	0

### ***Base Case***

Conventional horizontal arrangement strung on wooden poles, around thirty feet off the ground; voltage is 12.5 kV with 300 amps for delivery of 6.5 MegaWatts (MW).

### ***Horizontal (Base Case)/Increased Pole Height***

Same as base case except the conductors are around 45 feet off the ground rather than 30.

### ***Increased Voltage***

Utilize base case/horizontal arrangement and increase voltage from 12.5 kV to 25 kV with 150 amps for 6.5 MW.

### ***Compact Delta***

A triangular conductor arrangement, with conductors spaced 24 inches apart, around 2,731 feet above the ground.

### ***Double Circuit/Split Phase***

Placement of two three-phase circuits on either side of a single structure, with phase conductors stacked one above the other from 32 to 36 feet above the ground; use of 12.5 kV at 300 amps for delivery of 6.5 MW.

### ***Underground/Random Lay***

Placement of conductors three feet beneath the ground, randomly laid, with a phase spacing of 7.5 inches apart, directly in the ground; voltage is 12.5 kV with 300 amp current for power delivery of 6.5 MW.

### ***Underground Line in Conduit***

Placement of conductors in a non-magnetic conduit so they are constrained to approximately 2.5 inches apart, three feet deep, using 12.5 kV at 300 amps for 6.5 MW delivery.

### ***Single Phase/Crossarm***

Placement of a single phase on a pole, around 29.3 feet above the ground; a crossarm supports both the phase conductor and the neutral; use of 7.2 kV and 100 amps current for .72 MW power delivery. (When one phase of a 12.5 kV circuit and the circuit neutral are used, the voltage between them is 7.2 kV.)

### ***Single Phase/Headpin***

Placement of a single phase at the top of a pole, rather than off to the side on a crossarm, around 30.8 feet above the ground; the neutral is placed down the pole some distance. Use of 7.2 kV and 100 amps current for 0.72 MW power delivery.

### ***Single Phase Underground***

Placement of an insulated single-phase wire with concentric neutral, which is a neutral wrapped around insulated phase wire, buried three feet underground without encasement; use of 7.2 kV and 100 amps for .75 MW.

Table 3 shows electric and magnetic fields resulting from these alternatives. Comparing the alternatives we can conclude the following.

1. Other things remaining the same, a double circuit/split phase results in the greatest magnetic field reduction. This is true even when comparing to the underground distribution alternatives studied. Also, magnetic fields from this design are much less than magnetic fields for the single phase alternative studied, even though the power delivered is nine times

greater for the three-phase (6.5 MW versus 0.72 MW). This design could have application where an express feeder is run from a substation to a load area. It would become unbalanced and be less effective for general distribution lines where connections are made along its length to serve customers.

2. Single-phase distribution generally produces greater magnetic fields for the amount of power delivered. For example, a three-phase compact delta line designed to deliver 6.5 MW produces a 4.9 mG field 40 feet away versus a 6.4 mG field from the single-phase headpin alternative, delivering only .72 MW.
3. The second most effective means by which to reduce magnetic fields from distribution lines appears to be doubling the primary distribution voltage (see Alternative "C", Horizontal Delta) which reduces the fields to about 40% of the base case magnetic field at 40 feet.
4. The compact delta design reduces the magnetic field to about 63% of the base case at 40 feet.
5. Undergrounding a three-phase distribution line reduces the magnetic field to between 57% to 61% of the base case at 40 feet (see Alternatives "F", Double Circuit/Split Phase and Alternative "G", Multiphase, respectively). In other words, undergrounding is no more effective than use of the compact delta (see above) and is more costly. Undergrounding also results in higher fields than other alternatives directly over/under the line. Table 3 shows a range of 31.2 mG to 56.3 mG for underground versus 3.3 mG to 22.4 mG for overhead at 0 feet from the center line.
6. Magnetic fields from distribution lines can be relatively greater for the amount of power delivered than transmission lines due to the amount of unbalance in the distribution system, the close proximity to ground level where the fields are measured, and the amount of earth

return current. If we assume 20% current amplitude variation, and 50% earth return on the distribution system, a 12.5 kV, 300 amp double circuit/split phase distribution line produces an estimated mean value magnetic field of 2.5 mG 40 feet away, by comparison to a 230 kV, 300 amp circuit/split phase transmission line field of 4.8 mG at the same distance; when the transmission line is delivering 19 times as much power.

## **Additional Observations**

### *General Observations*

- Electric and magnetic fields are a function of voltage and net current on a line, geometry of the line, and distance from a line.
- The most common single circuit transmission structure in the United States is the flat, horizontal configuration. This design results in the highest electric and magnetic fields.

### *Phase Spacing*

- The closer the phase spacing, the lower the external electric and magnetic fields produced. If all three phases of a transmission line could be placed at the same point in space, there would be no electric or magnetic field assuming no net current and voltages on all three phases are equal.
- The higher the voltage, the farther the conductors must be apart to provide satisfactory operation of the line in the areas of safety, reliability, radio and TV interference and audible noise.
- The State and National electrical codes determine the minimum allowable distances between phase conductors based upon safety considerations. The Washington State code includes provisions that may affect field reduction potential.

- Engineers have sought to tighten phase spacing for reasons other than field reduction, including cost of towers and width of right-of-way.
- Single-circuit, three-phase transmission is now often designed to maximize field reduction by placing the phases closer together.
- Single-circuit, multiphase lines, which are now under experimentation, offer reduced magnetic fields for the same amount of power because there are additional phases to share current.
- Double-circuit, three-phase lines can achieve lower EMF than when the two circuits are on separate structures.
- Increasing the height of phase conductors reduces fields on the right-of-way but at some distances close to the line can actually increase fields off the right-of-way.

#### ***Electric Fields***

- Electric fields can be reduced by shielding. Electric field shield wires can be strung between energized conductors and the ground, resulting in a significant reduction in electric fields at certain locations. Also, most houses and other buildings are very good shields.
- Lines using single conductors can yield significantly lower electric fields (as much as 25%) than lines using bundled conductors, but they produce higher audible and radio noise.

#### ***Magnetic Fields***

- Magnetic fields are directly related to the customers' use of electricity and varies hourly and seasonally with living patterns.
- The use of two or more transmission or distribution lines, where one transmission or distribution line would normally be used, results in

lower magnetic fields near each line, given the same total power delivery.

- The use of more substations with lower current distribution lines would result in lower magnetic fields near each line, for the same amount of power delivered.
- Magnetic fields from distribution lines may decrease more rapidly with distance than magnetic fields from transmission lines because of their close conductor spacing.
- Much of the magnetic field attributed to distribution lines comes from unbalanced currents between phase conductors and from split currents from neutral-ground bonds to other grounding systems, such as water piping systems.
- Degaussing loops along the right-of-way have been proposed for reducing magnetic fields, but so far, practical methods for their use have not been developed or tested.
- Certain types of underground construction can reduce magnetic fields from transmission lines except at distances very close to the line. The lines can be placed very close together and some attenuation is also produced by the heavy steel pipe used in high pressure fluid filled underground transmission systems. This type of system is not currently being used for distribution because, among other things, the net current produces fields, whether the pipe is present or not.
- The multiphase line and double-circuit/split phase transmission line alternatives can reduce magnetic fields to about around 50% that of the two delta configured lines. These are lines with more than three phases that transmit the same amount of power as normal single-circuit three-phase lines.

Electric and Magnetic Field Reduction: Research Needs

Appendix 3

Transmission Line Designs

BASE CASE 230 kV, 300 amps,  
125 MegaWatts, wooden H-frame pole,  
19-foot spacing;

change to VERTICAL DELTA  
configuration; 230 kV, 300 amps,  
125 MegaWatts

*Cost:*

\$230,000 to \$260,000 per mile.

*Cost:*

\$220,000 to \$250,000 per mile.

*Electric Field:*

Maximum (at 20 feet from center of line) 2.6 kV/m  
40' from center of the line 1.9 kV/m  
200' from center of the line .04 kV/m

*Electric Field:*

Maximum (at 9 feet right of pole) 1.9 kV/m  
40' from center of the line 0.7 kV/m  
200' from center of the line 0.04 kV/m

*Magnetic Field:*

Maximum directly under the line 59.6 mG  
40' from center of the line 29.7 mG  
200' from center of the line 1.6 mG

*Magnetic Field:*

Maximum (at 3 feet right of pole) 27.0 mG  
40' from center of the line 11.0 mG  
200' from center of the line 0.6 mG

*Conductor Geometry and Phasing:*

A: 0°, 30 feet elevation, 19 feet left of center  
B: 120°, 30 feet elevation, 0 feet of center  
C: 240°, 30 feet elevation, 19 feet right of center

*Conductor Geometry and Phasing:*

A: 0°, 44 feet elevation, 6.5 feet right of center  
B: 120°, 37.5 feet elevation, 6.5 feet left of center  
C: 240°, 30 feet elevation, 6.5 feet right of center

change to **HORIZONTAL DELTA** configuration; 230 kV, 300 amps, 125 MegaWatts

**Cost:**

\$220,000 to \$250,000 per mile.

**Electric Field:**

Maximum (at 13 feet from center of the line)	1.6 kV/m
40' from center of the line	0.7 kV/m
200' from center of the line	0.03 kV/m

**Magnetic Field:**

Maximum directly under the line	28.9 mG
40' from center of the line	9.8 mG
200' from center of the line	0.5 mG

**Conductor Geometry and Phasing:**

A:  $0^\circ$ , 30 feet elevation, 6.5 feet left of center  
B:  $120^\circ$ , 40 feet elevation, 0 feet of center  
C:  $240^\circ$ , 30 feet elevation, 6.5 feet right of center

change horizontal **VOLTAGE LEVEL**, to 115 kV, 600 amps, 125 MegaWatts  
11 1/2 foot spacing, wood poles

**Cost:**

\$200,000 to \$230,000 per mile.

**Electric Field:**

Maximum (at 20 feet from center of the line)	1.0 kV/m
40' from center of the line	0.6 kV/m
200' from center of the line	0.01 kV/m

**Magnetic Field:**

Maximum directly under the line	91.5 mG
40' from center of the line	34.4 mG
200' from center of the line	1.9 mG

**Conductor Geometry and Phasing:**

A:  $0^\circ$ , 30 feet elevation, 11.5 feet left of center  
B:  $120^\circ$ , 30 feet elevation, 0 feet of center  
C:  $240^\circ$ , 30 feet elevation, 11.5 feet right of center

change **VOLTAGE LEVEL** to 500 kV,  
138 amps, 125 MegaWatts with 30  
foot spacing, steel lattice tower

**Cost:**

\$400,000 to \$500,000 per mile.

**Electric Field:**

Maximum (at 35 feet from center of the line)	5.5 kV/m
40' from center of the line	5.3 kV/m
200' from center of the line	0.1 kV/m

**Magnetic Field:**

Maximum (at 14 feet from center of the line)	24.4 mG
40' from center of the line	18.9 mG
200' from center of the line	1.2 mG

**Conductor Geometry and Phasing:**

- A: 0°, 35 feet elevation, 30 feet left of center
- B: 120°, 35 feet elevation, 0 feet of center
- C: 240°, 35 feet elevation, 30 feet right of center

change to **DOUBLE CIRCUIT/SPLIT PHASE** 230 kV line to line,  
150 amps per conductor,  
125 MegaWatts, steel pole

**Cost:**

\$350,000 to \$400,000 per mile.

**Electric Field:**

Maximum (12 feet) from center of the line	1.66 kV/m
40' from center of the line	0.55 kV/m
200' from center of the line	0.02 kV/m

**Magnetic Field:**

Maximum (0 feet) from center of the line	14.5 mG
40' from center of the line	4.8 mG
200' from center of the line	0.1 mG

**Conductor Geometry and Phasing:**

- A: 0°, 64 feet elevation, 8.5 feet right of center
- B: 0°, 30 feet elevation, -8.5 feet left of center
- C: 120°, 64 feet elevation, -8.5 feet left of center
- D: 120°, 30 feet elevation, 8.5 feet right of center
- E: -120°, 47 feet elevation, 12.8 feet right of center
- F: -120°, 47 feet elevation, -12.8 feet left of center



change to **UNDERGROUND CABLE** in a fluid filled steel pipe, 230 kV, 300 amps, 125 MegaWatts

change to **UNDERGROUND CABLE**, dry type cable in nonmagnetic pipe, 230 kV, 300 amps, MegaWatts

**Cost:**

\$1,500,000 to \$2,000,000 per mile.

**Cost**

\$1,500,000 to \$2,000,000 per mile.

**Electric Field:**

(measured at one meter above earth's surface)

Maximum directly above line	None
40' from center of the line	None
200' from center of the line	None

**Electric Field:**

(measured one meter above earth's surface)

Maximum directly above line	None
40' from center of the line	None
200' from center of the line	None

**Magnetic Field:**

(measured at one meter above earth's surface)

Maximum directly above line	4.9 mG
40' from center of the line	0.2 mG
200' from center of the line	0.01 mG

**Magnetic Field:**

(measured at one meter above earth's surface)

Maximum directly above line	14.7 mG
40' from center of the line	0.6 mG
200' from center of the line	0.03 mG

**Conductor Geometry and Phasing:**

- A: 0°, -5 feet elevation, 0.3 feet left of center
- B: 120°, -4.7 feet elevation, 0.0 feet of center
- C: 240°, -5 feet elevation, 0.3 feet right of center

**Conductor Geometry and Phasing:**

- A: 0°, -5 feet elevation, 0.3 feet left of center
- B: 120°, -4.7 feet elevation, 0.0 feet of center
- C: 240°, -5 feet elevation, 0.3 feet right of center

change to MULTIPHASE, 6 phase line,  
132 kV, 150 amps per conductor, 125  
MegaWatts, steel structure

**Cost:**

\$380,000 to \$450,000 per mile.

**Electric Field:**

Maximum (0 feet) from center of the line	2.46 kV/m
40' from center of the line	0.92 kV/m
200' from center of the line	0.05 kV/m

**Magnetic Field:**

Maximum (0 feet) from center of the line	16.7 mG
40' from center of the line	6.7 mG
200' from center of the line	0.4 mG

**Conductor Geometry and Phasing:**

A:  $0^\circ$ , 41.2 feet elevation, -3 feet left of center  
B:  $-60^\circ$ , 36 feet elevation, -6 feet left of center  
C:  $-120^\circ$ , 30.8 feet elevation, -3 feet left of center  
D:  $-180^\circ$ , 30.8 feet elevation, 3 feet right of center  
E:  $120^\circ$ , 36 feet elevation, 6 feet right of center  
F:  $60^\circ$ , 41.2 feet elevation, 3 feet right of center

change to STEEL POLE, 230 kv,  
300 amps, 125 MegaWatts, single  
circuit, vertical configuration

**Cost:**

\$275,000 to \$350,000 per mile

**Electric Field:**

Maximum (at 11.5 feet right of pole)	2.7 kV/m
40' from center of the line	0.8 kV/m
200' from center of the line	0.1 kV/m

**Magnetic Field:**

Maximum (at 11.5 feet right of pole)	36.2 mG
40' from center of the line	22.1 mG
200' from center of the line	1.5 mG

**Conductor Geometry and Phasing:**

A:  $0^\circ$ , 30 feet elevation, 11.5 feet right of center  
B:  $120^\circ$ , 47 feet elevation, 11.5 feet right of center  
C:  $240^\circ$ , 64 feet elevation, 11.5 feet right of center

change to UNDERGROUND CABLE in a fluid filled steel pipe, 230 kV, 300 amps, 125 MegaWatts

change to UNDERGROUND CABLE, dry type cable in nonmagnetic pipe, 230 kV, 300 amps, MegaWatts

**Cost:**

\$1,500,000 to \$2,000,000 per mile.

**Electric Field:**

(measured at one meter above earth's surface)

Maximum directly above line	None
40' from center of the line	None
200' from center of the line	None

**Magnetic Field:**

(measured at one meter above earth's surface)

Maximum directly above line	4.9 mG
40' from center of the line	0.2 mG
200' from center of the line	0.01 mG

**Conductor Geometry and Phasing:**

- A: 0°, -5 feet elevation, 0.3 feet left of center
- B: 120°, -4.7 feet elevation, 0.0 feet of center
- C: 240°, -5 feet elevation, 0.3 feet right of center

**Cost**

\$1,500,000 to \$2,000,000 per mile.

**Electric Field:**

(measured one meter above earth's surface)

Maximum directly above line	None
40' from center of the line	None
200' from center of the line	None

**Magnetic Field:**

(measured at one meter above earth's surface)

Maximum directly above line	14.7 mG
40' from center of the line	0.6 mG
200' from center of the line	0.03 mG

**Conductor Geometry and Phasing:**

- A: 0°, -5 feet elevation, 0.3 feet left of center
- B: 120°, -4.7 feet elevation, 0.0 feet of center
- C: 240°, -5 feet elevation, 0.3 feet right of center

## Distribution Line Designs

**BASE CASE** 12.5 kV, 6.5 MegaWatts  
 40 foot pole, 10 foot crossarm, 4 foot sag,  
 50% return current in the earth,  $\pm 20\%$   
 current amplitude variation, and  $\pm 5^\circ$  phase  
 angle variation

change to **TALLER POLE**, 12.5 kV, 6.5  
 MegaWatts, 55 foot pole, 10 foot crossarm,  
 4 foot sag, 50% return current in the earth,  
 $\pm 20\%$  current amplitude variation, and  $\pm$   
 $5^\circ$  phase angle variation

**Cost:**

\$50,000 to \$70,000 per mile

**Electric Field:**

Maximum or directly under the line	0.05 kV/m
20' from center of the line	0.05 kV/m
40' from center of the line	0.03 kV/m
100' from center of the line	0.003 kV/m

**Magnetic Field:**

Maximum or directly under the line	22.4 mG
20' from the center of the line	14.9 mG
40' from center of the line	7.7 mG
100' from center of the line	2.2 mG

**Conductor Geometry and Phasing:**

A: 29.3 feet elevation, 4.6 feet right of center, 300 amps,  $0^\circ$

B: 30.8 feet elevation, 0 feet of center, 300 amps,  $120^\circ$

C: 29.3 feet elevation, -4.6 feet left of center, 300 amps,  $240^\circ$

Neutral: 21.8 feet elevation, 0.5 feet right of center, 50%

**Cost:**

\$60,000 to \$80,000 per mile

**Electric Field:**

Maximum or directly under the line	0.02 kV/m
20' from the center of the line	0.02 kV/m
40' from center of the line	0.02 kV/m
100' from center of the line	0.004 kV/m

**Magnetic Field:**

Maximum or directly under the line	10.1 mG
20' from the center of the line	8.1 mG
40' from the center of the line	5.3 mG
100' from the center of the line	2.1 mG

**Conductor Geometry and Phasing:**

A: 43.3 feet elevation, 4.6 feet right of center, 300 amps,  $0^\circ$

B: 44.8 feet elevation, 0 feet of center, 300 amps,  $120^\circ$

C: 43.3 feet elevation, -4.6 feet left of center, 300 amps,  $240^\circ$

Neutral: 35.8 feet elevation, 0.5 feet right of center, 50%

increase VOLTAGE to 25 kV, 6.5 MegaWatts, 47.5 foot pole, 10 foot crossarm, 4 foot sag, 50% return current in the earth,  $\pm 20\%$  current amplitude variation, and  $\pm 5^\circ$  phase angle variation

change to COMPACT DELTA configuration, 12.5 kV, 6.5 MegaWatts, 40 foot pole, 10 foot crossarm, 4 foot sag, 50% return current in the earth,  $\pm 20\%$  current amplitude variation, and  $\pm 5^\circ$  phase angle variation

**Cost:**

\$60,000 to \$80,000 per mile

**Electric Field:**

Maximum or directly under the line	0.07 kV/m
20' from the center of the line	0.06 kV/m
40' from the center of the line	0.04 kV/m
100' from the center of the line	0.007 kV/m

**Magnetic Field:**

Maximum or directly under the line	6.9 mG
20' from the center of the line	5.1 mG
40' from the center of the line	3.1 mG
100' from center of line	1.0 mG

**Conductor Geometry and Phasing:**

- A: 37 feet elevation, 4.6 feet right of center, 150 amps,  $0^\circ$
- B: 38 feet elevation, 0 feet of center, 150 amps,  $120^\circ$
- C: 37 feet elevation, -4.6 feet left of center, 150 amps,  $240^\circ$
- Neutral: 30 feet elevation, 0.5 feet right of center, 50%

**Cost:**

\$55,000 to \$75,000 per mile

**Electric Field:**

Maximum or directly under the line	0.03 kV/m
20' from the center of the line	0.03 kV/m
40' from the center of the line	0.01 kV/m
100' from the center of the line	0.003 kV/m

**Magnetic Field:**

Maximum or directly under the line	13.1 mG
20' from center of the line	8.8 mG
40' from the center of the line	4.9 mG
100' from center of the line	1.9 mG

**Conductor Geometry and Phasing:**

- A: 27.3 feet elevation, 2 feet right of center, 300 amps,  $0^\circ$
- B: 30.8 feet elevation, 0 feet of center, 300 amps,  $120^\circ$
- C: 27.3 feet elevation, -2 feet left of center, 300 amps,  $240^\circ$
- Neutral: 20.3 feet elevation, 0.5 feet right of center, 50%

change to **DOUBLE CIRCUIT/SPLIT PHASE** 12.5 kV, 6.5 MegaWatts, 47.5 foot pole, 10 foot crossarm, 4 foot sag 50% return current in the earth,  $\pm 20\%$  current amplitude variation, and  $\pm 5^\circ$  phase angle variation

change to **RANDOM LAY UNDER-GROUND** line, 12.5 kV, 6.5 MegaWatts, buried 3 feet deep, 7.5 inch phase spacing, 50% return current in the earth,  $\pm 20\%$  current amplitude variation, and  $\pm 5^\circ$  phase angle variation

**Cost:**

\$80,000 to \$120,000 per mile.

**Electric Field:**

Maximum or directly under the line	0.03 kV/m
20' from center of the line	0.03 kV/m
40' from center of the line	0.01 kV/m
100' from center of the line	0.003 kV/m

**Magnetic Field:**

Maximum or directly under the line	3.3 mG
20' from the center of the line	3.1 mG
40' from center of the line	2.5 mG
100' from center of the line	1.2 mG

**Conductor Geometry and Phasing:**

A: 36.3 feet elevation, 4.6 feet right of center, 150 amps,  $0^\circ$

B: 32.3 feet elevation, -4.6 feet left of center, 150 amps,  $0^\circ$

C: 32.3 feet elevation, 4.6 feet right of center, 150 amps,  $120^\circ$

D: 36.3 feet elevation, -4.6 feet left of center, 150 amps,  $120^\circ$

E: 36.3 feet elevation, 2.0 feet right of center, 150 amps,  $240^\circ$

F: 32.3 feet elevation, -2.0 feet left of center, 150 amps,  $240^\circ$

Neutral: 24.8 feet elevation, 0.5 feet right of center, 50%

Electric and Magnetic Field Reduction: Research Needs

**Cost:**

\$120,000 to \$600,000 per mile.

**Electric Field:**

Maximum or directly above the line	None
20' from center of the line	None
40' from center of the line	None
100' from center of the line	None

**Magnetic Field:**

Maximum or directly above the line	56.3 mG
20' from the center of the line	9.8 mG
40' from center of the line	4.7 mG
100' from center of the line	1.9 mG

**Conductor Geometry and Phasing:**

A: -3 feet elevation, -0.6 feet left of center, 300 amps,  $0^\circ$

B: -3 feet elevation, 0 feet of center, 300 amps,  $120^\circ$

C: -3 feet elevation, 0.6 feet right of center, 300 amps,  $240^\circ$

Neutral: -3 feet elevation, 1.2 feet right of center, 50%

change to **SINGLE PHASE HEADPIN** configuration, 7.2 kV, 0.72 MegaWatts 40 ft. pole, 4 foot sag, 50% return current in the earth,  $\pm 20\%$  current amplitude variation, and  $\pm 5^\circ$  phase angle variation

**Cost:**

\$30,000 to \$40,000 per mile.

**Electric Field:**

Maximum or directly under the line	0.08 kV/m
20' from the center of the line	0.06 kV/m
40' from center of the line	0.03 kV/m
100' from center of the line	0.008 kV/m

**Magnetic Field:**

Maximum or directly under the line	8.5 mG
20' from the center of the line	8.3 mG
40' from center of the line	6.4 mG
100' from center of the line	3.2 mG

**Conductor Geometry and Phasing:**

A: 30.8 feet elevation, 0 feet of center, 100 amps,  $0^\circ$

Neutral: 23.8 feet elevation, 0.5 feet right of center, 50%

change to **SINGLE PHASE UNDER-GROUND LINE**, 7.2 kV, 0.72 MegaWatts, buried 3 feet deep, #1 conductor with concentric neutrals, 50% return current in the earth,  $\pm 20\%$  current amplitude variation and  $\pm 5^\circ$  phase angle variation

**Cost:**

\$100,000 to \$450,000 per mile.

**Electric Field:**

Maximum or directly above the line	None
20' from center of the line	None
40' from center of the line	None
100' from center of the line	None

**Magnetic Field:**

Maximum or directly above the line	51.3 mG
20' from the center of the line	15.4 mG
40' from center of the line	8.0 mG
100' from center of the line	3.2 mG

**Conductor Geometry and Phasing:**

A: -3 feet elevation, 0.0 feet of center, 100 amps,  $0^\circ$

Neutral: -3 feet elevation, 0.037 feet concentric, 50%

change to **UNDERGROUND LINE IN CONDUIT**, 12.5 kV, 6.5 MegaWatts, buried 3 feet deep, 2.5 inch phase spacing, 50% return current in the earth,  $\pm 20\%$  current amplitude variation, and  $\pm 5^\circ$  phase angle variation

change to **SINGLE PHASE CROSSARM** configuration, 7.2 kV, 0.72 MegaWatts 40 foot pole, 10 foot crossarm, 4 foot sag, 50% return current in the earth,  $\pm 20\%$  current amplitude variation, and  $\pm 5^\circ$  phase angle variation

**Cost:**

\$120,000 to \$600,000 per mile.

**Electric Field:**

Maximum or directly above the line	None
20' from center of the line	None
40' from center of the line	None
100' from center of the line	None

**Magnetic Field:**

Maximum or directly above the line	31.2 mG
20' from the center of the line	8.4 mG
40' from center of the line	4.4 mG
100' from center of the line	1.8 mG

**Conductor Geometry and Phasing:**

A: -3 feet elevation, -0.1 feet left of center, 300 amps,  $0^\circ$

B: -3 feet elevation, 0.1 feet of center, 300 amps,  $120^\circ$

C: -3.2 feet elevation, 0 feet right of center, 300 amps,  $240^\circ$

Neutral: -3.1 feet elevation, 0.05 feet right of center, 50%

**Cost:**

\$30,000 to \$40,000 per mile.

**Electric Field:**

Maximum or directly under the line	0.09 kV/m
20' from center of the line	0.08 kV/m
40' from center of the line	0.04 kV/m
100' from center of the line	0.01 kV/m

**Magnetic Field:**

Maximum or directly under the line	14.5 mG
20' from the center of the line	12.8 mG
40' from center of the line	8.6 mG
100' from center of the line	3.6 mG

**Conductor Geometry and Phasing:**

A: 29.3 feet elevation, 4.6 feet of center, 100 amps,  $0^\circ$

Neutral: 29.3 feet elevation, -4.6 feet right of center, 50%



## M A T R I X I I I

### Project Scanate

Project Scanate was one of many projects conducted by think-tanks like Stanford Research Institute and the CIA; it involved remote viewing. Two U.S. psychics, former UN diplomat Ingo Swann and former Burbank police chief Patrick Price, were involved with Scanate, which was at the time one of the most closely guarded Pentagon projects. Price died under mysterious circumstances, leaving Swann to continue his psychic research at SRI under a low profile. Stanford did a study for the Air Force, called the "Advanced Technique Threat Assessment", classified Top Secret, which detailed the entire spectrum of psychic weaponry at the time. In 1979, Rep. Charles Rose of the House Intelligence Committee went so far as to demand a congressional investigation of U.S. psychic preparedness. Rose claimed to have witnessed Swann and others in action. Today, not a word about this issue is mentioned by Rose or any other congressional member.

### The Terminal Man

A Senate report entitled "Behavior Modification" revealed that the CIA funded work done at UCLA to develop microwave broadcasting equipment which could carry human voices into a person's head for the purpose of inducing hypnosis at a distance. In the 1950's, another center tied to UCLA maintained a program which involved an "amnesia beam" for CIA use in domestic and foreign covert operations.

### Mind Control and the White House

Since mind control has apparently been a basic substrate of scientific endeavor for the last 40 years, it is no surprise that proponents of mind control techniques have taken their place beside American presidents. President's Nixon and Ford were advised by Dr. Arnold Hutschnecker, a 1926 graduate of the Nazi-supported Kaiser Wilhelm Institute, where much of the early medical and psychiatric techniques involved in mind control were pioneered. During Carters administration, Dr. Peter Borne prescribed hypnotic drugs to White House staffers and some cabinet members. Financial consultant and investigative journalist Dr. Harry Schult has speculated that Bourne's control of the Carter White House may have resulted in some unusual policy decisions. It was during Carter's administration that FEMA was born.

Perhaps the greatest champion of Brzezinski's technocratic mind controlled America is Dr. Louis J. West. Dr. West was involved with Air Force brainwashing programs and MKULTRA work for the CIA, and proposed converting a former Nike missile base into an electronic mind control compound. He received a great deal of support from Ronald Reagan when Reagan was the governor of California. Some of the mind-boggling proposals

## M A T R I X I I I

that have their origin with Dr. West are chemical castration, implantation of transponders in the sexual organs and the brain, biological control of menstrual cycles to control crime (try to figure that one out!), and eventual replacement of the U.S. "legal system" with a system of psychiatric control. Today, Dr. West continues his activities as the Director of the Neuropsychiatric Institute at UCLA, no doubt with the full support of President and "ex" CIA director George Bush.

At Pentagon DARPA laboratories, biocyberneticist Dr. Craig Fields, according to a 1978 interview, was hard at work with the development of techniques for electronically controlling mass populations. In fact, from the very beginning, members of the American Medical Association and American Psychiatric Association have participated in programs which use public funding to create a national mind control network. Their own documents prove their goal - to robotize the United States. The mind control programs under development at UCLA are now being supplemented with newer programs at Los Alamos Scientific Laboratories in New Mexico, the home of the atom bomb.

### Project River Styx

Weapons developed under the U.S. Army Project River Styx program were among the first prototypal electromagnetic weapons. The Styx weapons were used to grossly degrade bodily functions of the brain, the eyes, and the sex organs. According to the Army, "there are paraphysical advantages that may accrue to the United States and allied nations from the early realization of military applications of these effects."

Research indicates that the Army was involved in this type of work as early as 1957; it is obvious why this work is kept from public view. According to one Pentagon study, the Army has conducted microwave experiments which produced third degree burns on subjects at Fort Know in Kentucky. Corporate research has paralleled military research. General Electric, who has been involved in the development of anti-personnel microwave weapons, participated in Project Comet, which delved into the psychological effects of electromagnetic radiation between radio waves and microwaves. Of course, the main mover behind all types of hideous research, as always, appears to be the Office of Naval Research.

# E.M.C.

ORION  
U.S.A.F.  
? 1958

TRIDENT  
O.N.R.  
? 1989

RF MEDIA  
C.I.A.  
BOULDER 1990

TOWER  
C.I.A.  
? 1990

"Dreamland"  
E.D.O.M.  
  
Drugs, Hypnosis, Electronic  
—  
  
In Person & Short Distance  
—  
  
ELF Mod. Debriefing  
—  
  
Radar, Micro Waves, Mod. at ELF  
—  
  
Memory Loss, Programming, Training, Security & Loyalty

"Black Triad"  
A.E.M.C.  
  
Electronic, Directed & Targeted  
—  
  
On Large Groups Assembled  
—  
  
3-Black Helicopters in TRIAD Formation  
100 K-Watts each. UHF  
—  
  
Riot Control, MANAGING LARGE Crowds, Zapping.  
(F.E.M.A.)

"Buzz-saw"  
E.E.M.C.  
  
Electronic, Multidirectional Subliminal  
—  
  
On Everybody Long Range  
—  
  
ULF-VHF-HF  
S+Phase Modulation, GigaWatts(10)  
—  
  
TV, Radio, Communicat.  
VIDEODROME SIGNAL  
—  
  
Programming Trigger Disease, Preval, Confuse PSYCHIC Powers, Prepare for MASS. E.M.C.

"Wedding Bells"  
V.E.M.C.  
  
Electronic Cross Country Subliminal  
—  
  
On Everybody Short Range Interval, Long Range Total  
—  
  
Microwaves EHF-SHF Radar(?)  
—  
  
Secret Big Transmitters + Cellular Phone TOWERS. Mod. ELF  
—  
  
Programming by ALL Signals + PHONE RECEIVER US Encoded Info in EAR.(?)

# ELECTRONIC MIND CONTROL

<b>PHOENIX II</b> <b>U.S.A.F.</b> <b>Montauk 1983</b>	<b>MOONSTRUCK</b> <b>C.I.A.</b> <b>? 1952</b>	<b>MK ULTRA</b> <b>C.I.A.</b> <b>? 1955</b>	<b>MK DELTA</b> <b>C.I.A.</b> <b>? 1960</b>
<p><u>"Rainbow"</u> ZAP</p> <p>Electronic + Directional + Targeted</p> <hr/> <p>Medium Range Targeted</p> <hr/> <p>Radar Microwaves EHF-UHF Giga/Tera Watts <math>10^9-10^{12}</math></p> <hr/> <p>Tapping, Kill- ing, Frying Brains. Loading Earth Grids. Pulling Earth to Sleep. Programming</p>	<p><u>?</u> E.S.B./E.H.</p> <p>Electronic Implants in Brain &amp; Teeth</p> <hr/> <p>Long Range Targeted</p> <hr/> <p>In Person Surgery by Abduction or Surreptitiously</p> <hr/> <p>HF-ELF Trans. Receiv- ers in Body</p> <hr/> <p>Tracking, Mind Control, Train- ing, Program- ing, Spying</p>	<p><u>"Artichoke"</u> E.D.O.M.</p> <p>Drugs+Electro- nic+El. Shock</p> <hr/> <p>In Person Short Range</p> <hr/> <p>ELF's Electrodes on Body</p> <hr/> <p>Narcoleptic Trance, Sug- gestion, Brain washing</p> <hr/> <p>Memory Loss Programming Behaviour, Creating "CYBORGS"</p>	<p><u>"Deep Sleep"</u> R.H.I.C.</p> <p>Electronic Subliminal? Fine Tuned</p> <hr/> <p>In Person Long Range</p> <hr/> <p>VHF-HF-UHF Modulated at ELF</p> <hr/> <p>TV Antennas, Radio. Ant. Power Lines Mattress Springs (Metal Coils?)</p> <hr/> <p>Programing Behaviour &amp; Attitudes. Confusion, Fatigue, Moods Dreams(?)</p>

## CIA MIND CONTROL RESEARCH

**MKULTRA SUBPROJECT-68**

**T**his was Dr. Cameron's ongoing "attempts to establish lasting effects in a patient's behaviour" using a combination of particularly intensive electroshock, intensive repetition of prearranged verbal signals, partial sensory isolation, and repression of the driving period carried out by inducing continuous sleep for seven to ten days at the end of the treatment period. During research on sensory deprivation, Cameron experimented with the use of Curare, (the deadly poison used by South American Indians to tip their arrow heads), to immobilise his patients. After one test he noted: "Although the patient was prepared by both prolonged sensory isolation (35 days) and by repeated depatterning, and although she received 101 days of positive driving, no favourable results were obtained." Patients were regularly treated with hallucinogenic drugs, long periods in the "sleep room", and testing in the Radio Telemetry Laboratory that was built by Rubenstein under Dr. Cameron's direction. Here, patients were exposed to a range of RF and electromagnetic signals and monitored for changes in behaviour. It was later stated by other staff members who had worked at the Institute that not one patient sent to the Radio Telemetry Lab showed any signs of improvement afterwards.

**MKULTRA SUBPROJECT 3**

A project designed to assess the use of sexual entrapment in covert operations. It became known unofficially as Operation *Midnight Climax*. Included in the operation were attempts by CIA agents to infiltrate public gatherings, such as cocktail parties, where unsuspecting guests were sprayed with LSD in canisters variously labelled as insect repellent, deodorant, and perfume. An operation conducted in an apartment in New York's Greenwich Village focused specifically on drug testing. Another apartment was rented on Telegraph Hill in San Francisco and used for further drug testing. It was also set up as a brothel at which was used to discover more about the psychological aspects of sexual behaviour and prostitution, and to scout for potential CIA "assets." (Moles, Informers, snoops, field agents). A report by a Senate investigating committee recorded in 1975 that, "Prior consent was obviously not obtained from any of the subjects. There was, obviously, no medical pre-screening. In addition, the tests were conducted by individuals who were not qualified scientific observers. There was no medical personnel on hand to administer the drugs or to observe their effects and no follow up was conducted on the subjects."

**OTHER MKULTRA OPERATIONS**

There were an enormous number of MKUltra operations. The project farmed out work to eighty institutions, of which forty-four were colleges or universities, fifteen research facilities or private companies, twelve hospitals and three prisons. The estimated total cost of the operation was 10-25 million dollars.

Prisoners were used in experiments conducted at the California Medical Facility in Vacaville State Prison by Dr. James Hamilton. Funded by another chain of front organisations, Dr. Hamilton conducted "clinical testing of behavioural control materials." In New Jersey, testing was conducted by Dr. Carl Pfeiffer at the Borden Reformatory, on similar materials. At Holmesburg State Prison in Philadelphia volunteers were used to test a particularly violent incapacitating drug. Around the same time as these tests were being conducted by the CIA the

US Army initiated two projects, *THIRD CHANCE* and *DERBY HAT*. They conducted experiments both home and abroad, and at one time the New York State Psychiatric Institute was conducting research under contract to the Army. Between 1955 and 1958 the Army also tested LSD on 1,000 volunteer US servicemen at Fort Bragg and the Army's Chemical Warfare Laboratories at Edgewood.

**MKDELTA**

This operation focused on the interrogation of people who were suspected as being foreign agents spying upon US installations, or native Americans suspected of being foreign agents. Much of the testing was conducted off the American mainland in CIA safe houses and American occupied war zones.

**OPERATION MINDBENDER**

A covert operation conducted in Mexico City that involved the use of undercover hypnotherapists to determine whether an unsuspecting victim could be influenced, by a combination of drugs and hypnosis, into becoming an assassin who would carry out an order to kill after being triggered into action by a pre-programmed signal.

**MKSEARCH**

An operation that included over a dozen sub-projects. The projects were under the control of Dr Sydney Gottlieb. Most were a continuation of projects conducted under *MKUltra* that were renamed after Dr. Cameron's time with the Agency had come to an end. Some were to be conducted in CIA safe houses set aside in a number of American cities including, Washington, New York, Chicago, and Los Angeles. The intention was to use them as locations where "expendables", (that is a subject who might die, but whose disappearance was unlikely to arouse suspicion), could be

tested under full medical supervision. Other sub-projects concentrated specifically on exploiting human weaknesses and destabilizing personalities.

One operation funded under *MKSearch* by Dr. Gottlieb was researching micro-organisms with the capacity to kill. The work was carried out by two separate laboratories who were unaware of each other's activities. One was a private research facility in Baltimore, the other was at the Army Biological Laboratory at Fort Detrick, which had been running an operation since May 1952 known as *MKNaomi*. The civilian researchers in Baltimore were instructed to attempt to find chemicals that could induce anything from the desire for kinky sex, to simulating death by carbon dioxide, that is, to produce a chemical that could be used to fake suicide. At Mount Sinai Hospital an immunologist by the name of Dr Harold Abramson was allocated \$85,000 by Dr. Gottlieb and was told that the Agency wanted experiments done on disturbance of memory.

# M A T R I X I I I

They wanted disturbance by aberrant behaviour, changes of sex patterns, suggestibility and the creation of dependence, to be used in the obtaining of information.

## OPERATION BIG CITY

In their search for a chemical material "which would cause a reversible non-toxic aberrant mental state, the specific nature of which could be reasonably well predicted for each individual", Operation Big City was launched.

A 1953 Mercury car was modified so that its exhaust pipe extended 18 inches beyond its normal length. The car was then driven a total of eighty miles around New York emitting a gas to test its effect on passers-by. In another test operatives travelled on the New York subway with battery powered emission equipment fitted into suitcases, to see if LSD could be sprayed in confined areas and affect people. The operators wore nasal filters. In San Francisco a biological gas was released off the Golden Gate Bridge, with the intention of covering the city and monitoring the gases disorientating effects. It blew away before it could cause any harm. In 1957, the CIA Inspector General, Lyman Kirkpatrick issued an internal memo which stated that "precautions must be taken not only to protect the operations from exposure to enemy forces, but also to conceal these activities from the American public in general. The knowledge that the Agency is engaging in unethical and illicit activities would have serious repercussions in political and diplomatic circles and would be detrimental to the accomplishment of its mission."

## OPERATION RESURRECTION

In this *MKSearch* sub-project the isolation chamber that had been constructed earlier by Dr. Cameron at the Allan Memorial Institute was rebuilt at a laboratory of the National Institutes of Mental Health. This time, instead of humans, apes were to be subjected to a cruel combination of treatments. After first being lobotomized, the animals were kept in total isolation. The radio telemetry techniques developed earlier by Leonard Rubenstein were adapted so that radio frequency energy could be beamed into the brains of the highly disturbed animals. Many were then decapitated and their heads would be transplanted onto another body to see if the RF energy would bring them back to life. The apes that were not killed in this way were later bombarded with radio waves until they fell unconscious. Autopsies revealed that their brain tissue had literally been fried. These experiments were conducted around 1965/66, so it is a frightening reality that it is around 25 years since intelligence agencies covertly started experimenting with the use of radiated energy to control behaviour.

Around the same time the Agency set up the Amazon Natural Drug Company in Iquitos, Peru. It acted as a channel for the Agency to collect drugs for their operations. A small team of botanists gathered leaves, roots and barks from the jungle, which were then sent back to the TSS laboratories where they were pulverised into dust and fed to more apes to see if they were driven mad or would kill each other. They did both.

## OPERATION SPELLBINDER

On June 30th, 1966, Richard Helms became Director of Central Intelligence. He was the first DCI since Dulles to push hard for results in the mind control field. Operation *MKSearch* went into overdrive. Old projects were resurrected, abandoned projects reactivated. The safe houses were told to expect a steady supply of Viet Cong expendables to experiment on. One of the projects to be revived was the less than successful Operation *Mindbender*. Renamed Operation *Spellbinder*, the assignment was to create a sleeper killer, a real life "Manchurian Candidate." A hypnotist was recruited from the American Society of Clinical and Experimental Hypnosis. He became known amongst the Agency staff as "Dr. Fingers" and was selected because his file stated that he would have no qualms about conducting potentially terminal experiments. The intended victim of the experiment was Fidel Castro. After attempts to program several would-be assassins, the operation was discontinued and written off as a complete failure.

## DIGGING DEEPER INTO THE BRAIN .

What the Agency wanted more than anything was the capability to influence or control subjects remotely. This would open an entirely new set of operational possibilities to the world of covert intelligence. Due to the obviously sensitive nature of any research in this area, special precautions were taken to isolate operations financially from other projects and the Agency.

## MKULTRA SUBPROJECT 142 AND SUBPROJECT 94

*Subproject 142* was "a small biological program of electrical brain stimulation involving some new approaches to the subject." The project would "engage in some very practical experiments at some point in the work that would present security problems if this effort were to be handled in the usual way. Some of the work proposed for these animals would involve possible delivery systems for direct executive type action operations as distinguished from the eaves dropping application." The term "executive action" was the CIA's euphemism for assassination.

*Subproject 94* was similar, its purpose "to provide for a continuation of investigations on the remote directional control of activities in selected species of animals. Miniaturized stimulating electrode implants in specific brain center areas will be used."

These projects were initially conducted on animals. Dogs, cats and monkeys were tested as guided microphones and bombs. By 1960, "the feasibility of remote control of several species" had been demonstrated. By April 1961, Sidney Gottlieb's team had "a 'production' capability." After successful testing of electrode implants in animals brains, it was only a matter of time before human subjects were to be used.

In July 1968 an Agency team flew into Saigon to experiment on three Viet-Cong prisoners at Bien Hoa Hospital. Working in an enclosed compound, the team's neurosurgeon and neurologist inserted tiny electrodes into their brains.

## M A T R I X I I I

Behaviorists then experimented on the men, arming them with knives and trying to induce violent behaviour in them using the direct electrical stimulation. After a week of experimentation which failed to incite the men to attack each other, they were shot dead and their bodies were burned. One cannot even begin to guess at the number of people who have been subjected to brain implants since these early experiments.

### OPERATION OFTEN

By 1969 TSS had been replaced by the Office of research and Development (ORD) as the Agencies "department of the unorthodox." The most innovative and daring doctors were transferred to ORD and a number of bizarre and far-reaching experiments were put into action. The roots of the new research could be traced back to the earlier work Dr. Cameron had approved which tried to establish links between eye colouring and mental illness.

The ORD chemical and biological team started off trying to create a deadly virus by exposing a range of already deadly bacteria to ultraviolet light. While they continued with that line of research, the psychiatrists and behaviorists on the ORD team set off to explore an even stranger possibility. The world of the supernatural and black magic. Agents spread out across the country in search of fortune-tellers, palm readers, psychics and clairvoyants. The agents would introduce themselves as researchers from the Scientific Engineering Institute.

They worked with their new found subjects searching for ways to use the paranormal in spying and counter-intelligence. By May 1971, Operation *Often* had three astrologers on its payroll whose specific task was to predict the future. They would sit for hours in soundproof booths scouring magazines and newspapers looking for items that would alert them psychically. They then taped whatever thoughts came into their minds about how the particular situation may develop. By 1972 two Chinese-American palmists has been employed to probe how hand reading could be developed for intelligence work. Palmists had already been consulted after the Agency went to considerable lengths to obtain Fidel Castro's palm prints. A medium was used to scout the United Nations headquarters for "evil types" and an approach was even made to the minister in charge of exorcisms for the Catholic archdiocese of New York. Whatever the offer, it was firmly rejected. Research was conducted into black magic, complete with an analysis on the covens operating in the United States. The Scientific Engineering Institute funded a course in sorcery at the University of South Carolina. The CIA's scientists carefully studied the results of the classes devoted to fertility rites and raising the dead. Simultaneously, research into brain implant technology was stepped up.

### THE SCHWITZGEBEL MACHINE

After consultation with the DCI, Richard Helmes, Dr. Gottlieb hired the former director of the Agency's Office of Scientific Intelligence, Dr. Stephen Aldrich, and set him up in a safe house where a KGB defector had recently been interrogated and tortured continuously for almost three years, so that he could experiment with a device known as the Schwitzgebel Machine. This was a 'Behavioural Transmitter-Reinforcer' (BT-R) fitted to a body belt that received signals from, and transmitted signals to, a radio module. The machine was "linked to a missile-tracking device which graphs the wearer's location and displays it on a screen." It was developed by Ralph K. Schwitzgebel in the Laboratory of Community Psychiatry at Harvard Medical School. His brother,

Robert, subsequently modified the prototype into a more refined final product. The machine drew enthusiastic praise from criminologists who were supportive of ORD's concepts for the intelligence techniques of the new world order.

On December 10th, 1972, Helmes cancelled Operation *Often*. The memo sent to Dr. Gottlieb to notify him was marked READ - DESTROY. Dr. Gottlieb resigned from the Agency in January 1973. Before he left he was ordered by Helmes to shred all records from MKUltra - MKSearch.

130 boxes would later be discovered in the Langley archives that, inexplicably, Dr. Gottlieb had failed to destroy. It was thought that the records had been misfiled and would have been destroyed if Helmes and Gottlieb had been aware of them.

### SKELETONS IN THE CLOSET

In July 1974 the Watergate scandal climaxed with the resignation of President Richard M. Nixon, and Vice-President Gerald R. Ford stepping in to take the reins. Ford immediately became aware of scope of the CIA's wholesale misbehavior. They had tried everything from blackmail, bribery, and sexual harassment, to violence and murder, in a genuinely horrific abuse of their privilege to classify anything they deemed fit to cover up TOP-SECRET, ULTRA, or EYES-ONLY. Upon hearing the truth, Gerald Ford's reaction was reportedly to shake his head in disbelief and mutter, "My God. Oh, My God."

In December 1974 The New York Times ran a story exposing some of the Agency's illegal activities during the Johnson and Nixon administration, and a public outcry ensued. President Ford quelled the public reaction by appointing a committee, chaired by Vice-President Nelson A. Rockefeller, to investigate the allegations. Ronald Reagan, who was Governor of California at the time, was one of the eight members sitting on the committee. He rallied strongly in favour of the CIA and claimed that "in any bureaucracy of about sixteen million people there are going to be individuals who make mistakes and do things they shouldn't do." Over dinner with William Casey, Reagan vowed that if he were ever elected President he would make sure that the CIA would never have to fight with one arm tied behind its back. George Bush became DCI on January 31, 1976, and departed to become Reagan's running mate on January 20, 1977. On January 26, 1981, William Casey made his first trip to the White House as Director of Central Intelligence. Within a short space of time, the Director of the National Security Agency (NSA), Admiral Bobby Ray Inman, who had also been in the running to become DCI, helped forge closer ties with the CIA. Attempts were made to smooth the competitive relationship between the two agencies, the NSA allowing the CIA unprecedented access to their extensive data and computerised intelligence gathering facilities.

On December 11 1980, a law suit was filed

by a former patient under the "care" of Dr. Ewen Cameron. Shortly afterwards another patient became a co-plaintiff. It was expected that more victims of the CIA's covert mind-control research operations would shortly join in. Casey ordered the CIA legal staff to delay any court hearings for as long as possible, his plan being that if the elderly plaintiffs were to die before the trial, the case would die with them.

Casey then set about collecting damning evidence about the medical torture practices of over eighty countries deemed to be unfriendly to the United States. The case eventually made it to trial. The plaintiffs settled for a sum of \$100,000 each which was released to them on the understanding that they would never publicly discuss the case again.

The operations listed above only became public knowledge because of the public's awareness of the Senate investigations, and checks made by researchers under the Freedom of Information Act. Today, in almost every country in the world, torture involving the manipulation of the human mind is performed on someone every single day. Techniques have become so sophisticated that even victims who become statistics may be unaware of what, or who, has been interfering with their minds. The techniques that are in use today are more subtle, silent, and deadly than ever before. There is no way of knowing just how many research projects, or perhaps more importantly, deployment operations, are being conducted at the present time. Perhaps the sudden change of attitude by many of the Iraqi personnel on the ground in the recent Gulf War could be related to the possible use of secret long-range behaviour modifying technologies.

Much of the research conducted by the CIA and the Soviets has inspired both the Intelligence community and the Defense Department to a close look at the potential of parapsychology for covert psychic warfare purposes.

The intention of publishing this story is not to shock or scare you. It is to remind you that behind the veil of secrecy that masquerades as "national security", there are people perfecting mind-control techniques that can relieve you of your self control. Only by being aware of the silent hand that would like to control your mind will you recognize where the veil starts and deception begins. Only by being aware can we begin to lift the veil.

#### REFERENCES:

Journey into Madness - Gordon Thomas.  
(Published by Bantam Books 1989)

CIA - The Honourable Company Brian Freemantle. (Published by Futura Books 1984)

Psychic Warfare - Fact or Fiction? Edited by John White (Published by The Aquarian Press 1988)

The Search for the 'Manchurian Candidate' John Marks (published by Times Books 1979)

In all there were 149 MKUltra subprojects dealing with behavioural modification. A further 33 subprojects were funded under MKUltra that were not related to this type of research. We will never know what these projects were about.

# CIA Mind Control Research





# SUBLIMINAL WARFARE

**ELF**  
**Extremely Low**  
**Frequency Magnetic**  
**Fields.**  
**They affect us all in ways**  
**we may never**  
**consciously realise!**

by Dr. Robert Beck

President, United States Psychotronics Association, 1985.  
 This presentation consisted primarily of a slide presentation  
 with commentary. The text has been extracted from a  
 version of this lecture published in 1978 by Borderland  
 Sciences Research Foundation.

In 1952, German physicist named W.O. Schumann, playing around with math as physicists are prone to do, postulated that the earth - being a good conductor - was surrounded by a good dielectric called air. And around this is another layer of a good conductor known as the ionosphere, the Heaviside Layer, and that this constitutes a potentially resonant system. That means that any energy trapped in this earth-ionosphere cavity - like lightning storms, etc., - will cause it to ring like a bell. But the surprise was that this signal frequency was the identical

spectrum of human brain waves. It had to be of irresistible interest to me to build an apparatus which would measure the earth's brain wave, and at the same time measure the Witch Doctor's brain waves, and see if there was a correlation - which we did.

This publication, which is the *Journal of Research of the National Bureau of Standards*, Division of Radio Propagation, (p.3, Vol. #66, May-June 1962); tells of one of the early efforts where a government study, granted to Drs. Koch and Pitchum at the University of Rhode Island, had made recordings of the earth's brain wave; and those of you who know anything about Encephalography could almost diagnose the patient by these little squiggles. They look identical to human brain waves! (See figure 1)

We're reading the Magnetic H-wave which is the psychoactive component. Any radio propagation wave has three components: the E-wave which can be picked up by an antenna, the electro-static component, and the magnetic component - the vector is 90 degrees at right angles to it.

So we built apparatus to test the thesis: There are certain people walking among us today - perhaps one person in three thousand - who by dint of heredity, or training, meditation, or whatever it might be, is able to tune in to this magnetic component which is down around one micro-gauss, one millionth of a gauss. Somehow they latch on to this cosmic carrier of information, transduce it into paranormal "seeing" ability.

Now, the brain wave spectra seems to centre around that magic number of 7.8 to 8.0 Hertz (cycles per second). In other words, we know have an objective test to see whether that person is tuning into a paranormal state of consciousness, or whether he is making it up as he goes along.

If we look at these curves at 8 Hz, 7.8 Hz, there is a tremendous node in the earth's brain wave. There's another one at about 14 Hz, etc. Amazing! The same numbers which you get at the alpha-beta border, the alpha wave, beta, etc. Man is a bio-cosmic resonator.

Now what are some of the factors which can alter human moods if this thesis is correct? Sunspot activity. Recall how solar flare activity totally disrupts radio communication on this planet? It also changes the frequency of the Schumann wave. Lunar tides. The same gravity forces that cause tides in our oceans de-tunes the earth ionosphere cavity slightly, changing its frequency. How about this as a solution for "moon madness"?

A lot of previously anecdotal, but very well documented data, is going to seem to fit this model of why is man sensitive to these cosmic events. Here are some photographs

**SUBLIMINAL WARFARE**

of solar flare activity. The earth, drawn to the same scale as some of these tremendous bursts of energy, is this little dot right here. Tremendous bursts of energy from outer space alter the earth's ionospheric cavity, therefore changing the frequency slightly; therefore it can re-tune our nervous systems, electromagnetically. (Ed Note: We don't have Mr. Beck's film strip, but we do have a copy of the classic in this field, Dewey and Dakin's *Cycles, the Science of Prediction*, published in 1947 by Henry Holt & Co., New York. Figure 2 is a reproduction of chart 9, page 144)

On page 142, Dewey and Dakin write: "... in 1934, two Harvard research workers, Carlos Garcia-Mata and Felix Shaffner, re-examined the Jevons studies (on crop cycles) and checked them; they ended up with the conclusion that the sunspot phenomena showed no correlation with agricultural production, but - the solar phenomena showed a remarkable correlation with industrial production, business activity, and with stock market prices. Since this particular outcome of these studies apparently left them a little surprised and aghast, the two students threw up their hands and passed the problem over to the biologists and the psychologists." Who weren't particularly interested, we might add.

But Russian physicists were! They later proved in their own way the 4th Kingdom of Nature, the human kingdom, reacts immediately to the magnetic changes of the sun, and offered this knowledge for the practical and tactical use of the military maniacs in Moscow.

Now we won't go into the physics of the H-Layer and the I-Layer, etc., but basically the ionized particles that are emitted by the sunspot activity eventually arrive at earth, are trapped at the north and south Geomagnetic Poles, and cause all sorts of electro-magnetic anomalies. One of the things that we are familiar with that are triggered by this energy coming in from the sun are the Northern Lights, the Aurora Borealis. These reveal the tremendous amount of energy that comes in and ionizes the rare gasses, creating the

luminescence, nature's light show.

What if the ancient people realized that on certain days of the year, (the solstices, the equinoxes, etc), these frequencies change? And what if the priesthood decided to build observatories like Stonehenge and the ones all over Central and South America, Europe and England - to predict these so the people could be either freed or implanted all over again. I don't know the answers to those totally hypothetical questions, but it was terribly important to them to predict these days.

Now man is unique in that the RNA in his brain has a dielectric constant (K) of 140,000. How many engineers are here? Do you realise the significance of that figure? That one little cell, out of billions and billions in your cerebral cortex, can approach the liquid crystal boundaries. It's a quantum transducer that will respond to coherent energies in the neighborhood of one hundredth of a micro-gauss. This has not been suspected until fairly recently. It means that we are not \$2.40 worth of minerals and water - as I learned when I was in the third grade. We are incredibly complex bio-cosmic transducers; and the things that we have been calling mind, or occult, or what have you, are today surrendering to scientific research on a rational basis. It means that we have within us probably one of the most sensitive, quadruple-conversion, superheterodyne receivers that's ever been developed; and that we can respond to energy levels that almost appear paranormal.

In fact, some of the paperwork that came out of the secret files, and was declassified and hand delivered to me, pointed out that our own Central Intelligence Agency (CIA) in 1975 had given a research grant to Garret Air Research Corporation, El Segundo, California, which Dr. Ed Wortz (one of my buddies in biofeedback research), and Dr. Jed Erkins had predicted the exact mechanism by which the Soviets are manipulating - or can manipulate us globally using this very data; that man, as a bio-cosmic transducer, can respond to things which had previously been called ESP

Figure 1.

Typical human brain waves from W. Grey Walter's *The Living Brain*, page 87.

"... the frequency of a rhythm is more significant than its amplitude ...". Main Types of Brain Rhythms. Records showing the principal wave-forms found in EEGs (a) Delta — 0.5 to 3.5 cycles per second. (b) Theta — 1 to 7 c/s. (c) Alpha — 3 to 13 c/s. (d) Higher Frequency (Beta) — 14 to 30 c/s.

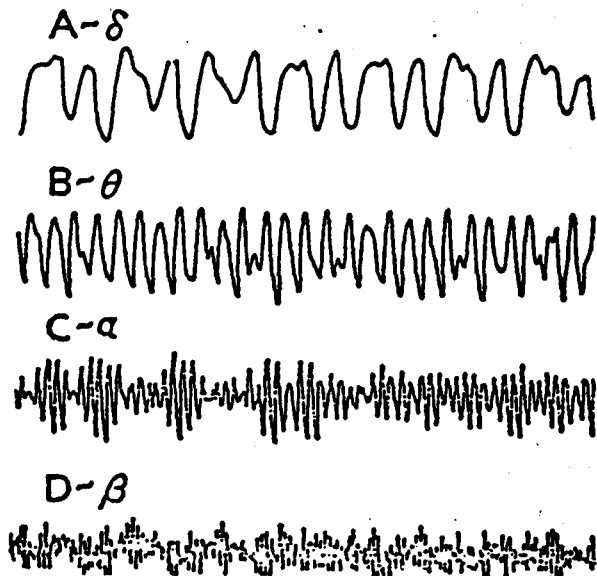

## SUBLIMINAL WARFARE

(Extra Sensory Perception) with known, physical mechanisms. That's what it means.

Now, an interesting thing developed. A.S. Pressman, Dept of Physics, Moscow University, did this open literature survey of the work on magnetics and life a number of years ago. Then suddenly most of these references - or rather the critical ones in Soviet literature - went underground. Is this trying to tell us something? At the time I did my own literature search - and I have a copy of the bibliography here, in which I found 182 references in the open literature - to the effects of extremely low frequency electrostatic and electro-magnetic fields on human performance, mood etc. At that time all of these things were in the open literature. Now one of my students went around to the bio-med library in UCLA not long ago (University of California at Los Angeles) and found a number of these had been sliced out of the text with a razor blade! That leads us to two conclusions: were the kids too broke to put a dime in the Xerox machine? Or had some of these been purposely removed?

How about the relationship between the mean annual magnetic activity and the number of Sunspots? Again, man is a bio-cosmic transducer. We know we live on a planet that has fairly well predicted (7, 21, 11, etc), cycles. What about this curve of magnetic storms, and mortality from nervous and cardiovascular diseases? A guy with a 25-Watt transmitter - with the Luxembourg effect (which means a circularly polarized antenna aimed at the ionosphere), with a few Hz frequency difference from a 50,000 watt broadcast transmitter can mood-manipulate an area of about 200 square miles. Dangerous? Hell yes!

How about comparison with daily periodic changes and the earth's electric and magnetic fields, and rhythms of living organisms? Circadian rhythms? All of these graphs which you are going to see for the next few minutes, incidentally, are from medically accepted literature, from the medical journals themselves. The dielectric constant of water, the magic transducer.

Okay, here's another one, a paper generated in the *Radio Science Journal of Research* of the National Bureau of Standards. Again, take a look at where the magic number appears to be. That's an 8.0 under the power distribution curve, the same figure that we were finding in the heads of psychics, the medicine men, the witch doctors, the Christian Mystics - they're all the same!

Any of you people know Dr. Ed Maxey, Stanton Maxey in Florida? Okay, about the time I was playing with it he did a very interesting experiment. He took a little coil, a few turns of wire, put it on the floor underneath the operating table and found that by turning this thing on a certain frequencies a large percentage of the people tested had brain wave entrainment. Entrainment simply means that their brain wave - the firing of their neurons - latches onto this magnetic field coming from this little coil putting out micro-gauss. You can't even measure things this low unless you have highly sophisticated equipment. It is invisible. It's tasteless, odorless etc. This is in a paper that he presented to a

Figure 2. Solar Radiation and Stock Prices

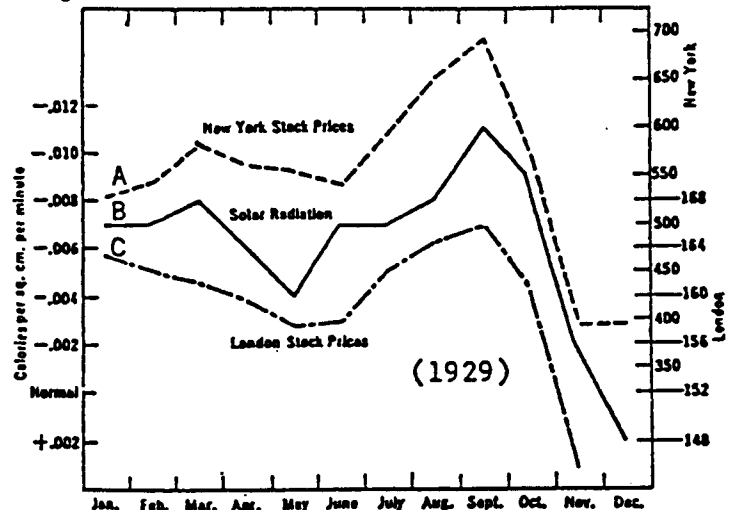

geophysical society meeting not too long ago. He too came up with the magic number that I have, 7.8 Hertz. He found that exactly four seconds after this field went on, the subject's brain waves would lock on exactly, on frequency and phase.

This was Dr. Polk's original paper, and then this "cop out" about 1975 when the people that were working in this field had to go back, backtrack, and pretend like they had not published their original papers, or seen what they had seen. This is what happens when you get a government grant, boys and girls!

Some good work that was being done at UCLA in their brain research group. Dr. W.R. Adey was on another government grant sponsored by the Office of Naval Research, into the effects of these (in this case - pulsed) very high frequency fields, that were pulsed with a very low frequency modulation. His published papers, and this goes back several years, show that this could influence the brain waves of cats and monkeys; and he didn't talk about the work that was done out there with human beings because by now this was fairly sensitive. They knew it worked. They didn't know why. So a lot of time, money and effort went into finding out what in the human brain was beginning to respond to this.

A few German physicists were looking into the possibility that this may have been the mechanism that we have lived with for thousands of years. The name of this paper is "The Biological Effect of Extremely Low Frequencies in the Atmosphere". In other words, if we live in a natural ELF environment could this possibly be the key and mechanism for mass accidents, mass suicides, etc? All of the people who did this work independently, Tromp in Holland, Koenig in Germany, found: yes - when they went back through the weather records, this had to be the mechanism that caused all of these admissions to psychiatric hospitals on certain dates, all of these homicides. The data is beginning to become massive.

James R. Hamer - or "Hammer". He was working with human subjects, and he has disappeared, as have a few

## SUBLIMINAL WARFARE

others. He did some extremely interesting work, and this was way back in 1968. At that time he was with the Space Biology Laboratory Brain Research Institute, University of California. The rest of his papers that I managed to gather about ten years ago are now classified. You can't get them for love or money. Hamer found that in a 9Hz signal the reaction time was definitely shortened. You were more alert. If you changed that signal down a few cycles per second, 3Hz to 5Hz, look what happens to the reaction time. This applies to human beings, monkeys, cats, - apparently all life forms that have brain waves.

Let's get out of here and into other things. Solar activity and incidence of cerebral spinal meningitis. Tom Bearden was talking about carrier-possibilities? We don't know whether the waves lower your resistance, or you can actually put the information on them and it is recreated inside the nervous system. Crest days of weather and the relation to sun spots and magnetic disturbances, etc. Mortality, diseases of the nervous system and the lower curve of sun spot activity. In other words, we are looking here at natural ELF phenomena before it began being manipulated. Sun spots and earth's magnetic activity. Again - epidemic meningitis.

Okay, now it gets really interesting. Socio-political mass disturbances, 1923 to 1927, in Europe, related to Full Moon axis. Remember, the full moon modifies the tides. It modifies these frequencies. In this case the tides are in the Ionosphere and the Heavyside Layer and their position above the earth. Double daily deaths from angina pectoris, and combined groups on the Lunar axis. What if we could manipulate this? Whole populations would be subject. Tuberculosis. Does it influence those germs, those little microbes as well? I don't know, but there it is, positive correlation. Cholera in Russia, from 1823 to 1923, versus solar activity in the same period.

Our first attempt at manufacturing psychics and radionics operators and healers was to put these little light bulbs in an empty eyeglass frame. On the left is an incandescent bulb and on the right is a little cold cathode indicator, like on your FM radio tuner. We flashed these little lights in real time to the Schumann resonance (we picked the Schumann resonance up on a coil), filtered out everything except that wave to which he psychics would entrain and fed them this little flickering light.

If you flash a light in a person's face you get an evoked potential in the occipital cortex. That's the photic response. And you know that if that is at a certain frequency you are going to turn that person on to epilepsy. But, if you put in a beneficial frequency, you can probably cause an evoked response of the brain wave at that frequency. Now that was marvelous, except for one thing. It takes about one hundred milliseconds from the time that light flashes for the signal to cause an evoked potential, and that hundred milliseconds

varies for most human beings. In other words, you can test IQ with this little box. The longer it takes that flash to get out here as an electrical signal the dumber that person is because the slower his system is responding.

After we found that this thing could alter moods, the questions came up: Is this hypnosis? Suggestion? Am I a magician? Am I doing it? So it occurred to me that I'd carry this thing around with me in my pocket. Now, I'm a bachelor. I've been divorced for twenty-some years; so I eat out three meals a day. So when I went to Denny's Coffee on Sunset Boulevard I put this thing in my pocket, and occasionally I set it at a specific frequency that I'm not going to mention - because I've been asked not to by the people who can ask other people not to do things.

And pretty soon the waitress would start dropping coffee into the laps of patrons. The babies would start screaming. People within a 10 or 12 foot radius (that's a 20 foot room), would begin freaking out. I'd surreptitiously turn this thing to two Hz higher in frequency. Hahhhhhh (a simulated sigh of relief), you could hear the room calm down. If you had a pocket Radio Shack decibel meter, the cocktail level effect, the volume of the conversation will drop, noticeably, in decibels.

Any of you wake up about 4am and can't get back to sleep until sunrise? Okay, you know why? We've been getting some very strong Russian transmissions. There is a particular anomaly that's the same as the Dawn Chorus - if you're familiar with atmospheric propagation research. It makes you particularly vulnerable at that time. Notice on this top curve, this 8Hz, the thing on which we want to latch if we're pure, spiritual and psychic - whatever that means. Four

o'clock in the morning the bottom drops out and whatever is left is going to get you baby!

Anyway, when Dr. Andrija Puharich was out here (in California) and Kathleen Joyce and I hosted him, we showed him the apparatus. This is probably the first he had heard of the psycho-physiological effects of the ELF fields; and I recall on your living room floor Kathleen, where he flexed his muscle near the coil, saw the spike readout on the oscilloscope, and realized that we finally had a detector in human captivity that could see micro-gauss levels. In other words his EMG, the few micro-volts of potential, firing through the nerve impulses, through the conductive layers of his skin, was creating enough of a magnetic field to read out on this thing.

He got very excited, so we began showing him some of my research dating back for about the last eight years, and he decided that this was important enough to take back to the United Nations. So he contacted the chap who really runs the government. This man has survived about the last five administrations. He must remain nameless because he is in a very low-profile position. I can assure you he is no-one that

But Russian physicists were! They later proved ... the human kingdom, reacts immediately to the magnetic changes of the sun, and offered this knowledge for the practical and tactical use of the military maniacs in Moscow.

## SUBLIMINAL WARFARE

you have ever heard about or read about in newspapers. They sent me an airline ticket and invited me to come back to the United Nations.

Dr. Puharich and I were supposed to have about an hour. It ran into a two and a half hour briefing. Kurt Waldheim (Secretary General of the UN) was out of the country at the time, so our host and chap that we informed was the number two man in the United Nations, Rudi himself. .

Now, the experiments which caused all of the excitement. Any of you guys ever been in Ossining, New York and seen this Faraday Cage? (The home of Dr. Andrija Puharich, 87 Hawkins Ave, about 40 miles north of New York city). It was probably the most sophisticated cage in captivity. It had three layer of copper and three layers of soft iron. In other words this is H wave shielding, and copper shielding for the E wave Faraday Cage. The thing probably has as much attenuation as the one at MIT (Massachusetts Institute of Technology) the triple new metal cage.

Okay, what we did here, we took this little box. Let's break it out here. This box has been disarmed. It is only mildly psychoactive. We did this at the request of the people who tell you to do things, for damn good reasons. We placed it outside the Faraday Cage. We sealed it up. Incidentally, the pickup, the magnetic pickup coil, is over here in this plastic garbage can filled with sand, to act as a microseismic damper - so that we weren't seeing quite as much vibration. We worked with several subjects and this little box was run by one of Dr. Puharich's secretaries, outside. She was told to turn the dial a little bit. Turn it on. Don't tell us what's happening. Turn it off. Turn the dial to another number. Turn it on. Turn it off. Total double blind. No one inside the cage knew what was going to happen or when it was going to happen.

The subject's brain waves were going from one channel on a chart recorder, with zero cross-talk. The other chart, with a tape recorder, was going to a magnetic pickup; so we could compare the brain waves of the subjects with what was happening magnetically inside of this absolutely airtight, secure environment. The chart readings - the one at the top and bottom were 180 degree changes of the magnetic pickup. The centre portion of that chart was the human subject's brain waves. Over the range of 6Hz to 14Hz, with some subjects there was 100% entrainment, of frequency and phase. Get that!

They locked on total! A little box the size of a package of cigarettes, when it uses the neural frequency principle can entrain the brain waves of a subject inside a totally shielded room, without his knowledge, consent etc. That's what this is all about.

What we're saying here by entrainment - if you look at the shape of this wave, they all fall on the same time rate. Starting from half a second to four seconds after the box goes on, the brain waves, the neurons, are being totally

driven by this little magnetic oscillator. It is down below 25 nano-Teslas at the source. A nano is one billionth of one Tesla. A Tesla is ten to the fourth gauss.

Our government was playing at that time - God, I guess, with the multi-billion dollar Project Sanguine. Their purpose was to communicate with submarines under water, with ELF magnetic fields. The project was kicked out of Wisconsin, Michigan, and a few other places by people who had a certain nervousness about environmental disruption. They were trying to use power lines as antenna systems, surreptitiously.

Back in March, the 26th and 27th this year (1978) a chap named Mike Theole, who is a journalist for the Eugene, Oregon *Register Guard*, decided to take his life into his hands and write about some of these things I have some

A guy with a 25-Watt transmitter - with the Luxembourg effect with a few Hz frequency difference from a 50,000W broadcast transmitter can mood-manipulate an area of about 200 square miles. Dangerous? Hell yes!

copies of these and many, many other articles that appeared in the public press prior to the time of the total news blackout. There were a few articles for a few days. A day after this one there were the denials, by the FCC, the EPA, etc. "Mystery Radio Signals May Cause Illness". Hell! They were totally disrupting left and right (brain) hemisphere synchronisation! People who had never any tendency toward epilepsy, had no hereditary tendencies in this direction - were going slightly unconscious. According to Marshall Van Ert, there was a two mile stretch of perfectly clear highway where

there had been four deaths in about a week. People were simply driving their cars off the road or into a telephone pole, or into oncoming traffic.

These are not apocryphal stories. These are a matter of public health records. It's in Los Angeles now at about 25 microgauss, and yes, it's spreading. Now the reason that Eugene, Oregon, is particularly toxic is because there is an 800 mile long antenna terminating up there, called the Bonneville Power Authority transmission line. I guess some of you engineers have heard of this thing. They are generating current and sending it down to California as direct current, 340,000 Volts. A DC line is an absolutely perfect, long wire antenna. In fact it would be highly attractive to people who couldn't launch Project Sanguine to use that as our own transmission system, at 2.2Hz.

The next thing was that the power grid was identified as the source of the signal. Any high school kid can tell you that any long wire hanging out there in space can act as an antenna and pick up all the other signals that are being transmitted and re-radiate them. Okay? Even if our Navy is fooling around with long wires as a substitute for Sanguine antennas that had been ostensibly kicked out of several states. They traced the signal and it was strongest around power grids. So what else is new?

These are some of the newspaper clippings that are in the archives. Now, they created

## SUBLIMINAL WARFARE

such an outrage among everyone who graduated from high school that the FCC itself (Federal Communications Commission) had to back off from this embarrassing, pseudo-solution.

"Could they be having one frequency which they want to work with and the others are just to mislead us?" (asks a listener).

Yes, (replies Dr. Beck), they have phantom frequencies. They are reconstructing heterodynes. Let me tell you why we're getting it and they are not: We are on a 60Hz power grid. They are on a 50Hz power grid. Get that? That's why they're immune. Every civilised industrial centre in the Western world - except one little segment still, near Chicago which is on direct current - and one which is on I think 50Hz in Arizona, is a potential radiating weapon of this psychotronic ELF field. In other words, why should they build antennas, re-radiating systems; when all of us have 110Volt systems in our homes; and we are also served with gas pipes, miles and miles of conductors, cold water pipes etc.

"Is there a quick explanation of why 60 cycles will pick it up instead of 50?" (asks someone)

Right. It's a harmonic! (replies Dr. Beck, and turns on his recording of the audio part of the Russian broadcast) at 5.340MegaHertz.

The growl was because we have a voltage control, or rather the VFO on the receiver. That was at 5.340MegaHertz, and we were listening to - in other words, since you cannot hear the fundamental (the actual ELF wave) we have the local oscillator on the superheterodyne receiver running. It is a global problem. Incidentally, for the engineers again, the attenuation rate of this signal will go around the earth 4.5 times before it is down a half of its original value. Nikola Tesla was right. With some of these frequencies you can excite the earth ionosphere cavity, as though it is a huge bell, and ring it! In other words, the Russians have a thing here which cannot be stopped. It's

practically not attenuable by anything that we are familiar with in physics.

Okay, now a lot of this is resonance. What we don't know is how much of this is being originated domestically? How much of it is a second or third order harmonic effect? And what the real and what the virtual parameters are

actually engendering? But meanwhile, from the standard textbook of physics, if we look at the E wave as being standard propagation wave form - as being parallel with this screen - the B wave, or H wave, the magnetic vector, is at right angles to this and has to accompany it.

When you strip off the E wave by shielding, by natural attenuation, you still have that H wave left; and that is the one against which you cannot shield. It goes right through you, everything else, and can trip certain neurons in your head.

This report is from a previously classified document done by Dr. Wartz and Dr. Erkins, of Garret Air Research for the CIA showing the "windows" that could be the stimulus for ESP, paranormal, Russian psychotronic research. Does that look familiar? If you move that down about 2Hz, you ain't got a psychic, you got an epileptic!

Some of the propagation paths of the various nodes. The whole earth ionosphere cavity rings like a bell. At certain frequencies you can put a little energy in here and under the same conditions get the same amount, or even a little more out, somewhere else. Tesla was right.

A little Soviet loveletter, U.S. Patent, Nov.20th 1973, Apparatus For the Treatment of Neuropsychic and Somatic Diseases with Heat, Light, Sound and Electromagnetic Radiation - a trial balloon to see how much we knew about what they were doing. It's Patent #3773049, and among all these words they hid their little gift, which you'll come across when you read the whole patent.

Apparently, certain neurons in the cerebral cortex act a frequency modulating discriminators. Any of you guys who have played around with radio know that you have a crystal set, and you hear several stations simultaneously, you get a garble. They are all overlapped. You can't sort them out; but the frequency modulation discriminator will latch onto the highest amplitude signal in the environment, override the others, and you'll hear that. If you are listening to Police Radio and a loud station comes in, overriding the other, you'll get one or the other. There's very little crosstalk. So what this thing does basically is that it puts out a little magnetic H wave field with a

spike wave which we don't like. We like to work with a different wave form that I don't want to talk about. But this thing is apparently mildly psychoactive, but not nearly as psychoactive as the ones they used for the tests in Los Angeles, the ones at the United Nations, and Ossining, New York.

Now, what I'd like to point out to you is that in this very narrow frequency spectrum corresponding to the Alpha-Theta border of brainwaves, you can change the excitation frequency by a fraction of a Hertz, and have an entirely different reaction. Now this was a big surprise. This is the thing that was not anticipated any more than the little germs were before Von Leeuwenhoek and Pasteur.

One reason I feel that this effect has been missed by other researchers who were working with gross frequency inputs is that they were not defining their frequencies down to a hundredth of a Hertz. Now there's a tremendous amount of a supportive evidence in the neuro-physiological literature that certain molecules in our brain, with dielectric constants of over 140,000 and other inductive capacitor parameters, act as long chain, semi-liquid crystal dipoles that are extremely sensitive to coherent frequencies.

Where I think I have done original work is in building systems that can go out to that second, third and fourth decimal place, taking them to the coffee shop, testing them on my own head and seeing what they do empirically, and kind of sounding the alarm on what we are now experiencing.

### NOTE

Pages 421-A to 421-J are a small sampling of material from NEXUS NEW TIMES MAGAZINE, available from Nexus Magazine, P.O. Box 30, Mapleton, Qld 4560, Australia; Subscription rates are \$US25 for 1 Year and \$US45 for 2 yrs. An incredible research resource.



©Cary Wolfe '91



# M A T R I X I I I

## ORION TECHNOLOGY AND OTHER SECRET PROJECTS

### Introduction

This report was constructed from over 9 hours of video interviews, personal interviews and individual commentary. It is structured in an open question-answer format, without regard to who is asking the question and who is answering; this format also allows insertion of other data in the later part of the report in the same open Q&A format. The data is not proven or verified, but is reported as received. This report contains information on the following: The Philadelphia Project, or Project Rainbow, Phoenix Projects 1-3, origins of the Radiosonde and connections with the work of Wilhelm Reich, government weather control programs and hidden agenda, the Montauk Mind Control projects, the deliberate murder of thousands of American children in mind control research and time tunnel experiments, government time-tunnel projects and operational procedures, how Nickola Tesla and Von Neumann contributed to these projects, the "martyrdom clause", mind control by individual signature, technical ways to produce planetary holograms and Matriya effects, the explanation behind closed time loops, government rationale and plans for the confinement camps and slave labor, Project Dreamscan, Project Moonscan, the Airborne Instrument Labs, Project Mindwrecker, the alien groups known as the Kondrashkin and their interaction with US Government mind control programs, the Kamogol II and Giza Groups, the negative Sirians, Soviet scalar weaponry, Orion Group manipulations, 6th root race incarnations, telepathy producing drugs and their use and suppression, the FAA and zero-time generators, technical spin-offs from the Philadelphia project, the International Aerospace Alliance, cross-section of implant device, Wilhelm Reich and mind control, Reichian Orgastic-type programming and its use by the US Government and Sirians, the Psi-Corps, Alien soul-trading, Montauk and the aliens from the Antares system, the Leverons, the Elohim Group, the US Navy and time-tunnel projects, the US Government and the Greys, electronic life support systems of the Reptilian Humanoids, new life form masses over the poles and their relation to yearly outbreaks of flu-like disease, AIDS and Fort Dietrick (NSA), Maglev trains and the US underground tunnel network, the missing human genes, buried spacecraft and alien technical archives under the Giza pyramid, the coming new money, the "Black Nobility", Nordic and human copper based blood systems and physiology, the technology of cloning and the development of synthetic humans and political replacement programs, the Middle East situation, Congressional awareness of drug and alien agenda, the MIB, the US Army and the black helicopter



## M A T R I X I I I

forces, government mobile mind disruption technology, nature and purposes and the Orion Group, fourth density transmutation of the human race, geological changes, Sirian Mind Control technology, and more, along with illustrations gleaned from witnesses with photographic memory and a lot of courage. This information is supplementary to that in Chapter 7.

### The Interviews

Where do you want to start?

Let's start with the Phoenix Project.

It was a project that evolved out of the Philadelphia Project. It was a project that the Navy did in the 1930's and 1940's in an attempt to make ships invisible. They threw the switch one eventful day and the ship went into hyperspace. They had all sorts of problems with the people on the boat. It was a huge success as well as a huge failure - then they shelved it. Around 1947 it was decided to re-activate the project and it was moved to Brookhaven National Laboratories with Dr. John Von Neumann and his associates. ut of Phoenix I came Stealth technology, which I cannot talk about because of my job. It also produced all sorts of energetic little toys like the radiosonde.

What is a radiosonde?

Well, in all appearances it was a little white box that they attached to a balloon and sent up into the atmosphere. The government told people that it involved gathering weather data. It used a very unusual type of pulse modulation. In most cases they used a CW (continuous wave) oscillator and pulsed the signal. This turned out to be a very efficient conversion of electrical energy to etheric energy. I very recently started collecting radiosondes. I never saw a receiver. I found out that they were designed up at Brookhaven National Labs. I started to talk to people at Brookhaven and ran into a retired gentleman who used to work there. He told me that the design was originally done by Wilhelm Reich. That peaked my interest. The story goes that in about 1947 Wilhelm Reich handed the US Government a weather control device, a device that would do DOR-busting. Reich thought that if he could decrease the amount of DOR that storms would not be so violent. (DOR is the result of orgone energy coming into contact with an enclosed radioactive source. This produces a Deadly Orgone Energy - DOR - which threatens life. It is also produced in the atmosphere through other processes. The government sent the device up there into a storm and it did reduce the intensity of the storm. The government liked it, and they started another phase of the Phoenix project where they designed these "radiosondes" and started launching them

## M A T R I X I I I

in large numbers, maybe 200 to 500 per day. The radio in these things had a range of about 100 miles. If they used so many of them, one would think that receivers for them would be common-

place. I used to be a collector of radio receivers. I have over 100 in my personal collection. I have never seen a radiosonde receiver. I have heard of them but I have never seen them.

What are the frequencies used?

The frequencies used are 403 MHz and 1680 MHz. They used two different frequencies.

They are both on at the same time?

No. One or the other was used at any one time. The earlier ones used 403 MHz plus or minus 2 MHz. The later ones used 1680 MHz, plus or minus 6 MHz. The "thermistor" in them had gold, silver, platinum and iridium in it. Reich used sensors that had gold and silver in them. The humidity element is a plastic plate with silver around the rim and conductive lines going across the plate. They put a very unusual mixture of chemicals on this plate. Unlike most humistors, the resistance went up as it got damp.

What we're theorizing at this point is that the "thermistor" (temperature sensing) rod acts like a DOR antenna out-of-phase. The "humidity sensor" acts as an antenna for the orgone. The pressure sensor is essentially what they call a barrel switch, which is a pressure sensitive cycling switch. The device would destroy DOR and build up the orgone. The transmitter consisted of two oscillators, one of which would run at the carrier frequency (403 or 1680) and a second one which was a 7 MHz oscillator hooked into the grid of the carrier oscillator. The result was that the 7 MHz oscillator would pulse on and off.

How does all this relate to what was going on with these other projects?

The government could not tell the public these were weather control devices. What we are seeing here is actually the genesis of what became the Montauk project, which was a combination of Wilhelm Reich's work and the Philadelphia Experiment. There were two separate projects going on in Phoenix One. You had the invisibility aspect and you had the development of Wilhelm Reich's weather control. Toward the end of the Phoenix project, by using some of Wilhelm Reich's concepts and some of the transmission schemes used from the "radiosonde" project, they found that you could combine the two factors and use them for MIND CONTROL. Government circles would have me say "mood alteration", but mind control is what these idiots were doing.

## M A T R I X I I I

That's what the Montauk project was?

No. Phoenix One. After political circles found out about it they wanted it shut down. The people that were running it went to the military and proposed that they could use it to "influence the minds of the enemy". The military loved the idea, and let them use the old Montauk Air Force Base. Among the equipment requested was an old SAGE radar unit, which was on the base. The base was shut down and everything was auctioned off. The group then moved in from the Brookhaven Labs. That began what we call Phoenix Two. They spent the first ten years, from about 1969 to about 1979, researching pure mind control. They started out by taking the output of the SAGE radar, modulating the special wave that Reich had showed them from the weather control process, and combined that with something noticed from the Philadelphia Experiment work. They transmitted about 406 MHz. It would hop around frequencies and change in phase. They used the amplidine concept where you have many stages pulse-modulated. BRF was from 10 cycles to 750 cycles. The pulse width could be varied anywhere from 10 to 75ms. The center frequency was 406MHz generated from a stay-low type function which was referenced from a zero-time function.

Was there any other modulation on this?

There was frequency hopping on it.

So Phoenix Two started in 1969?

Yes, in the period from 1969 to 1971. Phoenix One went from 1948 to 1968. The first part of the mind control project was to take an individual and stand them about 250 feet away from the antenna. The SAGE radar had a peak pulse power of .5 MW. The antenna had a gain of 30db. That means an effective radiated power of at least a gigawatt. It was nominally a gigawatt. Can you imagine what that would do to people? I think its amazing these people are still here. It does things like burn out brain functions, create neurological damage, scar lungs from heat, etc. They tried this with a number of people and there were few survivors.

Where did they get the volunteers for this?

They were just grabbing indigent people off the street and throwing them in front of the radar beam. That's the sort of nonsense that the government loves to do.

Who was in charge of the project at this time?

Dr. John Von Neumann and Jack Pruett.

M A T R I X I I I

Any particular agency?

I'm not sure what the agency was. Now, somebody got the brilliant idea to put the subjects directly in line with the gain horn of the antenna. Lo and behold they got their result without burning the people up. They found out that by varying the phase modulation and the frequency hopping and the pulsing of the multiple phases that they could have profound effects on a persons mind.

How many people worked at this installation?

About 30.

Who authorized them use of the base?

The Air Force and the Navy. It was a joint project. There were both Navy and Air Force personnel involved. We have copies of the orders for the Air Force personnel.

What was the cover story for the base?

They had none. It was a derelict base.

It was abandoned. It was turned over to GSA as surplus around 1969 or 1970 when they shut down all the SAGE radar systems. It was a "non-existent" operation. It was a perfect cover.

Where did they get the funding?

It was totally private.

Corporations?

It didn't originally come from corporations, although it did in later phases. The original money came from the Nazi government.

This is Phoenix One?

No, this is Phoenix Two and Three. In 1944 there was an American troop train that went through a French railroad tunnel carrying \$10 billion in Nazi gold which they had found. It was \$10 billion at the 1944 price of \$20 per ounce. The train was blown up in the tunnel. It killed 51 American soldiers. The gold turned up ten years later at Montauk. This has been verified. That money was used to finance the project for many years as the value of gold went up. They spent all of it and ran out of money. That's when they tapped on ITT, who funded it. ITT was owned by Krupp in Germany. In terms of personnel, many of the civilians and scientists there were

## M A T R I X I I I

all ex-Nazi's who came from Germany both before and after the war ended. The project was under US Government surveillance. The intelligence community knew what was going on and the CIA

monitored everything, as did other government intelligence agencies. The field of players who actually operated on the base was small, between 30 and 50. The funding was entirely private. After 1983, Senator Goldwater found out about it and started an investigation. He couldn't find any trace of government funding. Pruett was the metaphysical director of the project. He was Air Force. After he left Dr. Herman C. Untermann took over. They had an electronics expert, Dr. Mathew E. Zerrett, who came over from Germany in 1946 with Werhner Von Braun. Probably the reason that they ran out of money is that they had a total of 25 bases around the United States to support. The last of the bases shut down August 12, 1983. The base at Montauk, where all the stations got their zero-time reference from, shut down and the other two remaining bases went down with it.

What about some of the mind effects?

From what I recall of the program, as I was part of it, I was subjected to the mind control field not as I initially went into the program (because they wanted me initially for my sensitive abilities) but later. I was assigned to the indoctrination of the younger recruits. The first indoctrination turned out to be a disaster. I told them I didn't want anything to do with the program, and they put me in front of this mind beam, and it did do damage to me. Finally, someone said, "shut it off, he isn't going to give in to it" and they shut it off. Others were affected much more seriously than I was. The effects were generally really bad. It could burn your brains out. They would go out and pick kids between the ages of 12 and 16 off the street...

That's where a lot of disappearing American kids went?

We estimate they took 10,000 American children off the street and brought them to Montauk, New Jersey. The total number of people that they pulled off the streets for the 25 stations was about 250,000. What the actual thrust of the program was in terms of all these kids is still a mystery. We still don't know the answers. We know they were fully programmed for something. They were subjected to programming which eventually became more "humane" using advanced electronic techniques. The original programming was Reichian in nature and was more physical. Later they worked out techniques that used computers and electronic programming with the Reichian techniques that took very fast and had little side effects.

Are you aware of any people presently who have been through this?

## M A T R I X I I I

I've run into people over the years. There is a very specific field identity pattern you can detect if you are sensitive enough. You can spot a person who has been through the Montauk program "five miles away". It's very distinctive in the way that it's been altered. I've spotted more than a dozen people in the Long Island, New York area.

What about Von Neumann?

He was still alive up until 1989. He has run into a problem with the government as well as other problems, such as a personality split in 1977, when he resigned as director and became a consultant. The government told everyone he died in 1956. The government is still interacting with him.

Were any of the Montauk subjects given psychotropic drugs?

I don't think so...

They used one drug which was used in connection with the Reich programming to make them more receptive. I don't remember the name of it. The effect of the drug was that it would make you "horny as hell".

Also euphoric at the same time?

Also euphoric, yes.

Did they get this mind-altering chair from the aliens?

The prototype came from the aliens. Beyond that we are uncertain. This chair was essentially a mind amplifier. The government would have specially trained individuals sit in the chair and generate thoughtforms, which would be amplified and transmitted. They could transmit the signal and put people in a pre-orgasmic state where they would be receptive to programming. It worked very well and they found other capabilities. They found that it could work in time. They had a psychically trained individual sit in the chair and generate a thoughtform of a vortex that connected 1947 and 1981. That's exactly what they got - a time tunnel they could walk through. There was a series on television at one time that portrayed this concept fairly accurately. These were some of the earlier capabilities. They started going forward and backward in time. That was the last phase of the Phoenix project.

When did this time machine get going?

Around 1979 or 1980 it was fully operational. This transmitter had enough power to warp space and time. The individual in the chair would have to synthesize the vortex function because they didn't have the technical capability to do that. It can now be mechanically synthesized. They did other things. They

M A T R I X I I I

had the subject in the chair think of some creature, and the creature would materialize. They had the individual in the chair think of all the animals at Montauk point charging into town, and that's exactly what happened. They almost had the power to create a being. The problem they had was that what they created only stayed as long as the mind amplifier was on. The power was somewhere between gigawatts and terrawatts. Tremendous power. The vortex could have a diameter of about five miles.

Can you describe what this looked like?

Its like looking into a peculiar spiral tunnel which was lit up down its entire length. You would start to walk into this thing and then suddenly you'd be pulled down it. You didn't walk through it as such. You were more or less propelled through it. You could go anywhere in space and time.

Could you bring things back?

Yes.

Have you ever brought anything back?

Yes.

Could you continue your description of the tunnel?

Yes. The walls were solid but fluted. The tunnel was not straight but was a sort of corkscrew shape.

If someone turned off the power, would you be stuck in the destination time and space?

Yes. You'd be stuck there.

Did they send a lot of kids down the tunnel?

Yes, but we don't know what their goals were. They lost a lot of kids.

Since there is a time loop between however far you went back in the past through however far into the future, is everything fixed?

Yes.

One of the first things they did was send recruits forward to around 6030 AD. It was always to the same point. Somewhere in an abandoned city where there was a statue of solid gold. When they came back they were asked what they saw. Whether they were expecting to find a different answer from person to

M A T R I X I I I

person is unknown. They would look into the vortex and make sure the environment would support life before they sent people. They took samples.

Are there potential futures that people could be sent to?

No. Once you make the connection with the future the line becomes fixed to that point.

Can you change the present by sending someone to the past?

Yes. You can also change the present by sending someone into the future. Under certain conditions. The government is using existing time machines to go forward in the Montauk time line.

Are you saying that now the present can't be changed because we have established a time-loop through the future and the past?

Yes. That means whatever everyone is doing between the most extreme past point and the future they will be doing forever.

What is the furthest anyone has traveled in the future?

10,000 AD.

So everything is locked in until 10,000AD?

Yes. It's a dreamlike reality. No one has picked up a tangible future beyond 2012 AD. There is a very abrupt wall there with nothing on the other side.

Prophecies speak of earth changes around then.

Curious, isn't it?

Can you project yourself two hours into the future and meet yourself?

Yes, but its very dangerous. The person who walked into the tunnel is out of phase with the person who comes out the other end. This did happen. The result is that the person just incinerates.

Did they ever give you a weapon in case you ran into anything negative?

They didn't have to do that. The vortex could be arranged to follow the person, so that they could bring them back in if anything went wrong. They could see them on a viewer.

So they achieved a working time portal. At one point they had



## M A T R I X I I I

a situation where they had a "monster from the ID" type creature come through and everyone went into a panic. They shut the transmitter off. The creature ate people and equipment. They had to go back and shut down the unit in Philadelphia in order to shut off the unit in the future so they could stop this creature in 1983. This was on August 12, 1983. The vortex locked on to the 12 August 1943 test and formed a loop. All this occurred because someone planted the thought in the mind of the operator in the chair to generate this creature. It was an effort to sabotage the project. A lot of people thought the project had gone too far. When I worked for them between 1971 and 1983 I was so tired when I would get home from work. What they would do is that when I my mission was over they would return me to a point milliseconds before I left. It would appear from one perspective that I never left. Of course, after I stopped working there, all that stopped.

Is there a reason that all these things happened?

If you go back into the Philadelphia experiment end of it, which was the beginning of the whole business, one can see from the way that thing was maneuvered that there was a higher force of some kind involved in setting the whole thing up....because it never would have happened the way it did unless two obscure dates 40 years apart coincided between the two experiments: the project known as the Philadelphia experiment , or Project Rainbow, in 1943 and the Montauk project in 1983.

If I may interject something here. There is a point about two thirds of the way down the time tunnel where the person who is going through the tunnel perceives a large "thump". The person's consciousness leaves their body. There is a tendency to see things on a broader basis. I am sure there was some intelligence there. Looking back on my experiences, I'm sure there was some intelligence there. I would have trouble with the recognition of it. What they were trying to do at Montauk was to stabilize the perception process that would occur upon exteriorization from the body. They were trying to manifest that for some reason. We don't know what their purpose was.

What was the role of the aliens in this whole thing, other than the prototype of the mental amplifier chair?

That would be the another part of this that we haven't got into yet.

Let's look at what the Philadelphia experiment got into in a technical sense. It was what started all this happening. It originally began back in the 1930's in Chicago with three people. Dr John Hutchinson Sr., who was the Dean of the University of Chicago, Nickola Tesla, and Dr. Kurtenaur, who

## M A T R I X I I I

was an Austrian physicist who was on staff at the University.

They decided to do something with the speculation regarding the concept of things and people being invisible. This subject had been discussed for several year. They got together and did some research at the University of Chicago around 1931 or 1932. In 1933 the Institute of Advanced Studies at Princeton was formed and the project was transferred there in 1934. One of the people on staff at the Institute was Dr. John Erich Von Neumann, who was from Budapest Hungary. He got his degree in chemistry in 1925 and his PhD in mathematics in 1926. He taught in Europe for about four years and transferred to the United States. He taught at the graduate level for three years and was invited to join the Institute.

Other people at the Institute included Albert Einstein, who left Germany in 1930. He went to the California Institute of Technology for three years and taught there and then went to the Institute upon their invitation and acceptance. A lot of other people showed up there as time went on. The project expanded about 1936. In the meantime, Tesla was named director of the project. He was a friend of president Franklin Roosevelt, whom Tesla met in 1917 when FDR was secretary of the Navy. Tesla was asked at that time to do some work for the government for the war effort, which he did. He accepted and became director of the invisibility project until he resigned in 1942. In 1936, after intensive study, they decided to have an initial test of their work. They achieved some partial invisibility. The Navy and everyone else was encouraged to continue the work, and the Navy supplied money for research.

Scientists were coming to the United States from Germany until 1939, when the war with Germany was started.

In 1940, after research using Tesla's approach, they decided they were ready for a full test at the Brooklyn Navy Yard. They had a small ship and a tender ship at each side. One ship provided the power and the other supplied the drive for the coils. They were tendered to the test ship by cables. The idea was that if anything went wrong they could cut the cables or sink the test ship. Everything worked and the project was declared a success.

The important point about the 1940 test is that there was no one on board the test vehicle. It was strictly a dry run with no people. This is important because of what happened later.

Other people came on board. Thomas T. Brown joined the project because of his expertise in electrogravity effects. He had the task of solving the problem of the German magnetic mines that were affecting allied shipping and Naval efforts. This led into a parallel project which involved the use of degaussing coils and cables to explode the mines at a distance from the

## M A T R I X I I I

ship.

The Navy wanted several people to keep an eye on the tests. That is how I got involved. Keeping technical commentaries. Let's look at Nickola Tesla.

In 1879 his father died and his first year at college ended. He came to the United States in 1884. He had enormously intuitive insight. He had a perfect track record. Before coming to the US he had known Robert Oppenheimer, who later worked with the development of the atomic bomb, and Dr. David Hilbert, the mathematician who devised equations for Hilbert Space, which described multiple space or multiple realities mathematically. These equations for multiple space became very important in the project. Dr. Von Neumann met Hilbert in 1927 and retained a lot of what he had learned. With that, Von Neumann developed other new systems of mathematics. Von Neumann was considered to be one of the most outstanding mathematicians in this century. Some think he was better than Einstein. Another mathematician involved was Dr. John Levinson, who was born in 1912. He died in 1976. He published three books on mathematics. There is no other history of Levinson himself anywhere that I can find. Levinson developed the so-called Levinson Time Equations. With all this behind them, the group had all they needed to proceed with the project.

After the successful 1940 test, the Navy decided to give the project unlimited funds and to classify the project. On December 5, 1941 I was in San Francisco and the government came and told me that a war with Japan would start within 72 hours and that they needed me to assist them. In January 1942 I ended up at the Institute of Advanced Studies. Tesla was given a ship and a crew for a full sized test. Tesla got a battleship. Tesla and Von Neumann didn't agree on some things. Tesla insisted that they were going to have a very severe problem with personnel. Tesla wanted more time but the Navy wouldn't agree. Tesla made periodic announcements in the late 1930's and early 1940's about his contact with off planet species. He was in contact with the outside, who agreed that there was a problem with the people. He decided to sabotage the 1942 test in an attempt to stop the project. He de-tuned the equipment so nothing would work. The test failed. Tesla then turned the project over to Von Neumann in March 1942 and left the project.

Von Neumann went to the Navy and requested time to study the problem to determine what had gone wrong. Von Neumann decided to make changes in some of the equipment. He decided he would need a special ship that was designed from the ground up. The Eldridge was selected. The equipment was built into the ship. They put all the equipment on the ship. October 1942 arrived. They selected 33 volunteers for the crew, who arrived after graduation in December 1942. We still have a picture of the

## M A T R I X I I I

class.

After the ship was out of drydock work began. In May of 1943 Von Neumann installed a third generator. It would never synchronize with the other two. It went out of control one day and zapped one of the men. Von Neumann pulled out the third generator (installed because Tesla had convinced Von Neumann of the potential problem with people) and went back to the original design. In mid June, the ship had sea trials. On July 22, 1943, they had the test. The ship between radar and optically invisible. They discovered people very disoriented. The Navy pulled the crew off and consulted Von Neumann, who requested more time again from the Navy. The Navy, after consultation with higher-ups, announced that the drop dead date was on the 12th of August, 1943. Von Neumann voiced his concern that it wasn't enough time.

The Navy decided that it just wanted radar invisibility and not optical invisibility. The equipment was again modified by Von Neumann. August 12th arrived. We knew things were not right. The test began, and for about a minute everything was all right. The ships outline could be seen in the water. There was suddenly a blue flash and the ship disappeared entirely. No radio communication was possible. It was gone. In about three hours it came back. One of the masts was broken. Some personnel were partially embedded in the steel deck. Others were fading in and out. Some disappeared entirely. Many were insane. The Navy extracted the crew and proceeded with four days of meetings to decided what to do about the problem. They decided there would be one more test with another dry run without personnel. They conducted the dry run using about 1000 feet of cable attached to another ship. In late October 1943 the test occurred. The ship disappeared for about 20 minutes. When it returned, they found equipment missing. Two transmitter cabinets and one generator was missing. The cabinet with the zero-time reference generator was intact. At that point, the Navy stripped the ship and stopped the project. The Edridge served in the war and was turned over to Greece at the end of the war.

The important thing is that there were two tests that were exactly 40 years apart to the day. It was a 40 year separation in hyperspace. Now, the Earth itself has a biorhythm that peaks on a 20 year cycle on August 12th. It "just happened" to peak and provided the connecting link through the fields of the Earth for the two experiments to lock up in hyperspace. Walk-in efforts are aided if they occur during this peak.

The ship was pulled into hyperspace. We were inside the ship and knew something was drastically wrong with the test. We tried to shut it off but it wouldn't shut off. We ran out on deck and jumped over the side of the ship. We jumped overboard but ended up in a time tunnel which ended at

## M A T R I X I I I

Montauk, Long Island on August 12th, 1983. At night. We were found very quickly and taken down stairs, where Von Neumann greeted us. He expected us. It was a bit of a shock. We had just been in 1943 and now we were in 1983 looking at Von Neumann as an old man. He said that there was a hyperspace lockup and that we had to go back and shut off the generators on the ship or the hyperspace rift would keep increasing and possibly engulf the planet. He had been waiting 40 years for us to arrive.

Montauk sent us back and we smashed the equipment with axes. The ship returned to its original point in space and about three hours later in time. From 1943 on, Von Neumann didn't know what happened. He had modified earlier equipment in 1943 to where he had a full blown time machine. The Germans also were working on time travel, and had it working in 1945 just before the end of the war. This is all a matter of record.

After the Navy decided to shut down the project in 1943, Von Neumann was sent to work on the atomic bomb project at Los Alamos until that was over. In 1947 there were major changes in the Department of Defense. Someone in the new structure decided to dig up the Philadelphia project to see if they could find out what went wrong. They asked Von Neumann to "take another look" at the project. He agreed.

There is another matter. Starting about August 6th, 1943, UFOs appeared over the Eldridge for about six days. They were there during the test. One of the UFOs was sucked up into hyperspace with the Eldridge and it ended up in an underground facility in Montauk in 1983. It contained a charging device which some aliens made us go back and get for them, as they didn't want humans to have it. We don't know who they were. Pruettt was concerned about an alien invasion.

Also, Von Neumann was called by the government to come and assist in the examination of a crashed UFO in 1947 at Aztec. Another crash occurred at Aztec about a year later. The first crash had greys on it and none survived. At least one occupant survived the second crash. The radar systems unintentionally brought down the craft. Radar was used intentionally after that until the aliens got wise to it. The occupant of the second crash was not a grey, and Von Neumann got to talk with it. Von Neumann asked it what the answer to the invisibility problems could be. He learned that he had to go back and do his homework in metaphysics. The nature of the problem was that the personnel on the ship were not locked to the zero-time reference of the ship. Humans are normally locked to the point of conception as a time reference, not a zero-time reference. The time stream lock allows the person to flow in synch with the system so interaction is possible.

## M A T R I X I I I

Time locks are fragile. All the power of the project disrupted the time-locks of the people on the deck on the ship. When the ship came back in time, the people didn't come back to the same reference.

Von Neumann realized that he needed a computer, as well as some knowledge of metaphysics in order to be able to lock the time reference of the people to the time reference of the ship. He built a computer in 1950 for the purpose. It was ready to be installed in 1952 and a test was performed in 1953 that was successful. They didn't go floating off into space when it was over. At this point, the Navy canceled Project Rainbow and changed the name to project Phoenix.

A lot came out of the negative effects of the Rainbow project. Some of it led to mind control research programs in the Phoenix project. The invisibility research produced some Stealth technology as well as other highly classified projects.

In 1983, they decided to apply mind control to all participants in these projects in an effort to cover them up. They had also been working on another project: age regression. Now, Tesla had sought back in the 1940's to develop equipment that could help the members of the crew after they lost time-lock. The government developed it into the age regression program. It was physical age regression. A person retained the memory they had from the older age.

Tesla's theory was that if you took the individual's time-lock and moved it forward in time than you would remove aging. That's what happened. It took between 30 and 60 days for the body to complete the change to the new time reference.

Now, some of this turned up in the movie called the Philadelphia Experiment, which was released in 1984. The government got an injunction which banned showing in the US for two years. It was overturned in 1986 and it was out on tape. I saw the film in 1988, and it helped bring back some of my memory about this.

Do you have any initial comments about electromagnetics?

Well, there are a lot of interesting aspects. There is a lot that is not explained by most theories. It is not explained why a magnetic field only propagates at 0.4 of the speed of light, electromagnetic field propagates at the speed of light and an electric field (according to Maxwells equations) propagates at the rate of c-infinity, which means that it propagates throughout the universe instantaneously. If you understand those basic relationships and how they

## M A T R I X I I I

interlock with higher order energies and fields, like soliton and tensor fields, then you can understand how an antigravity drive will work. It is a fact that the unified field theory was completed by Einstein and given to the US Government. They have it and they don't want anybody to know they have it. It was never released publicly in any books. This kind of knowledge is used as a method of control between and for governments. It's unfortunate. The government is supposed to be "for the people and by the people". That is what it says in the Constitution. I wonder when the last time the president read the Constitution?

It seems like there are more people involved in secrecy than there are scientists. Where are all these people?

There are government agents and agencies everywhere that are concerned with keeping things secret. These days, the secrecy is applied more to the applications of hardware than the hardware itself. It's not like it was in the 1950's. As an example, the guidance package for the new Minuteman X missile that was developed for the Air Force by Northrop is unclassified. There was no classification on the circuitry and the layout. It was so accurate that it could take a missile 5,000 miles and drop it down a chimney stack. The applications and what it was capable of was classified.

Isn't a lot of this left out in the open to distract people from what is really going on?

Of course.

What is the capacity of the gravity craft fleet of the United States?

I don't know. I know that they have built quite a number of them.

What are the capabilities of these craft?

Well, when our astronauts first landed on the moon in 1969 they were greeted by a fleet of disks sitting on the rim of a crater. The astronauts asked their superiors if they knew about these disks. They were told "yes", that they were American disks. The astronauts were angry at being used as public relations men by the government.

Why spend so much money on the Stealth bomber when they have had this gravity technology for so many years?

Well, the aircraft combines two aspects for invisibility. One of the aspects relates to the construction and coating applied to the surface. The other aspect relates to an

## M A T R I X I I I

electronic type of invisibility package which is a result of work done on the Philadelphia experiment years ago. Also, the Stealth has a secondary drive system which is very advanced and allows it to fly in space. The assistant director of NASA admitted that this came straight out of alien technology. He admitted this to the public.

He did?

Yes.

That's interesting in view of the government's apparent position with respect to covert technology.

There are breaks in the government secrecy programs that are starting to show up. More and more people are getting totally disgusted with government activities and attitudes and they are beginning to talk.

Maybe it's a deliberate leak.

It could be deliberate. Even MJ-12 in 1984 was about to break some information to the public about ET's and UFOs. They decided not to release it at that time. John Kennedy demanded that they release it within one year. He also demanded that the CIA get out of the drug business. They assassinated him.

Have you found any resistance to what you have been coming out with?

No. The Navy keeps quiet, but I hear rumblings underground that they are definitely not pleased about it. The so-called "martyrdom clause" works in my favor. They know that I know why they can't touch me. If they do, they know that there will be real problems in time and space because of it. There are two of us that are holding certain factors in stability. If anything is done to either of us, there could be a rip in hyperspace. The whole reality system will shift. I will give you one guess as to what it will most likely shift to: We won the second world war by a slim margin. German technology was way ahead of us. If the war had gone on another 30 days the Germans would have won it. They had super weapons in production which they were ready to use. They were so close to winning the war that Churchill and FDR were really worried about it. If the system shifts, it could shift to a parallel reality where the Germans won the war.

That's why the government doesn't dare kill either of you?

Right. Because of what we were involved in, it might jeopardize our entire reality system.

Could you explain how a closed time loop works?



## M A T R I X I I I

Well, one of the problems that has developed is that when you travel through time you cannot come back to the exact point of origin. It has to be later than when you left. If you were to come back to the exact point at which you took off you would be at the same point twice in your lifetime and there would be a very serious problem.

Would you refresh my memory about some of the dates involved with the development of electronic mind control in the US?

The mind control experiments were moved to Montauk about 1969. The hardware phase of some of the later experiments began about 1975; equipment to modify the SAGE transmitter was ordered about 1973.

ITT was the main contractor and sub-contracted portions of the contract out. Most of the contracts were awarded to firms on Long Island.

So what did they actually prove that they could do when the experiments were over?

What they essentially proved they could do was that they could control a person that they had the "signature" for. This pattern that was unique to an individual could be put into the computer program for the transmitter. A second order wavelength would be transmitted that has a lower attenuation and affects that persons mind directly. There could be a command to do anything focused at the person. Once a device was constructed that illustrated this principle on a wide scale. A mental message was put out that if anybody heard the message they were to call a certain phone number. Over 600 calls came from all over the East coast all the way down to Florida. It works.

That's interesting. There's a fellow who calls himself Lord Mattreya who says that he is the Christ returned to the planet; that when he links up with the international press he will send a telepathic message to the entire planet in their own language and they will hear it. They also are supposed to receive a visual image. So..they have that technology?

Yes. There is not only an individual signature. There's a racial signature and also a universal signal for the human race. The government has used all three to target specific individuals. They have also done group messages targeted on a specific racial or ethnic group. That's common. In Boston and New York they were doing experiments on "mood control" on the cities. Transmitters used no longer exist, but the technology does.

## M A T R I X I I I

Do targeted individuals perceive what they are receiving as their own thought?

Yes.

Is there any defense against that?

Yes and no. Theoretically no. This is what the government depends on. Practically speaking, they can't get everyone, because some people are naturally resistant, depending on their level of mental and psychic development. Perhaps 5% of the population do not respond to these signals. If they get 95% coverage, they don't care about that 5%. That's what they have the riot squads and the concentration camps for. There is no defense unless you can interfere with that signal. Some people just don't react.

So they transmit a thought signal?

Not exactly. If you were put on an EEG, you would exhibit a certain pattern of electrical responses. These can be recorded and they are unique to you. It can be recorded and stored and replicated on a computer. If they can replicate your RNA/DNA pattern they've got you too - for life.

You mentioned about concentration camps?

Yes. They are all over the United States. There are three in Arizona alone.

So they can control us to the point where we'll just hand over our guns?

That's what they hope. It depends on how effective this equipment becomes, how thoroughly installed it is everywhere, and whether or not people can ferret this stuff out and render it inoperative before that time arrives.

How about the idea of a conflict between moral conscience and what the mental command tells you do to?

You don't have the option not to act as it says the way that equipment is set up - if you are not aware enough to make a connection that it is not your thought. It does not negate choice, it just puts in a strong impulse or command. Those people who responded by calling that number had no idea what went through their heads. Some of this does require preconditioning to a response pattern.

Could they be doing this over the media, like television and radio?

M A T R I X I I I

Of course.

You're suggesting a state of absolute corruption.

Absolutely correct. Planned corruption.

With this kind of technology, why do they need concentration camps?

Because there are always people that are resistant.

I would think that they would annihilate them, not lock them up. The first step is the camps, where you can handle them easier, then you can eliminate them en masse. You don't go down the streets shooting everybody down. Once you're in the camps, they break you down mentally. They're experts at that.

We think they're shipping guillotines in there for the people that don't comply. They're looking for a slave labor force. That is what H.R. 4079 is about that's in Congress now. It creates a slave labor force in the prison system, which will be privately owned. States will pay the private prison a fee in order to put their prisoner in there.

Yes.

What are some of the other projects that relate to the capacity of factions operating within the United States Government and corporations to manipulate and control the population?

Well, between 1977 and 1978 a project called Dreamscan came on line. It ceased in 1979. The goal of the project was to gain the technical ability to enter into an individual's mind in the dream state and cause his death. There was a movie called Dreamscape which showed what they discovered they could do. The project was run by the Secret Government and managed by the NSA. The purpose of the project was to provide for a means of covert assassination. President Carter found out about it and had it stopped. The hardware is still intact and in storage. There have been attempts to put it back on line by various intelligence operations, some of which are said to involve AT & T operatives.

What else?

Around 1987, a project called Moonscan started. It lasted into 1989 and involved positioning mind control equipment on the moon for use on the population of earth. It, like the others, has clear connections to negative alien activity.

Who ran that one?

## M A T R I X I I I

It was managed by an organization called Airborne Instrument Laboratories (AIL), who have had other covert projects under their wing. At the time, AIL was run by Eaton Corporation. It is now managed by the Department of Defense as of 1988. There are three branches of AIL: Covert, Commercial, and Defense.

Any other mind control programs that you can mention?

There was a project called Mindwrecker that would allow paralysis of the mind. The aliens were heavily involved with that project. It produced several neurological weapons, some of which are used on the B-1 bombe, which also contains a lot of alien technology. At time, various alien species came and went out of AIL. There was one group called the K-Group, which was short for the Kondrashkin. They had pale skin that had a slight greenish tint and almost no hair. They looked human, and had to bleach their skin and wear wigs. They have been periodically involved with covert projects since the 1940's.

Where has AIL been located?

In New York Stare, at Farmingdale, Deer Park and Long Island.

What is the current status of AIL?

Well, there were eight projects ongoing at AIL that also had to do with the development of weaponry against aliens. In 1989 the Orion group discovered this and destroyed the projects. It can only be assumed that AIL still functions in other areas.

What other research goes on at Long Island?

Research on scalar weaponry, like the one that destroyed the Challenger.

I thought the Challenger was destroyed by the Soviets using scalar weapons?

No. The Soviets didn't do that. The oddity with the incidents as far as the Soviets were concerned was that they pulled their ships about 150 miles out to sea before it happened. They were not the direct cause, which was a scalar weapon that they were trying to put into orbit and test. It accumulated a charge while the Challenger was going up through the atmosphere and turned itself on. That is what destroyed the Challenger. It might have been deliberate.

What was the ultimate power behind the Phoenix projects

## M A T R I X I I I

and the mind control?

Ultimately, the whole thing is manipulated by the Orion group. The expectation was that they could use mind control to take over the populace in the 1990's - no later than 1994 or 1995. They have also been doing genetic work in which they alter a human sperm and ovum to the extent that all offspring will produce hybrids with new characteristics. Humans will mate and create children with alien genetics. That's one step beyond the average abduction scenario. There are other things happening with the human race.

Like what?

Since 1947, there have been components of the 6th race incarnating on the planet. The 5th race was the Aryans. The 6th race humans are 100% telepathic - the secret government and the Orion group sees them as a threat. They've been aware of it since 1942.

Wasn't there a movie about something like that years ago?

Yes. I don't remember the name, but it came out in 1982. In that film, there was a drug that made babies that were 100% telepathic. This kind of thing has actually happened. There was a Canadian company that was producing a drug which turned out to do just that. This was between 1946 and 1947. It was removed from the market immediately, although its use continues privately. In the movie, the government had a way of using electromagnetics to explode a persons head to get rid of them.

Sounds like something they might have developed at Montauk.

It does, doesn't it?

What is the current situation with aliens?

Somewhat mixed and confused. There has been a lot going on all around the planet. In September and October 1990 there was an alien group from some other dimension that was attempting to invade the planet. They took down all the zero-time generators all over the country. The FAA was especially affected. The rogue group was stopped by another species. For many years, some factions of the Orion group depended on a ring of alien satellites that would sustain life functions. Those were wiped out in November 1990 by the same group.

So there are positive light forces out there that are seeking to balance these negative activities by the Orion group?

M A T R I X I I I

Yes. I am not at liberty to tell you their identity.

Do you think that this group is related to those who flew over military nuclear silos and rendered the warheads inoperative?

I don't know if they were involved, although I could ask. The nuclear charade is another thing on a cultural level. The idea of nuclear war was eliminated a long long time ago by all major powers on Earth. The threat of a nuclear winter and the fact that you can't detonate two nuclear devices too close together in time stops them from doing it. I think a lot of people are aware that the same forces that control the United States today are the same forces that supported the buildup of Nazi Germany and the Soviet Union and arranged for WWII and Vietnam. The public has been lied to in so many areas since the early 1930's that they don't know what's going on. Most people still think that the Congress and the President run the country and that they have Constitutional rights.

How about some interesting technology spin-offs from the Philadelphia experiment?

Well, there are a lot of them in use by the CIA and the NSA, as well as other corporate and government agencies. There is a portable unit that can render an individual invisible. The NSA is known to use those on a fairly regular basis. There is also a UFO research based covert organization that is believed to have them?

And what would that be?

Well, its a super secret international organization that is funded by all major governments. It performs research on aliens and alien technology, coverup operations, and also does espionage. The group is negatively oriented and is considered to have no positive attributes in relation to other humans. It's called the International Aerospace Alliance.

How does it fit into the hierarchy of command and control?

It's connected to MJ-12, which is believed to be headed by Kissinger at this time. It is also connected to the Joint Chiefs of Staff and the President. AIL type units are also connected to the MJ group.

I have heard a tape of Robert Lazar, the EG & G scientist, and others who indicate that the highest clearance level is ULTRA. Is that it?

There is also BLACK LEVEL clearance.

M A T R I X I I I

*The Spherical Biological Monitoring  
and Control Device ( SBMCD )*

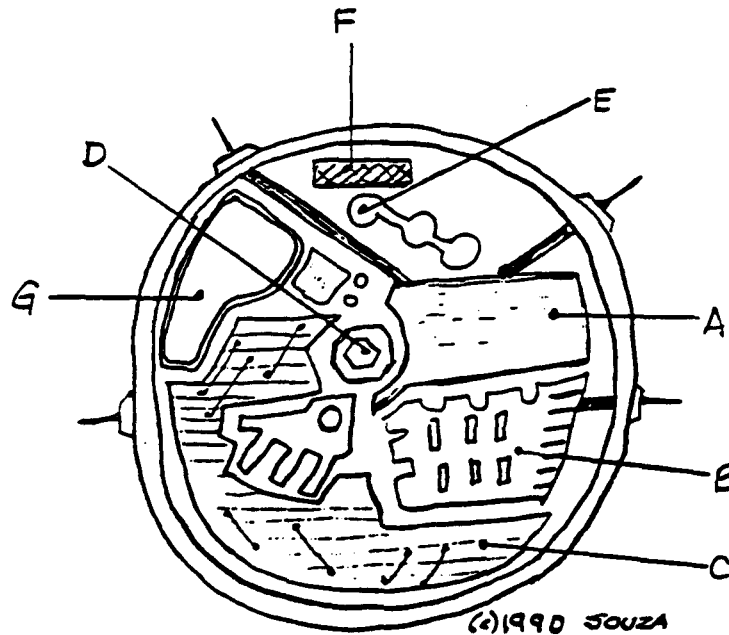

- A - Self-Destruction device; will destroy the SBMCD if access is attempted without frequencies to open 3mm module.
- B - Neural Stimulator. Delivers a phased voltage beam directly into the nerve endings in the brain; cortex-phased transducers on either side of the main lobe oscillate several microvolts of direct current stimulation to the brain.
- C - Auxilliary data storage unit maintains over 10,000 micro silicon wafers, each integrated by direct lead to the micro-positronic simulated brain center, providing instant access to information on call.
- D - Central Power Nucleus. Energy for the unit is generated by the decay of a small amount of Strontium 90, and particles are distributed to the entire unit through a unique direct flow of charged electrons in a fluid nutrient base of a consistency similar to hemoglobin.
- E - Internal/External sensor capable of detecting low photon levels of light energy ranging from UV to IR.
- F - Multiband micro transceiver.
- G - Auditory sensors.

## M A T R I X I I I

What is involved with those little implants that are spheres?

Those devices are about 3mm in size. They are called SBMCD's, or Spherical Biological Monitoring and Control Devices. They represent an organically enhanced synaptid processor powered by a micro-positron flow that controls or mimics the functions within the human nervous system with micro relays that duplicate brain operation or engram patterns.

What is the real story behind Wilhelm Reich?

Most people are familiar with Reichs brilliant work with bions, weather modification, cancer biopathy and other devices. Reichs work has been of interest to the National Security Agency for some time, and it involves the fact that when a person is electronically maintained in a pre-orgastic state in their nervous system, gateways unto the mind open up for mind control to take hold. It is his most secret work as far as applications are involved. Reichs contact with alien species, his discoveries about life energy and cancer, and the mind control applications are some of the reasons why he was killed. This knowledge was combined with other knowledge, some of it alien in nature, and integrated into the work at Montauk and subsequent covert projects to subvert the people of the United States and the world under an Orion based system.

What are some of the ways they put people into this state?

Well, there are these devices. Every psychiatric facility has them. For a male, they attach electrodes to five points on the body (you can guess what one of those points are) and turn the device on. It makes programming an individual really easy. It is devious, but a lot more humane than the old electro-shock therapy. The thing is, the device is being used for control instead of in a way that might benefit the individual.

What about the Philadelphia Experiment as related to aliens?

The Philadelphia Experiment was not an alien operation, as such, but what was the set-up was the date, August 12, 1943, because it had to be locked to the Phoenix project on August 12, 1983. The date was set by alien influence in order to cause a 40-year hole in hyperspace through which large numbers of alien craft could enter this dimension. It worked, but it didn't last long enough to give the aliens the maximum benefit of the scenario. The order for the date came from a man in the



## M A T R I X I I I

on another, a small flare of energy leaves his aura as a solar flare leaves the sun and travels at the speed of light to the person of his thoughts. The recipient then thinks of the sender without realizing that the thought was implanted in his mind. It is commonly known as telepathic communication or extrasensory perception (ESP). Everyone possesses the talent but, like other human attributes, the extent of one's ability varies from individual to individual. It seems strongest between family members or loved ones but, like physical skills, the power of telepathy can be exercised or cultivated to the limits of one's aptitude. The SS conducted many experiments in telepathic communications intended to transmit messages to people as they slept. If the dream message was strong enough, the recipient might subconsciously believe it to be his own thoughts and, once awakened, act accordingly. It is not known how far such experiments progressed in Nazi Germany but it is known how far the science has progressed since World War II.

Following the war, a new technique, called Kirlian photography, captured the aura on film and, for the first time, scientifically proved its existence. Using the technique, an entire human body was photographed and, in the subsequent study of the picture, an amazing discovery was made. The aura emitted from the body at certain focal points that exactly coincided with ancient Chinese acupuncture charts. Despite present day claims that the effectiveness of acupuncture treatments is not understood, this discovery proved what holistic experts had predicted. Disease is often caused by a blockage of the life-giving force of the aura and acupuncture needles merely unblock energy paths to permit the aura to flow unrestricted to the affected area. It is the aura and not the needle that cures the acupuncture patient. With this new insight into an ancient science, German researchers experimented with one particular acupuncture treatment that for over 5,000 years was believed to enhance one's psychic powers. Finally, they had arrived at a simple, universally effective method to turn average people into masters of telepathic communication by unblocking the focal points of their auras associated with ESP.

In the 1950's, several experiments were conducted with a telepathic sender and a receiver located a thousand miles apart. The only aspect new to the experiments was the inclusion of highly sensitive monitoring devices that recorded the minute energy flares on an electronic gauge as it left the sender and

## M A T R I X I I I

arrived at the receiver. The experiment only confirmed previous findings but one unheralded genius came up with a brilliant idea. The experiment was repeated but, instead of having the sender concentrate on a human receiver, he attempted to send his telepathic message directly to the monitoring equipment. The scientists were amazed when, at the appointed time, a thousand miles from the sender, the needle on the monitoring equipment moved. The machine could not understand the message, only that a message had been received, so the experiment was repeated but this time, instead of sending a speech or thought pattern, the sender projected a series of energy pulses in Morse code. The gauge registered the dots and dashes of the message and easily translated them into the written word. It was a monumental discovery; the first mind/machine link. By 1965, this unpublished science had so advanced as to be applied as the communication system for an ultra-secret intelligence group in the United States. One of the world's largest computers (the same Hewlett-Packard model as used by the General Services Administration to run the Federal government) was set-up and programmed to receive the telepathically communicated reports of thousands of intelligence agents in the field. It is the quickest, most efficient, untappable communication system in the world today; linking the life experiences of thousands of covert operatives directly into the computer data banks that, at a moment's notice, can regurgitate the sum total of their knowledge on anything or anyone so requested. The organization exists today with headquarters in California's Silicon Valley and branches throughout the world that operate in conjunction with acupuncture clinics as conditioning centers for the operatives. It was one of the best kept secrets.

The science of telepathic communication has not escaped the interest of the Central Intelligence Agency, which recently funded several studies in parapsychology in a joint venture with the National Security Agency in an effort to establish a super-secret national defense system utilizing the "energy influences" of thousands of operatives to jam the directional guidance systems of incoming enemy missiles. It is a plausible defense. Likewise, CIA reports indicate that as early as 1972, the characteristically austere Soviet Union had allocated an annual budget of over \$20 million for their research in this field.

Regardless of whether the reader views this account as futuristic fiction or the secret of life, to Heinrich Himmler the science was very serious business.

## M A T R I X I I I

He firmly believed that he had discovered a primeval truth previously mastered only by such historic figures as Jesus Christ. Christ never claimed to be God, not even to save his own life. Had he done so, Pontius Pilate would have dismissed him as insane and exempted him from execution. Christ professed to be the "Son of God" but within the limited scope of our understanding we have failed to see that we are all "sons of God" and the only difference between Christ and the rest of humanity is that he had mastered the essence of his nature. He knew who he was, from where he came, why he was here and what awaited him after death, whereas most people have absolutely no concrete answers, only mythological hearsay to explain these very basic mysteries of life. Himmler viewed Christ's powers to cure the sick as no more than the ability to impart his extremely strong aura to upgrade the low energy levels of the afflicted. Likewise, his miraculous power to raise the dead was no more than the ability to cure the ailment that had expelled the spirit, then travel through the astral world to retrieve the spirit and guide it back into the body. To Himmler, the "resurrection" was just the physical embodiment of the astral body. Himmler's assessment of the powers of Jesus Christ may well be correct. Several studies have gone so far as to accuse the Vatican of suppressing psychic research out of fear that science might provide a logical explanation for what they would prefer their following to think of as miracles.

Like their spiritual experiments, the Nazis' medical experiments have been grossly underrated. SS scientists, like the notorious doctor-killer, Fritz Fischer, had the free, unrestricted use of human guinea pigs, not just lab animals that only approximated human response. Tremendous strides were made in the areas of genetic engineering and sterilization but the only accomplishment reported was their development of the technique of male sterilization commonly known as a vasectomy operation. Himmler, who had made it illegal for non-Aryans to reproduce, wanted to make it impossible, hence the concentration on techniques of sterilization. Professor Carl Clauberg, director of sterilization at Auschwitz devised an ingenious way to sterilize the sub-humans en masse. Twenty-four specially built counters were installed throughout Germany and Poland. As each of the several thousand daily registrants approached the counter they were unknowingly subjected to an overdose of X-rays. Such experiments encompassed only the half of Himmler's plan

## M A T R I X I I I

concerned with eliminating the sub-humans but there was an equal number of experiments dealing with the procreation of the master race that are rarely reported and almost always misunderstood.

There has been speculation that the Nazis attempted to create the perfect Aryan specimen, artificially in the laboratory using techniques similar in concept to those described in Aldous Huxley's 1932 fictional work, Brave New World, and more recently in Ira Levin's Boys from Brazil. Huxley's work certainly did not escape Himmler's attention as he included his name on the "Special Search List" of those Englishmen slated for kidnapping by the SS. Though they did probably engage in such research, there is no indication that the SS succeeded in synthesizing life in the laboratory as they continued to stock Germany and Austria with naturally-born Aryan children they acquired through the Lebensborn (Fountain of Life) Program.

## M A T R I X I I I

SS officers, who could prove an ancestry untainted by sub-human blood back to the year 1750, were ordered to stud for the Lebensborn Program. They married only women with the "correct racial features;" fair-skinned, blue-eyed, blonde, wide hipped and full breasted. In SS wedding ceremonies they exchanged the following vows, "We stand, we starve, we do our bitter duty." Four sons were expected if the officer's career was to advance. When the program failed to produce the goal of one million male super-babies, polygamy was legalized for the SS. But, even with polygamy, each of the SS officer's wives could be expected to produce only one man-child every two years, in practice it was more like one every three or four years. Himmler realized that time was limited for both the Nazis and Lebensborn Program and that if he was to succeed in reaching his targetted goal of super-babies within the allotted time frame, he would require every Aryan woman in Germany to be pregnant by the SS. He formed The League of German Girls to catalog the racial backgrounds of unwed women and encourage them to have as many illegitimate Aryan children as possible. Himmler launched a major propaganda campaign called, "Mutter und Kind" (Mother and Child) in which posters and newsreels heralded the Aryan madonna as the heroine of Germany for having extended her love for the Fuhrer to his SS and bearing a son with the "correct racial features." The heart of the Lebensborn Program was the network of maternity wards that the SS established throughout Germany to care for the every need of the expectant mothers and their children. While the majority of Germans suffered from shortages of fresh meat and vegetables during the war years, the Lebensborn children received the best of everything. The program had been given top priority; Himmler's super-babies were considered more important than the German Army.

When the Lebensborn Program continued to fall short of Himmler's expectations, he ordered the SS to kidnap Aryan infants from the countries they occupied in Europe and transport them to Lebensborn wards in Germany. Kidnapping foreign-born Aryan children was only logical when one remembers that the Nazis were fighting people and not countries. In 1939, the Waffen SS followed the German Army into Poland to catalog the populace. Also in 1939, Himmler founded the Ahenerbe; an SS society dedicated to the study of "the sphere, spirit, deed and heritage of the Nordic Indo-Germanic race." Under the direction of Dr. Bruno Begor, the

## M A T R I X I I I

Ahenerbe gassed several hundred Polish Jews just to study the racial differences between Aryans and Jews. Otto Ohlendorf was in charge of the mobile killing units that gassed thousands while in transit to mass graves. Many Poles were sent to labor camps like Auschwitz where they worked as slaves for German companies like I.G. Farben -- at least for about three months until they succumbed to the meager diet of turnip soup. Though many Poles were executed in the concentration camps, over 200,000 Polish Aryan children were kidnapped and sent to Lebensborn wards where they were given German names and raised as pampered Nazis. Himmler gave the order,

I consider it a good idea that small children of Polish families who are especially desirable from a racial point of view be collected and educated by us in special institutions. The children should be removed under the pretext of their health being endangered.

H.H.

Reichsfuhrer SS

The kidnapped children as well as the legitimate and illegitimate children of SS officers were taken from their natural parents and raised in Lebensborn institutions before being sent out into the world for adoption by German families. Obviously, the Lebensborn children must have been indoctrinated in the Nazi philosophy but there has been some speculation that Himmler had developed a means to hypnotize or brainwash them to program their future work in the "Thousand Year Reich." Though such a process has been described only in fiction like Huxley's novel, Himmler must have at least tried to maintain control because not doing so would have been as foolish as allowing the uncontrolled procreation of chickens to the point where they overran the farmhouse. Himmler must have had some technique that justified his taking financial responsibility for groups of children like the 200,000 Poles, while the German economy suffered under the burden of war. These were, after all, Himmler's children, prior to their conception, most were only a twinkle in his eye. He even devised a system to name every last one of them.

## M A T R I X I I I

Rather than being baptized, Lebensborn children were initiated into the master race in an SS name-giving ceremony. The SS and not the natural parents named the child. Himmler wanted them to have a common identity and there was no better way of doing so than to give them a common name but, aside from being terribly confusing in the ranks, this would have destroyed any anonymity they might require to carry out their work. Himmler resolved his dilemma with an ingenious system that named each child differently, yet the same.

There is some indication that the Nazis did not initiate the Lebensborn Program, only develop it from one started earlier by some unknown entity, but regardless of when it began, the program graduated between one and two million super-babies under Himmler's control, which poses some interesting questions. Where are these people today? Are they still a group? And, if so, has their influence been felt in the world? Perhaps this work will help to answer such questions.

Plain-clothed SS agents, stationed in movie theaters throughout Germany, monitored audience reaction to Propaganda Minister Joseph Goebbels' newsreels and documentaries. He so advanced the art of political propaganda that the United States, even with all the talent of Hollywood, could not produce an effective counter-campaign. The propaganda unit of the U.S. army chose instead to concede to the Nazis' superior movie-making ability and used Germany's own film footage to frighten the American people with the strength and determination of their enemy. The propaganda war, or the "reel war" as it has been called, is a simple example of how the United States was developing a pattern of following the Nazis' lead. Actually, the only effective anti-Nazi propaganda the U.S. authored was produced, not during, but after World War II when Hollywood almost universally portrayed the Nazis as stupid, bumbling idiots who were easily deceived and always defeated. If the intention was to convince the American public that the Nazis posed no threat to the security of the United States in the post-war years, Hollywood could not have done a better job.

Hitler's strategy to win World War II was surprisingly simple. He was fighting on two major fronts: the Russians to the east and the Americans and British to the west. So very early in the conflict Hitler initiated a plan to infiltrate and misinform his enemies in an effort to create friction, especially

## M A T R I X I I I

between the United States and Russia. The present day cold war was born out of this plan of Hitler's to divide and conquer. Officers of the SS, posing as the German underground, contacted the Americans through Allen Dulles who then headed the Office of Strategic Services (OSS) in Switzerland. The rather elaborate masquerade was intended to convince Dulles that Russia and not Germany was the true enemy of the United States. Likewise, Hitler's top aide, Rudolf Hess staged a spectacular defection to the west to persuade England and America to join forces with Nazi Germany against the Russians. With all the false rhetoric and rumor, it was no surprise that hostility prevailed at the meeting of the Russian and American armies when they converged outside Berlin. The mistrust and misunderstanding increased when Hitler's vast stockpile of gold could not be found. Tons of gold: the German treasury, the treasuries of the countries they had conquered, the confiscated gold of the Holocaust victims, even the jewelry of Helen of Troy was missing from the Berlin museum. The Russians accused General Patton of hoarding the fortune and refusing to share in the spoils of war. Patton accused the Russians of the same but was to die in a suspicious auto accident during his subsequent quest to find the gold and discredit Russian claims. The gold has never been found, giving rise to the theory that it was hidden by the SS and spent covertly to support the fraternity's work after the war.

One of the key figures in the SS's master plan to control the United States was a member of the Great German General Staff, Reinhard Gehlen. General Gehlen, a staunch anti-communist, was one of Hitler's architects of the eastern front invasion and the foremost Nazi intelligence expert on Russia. It has been said that his files on Russia were more extensive than even those kept by the Russians themselves, epitomizing Field Marshall Rommel's quotation, "The first rule of war is to know everything there is to know about your enemy." In April of 1945, four days before Hitler reportedly committed suicide in his Berlin bunker, General Gehlen and a small staff defected with the Russian files to the Bavarian Alps where, at a place called Misery Meadows, they buried the catalogues in fifty metal boxes. Though Gehlen could have easily escaped, he made no attempt to do so. He waited in Misery Meadows for nine days and then traveled down the mountains to surrender. By this time the Americans had come to believe the Nazi propaganda about Russia and were only too happy to welcome Gehlen,



## M A T R I X I I I

his expertise, his files and his network of planted spies in Eastern Europe. Four months later, in August, Gehlen was smuggled into Washington, D.C. disguised as a four star U.S. Army General, befitting his rank in the German Army. He was well-received, being quartered at Fort Hunt, where a butler and several white-coated servants were provided for his comfort.

For the next few weeks, Gehlen met with President Truman and General William "Wild Bill" Donovan, the head of the OSS. Ever since President Roosevelt had sent him on a fact-finding tour of Europe just before the war, Donovan had advocated the establishment of a central intelligence group. Donovan was a New York attorney when Roosevelt first sought his services. World War II had elevated him to the rank of General in charge of our somewhat primitive intelligence gathering Office of Strategic Services. It took about a month for Donovan and Gehlen to convince the president to reorganize U.S. intelligence. On September 20, 1945, Truman disbanded the OSS and for four months the United States relied only on military intelligence to formulate foreign policy. On January 22, 1946, Truman established the Central Intelligence Group, under an authority headed by Rear Admiral Sidney W. Souers. The Central Intelligence Agency (CIA) as we know it today was born of this group on September 18, 1947, under the direction of Rear Admiral Roscoe H. Hillenkoetter who had set up the wartime intelligence network in the Pacific for Admiral Chester Nimitz along with Rear Admiral Edwin T. Layton. The CIA, designed to a large extent by Reinhard Gehlen, was staffed with former OSS, FBI, SS and SD agents. Yes, half were Americans, half were German Nazis.

With the full support of the U.S. government, the man, who now called himself "Dr. Gehlen," returned to Germany to establish the West German Federal Intelligence Agency or "Gehlen's Organization" as the CIA called its European spy ring. Initially, the CIA gave Gehlen an annual budget of \$600,000 but that was soon increased to \$20 million. The CIA spent \$3 million just to remodel a former SS housing development for Gehlen's headquarters. Over one thousand agents and their families lived totally within the walled compound that was once the headquarters of Martin Bormann and Rudolf Hess. Gehlen established sixty spy schools that graduated over 7,000 new agents to join the veteran Nazis in the field. It was Gehlen's idea to start Radio Free Europe; a propagandistic news station located only a few miles from his headquarters.

## M A T R I X I I I

Always pleased with Gehlen's work, the agency showed their appreciation by giving him a \$1/4 million lakeside village in Starnburg, Bavaria to which he retired in 1967 after a series of scandals involving former SS officers in his employ (hence the employ of the CIA) forced his abdication amid a rash of "suicides" among his critics. This former Nazi General, who has been called the "co-founder of the CIA," exerted considerable influence in formulating U.S. foreign policy when one considers that three-fourths of all U.S. intelligence on Russia originates in "Gehlen's Organization."

Many Americans, especially those who lived through World War II, may find it difficult to accept the fact that the U.S. government would be so foolish as to hire Nazis to organize and staff such a critically important federal agency as the CIA but that is exactly what happened. If Washington was taken in by the Nazis, it occurred not after, but during the war when they began to accept Germany's claims that the Russian communists were the real threat. Following the war, fear of the Russians was all that was needed to prompt Truman to accept Gehlen's well-placed spies who provided a convenient solution to concerns that, whether legitimate or not, had been brought to Washington's attention by the Nazis.

The SS was so far superior to the Americans in their espionage techniques that their inclusion in U.S. intelligence required a complete revamping of the system. So many former SS and SD agents were hired by the CIA that they formed the basic personality of the agency. They all swore allegiance to the United States just as they had all sworn allegiance to Adolf Hitler years earlier. If one is still skeptical as to the extent to which the Nazis infiltrated the CIA, the evidence is easy to confirm. Instead of trying to pierce the security of the CIA and look for agents who are former Nazis, simply review the stories of Nazi war criminals and suspects recently discovered living in America; most, if not all, have a history of working for the CIA. A good example is the 1983 arrest of Klaus Barbie, a notorious SS officer known as "The Butcher of Lyons" for his war crimes against the people of that French city. Following the war, Barbie was hired by the CIA and hidden from the French who had targetted him for prosecution. Barbie worked as a CIA informant in Bolivia where, according to reports, he organized a mercenary force to protect Bolivia's cocaine trade, cocaine that eventually ended up on the streets of the United States. French Nazi-hunters

## M A T R I X I I I

finally located him and he was extradicted to stand trial. Though it was nearly forty years too late, the United States apologized to France for having protected Barbie, being one of the few times that the U.S. officially acknowledged that their hiring of Nazis was wrong.

Another Nazi who worked for the CIA and one whose history is more pertinent to this story is Otto Albrecht Alfred von Bolschwing. According to a 1981 newspaper article,

The war over, von Bolschwing made a move crucial to his future success; He became an American spy. "He knocked on the door of the U.S. Army Intelligence," a source explained, "and said, 'I'm experienced, I have a ring operating. If you give me a paycheck, I'll make you very happy.' He was sort of a miniature Reinhard Gehlen."<sup>1</sup>

In March of 1969, von Bolschwing was hired as a consultant by TCI, a high-tech investment firm in Sacramento that planned to capitalize on the latest military technology developed in California's Silicon Valley. TCI was engaged in classified work for the Department of Defense and according to the company's founder, "Ours was going to be a sensitive thing. We all had to have security clearances."<sup>2</sup> A TCI memo written in 1969 reported that its new consultant, "has extremely valuable connections and information in Germany, Switzerland, Liechtenstein, the Netherlands, Antilles and South America. Mr. von Bolschwing's connections in these countries are current."<sup>3</sup> In his first year with TCI, von Bolschwing was appointed president of the firm by its board of directors, one of whom was the oil billionaire, John Paul Getty, Jr. From 1939 until 1942, the FBI had been investigating Getty's father because of his close personal relationship with Adolf Hitler and his illegal practice of selling oil to the Nazis via Mexico. According to the newspaper article that exposed von Bolschwing as a Nazi,

## M A T R I X I I I

Records and interviews with TCI officials indicate that Helene von Damm, President Reagan's Austrian-born deputy assistant, translated contracts for TCI and invested \$1,000 in it while she was then - Gov. Reagan's secretary in Sacramento. Von Damm was "too busy" to talk about von Bolschwing, but through her White House secretary said she knew him "socially" in Sacramento "many years ago."<sup>4</sup>

Soon after von Bolschwing assumed control of TCI, several of the company's major stockholders began syndicating their stock and selling it to small investors in the Sacramento area. The trading was eventually found to be illegal and several stockholders (but not von Bolschwing) were prosecuted by the Sacramento District Attorney's Office who referred to the case as "possibly the biggest stock fraud in California history."

Gehlen, Barbie and von Bolschwing are presented here as three prime examples of the thousands of Nazis who infiltrated the CIA and whose post-war activities continued to have detrimental effect on the American people. Von Bolschwing is of particular interest as his business dealings in California blazed a trail that lead directly to Jonestown.

One of TCI's two Silicon Valley subsidiaries, a Sunnyvale Corporation called International Imaging Systems (formerly Stanford Technology) purchased Intercontinental Technology, a Washington D.C. based marketing firm to represent them in the sale of sophisticated electronic surveillance equipment to African and Middle Eastern governments. This was not a new endeavor for International Imaging Systems that, under its former name, had supplied the CIA-backed Shah of Iran. The founder and president of the Intercontinental Technology was none other than the notorious CIA arms dealer, Frank Terpil. The New York Times reported that Terpil and his partner, Edmond Wilson,

used Intercontinental Technology's Geneva office for payment of former Army Special Forces troops, or Green Berets, he had recruited to train terrorists in Libya, according to several participants in the operation.<sup>5</sup>

## M A T R I X I I I

The purchase of Terpil's company by von Bolschwing's subsidiary is hard evidence of at least a connection between the two men that went beyond their mutual affiliation with the CIA. It also attests to the widely-held belief that the agency operates front companies in the U.S. despite the fact that such activities were a direct violation of their charter. The connection is important, for Terpil later admitted to a BBC interviewer that, during this period of time, he supplied mercenaries and arms to the early stages of Jonestown, when the jungle camp was used as a CIA training center. Von Bolschwing provides the first glimpse into a Nazi/CIA/Jonestown connection: a living bridge between the Crystal Night and the White Night.

The Central Intelligence Agency is not responsible for the Jonestown atrocity, but they are accountable for it. Any government agency or, for that matter, any government, is a concept and only as good or as bad as the people it employs. This is particularly true of the CIA, which lacks the chain of command that typically structures most organizations. The CIA is compartmental which enables each department to function independently. Certainly not everyone employed by the agency knows that the CIA sponsored the Jonestown experiment, perhaps not even the agency's director is aware that Jim Jones was an operative. Not even the agency personnel working in Jonestown knew the full scope of the experiment that was conducted by what the CIA will eventually term a renegade faction.

Following World War II, the CIA began its operation from several office buildings scattered throughout the Washington, D.C. area. Though contrary to the agency's name, this decentralized structure was necessary to compartmentalize the various activities of the U.S. and former Nazi German agents. Eventually, Congress granted 46 of the 60 million dollars the agency requested to construct a headquarters building on a isolated government reserve across the Potomac River from Washington, D.C. In its initial presentation to the House Appropriations Committee, the agency reported,

The new building will consist of block-type wings, readily compartmented from one another, so that specially restricted areas can be established and special controls maintained in each section.

## M A T R I X I I I

The Langley, Virginia headquarters houses untold numbers of self-contained departments that operate independently behind unmarked doors. Through one of those doors passed the truth about Jonestown.

While presidents come and go (from Washington to Reagan, they average only five years in office) the true power of the executive branch of government is carried from administration to administration by the different departments of the CIA. The best assessment of the threat the CIA presently poses to the American people comes from the president who helped establish the agency. In 1963, Harry Truman wrote in a syndicated newspaper article,

For some time I have been disturbed by the way the CIA has been diverted from its original assignment. It has become an operational and at times a policy-making arm of the government...I never had any thought that when I set up the CIA that it would be injected into peacetime cloak-and-dagger operations. Some of the complications and embarrassment that I think we have experienced are in part attributable to the fact that this quiet intelligence arm of the President has been so removed from its intended role that it is interpreted as a symbol of sinister and mysterious foreign intrigue.

Even as early as 1963, Truman and many others recognized that the executive branch of government was no longer in control of the agency but no one questioned who was in control. Everyone assumed that the CIA had gone its separate way under its own power. No one could see that the Nazis who helped establish the agency had used the need to know security system to continue the Third Reich in the United States under the impenetrable cloak of national security.

The Nazis hiding in the CIA were relatively quiet for the first few years after World War II that it required to convince the American public that their true enemy was not fascism but communism. The success

## M A T R I X I I I

of the McCarthy Era propaganda campaign in the early 1950's marked a distinct change in U.S. intelligence. No longer satisfied with merely gathering information about world events, as was their chartered function, the CIA began to create events that shaped history.

With the formation of the National Security Agency in 1952, the CIA was relieved of most of the responsibility for gathering intelligence but even though it had outlived its original function, the agency continued to grow in personnel and budget. They were left with little more to do than play "what if" games; speculative contingency planning like, "Is there a pharmaceutical solution to the growing unrest among Blacks and Native Americans?" The experiment in Jonestown was conceived from just such speculation.

Jim Jones worked for the CIA but that does not exclude the distinct possibility that he only worked through the agency for his true employer, the Nazis. As a youngster he studied the Nazis, later he would employ Nazis in his Peoples Temple that was structured along fascist lines. When the FBI searched Jones' San Francisco office after the massacre they found that half the books in his personal library were about behavior modification and the other half were about Nazi Germany. The odyssey that ended in Jonestown, began some fifteen years earlier in Brazil when Jones received his life assignment, presumably but not necessarily, from his CIA employer. At precisely the same time that Jones moved to the Belo Horizonte suburb of San Antonio, Brazil, Josef Mengele, the infamous "Angel of Death" purchased a farm just south of him.

Josef Mengele was born to the wealthiest family in Gunzburg, Bavaria. He was raised a strict Roman Catholic, studied anthropology and eventually went to work for the Kaiser Wilhelm Institute. When Hitler declared that only anthropologists were qualified to separate Aryans from sub-humans, Mengele was appointed head of the genetic experiments at Auschwitz. In the death camp, Mengele preferred to experiment on young twins. He would use some new weapons or drug the SS was developing to kill one of the twins and then kill the other by some conventional means. Autopsies were then performed on both corpses for comparison. He also attempted to unlock the genetic secret that produces twins in an effort to double the output of the Lebensborn Program. Mengele was personally responsible for the death of 400,000 inmates at Auschwitz; four times the number killed by the combined nuclear explosions at Hiroshima and Nagasaki. Josef Mengele murdered more people than anyone else in history.

## M A T R I X I I I

After the war, Mengele was interred by the occupying Americans who transported him back to his native Bavaria where they released him under his own name. They knew who he was and let him go free. With characteristical Nazi arrogance, Mengele expected to continue his genetic experiments after the war but, despite obvious support from the Americans, he was not safe in Europe. In 1948, he traveled down the Rat Run to Genoa, Italy where, with the help of the Red Cross and the Vatican, he was issued a passport of the type intended to repatriate victims of the Nazis. Under the name Dr. Helmut Gregor, Mengele boarded a freighter for Buenos Aires, where President Juan Peron had welcomed thousands of Nazis fleeing persecution for their war crimes. The Mengele family had managed to retain the bulk of their fortune through the war and their financial support of Josef enabled him to continue his experiments in Argentina. He bought a pharmaceutical company in Buenos Aires and set to work analyzing the blood samples that he had brought with him from Auschwitz. In 1956, with a passport in his own name, Mengele traveled to Zurich, Switzerland where he visited his family and married his brother's widow. It would appear that he enjoyed a great deal of freedom for being one of the most wanted men in the world but this security was soon shattered when, after his return to South America, Israeli commandos kidnapped Adolf Eichmann in Argentina to stand trial in Israel. In 1959, Mengele fled to Paraguay where fellow Nazis helped him establish a false cover. For the next twenty-five years, most who hunted for Mengele believed he was hiding somewhere in Paraguay when actually he had moved to Nova Europa, Brazil in late 1960. His new wife left him in 1961 as his first wife had years earlier. In 1962, Mengele purchased a farm in Serra Negro, Brazil in partnership with a European couple who shared his fascist politics. At that same time, Jim Jones moved into a rented house in San Antonio, just a short distance north. Mengele was the foremost living authority on the Nazis' genetic experiments and Jim Jones would soon assume his title. The fact that the two men moved so close to each other during a pivotal point in both their lives suggests that they met. Jonestown could have been the "changing of the guard"; the Nouveau Nazi superbabies taking power from Himmler's SS. There may not be a Fourth Reich, only a continuation of the Third. It has been said that Jones traveled to Brazil after escaping Jonestown with the medical records. He may have delivered the results of the experiment to Mengele who had since moved to San



## M A T R I X I I I

Paulo. On February 7, 1979, just ten weeks after the Jonestown massacre, Mengele reportedly drowned in a swimming accident. His death was not revealed until 1985 when, in the midst of the greatest manhunt in history, Mengele's Nazi partners in Brazil announced that the Angel of Death was dead and buried. The body was exhumed but, after so many years in the dirt, the remains were not identifiable. Mengele's friends provided the authorities with samples of what they said was the dead man's handwriting and it was confirmed as the same as Mengele's SS application on file since the early 1930s. That was the only identification made. Obviously, Mengele's business associates in Brazil would have copies of his handwriting but what is astonishing is that the world would believe that it was the handwriting of the dead man. The only people to claim to have proof that Mengele is dead are his family in Bavaria and his friends in Brazil.

It is time we realized the danger posed by Nazis who have infiltrated organizations in an effort to achieve world dominance. Their presence and influence is everywhere. In the early 1940's, a young Polish salesman, employed by I.G. Farben, sold cyanide to the Nazis for use in Auschwitz. Fearing for his life after the war, he took refuge in the Catholic Church and was ordained a priest in late 1946. In 1958 he was ordained Poland's youngest bishop. After the thirty day reign and assassination of his predecessor, he assumed the Papacy as Pope John Paul II. One of his first jobs in office was to canonize a Polish priest who was allegedly killed in the Auschwitz concentration camp.

It has recently been disclosed that Austrian President Kurt Waldheim, who was Secretary General of the United Nations from 1972 until 1982, was in fact a Nazi intelligence officer who helped identify and execute thousands of non-military personnel in German occupied countries during the war.

There was once a woman with a dream, a dream to give underprivileged women a choice through inexpensive or free birth control. The woman was Margaret Sanger who, in the conceptual stages of her Planned Parenthood organization, consulted with several of Hitler's social architects who saw her plan as a viable means to curb the birthrate of U.S. Blacks, which was, and still is, twice that of Whites.

Recently, the U.S. extradited Nazi war criminal Andriya Artukovic to stand trial in Yugoslavia where he was sentenced to death by firing squad for ordering the execution of over 231,000 residents of the Nazi puppet state of Croatia. For the last 36 years, Artukovic has

## M A T R I X I I I

lived an affluent lifestyle in Seal Beach, California, while the U.S. government made every excuse imaginable to prevent his extradition to Yugoslavia. They even declared him senile and legally blind but that did not stop the Yugoslavians' pursuit and finally he was turned over to his executioners. The release of this 86 year old, terminally ill Nazi was just a token effort by the U.S. government to disguise the truth that, even to this day, over 26 Nazis are living in the U.S. under the protection of Washington. These Nazis are only the ones who have been identified as war criminals and who have survived the forty-one years since the end of World War II.

Soon after the war, two Nazis hiding in the United States were facing extradition, trial and almost certain execution for their crimes against humanity when a brilliant young lawyer came to their defense. The lawyer instructed them to establish a business on paper only. He then arranged through his contacts in government for this phony company to be granted a military contract to supply some minor piece of hardware that was classified top secret. He then approached the courts with a defense that his Nazi clients should not be extradited because their company was necessary for national defense. The courts agreed and the Nazis were permitted to remain in the U.S. even though their shell of a company could not and did not fulfill the contract. The young lawyer went on to work with Senator McCarthy to compile a list of Hollywood performers suspected of being "communist sympathizers." Prominent on the Hollywood blacklist was the name of an actress whose family history would not seem to warrant her inclusion. Her mother had even worked as an undercover agent for the FBI. She was reportedly despondent over the prospect of never again being cast in one of her minor movie roles but actually she was about to embark on the most important theatrical performance of her life. Citing what she said was unfair treatment, she complained to the head of the Screen Actor's Guild who empathized with her problem and found that they had more than just a career in common. He and his ex-wife had worked as FBI informants who spied on their fellow actors. The two married only a few weeks after this first meeting. The young lawyer was Richard Nixon. The newlyweds were Ronald and Nancy Reagan.

Nazis have attempted to control every political, social, economic, and religious power structure in the world today. They have infiltrated

## M A T R I X I I I

every major organization from the Holy See to the United Nations, from Interpol to the atomic energy community, from Washington to Moscow. It is logical to assume that when the Nazis sold their spies in Russia to the CIA that they also sold their spies in the United States to the KGB.

The Nazis' influence over the U.S. federal government has not gone unnoticed. In early 1979, just a few months after the Jonestown massacre, President Carter established a commission on the Holocaust that, among other duties, was to receive reports of any new attempts at genocide. Carter said, "Never again will the world stand silent or look the other way in the face of genocide." Carter was well aware of the modern-day Nazi threat but his concern might have stemmed from the embarrassment or responsibility he felt since the largest attempt at genocide since World War II occurred under his administration. In any event, the commission never investigated Jonestown. Toward the end of his term, Carter helped establish a judiciary agency to ferret out Nazi war criminals in the United States. Until 1983, the chief Nazi-hunter in the U.S. government was Allen Ryan but, by this third year of the Reagan administration, most attempts to identify Nazis in government (and particularly in the CIA) were circumvented by President Reagan and Vice President Bush (a former director of the CIA). Reagan gave the agency sweeping new powers to spy on American citizens at home, operate domestic front companies and prosecute anyone who identified Agency personnel. He increased their budget and approved construction of a new wing on their headquarters. The recent growth of the CIA is indicative of a fascist, right wing wave that is presently rampant in the United States. For our democracy to survive into the 21st century, Americans need to understand that their lives and freedom are in danger from an enemy that most believe was defeated over forty years ago. We are now only fifty years into Himmler's plan to purify the race of man in the first one hundred twenty-five years of the Thousand Year Reich. It would seem that the plan is still on schedule. Fifty years ago, the Nazis had to manually identify homosexuals and drug addicts, transport them to the death camps that they had to build, pay for the guards, the cyanide and the disposal of the corpses, all under public scrutiny and the chance that eventually they would have to answer for their genocidal crimes. Today, the very inexpensive AIDS virus performs the same function without the risk that the architects of the epidemic will ever be brought to justice.

# Laughing in Face of Death, B. F. Skinner Defends His Theory of Life

THE NEW YORK TIMES NATIONAL WEDNESDAY, AUGUST 8, 1990

CAMBRIDGE, Mass., Aug. 7 (AP) B. F. Skinner, the psychologist who popularized behavior modification, says he is facing his approaching death from leukemia with no regrets, a life that he says was governed by rational rules.

Dr. Skinner, 86 years old, is preparing what may be his final work, a defense of research that explored the uses of positive and negative reinforcement to improve human behavior.

"I will be dead in a few months," Dr. Skinner said with a laugh in an interview last week. "But it hasn't given me the slightest anxiety or worry or anything. I always knew I was going to die."

Dr. Skinner's frame is lean but otherwise he shows little sign of illness. His snow-white hair is combed back from an expansive forehead and his blue-gray eyes sparkle when he discusses his work.

## Summing Up of His Beliefs

For years, he has endured a battering by many American psychologists who scorned his belief that behavior could be engineered to make society better. Not everyone will accept his final work, he said.

"I'm writing a paper which is my summing up of what psychology is all about and attacking cognitive psychologists," Dr. Skinner said. "The cognitive psychologists won't like it, but that doesn't bother me at all."

Cognitive psychology emphasizes the unconscious structures of the human mind, rules for the brain's operation that cannot be explained by conditioning.

Dr. Skinner's principle of "operant behavior" holds that even seemingly spontaneous action is a response to rewards and punishment. People do not shape the world, he has said; the world shapes them.

## 'Smuggle Me up on the Stage'

On Friday, Dr. Skinner is to be honored by the American Psychological



The psychologist, B. F. Skinner, at his home in Cambridge, Mass.

Association in Boston. The appearance will have to be with care. The cancer has destroyed much of Dr. Skinner's immune system. Visitors to his Cambridge home must wash their hands before meeting him.

"They're going to smuggle me up on the stage and then take me right back out," Dr. Skinner said. "I won't go to a reception and shake anyone's hands."

"I suppose," he added with a chuckle, "I could show up with rubber gloves on."

Burrhus Frederic Skinner (B. F. to the world, Fred to his friends) grew up in Susquehanna, Pa., and spent most of his career at Harvard University, where he applied his observations of animals to the motives and manipulation of human conduct. He retired from the faculty in 1974.

Dr. Skinner argued that "behavioral technology" could be put to work to

create a world free of overpopulation, war and pollution.

In "Walden Two," a novel published in 1948, he described a tightly controlled Utopia in which people were motivated by positive and negative reinforcements. The novel was required reading for many college students in the 1960's and 1970's.

In Walden Two, everyone was happy. People did not know the meaning of envy and jealousy. Buildings were communally owned and everyone helped out with chores.

## Ideas of Russian Psychologist

Many psychologists found Dr. Skinner's Walden to be a tyrannical place; others said it was bland. But his application of the ideas of the Russian physiologist Ivan Pavlov have left an indel-

ible stamp on American society.

Jerome Kagan, chairman of the Harvard psychology department, said, "We now know that many principles govern human behavior, not just operant behavior, but that doesn't diminish his importance."

Operant conditioning is used every day by parents, Dr. Kagan said, "every time they praise a behavior they want and punish one they don't want."

To his regret, Dr. Skinner is widely remembered for teaching pigeons to play Ping-Pong. Using a device known as the Skinner Box, the pigeons pressed buttons or levers to receive food in return for doing what the experimenter wanted them to do. A Life magazine photograph of the pigeons hangs in Dr. Skinner's wood-paneled study. Nearby is a signed portrait of Pavlov, whose experiment showed that dogs could be conditioned to salivate at the ring of a bell.

## Laments Search for Inner Self

He laments the search among cognitive psychologists for an "inner creator" responsible for human behavior, likening them to creationists who scorn Darwin's theory of evolution.

Dr. Skinner compares the search for an inner self to the search for God. Dr. Skinner does not believe in God, either.

And how does he want to be remembered?

"Somebody asked my daughter recently what she remembered most about me," he said. "It was very strange. She said I used to come and put her to bed and talk with her, and I'd take her hand and there'd be tears in my eyes."

"I'd hate to have people say he's the man who taught pigeons to play Ping-Pong."



**W**ho is George Bush? How did he become the 41st U.S. President?

He is said to be a man of the "old establishment," who "chose to seek his fortune as an independent oilman. . . ."

In fact, Bush was never "independent." Every career step in his upward climb relied on his family's powerful associations. The Bush family joined the Eastern Establishment comparatively recently, and only as servitors. Their wealth and influence resulted from their loyalty to another, more powerful family, and their willingness to do *anything* to get ahead.

For what they did, Bush's forebears should have become very famous, or infamous. They remained obscure figures, managers from behind the scenes. But their actions—including his father's role as banker for Adolf Hitler—had tragic effects for the whole planet.

It was these services to his family's benefactors, which propelled George Bush to the top.

## 1. Prescott Goes to War

President George Herbert Walker Bush was born in 1924, the son of Prescott S. Bush and Dorothy Walker Bush. We will begin the George Bush story about a decade before his birth, on the eve of World War I. We will follow the career of his father, Prescott Bush, through his marriage with Dorothy Walker, as he moves along the path to fortune, elegance, and power.

Prescott Bush entered Yale University in 1913. A native of Columbus, Ohio, Prescott had spent the last five years before college in St. George's Episcopal preparatory school in Newport, Rhode Island.

Prescott Bush's first college year, 1913, was also the freshman year at Yale for E. Roland ("Bunny") Harriman, whose older brother (Wm.) Averell Harriman had just graduated from Yale. This is the Averell Harriman who went on to fame as the U.S. ambassador to the Soviet Union during World War II, as a governor of New York State, and as a presidential adviser who was greatly responsible for starting the Vietnam War.

The Harrimans would become the sponsors of the Bushes, to lift them onto the stage of world history.

In the spring of 1916, Prescott Bush and "Bunny" Harriman were chosen for membership in an elite Yale senior-year secret society known as Skull and Bones. This unusually morbid, death-celebrating group helped Wall Street financiers find active young men of "good birth" to form a kind of imitation British aristocracy in America.

World War I was then raging in Europe. With the prospect that the U.S.A. would soon join the war, two Skull and Bones "Patriarchs," Averell Harriman (class of 1913) and Percy A. Rockefeller (class of 1900), paid special attention to Prescott's class of 1917. They wanted reliable cadres to help them play the Great Game, in the lucrative new imperial era that the war was opening up for London and New York moneycrats. Prescott Bush, by then a close friend of "Bunny" Harriman, and several other Bonesmen from their class of 1917 would later comprise the core partners in Brown Brothers Harriman, the world's largest private investment bank.

World War I did make an immense amount of money for the clan of stock speculators and British bankers who had just taken over U.S. industry. The Harrimans were stars of this new Anglo-American elite.

Averell's father, stock broker E.H. Harriman, had gained control of the Union Pacific Railroad in 1898 with credit arranged by William Rockefeller, Percy's father, and by Kuhn Loeb & Co.'s British-affiliated private bankers, Otto Kahn, Jacob Schiff and Felix Warburg.

William Rockefeller, treasurer of Standard Oil and brother of Standard founder John D. Rockefeller, owned National City Bank (later "Citibank") together with Texas-based James Stillman. In return for their backing, E.H. Harriman deposited in City Bank the vast receipts from his railroad lines. When he issued tens of millions of dollars of "watered" (fraudulent) railroad stock, Harriman sold most of the shares through the Kuhn Loeb company.

The First World War elevated Prescott Bush and his father, Samuel P. Bush, into the lower ranks of the Eastern Establishment.

As war loomed in 1914, National City Bank began reorganizing the U.S. arms industry. Percy A. Rockefeller took direct control of the Remington Arms company, appointing his own man, Samuel F. Pryor, as the new chief executive of Remington.

The United States entered World War I in 1917. In the spring of 1918, Prescott's father, Samuel P. Bush, became chief of the Ordnance, Small Arms and Ammunition Section of the War Industries Board.<sup>2</sup> The senior Bush took national responsibility for government assistance to and relations with Remington and other weapons companies.

This was an unusual appointment, as Prescott's father seemed to have no background in munitions. Samuel Bush had been president of the Buckeye Steel Castings Co. in Columbus, Ohio, makers of railcar parts. His entire career had been in the railroad business—supplying equipment to the Wall Street-owned railroad systems.

The War Industries Board was run by Bernard Baruch, a Wall Street speculator with close personal and business ties to old E.H. Harriman. Baruch's brokerage firm had handled Harriman speculations of all kinds.<sup>3</sup>

In 1918, Samuel Bush became director of the Facilities Division of the War Industries Board. Prescott's father reported to the board's chairman, Bernard Baruch, and to Baruch's assistant, Wall Street private banker Clarence Dillon.

Robert S. Lovett, President of Union Pacific Railroad, chief counsel to E.H. Harriman, and executor of his will, was in charge of national production and purchase "priorities" for Baruch's board.

With the war mobilization conducted under the supervision of the War Industries Board, U.S. consumers and taxpayers showered unprecedented fortunes on war producers and certain holders of raw materials and patents. Hearings in 1934 by the committee of U.S. Senator Gerald Nye attacked the "Merchants of Death"—war profiteers such as Remington Arms and the British Vickers company—whose salesmen had manipulated many nations into



1. Samuel Prescott Bush



3. George Herbert Walker



5. Prescott Sheldon Bush



7. President George Herbert Walker Bush

2. Flora Sheldon

4. Loulie Wear

6. Dorothy Walker

1. Samuel Prescott Bush, the President's paternal grandfather: Ohio railroad supplier, wartime mediator between government and the arms merchants.

2. Flora Sheldon Bush, the President's paternal grandmother: She wrote an apology for Prescott's fake heroism.

3. George Herbert Walker, the President's maternal grandfather: St. Louis banker, sports gambling chief with friends in the British establishment.

4. Loulie Wear Walker, the President's maternal grandmother: From a "high society" St. Louis family.

5. Prescott Sheldon Bush, the President's father: Owing his power and fortune to the Harrimans, he would do anything for them.

6. Dorothy Walker Bush, the President's mother: Athletic, proud, wealthy, terrifyingly competitive.

wars, and then supplied all sides with the weapons to fight them.

Percy Rockefeller and Samuel Pryor's Remington Arms supplied machine guns and Colt automatic pistols; millions of rifles to Czarist Russia; over half of the small-arms ammunition used by the Anglo-American allies in World War I; and 69 percent of the rifles used by the United States in that conflict.<sup>4</sup>

Samuel Bush's wartime relationship to these businessmen would continue after the war, and would especially aid his son Prescott's career of service to the Harrimans.

Most of the records and correspondence of Samuel Bush's arms-related section of the government have been burned, "to save space" in the National Archives. This matter of destroyed or misplaced records should be of concern to citizens of a constitutional republic. Unfortunately, it is a rather constant impediment with regard to researching George Bush's background: He is certainly the most "covert" American chief executive.

Now, arms production in wartime is by necessity carried on with great security precautions. The public need not know details of the private lives of the government or industry executives involved, and a broad interrelationship between government and private-sector personnel is normal and useful.

But during the period preceding World War I, and in the war years 1914-1917 when the United States was still neutral, interlocking Wall Street financiers subservient to British strategy lobbied heavily, and twisted U.S. government and domestic police functions. Led by the J.P. Morgan concern, Britain's overall purchasing agent in America, these financiers wanted a world war and they wanted the United States in it as Britain's ally. The U.S. and British arms companies, owned by these international financiers, poured out weapons abroad in deals not subject to the scrutiny of any electorate back home. The same gentlemen, as we shall see, later supplied weapons and money to Hitler's Nazis.

That this problem persists today, is in some respect due to the "control" over the documentation and the history of the arms traffickers.

World War I was a disaster for civilized humanity. It had terrible, unprecedented casualties, and shattering effects on the moral philosophy of Europeans and Americans.

But for a brief period, the war treated Prescott Bush rather well.

In June 1918, just as his father took over responsibility for relations of the government with the private arms producers, Prescott went to Europe with the U.S. Army. His unit did not come near any fire until September. But on August 8, 1918, the following item appeared on the front page of Bush's home-town newspaper:

### **3 High Military Honors Conferred on Capt. Bush**

*For Notable Gallantry, When Leading Allied Commanders Were Endangered, Local Man is Awarded French, English and U.S. Crosses.*

International Honors, perhaps unprecedented in the life of an American soldier, have been conferred upon Captain Prescott Sheldon Bush, son of Mr. and Mrs. S.P. Bush of Columbus.

Upon young Bush . . . were conferred: Cross of the Legion of Honor, . . . Victoria Cross, . . . Distinguished Service Cross. . .

Conferring of the three decorations upon one man at one time implies recognition of a deed of rare valor and probably of great military importance as well.

From word which has reached Columbus during the last few days, it appears as if the achievement of Captain Bush well measures up to these requirements.

The incident occurred on the western front about the time the Germans were launching their great offensive of July 15. . . . The history of the remarkable victory scored later by the allies might have been written in another vein, but for the heroic and quick action of Captain Bush.

The . . . three allied leaders, General Foch, Sir Douglas Haig and General Pershing. . . were making an inspection of American positions. General Pershing had sent for Captain Bush to guide them about one sector.

As they approached a certain battery, it was evident that the place was being shelled by German 77s, but the generals proceeded. . .

It is possible a German field glass perceived their movements, for a shell lit 20 yards in front of them. None was injured, although a fragment tore the boot of Captain Bush.

The party then moved along more rapidly. Suddenly Captain Bush noticed a shell coming directly for them. He shouted a warning, suddenly drew his bolo knife, stuck it up as he would a ball bat, and parried the blow, causing the shell to glance off to the right.

The three generals marvelled at the exploit. Apparently, they couldn't believe their eyes.

They immediately took shelter and waited for the shelling to stop.

Within 24 hours young Bush was notified . . . [that] the three allied commanders had recommended him for practically the highest honors within their gift.

On the following day there was a parade in Paris of soldiers to be decorated. As he was the only one to receive three honors, Captain Bush was placed at the head of the procession.

Captain Bush is 23 years old, a graduate of Yale in the class of 1917. He was one of Yale's best-known athletes . . . was leader of the glee club . . . and in his senior year was elected to the famous Skull and Bones Society. . . .<sup>5</sup>

The day after this astonishing story appeared, there was a large cartoon on the editorial page. It depicted Prescott Bush as a small boy, reading a story-book about military heroism, and saying: "Gee! I wonder if anything like that could ever truly happen to a boy." The caption below was a rehash of the batting-away-the-deadly-shell exploit, written in storybook style.<sup>6</sup>

Local excitement about the military "Babe Ruth" lasted just four weeks. Then this somber little box appeared on the front page:

Editor State Journal:

A cable received from my son, Prescott S. Bush, brings word that he has not been decorated, as published in the papers a month ago. He feels dreadfully troubled that a letter, written

in a spirit of fun, should have been misinterpreted. He says he is no hero and asks me to make explanations. I will appreciate your kindness in publishing this letter. . . .

Flora Sheldon Bush.  
Columbus, Sept. 5.<sup>7</sup>

Prescott Bush later claimed that he spent "about 10 or 11 weeks" in the area of combat in France. "We were under fire there. . . . It was quite exciting, and of course a wonderful experience."<sup>8</sup>

Prescott Bush was discharged in mid-1919, and returned for a short time to Columbus, Ohio. But his humiliation in his home town was so intense that he could no longer live there. The "war hero" story was henceforth not spoken of in his presence. Decades later, when he was an important, rich U.S. senator, the story was whispered and puzzled over among the congressmen.

Looking to be rescued from this ugly situation, Captain Bush went to the 1919 reunion of his Yale class in New Haven, Connecticut. Skull and Bones Patriarch Wallace Simmons, closely tied to the arms manufacturers, offered Prescott Bush a job in his St. Louis railroad equipment company. Bush took the offer and moved to St. Louis—and his destiny.

Prescott Bush went to St. Louis to repair his troubled life. Sometime that same year, Averell Harriman made a trip there on a project which would have great consequences for Prescott. The 28-year-old Harriman, until then something of a playboy, wanted to bring his inherited money and contacts into action in the arena of world affairs.

President Theodore Roosevelt had denounced Harriman's father for "cynicism and deep-seated corruption" and called him an "undesireable citizen."<sup>9</sup> For the still-smarting Averell to take his place among the makers and breakers of nations, he needed a financial and intelligence-gathering organization of his own. The man Harriman sought to create such an institution for him was Bert Walker, a Missouri stock broker and corporate wheeler-dealer.

George Herbert ("Bert") Walker, for whom President George H.W. Bush was named, did not immediately accept Harriman's proposal. Would Walker leave his little St. Louis empire, to try his influence in New York and Europe?

Bert was the son of a dry goods wholesaler who had thrived on imports from England.<sup>10</sup> The British connection had paid for Walker summer houses in Santa Barbara, California, and in Maine—"Walker's Point" at Kennebunkport. Bert Walker had been sent to England for his prep school and college education.



Jacob Schiff, boss of Kuhn Loeb.



Otto Kahn, E.H. Harriman's man at Kuhn Loeb.



William Rockefeller, Citibank founder.



Percy A. Rockefeller, co-founder W.A. Harriman & Co.



J.P. Morgan, Sr.

"Led by J.P. Morgan, these financiers wanted a world war and the United States as Britain's ally. The same gentlemen later supplied weapons and money to Hitler's Nazis."



E.H. Harriman with his sons Averell (left) and Roland ("Bunny") Harriman. The Bush family's wealth and power comes from the Harrimans.

"World War I was a disaster for civilized humanity, with shattering effects on the moral philosophy of Europeans and Americans. But the war treated Prescott Bush rather well."



The Allied Meuse-Argonne offensive in World War I, September 1918.

British officials testing a machine gun.





By 1919, Bert Walker had strong ties to the Guaranty Trust Company in New York and to the British-American banking house J.P. Morgan and Co. These Wall Street concerns represented all the important owners of American railroads: the Morgan partners and their associates or cousins in the intermarried Rockefeller, Whitney, Harriman, and Vanderbilt families.

Bert Walker was known as the Midwest's premier deal-arranger, awarding the investment capital of his international-banker contacts to the many railroads, utilities, and other mid-western industries of which he and his St. Louis friends were executives or board members.

Walker's operations were always quiet, or mysterious, whether in local or global affairs. He had long been the "power behind the throne" in the St. Louis Democratic Party, along with his crony, former Missouri Governor David R. Francis. Walker and Francis together had sufficient influence to select the party's candidates.<sup>11</sup>

Back in 1904, Bert Walker, David Francis, Washington University President Robert Brookings and their banker/broker circle had organized a world's fair in St. Louis, the Louisiana Purchase Exposition. In line with the old Southern Confederacy family backgrounds of many of these sponsors, the fair featured a "Human Zoo": live natives from overseas jungle regions, and American Indians who were federal prisoners, were exhibited in walled compounds under the supervision of anthropologist William J. McGee.

So Averell Harriman was a natural patron for Bert Walker. Bert shared Averell's passion for horse breeding and horse racing, and easily accommodated the Harriman family's related social philosophy. They believed that the horses and racing stables they owned showed the way toward a sharp upgrading of the human stock—just select and mate thoroughbreds, and spurn or eliminate inferior animals.

The First World War had brought the little St. Louis oligarchy into the Confederate-slaveowner-oriented administration of President Woodrow Wilson and his advisers, Col. Edward House and Bernard Baruch.

Walker's friend Robert Brookings got into Bernard Baruch's War Industries Board as director of national Price Fixing (sic). David R. Francis became U.S. ambassador to Russia in 1916. As the Bolshevik Revolution broke out, we find Bert Walker busy appointing people to Francis's staff in Petrograd.<sup>12</sup>

Walker's earliest activities in relation to the Soviet state are of significant interest to historians, given the activist role he was to play there together with Harriman. But Walker's life is as covert as the rest of the Bush clan's, and the surviving public record is extremely thin.

The 1919 Versailles peace conference brought together British imperial strategists and their American friends to make postwar global arrangements. For his own intended international adventures, Harriman needed Bert Walker, the seasoned intriguer, who quietly represented many of the British-designated rulers of American politics and finance.

After two persuasion trips west by Harriman,<sup>13</sup> Walker at length agreed to move to New York. But he kept his father's summer house in Kennebunkport, Maine.

Bert Walker formally organized the W. A. Harriman & Co. private bank in November 1919. Walker became the bank's president and chief executive; Averell Harriman was chairman and controlling co-owner with his brother Roland ("Bunny"), Prescott Bush's close friend from Yale; and Percy Rockefeller was a director and a founding financial sponsor.

In the autumn of 1919, Prescott Bush made the acquaintance of Bert Walker's daughter Dorothy. They were engaged the following year, and were married in August, 1921.<sup>14</sup>

The society page of a St. Louis newspaper described the gala affair:

The marriage of Miss Dorothy Walker, daughter of Mr. and Mrs. G. Herbert Walker of New York, formerly of this city, and Mr. Prescott Sheldon Bush took place Friday afternoon at the Walker summer home, 'Surf Lodge,' in Kennebunkport [sic], Me. . . . Guests from summer resorts along the New Hampshire and Massachusetts coasts were present at the reception. . . . The spacious grounds surrounding the Walker country home made a charming setting for the dainty summer frocks of the guests. . . .

The bridesmaids included . . . Miss Isabel Rockefeller [daughter of Percy Rockefeller] . . . of New York. . . .

The bride came out two years ago and was invited to join the Imperial in her debut year, and was also a member of the Junior League. She is related to many families of prominence in St. Louis. . . .

Among the 11 "ushers and groomsmen" named were Henry P. Isham, Ellery S. James, Samuel Duryee, Frank P. Shepard, Knight Woolley, and Henry Fenimore Cooper, all fellow Skull and Bonesmen from the Yale Class of 1917.<sup>15</sup>

The Bush-Walker extended family has gathered each summer at the "Walker country home" in Kennebunkport, from this marriage of President Bush's parents down to the present day.

When Prescott married Dorothy, he was only a minor executive of the Simmons Co., railroad equipment suppliers, while his wife's father was building one of the most gigantic businesses in the world. The following year the couple tried to move back to Columbus, Ohio; there Prescott worked for a short time in a rubber products company owned by his father. But they soon moved again to Milton, Mass., after outsiders bought the little family business and moved it near there.

Thus Prescott Bush was going nowhere fast, when his son George Herbert Walker Bush—the future U.S. President—was born in Milton, Mass., on June 12, 1924.

Perhaps it was as a birthday gift for George, that "Bunny" Harriman stepped in to rescue his father Prescott from oblivion, bringing him into the Harriman-controlled U.S. Rubber Co. in New York City. In 1925 the young family moved to the town where George was to grow up: Greenwich, Connecticut, a suburb both of New York and of New Haven/Yale.

Then, on May 1, 1926, Prescott Bush joined W.A. Harriman & Co. as its vice president, under the bank's president, Bert Walker, his father-in-law and George's maternal grandfather—the head of the family.<sup>16</sup>

---

## The Great Game

Prescott Bush would demonstrate strong loyalty to the firm he joined in 1926. And the bank, with the scope and power of many ordinary nations, could amply reward its agents. George Bush's Grandfather Walker had put the enterprise together, quietly, secretly, using all the international connections at his disposal. Let us briefly look back at the beginning of the Harriman firm—the Bush family enterprise—and follow its course into one of history's darkest projects.

The firm's first global lever was its successful arrangement to get into Germany by dominating that country's shipping. Averell Harriman announced in 1920 that he would re-start Germany's Hamburg-Amerika Line, after many months of scheming and arm-twisting. Hamburg-Amerika's commercial steamships had been confiscated by the United States at the end of the First World War. These ships had then become the property of the Harriman enterprise, by some arrangements with the U.S. authorities that were never made public.

The deal was breathtaking; it would create the world's largest private shipping line. Hamburg-Amerika Line regained its confiscated vessels, for a heavy price. The Harriman enterprise took "the right to participate in 50 percent of all business originated in Hamburg"; and for the next twenty years (1920-1940), the Harriman enterprise had "complete control of all activities of the Hamburg line in the United States."<sup>17</sup>

Harriman became co-owner of Hamburg-Amerika. The Harriman-Walker firm gained a tight hold on its management, with the not-so-subtle backing of the post-World War I occupation of Germany by the armies of England and America.

Just after Harriman's public statement, the St. Louis press celebrated Bert Walker's role in assembling the money to consummate the deal:

**Ex-St. Louisan Forms Giant Ship Merger**  
G. H. Walker is Moving Power Behind Harriman-Morton Shipping Combine. . . .

The story celebrated a "merger of two big financial houses in New York, which will place practically unlimited capital at the disposal of the new American-German shipping combine."<sup>18</sup>

Bert Walker had arranged a "marriage" of J.P. Morgan credit and Harriman family inherited wealth.

W.A. Harriman & Co., of which Walker was president and founder, was merging with the Morton & Co. private bank—and Walker was "[p]rominent in the affairs of Morton & Co.," which was interlocked with the Morgan-controlled Guaranty Trust Co.

The Hamburg-Amerika takeover created an effective instrument for the manipulation and fatal subversion of Germany. One of the great "merchants of death," Samuel Pryor, was in it from the beginning. Pryor, then chairman of the executive committee of Remington Arms,

helped arrange the deal and served with Walker on the board of Harriman's shipping front organization, the American Ship and Commerce Co.

Walker and Harriman took the next giant step in 1922, setting up their European headquarters office in Berlin. With the aid of the Hamburg-based Warburg bank, W.A. Harriman & Co. began spreading an investment net over German industry and raw materials.

From the Berlin base, Walker and Harriman then plunged into deals with the new dictatorship of the Soviet Union. They led a select group of Wall Street and British Empire speculators who re-started the Russian oil industry, which had been devastated by the Bolshevik Revolution. They contracted to mine Soviet manganese, an element essential to modern steelmaking. These concessions were arranged directly with Leon Trotsky, then with Feliks Dzerzhinsky, founder of the Soviet dictatorship's secret intelligence service (KGB), whose huge statue was finally pulled down by pro-democracy demonstrators in 1991.

These speculations created both channels of communication and the style of accommodation with the communist dictatorship, that have continued in the family down to President Bush.

With the bank launched, Bert Walker found New York the ideal place to satisfy his passion for sports, games and gambling. Walker was elected president of the United States Golf Association (USGA) in 1920. He negotiated new international rules for the game with the Royal and Ancient Golf Club of St. Andrews, Scotland. After these talks he contributed the three-foot-high silver Walker Cup, for which British and American teams have since competed every two years.

Bert's son-in-law Prescott Bush was later secretary of the U.S. Golf Association, in the grave political and economic crises of the early 1930s. Prescott became USGA President in 1935, while he was otherwise embroiled in the family firm's work with Nazi Germany.

When George was one year old, in 1925, Bert Walker and Averell Harriman headed a syndicate which rebuilt Madison Square Garden as the modern Palace of Sport. Walker was at the center of New York's gambling scene in its heyday, in that Prohibition era of colorful and bloody gangsters. The Garden bloomed with million-dollar prize fights; bookies and their clients pooled more millions, trying to match the pace of the speculation-crazed stock and bond men. This was the era of "organized" crime—the national gambling and bootleg syndicate structured on the New York corporate model.

By 1930, when George was a boy of six, Grandpa Walker was New York State Racing Commissioner. The vivid colors and sounds of the racing scene must have impressed little George as much as his grandfather. Bert Walker bred race horses at his own stable, the Log Cabin Stud. He was president of the Belmont Park race track. Bert also personally managed most aspects of Averell's racing interests—down to picking the colors and fabrics for the Harriman racing gear.<sup>19</sup>

From 1926, George's father Prescott Bush showed a fierce loyalty to the Harrimans and a dogged determination to advance himself; he gradually came to run the day-to-day operations of W.A. Harriman & Co. After the firm's 1931 merger with the British-American banking house Brown Brothers, Prescott Bush became managing partner of the resulting company: Brown Brothers Harriman. This was ultimately the largest and politically the most important private banking house in America.

Financial collapse, world depression, and social upheaval followed the fevered speculation of the 1920s. The 1929-31 crash of securities values wiped out the small fortune Prescott Bush had gained since 1926. But because of his devotion to the Harrimans, they "did a very generous thing," as Bush later put it. They staked him to what he had lost and put him back on his feet.

Prescott Bush described his own role, from 1931 through the 1940s, in a confidential interview:

"I emphasize . . . that the Harrimans showed great courage and loyalty and confidence in us, because three or four of us were really running the business, the day to day business. Averell was all over the place in those days . . . and Roland was involved in a lot of directorships, and he didn't get down into the 'lift-up-and-bear-down' activity of the bank, you see—the day-to-day decisions . . . we were really running the business, the day to day business, all the administrative decisions and the executive decisions. We were the ones that did it. We were the managing partners, let's say."<sup>20</sup>

But of the "three or four" partners in charge, Prescott was effectively at the head of the firm, because he had taken over management of the gigantic *personal investment funds* of Averell and E. Roland "Bunny" Harriman.

In those interwar years, Prescott Bush made the family fortune which George Bush inherited. He piled up the money from an international project which continued until a new world war, and the action of the U.S. government, intervened to stop him.

1. *Washington Post*, Aug. 16, 1991, p. A-1.
2. Gen. Hugh S. Johnson to Major J.H.K. Davis, June 6, 1918, file no. 334.8/168 or 334.8/451 in U.S. National Archives, Suitland, Maryland.
3. Bernard M. Baruch, *My Own Story*, New York: Henry Holt and Co., 1957, pp. 138-139. Baruch related that "our firm did a large business for Mr. Harriman. . . . In 1906 Harriman had [us] place heavy bets on Charles Evans Hughes in his race for Governor of New York against William Randolph Hearst. After several hundred thousand dollars had been wagered, [our firm] stopped. Hearing of this, Harriman called . . . up. 'Didn't I tell you to bet?' he demanded. 'Now go on.'"
4. Alden Hatch, *Remington Arms: An American History*, 1956, copyright by the Remington Arms Co., pp. 224-225.
5. *The Ohio State Journal*, Columbia, Ohio, Thursday, Aug. 8, 1918.
6. *The Ohio State Journal*, Friday, Aug. 9, 1918.
7. *The Ohio State Journal*, Friday, Sept. 6, 1918.
8. Interview with Prescott Bush in the Oral History Research Project conducted by Columbia University in 1966, Eisenhower Administration Part II; pp. 5-6. The interview was supposed to be kept confidential and was never published, but Columbia later sold microfilms of the transcript to certain libraries, including Arizona State University.
9. Theodore Roosevelt to James S. Sherman, Oct. 6, 1906, made public by Roosevelt at a press conference April 2, 1907. Quoted in Henry F. Pringle, *Theodore Roosevelt*, New York: Harcourt, Brace and Company, 1931, p. 432. Roosevelt later confided to Harriman lawyer Robert S.

Lovett that his views on Harriman were based on what J.P. Morgan had told him.

10. Cf. *The Industries of St. Louis*, published 1885 by J.M. Elstner & Co., pp. 61-62 for Crow, Hagardine & Co., David Walker's first business; and p. 86 for Ely & Walker.
11. Cf. Letter of G. H. Walker to D. R. Francis, March 20, 1905, in the Francis collection of the Missouri Historical Society, St. Louis, Missouri, on the organization of the Republicans and Democrats to run the election of the mayor, a Democrat acceptable to the socially prominent. The next day Walker became the treasurer and Francis the president of this "Committee of 1000." Cf. also George H. Walker obituary, *St. Louis Globe-Democrat*, June 25, 1953.
12. Letter of Perry Francis to his father, Ambassador David R. Francis, Oct. 15, 1917, Francis collection of the Missouri Historical Society. ". . . Joe Miller left for San Francisco last Tuesday night, where he will receive orders to continue to Petrograd. I was told by Mildred Kotany [Walker's sister-in-law] that Bert Walker got him his appointment through Breck Long. I didn't know Joe was after it, or could have helped him myself. He will be good company for you when he gets there. . . ."
13. Private interview with a Walker family member, cousin of President Bush.
14. Prescott Bush, Columbia University, *op. cit.*, p. 7.
15. *St. Louis Globe Democrat*, Sunday, Aug. 7, 1921.
16. This is the sequence of events, from Simmons to U.S. Rubber, which Prescott Bush gave in his Columbia University interview, *op. cit.*, pp. 7-8.
17. Public statement of Averell Harriman, *New York Times*, Oct. 6, 1920, p. 1.
18. *St. Louis Globe-Democrat*, Oct. 12, 1920, p. 1.
19. Sports-as-business has continued in the family up through George Bush's adult life. Bert's son George Walker Jr.—President Bush's uncle and financial angel in Texas—co-founded the New York Mets and was the baseball club's vice president and treasurer for 17 years until his death in 1977. The President's son, George Walker Bush, Jr., was co-owner of the Texas Rangers club during his father's presidency.
20. Prescott Bush, Columbia University, *op. cit.*, pp. 16-22.

## 2. The Bush Family and the Hitler Project

In October 1942, ten months after entering World War II, America was preparing its first assault against Nazi military forces. Prescott Bush was managing partner of Brown Brothers Harriman. His 18-year-old son George, the future U.S. President, had just begun training to become a naval pilot.

On October 20, 1942, the U.S. government ordered the seizure of Nazi German banking operations in New York City which were being conducted by Prescott Bush.

Under the Trading with the Enemy Act, the government took over the Union Banking Corporation, in which Bush was a director. The U.S. Alien Property Custodian seized Union Banking Corp.'s stock shares, all of which were owned by Prescott Bush, E. Roland "Bunny" Harriman, three Nazi executives, and two other associates of Bush.<sup>1</sup>

The order seizing the bank "vest[ed] [seized] all of the capital stock of Union Banking Corporation, a New York corporation," and named the holders of its shares as:

• "E. Roland Harriman—3991 shares." Harriman was chairman and director of Union Banking Corp. (UBC); this is "Bunny" Harriman, described by Prescott Bush as a place holder who didn't get much into banking affairs; Prescott managed his personal investments.

• "Cornelis Lievens—4 shares." Lievens was president and director of UBC, and a New York resident banking functionary for the Nazis.

• "Harold D. Pennington—1 share." Pennington was treasurer and director of UBC, and an office manager employed by Bush at Brown Brothers Harriman.

• "Ray Morris—1 share." Morris was director of UBC, and a partner of Bush and the Harrimans.

• "Prescott S. Bush—1 share." Bush was director of UBC, which was co-founded and sponsored by his father-in-law George Walker; he was senior managing partner for E. Roland Harriman and Averell Harriman.

• "H.J. Kouwenhoven—1 share" Kouwenhoven was director of UBC; he organized UBC as the emissary of Fritz Thyssen in negotiations with George Walker and Averell Harriman; he was also managing director of UBC's Netherlands affiliate under Nazi occupation; industrial executive in Nazi Germany, and also director and chief foreign financial executive of the German Steel Trust.

• "Johann G. Groeninger—1 share." Groeninger was director of UBC and of its Netherlands affiliate; he was an industrial executive in Nazi Germany.



President Bush's father, Prescott Bush, a director of the Nazi-front Union Banking Corporation from 1934 until 1942.

The order also specified: "all of which shares are held for the benefit of . . . members of the Thyssen family, [and] is property of nationals . . . of a designated enemy country. . . ."

By October 26, 1942, U.S. troops were underway for North Africa. On October 28, the government issued orders seizing two Nazi front organizations run by the Bush-Harriman bank: the Holland-American Trading Corporation and the Seamless Steel Equipment Corporation.<sup>2</sup>

U.S. forces landed under fire near Algiers on November 8, 1942; heavy combat raged throughout November. Nazi interests in the Silesian-American Corporation, long managed by Prescott Bush and his father-in-law George Herbert Walker, were seized under the Trading with the Enemy Act on November 17, 1942. In this action, the government announced that it was seizing only the Nazi interests, leaving the Nazis' U.S. partners to carry on the business.<sup>3</sup>

These and other actions taken by the U.S. government in wartime were, tragically, too little and too late. President Bush's family had already played a central role in financing and arming Adolf Hitler for his takeover of Germany; in financing and managing the buildup of Nazi war industries for the conquest of Europe

and war against the U.S.A.; and in the development of Nazi genocide theories and racial propaganda, with their well-known results.

The facts presented here must be known, and their implications reflected upon, for a proper understanding of President George Herbert Walker Bush and of the danger to mankind that he represents. The President's family fortune was largely a result of the Hitler project. The powerful Anglo-American family associations, which later boosted him into the Central Intelligence Agency and up to the White House, were his father's partners in the Hitler project.

President Franklin Roosevelt's Alien Property Custodian, Leo T. Crowley, signed Vesting Order Number 248 seizing the property of Prescott Bush under the Trading with Enemy Act. The order, published in obscure government record books and kept out of the news,<sup>4</sup> explained nothing about the Nazis involved; only that the Union Banking Corporation was run for the "Thyssen family" of "Germany and/or Hungary"—"nationals . . . of a designated enemy country."

By deciding that Prescott Bush and the other directors of the Union Banking Corp. were legally *front men for the Nazis*, the government avoided the more important historical issue: In what way were Hitler's Nazis themselves hired, armed, and instructed by the New York and London clique of which Prescott Bush was an executive manager? Let us examine the Harriman-Bush Hitler project from the 1920s until it was partially broken up, to seek an answer for that question.

## Origin and Extent of the Project

Fritz Thyssen and his business partners are universally recognized as the most important German financiers of Adolf Hitler's takeover of Germany. At the time of the order seizing the Thyssen family's Union Banking Corp., Mr. Fritz Thyssen had already published his famous book, *I Paid Hitler*,<sup>5</sup> admitting that he had financed Adolf Hitler and the Nazi movement since October 1923. Thyssen's role as the leading early backer of Hitler's grab for power in Germany had been noted by U.S. diplomats in Berlin in 1932.<sup>6</sup> The order seizing the Bush-Thyssen bank was curiously quiet and modest about the identity of the perpetrators who had been nailed.

But two weeks before the official order, government investigators had reported secretly that "W. Averell Harriman was in Europe sometime prior to 1924 and at that time became acquainted with Fritz Thyssen, the German industrialist." Harriman and Thyssen agreed to set up a bank for Thyssen in New York. "[C]ertain of [Harriman's] associates would serve as directors. . . ." Thyssen agent "H.J. Kouwenhoven . . . came to the United States . . . prior to 1924 for conferences with the Harriman Company in this connection. . . ."<sup>7</sup>

When exactly was "Harriman in Europe sometime prior to 1924"? In fact, he was in Berlin in 1922 to set up the Berlin branch of W.A. Harriman & Co. under George Walker's presidency.

The Union Banking Corporation was established formally in 1924, as a unit in the Manhattan offices of W.A. Harriman & Co., interlocking with the Thyssen-owned *Bank voor Handel en Scheepvaart* (BHS) in the Netherlands. The investigators concluded that "the Union Banking Corporation has since its inception handled funds chiefly supplied to it through the Dutch bank by the Thyssen interests for American investment."

Thus by personal agreement between Averell Harriman and Fritz Thyssen in 1922, W.A. Harriman & Co. (alias Union Banking Corporation) would be transferring funds back and forth between New York and the "Thyssen interests" in Germany. By putting up about \$400,000, the Harriman organization would be joint owner and manager of Thyssen's banking operations outside of Germany.

How important was the Nazi enterprise for which President Bush's father was the New York banker?

The 1942 U.S. government investigative report said that Bush's Nazi-front bank was an interlocking concern with the Vereinigte Stahlwerke (United Steel Works Corporation or German Steel Trust) led by Fritz Thyssen and his two brothers. After the war, congressional investigators probed the Thyssen interests, Union Banking Corp. and related Nazi units. The investigation showed that the Vereinigte Stahlwerke had produced the following approximate proportions of total German national output: 50.8% of Nazi Germany's pig iron; 41.4% of Nazi Germany's universal plate; 36.0% of Nazi Germany's heavy plate; 38.5% of Nazi Germany's galvanized sheet; 45.5% of Nazi Germany's pipes and tubes; 22.1% of Nazi Germany's wire; 35.0% of Nazi Germany's explosives.

This accounts for many, many Nazi submarines, bombs, rifles, gas chambers, etc.

Prescott Bush became vice president of W.A. Harriman & Co. in 1926. That same year, a friend of Harriman and Bush set up a giant new organization for their client Fritz Thyssen, prime sponsor of politician Adolf Hitler. The new *German Steel Trust*, Germany's largest industrial corporation, was organized in 1926 by Wall Street banker Clarence Dillon. Dillon was the old comrade of Prescott Bush's father Sam Bush from the "Merchants of Death" bureau in World War I.

In return for putting up \$70 million to create his organization, majority owner Thyssen gave the Dillon Read company two or more representatives on the board of the new Steel Trust.

Thus there is a division of labor: Thyssen's own confidential accounts, for political and related purposes, were run through the Walker-Bush organization; the Steel Trust did its corporate banking through Dillon Read.

\* \* \*

The Walker-Bush firm's banking activities were not just politically neutral money-making ventures which happened to coincide with the aims of German Nazis. All of the firm's European business in those days was organized around anti-democratic political forces.

In 1927, criticism of their support for totali-

tarianism drew this retort from Bert Walker, written from Kennebunkport to Averell Harriman: "It seems to me that the suggestion in connection with Lord Bearsted's views that we withdraw from Russia smacks somewhat of the impertinent . . . I think that we have drawn our line and should hew to it."<sup>10</sup>

Averell Harriman met with Italy's fascist dictator, Benito Mussolini. A representative of the firm subsequently telegraphed good news back to his chief executive Bert Walker: ". . . During these last days . . . Mussolini . . . has examined and approved our c[on]tract 15 June."<sup>11</sup>

The great financial collapse of 1929-31 shook America, Germany, and Britain, weakening all governments. It also made the hard-pressed

**"The President's family fortune was largely a result of the Hitler project. The powerful Anglo-American family associations, which later boosted him into the CIA and up to the White House, were his father's partners in the Hitler project."**

Prescott Bush even more willing to do whatever was necessary to retain his new place in the world. It was in this crisis that certain Anglo-Americans determined on the installation of a Hitler regime in Germany.

W.A. Harriman & Co., well-positioned for this enterprise and rich in assets from their German and Russian business, merged with the British-American investment house, Brown Brothers, on January 1, 1931. Bert Walker retired to his own G.H. Walker & Co. This left the Harriman brothers, Prescott Bush, and Thatcher M. Brown as the senior partners of the new Brown Brothers Harriman firm. (The London, England branch of the Brown family firm continued operating under its historic name—Brown, Shipley.)

Robert A. Lovett also came over as a partner from Brown Brothers. His father, E.H. Harriman's lawyer and railroad chief, had been on the War Industries Board with Prescott's father. Though he remained a partner in Brown Brothers Harriman, the junior Lovett soon replaced his father as chief executive of Union Pacific Railroad.

Brown Brothers had a racial tradition that fitted it well for the Hitler project. American patriots had cursed its name back in Civil War days. Brown Brothers, with offices in the U.S.A. and in England, had carried on their ships fully 75 percent of the slave cotton from the American South over to British mill owners; through their usurious credit they controlled and manipulated the slave-owners.

Now, in 1931, the virtual dictator of world finance, Bank of England Governor Montagu Collet Norman, was a former Brown Brothers partner, whose grandfather had been boss of Brown Brothers during the U.S. Civil War. Montagu Norman was known as the most avid of Hitler's supporters within British ruling circles, and Norman's intimacy with this firm was essential to his management of the Hitler project.

In 1931, while Prescott Bush ran the New York office of Brown Brothers Harriman, Prescott's partner was Montagu Norman's intimate friend Thatcher Brown. The Bank of England chief always stayed at the home of Prescott's partner on his hush-hush trips to New York. Prescott Bush concentrated on the firm's German activities, and Thatcher Brown saw to their business in old England, under the guidance of his mentor Montagu Norman.<sup>12</sup>

## Hitler's Ladder to Power

Adolf Hitler became Chancellor of Germany January 30, 1933, and absolute dictator in March 1933, after two years of expensive and violent lobbying and electioneering. Two affiliates of the Bush-Harriman organization played great parts in this criminal undertaking: Thyssen's German Steel Trust; and the Hamburg-Amerika Line and several of its executives.<sup>13</sup>

Let us look more closely at the Bush family's German partners.

Fritz Thyssen told Allied interrogators after the war about some of his financial support for the Nazi Party: "In 1930 or 1931 . . . I told [Hitler's deputy Rudolph] Hess . . . I would arrange a credit for him with a Dutch bank in Rotterdam, the Bank für Handel und Schiff [i.e. Bank voor Handel en Scheepvaart (BHS), the Harriman-Bush affiliate]. I arranged the credit . . . he would pay it back in three years. . . . I chose a Dutch bank because I did not want to be mixed up with German banks in my position, and because I thought it was better to do business with a Dutch bank, and I thought I would have the Nazis a little more in my hands. . . ."

"The credit was about 250-300,000 [gold] marks—about the sum I had given before. The loan has been repaid in part to the Dutch bank, but I think some money is still owing on it. . . ."<sup>14</sup>

The overall total of Thyssen's political donations and loans to the Nazis was well over a million dollars, including funds he raised from others—in a period of terrible money-shortage in Germany.

Friedrich Flick was the major co-owner of the German Steel Trust with Fritz Thyssen, Thyssen's longtime collaborator and sometime competitor. In preparation for the war crimes tribunal at Nuremberg, the U.S. government said that Flick was "one of leading financiers and industrialists who from 1932 contributed large sums to the Nazi Party . . . member of 'Circle of Friends' of Himmler who contributed large sums to the SS."<sup>15</sup>

Flick, like Thyssen, financed the Nazis to maintain their private armies called Schutzstaffel (S.S. or Black Shirts) and Sturmabteilung (S.A., storm troops or Brown Shirts).

The Flick-Harriman partnership was directly supervised by Prescott Bush, President Bush's father, and by George Walker, President Bush's grandfather.

The Harriman-Walker Union Banking Corp. arrangements for the German Steel Trust had made them bankers for Flick and his vast operations in Germany by no later than 1926.

The Harriman Fifteen Corporation (George Walker, president, Prescott Bush and Averell

Harriman, sole directors) held a substantial stake in the Silesian Holding Co. at the time of the merger with Brown Brothers, January 1, 1931. This holding correlated to Averell Harriman's chairmanship of the Consolidated Silesian Steel Corporation, the American group owning one-third of a complex of steelmaking, coal-mining and zinc-mining activities in Germany and Poland, in which Friedrich Flick owned two-thirds.<sup>16</sup>

The Nuremberg prosecutor characterized Flick as follows:

"Proprietor and head of a large group of industrial enterprises (coal and iron mines, steel producing and fabricating plants) . . . 'Wehrwirtschaftsfuehrer,' 1938 [title awarded to prominent industrialists for merit in armaments drive—'Military Economy Leader'] . . ."<sup>17</sup>

For this buildup of the Hitler war machine with coal, steel, and arms production, using slave laborers, the Nazi Flick was condemned to seven years in prison at the Nuremberg trials; he served three years. With friends in New York and London, however, Flick lived into the 1970s and died a billionaire.

On March 19, 1934, Prescott Bush—then director of the German Steel Trust's Union Banking Corporation—initiated an alert to the absent Averell Harriman about a problem which had developed in the Flick partnership.<sup>18</sup> Bush sent Harriman a clipping from the *New York Times* of that day, which reported that the Polish government was fighting back against American and German stockholders who controlled "Poland's largest industrial unit, the Upper Silesian Coal and Steel Company. . . ."

The *Times* article continued: "The company has long been accused of mismanagement, excessive borrowing, fictitious bookkeeping and gambling in securities. Warrants were issued in December for several directors accused of tax evasions. They were German citizens and they fled. They were replaced by Poles. Herr Flick, regarding this as an attempt to make the company's board entirely Polish, retaliated by restricting credits until the new Polish directors were unable to pay the workmen regularly."

The *Times* noted that the company's mines and mills "employ 25,000 men and account for 45 percent of Poland's total steel output and 12 percent of her coal production. Two-thirds of the company's stock is owned by Friedrich Flick, a leading German steel industrialist, and the remainder is owned by interests in the United States."

In view of the fact that a great deal of Polish output was being exported to Hitler's Germany under depression conditions, the Polish government thought that Bush, Harriman, and their Nazi partners should at least pay full taxes on their Polish holdings. The U.S. and Nazi owners responded with a lockout. The letter to Harriman in Washington reported a cable from their European representative: "Have undertaken new steps London Berlin . . . please establish friendly relations with Polish Ambassador [in Washington]."

A 1935 Harriman Fifteen Corporation memo from George Walker announced an agreement had been made "in Berlin" to sell an 8,000 block of their shares in Consolidated Silesian Steel.<sup>19</sup>

But the dispute with Poland did not deter the Bush family from continuing its partnership with Flick.

Nazi tanks and bombs "settled" this dispute in September, 1939 with the invasion of Poland, beginning World War II. The Nazi army had been equipped by Flick, Harriman, Walker, and Bush, with materials essentially stolen from Poland.

There were probably few people at the time who could appreciate the irony, that when the Soviets also attacked and invaded Poland from the East, their vehicles were fueled by oil pumped from Baku wells revived by the Harriman/Walker/Bush enterprise.

Three years later, nearly a year after the Japanese attack on Pearl Harbor, the U.S. government ordered the seizure of the Nazis' share in the Silesian-American Corporation under the Trading with the Enemy Act. Enemy nationals were said to own 49 percent of the common stock and 41.67 percent of the preferred stock of the company.

The order characterized the company as a "business enterprise within the United States, owned by [a front company in] Zurich, Switzerland, and held for the benefit of Bergwerks-Gesellschaft George von Giesche's Erben, a German corporation. . . ."<sup>20</sup>

Bert Walker was still the senior director of the company, which he had founded back in 1926 simultaneously with the creation of the German Steel Trust. Ray Morris, Prescott's partner from Union Banking Corp. and Brown Brothers Harriman, was also a director.

The investigative report prior to the government crackdown explained the "NATURE OF BUSINESS: The subject corporation is an American holding company for German and Polish subsidiaries, which own large and valuable coal and zinc mines in Silesia, Poland and Germany. Since September 1939, these properties have been in the possession of and have been operated by the German government and have undoubtedly been of considerable assistance to that country in its war effort."<sup>21</sup>

The report noted that the American stockholders hoped to regain control of the European properties after the war.

---

## Control of Nazi Commerce

Bert Walker had arranged the credits Harriman needed to take control of the Hamburg-Amerika Line back in 1920. Walker had organized the American Ship and Commerce Corp. as a unit of the W.A. Harriman & Co., with contractual power over Hamburg-Amerika's affairs.

As the Hitler project went into high gear, Harriman-Bush shares in American Ship and Commerce Corp. were held by the Harriman Fifteen Corp., run by Prescott Bush and Bert Walker.<sup>22</sup>

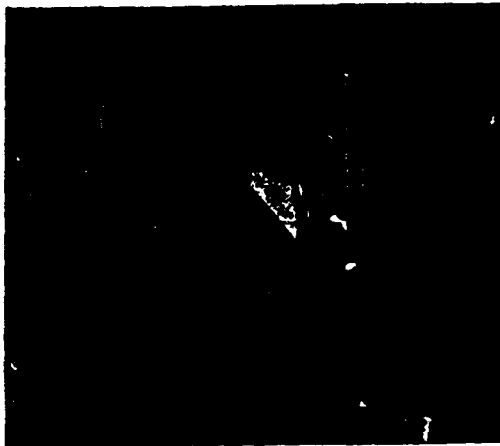

Roland ("Bunny") Harriman, left, and his brother chairman of the Union Banking Corporation, the Hitler's main German sponsor: Fritz Thyssen.

It was a convenient stroll for the well-tanned, athletic, handsome Prescott Bush. From the Brown Brothers Harriman skyscraper at 59 Wall Street—where he was senior managing partner, confidential investments manager and advisor to Averell and his brother "Bunny"—he walked across to the Harriman Fifteen Corporation at One Wall Street, otherwise known as G.H. Walker & Co.—and around the corner to his subsidiary offices at 39 Broadway, former home of the old W.A. Harriman & Co., and still the offices for American Ship and Commerce, and of the Union Banking Corporation.

In many ways, Bush's Hamburg-Amerika Line was the pivot for the entire Hitler project.

Averell Harriman and Bert Walker had gained control over the steamship company in 1920 in negotiations with its post-World War I chief executive, Wilhelm Cuno, and with the line's bankers, M.M. Warburg. Cuno was thereafter completely dependent on the Anglo-Americans, and became a member of the Anglo-German Friendship Society. In the 1930-32 drive for a Hitler dictatorship, Wilhelm Cuno contributed important sums to the Nazi Party.<sup>23</sup>

Albert Voegler was chief executive of the Thyssen-Flick German Steel Trust for which Bush's Union Banking Corp. was the New York office. He was a director of the Bush-affiliate BHS Bank in Rotterdam, and a director of the Harriman-Bush Hamburg-Amerika Line. Voegler joined Thyssen and Flick in their heavy 1930-33 Nazi contributions, and helped organize the final Nazi leap into national power.<sup>24</sup>

The Schroeder family of bankers was a linchpin for the Nazi activities of Harriman and Prescott Bush, closely tied to their lawyers Allen and John Foster Dulles.

Baron Kurt von Schroeder was co-director of the massive Thyssen-Huette foundry along with Johann Groening, Prescott Bush's New York bank partner. Kurt von Schroeder was treasurer of the support organization for the Nazi Party's private armies, to which Friedrich Flick contributed. Kurt von Schroeder and Montagu



Norman's protégé Hilmar Schacht together made the final arrangements for Hitler to enter the government.<sup>25</sup>

Baron Rudolph von Schroeder was vice president and director of the Hamburg-Amerika Line. Long an intimate contact of Averell Harriman's in Germany, Baron Rudolph sent his grandson Baron Johann Rudolph for a tour of Prescott Bush's Brown Brothers Harriman offices in New York City in December 1932—on the eve of their Hitler-triumph.<sup>26</sup>

Certain actions taken directly by the Harriman-Bush shipping line in 1932 must be ranked among the gravest acts of treason in this century.

The U.S. Embassy in Berlin reported back to Washington that the "costly election campaigns" and "the cost of maintaining a private army of 300,000 to 400,000 men" had raised questions as to the Nazis' financial backers. The constitutional government of the German republic moved to defend national freedom by ordering the Nazi Party private armies disbanded. The U.S. Embassy reported that the Hamburg-Amerika Line was purchasing and distributing propaganda attacks against the German government, for attempting this last-minute crackdown on Hitler's forces.<sup>27</sup>

Thousands of German opponents of Hitlerism were shot or intimidated by privately armed Nazi Brown Shirts. In this connection, we note that the original "Merchant of Death," Samuel Pryor, was a founding director of both the Union Banking Corp. and the American Ship and Commerce Corp. Since Mr. Pryor was executive committee chairman of Remington Arms and a central figure in the world's private arms traffic, his use to the Hitler project was enhanced as the Bush family's partner in Nazi Party banking and trans-Atlantic shipping.

The U.S. Senate arms-traffic investigators probed Remington after it was joined in a cartel agreement on explosives to the Nazi firm I.G. Farben. Looking at the period leading up to Hitler's seizure of power, the senators found that "German political associations, like the Nazi and others, are nearly all armed with American . . . guns. . . . Arms of all kinds coming from America are transshipped in the Scheldt to river barges before the vessels arrive in Antwerp. They then can be carried through Holland without police inspection or interference. The Hitlerists and Communists are presumed to get arms in this manner. The principal arms coming from America are Thompson submachine guns and revolvers. The number is great."<sup>28</sup>

The beginning of the Hitler regime brought some bizarre changes to the Hamburg-Amerika Line—and more betrayals.

Prescott Bush's American Ship and Commerce Corp. notified Max Warburg of Hamburg, Germany, on March 7, 1933, that Warburg was to be the corporation's official, designated representative on the board of Hamburg-Amerika.<sup>29</sup>

Max Warburg replied on March 27, 1933, assuring his American sponsors that the Hitler government was good for Germany: "For the last few years business was considerably better than we had anticipated, but a reaction is making itself felt for some months. We are actually suffering also under the very active propaganda against Germany, caused by some unpleas-

ant circumstances. These occurrences were the natural consequence of the very excited election campaign, but were extraordinarily exaggerated in the foreign press. The Government is firmly resolved to maintain public peace and order in Germany, and I feel perfectly convinced in this respect that there is no cause for any alarm whatsoever."<sup>30</sup>

This seal of approval for Hitler, coming from a famous Jew, was just what Harriman and Bush required, for they anticipated rather serious "alarm" inside the U.S.A. against their Nazi operations.

On March 29, 1933, two days after Max's letter to Harriman, Max's son Erich sent a cable to his cousin Frederick M. Warburg, a director of the Harriman railroad system. He asked Frederick to "use all your influence" to stop all anti-Nazi activity in America, including "atrocious news and unfriendly propaganda in foreign press, mass meetings, etc." Frederick cabled back to Erich: "No responsible groups here [are] urging [a] boycott [of] German goods[,] merely excited individuals." Two days after that, on March 31, 1933, the American-Jewish Committee, controlled by the Warburgs, and the B'nai B'rith, heavily influenced by the Sulzbergers' (*New York Times*), issued a formal, official joint statement of the two organizations, counselling "that no American boycott against Germany be encouraged, [and advising] . . . that no further mass meetings be held or similar forms of agitation be employed."<sup>31</sup>

The American Jewish Committee and the B'nai B'rith (mother of the "Anti-Defamation League") continued with this hardline, no-attack-on-Hitler stance all through the 1930s, blunting the fight mounted by many Jews and other anti-fascists.

Thus the decisive interchange reproduced above, taking place entirely within the orbit of the Harriman/Bush firm, may explain some-

thing of the relationship of George Bush to American Jewish and Zionist leaders. Some of them, in close cooperation with his family, played an ugly part in the drama of Nazism. Is this why "professional Nazi-hunters" have never discovered how the Bush family made its money?

\*\*\*

The executive board of the Hamburg Amerika Line (Hapag) met jointly with the North German Lloyd company board in Hamburg on September 5, 1933. Under official Nazi supervision, the two firms were merged. Prescott Bush's American Ship and Commerce Corp. installed Christian J. Beck, a longtime Harriman executive, as manager of freight and operations in North America for the new joint Nazi shipping lines (Hapag-Lloyd) on November 4, 1933.

According to testimony of officials of the companies before Congress in 1934, a supervisor from the Nazi Labor Front rode with every ship of the Harriman-Bush line; employees of the New York offices were directly organized into the Nazi Labor Front organization; Hamburg-Amerika provided free passage to individuals going abroad for Nazi propaganda purposes; and the line subsidized pro-Nazi newspapers in the U.S.A., as it had done in Germany against the constitutional German government.<sup>32</sup>



In mid-1936, Prescott Bush's American Ship and Commerce Corp. cabled M.M. Warburg, asking Warburg to represent the company's heavy share interest at the forthcoming Hamburg-Amerika stockholders meeting. The Warburg office replied with the information that "we represented you" at the stockholders meeting and "exercised on your behalf your voting power for Rm [gold marks] 3,509,600 Hapag stock deposited with us."

The Warburgs transmitted a letter received from Emil Helfferich, German chief executive of both Hapag-Lloyd and of the Standard Oil subsidiary in Nazi Germany: "It is the intention to continue the relations with Mr. Harriman on the same basis as heretofore. . . ." In a colorful gesture, Hapag's Nazi chairman Helfferich sent the line's president across the Atlantic on a Zeppelin to confer with their New York string-pullers.

After the meeting with the Zeppelin passenger, the Harriman-Bush office replied: "I am glad to learn that Mr. Helfferich [sic] has stated that relations between the Hamburg American Line and ourselves will be continued on the same basis as heretofore."<sup>23</sup>

Two months before moving against Bush's Union Banking Corp., the U.S. government ordered the seizure of all property of the Hamburg-Amerika Line and North German Lloyd, under the Trading with the Enemy Act. The investigators noted in the pre-seizure report that Christian J. Beck was still acting as an attorney representing the Nazi firm.<sup>24</sup>

In May 1933, just after the Hitler regime was consolidated, an agreement was reached in Berlin for the coordination of all Nazi commerce with the U.S.A. The Harriman International Co., led by Averell Harriman's first cousin Oliver, was to head a syndicate of 150 firms and individuals, to conduct *all exports from Hitler's Germany to the United States*.<sup>25</sup>

This pact had been negotiated in Berlin between Hitler's economics minister, Hjalmar Schacht, and John Foster Dulles, international attorney for dozens of Nazi enterprises, with the counsel of Max Warburg and Kurt von Schroeder.

John Foster Dulles would later be U.S. Secretary of State, and the great power in the Republican Party of the 1950s. Foster's friendship and that of his brother Allen (head of the Central Intelligence Agency), greatly aided Prescott Bush to become the Republican U.S. senator from Connecticut. And it was to be of inestimable value to George Bush, in his ascent to the heights of "covert action government," that both of these Dulles brothers were the lawyers for the Bush family's far-flung enterprise.

Throughout the 1930s, John Foster Dulles arranged debt restructuring for German firms under a series of decrees issued by Adolf Hitler. In these deals, Dulles struck a balance between the interest owed to selected, larger investors, and the needs of the growing Nazi warmaking apparatus for producing tanks, poison gas, etc.

Dulles wrote to Prescott Bush in 1937 concerning one such arrangement. The German-Atlantic Cable Company, owning Nazi Germany's only telegraph channel to the United States, had made debt and management agreements with the Walker-Harriman bank during the 1920s. A new decree would now void those agreements, which had originally been reached

with non-Nazi corporate officials. Dulles asked Bush, who managed these affairs for Averell Harriman, to get Averell's signature on a letter to Nazi officials, agreeing to the changes. Dulles wrote: "Sept. 22, 1937

"Mr. Prescott S. Bush

"59 Wall Street, New York, N.Y.

"Dear Press,

"I have looked over the letter of the German-American [sic] Cable Company to Averell Harriman. . . . It would appear that the only rights in the matter are those which inure in the bankers and that no legal embarrassment would result, so far as the bondholders are concerned, by your acquiescence in the modification of the bankers' agreement.

"Sincerely yours,

"John Foster Dulles"

Dulles enclosed a proposed draft reply, Bush got Harriman's signature, and the changes went through.<sup>26</sup>

In conjunction with these arrangements, the German Atlantic Cable Company attempted to stop payment on its debts to smaller American bondholders. The money was to be used instead for arming the Nazi state, under a decree of the Hitler government.

Despite the busy efforts of Bush and Dulles, a New York court decided that this particular Hitler "law" was invalid in the United States; small bondholders, not parties to deals between the bankers and the Nazis, were entitled to get paid.<sup>27</sup>

In this and a few other of the attempted swindles, the intended victims came out with their money. But the Nazi financial and political reorganization went ahead to its tragic climax.

For his part in the Hitler revolution, Prescott Bush was paid a fortune.

This is the legacy he left to his son, President George Bush.

**I**t was not inevitable that millions would be slaughtered under fascism and in World War II. At certain moments of crisis, crucial pro-Nazi decisions were made outside of Germany. These decisions for pro-Nazi actions were more aggressive than the mere "appeasement" which Anglo-American historians later preferred to discuss.

Private armies of 300,000 to 400,000 terrorists aided the Nazis' rise to power. E.H. Harriman's Hamburg-Amerika line intervened against Germany's 1932 attempt to break them up.

The 1929-31 economic collapse bankrupted the Wall-Street-backed German Steel Trust. When the German government took over the Trust's stock shares, interests associated with Konrad Adenauer and the anti-Nazi Catholic Center Party attempted to acquire the shares. But the Anglo-Americans—Montagu Norman, and the Harriman-Bush bank—made sure that their Nazi puppet Fritz Thyssen regained control over the shares and the Trust. Thyssen's bankrolling of Hitler could then continue unhindered.

Unpayable debts crushed Germany in the 1920s, reparations required by the Versailles agreements. Germany was looted by the London-New York banking system, and Hitler's propaganda exploited this German debt burden.

But immediately after Germany came under Hitler's dictatorship, the Anglo-American financiers granted debt relief, which freed funds to be used for arming the Nazi state.

The North German Lloyd steamship line, which was merged with Hamburg-Amerika Line, was one of the companies which stopped debt payments under a Hitler decree arranged by John Foster Dulles and Hjalmar Schacht.

Kuhn Loeb and Co.'s Felix Warburg carried out the Hitler finance plan in New York. Kuhn Loeb asked North German Lloyd bondholders to accept new lower interest steamship bonds, issued by Kuhn Loeb, in place of the better pre-Hitler bonds.

---

## The Opposition

New York attorney Jacob Chaitkin, father of coauthor Anton Chaitkin, took the cases of many different bondholders who rejected the swindle by Harriman, Bush, Warburg, and Hitler. Representing a woman who was owed \$30 on an old steamship bond—and opposing John Foster Dulles in New York municipal court—Chaitkin got a writ from a sheriff tying up the 30,000 ton transatlantic liner *Europa* until the client received her \$30. (*New York Times*, January 10, 1934, p. 31 col. 3).

The American Jewish Congress hired Jacob Chaitkin as the legal director of the boycott against Nazi Germany. The American Federation of Labor cooperated with Jewish and other groups in the anti-import boycott. On the other side, virtually all the Nazi trade with the United States was under the supervision of the Harriman interests and functionaries such as Prescott Bush, father of President George Bush.

Meanwhile, the Warburgs demanded that American Jews not "agitate" against the Hitler government, or join the organized boycott. The Warburgs' decision was carried out by the American Jewish Committee and the *B'nai B'rith*, who opposed the boycott as the Nazi military state grew increasingly powerful.

The historical coverup on these events is so tight that virtually the only expose of the Warburgs came in journalist John L. Spivak's "Wall Street's Fascist Conspiracy," in the pro-communist *New Masses* periodical (January 29 and February 5, 1934). Spivak pointed out that the Warburgs controlled the American Jewish Committee, which opposed the anti-Nazi boycott, while their Kuhn Loeb and Co. had underwritten Nazi shipping; and he exposed the financing of pro-fascist political activities by the Warburgs and their partners and allies, many of whom were bigwigs in the American Jewish Committee and *B'nai B'rith*.

Given where the Spivak piece appeared, it is not surprising that Spivak called Warburg an ally of the Morgan Bank, but made no mention of Averell Harriman. Mr. Harriman, after all, was a permanent hero of the Soviet Union.

John L. Spivak later underwent a curious transformation, himself joining the coverup. In 1966, he wrote an autobiography which praises the American Jewish Committee. The pro-fascism of the Warburgs does not appear in the book. The former "rebel" Spivak also praises

the action arm of the *B'nai B'rith*, the *Anti-Defamation League*. Pathetically, he comments favorably that the League has spy files on the American populace which it shares with government agencies.

Thus is history erased; and those decisions, which direct history into one course or another, are lost to the knowledge of the current generation.

## 3. Race Hygiene: Three Bush Family Alliances

"The [government] must put the most modern medical means in the service of this knowledge. . . . Those who are physically and mentally unhealthy and unworthy must not perpetuate their suffering in the body of their children. . . . The prevention of the faculty and opportunity to procreate on the part of the physically degenerate and mentally sick, over a period of only 600 years, would . . . free humanity from an immeasurable misfortune."<sup>1</sup>

"The per capita income gap between the developed and the developing countries is increasing, in large part the result of higher birth rates in the poorer countries. . . . Famine in India, unwanted babies in the United States, poverty that seemed to form an unbreakable chain for millions of people—how should we tackle these problems? . . . It is quite clear that one of the major challenges of the 1970s . . . will be to curb the world's fertility."

These two quotations are alike in their mock show of concern for human suffering, and in their cynical remedy for it: Big Brother must prevent the "unworthy" or "unwanted" people from living.

Let us now further inquire into the family background of our President, so as to help illustrate how the second quoted author, George Bush<sup>1</sup> came to share the outlook of the first, Adolf Hitler.<sup>2</sup>

We shall examine here the alliance of the Bush family with three other families: Farish, Draper and Gray.

The private associations among these families have led to the President's relationship to his closest, most confidential advisers. These alliances were forged in the earlier Hitler project and its immediate aftermath. Understanding them will help us to explain George Bush's obsession with the supposed overpopulation of the world's non-Anglo-Saxons, and the dangerous means he has adopted to deal with this "problem."

## Bush and Farish

When George Bush was elected vice president in 1980, Texas mystery man William Stamps Farish III took over management of all of George Bush's personal wealth in a "blind trust." Known as one of the richest men in Texas, Will Farish keeps his business affairs under

the most intense secrecy. Only the source of his immense wealth is known, not its employment.<sup>3</sup>

Will Farish has long been Bush's closest friend and confidante. He is also the unique private host to Britain's Queen Elizabeth: Farish owns and boards the studs which mate with the Queen's mares. That is her public rationale when she comes to America and stays in Farish's house. It is a vital link in the mind of our Anglophile President.

President Bush can count on Farish not to betray the violent secrets surrounding the Bush family money. For Farish's own family fortune was made in the same Hitler project, in a nightmarish partnership with George Bush's father.

On March 25, 1942, U.S. Assistant Attorney General Thurman Arnold announced that Wil-

liam Stamps Farish (grandfather of the President's money manager) had pleaded "no contest" to charges of criminal conspiracy with the Nazis. Farish was the principal manager of a worldwide cartel between Standard Oil Co. of New Jersey and the I.G. Farben concern. The merged enterprise had opened the Auschwitz slave labor camp on June 14, 1940, to produce artificial rubber and gasoline from coal. The Hitler government supplied political opponents and Jews as the slaves, who were worked to near death and then murdered.

Arnold disclosed that Standard Oil of New Jersey (later known as Exxon), of which Farish was president and chief executive, had agreed to stop hiding from the United States patents for artificial rubber which the company had provided to the Nazis.<sup>4</sup>

A Senate investigating committee under Senator (later U.S. President) Harry Truman of Missouri had called Arnold to testify at hearings on corporations' collaboration with the Nazis. The Senators expressed outrage at the cynical way Farish was continuing an alliance with the

Hitler regime that had begun back in 1933, when Farish became chief of Jersey Standard. Didn't he know there was a war on?

The Justice Department laid before the committee a letter, written to Standard president Farish by his vice president, shortly after the beginning of World War II (September 1, 1939) in Europe. The letter concerned a renewal of their earlier agreements with the Nazis:

Report on European Trip

Oct. 12, 1939

Mr. W.S. Farish

30 Rockefeller Plaza

Dear Mr. Farish:

... I stayed in France until Sept. 17th. ... In England I met by appointment the Royal Dutch [Shell Oil Co.] gentlemen from Holland, and ... a general agreement was reached on the necessary changes in our relations with the I.G. [Farben], in view of the state of war. ... [T]he Royal Dutch Shell group is essentially British. ... I also had several meetings with ... the [British] Air Ministry. ...

I required help to obtain the necessary permission to go to Holland. ... After discussions with the [American] Ambassador [Joseph Kennedy] ... the situation was cleared completely. ... The gentlemen in the Air Ministry ... very kindly offered to assist me [later] in reentering England. ...

Pursuant to these arrangements, I was able to keep my appointments in Holland [having flown there on a British Royal Air Force bomber], where I had three days of discussion with the representatives of I.G. They delivered to me assignments of some 2,000 foreign patents and *we did our best to work out complete plans for a modus vivendi which could operate through the term of the war, whether or not the U.S. came in.* ... [emphasis added]

Very truly yours, F[rank] A. Howard<sup>5</sup>

Here are some cold realities behind the tragedy of World War II, which help explain the Bush-Farish family alliance—and their peculiar closeness to the Queen of England:

- Shell Oil is principally owned by the British Royal family. Shell's chairman, Sir Henri Deterding, helped sponsor Hitler's rise to power,<sup>6</sup> by arrangement with the Royal Family's Bank of England Governor, Montagu Norman. Their ally, Standard Oil, would take part in the Hitler project right up to the bloody, gruesome end.

- When grandfather Farish signed the Justice Department's consent decree in March 1942, the government had already started picking its way through the tangled web of world-monopoly oil and chemical agreements between Standard Oil and the Nazis. Many patents and other Nazi-owned aspects of the partnership had been seized by the U.S. Alien Property Custodian.

Uncle Sam would not seize Prescott Bush's Union Banking Corporation for another seven months.

The Bush-Farish axis had begun back in 1929. In that year, the Harriman bank bought Dresser Industries, supplier of oil-pipeline couplers to Standard and other companies. Prescott Bush became a director and financial czar of Dresser, installing his Yale classmate Neil Mallon as chairman.<sup>7</sup> George Bush would later name one of his sons after the Dresser executive.

William S. Farish was the main organizer of the Humble Oil Co. of Texas, which Farish merged into the Standard Oil Company of New Jersey. Farish built up the Humble-Standard empire of pipelines and refineries in Texas.<sup>8</sup>

The stock market crashed just after the Bush family got into the oil business. The world financial crisis led to the merger of the Walker-Harriman bank with Brown Brothers in 1931. Former Brown partner Montagu Norman and his protege Hjalmar Schacht, who was to become Hitler's economics minister, paid frantic

**“Farish was hauled before the Senate committee investigating the national defense program. The committee chairman, Senator Harry Truman, told newsmen before Farish testified: ‘I think this approaches treason.’”**

visits to New York that year and the next, preparing the new Hitler regime for Germany.

## The Congress on Eugenics

The most important American political event in those preparations for Hitler was the infamous Third International Congress on Eugenics, held at New York's American Museum of Natural History August 21-23, 1932, supervised by the International Federation of Eugenics Societies.<sup>9</sup> This meeting took up the stubborn persistence of African-Americans and other allegedly "inferior" and "socially inadequate" groups in reproducing, expanding their numbers, and "amalgamating" with others. It was recommended that these "dangers" to the "better" ethnic groups and to the "well-born," could be dealt with by sterilization or "cutting off the bad stock" of the "unfit."

Italy's fascist government sent an official representative. Averell Harriman's sister Mary, director of "entertainment" for the Congress, lived down in Virginia fox-hunting country; her state supplied the speaker on "racial purity," W.A. Plecker, Virginia commissioner of vital statistics. Plecker reportedly held the delegates spellbound with his account of the struggle to stop race-mixing and interracial sex in Virginia.

The Congress proceedings were dedicated to Averell Harriman's mother; she had paid for the founding of the race-science movement in America back in 1910, building the Eugenics Record Office as a branch of the Galton National Laboratory in London. She and other Harrimans were usually escorted to the horse races by old George Herbert Walker—they shared with the Bushes and the Farishes a fascination with "breeding thoroughbreds" among horses and humans.<sup>10</sup>

Averell Harriman personally arranged with the Walker/Bush Hamburg-Amerika Line to transport Nazi ideologues from Germany to New York for this meeting.<sup>11</sup> The most famous among those transported was Dr. Ernst Rudin, psychiatrist at the Kaiser Wilhelm Institute for Genealogy and Demography in Berlin, where the Rockefeller family paid for Dr. Rudin to occupy an entire floor with his eugenics "research." Dr. Rudin had addressed the International Federation's 1928 Munich meeting, speaking on "Mental Aberration and Race Hygiene," while others (Germans and Americans) spoke on race-mixing and sterilization of the unfit. Rudin had led the German delegation to the 1930 Mental Hygiene Congress in Washington, D.C.

At the Harrimans' 1932 New York Eugenics Congress, Ernst Rudin was unanimously elected President of the International Federation of Eugenics Societies. This was recognition of Rudin as founder of the German Society for Race Hygiene, with his co-founder, Eugenics Federation vice president Alfred Ploetz.

As depression-maddened financiers schemed in Berlin and New York, Rudin was now official leader of the world eugenics movement. Components of his movement included groups with overlapping leadership, dedicated to:

- sterilization of mental patients ("mental hygiene societies");
- execution of the insane, criminals and the terminally ill ("euthanasia societies"); and
- eugenical race-purification by prevention of births to parents from inferior blood stocks ("birth control societies").

Before the Auschwitz death camp became a household word, these British-American-European groups called openly for the elimination of the "unfit" by means including force and violence.<sup>12</sup>

Ten months later, in June 1933, Hitler's interior minister Wilhelm Frick spoke to a eugenics meeting in the new Third Reich. Frick called the Germans a "degenerate" race, denouncing one-fifth of Germany's parents for producing "feeble-minded" and "defective" children. The following month, on a commission by Frick, Dr. Ernst Rudin wrote the "Law for the Prevention of Hereditary Diseases in Posterity," the sterilization law modeled on previous U.S. statutes in Virginia and other states.

Special courts were soon established for the sterilization of German mental patients, the blind, the deaf, and alcoholics. A quarter million people in these categories were sterilized. Rudin, Ploetz, and their colleagues trained a whole generation of physicians and psychiatrists—as sterilizers and as killers.

When the war started, the eugenicists, doctors, and psychiatrists staffed the new "T4" agency, which planned and supervised the mass killings: first at "euthanasia centers," where the same categories which had first been subject to sterilization were now to be murdered, their brains sent in lots of 200 to experimental psychiatrists; then at slave camps such as Auschwitz; and finally, for Jews and other race victims, at straight extermination camps in Poland, such as Treblinka and Belsen.<sup>13</sup>

In 1933, as what Hitler called his "New Order" appeared, John D. Rockefeller, Jr. appointed William S. Farish the chairman of Standard Oil Co. of New Jersey (in 1937 he was made president and chief executive). Farish moved his offices to Rockefeller Center, New York, where he spent a good deal of time with Hermann Schmitz, chairman of I.G. Farben; his company paid a publicity man, Ivy Lee, to write pro-I.G. Farben and pro-Nazi propaganda and get it into the U.S. press.

Now that he was outside of Texas, Farish found himself in the shipping business—like the Bush family. He hired Nazi German crews for Standard Oil tankers. And he hired Emil Helfferich, chairman of the Walker/Bush/Harriman Hamburg-Amerika Line, as chairman also of the Standard Oil Company subsidiary in Germany. Karl Lindemann, board member of Hamburg-Amerika, also became a top Farish-Standard executive in Germany.<sup>14</sup>

This interlock between their Nazi German operations put Farish together with Prescott Bush in a small, select group of men operating from abroad through Hitler's "revolution," and calculating that they would never be punished.

In 1939, Farish's daughter Martha married Averell Harriman's nephew, Edward Harriman Gerry, and Farish in-laws became Prescott Bush's partners at 59 Broadway.<sup>15</sup>

Both Emil Helfferich and Karl Lindemann were authorized to write checks to Heinrich Himmler, chief of the Nazi SS, on a special Standard Oil account. This account was managed by the German-British-American banker, Kurt von Schroeder. According to U.S. intelligence documents reviewed by author Anthony Sutton, Helfferich continued his payments to the SS into 1944, when the SS was supervising the mass murder at the Standard-I.G. Farben Auschwitz and other death camps. Helfferich told Allied interrogators after the war that these were not his personal contributions—they were corporate Standard Oil funds.<sup>16</sup>

After pleading "no contest" to charges of criminal conspiracy with the Nazis, William Stamps Farish was fined \$5,000. (Similar fines were levied against Standard Oil—\$5,000 each for the parent company and for several subsidiaries.) This of course did not interfere with the millions of dollars that Farish had acquired in conjunction with Hitler's New Order, as a large stockholder, chairman, and president of Standard Oil. All the government sought was the use of patents which his company had given to the Nazis—the Auschwitz patents—but had withheld from the U.S. military and industry.

But a war was on, and if young men were to be asked to die fighting Hitler . . . something more was needed. Farish was hauled before the Senate committee investigating the national defense program. The committee chairman, Senator Harry Truman, told newsmen before Farish testified: "I think this approaches treason."<sup>17</sup>

Farish began breaking apart at these hearings. He shouted his "indignation" at the senators, and claimed he was not "disloyal."

After the March-April hearings ended, more dirt came gushing out of the Justice Department and the Congress on Farish and Standard Oil. Farish had deceived the U.S. Navy to prevent the Navy from acquiring certain patents, while supplying them to the Nazi war machine; meanwhile, he was supplying gasoline and tetraethyl lead to Germany's submarines and air force. Communications between Standard and I.G. Farben from the outbreak of World War II were released to the Senate, showing that Farish's organization had arranged to deceive the U.S. government into passing over Nazi-owned assets: They would nominally buy I.G.'s share in certain patents because "in the event of war between ourselves and Germany . . . it would certainly be very undesirable to have this 20 percent Standard-I.G. pass to an alien property custodian of the U.S. who might sell it to an unfriendly interest."<sup>18</sup>

John D. Rockefeller, Jr. (father of David, Nelson, and John D. Rockefeller III), the controlling owner of Standard Oil, told the Roosevelt administration that he knew nothing of the day-to-day affairs of his company, that all these matters were handled by Farish and other executives.<sup>19</sup>

In August, Farish was brought back for more testimony. He was now frequently accused of lying. Farish was crushed under the intense, public grilling; he became morose, ashen. While Prescott Bush escaped publicity when the government seized his Nazi banking organization in October, Farish had been nailed. He collapsed and died of a heart attack on November 29, 1942.

The Farish family was devastated by the exposure. Son William Stamps Farish, Jr., a lieutenant in the Army Air Force, was humiliated by the public knowledge that his father was fueling the enemy's aircraft; he died in a training accident in Texas six months later.<sup>20</sup>

With this double death, the fortune comprising much of Standard Oil's profits from Texas and Nazi Germany was now to be settled upon the little four-year-old grandson, William ("Will") Stamps Farish III. Will Farish grew up a recluse, the most secretive multimillionaire in Texas, with investments of "that money" in a multitude of foreign countries, and a host of exotic contacts overlapping the intelligence and financial worlds—particularly in Britain.

The Bush-Farish axis started George Bush's career. After his 1948 graduation from Yale (and the Skull and Bones secret society), George Bush flew down to Texas on a corporate jet and was employed by his father's Dresser Industries. In a couple of years he got help from his uncle, George Walker, Jr., and Farish's British banker friends, to set him up in the oil property speculation business. Soon thereafter, George Bush founded the Zapata Oil Company, which put oil drilling rigs into certain locations of great strategic interest to the Anglo-American intelligence community.

Twenty-five-year-old Will Farish was personal aide to Zapata chairman George Bush in Bush's unsuccessful 1964 campaign for Senate. Farish used "that Auschwitz money" to back George Bush financially, investing in Zapata. When Bush was elected to Congress in 1966, Farish joined the Zapata board.<sup>21</sup>

When George Bush became U.S. vice president in 1980, the Farish and Bush family fortunes were again completely, secretly commingled. As we shall see, the old projects were now being revived on a breathtaking scale.

---

## Bush and Draper

Twenty years before he was U.S. President, George Bush brought two "race-science" professors in front of the Republican Task Force on Earth Resources and Population. As chairman of the Task Force, then-Congressman Bush invited Professors William Shockley and Arthur Jensen to explain to the committee how allegedly runaway birth-rates for African-Americans were "down-breeding" the American population.

Afterwards, Bush personally summed up for the Congress the testimony his black-inferiority advocates had given to the Task Force.<sup>22</sup> George Bush held his hearings on the threat posed by black babies on August 5, 1969, while much of the world was in a better frame of mind—celebrating mankind's progress from the first moon landing 16 days earlier. Bush's obsessive thinking on this subject was guided by his family's friend, Gen. William H. Draper, Jr., the founder and chairman of the Population Crisis Committee, and vice chairman of the Planned Parenthood Federation. Draper had long been steering U.S. public discussion about the so-called "population bomb" in the non-white areas of the world.

If Congressman Bush had explained to his

colleagues how his family had come to know General Draper, they would perhaps have felt some alarm, or even panic, and paid more healthy attention to Bush's presentation. Unfortunately, the Draper-Bush population doctrine is now official U.S. foreign policy.

William H. Draper, Jr. had joined the Bush team in 1927, when he was hired by Dillon Read & Co., New York investment bankers. Draper was put into a new job slot at the firm: handling the Thyssen account.

We recall that in 1924, Fritz Thyssen set up his Union Banking Corporation in George Herbert Walker's bank at 39 Broadway, Manhattan. Dillon Read & Co.'s boss, Clarence Dillon, had begun working with Fritz Thyssen some time after Averell Harriman first met with Thyssen—at about the time Thyssen began financing Adolf Hitler's political career.

In January 1926, Dillon Read created the *German Credit and Investment Corporation* in Newark, New Jersey and Berlin, Germany, as Thyssen's short-term banker. That same year, Dillon Read created the *Vereinigte Stahlwerke* (German Steel Trust), incorporating the Thyssen family interests under the direction of New York and London finance.<sup>23</sup>

William H. Draper, Jr. was made director, vice president, and assistant treasurer of the German Credit and Investment Corp. His business was short-term loans and financial management tricks for Thyssen and the German Steel Trust. Draper's clients sponsored Hitler's terroristic takeover; his clients led the buildup of the Nazi war industry; his clients made war against the United States. The Nazis were Draper's direct partners in Berlin and New Jersey: Alexander Kreuter, residing in Berlin, was president; Frederic Brandt, whose father was a top coal executive in the German Steel Trust, moved to the United States in 1926 and served as Draper's co-director in Newark.

Draper's role was crucial for Dillon Read & Co., for whom Draper was a partner and eventually vice president. The German Credit and Investment Corp. (GCI) was a "front" for Dillon Read: It had the same New Jersey address as U.S. & International Securities Corp. (USIS), and the same man served as treasurer of both firms.<sup>24</sup>

Clarence Dillon and his son C. Douglas Dillon were directors of USIS, which was spotlighted when Clarence Dillon was hauled before the Senate Banking Committee's famous "Pecora" hearings in 1933. USIS was shown to be one of the great speculative pyramid schemes which had swindled stockholders of hundreds of millions of dollars. These investment policies had rotted the U.S. economy to the core, and led to the Great Depression of the 1930s.

But William H. Draper, Jr.'s GCI "front" was not apparently affiliated with the USIS "front" or with Dillon, and the GCI escaped the congressmen's limited scrutiny. This oversight was to prove most unfortunate, particularly to the 50 million people who subsequently died in World War II.

Dillon Read hired public relations man Ivy Lee to prepare their executives for their testimony and to confuse and further baffle the congressmen.<sup>25</sup> Lee apparently took enough time out from his duties as image-maker for William

S. Farish and the Nazi I.G. Farben Co.; he managed the congressional thinking so that the congressmen did not disturb the Draper operation in Germany—and did not meddle with Thyssen, or interfere with Hitler's U.S. moneymen.

Thus, in 1932, William H. Draper, Jr. was free to finance the International Eugenics Congress as a "Supporting Member."<sup>26</sup> Was he using his own income as a Thyssen trust banker? Or did the funds come from Dillon Read corporate accounts, perhaps to be written off income tax as "expenses for German project: race purification"? Draper helped select Ernst Rudin as chief of the world eugenics movement, who used his office to promote what he called Adolf Hitler's "holy, national and international racial hygienic mission."<sup>27</sup>

W.S. Farish was publicly exposed in 1942, humiliated and destroyed. Just before Farish died, Prescott Bush's Nazi banking office was quietly seized and shut down. But Prescott's close friend and partner in the Thyssen-Hitler business, William H. Draper, Jr., *neither died nor moved out of German affairs*. Draper listed himself as a director of the German Credit and Investment Corp. through 1942, and the firm was not liquidated until November 1943.<sup>28</sup> But a war was on. Draper, a colonel from previous military service, went off to the Pacific theater and became a general.

General Draper apparently had a hobby: magic—illusions, sleight of hand, etc.—and he was a member of the Society of American Magicians. This is not irrelevant to his subsequent career.

The Nazi regime surrendered in May 1945. In July 1945, General Draper was called to Europe by the American military government authorities in Germany. Draper was appointed head of the Economics Division of the U.S. Control Commission. He was assigned to take apart the Nazi corporate cartels. There is an astonishing but perfectly logical rationale to this—Draper knew a lot about the subject! General Draper, who had spent about 15 years financing and managing the dirtiest of the Nazi enterprises, was now authorized to decide *who was exposed, who lost and who kept his business, and in practical effect, who was prosecuted for war crimes.*<sup>29</sup>

(Draper was not unique within the postwar occupation government. Consider the case of John J. McCloy, U.S. Military Governor and High Commissioner of Germany, 1949-1952. Under instructions from his Wall Street law firm, McCloy had lived for a year in Italy, serving as an adviser to the fascist government of Benito Mussolini. An intimate collaborator of the Harriman/Bush bank, McCloy had sat in Adolf Hitler's box at the 1936 Olympic games in Berlin, at the invitation of Nazi chieftains Rudolf Hess and Hermann Goering.)<sup>30</sup>

William H. Draper, Jr., as a "conservative" was paired with the "liberal" U.S. Treasury Secretary Henry Morgenthau in a vicious game. Morgenthau demanded that Germany be utterly destroyed as a nation, that its industry be dismantled and it be reduced to a purely rural country. As the economic boss in 1945 and 1946, Draper "protected" Germany from the Morgenthau Plan... but at a price.

Draper and his colleagues demanded that Germany and the world accept the *collective guilt of the German people as the explanation for*



the rise of Hitler's New Order, and the Nazi war crimes. This, of course, was rather convenient for General Draper himself, as it was for the Bush family. It is still convenient decades later, allowing Prescott's son, President Bush, to lecture Germany on the danger of Hitlerism. Germans are too slow, it seems, to accept his New World Order.

After several years of government service (often working directly for Averell Harriman in the North Atlantic Alliance), Draper was appointed in 1958 chairman of a committee which was to advise President Dwight Eisenhower on the proper course for U.S. military aid to other countries. At that time, Prescott Bush was a U.S. senator from Connecticut, a confidential friend and golf partner with National Security Director Gordon Gray, and an important golf partner with Dwight Eisenhower as well. Prescott's old lawyer from the Nazi days, John Foster Dulles, was Secretary of State, and his brother Allen Dulles, formerly of the Schroder bank, was head of the CIA.

This friendly environment emboldened our General Draper to pull off a stunt with his military aid advisory committee. He changed the subject under study. The following year, the Draper committee recommended that the U.S. government react to the supposed threat of the "population explosion" by formulating plans to depopulate the poorer countries. The growth of the world's non-white population, he proposed, should be regarded as dangerous to the national security of the United States!<sup>31</sup>

President Eisenhower rejected the recommendation. But in the next decade, General Draper founded the "Population Crisis Committee" and the "Draper Fund," joining with the Rockefeller and DuPont families to promote eugenics as "population control." The administration of President Lyndon Johnson, advised by Draper on the subject, began financing birth control in the tropical countries through the Agency for International Development.

General William Draper was George Bush's guru on the population question.<sup>32</sup> But there was also Draper's money—from that uniquely horrible source—and Draper's connections on Wall Street and abroad. Draper's son and heir, William H. Draper III, was co-chairman for finance (chief of fundraising) of the Bush-for-President national campaign organization in 1980. With George Bush in the White House, the younger Draper heads up the depopulation activities of the United Nations throughout the world.

Draper was vice president of Dillon Read until 1953. During the 1950s and 1960s, the chief executive there was Frederic Brandt, the German who was Draper's co-director for the Nazi investments and his personal contact man with the Nazi Steel Trust. Nicholas Brady was Brandt's partner from 1954, and replaced him as the firm's chief executive in 1971. Nicholas Brady, who knows where all the bodies are buried, was chairman of his friend George Bush's 1980 election campaign in New Jersey, and has been United States Treasury Secretary throughout Bush's presidency.<sup>33</sup>

## Bush and Grey

The U.S. Agency for International Development (USAID) says that surgical sterilization is the Bush administration's "first choice" method of population reduction in the Third World.<sup>34</sup>

The United Nations Population Fund claims that 37 percent of contraception users in Ibero-America and the Caribbean have already been surgically sterilized. In a 1991 report, William H. Draper III's U.N. agency asserts that 254 million couples will be surgically sterilized over the course of the 1990s; and that if present trends continue, 80 percent of the women in Puerto Rico and Panama will be surgically sterilized.<sup>35</sup>

The U.S. government pays directly for these sterilizations.

Mexico is first among targeted nations, on a list which was drawn up in July 1991, at a USAID strategy session. India and Brazil are second and third priorities, respectively.

On contract with the Bush administration, U.S. personnel are working from bases in Mexico to perform surgery on millions of Mexican men and women. The acknowledged strategy in this program is to sterilize those young adults who have not already completed their families.

George Bush has a rather deep-seated personal feeling about this project, in particular as it pits him against Pope John Paul II in Catholic countries such as Mexico. (See Chapter 4 below, on the origin of a Bush-family grudge in this regard.)

The spending for birth control in the non-white countries is one of the few items that is headed upwards in the Bush administration budget. As its 1992 budget was being set, USAID said its Population Account would receive \$300 million, a 20 percent increase over the previous year. Within this project, a significant sum is spent on political and psychological manipulations of target nations, and rather blatant subversion of their religions and governments.<sup>36</sup>

These activities might be expected to cause serious objections from the victimized nationalities, or from U.S. taxpayers, especially if the program is somehow given widespread publicity.

Quite aside from moral considerations, legal questions would naturally arise, which could be summed up: **How does George Bush think he can get away with this?**

In this matter the President has expert advice. Mr. (Clayland) Boyden Gray has been counsel to George Bush since the 1980 election. As chief legal officer in the White House, Boyden Gray can walk the President through the dangers and complexities of waging such unusual warfare against Third World populations. Gray knows how these things are done.

When Boyden Gray was four and five years old, his father organized the pilot project for the present worldwide sterilization program, from the Gray family household in North Carolina.

It started in 1946. The eugenics movement was looking for a way to begin again in America.

**“When Boyden Gray was four and five years old, his father organized the pilot project for the present worldwide sterilization program, from the Gray family household in North Carolina.”**



C. Boyden Gray, chief counsel to President Bush, ecology kook, and opponent of civil rights. His family sterilized North Carolina school children, a pilot project for current worldwide sterilization of nonwhites.

**“All children enrolled in the school district of Winston-Salem, N.C., were given a special ‘intelligence test.’ Those children who scored below a certain arbitrary low mark were then cut open and surgically sterilized.”**

Nazi death camps such as Auschwitz had just then seared the conscience of the world. The Sterilization League of America, which had changed its name during the war to “Birthright, Inc.,” wanted to start up again. First they had to overcome public nervousness about crackpots proposing to eliminate “inferior” and “defective” people. The League tried to surface in Iowa, but had to back off because of negative publicity: a little boy had recently been sterilized there and had died from the operation.

They decided on North Carolina, where the Gray family could play the perfect host.<sup>37</sup> Through British imperial contacts, Boyden Gray’s grandfather Bowman Gray had become principal owner of the R.J. Reynolds Tobacco Co. Boyden’s father, Gordon Gray, had recently founded the Bowman Gray (memorial) Medical School in Winston-Salem, using his inherited cigarette stock shares. The medical school was already a eugenics center.

As the experiment began, Gordon Gray’s great aunt, Alice Shelton Gray, who had raised him from childhood, was living in his household. Aunt Alice had founded the “Human Betterment League,” the North Carolina branch of the national eugenical sterilization movement.

Aunt Alice was the official supervisor of the 1946-47 experiment. Working under Miss Gray was Dr. Claude Nash Herndon, whom Gordon Gray had made assistant professor of “medical genetics” at Bowman Gray medical school.

Dr. Clarence Gamble, heir to the Proctor and Gamble soap fortune, was the sterilizers’ national field operations chief.

The experiment worked as follows. All children enrolled in the school district of Winston-Salem, N.C., were given a special “intelligence test.” Those children who scored below a certain arbitrary low mark were then cut open and surgically sterilized.

We quote now from the official story of the project: “In Winston-Salem and in [nearby] Orange County, North Carolina, the [Sterilization League’s] field committee had participated in testing projects to identify school age children

who should be considered for sterilization. The project in Orange County was conducted by the University of North Carolina and was financed by a ‘Mr. Hanes,’ a friend of Clarence Gamble and supporter of the field work project in North Carolina. The Winston-Salem project was also financed by Hanes. [“Hanes” was underwear mogul James Gordon Hanes, a trustee of Bowman Gray Medical School and treasurer of Alice Gray’s group]. . .

“The medical school had a long history of interest in eugenics and had compiled extensive histories of families carrying inheritable disease. In 1946, Dr. C. Nash Herndon . . . made a statement to the press on the use of sterilization to prevent the spread of inheritable diseases. . . .

“The first step after giving the mental tests to grade school children was to interpret and make public the results. In Orange County the results indicated that three percent of the school age children were either insane or feeble-minded. . . . [Then] the field committee hired a social worker to review each case . . . and to present any cases in which sterilization was indicated to the State Eugenics Board, which under North Carolina law had the authority to order sterilization. . . .”

Race science experimenter Dr. Claude Nash Herndon provided more details in an interview in 1990.<sup>38</sup>

“Alice Gray was the general supervisor of the project. She and Hanes sent out letters promoting the program to the commissioners of all 100 counties in North Carolina. . . . What did I do? Nothing besides riding herd on the whole thing! The social workers operated out of my office. I was at the time also director of outpatient services at North Carolina Baptist Hospital. We would see the [targeted] parents and children there. . . . I.Q. tests were run on all the children in the Winston-Salem public school system. Only the ones who scored really low [were targeted for sterilization], the real bottom of the barrel, like below 70.

“Did we do sterilizations on young children? Yes. This was a relatively minor operation. . . .



It was usually not until the child was eight or ten years old. For the boys, you just make an incision and tie the tube. . . . We more often performed the operation on girls than with boys. Of course, you have to cut open the abdomen, but again, it is relatively minor."

Dr. Herndon remarked coolly that "we had a very good relationship with the press" for the project. This is not surprising, since Gordon Gray owned the *Winston-Salem Journal*, the *Twin City Sentinel*, and radio station WSJS.

In 1950 and 1951, John Foster Dulles, then chairman of the Rockefeller Foundation, led John D. Rockefeller III on a series of world tours, focusing on the need to stop the expansion of the non-white populations. In November 1952, Dulles and Rockefeller set up the Population Council, with tens of millions of dollars from the Rockefeller family.

At that point, the American Eugenics Society, still cautious from the recent bad publicity vis-a-vis Hitler, left its old headquarters at Yale University. The Society moved its headquarters into the office of the Population Council, and the two groups melded together. The long-time secretary of the Eugenics Society, Frederick Osborne, became the first president of the Population Council. The Gray family's child-sterilizer, Dr. C. Nash Herndon, became president of the American Eugenics Society in 1953, as its work expanded under Rockefeller patronage.

Meanwhile, the International Planned Parenthood Federation was founded in London, in the offices of the British Eugenics Society.

The undead enemy from World War II, renamed "Population Control," had now been revived.

George Bush was U.S. ambassador to the United Nations in 1972, when with prodding from Bush and his friends, the United States Agency for International Development first made an official contract with the old Sterilization League of America. The league had changed its name twice again, and was now called the "Association for Voluntary Surgical Contraception." The U.S. government began paying the old fascist group to sterilize non-whites in foreign countries.

The Gray family experiment had succeeded.

In 1988, the U.S. Agency for International Development signed its latest contract with the old Sterilization League (a.k.a. "Association for Voluntary Sterilization"), committing the U.S. government to spend \$80 million over five years.

Having gotten away with sterilizing several hundred North Carolina school children, "not usually less than eight to ten years old," the identical group is now authorized by President Bush to do it to 58 countries in Asia, Africa, and Ibero-America. The group modestly claims it has directly sterilized only 2 million people, with 87 percent of the bill paid by U.S. taxpayers.

Meanwhile, Dr. Clarence Gamble, Boyden Gray's favorite soap manufacturer, formed his own "Pathfinder Fund" as a split-off from the Sterilization League. Gamble's Pathfinder Fund, with additional millions from USAID, concentrates on penetration of local social groups in the non-white countries, to break down psychological resistance to the surgical sterilization teams.

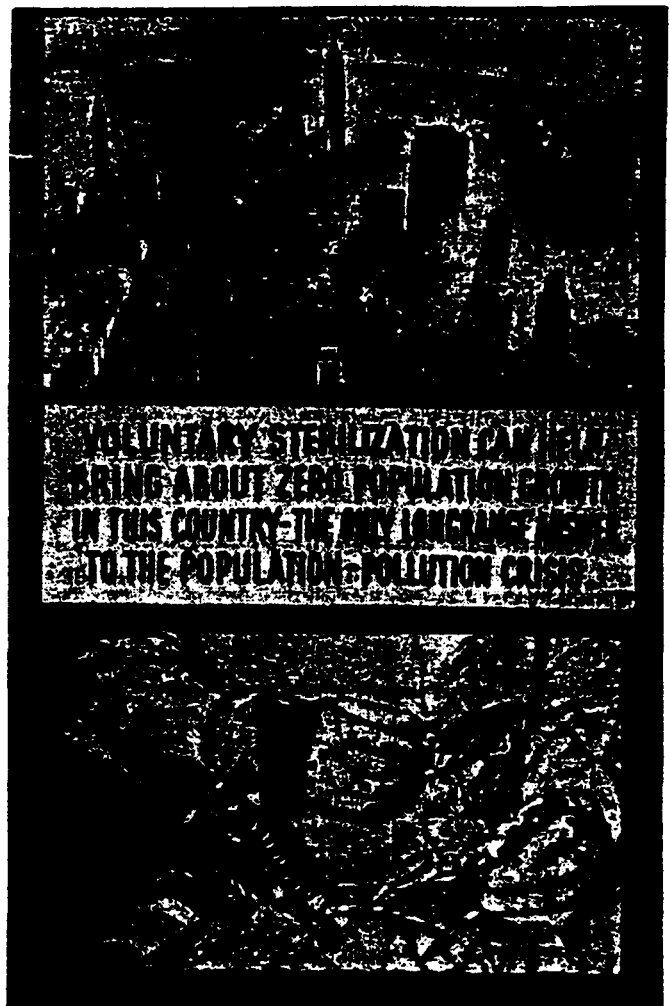

A poster of the Association for Voluntary Sterilization (formerly the "Sterilization League"). The U.S. government now pays this group from the Nazi era to sterilize nonwhites overseas.

#### Notes

1. Phyllis Tilson Piotrow, *World Population Crisis: The United States Response* (New York: Praeger Publishers, 1973), "Forward" by George H.W. Bush, pp. vii-viii.
2. Adolf Hitler, *Mein Kampf* (Boston, Houghton Mifflin Company, 1971), p. 404.
3. "The Ten Richest People in Houston," in *Houston Post Magazine*, March 11, 1984. "\$150 million to \$250 million from . . . inheritance, plus subsequent investments . . . chief heir to a family fortune in oil stock. . . . As to his financial interests, he is . . . coy. He once described one of his businesses as a company that 'invests in and oversees a lot of smaller companies . . . in a lot of foreign countries.'"
4. The announcements were made in testimony before a Special Committee of the U.S. Senate Investigating the National Defense Program. The hearings on Standard Oil were held March 5, 24, 26, 27, 31, and April 1, 2, 3 and 7, 1942. Available on microfiche, law section, Library of Congress. See also *New York Times*, March 26 and March 27, 1942, and *Washington Evening Star*, March 26 and March 27, 1942.
5. *Ibid.*, Exhibit No. 368, printed on pp. 4584-87 of the hearing record. See also Charles Higham, *Trading With The Enemy* (New York: Delacorte Press, 1983), p. 36.
6. Confidential memorandum from U.S. Embassy, Berlin, *op. cit.*, chapter 2. Sir Henri Deterding was among the most notorious pro-Nazis of the early war period.
7. See sections on Prescott Bush in Darwin Payne, *Initiative in Energy: Dresser Industries, Inc.* (New York: Distributed by Simon and Schuster, 1979) (published by the Dresser Company).
8. William Stamps Farish obituary, *New York Times*, Nov. 30, 1942.

9. *A Decade of Progress in Eugenics: Scientific Papers of the Third International Congress of Eugenics held at American Museum of Natural History New York, August 21-23, 1932.* (Baltimore: Williams & Wilkins Company, September, 1934).

The term "eugenics" is taken from the Greek to signify "good birth" or "well-born," as in aristocrat. Its basic assumption is that those who are not "well-born" should not exist.

10. See among other such letters, George Herbert Walker, 39 Broadway, N.Y., to W. A. Harriman, London, February 21, 1925, in W.A. Harriman papers.

11.

Averell Harriman to Dr. Charles B. Davenport, President, The International Congress of Eugenics, Cold Spring Harbor, L.I., N.Y.:

January 21, 1932

Dear Dr. Davenport:

I will be only too glad to put you in touch with the Hamburg-American Line . . . they may be able to co-operate in making suggestions which will keep the expenses to a minimum. I have referred your letter to Mr. Emil Lederer [of the Hamburg-Amerika executive board in New York] with the request that he communicate with you.

Charles B. Davenport to W.A. Harriman, 59 Wall Street, New York, N.Y.

January 23, 1932

Dear Mr. Harriman:

Thank you very much for your kind letter of January 21st and the action you took which has resulted at once in a letter from Mr. Emil Lederer. This letter will serve as a starting point for correspondence, which I hope will enable more of our German colleagues to come to America on the occasion of the congresses of eugenics and genetics, than otherwise.

Congressional hearings in 1934 established that Hamburg-Amerika routinely provided free transatlantic passage for those carrying out Nazi propaganda chores. See *Investigation of Nazi Propaganda Activities and Investigation of Certain Other Propaganda Activities*, op. cit., chapter 2.

12. Alexis Carrel, *Man the Unknown* (New York: Halcyon House, published by arrangement with Harper & Brothers, 1935), pp. 318-19.

The battle cry of the New Order was sounded in 1935 with the publication of *Man the Unknown*, by Dr. Alexis Carrel of the Rockefeller Institute in New York. This Nobel Prize-winner said "enormous sums are now required to maintain prisons and insane asylums . . . Why do we preserve these useless and harmful beings? This fact must be squarely faced. Why should society not dispose of the criminals and the insane in a more economical manner? . . . The community must be protected against troublesome and dangerous elements. . . Perhaps prisons should be abolished. . . The conditioning of the petty criminal with the whip, or some more scientific procedure, followed by a short stay in hospital, would probably suffice to insure order. [Criminals, including those] who have . . . misled the public on important matters, should be humanely and economically disposed of in small euthanasic institutions supplied with proper gases. A similar treatment could be advantageously applied to the insane, guilty of criminal acts."

Carrel claimed to have transplanted the head of a dog to another dog and kept it alive for quite some time.

13. Bernhard Schreiber, *The Men Behind Hitler: A German Warning to the World*, France: La Hay-Mureaux, ca. 1975), English language edition supplied by H. & P. Tadeusz, 369 Edgewere Road; London W2. A copy of this book is now held by Union College Library, Syracuse, N.Y.

14. Higham, op. cit., p. 35.

15. Engagement announced Feb. 10, 1939, *New York Times*, p. 20. See also *Directory of Directors for New York City, 1930s and 1940s*.

16. Higham, op. cit., pp. 20, 22 and other references to Schroeder and Lindemann.

Anthony Sutton, *Wall Street and the Rise of Hitler* (Seal Beach: '76 Press, 1976). Sutton is also a good source on the Harrimans.

17. *Washington Evening Star*, March 27, 1942, p. 1.

18. Higham, op. cit. p. 50.

19. *Ibid.*, p. 48.

20. *Washington Post*, April 29, 1960, p. F4. Higham, op. cit., pp. 52-53.

21. Zapata annual reports, 1950s-1960s, Library of Congress microforms.

22. See *Congressional Record* for Bush speech in the House of Representatives, Sept. 4, 1969. Bush inserted in the record the testimony given before his Task Force on August 5, 1969.

23. Sobel, op. cit., pp. 92-111. See also Boyle, op. cit., chapter 1, concerning the Morgan-led Dawes Committee of Germany's foreign creditors.

Like Harriman, Dillon used the Schroeder and Warburg banks to strike his German bargains. All Dillon Read & Co. affairs in Germany were supervised by J.P. Morgan & Co. partner Thomas Lamont, and were authorized by Bank of England Governor Montagu Norman.

24. See *Poor's Register of Directors and Executives*, (New York: Poor's Publishing Company, late 1920s, '30s and '40s). See also *Standard Corporation Records* (New York: Standard & Poor), 1935 edition pp. 2571-25, and 1938 edition pp. 7436-38, for description and history of the German Credit and Investment Corporation. For Frederic Brandt, See also Sobel, op. cit., p. 213-214.

25. Sobel, op. cit., pp. 180, 188. Ivy Lee had been hired to improve the Rockefeller family image, particularly difficult after their 1914 massacre of striking miners and pregnant women in Ludlow, Colorado. Lee got old John D. Rockefeller to pass out dimes to poor people lined up at his porch.

26. Third International Eugenics Congress papers op. cit., footnote 7, p. 512, "Supporting Members."

27. Schreiber, op. cit., p. 160. The Third Int. Eugenics Congress papers, p. 526, lists the officers of the International Federation as of publication date in September, 1934. Rudin is listed as president—a year after he has written the sterilization law for Hitler.

28. *Directory of Directors for New York City, 1942*. Interview with Nancy Bowles, librarian of Dillon Read & Co.

29. Higham, op. cit., p. 129, 212-15, 219-23.

30. Walter Isaacson and Evan Thomas, *The Wise Men: Six Friends and the World They Made—Acheson, Bohlen, Harriman, Kennan, Lovett, McCloy* (New York: Simon and Schuster, 1966), pp. 122, 305.

31. Plotrow, op. cit., pp. 36-42.

32. *Ibid.*, p. viii. "As chairman of the special Republican Task Force on Population and Earth Resources, I was impressed by the arguments of William H. Draper, Jr. . . . General Draper continues to lead through his tireless work for the U.N. Population Fund."

33. Sobel, op. cit., pp. 298, 354.

34. Interview July 16, 1991, with Joanne Grossi, an official with the USAID's Population Office.

35. Dr. Nafis Sadik, "The State of World Population," 1991, New York, United Nations Population Fund.

36. See *User's Guide to the Office of Population*, 1991, Office of Population, Bureau for Science and Technology, United States Agency for International Development. Available from S&T/POP, Room 811 SA-18, USAID, Washington D.C. 20523-1819.

37. "History of the Association for Voluntary Sterilization [formerly Sterilization League of America], 1935-64," thesis submitted to the faculty of the graduate school of the University of Minnesota by William Ray Van Essendelft, March, 1978, available on microfilm, Library of Congress. This is the official history, written with full cooperation of the Sterilization League.

38. Interview with Dr. C. Nash Herndon, June 20, 1990.



# Rapist chooses castration over jail term

## That's 'barbaric,' critics say

P-I News Services 3-7-92

HOUSTON — A judge yesterday approved a child molester's request to be surgically castrated rather than go to prison on a charge of raping a 13-year-old girl last year.

The decision was called barbaric by critics who said it could open the door to similar remedies for other crimes. And an activist against sexual assault said the punishment wouldn't necessarily have the desired effect.

Castration has frequently been imposed as a eugenic method, to limit future generations of people who were considered undesirable.

In 1942, the U.S. Supreme Court struck down an Oklahoma law allowing forced castration as a punishment for people who committed felonies repeatedly involving "moral turpitude," including offenses that did not involve sex.

Until the early 1970s, Virginia carried out a policy of surgical sterilization for more than 7,000 mentally retarded people, most of them women.

Last year, a California judge ordered a woman convicted of child abuse to use Norplant, a surgically implanted contraceptive, but the order was widely criticized and the case is being appealed.

The proposal to use castration as a punishment for sex crimes re-emerged in the 1980s in a few scattered cases in which judges offered people convicted of rape or sexual abuse the choice of castration or long prison terms.

But those offers were either withdrawn or overruled before any castration took place.

Two years ago, Washington state legislators considered, and finally rejected, two bills on castration, one providing for mandatory castration of certain sex offenders, and the other allowing sex offenders to choose castration in exchange for reduced prison sentences.

# 'Scientific' Societies Launch Population Control Campaign

by Kathleen Klenetsky

4/92

March 9 (EIRNS)—A new flank in the campaign to kill off huge sections of the world's population has been opened by the U.S. National Academy of Sciences (NAS) and the Royal Society of London.

In an unprecedented joint statement issued Feb. 26, the respective "scientific academies" of the United States and Great Britain charge that population growth is "threatening the planet," and call for urgent measures for a "more rapid stabilization of world population," as well as strict environmental measures.

Entitled "Population Growth, Resource Consumption, and a Sustainable World," the statement uncritically endorses the old Malthusian saw that the world's resources, and thus its ability to support increased population, are finite, as well as the latest version of this quackery, namely, that human population growth in itself destroys the environment.

"Scientific and technological innovations, such as in agriculture, have been able to overcome many pessimistic predictions about resource constraints affecting human welfare," the statement concedes. But, it adds: "Nevertheless, the present patterns of human activity accentuated by population growth should make even those most optimistic about future scientific progress pause and reconsider the wisdom of ignoring these threats to our planet."

"It is not prudent to rely on science and technology alone to solve problems created by rapid population growth, wasteful resource consumption, and harmful human practices," the statement continues. But what science can do, it claims, is to develop safe, easy-to-use, and effective contraceptive agents and devices; environmentally benign alternative energy sources; improved agriculture; better public health; and research on biodiversity and ecological degradation.

Though paying the required lip service to economic developing in the Third World, the statement makes it clear that zero growth is the goal: "Unrestrained resource consumption for energy production and other uses, especially if the developing world strives to achieve living standards based on the same levels of consumption as the developed world, could lead to catastrophic outcomes for the global environment."

The statement was issued just in time for the opening of the last international negotiating committee preparatory to this June's United Nations-sponsored global ecological-fascist extravaganza in Brazil.

According to a cover letter accompanying the report, the officers of the two organizations "hope that the statement will encourage dialogue" on the issue of population and the environment at the June Earth Summit.

A spokesman for the NAS revealed today that the impetus for the joint statement came from the Foreign Secretary of the Royal Society during a meeting with the NAS in England last September. He "expressed concern that the population issue wasn't really going to be given the attention it deserved" at the Rio meeting, the spokesman said. "That led to a decision that the two groups should take action to influence" participants at Rio "to give population the urgent attention it requires."

A cover letter issued with the NAS-Royal Society statement reports that the Royal Swedish Academy of Sciences will host an international conference in spring 1993 to discuss issues of population growth, development, and the environment.

# Scientist suggests sterilization as population-explosion curb

Canadian Press 11-4-91

OTTAWA — Mass sterilization of people in poor countries might be the only way to stop the world population explosion, a prominent French scientist said Monday.

"I fear we may be forced to violate some basic human rights if we want to keep humanity alive," said Jean-Claude Pecker, France's leading astronomer and a long-time human-rights activist.

"One of the greatest needs now is to diminish the birth rate in poor countries. In order to do that, you might eventually be led to sterilize people after two children, for example.

"You might be forced to that drastic kind of solution less than 50 years from now. We see it coming, but no one dares to say it."

Forced migrations might also become unavoidable, he said.

Pecker is vice-president of the French National Commission for the United Nations Educational and Cultural Organization, former director of the Institute of Astrophysics in Paris, and a founding member of the human-rights committee of the French Academie des sciences.

His assertions weren't challenged by any of about 50 scientists at a symposium sponsored by the Royal Society of Canada.

But the idea of forced sterilization was strongly rejected by Bonnie Johnson of Planned Parenthood of Canada, who has studied Third World population issues.

"I find it just unconscionable that we would try to dictate to any woman or to any family their reproductive rights or freedoms," she said.

The only way to stop the population explosion is by raising living standards in poor countries, she said.



Bush campaign financier William H. Draper III, son of the Nazi banker, is current head of all United Nations Population programs.



Fritz Thyssen paid for Hitler's rise to power, and armed his war machine. Prescott Bush (George's father) and William Draper Jr. (George's population advisor) were Thyssen's U.S. bankers.



Charles Davenport, president of the 1932 Eugenics Congress, arranged cut-rate passage on the Harriman/Bush steamship line for German Nazis coming to the meeting.

**“Draper’s clients sponsored Hitler’s terroristic takeover; his clients led the buildup of the Nazi war industry; his clients made war against the United States. The Nazis were Draper’s direct partners in Berlin and New Jersey.”**

#### 4. **‘The Center of Power Is in Washington’**

Brown Brothers Harriman & Co.  
59 Wall Street, New York Cable  
Address “Shipley-New York”  
Business Established 1818  
Private Bankers

September 5, 1944

The Honorable W. A. Harriman  
American Ambassador to the U.S.S.R.  
American Embassy, Moscow, Russia  
Dear Averell:

Thinking that possibly Bullitt’s article in the recent issue of “LIFE” may not have come to your attention, I have clipped it and am sending it to you, feeling that it will interest you.

At present writing all is well here.

With warm regards, I am,  
Sincerely yours,

Pres

‘At present writing all is well here.’ Thus the ambassador to Russia was reassured by the managing partner of his firm, Prescott Bush. Only 22 and a half months before, the U.S. government had seized and shut down the Union Banking Corporation, which had been operated on behalf of Nazi Germany by Bush and the Harrimans. But that was behind them now, and they were safe. There would be no publicity on the Harriman-Bush sponsorship of Hitlerism.

Prescott’s son George, the future U.S. President, was also safe. Three days before this note to Moscow was written, George Bush had parachuted from a Navy bomber airplane over the

Pacific Ocean, killing his two crew members when the unpowered plane crashed.

Five months later, in February 1945, Prescott’s boss Averell Harriman escorted President Franklin Roosevelt to the fateful summit meeting with Soviet leader Joseph Stalin at Yalta. In April Roosevelt died. The agreement reached at Yalta, calling for free elections in Poland once the war ended, was never enforced.

Over the next eight years (1945 through 1952), Prescott Bush was Harriman’s anchor in the New York financial world. The increasingly powerful Mr. Harriman and his allies gave Eastern Europe over to Soviet dictatorship. A Cold War was then undertaken, to “counterbalance” the Soviets.

This British-inspired strategy paid several nightmarish dividends. Eastern Europe was to remain enslaved. Germany was “permanently” divided. Anglo-American power was jointly exercised over the non-Soviet “Free World.” The confidential functions of the British and American governments were merged. The Harriman clique took possession of the U.S. national security apparatus, and in doing so, they opened the gate and let the Bush family in.

\* \* \*

Following his services to Germany’s Nazi Party, Averell Harriman spent several years mediating between the British, American, and Soviet governments in the war to stop the Nazis. He was ambassador to Moscow from 1943 to 1946.

President Harry Truman, whom Harriman and his friends held in amused contempt, appointed Harriman U.S. ambassador to Britain in 1946.

Harriman was at lunch with former British Prime Minister Winston Churchill one day in 1946, when Truman telephoned. Harriman asked Churchill if he should accept Truman's offer to come back to the U.S. as Secretary of Commerce. According to Harriman's account, Churchill told him: "Absolutely. The center of power is in Washington."

## Jupiter Island

The reorganization of the American government after World War II—the creation of the U.S. Central Intelligence Agency along British lines, for example—had devastating consequences. We are concerned here with only certain aspects of that overall transformation, those matters of policy and family which gave shape to the life and mind of George Bush, and gave him access to power.

It was in these postwar years that George

Bush attended Yale University, and was inducted into the Skull and Bones society. The Bush family's home at that time was in Greenwich, Connecticut. But it was just then that George's parents, Prescott and Dorothy Walker Bush, were wintering in a peculiar spot in Florida, a place that is excluded from mentions in literature originating from Bush circles.

Certain national news accounts early in 1991 featured the observations on President Bush's childhood by his elderly mother Dorothy. She was said to be a resident of Hobe Sound, Florida. More precisely, the President's mother lived in a hyper-security arrangement created a half-century earlier by Averell Harriman, adjacent to Hobe Sound. Its correct name is Jupiter Island.

During his political career, George Bush has claimed many different "home" states, including Texas, Maine, Massachusetts, and Connecticut. It has not been expedient for him to claim Florida, though that state has a vital link to his role in the world, as we shall see. And George Bush's home base in Florida, throughout his adult life, has been Jupiter Island.

The unique, bizarre setup on Jupiter Island began in 1931, following the merger of W.A. Harriman and Co. with the British-American firm Brown Brothers.

The reader will recall Mr. Samuel Pryor, the "Merchant of Death." A partner with the Harrimans, Prescott Bush, George Walker, and Nazi boss Fritz Thyssen in banking and shipping enterprises, Sam Pryor remained executive committee chairman of Remington Arms. In this period, the Nazi private armies (SA and SS) were supplied with American arms—most likely by Pryor and his company—as they moved to overthrow the German republic. Such gun-running as an instrument of national policy would later become notorious in the "Iran-Contra" affair.

Sam Pryor's daughter Permelia married Yale graduate Joseph V. Reed on the last day of 1927. Reed immediately went to work for Prescott Bush and George Walker, as an apprentice at W.A. Harriman and Co.

During World War II, Joseph V. Reed had served in the "special services" section of the U.S. Army Signal Corps. A specialist in security, codes and espionage, Reed later wrote a book entitled *Fun with Cryptograms*.<sup>2</sup>

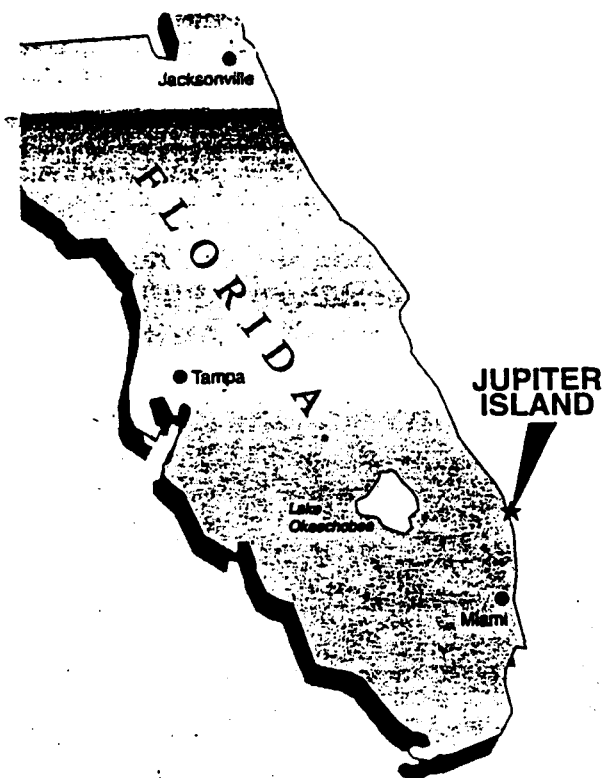

George Bush on Jupiter Island. Bush is wearing a boat racing uniform from his friend Don Aronow, front-man for gangster boss Meyer Lansky. The island lies just off the Florida coast, about 75 miles north of Miami.

Sam Pryor had had property around Hobe Sound, Florida, for some time. In 1931, Joseph and Permelia Pryor Reed bought the entirety of Jupiter Island.

This is a typically beautiful Atlantic coast "barrier island," a half-mile wide and nine miles long. The middle of Jupiter Island lies just off Hobe Sound. The south bridge connects the island with the town of Jupiter, to the north of Palm Beach. It is about 90 minutes by auto from Miami—today, a few minutes by helicopter.

Early in 1991, a newspaper reporter asked a friend of the Bush family about security arrangements on Jupiter Island. He responded, "If you called up the White House, would they tell you how many security people they had?"

Robert Lovett, Prescott Bush's partner, helped arrange the demise of James Forrestal, and soon took his place as U.S. Defense Secretary. Lovett's committee proposed the creation of the Central Intelligence Agency, to be based on British lines.



Opium manufacturer George Merca (right), chief of all U.S. biological warfare projects, is shown here in 1946 with Defense Secretary Louis Patterson. Led by neighbor Paul Mellon, Jupiter islanders pushed the MK-Ultra drug experiments which addicted America.



John May ("Jack") Whitney, (boy on pony), later U.S. ambassador to England. His sister Joan Whitney Payson was co-owner of the New York Mets with the Walkers, and a Bush neighbor on Jupiter Island. Their grandfather, Secretary of the Navy William C. Whitney, turned U.S. Naval intelligence over to British control. Below, Queen Elizabeth II with an American worshipper.



It's not that Jupiter Island is the White House, although he [George Bush] does come down frequently."

But for several decades before Bush was President, Jupiter Island had an ordinance requiring the registration and fingerprinting of all housekeepers, gardeners, and other non-residents working on the island. The Jupiter Island police department says that there are sensors in the two main roads that can track every automobile on the island. If a car stops in the street, the police will be there within one or two minutes. Surveillance is a duty of all employees of the Town of Jupiter Island. News reporters are to be prevented from visiting the island.<sup>3</sup>

To create this astonishing private club, Joseph and Permelia Pryor Reed sold land only to those who would fit in. Permelia Reed was still the grande dame of the island when George Bush was inaugurated President in 1989. In recognition of the fact that the Reeds know where all the bodies are buried, President Bush appointed Permelia's son, Joseph V. Reed, Jr., chief of protocol for the U.S. State Dept., in charge of private arrangements with foreign dignitaries.

Averell Harriman made Jupiter Island a staging ground for his 1940s takeover of the U.S. national security apparatus. It was in that connection that the island became possibly the most secretive private place in America.

Let us briefly survey the neighborhood, back then in 1946-48, to see some of the uses various of the residents had for the Harriman clique.

## Residence on Jupiter Island

• Jupiter Islander Robert A. Lovett,<sup>4</sup> Prescott Bush's partner at Brown Brothers Harriman, had been Assistant Secretary of War for Air from 1941 to 1945. Lovett was the leading Ameri-

can advocate of the policy of terror-bombing of civilians. He organized the Strategic Bombing Survey, carried out for the American and British governments by the staff of the Prudential Insurance Company, guided by London's Tavistock Psychiatric Clinic.

In the postwar period, Prescott Bush was associated with Prudential Insurance, one of Lovett's intelligence channels to the British secret services. Prescott was listed by Prudential as a director of the company for about two years in the early 1950s.

Their Strategic Bombing Survey failed to demonstrate any real military advantage accruing from such outrages as the fire-bombing of Dresden, Germany. But the Harrimanites nevertheless persisted in the advocacy of terror from the air. They glorified this as "psychological warfare," a part of the utopian military doctrine opposed to the views of military traditionalists such as Gen. Douglas MacArthur.

Robert Lovett later advised President Lyndon Johnson to terror-bomb Vietnam. President George Bush revived the doctrine with the bombing of civilian areas in Panama, and the destruction of Baghdad.

On October 22, 1945, Secretary of War Robert Patterson created the Lovett Committee, chaired by Robert A. Lovett, to advise the government on the post-World War II organization of U.S. intelligence activities. The existence of this committee was unknown to the public until an official CIA history was released from secrecy in 1989. But the CIA's author (who was President Bush's prep school history teacher; see chapter 5) gives no real details of the Lovett Committee's functioning, claiming: "The record of the testimony of the Lovett Committee, unfortunately, was not in the archives of the agency when this account was written."<sup>5</sup>

The CIA's self-history does inform us of the advice that Lovett provided to the Truman cabinet, as the official War Department intelligence proposal.

Lovett decided that there should be a sepa-



rate Central Intelligence Agency. The new agency would "consult" with the armed forces, but it must be the sole collecting agency in the field of foreign espionage and counterespionage. The new agency should have an independent budget, and its appropriations should be granted by Congress without public hearings.

Lovett appeared before the Secretaries of State, War, and Navy on November 14, 1945. He spoke highly of the FBI's work because it had "the best personality file in the world." Lovett said the FBI was expert at producing false documents, an art "which we developed so successfully during the war and at which we became outstandingly adept." Lovett pressed for a virtual resumption of the wartime Office of Strategic Services (OSS) in a new CIA.

U.S. military traditionalists centered around Gen. Douglas MacArthur opposed Lovett's proposal. The continuation of the OSS had been attacked at the end of the war on the grounds that the OSS was entirely under British control, and that it would constitute an American Gestapo.<sup>6</sup> But the CIA was established in 1947 according to the prescription of Robert Lovett, of Jupiter Island.

• Charles Payson and his wife, Joan Whitney Payson, were extended family members of Harriman's and business associates of the Bush family.

Joan's aunt, Gertrude Vanderbilt Whitney, was a relative of the Harrimans. Gertrude's son, Cornelius Vanderbilt ("Sonny") Whitney, long-time chairman of Pan American Airways (Prescott was a Pan Am director), became assistant secretary of the U.S. Air Force in 1947. Sonny's wife Marie had divorced him and married Averell Harriman in 1930. Joan and Sonny's uncle, Air Marshal Sir Thomas Elmhirst, was director of intelligence for the British Air Force from 1945 to 1947.

Joan's brother, John Hay ("Jock") Whitney, was to be ambassador to Great Britain from 1955 to 1961 . . . when it would be vital for Prescott and George Bush to have such a friend. Joan's father, grandfather, and uncle were members of the Skull and Bones secret society.

Charles Payson organized a uranium refinery in 1948. Later, he was chairman of Vitro Corporation, makers of parts for submarine-launched ballistic missiles, equipment for frequency surveillance and torpedo guidance, and other sub-surface weaponry.

Naval warfare has long been a preoccupation of the British Empire. British penetration of the U.S. Naval Intelligence service has been particularly heavy since the tenure of Joan's Anglophile grandfather, William C. Whitney, as secretary of the Navy for President Grover Cleveland. This traditional covert British orientation in the U.S. Navy, Naval Intelligence and the Navy's included service, the Marine Corps, forms a backdrop to the career of George Bush—and to the whole neighborhood on Jupiter Island. Naval Intelligence maintained direct relations with gangster boss Meyer Lansky for Anglo-American political operations in Cuba during World War II, well before the establishment of the CIA. Lansky officially moved to Florida in 1953.<sup>7</sup>

• George Herbert Walker, Jr. (Skull and Bones, 1927), was extremely close to his nephew

George Bush, helping to sponsor his entry into the oil business in the 1950s. "Uncle Herbie" was also a partner of Joan Whitney Payson when they co-founded the New York Mets baseball team in 1960. His son, G.H. Walker III, was a Yale classmate of Nicholas Brady and Moreau D. Brown (Thatcher Brown's grandson), forming what was called the "Yale Mafia" on Wall Street.

• Walter S. Carpenter, Jr. had been chairman of the finance committee of the Du Pont Corporation (1930-40). In 1933, Carpenter oversaw Du Pont's purchase of Remington Arms from Sam Pryor and the Rockefellers, and led Du Pont into partnership with the Nazi I.G. Farben company for the manufacture of explosives. Carpenter became Du Pont's president in 1940. His cartel with the Nazis was broken up by the U.S. government. Nevertheless, Carpenter remained Du Pont's president, as the company's technicians participated massively in the Manhattan Project to produce the first atomic bomb. He was chairman of Du Pont from 1948 to 1962, retaining high-level access to U.S. strategic activities.

Walter Carpenter and Prescott Bush were fellow activists in the Mental Hygiene Society. Originating at Yale University in 1908, the movement had been organized into the World Federation of Mental Health by Montague Norman, himself a frequent mental patient, former Brown Brothers partner and Bank of England Governor. Norman had appointed as the federation's chairman, Brigadier John Rawlings Rees, director of the Tavistock Clinic, chief psychiatrist and psychological warfare expert for the British intelligence services. Prescott was a director of the society in Connecticut; Carpenter was a director in Delaware.

• Paul Mellon was the leading heir to the Mellon fortune, and a long-time neighbor of Averell Harriman's in Middleburg, Virginia, as well as Jupiter Island, Florida. Paul's father, Andrew Mellon, U.S. treasury secretary 1921-32, had approved the transactions of Harriman, Pryor, and Bush with the Warburgs and the Nazis. Paul Mellon's son-in-law, David K.E. Bruce, worked in Prescott Bush's W.A. Harriman & Co. during the late 1920s; was head of the London branch of U.S. intelligence during World War II; and was Averell Harriman's Assistant Secretary of Commerce in 1947-48. Mellon family money and participation would be instrumental in many domestic U.S. projects of the new Central Intelligence Agency.



Prescott Bush (left) with President Eisenhower at 1956 Republican convention. The same British-backed crew, in Republican dress, ran the Eisenhower administration.

• Carll Tucker manufactured electronic guidance equipment for the Navy. With the Mellons, Tucker was an owner of South American oil properties. Mrs. Tucker was the great-aunt of *Nicholas Brady*, later George Bush's Iran-Contra partner and U.S. treasury secretary. Their son Carll Tucker, Jr. (*Skull and Bones*, 1947), was among the 15 Bonesmen who selected George Bush for induction in the class of 1948.

• C. Douglas Dillon was the boss of William H. Draper, Jr. in the Draper-Prescott Bush-Fritz Thyssen Nazi banking scheme of the 1930s and 40s. His father, Clarence Dillon, created the Vereinigte Stahlwerke (Thyssen's German Steel Trust) in 1926. C. Douglas Dillon made *Nicholas Brady* the chairman of the Dillon Read firm in 1971 and himself continued as chairman of the Executive Committee. C. Douglas Dillon would be a vital ally of his neighbor Prescott Bush during the Eisenhower administration.

• Publisher Nelson Doubleday headed his family's publishing firm, founded under the auspices of J.P. Morgan and other British Empire representatives. When George Bush's "Uncle Herbie" died, Doubleday took over as majority owner and chief executive of the New York Mets baseball team.

Some other specialized corporate owners had their place in Harriman's strange club.

• George W. Merck, chairman of Merck & Co., drug and chemical manufacturers, was director of the War Research Service: Merck was the official chief of all U.S. research into biological warfare from 1942 until at least the end of World War II. After 1944, Merck's organization was placed under the U.S. Chemical Warfare Service. His family firm in Germany and the United States was famous for its manufacture of morphine.

• James H. McGraw, Jr., chairman of McGraw Hill Publishing Company, was a member of the advisory board to the U.S. Chemical Warfare Service and a member of the Army Ordnance Association Committee on Endowment.

• Fred H. Haggerson, chairman of Union Carbide Corp., produced munitions, chemicals, and firearms.

• A.L. Cole was useful to the Jupiter Islanders as an executive of *Readers Digest*. In 1965, just after performing a rather dirty favor for George Bush [which will be discussed in a coming chapter—ed.], Cole became chairman of the executive committee of the *Digest*, the world's largest-circulation periodical.

From the late 1940s, Jupiter Island has served as a center for the direction of covert action by the U.S. government and, indeed, for the covert management of the government. Jupiter Island will reappear later on, in our account of George Bush in the Iran-Contra affair.

---

## Target: Washington

George Bush graduated from Yale in 1948. He soon entered the family's Dresser oil supply concern in Texas. We shall now briefly describe the forces that descended on Washington, D.C. during those years when Bush, with the assis-

tance of family and powerful friends, was becoming "established in business on his own."

From 1948 to 1950, Prescott Bush's boss Averell Harriman was U.S. "ambassador-at-large" to Europe. He was a non-military "Theater Commander," the administrator of the multi-billion-dollar Marshall Plan, participating in all military/strategic decision-making by the Anglo-American alliance.

The U.S. secretary of defense, James Forrestal, had become a problem to the Harrimanites. Forrestal had long been an executive at Dillon Read on Wall Street. But in recent years he had gone astray. As secretary of the navy in 1944, Forrestal proposed the racial integration of the Navy. As defense secretary, he pressed for integration in the armed forces and this eventually became the U.S. policy.

Forrestal opposed the utopians' strategy of appeasement coupled with brinkmanship. He was simply opposed to communism. On March 28, 1949, Forrestal was forced out of office and flown on an Air Force plane to Florida. He was taken to "Hobe Sound" (Jupiter Island), where Robert Lovett and an army psychiatrist dealt with him.

He was flown back to Washington, locked in Walter Reed Army Hospital and given insulin shock treatments for alleged "mental exhaustion." He was denied all visitors except his estranged wife and children—his son had been Averell Harriman's aide in Moscow. On May 22, Forrestal's body was found, his bathrobe cord tied tightly around his neck, after he had plunged from a sixteenth-story hospital window. The chief psychiatrist called the death a suicide even before any investigation was started. The results of the Army's inquest were kept secret. Forrestal's diaries were published, 80 percent deleted, after a year of direct government censorship and rewriting.

\* \* \*

North Korean troops invaded South Korea in June 1950, after U.S. Secretary of State Dean Acheson (Harriman's very close friend) publicly specified that Korea would not be defended. With a new war on, Harriman came back to serve as President Truman's adviser, to "oversee national security affairs."

Harriman replaced Clark Clifford, who had been special counsel to Truman. Clifford, however, remained close to Harriman and his partners as they gained more and more power. Clifford later wrote about his cordial relations with Prescott Bush:

"Prescott Bush . . . had become one of my frequent golfing partners in the fifties, and I had both liked and respected him. . . . Bush had a splendid singing voice, and particularly loved quartet singing. In the fifties, he organized a quartet that included my daughter Joyce. . . . They would sing in Washington, and, on occasion, he invited the group to Hobe Sound in Florida to perform. His son [George], though, had never struck me as a strong or forceful person. In 1988, he presented himself successfully to the voters as an outsider—no small trick for

a man whose roots wound through Connecticut, Yale, Texas oil, the CIA, a patrician background, wealth, and the Vice Presidency."<sup>9</sup>

With Forrestal out of the way, Averell Harriman and Dean Acheson drove to Leesburg, Virginia, on July 1, 1950, to hire the British-backed U.S. Gen. George C. Marshall as secretary of defense. At the same time, Prescott's partner, Robert Lovett, himself became assistant secretary of defense.

Lovett, Marshall, Harriman, and Acheson went to work to unhorse Gen. Douglas MacArthur, commander of U.S. forces in Asia. MacArthur kept Wall Street's intelligence agencies away from his command, and favored real independence for the non-white nations. Lovett called for MacArthur's firing on March 23, 1951, citing MacArthur's insistence on defeating the Communist Chinese invaders in Korea. MacArthur's famous message, that there was "no substitute for victory," was read in Congress on April 5; MacArthur was fired on April 10, 1951.

That September, Robert Lovett replaced Marshall as secretary of defense. Meanwhile, Harriman was named director of the Mutual Security Agency, making him the U.S. chief of the Anglo-American military alliance. By now, Brown Brothers Harriman was everything but commander-in-chief.

\* \* \*

These were, of course, exciting times for the Bush family, whose wagon was hitched to the financial gods of Olympus—to Jupiter, that is.

Brown Brothers Harriman & Co.  
59 Wall Street, New York 5, N.Y.

Business Established 1818 Cable  
Address "Shipley-New York"  
Private Bankers  
April 2, 1951

The Honorable W.A. Harriman,  
The White House, Washington, D.C.

Dear Averell:

I was sorry to miss you in Washington but appreciate your cordial note. I shall hope for better luck another time.

I hope you had a good rest at Hobe Sound.

With affectionate regard, I am,  
Sincerely yours,

Pres [signed]  
Prescott S. Bush

A central focus of the Harriman security regime in Washington (1950-53) was the organization of covert operations, and "psychological warfare." Harriman, together with his lawyers and business partners, Allen and John Foster Dulles, wanted the government's secret services to conduct extensive propaganda campaigns and mass-psychology experiments within the U.S.A., and paramilitary campaigns abroad. This would supposedly ensure a stable worldwide environment favorable to Anglo-American financial and political interests.

The Harriman security regime created the

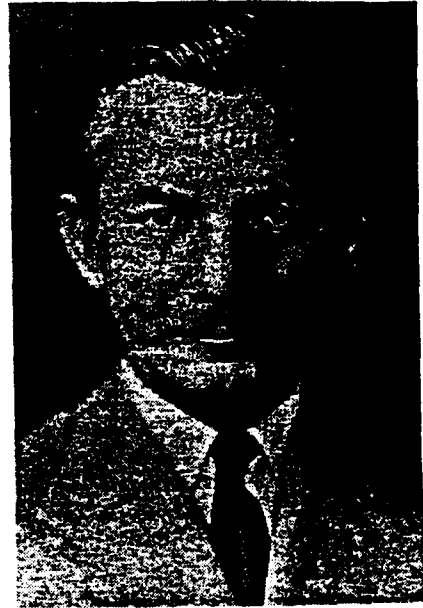

Defense Secretary James Forrestal. Formerly with Dillon Read, he opposed the Harrimanites' condominium with the U.S.S.R., and racially integrated U.S. armed forces. He was fired and flown to Jupiter Island, where he was "suicided."

Psychological Strategy Board (PSB) in 1951. The man appointed director of the PSB, Gordon Gray, is familiar to the reader as the sponsor of the child sterilization experiments, carried out by the Harrimanite eugenics movement in North Carolina following World War II.

Gordon Gray was an avid Anglophile, whose father had gotten controlling ownership of the R.J. Reynolds Tobacco Company through alliance with the British Imperial tobacco cartel's U.S. representatives, the Duke family of North Carolina. Gordon's brother, R.J. Reynolds chairman Bowman Gray Jr., was also a naval intelligence officer, known around Washington as the "founder of operational intelligence." Gordon Gray became a close friend and political ally of Prescott Bush; and Gray's son became for Prescott's son, George, his lawyer and the shield of his covert policy.

But President Harry Truman, as malleable as he was, constituted an obstacle to the covert warriors. An insular Missouri politician vaguely favorable to the U.S. Constitution, he remained skeptical about secret service activities that reminded him of the Nazi Gestapo.

So, "covert operations" could not fully take off without a change of the Washington regime. And it was with the Republican Party that Prescott Bush was to get his turn.

---

## Prescott Runs for Senate

Prescott had made his first attempt to enter national politics in 1950, as his partners took control of the levers of governmental power.

Remaining in charge of Brown Brothers Harriman, he ran against Connecticut's William Benton for his seat in the U.S. Senate. (The race was actually for a two-year unexpired term, left empty by the death of the previous senator).

In those days, Wisconsin's drunken Senator Joseph R. McCarthy was making a circus-like crusade against communist influence in Washington. McCarthy attacked liberals and leftists, State Department personnel, politicians, and Hollywood figures. He generally left unscathed the Wall Street and London strategists who donated Eastern Europe and China to communist dictatorship—like George Bush, their geopolitics was beyond left and right.

Prescott Bush had no public ties to the notorious Joe McCarthy, and appeared to be neutral about his crusade. But the Wisconsin senator had his uses. Joe McCarthy came into Connecticut three times that year to campaign for Bush and against the Democrats. Bush himself made charges of "Korea, Communism and Corruption" into a slick campaign phrase against Benton, which then turned up as a national Republican slogan.

The response was disappointing. Only small crowds turned out to hear Joe McCarthy, and Benton was not hurt. McCarthy's pro-Bush rally in New Haven, in a hall that seated 6,000, drew only 376 people. Benton joked on the radio that "200 of them were my spies."

Prescott Bush resigned from the Yale Board of Fellows for his campaign, and the board published a statement to the effect that the "Yale vote" should support Bush—despite the fact that Benton was a Yale man, and in many ways identical in outlook to Bush. Yale's Whiffenpoof singers appeared regularly for Prescott's campaign. None of this was particularly effective, however, with the voting population.<sup>10</sup>

Then Papa Bush ran into a completely unexpected problem. At that time, the old Harriman eugenics movement was centered at Yale University. Prescott Bush was a Yale trustee, and his former Brown Brothers Harriman partner, Lawrence Tighe, was Yale's treasurer. In that connection, a slight glimmer of the truth about the Bush-Harriman firm's Nazi activities now made its way into the campaign.

Not only was the American Eugenics Society itself headquartered at Yale, but all parts of this undead fascist movement had a busy home at Yale. The coercive psychiatry and sterilization advocates had made the Yale/New Haven Hospital and Yale Medical School their laboratories for hands-on practice in brain surgery and psychological experimentation. And the Birth Control League was there, which had long trumpeted the need for eugenical births—fewer births for parents with "inferior" bloodlines. Prescott's partner Tighe was a Connecticut director of the league, and the Connecticut league's medical advisor was the eugenics advocate, Dr. Winternitz of Yale Medical School.

Now in 1950, people who knew something about Prescott Bush knew that he had very unsavory roots in the eugenics movement. There were then, just after the anti-Hitler war, few open advocates of sterilization of "unfit" or "unnecessary" people. (That would be revived later, with the help of General Draper and his

friend George Bush.) But the Birth Control League was public—just about then it was changing its name to the euphemistic "Planned Parenthood."

Then, very late in the 1950 senatorial campaign, Prescott Bush was publicly exposed for being an activist in that section of the old fascist eugenics movement. Prescott Bush lost the election by about 1,000 out of 862,000 votes. He and his family blamed the defeat on the exposé. The defeat was burned into the family's memory, leaving a bitterness and perhaps a desire for revenge.

In his foreword to a population control propaganda book, George Bush wrote about that 1950 election: "My own first awareness of birth control as a public policy issue came with a jolt in 1950 when my father was running for United States Senate in Connecticut. Drew Pearson, on the Sunday before Election day, 'revealed' that my father was involved with Planned Parenthood. . . . Many political observers felt a sufficient number of voters were swayed by his alleged contacts with the birth controllers to cost him the election. . . ."<sup>11</sup>

Prescott Bush gave a graphic description of these events in his "oral history" interview at Columbia University: "In the 1950 campaign, when I ran against Benton, the very last week, Drew Pearson, famous columnist, was running a radio program at that time. . . . In this particular broadcast, just at the end of our campaign [Pearson said]: 'I predict that Benton will retain his seat in the United States Senate, because it has just been made known that Prescott Bush, his opponent, is president of the Birth Control Society' or chairman, member of the board of directors, or something, 'of the Birth Control Society. In this country, and of course with Connecticut's heavy Catholic population, and its laws against birth control . . . this is going to be too much for Bush to rise above. Benton will be elected. I predict.'"

The next Sunday, they handed out, at these Catholic Churches in Waterbury and Torrington and Bridgeport, handbills, quoting Drew Pearson's statement on the radio about Prescott Bush, you see—I predict. Well, my telephone started ringing that Sunday at home, and when I'd answer, or Dotty [Prescott's wife, George's mother] would answer—"Is this true, what they say about Prescott Bush? This can't be true. Is it true?"

She'd say, "No, it isn't true." Of course, it wasn't true. But you never catch up with a thing like this—the election's just day after tomorrow, you see? So there's no doubt, in the estimate of our political leaders, that this one thing cost me many thousand votes—whether it was 1, 3, 5 or 10 thousand we don't know, we can't possibly tell, but it was enough. To have overcome that thousand vote, it would only have had to be 600 switch [sic].

[Mrs. Bush then corrected the timing in Prescott Bush's recollections.]

"I'd forgotten the exact sequence, but that was it. . . . The state then—and I think still is—probably about 55 percent Catholic population, with all the Italian derivation people [sic], and Polish is very heavy, and the Catholic church is very dominant here, and the archbishop was

death on this birth control thing. They fought repeal every time it came up in the legislature, and *we never did get rid of that prohibition until just a year or two ago*, as I recall it [emphasis added].<sup>12</sup>

Prescott Bush was defeated, while the other Republican candidates fared well in Connecticut. He attributed his loss to the Catholic Church. After all, he had dependable friends in the news media. The *New York Times* loved him for his bland pleasantness. He just about owned CBS. Twenty years earlier, Prescott Bush had personally organized the credit to allow William S. Paley to buy the CBS (radio, later television) network outright. In return, Prescott was made a director and the financial leader of CBS; Paley himself became a devoted follower and servitor of Averell Harriman.

Well, when he tried again, Prescott Bush would not leave the outcome to the blind whims of the public.

Prescott Bush moved into action in 1952 as a national leader of the push to give the Republican presidential nomination to Gen. Dwight D. ("Ike") Eisenhower. Among the other team members were Bush's Hitler-era lawyer John Foster Dulles, and Jupiter Islander C. Douglas Dillon.

Dillon and his father were the pivots as the Harriman-Dulles combination readied Ike for the presidency. As a friend put it: "When the Dillons ... invited [Eisenhower] to dinner it was to introduce him to Wall Street bankers and lawyers."<sup>13</sup>

Ike's higher level backers believed, correctly, that Ike would not interfere with even the dirtiest of their covert action programs. The bland, pleasant Prescott Bush was in from the beginning: a friend to Ike, and an original backer of his presidency.

On July 28, 1952, as the election approached, Connecticut's senior U.S. senator, James O'Brien McMahon, died at the age of 48. (McMahon had been Assistant U.S. Attorney General, in charge of the Criminal Division, from 1935 to 1939. Was there a chance he might someday speak out about the unpunished Nazi-era crimes of the wealthy and powerful?)

This was *extremely* convenient for Prescott. He got the Republican nomination for U.S. senator at a special delegated meeting, with backing by the Yale-dominated state party leadership. Now he would run in a special election for the suddenly vacant Senate seat. He could expect to be swept into office, since he would be on the same electoral ticket as the popular war hero, General Ike. By a technicality, he would instantly become Connecticut's senior senator, with extra power in Congress. And the next regularly scheduled senatorial race would be in 1956 (when McMahon's term would have ended), so Prescott could run again in that presidential election year ... once again on Ike's coattails!

With this arrangement, things worked out very smoothly. In Eisenhower's 1952 election victory, Ike won Connecticut by a margin of 129,507 votes out of 1,092,471. Prescott Bush came in last among the statewide Republicans, but managed to win by 30,373 out of 1,088,799, his margin nearly 100,000 behind Eisenhower. He took the traditionally Republican towns.

In Eisenhower's 1956 re-election, Ike won Connecticut by 303,036 out of 1,114,954 votes, the largest presidential margin in Connecticut's history. Prescott Bush managed to win again, by 129,544 votes out of 1,085,206—his margin this time 290,082 smaller than Eisenhower's.<sup>14</sup>

In January 1963, when this electoral strategy had been played out and his second term expired, Prescott Bush retired from government and returned to Brown Brothers Harriman.

The 1952 Eisenhower victory made John Foster Dulles Secretary of State, and his brother Allen Dulles head of the CIA. The reigning Dulles brothers were the "Republican" replacements for their client and business partner, "Democrat" Averell Harriman. Occasional public posturings aside, their strategic commitments were identical to his.

Undoubtedly the most important work accomplished by Prescott Bush in the new regime was on the golf links.

Those who remember the Eisenhower presidency know that Ike played ... quite a bit of golf! Democrats sneered at him for mindlessness, Republicans defended him for taking this healthy recreation. Golf was Ike's ruling passion. And there at his side was the loyal, bland, pleasant Senator Prescott Bush, former president of the U.S. Golf Association, son-in-law of the very man who had reformulated the rules of the game.

Prescott Bush was Dwight Eisenhower's favorite golf partner. Prescott could reassure Ike about his counselors, allay his concerns, and monitor his moods. Ike was very grateful to Prescott, who never revealed the President's scores.

The public image of his relationship to the President may be gleaned from a 1956 newspaper profile of Prescott Bush's role in the party. The *New York Times*, which 11 years before had consciously protected him from public exposure as a Nazi banker, fawned over him in an article entitled, "His Platform: Eisenhower": "A tall, lean, well-dressed man who looks exactly like what he is—a wealthy product of the Ivy League—is chairman of the Republican Convention's platform committee. As such, Prescott Bush, Connecticut's senior United States Senator, has a difficult task: he has to take one word and expand it to about 5,000.

"The one word, of course, is 'Ike'—but no party platform could ever be so simple and direct

... "Thus it is that Senator Bush and his fellow committee members ... find themselves confronted with the job of wrapping around the name Eisenhower sufficient verbiage to persuade the public that it is the principles of the party, and not the grin of the man at the head of it, which makes it worthy of endorsement in [the] November [election].

"For this task Prescott Bush, a singularly practical and direct conservative, may not be entirely fitted. It is likely that left to his own devices he would simply offer the country the one word and let it go at that.

"He is ... convinced that this would be enough to do the trick ... if only the game were played that way.

"Since it is not, he can be expected to preside with dignity, fairness and dispatch over the ses-

sions that will prepare the party credo for the 1956 campaign.

"If by chance there should be any conflicts within the committee . . . the Senator's past can offer a clue to his conduct.

"A former Yale Glee Club and second bass in the All-Time Whiffenpoofs Quartet, he is . . . [called] 'the hottest close-harmony man at Yale in a span of twenty-five years.'

"Close harmony being a Republican specialty under President Eisenhower, the hottest close-harmony man at Yale in twenty-five years would seem to be an ideal choice for the convention job he holds at San Francisco. . . .

"[In addition to his business background, he] also played golf, competing in a number of tournaments. For eight years he was a member of the executive committee of the United States Golf Association. . . .

"As a Senator, Connecticut's senior spokesman in the upper house has followed conservative policies consistent with his business background.

He resigned all his corporate directorships, took a leave from Brown Brothers, Harriman, and proceeded to go down the line for the Eisenhower program. . . .

"Around the Senate, he is known as a man who does his committee work faithfully, defends the Administration stoutly, and fits well into the clublike atmosphere of Capitol Hill.

To be continued.

#### Notes

1. Walter Isaacson and Evan Thomas, *The Wise Men: Six Friends and the World They Made*—Acheson, Bohlen, Harriman, Kennan, Lovett, McCloy (New York: Simon and Schuster, 1986), p. 377.
2. Reed was better known in high society as a minor diplomat, the founder of the Triton Press and the president of the American Shakespeare Theater.
3. *Palm Beach Post*, January 13, 1991.
4. For Lovett's residency there see Isaacson and Thomas, *op. cit.*, p. 417. Some Jupiter Island residencies were verified by their inclusion in the 1947 membership list of the Hobe Sound Yacht Club, in the Harriman papers, Library of Congress; others were established from interviews with long-time Jupiter Islanders.
5. Arthur Burr Darling, *The Central Intelligence Agency: An Instrument of Government, to 1950*, (College Station: Pennsylvania State University, 1990), p. 59.
6. The *Chicago Tribune*, Feb 9, 1945, for example, warned of "Creation of an all-powerful intelligence service to spy on the postwar world and to pry into the lives of citizens at home. Cf. Anthony Cave Brown, *Wild Bill Donovan: The Last Hero*, (New York: Times Books, 1982), p. 625, on warnings to FDR about the British control of U.S. intelligence.
7. Dennis Eisenberg, Uri Dan, Eli Landau, *Meyer Lansky: Mogul of the Mob* (New York: Paddington Press, 1979) pp. 227-28.
8. See John Ranelagh, *The Agency: The Rise and Decline of the CIA*, (New York: Simon and Schuster, 1987), pp. 131-32.
9. Clark Clifford, *Counsel to the President* (New York: Random House, 1991).
10. Sidney Hyman, *The Life of William Benton* (Chicago: The University of Chicago Press, 1969), pp. 438-41.
11. Phyllis Tilson Piotrow, *World Population Crisis: The United States Response* (New York: Praeger Publishers, 1973), "Forward" by George H.W. Bush, p. vii.
12. Interview with Prescott Bush in the Oral History Research Project conducted by Columbia University in 1966, Eisenhower Administration Part II; pp. 62-4.
13. Herbert S. Parmet, *Eisenhower and the American Crusades* (New York: The Macmillan Company, 1972), p. 14.
14. *New York Times*, Sept. 6, 1952, Nov. 5, 1952, Nov. 7, 1956.
15. *New York Times*, Aug. 21, 1956.

Prescott Bush was a most elusive, secretive senator. By diligent research, his views on some issues may be traced: He was opposed to the development of public power projects like the Tennessee Valley Authority; he opposed the constitutional amendment introduced by Ohio Senator John W. Bricker, which would have required congressional approval of international agreements by the executive branch.

But Prescott Bush was essentially a covert operative in Washington.

In June 1954, Bush received a letter from Connecticut resident H. Smith Richardson, owner of Vick Chemical Company (cough drops, Vapo-Rub): It read, in part, ". . . At some time before Fall, Senator, I want to get your advice and counsel on a [new] subject—namely what should be done with the income from a foundation which my brother and I set up, and which will begin its operation in 1956. . . ."<sup>16</sup>

This letter presages the establishment of the H. Smith Richardson Foundation, a Bush family-dictated private slush fund which was to be utilized by the Central Intelligence Agency, and by Vice President Bush for the conduct of his Iran-Contra adventures.

The Bush family knew Richardson and his wife through their mutual friendship with Sears Roebuck's chairman, General Robert E. Wood. General Wood had been president of the America First organization, which had lobbied against war with Hitler's Germany. H. Smith Richardson had contributed the start-up money for America First and had spoken out against the United States "joining the Communists" by fighting Hitler. Richardson's wife was a proud relative of Nancy Langehorne from Virginia, who married Lord Astor and backed the Nazis from their Cliveden Estate.

General Wood's daughter Mary had married the son of Standard Oil president William Stamps Farish. The Bushes had stuck with the Farishes through their disastrous exposure during World War II (See Chapter 3). Young George Bush and his bride Barbara were especially close to Mary Farish, and to her son W.S. Farish III, who would be the great confidante of George's presidency.<sup>17</sup>



The emblem of "Skull & Bones," the secret society of American bluebloods, into which George Bush was inducted during his years at Yale University.



H. Smith Richardson was Connecticut's leading "McCarthyite." He planned an elaborate strategy for Joe McCarthy's intervention in Connecticut's November 1952 elections, to finally defeat Senator Benton.<sup>18</sup> (Benton's 1950 victory over Prescott Bush was only for a two-year unexpired term. He was running in this election for a full term, at the same time that Prescott Bush was running to fill the seat left vacant by Senator McMahon's death).<sup>18</sup>

The H. Smith Richardson Foundation was organized by Eugene Stetson, Jr., Richardson's son-in-law. Stetson (*Skull and Bones*, 1934) had worked for Prescott Bush as assistant manager of the New York branch of Brown Brothers Harriman.

In the late 1950s, the Smith Richardson Foundation took part in the "psychological warfare" of the CIA. This was not a foreign, but a domestic covert operation, carried out mainly against unwitting U.S. citizens. CIA director Allen Dulles and his British allies organized "MK-Ultra," the testing of psychotropic drugs including LSD on a very large scale, allegedly to evaluate "chemical warfare" possibilities.

In this period, the Richardson Foundation helped finance experiments at Bridgewater Hospital in Massachusetts, the center of some of the most brutal MK-Ultra tortures. These outrages have been graphically portrayed in the movie, *Titticut Follies*.

During 1990, an investigator for this book toured H. Smith Richardson's Center for Creative Leadership just north of Greensboro, North Carolina. The tour guide said that in these rooms, agents of the Central Intelligence Agency and the Secret Service are trained. He demonstrated the two-way mirrors through which the government employees are watched, while they are put through mind-bending psychodramas. The guide explained that "virtually everyone who becomes a general" in the U.S. armed forces also goes through this "training" at the Richardson Center.

Another office of the Center for Creative Leadership is in Langley, Virginia, at the headquarters of the Central Intelligence Agency. Here also, Richardson's center trains leaders of the CIA.

The Smith Richardson Foundation will be seen in a later chapter, performing in the Iran-Contra drama around Vice President George Bush.

\* \* \*

Prescott Bush worked throughout the Eisenhower years as a confidential ally of the Dulles brothers. In July 1956, Egypt's President Gamel Abdul Nasser announced he would accept the U.S. offer of a loan for the construction of the Aswan dam project. John Foster Dulles then prepared a statement telling the Egyptian ambassador that the U.S.A. had decided to retract its offer. Dulles gave the explosive statement in advance to Prescott Bush for his approval. Dulles also gave the statement to President Eisenhower, and to the British government.

Nasser reacted to the Dulles brush-off by nationalizing the Suez Canal to pay for the dam. Israel, then Britain and France, invaded Egypt to try to overthrow Nasser, leader of the anti-imperial Arab nationalists. However, Eisen-

hower refused (for once) to play the Dulles-British game, and the invaders had to leave Egypt when Britain was threatened with U.S. economic sanctions.

During 1956, Senator Prescott Bush's value to the Harriman-Dulles political group increased when he was put on the Senate Armed Services Committee. Bush toured U.S. and allied military bases throughout the world, and had increased access to the national security decision-making process.

In the later years of the Eisenhower presidency, Gordon Gray rejoined the government. As an intimate friend and golfing partner of Prescott Bush, Gray complemented the Bush influence on Ike. The Bush-Gray family partnership in the "secret government" continues up through the George Bush presidency.

Gordon Gray had been appointed head of the new Psychological Strategy Board in 1951 under Averell Harriman's rule as assistant to President Truman for national security affairs. From 1958 to 1961 Gordon Gray held the identical post under President Eisenhower. Gray acted as Ike's intermediary, strategist and hand-holder, in the President's relations with the CIA and the U.S. and allied military forces.

Eisenhower did not oppose the CIA's covert action projects; he only wanted to be protected from the consequences of their failure or exposure. Gray's primary task, in the guise of "oversight" on all U.S. covert action, was to protect and hide the growing mass of CIA and related secret government activities.

It was not only covert projects which were developed by the Gray-Bush-Dulles combination; it was also new, hidden structures of the United States government.

Senator Henry Jackson challenged these arrangements in 1959 and 1960. Jackson created a Subcommittee on National Policy Machinery of the Senate Committee on Governmental Operations, which investigated Gordon Gray's reign at the National Security Council. On January 26, 1960, Gordon Gray warned President Eisenhower that a document revealing the existence of a secret part of the U.S. government had somehow gotten into the bibliography being used by Senator Jackson. The unit was Gray's "5412 Group" within the administration, officially but secretly in charge of approving covert action. Under Gray's guidance, Ike "was clear and firm in his response" that Jackson's staff *not* be informed of the existence of this unit [emphasis in the original].<sup>20</sup>

On January 1, 1959, Fidel Castro took power in Cuba. Thereafter, in the last Eisenhower years, with Castro as a target and universal pretext, the fatal Cuban-vectored gangster section of the American government was assembled.

Several figures of the Eisenhower administration must be considered the fathers of this permanent Covert Action monolith, men who continued shepherding the monster after its birth in the Eisenhower era:

• Gordon Gray, the shadowy Assistant to the President for National Security Affairs, Prescott Bush's closest executive branch crony and golf partner along with Eisenhower. By 1959-60, Gray had Ike's total confidence and served as the Harrimanites' monitor on all U.S. military and non-military projects.

British intelligence agent Kim Philby defected to the Russians in 1963. Philby had gained virtually total access to U.S. intelligence activities beginning in 1949, as the British secret services' liaison to the Harriman-dominated CIA. After Philby's defection, it seemed obvious that the aristocratic British intelligence service was in fact a menace to the western cause. In the 1960s, a small team of U.S. counterintelligence specialists went to England to investigate the situation. They reported back that the British secret service could be thoroughly trusted. The leader of this "expert" team, Gordon Gray, was the head of the counterespionage section of the President's Foreign Intelligence Advisory Board (PFIAB) for Presidents Kennedy through Ford.

- **Robert Lovett**, Bush's Jupiter Island neighbor and Brown Brothers Harriman partner, from 1956 on a member of the President's Foreign Intelligence Advisory Board. Lovett later claimed to have criticized—from the "inside"—the plan to invade Cuba at the Bay of Pigs. Lovett was asked to choose the cabinet for John Kennedy in 1961.

- **CIA Director Allen Dulles**, Bush's former international attorney. Kennedy fired Dulles after the Bay of Pigs invasion, but Dulles served on the Warren Commission, which whitewashed President Kennedy's murder.

- **C. Douglas Dillon**, neighbor of Bush on Jupiter Island, became undersecretary of state in 1958 after the death of John Foster Dulles. Dillon had been John Foster Dulles's ambassador to France (1953-57), coordinating the original U.S. covert backing for the French imperial effort in Vietnam, with catastrophic results for the world. Dillon was treasury secretary for both John Kennedy and Lyndon Johnson.

- **Ambassador to Britain Jock Whitney**, extended family member of the Harrimans and neighbor of Prescott Bush on Jupiter Island. Whitney set up a press service in London called Forum World Features, which published propaganda furnished directly by the CIA and the British intelligence services. Beginning in 1961, Whitney was chairman of the British Empire's "English Speaking Union."

- **Senator Prescott Bush**, friend and counselor of President Eisenhower.

Bush's term continued on in the Senate after the Eisenhower years, throughout most of the aborted Kennedy presidency.

In 1962, the National Strategy Information Center was founded by Prescott Bush and his son Prescott, Jr., William Casey (the future CIA chief), and Leo Cherne. The center came to be directed by Frank Barnett, former program officer of the Bush family's Smith Richardson Foundation. The center conduited funds to the London-based Forum World Features, for the circulation of CIA-authored "news stories" to some 300 newspapers internationally.<sup>21</sup>

"Democrat" Averell Harriman rotated back into official government in the Kennedy administration. As assistant secretary and undersecretary of state, Harriman helped push the United States into the Vietnam War. Harriman had no post in the Eisenhower administration. Yet he was perhaps more than anyone the leader and the glue for the incredible evil that was hatched by the CIA in the final Eisenhower years: a half-public, half-private Harrimanite army, never since demobilized, and increasingly associated with the name of Bush.

Following the rise of Castro, the U.S. Central Intelligence Agency contracted with the organization of Mafia boss Meyer Lansky to organize and train assassination squads for use against the Cuban government. Among those employed were John Rosselli, Santos Trafficante, and Sam Giancana. Uncontested public documentation of these facts has been published by congressional bodies and by leading Establishment academics.<sup>22</sup>

But the disturbing implications and later consequences of this engagement are a crucial matter for further study by the citizens of every nation. This much is established:

On August 18, 1960, President Eisenhower approved a \$13 million official budget for a secret CIA-run guerrilla war against Castro. It is known that Vice President Richard M. Nixon took a hand in the promotion of this initiative. The U.S. military was kept out of the covert action plans until very late in the game.

The first of eight admitted assassination attempts against Castro took place in 1960.

The program was, of course, a failure, if not a circus. The invasion of Cuba by the CIA's anti-Castro exiles was put off until after John Kennedy took over the presidency. As is well known, Kennedy balked at sending in U.S. air cover and Castro's forces easily prevailed. But the program continued.

In 1960, Felix Rodriguez, Luis Posada Carriles, Rafael "Chi Chi" Quintero, Frank Sturgis (or "Frank Fiorini") and other Florida-based Cuban exiles were trained as killers and drug traffickers in the Cuban initiative; their supervisor was E. Howard Hunt. Their overall CIA boss was Miami station chief Theodore G. Shackley, seconded by Thomas Clines. In later chapters we will follow the subsequent careers of these characters—increasingly identified with George Bush—through the Kennedy assassination, the Watergate coup, and the Iran-Contra scandal.

## 5. The Silver Spoon

George Herbert Walker Bush was born in Milton, Massachusetts, on June 12, 1924. During the next year the family moved to Greenwich, Connecticut, and established their permanent residence.

Prescott and Dorothy Walker Bush had had a son, Prescott, Jr., before George. Later there was a little sister, Nancy, and another brother, Jonathan; a fourth son, William ("Bucky"), was born 14 years after George, in 1939.

George was named after his grandfather, George Herbert Walker. Since George's mother called Grandfather Walker "Pop," she began calling her son, his namesake, "little Pop," or "Poppy." Hence, Poppy Bush is the name the President's family friends have called him since his youth.

Prescott, Sr. joined W.A. Harriman & Co. May 1, 1926. With his family's lucrative totalitarian projects, George Bush's childhood began in comfort and advanced dramatically to luxury and elegance.

The Bushes had a large, dark-shingled house with "broad verandas and a portecochere" (originally a roofed structure extending out to the driveway to protect the gentry who arrived in coaches) on Grove Lane in the Deer Park



section of Greenwich.<sup>1</sup>

Here they were attended by four servants—three maids, one of whom cooked, and a chauffeur.

The U.S.A. was plunged into the Great Depression beginning with the 1929-31 financial collapse. But George Bush and his family were totally insulated from this crisis. Before and after the crash, their lives were a frolic, sealed off from the concerns of the population at large.

During the summers, the Bushes stayed in a second home on the family's ten-acre spread at Walker's Point at Kennebunkport, Maine. Flush from the Soviet oil deals and the Thyssen-Nazi Party arrangements, Grandfather Walker had built a house there for Prescott and Dorothy. They and other well-to-do summer colonists used Kennebunkport's River Club for tennis and the club's yachting facilities.

In the winter season, they took the train to Grandfather Walker's plantation, called "Duncannon," near Barnwell, South Carolina. The novices were instructed in skeet shooting, then went out on horseback, following the hounds in pursuit of quail and dove. George's sister Nancy recalled "the care taken" by the servants "over the slightest things, like the trimmed edges of the grapefruit. We were waited on by the most wonderful black servants who would come into the bedrooms early in the morning and light those crackling pine-wood fires. . . ."<sup>2</sup>

The money poured in from the Hamburg-America steamship line, its workforce crisply regulated by the Nazi Labor Front. The family took yet another house at Aiken, South Carolina. There the Bush children had socially acceptable "tennis and riding partners. Aiken was a southern capital of polo in those days, a winter resort of considerable distinction and serenity that attracted many Northerners, especially the equestrian oriented. The Bush children naturally rode there, too. . . ."<sup>3</sup> Averell Harriman, a world-class polo player, also frequented Aiken.

Poppy Bush's father and mother anxiously promoted the family's distinguished lineage, and its growing importance in the world. Prescott Bush claimed that he "could trace his family's roots back to England's King Henry III, making George a thirteenth cousin, twice removed of Queen Elizabeth."<sup>4</sup>

This particular conceit may be a bad omen for President Bush. The cowardly, acid-tongued Henry III was defeated by France's Louis IX (Saint Louis) in Henry's grab for power over France and much of Europe. Henry's own barons at length revolted against his blundering arrogance, and his power was curbed.

As the 1930s economic crisis deepened, Americans experienced unprecedented hardship and fear. The Bush children were taught that those who suffered these problems had no one to blame but themselves.

A hack writer, hired to puff President Bush's "heroic military background," wrote these lines from material supplied by the White House:

"Prescott Bush was a thrifty man. . . . He had no sympathy for the nouveau riches who flaunted their wealth—they were without class, he said. As a sage and strictly honest businessman, he had often turned failing companies around, making them profitable again, and he

**"As the 1930s economic crisis deepened, Americans experienced unprecedented hardship and fear. The Bush children were taught that those who suffered these problems had no one to blame but themselves."**

had scorn for people who went bankrupt because they mismanaged their money. Prescott's lessons were absorbed by young George. . . ."<sup>5</sup>

When he reached the age of five, George Bush joined his older brother Pres in attending the Greenwich Country Day School. The brothers' "lives were charted from birth. Their father had determined that his sons would be . . . educated and trained to be members of America's elite. . . . Greenwich Country Day School [was] an exclusive all-male academy for youngsters slated for private secondary schools. . . ."

"Alec, the family chauffeur, drove the two boys to school every morning after dropping Prescott, Sr. at the railroad station for the morning commute to Manhattan. The Depression was nowhere in evidence as the boys glided in the family's black Oldsmobile past the stone fences, stables, and swimming pools of one of the wealthiest communities in America."<sup>6</sup>

But though the young George Bush had no concerns about his material existence, one must not overlook the important, private anxiety gnawing at him from the direction of his mother.

The President's wife, Barbara, has put most succinctly the question of Dorothy Bush and her effect on George: "*His mother was the most competitive living human.*"<sup>7</sup>

If we look here in his mother's shadow, we may find something beyond the routine medical explanations for President Bush's "driven" states of rage, or hyperactivity.

Mother Bush was the best athlete in the family, the fastest runner. She was hard. She expected others to be hard. They must win, but they must always appear not to care about winning.

This is put politely, delicately, in a "biography" written by an admiring friend of the President: "She was with them day after day, . . . often curbing their egos as only a marine drill instructor can. Once when . . . George lost a tennis match, he explained to her that he had been off his game that morning. She retorted, 'You don't have a game.'<sup>8</sup>

According to this account, Barbara was fascinated by her mother-in-law's continuing ferocity: "George, playing mixed doubles with Barbara on the Kennebunkport court, ran into a porch and injured his right shoulder blade. 'His mother said it was my ball to hit, and it happened because I didn't run for it. She was probably right,' Barbara told [an interviewer]. . . . When a discussion of someone's game came up, as Barbara described it, 'if Mrs. Bush would say, 'She had some good shots,' it meant she stank. That's just the way she got the message across. When one of the grandchildren brought this girl home, everybody said, 'We think he's going to marry her,' and she said, 'Oh, no, she won't play net.'<sup>9</sup> (I.e., she was not tough enough to stand

unflinchingly and return balls hit to her at close range.)

A goad to *rapid motion* became embedded in his personality. It is observable throughout George Bush's life.

A companion trait was Poppy's uncanny urge, his master obsession with the need to "kiss up," to propitiate those who might in any way advance his interests. A life of such efforts could at some point reach a climax of released rage, where the triumphant one may finally say, "Now it is only I who must be feared."

This dangerous cycle began very early, a response to his mother's prodding and intimidation; it intensified as George became more able to calculate his advantage.

His mother says: "George was a most unselfish child. When he was only a little more than two years old ... we bought him one of those pedal cars you climb into and work with your feet.

"[His brother] Pres knew just how to work it, and George came running over and grabbed the wheel and told Pres he should 'have half,' meaning half of his new possession. 'Have half, have half,' he kept repeating, and for a while around the house we called him 'Have half.'"<sup>10</sup>

George "learned to ask for no more than what was due him. Although not the school's leading student, his report card was always good, and his mother was particularly pleased that he was always graded 'excellent' in one category she thought of great importance: 'Claims no more than his fair share of time and attention.' This consistent ranking led to a little family joke—George always did best in 'Claims no more.'

"He was not a selfish child, did not even display the innocent possessiveness common to most children. ..."<sup>11</sup>

---

## At Andover

George Bush left Greenwich Country Day School in 1936. He joined his older brother at Phillips Academy in Andover, Massachusetts, 20 miles north of Boston. "Poppy" was 12 years old, handsome, and rich. Though the U.S. economy took a savage turn for the worse the following year, George's father was piling up a fortune, arranging bond swindles for the Nazis with John Foster Dulles.

Only about one in 14 U.S. secondary school students could afford to be in private schools during George Bush's stay at Andover (1936-42). The New England preparatory or "prep" schools were the most exclusive. Their students were almost all rich white boys, many of them Episcopalians. And Andover was, in certain strange ways, the most exclusive of them all.

A 1980 campaign biography prepared by Bush's own staff concedes that "it was to New England that they returned to be educated at select schools that produce leaders with a patrician or aristocratic stamp—adjectives, incidentally, which cause a collective wince among the Bushes.... At the close of the 1930s... these schools... brought the famous 'old-boy networks' to the peak of their power."<sup>12</sup>

These American institutions have been consciously modeled on England's elite private



AUV house, George Bush's secret society at Andover prep school, where death, sadism, and humiliation were celebrated. Inset: The number "321" on AUV's seal is a status symbol showing its affiliation with Yale's Skull & Bones, which calls itself "322."

**"Secret societies for the school's children, modeled on the barbarian orders at Yale, were now established at Andover. Official school advisers were assigned to each secret society, who participated in their cruel and literally insane rituals."**

schools (confusingly called "public" schools because they were open to all English boys with sufficient money). The philosophy inculcated into the son of a British Lord Admiral or South African police chief, was to be imbibed by sons of the American republic.

George made some decisive moral choices about himself in these first years away from home. The institution which guided these choices, and helped shape the peculiar obsessions of the 41st President, was a pit of Anglophile aristocratic racialism when George Bush came on the scene.

"Andover was... less dedicated to 'elitism' than some [schools]... There were even a couple of blacks in the classes, tokens of course, but this at a time when a black student at almost any other Northeastern prep school would have been unthinkable."<sup>13</sup>

Andover had a vaunted "tradition," intermingled with the proud bloodlines of its students and alumni, that was supposed to reach back to the school's founding in 1778. But a closer examination reveals this "tradition" to be a fraud. It is part of a larger, highly significant historical fallacy perpetrated by the Anglo-Americans—and curiously stressed by Bush's agents in foreign countries.

Thomas Cochran, a partner of the J.P. Morgan banking firm, donated considerable sums to construct swanky new Andover buildings in the 1920s. Among these were George Washington Hall and Paul Revere Hall, named for leaders of the American Revolution against the British Empire. These and similar "patriotic" trappings, with the alumni's old school-affiliated genealogies, might seem to indicate an unbroken line of racial imperialists like Cochran and his circle, reaching back to the heroes of the Revolution!

Let us briefly tour Andover's history, and then ponder whether General Washington would want to be identified with Poppy Bush's school.

Thirty years after Samuel Phillips founded the Academy at Andover, Massachusetts, the quiet little school became embroiled in a violent controversy. On one side were certain die-hard pro-British families, known as Boston Brahmins, who had prospered in the ship transportation of rum and black slaves. They had regained power in Boston since their allies had lost the 1775-83 Revolutionary War.

In 1805 these cynical, neo-pagan, "Tory" families succeeded in placing their representative in the Hollis chair of Philosophy at Harvard College. The Tories, parading publicly as liberal religionists called Unitarians, were opposed by American nationalists led by the geographer-historian Rev. Jedidiah Morse (1761-1826). The nationalists rallied the Christian churches of the northeastern states behind a plan to establish, at Andover, a new religious institution which would counter the British spies, atheists, and criminals who had taken over Harvard.

British Empire political operatives Stephen Higginson, Jr. and John Lowell, Jr. published counterattacks against Rev. Morse, claiming he was trying to rouse the lower classes of citizens to hatred against the wealthy merchant families. Then the Tories played the "conservative" card. Ultra-orthodox Calvinists, actually business partners to the Harvard liberals, threatened to set up their own religious institution in Tory-dominated Newburyport. Their assertion, that Morse was not conservative enough, split the resources of the region's Christians, until the Morse group reluctantly brought the Newburyport ultras as partners into the management of the Andover Theological Seminary in 1808.

The new theological seminary and the adjacent boys' academy were now governed together under a common board of trustees (balanced between the Morse nationalists and the Newburyport anti-nationalists, the opposing wings of the old Federalist Party).

Jedidiah Morse made Andover the headquarters of a rather heroic, anti-racist, Christian missionary movement, bringing literacy, printing presses, medicine, and technological education to Southeast Asia and American Indians, notably the Georgia Cherokees. This activist Andover doctrine of racial equality and American Revolutionary spirit was despised and feared by British opium pushers in East Asia and by Boston's blueblood Anglophiles. Andover missionaries were eventually jailed in Georgia; their too-modern Cherokee allies were murdered and driven into exile by pro-slavery mobs.

When Jedidiah Morse's generation died out, the Andover missionary movement was crushed by New England's elite families—who were then Britain's partners in the booming opium traffic. Andover was still formally Christian after 1840; Boston's cynical Brahmins used Andover's orthodox Protestant board to prosecute various of their opponents as "heretics."

Neo-paganism and occult movements bloomed after the Civil War with Darwin's new materialist doctrines. In the 1870s, the death-worshipping Skull and Bones Society sent its alumni members back from Yale University, to organize aristocratic secret satanic societies for the teenagers at the Andover prep school. But these cults did not yet quite flourish. National power was still precariously balanced between the imperial Anglo-American financiers, and the old-line nationalists who built America's railroads, steel and electrical industries.

The New Age aristocrats proclaimed their victory under Theodore Roosevelt's presidency (1901-09). The Andover Theological Seminary wound up its affairs and moved out of town, to be merged with the Harvard Divinity School! Andover prep school was now largely free of the annoyance of religion, or any connection whatsoever with the American spirit. Secret societies for the school's children, modeled on the barbarian orders at Yale, were now established in permanent, incorporated headquarters buildings just off campus at Andover. Official school advisers were assigned to each secret society, who participated in their cruel and literally insane rituals.

When J.P. Morgan partner Thomas Cochran built Andover's luxurious modern campus for boys like Poppy Bush, the usurpers of America's name had cause to celebrate. Under their supervision, fascism was rising in Europe. The new campus library was named for Oliver Wendell Holmes, Andover class of 1825. This dreadful poet of the "leisure class," a tower of Boston blue-blooded conceit, was famous as the father of the twentieth century U.S. Supreme Court justice. His son, Oliver Wendell Holmes, Jr., symbolized the arbitrary rule of the racial purity advocates, the usurpers, over American society.

---

## The Secret Societies

Andover installed a new headmaster in 1933. Claude Moore Fuess (rhymes with fleece) replaced veteran headmaster Alfred E. Stearns, whom the Brahmins saw as a dyed-in-the-wool reactionary. Stearns was forced out over a "scandal": a widower, he had married his housekeeper, who was beneath his social class.

The new headmaster was considered forward-looking and flexible, to meet the challenges of the world political crisis: for example, Fuess favored psychiatry for the boys, something Stearns wouldn't tolerate.

Claude Fuess had been an Andover history teacher since 1908, and gained fame as an historian. He was one of the most skillful liars of the modern age.

Fuess had married into the Boston Cushing family. He had written the family-authorized

whitewash biography of his wife's relative, Caleb Cushing, a pro-slavery politician of the middle nineteenth century. The outlandish, widely known corruption of Cushing's career was matched by Fuess's bold, outrageous coverup.<sup>14</sup>

During George Bush's years at Andover, his headmaster, Fuess, wrote an authorized biography of Calvin Coolidge, the late U.S. President. This work was celebrated in jest as a champion specimen of unwholesome flattery. In other books, also about the bluebloods, Fuess was simply given the family papers and designated the chief liar for the "Bostonian Race."

Both the Cushing and Coolidge families had made their fortunes in opium trafficking. Bush's headmaster named his son John Cushing Fuess, perhaps after the fabled nineteenth century dope kingpin who had made the Cushings rich.<sup>15</sup>

Headmaster Fuess used to say to his staff, "I came to power with Hitler and Mussolini."<sup>16</sup> This was not merely a pleasantry, referring to his appointment the year Hitler took over Germany.

In his 1939 memoirs, Headmaster Fuess expressed the philosophy which must guide the education of the well-born young gentlemen under his care:

"Our declining birth rate . . . may perhaps indicate a step towards national deterioration. Among the so-called upper and leisure classes, noticeably among the university group, the present birth rate is strikingly low. Among the Slavonic and Latin immigrants, on the other hand, it is relatively high. We seem thus to be letting the best blood thin out and disappear; while at the same time our humanitarian efforts for the preservation of the less fit, those who for some reason are crippled and incapacitated, are being greatly stimulated. The effect on the race will not become apparent for some generations and certainly cannot now be accurately predicted; but the phenomenon must be mentioned if you are to have a true picture of what is going on in the United States."<sup>17</sup>

Would George Bush adopt this anti-Christian outlook as his own? One can never know for sure how a young person will respond to the doctrines of his elders, no matter how cleverly presented. There is a much higher degree of certainty that he will conform to criminal expectations, however, if the student is brought to practice cruelty against other youngsters, and to degrade himself in order to get ahead. At Andover, this was where the secret societies came in.

Nothing like Andover's secret societies existed at any other American school. What were they all about?

Bush's friend Fitzhugh Greene wrote in 1989: "Robert L. 'Tim' Ireland, Bush's longtime supporter [and Brown Brothers Harriman partner], who later served on the Andover board of trustees with him, said he believed [Bush] had been in AUV. 'What's that?' I asked. 'Can't tell you,' laughed Ireland. 'It's secret!' Both at Andover and Yale, such groups only bring in a small percentage of the total enrollment in any class. 'That's a bit cruel to those who don't make AU[V] or 'Bones,'" conceded Ireland.<sup>18</sup>



Andover Headmaster Claude M. Fuess

A retired teacher, who was an advisor to one of the groups, cautiously disclosed in his bicentennial history of Andover, some aspects of the secret societies. The reader should keep in mind that this account was published by the school, to celebrate itself: "A charming account of the early days of K.O.A, the oldest of the Societies, was prepared by Jack [i.e. Claude Moore] Fuess, a member of the organization, on the occasion of their Fiftieth Anniversary. The Society was founded in . . . 1874. . . ."

"[A] major concern of the membership was the initiation ceremony. In K.O.A. the ceremony involved visiting one of the local cemeteries at midnight, various kinds of tortures, running the gauntlet—though the novice was apparently punched rather than paddled, being baptized in a water tank, being hoisted in the air by a pulley, and finally being placed in a coffin, where he was cross-examined by the members. . . . K.O.A. was able to hold the loyalty of its members over the years to become a powerful institution at Phillips Academy and to erect a handsome pillared Society house on School Street.

"The second Society of the seven that would survive until 1950 was A.U.V. [George Bush's group]. The letters stood for Auctoritas, Unitas, Veritas. [Authority, Unity, Truth]. This organization resulted from a merger of two . . . earlier Societies . . . in 1877. A new constitution was drawn up . . . providing for four chief officers—Imperator [commander], Vice Imperator [vice-commander], Scriptor [secretary], and Quaesor [magistrate or inquisitor]. . . ."

"Like K.O.A., A.U.V. had an elaborate initiation ceremony. Once a pledge had been approved by the Faculty, he was given a letter with a list of rules he was to follow. He was to be in the cemetery every night from 12:30 to 5:00, deliver a morning paper to each member of the Society each morning, must not comb or brush his hair nor wash his face or hands, smoke nothing but a clay pipe with Lucky Strike tobacco, and not speak to any student except members of A.U.V.

"After the pledge had memorized these rules, his letter of instruction was burned. The pledge had now become a 'scut' and was compelled to learn many mottoes and incantations. On Friday night of initiation week the scut was taken to Hartigan's drugstore downtown and given a 'scut sundae,' which consisted of pepper, ice cream, oysters, and raw liver. Later that night he reported to the South Church cemetery, where he had to wait for two hours for the members to arrive. There followed the usual horseplay—the scut was used as a tackling dummy, threats were made to lock him in a tomb, and various other ceremonies observed. On Saturday afternoon the scut was taken on a long walk around town, being forced to stop at some houses and ask for food, to urinate on a few porches, and generally to make a fool of himself. On Saturday night came the initiation proper. The scut was prepared by reporting to the cellar in his underwear and having dirt and flour smeared all over his body. He was finally cleaned up and brought to the initiation room, where a solemn ceremony followed, ending with the longed-for words 'Let him have light,' at which point his blindfold was removed, some oaths were administered, and the boy was finally a member. . . ." 19

#### Notes for Chapter 4

16. Richardson to Prescott Bush, June 10, 1954. H. Smith Richardson Papers, University of North Carolina, Chapel Hill.
17. Wayne S. Cole, *America First: The Battle Against Intervention, 1940-1941* (Madison: the University of Wisconsin Press, 1953); Interviews with Richardson family employees; H. Smith Richardson Foundation annual reports; Richardson to Prescott Bush, March 26, 1954, Richardson Papers. *Washington Post*, April 29, 1990.
18. Richardson to Chase Bank executive Cole Younger, Sept. 17, 1952, H. Smith Richardson Papers, University of North Carolina, Chapel Hill.
19. Parmet, Herbert S., *Eisenhower and the American Crusades* (New York: MacMillan Company, 1972), p. 481.
20. John Prados, *Keepers of the Keys: A History of the National Security Council from Truman to Bush* (New York: William Morrow, 1991) pp. 92-95.
21. Robert Callaghan in *Covert Action*, No. 33, Winter 1990. Prescott, Jr. was a board member of the National Strategy Information Center as of 1991. Both Prescott Sr. and Jr. were deeply involved along with Casey in the circles of Pan American Airlines, Pan Am's owners the Grace family, and the CIA's Latin American affairs. The Center, based in Washington D.C., declines public inquiries about its founding.

See also *EIR Special Report*, "American Leviathan: Administrative Fascism under the Bush Regime" (Wiesbaden, Germany: Executive Intelligence Review Nachrichtensagentur, April, 1990), p. 192.

22. For example, see Trumbull Higgins, *The Perfect Failure: Kennedy, Eisenhower, and the CIA at the Bay of Pigs* (New York: W.W. Norton and Co., 1987), pp. 55-56, 89-90.

Unverified information on the squads is provided in the affidavit of Daniel P. Sheehan, attorney for the Christic Institute, reproduced in *EIR Special Report* "Project Democracy: The 'Parallel Government' behind the Iran Contra Affair" (Washington, D.C.: Executive Intelligence Review, 1987), pp. 249-50.

Some of the hired assassins have published their memoirs. See, for example Felix Rodriguez and John Weisman, *Secret Warrior* (New York: Simon and Schuster, 1989); and E. Howard Hunt, *Undercover: Memoirs of an American Secret Agent* (New York: G.P. Putnam's Sons, 1974).

#### Notes for Chapter 5

1. Nicholas King, *George Bush: A Biography* (New York: Dodd, Mead & Company, 1980), pp. 13-14.
2. *Ibid.*, p. 19.
3. *Ibid.*
4. Joe Hyams, *Flight of the Avenger: George Bush at War* (New York: Harcourt, Brace, Jovanovitch, 1991), p. 14.



Arthur Burr Darling, George Bush's history teacher. He wrote the CIA's official, falsified, secret history.

5. *Ibid.*, p. 17.
6. *Ibid.*, pp. 16-17.
7. Donnie Radcliffe, *Simply Barbara Bush* (New York: Warner Books, 1989), p. 132.
8. Fitzhugh Green, *George Bush: An Intimate Portrait* (New York: Hippocrene Books, 1989), p. 16.
9. Radcliffe, *op. cit.*, p. 133.
10. King, *op. cit.*, p. 14.
11. Hyams, *op. cit.*, pp. 17-19.
12. King, *op. cit.*, pp. 10, 20.
13. *Ibid.*, p. 21.
14. Claude M. Fuess, *The Life of Caleb Cushing*, 2 vols. (New York: Harcourt, Brace and Company, 1923).
15. John Perkins Cushing was a multi-millionaire opium smuggler who retired to Watertown, Massachusetts with servants dressed as in a Canton gangster carnival. See Vernon L. Briggs, *History and Genealogy of the Cabot Family, 1475-1927* (Boston: privately printed, 1927), Vol. II, pp. 558-559. John Murray Forbes, *Letters and Recollections*, (reprinted New York: Arno Press, 1961), Vol. I, p. 62-63. Mary Caroline Crawford, *Famous Families of Massachusetts* (Boston: Little, Brown & Co., 1930), 2 vols.
16. Interview with a retired Andover teacher.
17. Claude M. Fuess, *Creed of a Schoolmaster* (reprinted Freeport, New York: Books for Libraries Press, 1970), pp. 192-93.
18. Green, *op. cit.*, p. 49.
19. Frederick S. Allis, *Youth from Every Quarter: A Bicentennial History of Phillips Academy, Andover* (Andover, Mass.: Phillips Academy, 1979), distributed by the University Press of New England, Hanover, N.H.), pp. 505-7.



Two of George Bush's prep school secret society brothers. On the right is Godfrey ("Rocky") Rockefeller, a great-nephew of Bush family patron Percy Rockefeller.

The hierarchical top banana of the AUV secret society in George's 1942 Andover class was Godfrey Anderson ("Rocky") Rockefeller. In the yearbook just above the AUV roster is a photograph of "Rocky Rockefeller" and "Lem [Lehman F.] Beardsley"; Rockefeller stands imperiously without a shirt, Beardsley scowls from behind sunglasses. Certainly the real monarch of George Bush's Andover secret society, and George's sponsor, was this "Rocky" 's father, Godfrey S. Rockefeller.

The latter gentleman had been on the staff of the Yale University establishment in China in 1921-22. Yale and the Rockefellers were breeding a grotesque communist insurgency with British Empire ideology; another Yale staffer there was Mao Zedong, later the communist dictator and mass murderer. While he was over in China, Papa Godfrey's cousin Isabel had been the bridesmaid at the wedding of George Bush's parents. His Uncle Percy had co-founded the Harriman bank with George Walker, and backed George Bush's father in several Nazi German enterprises. His grandfather had been the founding treasurer of the Standard Oil Company, and had made the Harrimans (and thus ultimately George Bush) rich.

Faculty adviser to AUV in those days was Norwood Penrose Hallowell; his father by the same name was chairman of Lee, Higginson & Co. private bankers, the chief financiers of Boston's extreme racist political movements. The elder Hallowell was based in London throughout the 1930s, on intimate terms with Montagu Norman and his pro-Hitler American banking friends. . . .

One of Poppy Bush's teachers at Andover, now in retirement, offered to an interviewer for this book, a striking picture of his former pupil. How was the President as a student?

"He never said a word in class. He was bored to death. And other teachers told me Bush was the worst English student ever in the school."

But was this teenager simply slow, or dull? On the contrary.

"He was the classic 'BMO' (Big Man On Campus). A great glad-hander. Always smiling."<sup>21</sup> . . .

George Bush was the most insistent self-promoter on the campus. He was able to pursue this career, being fortunately spared from the more mundane chores some other students had to do. For example, he mailed his dirty laundry home each week, to be done by the servants. It was mailed back to him clean and folded.<sup>22</sup> . . .

One may ask, in what way are President Bush and his backers conscious of an oligarchical tradition? For a clue, let us look at the case of Arthur Burr Darling, George Bush's prep school history teacher.

Just after Claude Fuess "came into power with Hitler and Mussolini" in 1933, Fuess brought [Arthur Burr] Darling in to teach. Dr. Darling was head of the Andover history department from 1937 to 1956, and Faculty Guardian of one of the secret societies. His *Political Changes in Massachusetts, 1824 to 1848* covered the period of Andover's eclipse by Boston's aristocratic opium lords. Darling's book attacks Andover's greatest humanitarian, Jedidiah Morse, as a dangerous lunatic, because Morse warned about international criminal conspira-

cies involving these respectable Bostonians. The same book attacks President John Quincy Adams as a misguided troublemaker, responsible with Morse for the anti-freemasonic movement in the 1820s-30s.

Arthur Burr Darling, while still head of Andover's history department, was chosen by the Harrimanites to organize the historical files of the new Central Intelligence Agency, and to write the CIA's own official account of its creation and first years. Since this cynical project was secret, Darling's 1971 obituary did not reflect his CIA employment.<sup>20</sup>

Darling's *The Central Intelligence Agency: An Instrument of Government, to 1950* was classified Secret on its completion in December 1953. . . . This mercenary work was finally declassified in 1989 and was published by Pennsylvania State University in 1990. Subsequent editions of *Who Was Who in America* were changed, in the fashion of Joe Stalin's "history revisers," to tell the latest, official version of what George Bush's history teacher had done with his life. . . .

Secretary of War Henry Stimson, who was also the president of the board of Andover Prep, made a famous speech in June 1942, to Poppy Bush and the other graduating Andover boys. Stimson told them the war would be long, and they, the elite, should go on to college.

But George Bush had some very complicated problems. The decision had already been made that he would join the service and get quite far away from where he had been. For reasons of family (which will be discussed in Chapter 7 on *Skull and Bones*) there was a very special niche waiting for him in naval aviation.

There was one serious hitch in this plan. It was illegal. Though he would be 18 years old on June 12, he would not have the two years of college the Navy required for its aviators.

Well, if you had an *urgent* problem, perhaps the law could be simply *set aside, for you and you alone*, ahead of all the 5 million poor slobs who had to go in the mud with the infantry or swab some stinking deck—especially if your private school's president was currently Secretary of War (Henry Stimson), if your father's banking partner was currently Assistant Secretary of War for Air (Robert Lovett), and if your father had launched the career of the current Assistant Navy Secretary for Air (Artemus Gates).

And it was done.

As a Bush-authorized version puts it, "One wonders why the Navy relaxed its two years of college requirement for flight training in George Bush's case. He had built an outstanding record at school as a scholar [sic], athlete and campus leader, but so had countless thousands of other youths.

"Yet it was George Bush who appeared to be the only beneficiary of this rule-waiving, and thus he eventually emerged as the youngest pilot in the Navy—a fact that he can still boast about and because of which he enjoyed a certain celebrity during the war."<sup>24</sup>

#### Notes

21. Spoke on condition of non-attribution.

22. Hyams, *op. cit.*, pp. 23-24.

30. See *New York Times*, Nov. 29, 1971.

32. Allis, *op. cit.*, p. 512.

33. *Newsweek*, August 9, 1943; *Boston Globe*, July 22, 1943.

34. Green, *op. cit.*, page 28.

## Bush in World War II

*Plut aux dieux que ce fut le dernier de ses crimes!\**

—*Racine, Britannicus*

George Bush has always traded shamelessly on his alleged record as a naval aviator during the Second World War in the Pacific theatre. During the 1964 Senate campaign in Texas against Senator Ralph Yarborough, Bush televised a grainy old film which depicted young George being rescued at sea by the crew of the submarine *USS Finnback* after his Avenger torpedo bomber was hit by Japanese anti-aircraft fire during a bombing raid on the island of Chichi Jima on September 2, 1944. That film, retrieved from the Navy archives, backfired when it was put on the air too many times, eventually becoming something of a maladroit cliché.

Bush's campaign literature has always celebrated his alleged military exploits and the Distinguished Flying Cross he received. As we become increasingly familiar with the power of the Brown Brothers Harriman/Skull and Bones network working for Senator Prescott Bush, we will learn to become increasingly skeptical of such official accolades and of the official accounts on which they are premised.

During Bush's Gulf war adventure of 1990-91, the adulation of Bush's ostensible warrior prowess reached levels that were previously considered characteristic of openly totalitarian and militaristic regimes. Late in 1990, after Bush had committed himself irrevocably to his campaign of bombing and savagery against

Iraq, hack writer Joe Hyams completed an authorized account of George Bush at war. This was entitled *Flight of the Avenger*, and appeared during the time of the Middle East conflagration that was the product of Bush's obsessions.

Hyams's work had the unmistakable imprimatur of the regime: Not just George, but also Barbara had been interviewed during its preparation, and its adulatory tone placed this squalid text squarely within the "red Studebaker" school of political hagiography.

The appearance of such a book at such a time is suggestive of the practice of the most infamous twentieth-century dictatorships, in which the figure of the strong man, Fuehrer, duce, or vozhd as he might be called, has been used for the transmission of symbolic-allegorical directives to the subject population. Was fascist Italy seeking to assert its economic autarky in food production in the face of trade sanctions by the League of Nations? Then a film would be produced by the MINCULPOP (the Ministry of Popular Culture, or propaganda) depicting Mussolini indefatigably harvesting grain. Was Nazi Germany in the final stages of preparation of a military campaign against a neighboring state? If so, Goebbels would orchestrate a cascade of magazine articles and best-selling pulp evoking the glories of Hitler in the trenches of 1914-18. Closer to our own time, Leonid Brezhnev sought to alimnt his own personality cult with a little book called *Malaya Zemlya*, an account of his war experiences which was used by his propagandists to motivate his promotion to Marshal of the U.S.S.R. and the erection of a statue in his honor during his own lifetime. This is the tradition to which *Flight of the Avenger* belongs.

Bush tells us in his campaign autobiography that he decided to enlist in the armed forces,

specifically naval aviation, shortly after he heard of the Japanese attack on Pearl Harbor. About six months later, Bush graduated from Phillips Academy at Andover, and the commencement speaker was Secretary of War Henry Stimson, *eminence grise* of the U.S. ruling elite. Stimson was possibly mindful of the hecatomb of young members of the British ruling classes which had occurred in the trenches of World War I on the western front. In any event, Stimson's advice to the Andover graduates was that the war would go on for a long time, and that the best way of serving the country was to continue one's education in college. Prescott Bush supposedly asked his son if Stimson's recommendation had altered his plan to enlist. Young Bush answered that he was still committed to join the Navy.

Henry L. Stimson was certainly an authoritative spokesman for the Eastern Liberal Establishment, and Bushman propaganda has lately exalted him as one of the seminal influences on Bush's political outlook. Stimson had been educated at both Yale (where he had been tapped by Skull and Bones) and Harvard Law School. He became the law partner of Elihu Root, who was Theodore Roosevelt's Secretary of State. Stimson had been Theodore Roosevelt's anti-corruption, trust-busting U.S. Attorney in New York City during the first years of the FBI, then Taft's secretary of war, a colonel of artillery in World War I, governor general of the Philippines for Coolidge, secretary of state for Hoover, and enunciator of the "Stimson doctrine." This last was a piece of hypocritical posturing directed against Japan, asserting that changes in the international order brought about by force of arms (and thus in contravention of the Kellogg-Briand Pact of 1928) should not be given diplomatic recognition. This amounted to a U.S. commitment to uphold the Versailles system, the same policy upheld by Baker, Eagleburger and Kissinger in the Serbian war on Slovenia and Croatia during 1991. Stimson, though a Republican, was brought into Roosevelt's war cabinet in 1940 in token of bipartisan intentions.

But in 1942, Bush was not buying Stimson's advice. It is doubtless significant that in the mind of young George Bush, World War II meant exclusively the war in the Pacific, against the Japanese. In the Bush-approved accounts of this period of his life, there is scarcely a mention of the European theatre, despite the fact that Roosevelt and the entire Anglo-American establishment had accorded strategic priority to the "Germany first" scenario. Young George, it would appear, had his heart set on becoming a Navy fier.

---

**"The Bush propaganda machine needs the fire on board the Avenger in order to justify Bush's precipitous decision to bail out, leaving his two crew members to their fate, rather than attempting the water landing which might have saved them."**



## Rules Bent for Bush

Normally the Navy required two years of college from volunteers wishing to become naval aviators. But, for reasons which have never been satisfactorily explained, young George was exempted from this requirement. Had father Prescott's crony Artemus Gates, the assistant secretary of the navy for air, been instrumental in making the exception, which was the key to allowing George to become the youngest of all navy pilots?

On June 12, 1942, his eighteenth birthday, Bush joined the Navy in Boston as a seaman second class.<sup>1</sup> He was ordered to report for active duty as an aviation cadet on August 6, 1942. After a last date with Barbara, George was taken to Penn Station in New York City by father Prescott to board a troop train headed for Chapel Hill, North Carolina. At Chapel Hill Naval Air Station, one of Bush's fellow cadets was the well-known Boston Red Sox hitter Ted Williams, who would later join Bush on the campaign trail in his desperate fight in the New Hampshire primary in February 1988.

After preflight training at Chapel Hill, Bush moved on to Wold-Chamberlain Naval Airfield in Minneapolis, Minnesota, where he flew solo for the first time in November 1942. In February 1943 Bush moved on to Corpus Christi, Texas for further training. Bush received his commission as an ensign at Corpus Christi on June 9, 1943.

After this, Bush moved through a number of naval air bases over a period of almost a year for various types of advanced training. In mid-June 1943, he was learning to fly the Grumman TBF Avenger torpedo-bomber at Fort Lauderdale, Florida. In August, he made landings on the *USS Sable*, a paddle-wheel ship that was used as an aircraft carrier for training purposes. During the summer of 1943, Bush spent a couple of weeks of leave with Barbara at Walker's Point in Kennebunkport; their engagement was announced in the *New York Times* of December 12, 1943.

Later in the summer of 1943, Bush moved on to the Naval Air Base at Norfolk, Virginia. In September 1943 Bush's new squadron, called VT-51, moved on to the Naval Air Station at Chincoteague, Virginia, located on the Delmarva peninsula. On December 14, 1943 Bush and his squadron were brought to Philadelphia to attend the commissioning of the *USS San Jacinto* (CVL30), a light attack carrier built on a cruiser hull. Since the name of the ship recalled Sam Houston's defeat of the Mexican leader Santa Ana in 1836, and since the ship flew a Lone Star flag, Bushman propaganda has made much of these artifacts in an attempt to buttress "carpetbag" Bush's tenuous connections to the state of Texas. Bush's VF-51 squadron reported on board this ship for a shake-down cruise on February 6, 1944, and on March 25, 1944 the *San Jacinto* left for San Diego by way of the Panama Canal. The *San Jacinto* reached Pearl Harbor on April 20, 1944, and was assigned to Admiral Marc A. Mitscher's Task Force 58/38, a group of fast carriers, on May 2, 1944.

## Bush Bails Out

In June, Bush's ship joined battle with Japanese forces in the Marianas archipelago. Here Bush flew his first combat missions. On June 17, a loss of oil pressure forced Bush to make an emergency landing at sea. Bush, along with his two crew members, gunner Leo Nadeau and radioman-tail gunner John L. Delaney, were picked up by a U.S. destroyer after some hours in the water. Bush's first Avenger, named by him the Barbara, was lost.

During July 1944 Bush took part in 13 air strikes, many in connection with the U.S. Marines' landing on Guam. In August, Bush's ship proceeded to the area of Iwo Jima and Chichi Jima in the Bonin Islands for a new round of sorties.

On September 2, 1944 Bush and three other Avenger pilots, escorted by Hellcat fighter planes, were directed to attack a radio transmitter on Chichi Jima. Planes from the *USS Enterprise* would also join in the attack. On this mission Bush's rear-seat gunner would not be the usual Leo Nadeau, but rather Lt. Junior Grade William Gardner "Ted" White, the squadron ordnance officer of VT-51, already a Yale graduate and already a member of Skull and Bones. White's father had been a classmate of Prescott Bush. White took his place in the rear-facing machine gun turret of Bush's TBM Avenger, the Barbara II. The radioman-gunner was John L. Delaney, a regular member of Bush's crew.

What happened in the skies of Chichi Jima that day is a matter of lively controversy. Bush has presented several differing versions of his own story. In his campaign autobiography published in 1987 Bush gives the following account:

"The flak was the heaviest I'd ever flown into. The Japanese were ready and waiting; their anti-aircraft guns were set up to nail us as we pushed into our dives. By the time VT-51 was ready to go in, the sky was thick with angry black clouds of exploding anti-aircraft fire.

"Don Melvin led the way, scoring hits on a radio tower. I followed, going into a thirty-five degree dive, an angle of attack that sounds shallow but in an Avenger felt as if you were headed straight down. The target map was strapped to my knee, and as I started into my dive, I'd already spotted the target area. Coming in, I was aware of black splotches of gunfire all around.

"Suddenly there was a jolt, as if a massive fist had crunched into the belly of the plane. Smoke poured into the cockpit, and I could see flames rippling across the crease of the wing, edging towards the fuel tanks. I stayed with the dive, homed in on the target, unloaded our four 500-pound bombs, and pulled away, heading for the sea. Once over water, I leveled off and told Delaney and White to bail out, turning the plane to starboard to take the slipstream off the door near Delaney's station.

"Up to that point, except for the sting of dense smoke blurring my vision, I was in fair shape. But when I went to make my jump, trouble came in pairs."<sup>2</sup>

In this account, there is no more mention of



White and Delaney until Bush hit the water and began looking around for them. Bush says that it was only after having been rescued by the USS *Finnback*, a submarine, that he "learned that neither Jack Delaney nor Ted White had survived. One went down with the plane; the other was seen jumping, but his parachute failed to open." The Hyams account of 1991 was written after an August 1988 interview with Chester Mierzejewski, another member of Bush's squadron, had raised important questions about the haste with which Bush bailed out, rather than attempting a water landing. Mierzejewski's account, which is summarized below, contradicted Bush's own version of these events, and hinted that Bush might have abandoned his two crew members to a horrible and needless death. The Hyams account, which is partly intended to refute Mierzejewski, develops as follows:

"... Bush was piloting the third plane over the target, with Moore flying on his wing. He nosed over into a thirty-degree glide, heading straight for the radio tower. Determined to finally destroy the tower, he used no evasive tactics and held the plane directly on target. His vision ahead was occasionally cancelled by bursts of black smoke from the Japanese anti-aircraft guns. The plane was descending through thickening clouds of flak pierced by the flaming arc of tracers.

"There was a sudden flash of light followed by an explosion. 'The plane was lifted forward, and we were enveloped in flames,' Bush recalls. 'I saw the flames running along the wings where the fuel tanks were and where the wings fold. I thought, This is really bad! It's hard to remember the details, but I looked at the instruments and couldn't see them for the smoke.'

"Don Melvin, circling above the action while waiting for his pilots to drop their bombs and get out, thought the Japanese shell had hit an oil line on Bush's Avenger. 'You could have seen that smoke for a hundred miles.'"

Perhaps so, but it is difficult to understand why the smoke from Bush's plane was so distinctly visible in such a smoke-filled environment. Hyams goes on to describe Bush's completion of his bombing run. His account continues:

"By then the wings were covered in flames and smoke, and the engine was blazing. He considered making a water landing but realized it would not be possible. Bailing out was absolutely the last choice, but he had no other option. He got on the radio and notified squadron leader Melvin of his decision. Melvin radioed back, 'Received your message. Got you in sight. Will follow.'

"[...] Milt Moore, flying directly behind Bush, saw the Avenger going down smoking. 'I pulled up to him; then he lost power and I went sailing by him.'

"As soon as he was back over water, Bush shouted on the intercom for White and Delaney to 'hit the silk!' [...] Dick Gorman, Moore's radioman-gunner, remembers hearing someone on the intercom shout, 'Hit the silk!' and asking Moore, 'Is that you, Red?'

"'No,' Moore replied. 'It's Bush, he's hit!'

"Other squadron members heard Bush repeating the command to bail out, over and over, on the radio.

"There was no response from either of Bush's crewmen and no way he could see them; a shield of armor plate between him and Lt. White blocked his view behind. He was certain that White and Delaney had bailed out the moment they got the order."<sup>3</sup>

Hyams quotes a later entry by Melvin in the squadron log as to the fate of Bush's two crewmen: "At a point approximately nine miles bearing 045°T (degrees) from Minami Jima, Bush and one other person were seen to bail out from about 3,000 feet. Bush's chute opened and he landed safely in the water, inflated his raft, and paddled farther away from Chichi Jima. The chute of the other person who bailed out did not open. Bush has not yet been returned to the squadron . . . so this information is incomplete. While Lt. junior grade White and J.L. Delaney are reported missing in action, it is believed that both were killed as a result of the above described action."<sup>4</sup>

But it is interesting to note that this report, contrary to usual standard Navy practice, has

no date. This should alert us to that tampering with public records, such as Bush's filings at the Securities and Exchange Commission during the 1960s, which appears to be a specialty of the Brown Brothers Harriman/Skull and Bones network.

For comparison, let us now cite the cursory account of this same incident provided by Bush's authorized biographer in the candidate's 1980 presidential campaign biography:

"On a run toward the island, Bush's plane was struck by Japanese anti-aircraft shells. One of his two crewmen was killed instantly and the aircraft was set on fire. Bush was able to score hits on the enemy installations with a couple of five-hundred pound bombs before he wriggled out of the smoking cockpit and floated towards the water. The other crewman also bailed out but died almost immediately thereafter because, as the fighter pilot behind Bush's plane was later to report, his parachute failed to open properly. Bush's own parachute became momentarily fouled on the tail of the plane after he hit the water."<sup>5</sup>

King's account is interesting for its omission of any mention of Bush's injury in bailing out, a gashed forehead he got when he struck the tail assembly of the plane. This had to have occurred long before Bush had hit the water, so this account is garbled indeed.

Let us also cite parts of the account provided by Fitzhugh Green in his 1989 authorized biography. Green has Bush making his attack "at a 60-degree angle." "For his two crew members," notes Green, "life was about to end." His version goes on:

"Halfway through Bush's dive, the enemy found his range with one or more shells. Smoke filled his cabin; his plane controls weakened; the engine began coughing, and still he wasn't close enough to the target. He presumed the TBM to be terminally damaged. Fighting to stay on course, eyes smarting, Bush managed to launch his bombs at the last possible moment. He couldn't discern the result through black fumes. But a companion pilot affirmed later that the installation blew up, along with two other buildings. The Navy would decorate Bush for literally sticking to his guns until he completed his mission under ferocious enemy fire.

"Good! Now the trick was to keep the plane aloft long enough to accomplish two objectives: first, get far enough away from the island to allow rescue from the sea before capture or killing by the enemy; second, give his plane mates time to parachute out of the burning aircraft.

"The TBM sputtered on its last few hundred yards. Unbeknownst to Bush, one man freed himself. Neither fellow squadron pilots nor Bush ever were sure which crew member this was. As he jumped, however, his parachute snarled and failed to open."<sup>6</sup>

Green writes that when Bush was swimming in the water, he realized that "his crew had disappeared" and that "the loss of the two men numbed Bush."

---

## Still Another Story

For the 1992 presidential campaign, the Bushmen have readied yet another rehash of the adulatory "red Studebaker" printout in the form of a new biography by Richard Ben Cramer. This is distinguished as a literary effort above all by the artificial verbal pyrotechnics with which the author attempts to breathe new life into the dog-eared Bush canonical printout. For these, Cramer relies on a hyperkinetic style with non-verbal syntax, which to some degree echoes Bush's own disjointed manner of speaking. The resulting text may have found favor with Bush when he was gripped by his hyperthyroid rages during the buildup for the Gulf war. A part of this text has appeared in *Esquire* magazine.<sup>7</sup> Here is Cramer's description of the critical phase of the incident:

"He felt a jarring lurch, a crunch, and his plane leaped forward, like a giant had struck it from below with a fist. Smoke started to fill the cockpit. He saw a tongue of flame streaming down the right wing toward the crease. Christ! The fuel tanks!

"He called to Delaney and White—We've been hit! He was diving. Melvin hit the tower dead-on—four five hundred pounders. West was on the same beam. Bush could have pulled out. Have to get rid of these bombs. Keep the dive. . . . A few seconds. . . .

"He dropped on the target and let 'em fly. The bombs spun down, the plane shrugged with release, and Bush banked away hard to the east. No way he'd get to the rendezvous point with Melvin. The smoke was so bad he couldn't see the gauges. Was he climbing? Have to get to the water. They were dead if they bailed out over land. The Japs killed pilots. Gonna have to bail out. Bush radioed the skipper, called his crew. No answer. Does White know how to get to his chute? Bush looked back for an instant. God, was White hit? He was yelling the order to bail out, turning right rudder to take the slipstream off their hatch . . . had to get himself out. He leveled off over water, only a few miles from the island . . . more, ought to get out farther . . . that's it, got to be now. . . . He flicked the red toggle switch on the dash—the IFF, Identification Friend or Foe—supposed to alert any U.S. ship, send a special frequency back to his own carrier . . . no other way to communicate, had to get out now, had to be . . . NOW."

It will be seen that these versions contain numerous internal contradictions, but that the hallmark of "red Studebaker" orthodoxy, especially after the appearance of the Mierzejewski account, is that Bush's plane was on fire, with visible smoke and flames. The Bush propaganda machine needs the fire on board the Avenger in order to justify Bush's precipitous decision to bail out, leaving his two crew members to their fate, rather than attempting the water landing which might have saved them.

The only person who has ever claimed to have seen Bush's plane get hit, and to have seen it hit the water, is Chester Mierzejewski, who was the rear turret gunner in the aircraft flown by Squadron Commander Douglas Melvin. During 1987-88, Mierzejewski became increasingly indignant as he watched Bush repeat his canonical account of how he was shot down. Shortly before the Republican National Convention in 1988, Mierzejewski, by then a 68-year-old retired aircraft foreman living in Cheshire, Connecticut, decided to tell his story to Allan Wolper and Al Ellenberg of the *New York Post*, which printed it as a copyrighted article.<sup>8</sup>

"That guy is not telling the truth," Mierzejewski said of Bush.

As the rear-looking turret gunner on Commander Melvin's plane, Mierzejewski had the most advantageous position for observing the events in question here. Since Melvin's plane flew directly ahead of Bush's, he had a direct and unobstructed view of what was happening aft of his own plane. When the *New York Post* reporters asked former Lt. Legare Hole, the executive officer of Bush's squadron, about who might have best observed the last minutes of the Barbara II, Hole replied: "The turret gunner in Melvin's plane would have had a good view. If the plane was on fire, there is a very good chance he would be able to see that. The pilot can't see everything that the gunner can, and he'd miss an awful lot," Hole told the *New York Post*.

Gunner Lawrence Mueller of Milwaukee, another former member of Bush's squadron who flew on the Chichi Jima mission, when asked who would have had the best view, replied: "The turret gunner of Melvin's plane." Mierzejewski for his part said that his plane was flying about 100 feet ahead of Bush's plane during the incident—so close that he could see into Bush's cockpit.

Mierzejewski, who is also a recipient of the Distinguished Flying Cross, told the *New York Post* that he saw "a puff of smoke" come out of Bush's plane and quickly dissipate. He asserted that after that there was no more smoke visible, that Bush's "plane was never on fire" and that "no smoke came out of his cockpit when he opened his canopy to bail out." Mierzejewski stated that only one man ever got out of the Barbara II, and that was Bush himself. "I was hoping I would see some other parachutes. I never did. I saw the plane go down. I knew the guys were still in it. It was a helpless feeling."

Mierzejewski has long been troubled by the notion that Bush's decision to parachute from his damaged aircraft might have cost the lives of Radioman second class John Delaney, a close friend of Mierzejewski, as well as gunner Lt. junior grade William White. "I think [Bush]

could have saved those lives, if they were alive. I don't know that they were, but at least they had a chance if he had attempted a water landing," Mierzejewski told the *New York Post*.

Former executive officer Legare Hole summed up the question for the *New York Post* reporters as follows: "If the plane is on fire, it hastens your decision to bail out. If it is not on fire, you make a water landing." The point is that a water landing held out more hope for all members of the crew. The Avenger had been designed to float for approximately two minutes, giving the tailgunner enough time to inflate a raft and giving everyone an extra margin of time to get free of the plane before it sank. Bush had carried out a water landing back in June when his plane had lost oil pressure.

The official—but undated—report on the incident among the squadron records was signed by Commander Melvin and an intelligence officer named Lt. Martin E. Kilpatrick. Kilpatrick is deceased, and Melvin in 1988 was hospitalized with Parkinson's disease and could not be interviewed. Mierzejewski in early August 1988 had never seen the undated intelligence report in question. "Kilpatrick was the first person I spoke to when we got back to the ship," he said. "I told him what I saw. I don't understand why it's not in the report."

Gunner Lawrence Mueller tended to corroborate Mierzejewski's account. Mueller had kept

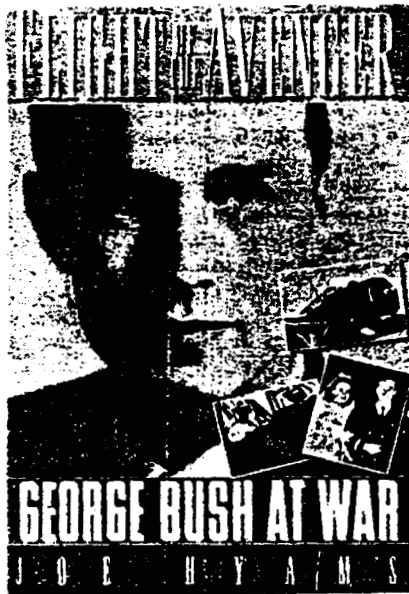

Flight of the Avenger, the book commissioned by George Bush to tell of his bravery under fire.

a log book of his own in which he made notations as the squadron was debriefed in the ready room after each mission. For September 2, 1944, Mueller's personal log had the following entry: "White and Delaney presumed to have gone down with plane." Mueller told the *New York Post* that "no parachute was sighted except Bush's when the plane went down." The *New York Post* reporters were specific that, according to Mueller, no one in the *San Jacinto* ready room during the debriefing had said anything about a fire on board Bush's plane. Mueller said: "I would have put it in my logbook if I had heard it."

According to this *New York Post* article, the report of Bush's debriefing aboard the submarine *Finnback* after his rescue makes no mention of any fire aboard the plane. When the *New York Post* reporters interviewed Thomas R. Keene, an airman from another carrier, who had been picked up by the *Finnback* a few days after Bush, they referred to the alleged fire on board Bush's plane and "Keene was surprised to hear" it. "'Did he say that?,' Keene asked.

Leo Nadeau, Bush's usual rear turret gunner, who had been in contact with Bush during the 1980s, attempted to undercut Mierzejewski's credibility by stating that "Ski," as Mierzejewski was called, would have been "too busy shooting" to have been able to focus on the events involving Bush's plane. But even the pro-Bush accounts agree that the reason that White had been allowed to come aloft in the first place was the expectation that there would be no Japanese aircraft over the target, making a thoroughly trained and experienced gunner superfluous. Indeed, no account alleges that any Japanese aircraft appeared over Chichi Jima.

Bush and Mierzejewski met again on board the *San Jacinto* after the downed pilot was returned from the *Finnback* about a month after the loss of the *Barbara II*. According to the *New York Post* account, about a month after all these events Bush, clad in Red Cross pajamas, returned to the *San Jacinto*. "He came into the ready room and sat down next to me," Mierzejewski recounted. "He [Bush] knew I saw the whole thing. He said, 'Ski, I'm sure those two men were dead. I called them on the radio three times. They were dead.' When he told me they were dead, I couldn't prove they weren't. He



The *New York Post*, August 12, 1988, quoted eyewitness Chester Mierzejewski debunking Bush's self-described heroism. The *Post*'s extensive coverage featured pictures of Bush as a naval aviator, the gunner who challenged his tale of heroism, and the two young men who died in the crash Bush survived.

seemed distraught. He was trying to assure me he did the best he could. I'm thinking what am I going to say to him," Mierzejewski commented in 1988.

Mierzejewski began to become concerned about Bush's presentation of his war record while watching Bush's December 1987 inter-

view with David Frost, which was one of the candidate's most sanctimonious performances. In March 1988, Mierzejewski wrote to Bush and told him that his recollections were very different from the Vice President's story. Mierzejewski's letter was not hostile in tone, but voiced concern that political opponents might come forward to dispute Bush. There was no reply to this letter, and Chester Mierzejewski ultimately elected to tell his own unique eyewitness version of the facts to the *New York Post*. Certainly his authoritative, first-hand account places a large question mark over the events of September 2, 1944, which Bush has so often sought to exploit for political gain.

Several days after Mierzejewski's interview was published, Bush's office obtained and released to the press a copy of the (undated) squadron log report. One Donald Rhodes of Bush's office called Mierzejewski to offer him a copy of the report.

It is typical of Joe Hyams's hack work for Bush in *The Flight of the Avenger* that he never mentions Mierzejewski's critical account, although he is obviously acutely aware of the objections raised by Mierzejewski and wants very much to discredit those objections. Indeed, Hyams totally ignores Mierzejewski as a source, and also studiously ignores the other witness who would have supported Mierzejewski, that is to say Mueller. Hyams had the support of Bush's White House staff in arranging interviews for his book, but somehow he never got around to talking to Mierzejewski and Mueller. This must increase our suspicion that Bush has some damning circumstance he wishes to hide.

Bush himself admits that he was in a big hurry to get out of his cockpit: "The wind was playing tricks, or more likely, I pulled the rip cord too soon."<sup>9</sup> This caused his gashed forehead and damaged his parachute.

Concerning the ability of Brown Brothers Harriman to fix a combat report in naval aviation, it is clear that this could be accomplished as easily as fixing a parking ticket. Artemus Gates is someone who could have helped out. Other Brown Brothers Harriman assets in powerful posts included Secretary of War Stimson, Secretary of War for Air Robert Lovett, Special Envoy W. Averell Harriman, and even President Roosevelt's confidant and virtual alter ego, Harry Hopkins, an asset of the Harriman family.

Bush was very upset about what had happened to his two crewmen. Later, during one of his Skull and Bones "Life History" self-exposures, Bush referred to Lt. White, the Skull and Bones member who had gone to his death with the Barbara II: "I wish I hadn't let him go," said Bush, according to former Congressman Thomas W. L. (Lud) Ashley, a fellow Skull and Bones member and during 1991 one of the administrators of the Neil Bush legal defense fund. According to Ashley, "Bush was heartbroken. He had gone over it in his mind 100,000 times and concluded he couldn't have done anything. . . . He didn't feel guilty about anything that happened. . . . But the incident was a source of real grief to him. It tore him up, real anguish. It was so fresh in his mind. He had a real friendship with this man," said Ashley.<sup>10</sup>

Bush later wrote letters to the families of the

**"Well, if you had an urgent problem, perhaps the law could be simply set aside, for you and you alone, ahead of all the 5 million poor slobs who had to go in the mud with the infantry or swab some stinking deck. . ."**

men who had died on his plane. He received a reply from Delaney's sister, Mary Jane Delaney. The letter read in part:

"You mention in your letter that you would like to help me in some way. There is a way, and that is to stop thinking you are in any way responsible for your plane accident and what has happened to your men. I might have thought you were if my brother Jack had not always spoken of you as the best pilot in the squadron."<sup>11</sup>

Bush also wrote a letter to his parents in which he talked about White and Delaney: "I try to think about it as little as possible, yet I cannot get the thought of those two out of my mind. Oh, I'm OK—I want to fly again and I won't be scared of it, but I know I won't be able to shake the memory of this incident and I don't believe I want to completely."<sup>12</sup>

As Bush himself looked back on all these events from the threshold of his genocidal assault on Iraq, he complacently concluded that the pagan fates had preserved his life for some future purpose. He told Hyams:

"There wasn't a sudden revelation of what I wanted to do with the rest of my life, but there was an awakening. There's no question that underlying all that were my own religious beliefs. In my own view there's got to be some kind of destiny and I was being spared for something on earth."<sup>13</sup>

After having deliberately ignored the relevant dissenting views about the heroism of his patron, Hyams chooses to conclude his book on the following disturbing note:

"When flying his Avenger off the deck of the San Jac, Bush was responsible for his own fate as well as his crewmen's. As President he is responsible for the fate of all Americans as well as that of much of the world."

And that is precisely the problem.

#### Notes

- \* Would to the gods that this be the last of his crimes!
- 1. For details of Bush's Navy career, see Joe Hyams, *Flight of the Avenger: George Bush at War* (New York: Harcourt, Brace, Jovanovitch, 1991), *passim*.
- 2. George Bush and Victor Gold, *Looking Forward*, (New York: Doubleday, 1987), p. 36.
- 3. Hyams, *op. cit.*, pp. 106-7.
- 4. *Ibid.*, p. 111.
- 5. Nicholas King, *George Bush: A Biography* (New York: Dodd, Mead & Company, 1980), pp. 30-31.

6. Fitzhugh Green, *George Bush: An Intimate Portrait* (New York: Hippocrene Books, 1989), pp. 36-37.
7. Richard Ben Cramer, "George Bush: How He Got Here," *Esquire*, June 1991.
8. Allan Wolper and Al Ellenberg, "The Day Bush Bailed Out," *New York Post*, August 12, 1988, p. 1 ff.
9. Bush and Gold, *op. cit.*, p. 36.
10. *Washington Post*, August 7, 1988. For the Skull and Bones Society and its "life history" self-exposure, see Chapter 7.
11. Hyams, *op. cit.*, p. 143.
12. Bush and Gold, *op. cit.*, pp. 40-41.
13. Hyams, *op. cit.*, p. 134.

#### Correction

Corrections to errors in Chapter 3, in volume 6, No. 1, Jan. 6, 1992:

There was an extraneous footnote ("1") following the first paragraph, which might have made that quote appear to be from George Bush, rather than Hitler. Bush's (similar) quote in fact follows that one.

"After his 1948 graduation . . . George Bush flew down to Texas on a corporate jet" should have read "on a corporate aircraft."

## Skull and Bones: Racist Nightmare At Yale

The U.S. Navy delivered George Bush back home for good on Christmas Eve 1944; the war in the Pacific raged on over the next half year, with Allied forces taking Southeast Asia, the Netherlands East Indies (Indonesia), and islands such as Iwo Jima and Okinawa.

Barbara Pierce quit Smith College in her sophomore year to marry George. Prescott and Mother Bush gave a splendid prenuptial dinner at the Greenwich Field Club. The wedding took place January 6, 1945, in the Rye, New York Presbyterian Church, as the U.S. Third Fleet bombarded the main Philippine island of Luzon in preparation for invasion. Afterwards there was a glamorous reception for 300 at Appawamis Country Club. The newlyweds honeymooned at The Cloisters, a five-star hotel on Sea Island, Georgia, with swimming, tennis, and golf. . . .

Japan surrendered in August. That fall, George and Barbara Bush moved to New Haven where Bush entered Yale University. He and Barbara moved into an apartment at 37 Hillhouse Avenue, across the street from Yale President Charles Seymour.

College life was good to George, what he saw of it. A college career usually occupies four years. But we know that George Bush is a rapidly moving man. Thus he was pleased with the special arrangement made for veterans, by which Yale allowed him to get his degree after attending classes for only two and a half years. . . .

In 1947, Barbara gave birth to George W. Bush, Jr.

By the time of his 1948 graduation, he had been elected to Phi Beta Kappa, an honor traditionally associated with academic achievement. Not a great deal is known about George Bush's career at Yale, especially the part about books and studies. Unfortunately for those who would wish to consider his intellectual accomplishment, everything about *that* has been sealed shut and is top secret. The Yale administration says they have turned over to the FBI custody of all of Bush's academic records, allegedly because the FBI needs such access to check the resumes of important office holders.



The previous Bush "biographies," written or commissioned by Bush and his staff.

From all available testimony, his mental life before college was anything but outstanding. His campaign literature claims that, as a veteran, Bush was "serious" at Yale. But we cannot check exactly how he achieved election to Phi Beta Kappa, in his abbreviated college experience. Without top secret clearance, we cannot consult his test results, read his essays, or learn much about his performance in class. We know that his father was a trustee of the university, in charge of "developmental" fundraising. And his family friends were in control of the U.S. secret services.

A great deal is known, however, about George Bush's *status* at Yale.

His fellow student John H. Chafee, later a U.S. senator from Rhode Island and secretary of the navy, declared: "We didn't see much of him because he was married, but I guess my first impression was that he was—and I don't mean this in a derogatory fashion—in the inner set, the movers and shakers, the establishment. I don't mean he put on airs or anything, but . . . just everybody knew him."

Chafee, like Bush and Dan Quayle, was in the important national fraternity, Delta Kappa Epsilon (DKE or the "Dekes"). But Chafee says: "I never remember seeing him there. He wasn't one to hang around with the fellows."<sup>5</sup>

## The Tomb

George Bush, in fact, passed his most important days and nights at Yale in the strange companionship of the senior-year Skull and Bones Society.<sup>6</sup>

Out of those few who were chosen for Bones membership, George was the last one to be notified of his selection—this honor is traditionally reserved for the highest of the high and mighty.

His father, Prescott Bush, several other relatives and partners, and Roland and Averell Harriman, who sponsored the Bush family, were also members of this secret society. . . .

The order was incorporated in 1856 under the name "Russell Trust Association." By special act of the state legislature in 1943, its trustees are exempted from the normal requirement of filing corporate reports with the Connecticut secretary of state.

As of 1978, all business of the Russell Trust [owner of the Skull and Bones] was handled by its lone trustee, Brown Brothers Harriman partner John B. Madden, Jr. Madden started with Brown Brothers Harriman in 1946, under senior partner Prescott Bush, George Bush's father.

Each year, Skull and Bones members select ("tap") 15 third-year Yale students to replace them in the senior group the following year. Graduating members are given a sizeable cash bonus to help them get started in life. Older graduate members, the so-called "Patriarchs," give special backing in business, politics, espionage and legal careers to graduate Bonesmen who exhibit talent or usefulness.

The home of Skull and Bones on the Yale campus is a stone building resembling a mausoleum, and known as "the Tomb." Initiations take place on Deer Island in the St. Lawrence River (an island owned by the Russell Trust Association), with regular reunions on Deer Island and at Yale. Initiation rites reportedly include strenuous and traumatic activities of the new member, while immersed naked in mud, and in a coffin. More important is the "sexual autobiography": The initiate tells the order all the sex secrets of his young life. Weakened mental defenses against manipulation, and the blackmail potential of such information, have obvious permanent uses in enforcing loyalty among members.

The loyalty is intense. One of Bush's former teachers, whose own father was a Skull and Bones member, told our interviewer that his father used to stab his little Skull and Bones pin into his skin to keep it in place when he took a bath.

Members continue throughout their lives to unburden themselves on their psycho-sexual thoughts to their Bones Brothers, even if they are no longer sitting in a coffin. This has been the case with President George Bush, for whom these ties are reported to have a deep personal meaning. Beyond the psychological manipulation associated with freemasonic mummery, there are very solid political reasons for Bush's strong identification with this cult. . . .

Skull and Bones—the Russell Trust Association—was first established among the class graduating from Yale in 1833. Its founder was William Huntington Russell of Middletown, Connecticut. The Russell family was the master of incalculable wealth derived from the largest

U.S. criminal organization of the nineteenth century: Russell and Company, the great opium syndicate.

There was at that time a deep suspicion of, and national revulsion against, freemasonry and secret organizations in the United States, fostered in particular by the anti-masonic writings of former U.S. President John Quincy Adams. Adams stressed that those who take oaths to politically powerful international secret societies cannot be depended on for loyalty to a democratic republic.

But the Russells were protected as part of the multiply intermarried grouping of families then ruling Connecticut. The blood-proud members of the Russell, Pierpont, Edwards, Burr, Griswold, Day, Alsop, and Hubbard families were prominent in the pro-British party within the state. Many of their sons would be among the members chosen for the Skull and Bones Society over the years.

---

## Opium and Empire

The background to Skull and Bones is a story of Opium and Empire, and a bitter struggle for political control over the new U.S. republic.

Samuel Russell, second cousin to Bones founder William H., established Russell and Company in 1823. Its business was to acquire opium from Turkey and smuggle it into China, where it was strictly prohibited, under the armed protection of the British Empire.

The prior, predominant American gang in this field had been the syndicate created by Thomas Handasyd Perkins of Newburyport, Massachusetts, an aggregation of the self-styled "bluebloods" or Brahmins of Boston's north shore. Forced out of the lucrative African slave trade by U.S. law and Caribbean slave revolts, leaders of the Cabot, Lowell, Higginson, Forbes, Cushing, and Sturgis families had married Perkins siblings and children. The Perkins opium syndicate made the fortune and established

**"For George Bush, the Skull and Bones Society is more than simply the British, as opposed to the American, strategic tradition. It is merged in the family and personal network within which his whole life has been, in a sense, handed to him prepackaged."**

the power of these families, under the direct protection of the British navy and British imperial finance. By the 1830s, the Russells had bought out the Perkins syndicate and made Connecticut the primary center of the U.S. opium racket. Massachusetts families (Coolidge, Sturgis, Forbes, and Delano) joined Connecticut (Alsop) and New York (Low) smuggler-millionaires under the Russell (and British) auspices. . . .

Samuel and William Huntington Russell were quiet, wary builders of their faction's power. An intimate colleague of opium gangster Samuel Russell wrote this about him:



"While he lived no friend of his would venture to mention his name in print. While in China, he lived for about twenty-five years almost as a hermit, hardly known outside of his factory [the Canton warehouse compound] except by the chosen few who enjoyed his intimacy, and by his good friend, Hoqua [Chinese security director for the East India Company], but studying commerce in its broadest sense, as well as its minutest details. Returning home with well-earned wealth he lived hospitably in the midst of his family, and a small circle of intimates. Scorning words and pretensions from the bottom of his heart, he was the truest and staunchest of friends; hating notoriety, he could always be absolutely counted on for every good work which did not involve publicity."

The Russells' Skull and Bones Society was the most important of their domestic projects "which did not involve publicity."

... Yale was the northern college favored by southern slaveowning would-be aristocrats. Among Yale's southern students were John C. Calhoun, later the famous South Carolina defender of slavery against nationalism, and Judah P. Benjamin, later secretary of state for the slaveowners' Confederacy. ...

In 1832-33, Skull and Bones was launched under the Russell pirate flag.

Among the early initiates of the order were Henry Rootes Jackson (S&B 1839), a leader of the 1861 Georgia Secession Convention and post-Civil War president of the Georgia Historical Society; ... John Perkins, Jr., (S&B 1840), chairman of the 1861 Louisiana Secession Convention; ... and William Taylor Sullivan Barry (S&B 1841), a national leader of the secessionist wing of the Democratic Party during the 1850s, and chairman of the 1861 Mississippi Secession Convention.

Alphonso Taft was a Bonesman alongside William H. Russell in the Class of 1833. As U.S. attorney general in 1876-77, Alphonso Taft helped organize the backroom settlement of the deadlocked 1876 presidential election. The bargain gave Rutherford B. Hayes the presidency (1877-81) and withdrew the U.S. troops from the South, where they had been enforcing blacks' rights.

Alphonso's son, William Howard Taft (S&B 1878), was U.S. President from 1909 to 1913. President Taft's son, Robert Alphonso Taft (S&B 1910), was a leading U.S. senator after World War II; his family's Anglo-Saxon racial/ancestral preoccupation was the disease which crippled Robert Taft's leadership of American nationalist "conservatives."

## Leading Bonesmen

Other pre-Civil War Bonesmen were:

- William M. Evarts (S&B 1837), Wall Street attorney for British and southern slaveowner projects, collaborator of Taft in the 1876 bargain, U.S. secretary of state 1877-81;

- Morris R. Waite (S&B 1837), chief justice of the U.S. Supreme Court 1874-88, whose rulings destroyed many rights of African-Americans gained in the Civil War; he helped his cohorts Taft and Evarts arrange the 1876 presidential settlement scheme to pull the rights-enforcing U.S. troops out of the South;

- Daniel Coit Gilman (S&B 1852), co-incorporator of the Russell Trust; founding president of Johns Hopkins University as a great center for the racialist eugenics movement;

- Andrew D. White (S&B 1853), founding president of Cornell University; psychic researcher; and diplomatic cohort of the Venetian, Russian and British oligarchies;

- Chauncey M. Depew (S&B 1856), general counsel for the Vanderbilt railroads, he helped the Harriman family to enter into high society. ...

- Irving Fisher (S&B 1888) became the racialist high priest of the economics faculty (Yale professor 1896-1946), and a famous merchant of British Empire propaganda for free trade and reduction of the non-white population. Fisher was founding president of the American Eugenics Society under the financial largesse of Averell Harriman's mother.

- Gifford Pinchot (S&B 1889) invented the aristocrats' "conservation" movement. He was President Theodore Roosevelt's chief forester, substituting federal land-control in place of Abraham Lincoln's free-land-to-families farm creation program. Pinchot's British Empire activism included the Psychical Research Society and his vice presidency of the first International Eugenics Congress in 1912. ...

- Frederick E. Weyerhaeuser (S&B 1896), owner of vast tracts of American forest, was a follower of Pinchot's movement, while the Weyerhaeusers were active collaborators of British-South African super-racist Cecil Rhodes. This family's friendship with President George Bush is a factor in the present environmentalist movement.

Henry L. Stimson (S&B 1888) was President Taft's secretary of war (1911-13), and President Herbert Hoover's secretary of state (1929-33). As secretary of war (1940-45), Stimson pressed President Truman to drop the atomic bomb on the Japanese. This decision involved much more than merely "pragmatic" military considerations. These Anglophiles, up through George Bush, have opposed the American republic's tradition of alliance with national aspirations in Asia. And they worried that the invention of nuclear energy would too powerfully unsettle the world's toleration for poverty and misery. Both the United States and the atom had better be dreaded, they thought.

The present century owes much of its record of horrors to certain Anglophile American families which have employed Skull and Bones as a political recruiting agency, particularly the Harrimans, Whitneys, Vanderbilts, Rockefellers and their lawyers, the Lords and Tafts and Bundys.

The politically aggressive Guaranty Trust Company, run almost entirely by Skull and Bones initiates, was a financial vehicle of these families in the early 1900s. Guaranty Trust's support for the Bolshevik and Nazi revolutions overlapped the more intense endeavors in these fields by the Harrimans, George Walker, and Prescott Bush a few blocks away, and in Berlin.

Skull and Bones was dominated from 1913 onward by the circles of Averell Harriman. They displaced remaining traditionalists such as Douglas MacArthur from power in the United States.

For George Bush, the Skull and Bones Society is more than simply the British, as opposed to the American, strategic tradition. It is merged in the family and personal network within which his whole life has been, in a sense, handed to him prepackaged.

## Britain's Yale Flying Unit

During Prescott Bush's student days, the Harriman set at Yale decided that World War I was sufficiently amusing that they ought to get into it as recreation. They formed a special Yale Unit of the Naval Reserve Flying Corps, at the instigation of F. Trubee Davison. Since the United States was not at war, and the Yale students were going to serve Britain, the Yale Unit was privately and lavishly financed by F. Trubee's father, Henry Davison, the senior managing partner at J.P. Morgan and Co. (the official financial agency for the British government in the United States). The Yale Unit's leader was amateur pilot Robert A. Lovett. They were based first on Long Island, New York, then in Palm Beach, Florida.

The Yale Unit has been described by Lovett's family and friends in a collective biography of the Harriman set:

"Training for the Yale Flying Unit was not exactly boot camp. Davison's father . . . helped finance them royally, and newspapers of the day dubbed them 'the millionaires' unit.' They cut rakish figures, and knew it; though some dismissed them as dilettantes, the hearts of young Long Island belles fluttered at the sight . . .

"[In] Palm Beach . . . they ostentatiously pursued a relaxed style. They were rolled about in wheel chairs by African slaves amid tropical gardens and coconut palms,' wrote the unit's historian. . . . 'For light exercise, they learned to glance at their new wristwatches with an air of easy nonchalance'. . . . [Lovett] was made chief of the unit's private club, the Wags, whose members started their sentences, 'Being a Wag and therefore a superman' . . .

"Despite the snide comments of those who dismissed them as frivolous rich boys, Lovett's unit proved to be daring and imaginative warriors when they were dispatched for active duty in 1917 with Britain's Royal Naval Air Service."<sup>7</sup>

Lovett was transferred to the U.S. Navy after the United States joined Britain in World War I.

The Yale Flying Unit was the glory of Skull and Bones. Roland Harriman, Prescott Bush, and their 1917 Bonesmates selected for 1918 membership in the secret order these Yale Flying Unit leaders: Robert Lovett, F. Trubee Davison, Artemus Lamb Gates, and John Martin Verys. Unit flyers David Sinton Ingalls and F. Trubee's brother, Harry P. Davison (who became Morgan vice chairman), were tapped for the 1920 Skull and Bones.

Lovett did not actually have a senior year at Yale: "He was tapped for Skull and Bones not on the Old Campus but at a naval station in West Palm Beach; his initiation, instead of being conducted in the 'tomb' on High Street, occurred at the headquarters of the Navy's Northern Bombing Group between Dunkirk and Calais."<sup>8</sup>

Some years later, Averell Harriman gathered Lovett, Prescott Bush, and other pets into the utopian oligarchs' community a few miles to the north of Palm Beach, called Jupiter Island.

British Empire loyalists flew right from the Yale Unit into U.S.-strategy-making positions:

- F. Trubee Davison was assistant U.S. secretary of war for air from 1926 to 1933. David S. Ingalls (on the board of Jupiter Island's Pan American Airways) was meanwhile assistant secretary of the navy for aviation (1929-32). Following the American Museum of Natural History's Hitlerite 1932 eugenics congress, Davison resigned his government Air post to become the museum's president. Then, under the Harriman-Lovett national security regime of the early 1950s, F. Trubee Davison became director of personnel for the new Central Intelligence Agency.

- Robert Lovett was assistant secretary of war for Air from 1941-45.

- Lovett's 1918 Bonesmate, Artemus Gates (chosen by Prescott and his fellows), became assistant navy secretary for air in 1941. Gates retained this post throughout the war until 1945. Having a man like Gates up there, who owed his position to Averell, Bob, Prescott, and their set, was quite reassuring to young naval aviator George Bush; especially so, when Bush would have to worry about the record being correct concerning his controversial fatal crash.

---

## Other Important Bonesmen

- Richard M. Bissell, Jr. was a very important man to the denizens of Jupiter Island.

He graduated from Yale in 1932, the year after the Harrimanites bought the island. Though not in Skull and Bones, Bissell was the younger brother of William Truesdale Bissell, a Bonesman from the class of 1925. Their father, Connecticut insurance executive Richard M. Bissell, Sr., was a powerful Yale alumnus, and the director of the Neuro-Psychiatric Institute of the Hartford Retreat for the Insane. There, in 1904, Yale graduate Clifford Beers underwent mind-destroying treatment which led this mental patient to found the Mental Hygiene Society, a Yale-based Skull and Bones project. This would evolve into the CIA's cultural engineering effort of the 1950s, the drugs and brain-washing adventure known as "MK-Ultra."

Richard M. Bissell, Jr. studied at the London School of Economics in 1932 and 1933, and taught at Yale from 1935 to 1941. He worked as an assistant or adviser to Averell Harriman in various government posts between 1942 and 1952, participating in the Harriman clique's takeover of the Truman administration.

Bissell then joined F. Trubee Davison at the Central Intelligence Agency. When Allen Dulles became CIA director in 1953, Bissell was one of his three aides. The great anti-Castro covert initiative of 1959-61 was supervised by an awesome array of Harriman agents—and the detailed management of the invasion of Cuba, and of the assassination planning, and the training of the squads for these jobs, was given into the hands of Richard M. Bissell, Jr.



## The Yale Tories Who Made Skull and Bones

This chart depicts family relationships which were vital to the persons appearing on the chart. At less exalted levels of society, one is supposed to be praised or blamed only according to one's own actions. But in these Yale circles, "family"—genealogy—is an overwhelming consideration when evaluating individuals. Thus what we present here is more than

simply a system of associations. It is a tradition which has operated powerfully on the emotions and judgment of the leaders of Yale University; they have merged their own identities into this tradition.

Lines are directed downwards from parents to their children. A double hyphen—signifies the marriage of the persons on either side.

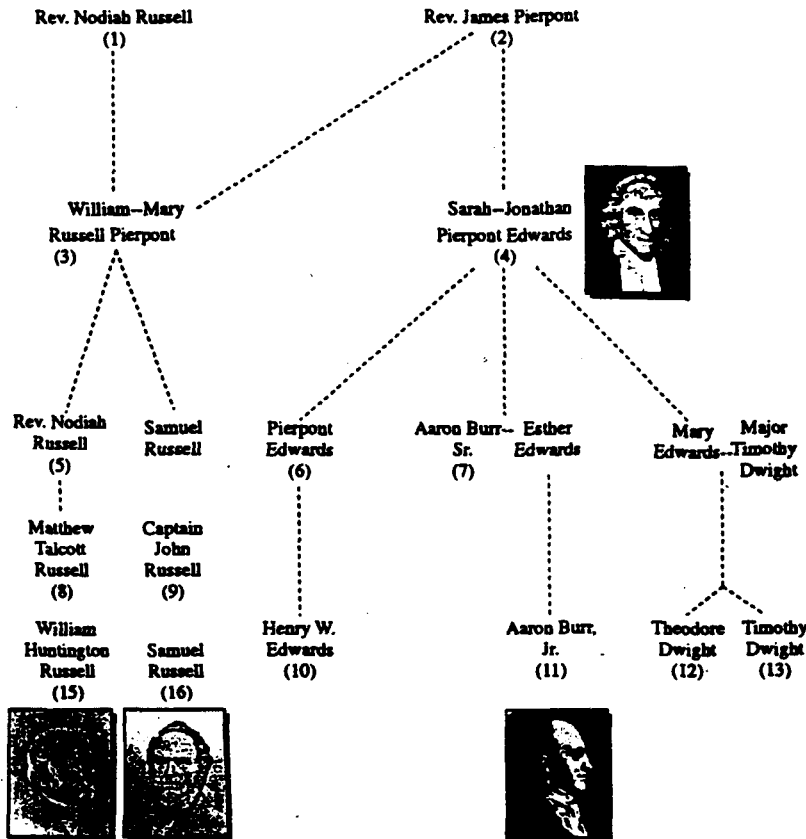

um-financed enterprises; patron of William Huntington Russell's new secret society, Skull and Bones.

- 11) Aaron Burr, Jr.: U.S. vice president 1801-08; killed Alexander Hamilton in a duel in 1804; secession conspirator; acquitted of treason in 1807, but wanted for murder, he fled to England; returned to U.S. in 1812; Wall Street lawyer, 1812-36; romantic hero of imperial Anglo-Americans.
- 12) Theodore Dwight (1764-1846): Law partner of his cousin Aaron Burr, Jr.; secretary of the secessionist Hartford Convention, 1815; he united the Connecticut pro-British party with Massachusetts "Essex Junks."
- 13) Timothy Dwight: secessionist; president of Yale, 1795-1817.
- 14) William Huntington Russell (1809-85): graduated Yale 1833; founder of Skull and Bones Society (or Russell Trust Association); His secret organization spread in the 1870s to Phillips Academy, the Andover, Massachusetts prep school.
- 15) Samuel Russell: born in 1789 in the main ancestral house of the Russell family of Middletown. This house had been owned by the co-founder of Yale, Nodiah Russell (1), and by William Russell (3) and his wife Mary, sister-in-law to Jonathan Edwards.

He became head of the Middletown Russells. He established Russell and Co, 1823, which by the 1830s superseded Perkins syndicate as the largest American opium smuggling organization. His partners included leading Boston families.

He founded the Russell Mfg. Company, Middletown, in 1837; he was president of Middlesex County Bank. During the formative years of Skull and Bones, the fabulously wealthy Samuel Russell was undisputed king of Middletown. Sometime prior to 1837, he ordered "the erection of the elegant mansion on the corner of Washington and High Streets. This was done under the supervision of (Congressman) Samuel D. Hubbard."

- 1) Rev. Nodiah Russell: one of 10 or 12 men who founded Yale University in 1701; Yale trustee 1701-13; pastor, First Congregational Church, Middletown, Ct. ca. 1691-1718.
- 2) Rev. James Pierpont: most celebrated of the Yale founders; Yale trustee, 1701-14.
- 3) William Russell: Yale trustee 1745-61; pastor, First Congregational Church, Middletown, Ct. 1716-61.
- 4) Jonathan Edwards: graduated Yale 1720; ultra-Calvinist theologian, president of Princeton University (called then "College of New Jersey").
- 5) Rev. Nodiah Russell: graduated Yale 1750.

- 6) Pierpont Edwards (1750-1826): made master of Connecticut Masons by the British Army occupying New York in 1783; he administered the estate of the traitor Benedict Arnold.
- 7) Aaron Burr, Sr.: Graduated Yale 1735. President of Princeton University ("College of New Jersey").
- 8) Matthew Talcott Russell: graduated Yale 1769; deacon of First Congregational Church, Middletown, Ct. for 30 years; lawyer for the Middletown Russell family; died ca. 1817.
- 9) Captain John Russell: died 1801 or 1802.
- 10) Henry W. Edwards: governor of Connecticut 1833, 1835-38; protector of Samuel Russell's opi-

Note: For the sake of clarity, we have omitted from this chart the ancestral line from Rev. James Pierpont (2) to his great grandson Rev. John Pierpont.

Rev. John Pierpont wrote poetry for the pro-British secessionists; he denounced President Thomas Jefferson for saying that Pierpont's New England relatives were "under the influence of the whore of England." Rev. John was an employee of Aaron Burr's family during Burr's Western Conspiracy. Rev. John's daughter Juliet married Connecticut-born British banker Junius Morgan and gave birth to U.S. financial kingpin John Pierpont Morgan, named for his grandfather Rev. John.

... Fidel Castro survived the widely discussed assassination plots against him. But the initiative succeeded in what was probably its core purpose: to organize a force of multi-use professional assassins.

The Florida-trained killers stayed in business under the leadership of Ted Shackley. They were all around the assassination of President Kennedy in 1963. They kept going with the Operation Phoenix mass murder of Vietnamese civilians, with Middle East drug and terrorist programs, and with George Bush's Contra wars in Central America.

• Harvey Hollister Bundy (S&B 1909) was Henry L. Stimson's assistant secretary of state (1931-33); then he was Stimson's special assistant secretary of war, alongside Assistant Secretary Robert Lovett of Skull and Bones and Brown Brothers Harriman.

Harvey's son William P. Bundy (S&B 1939) was a CIA officer from 1951 to 1961; as a 1960s defense official, he pushed the Harriman-Dulles scheme for a Vietnam war. Harvey's other son, McGeorge Bundy (S&B 1940) coauthored Stimson's memoirs in 1948. As President John Kennedy's director of national security, McGeorge Bundy organized the whitewash of the Kennedy assassination, and immediately switched the U.S. policy away from the Kennedy pullout and back toward war in Vietnam.

• There was also Henry Luce, a Bonesman of 1920 with David Ingalls and Harry Pomeroy. Luce published *Time* magazine, where his ironically named "American Century" blustering was straight British Empire doctrine: Bury the republics, hail the Anglo-Saxon conquerors.

• William Sloane Coffin, tapped for 1949 Skull and Bones by George Bush and his Bone companions, was from a long line of Skull and Bones

Coffins. William Sloane Coffin was famous in the Vietnam War protest days as a leader of the left protest against the war. Was the fact that he was an agent of the Central Intelligence Agency embarrassing to William Sloane?

This was no contradiction. His uncle, the Reverend Henry Sloane Coffin (S&B 1897), had also been a "peace" agitator, and an oligarchical agent. Uncle Henry was for 20 years president of the Union Theological Seminary, whose board chairman was Prescott Bush's partner Thatcher Brown. In 1937, Henry Coffin and John Foster Dulles led the U.S. delegation to England to found the World Council of Churches, as a "peace movement" guided by the pro-Hitler faction in England.

The Coffins have been mainstays of the liberal death lobby for euthanasia and eugenics. The Coffins outlasted Hitler, arriving into the CIA in 1950s.

- Amory Howe Bradford (S&B 1934) married Carol Warburg Rothschild in 1941. Carol's mother, Carola, was the acknowledged head of the Warburg family in America after World War II. This family had assisted the Harrimans' rise into the world in the nineteenth and early twentieth centuries; in concert with the Sulzbergers at the *New York Times*, they had used their American Jewish Committee and B'nai Brith to protect the Harriman-Bush deals with Hitler.

This made it nice for Averell Harriman, just like family, when Amory Howe worked on the Planning Group of Harriman's NATO secretariat in London, 1951-52. Howe was meanwhile assistant to the publisher of the *New York Times*, and went on to become general manager of the *Times*.

Thus, we could be assured of "responsible news coverage," with due emphasis on the necessary role of "moderates" named Harriman and Bush.

- Other modern Bonesmen have been closely tied to George Bush's career. George Herbert Walker, Jr. (S&B 1927) was the President's uncle and financial angel. In the 1970s he sold G.H. Walker & Co. to White, Weld & Co. and became a vice president of White, Weld; company heir William Weld, the original federal prosecutor of Lyndon LaRouche and current Massachusetts governor, is an active Bush Republican.

Publisher William F. Buckley (S&B 1950) had a family oil business in Mexico. There, Buckley was a close ally to CIA assassinations manager E. Howard Hunt, whose lethal antics were performed under the eyes of Miami Station and Jupiter Island.

David Lyle Boren (S&B 1963) ... was elected to the U.S. Senate in 1979 and became chairman of the Senate Intelligence Committee.

Though a Democrat (who spoke knowingly of the "parallel government" operating in Iran-Contra), Boren's Intelligence Committee rulings have been (not unexpectedly) more and more favorable to his "Patriarch" in the White House.

Among the traditional artifacts the Skull and Bones collected and maintained within the High Street Tomb are human remains of various derivations. The following concerns one such set of Skull and Bones.

Geronimo, an Apache faction leader and warrior, led a party of warriors on a raid in 1876,

after Apaches were moved to the San Carlos Reservation in Arizona territory. He led other raids against U.S. and Mexican forces well into the 1880s; he was captured and escaped many times.

Geronimo became a farmer and joined a Christian congregation. He died at the age of 79 years in 1909, and was buried at Fort Sill, Oklahoma. Three-quarters of a century later, his tribesmen raised the question of getting their famous warrior reinterred back in Arizona.

Ned Anderson was Tribal Chairman of the San Carlos Apache Tribe from 1978 to 1986. This is the story he tells:

Around the fall of 1983, the leader of an Apache group in another section of Arizona said he was interested in having the remains of Geronimo returned to his tribe's custody. Taking up this idea, Anderson said that the remains properly belonged to his group as much as to the other Apaches. After much discussion, several Apache groups met at a kind of summit meeting held at Fort Sill, Oklahoma. The army authorities were not favorable to the meeting, and it only occurred through the intervention of the office of the Governor of Oklahoma.

As a result of this meeting, Ned Anderson was written up in the newspapers as an articulate Apache activist. Soon afterwards, in late 1983 or early 1984, a Skull and Bones member contacted Anderson and leaked evidence that Geronimo's remains had long ago been pilfered—by Prescott Bush, George's father. The informant said that in May of 1918, Prescott Bush and five other officers at Fort Sill desecrated the grave of Geronimo. They took turns on guard while they robbed the grave, taking items including a skull, some other bones, a horse bit and straps. These prizes were taken back to the Tomb, the home of the Skull and Bones Society at Yale in New Haven, Connecticut. They were put into a display case, which members and visitors could easily view upon entry to the building.

The informant provided Anderson with photographs of the stolen remains, and a copy of a Skull and Bones log book in which the 1918 grave robbery had been recorded. The informant said that Skull and Bones members used the pilfered remains in performing some of their Thursday and Sunday night rituals, with Geronimo's skull sitting out on a table in front of them. . . .

Through an attorney, Anderson asked the FBI to move into the case. The attorney conveyed to him the Bureau's response: If he would turn over every scrap of evidence to the FBI, and completely remove himself from the case, they would get involved. He rejected this bargain, since it did not seem likely to lead towards recovery of Geronimo's remains.

Due to his persistence, he was able to arrange a September, 1986 Manhattan meeting with Jonathan Bush, George Bush's brother. Jonathan Bush vaguely assured Anderson that he would get what he had come after, and set a followup meeting for the next day. But Bush stalled—Anderson believes this was to gain time to hide and secure the stolen remains against any possible rescue action.

The Skull and Bones attorney representing the Bush family and managing the case was Endicott Peabody Davison. His father was the F. Trubee Davison mentioned above, who had been president of New York's American Museum of Natural History, and personnel director for the Central Intelligence Agency. The attitude of this Museum crowd has long been that "Natives" should be stuffed and mounted for display to the Fashionable Set.

Finally, after about 11 days, another meeting occurred. A display case was produced, which did in fact match the one in the photograph the informant had given to Anderson. But the skull he was shown was that of a ten-year-old child, and Anderson refused to receive it or to sign a legal document promising to shut up about the matter.

Anderson took his complaint to Arizona Congressmen Morris Udall and John McCain III, but with no results. George Bush refused Congressman McCain's request that he meet with Anderson.

Anderson wrote to Udall, enclosing a photograph of the wall case and skull at the "Tomb," showing a black and white photograph of the living Geronimo, which members of the Order had boastfully posted next to their display of his skull. Anderson quoted from a Skull and Bones Society internal history, entitled *Continuation of the History of Our Order for the Century Celebration, 17 June 1933, by The Little Devil of D'121*.

"From the war days [W.W. I] also sprang the mad expedition from the School of Fire at Fort Sill, Oklahoma, that brought to the [Tomb] its most spectacular 'crook,' the skull of Geronimo the terrible, the Indian Chief who had taken forty-nine white scalps. An expedition in late May, 1918, by members of four [graduating-class years of the Society], Xit D.114, Barebones, Caliban and Dingbat, D.115, S'Mike D.116, and Hellbender D.117, planned with great caution since in the words of one of them: 'Six army captains robbing a grave wouldn't look good in the papers.'

The stirring climax was recorded by Hellbender in the Black Book of D.117: '... The ring of pick on stone and thud of earth on earth alone disturbs the peace of the prairie. An axe pried open the iron door of the tomb, and Pat[riarch] Bush entered and started to dig. We dug in turn, each on relief taking a turn on the road as guards. ... Finally Pat[riarch] Ellery James turned up a bridle, soon a saddle horn and rotten leathers followed, then wood and then, at the exact bottom of the small round hole, Pat[riarch] James dug deep and pried out the trophy itself. ...

We quickly closed the grave, shut the door and sped home to Pat[riarch] Mallon's room, where we cleaned the Bones. Pat[riarch] Mallon sat on the floor liberally applying carbolic acid. The Skull was fairly clean, having only some flesh inside and a little hair. I showered and hit the hay ... a happy man. ..."<sup>10</sup>

The other grave robber whose name is given, Ellery James, we encountered in Chapter One—he was to be an usher at Prescott's wedding three years later. And the fellow who applied acid to the stolen skull, burning off the

flesh and hair, was Neil Mallon. Years later, Prescott Bush and his partners chose Mallon as chairman of Dresser Industries; Mallon hired Prescott's son, George Bush, for George's first job; and George Bush named his son, Neil Mallon Bush, after the flesh-picker.

In 1988 the *Washington Post* ran an article entitled "Skull for Scandal: Did Bush's Father Rob Geronimo's Grave?" There was a small quote from the 1933 *Skull and Bones History of Our Order*: "An axe pried open the iron door of the tomb, and ... Bush entered and started to dig ..." and so forth, but neglected to include other names beside Bush.

According to the *Washington Post*, the document which Bush attorney Davison tried to get the Apache leader to sign, stipulated that Anderson agreed it would be "inappropriate for you, me [Jonathan Bush] or anyone in association with us to make or permit any publication in connection with this transaction." Anderson called the document "very insulting to Indians." Davison claimed later that the Order's own history book is a hoax, but during the negotiations with Anderson, Bush's attorney demanded Anderson give up his copy of the book.<sup>11</sup>

Bush crony Fitzhugh Green gives the view of the President's backers on this affair, and conveys the arrogant racial attitude typical of Skull and Bones:

"Prescott Bush had a colorful side. In 1988 the press revealed the complaint of an Apache leader about Bush. This was Ned Anderson of San Carlos, Oklahoma [sic], who charged that as a young army officer Bush stole the skull of Indian Chief [sic] Geronimo and had it hung on the wall of Yale's Skull and Bones Club. After exposure of 'true facts' by Anderson, and consideration by some representatives in Congress, the issue faded from public sight. Whether or not this alleged skullduggery actually occurred, the mere idea casts the senior Bush in an adventurous light"<sup>12</sup> [emphasis added].

George Bush's crowning as a Bonesman was intensely, personally important to him. ...

Survivors of his 1948 Bones group were interviewed for a 1988 *Washington Post* campaign profile of George Bush. The members described their continuing intimacy with and financial support for Bush up through his 1980s vice presidency. Their original sexual togetherness at Yale is stressed:

The relationships that were formed in the "Tomb" ... where the Society's meetings took place each Thursday and Sunday night during the academic year, have had a strong place in Bush's life, according to all 11 of his fellow Bonsemen who are still alive.

Several described in detail the ritual in the organization that builds the bonds. Before giving his life history, each member had to spend a Sunday night reviewing his sex life in a talk known in the Tomb as CB, or "connubial bliss" ...

"The first time you review your sex life. ... We went all the way around among the 15, said Lucius H. Biglow Jr., a retired Seattle attorney. "That way you get everybody committed to a certain extent. ... It was a gradual way of building confidence."

The sexual histories helped break down the normal defenses of the members, according to several of the members from his class. William J. Connelly Jr. . . . said, "In Skull and Bones we all stand together, 15 brothers under the skin. [It is] the greatest allegiance in the world." . . .<sup>13</sup>

#### Notes

5. Fitzhugh Green, *George Bush: An Intimate Portrait*, (New York: Hippocrene Books, 1989), p. 48.
6. Among the sources used for this section are:
  - Skull and Bones membership list, 1833-1950, printed 1949 by the Russell Trust Association, New Haven Connecticut, available through the Yale University Library, New Haven.
  - Biographies of the Russells and related families, in the Yale University Library, New Haven, and in the Russell Library, Middletown, Connecticut.
  - Ron Chernow, *The House of Morgan: An American Banking Dynasty and the Rise of Modern Finance*, (New York: Atlantic Monthly Press, 1990).
  - Anthony C. Sutton, *How the Order Creates War and Revolution*, (Phoenix: Research Publications, Inc., 1984).
  - Anthony C. Sutton, *America's Secret Establishment: An Introduction to the Order of Skull and Bones*, (Billings, Mt., Liberty House Press, 1986).
  - Anton Chaitkin, *Treason in America: From Aaron Burr to Averell Harriman*, second edition, (New York: New Benjamin Franklin House, 1985).
  - Anton Chaitkin, "Station Identification: Morgan, Hitler, NBC," *New Solidarity*, Oct. 8, 1994.
  - Interviews with Bones members and their families.
7. Walter Isaacson and Evan Thomas, *The Wise Men: Six Friends and the World They Made—Acheson, Bohlen, Harriman, Kennan, Lovett, McCloy*, (New York: Simon and Schuster, 1986), p. 90-91.
8. *Ibid.*, p. 93.
9. Interview with Ned Anderson, Nov. 6, 1991.
10. Quoted in Ned Anderson to Anton Chaitkin, Dec. 2, 1991, in possession of the present authors.
11. Article by Paul Brinkley-Rogers of the *Arizona Republic*, in the *Washington Post*, Oct. 1, 1988.
12. Green, *op. cit.*, p. 50.
13. Bob Woodward and Walter Pincus, "Bush Opened Up To Secret Yale Society," *Washington Post*, August 7, 1988.

## The Permian Basin Gang, 1948-59

Pecunia non olet.  
[Money doesn't smell.]  
— Vespasian

**D**uring the years following the Second World War, the patrician families of the Eastern Anglophile Liberal Establishment sent numbers of their offspring to colonize those geographic regions of the United States which, the families estimated, were likely to prosper in the postwar period. On the surface, this appears as a simple reflex of greed: Cadet sons were dispatched to those areas of the provinces where their instinctive methods of speculation and usury could be employed to parasitize emerging wealth. More fundamentally, this migration of young patrician bankers answered the necessity of political control.

The Eastern Establishment, understood as an agglomeration of financier factions headquartered in Wall Street, had been the dominant force in American politics since J.P. Morgan had bailed out the Grover Cleveland regime

in the 1890s. Since the assassination of William McKinley and the advent of Theodore Roosevelt, the power of the Wall Street group had grown continuously. The Eastern Establishment may have had its earliest roots north of Boston and in the Hudson River Valley, but it was determined to be, not a mere regional financier faction, but the undisputed ruling elite of the United States as a whole, from Boston to Bohemian Grove and from Palm Beach to the Pacific Northwest. It was thus imperative that the constant tendency toward the formation of regional factions be preempted by the pervasive presence of men bound by blood loyalty to the dominant cliques of Washington, New York, and the "mother country," the City of London.

If the Eastern Liberal Establishment were thought of as a cancer, then after 1945 that cancer went into a new phase of malignant metastasis, infecting every part of the American body politic. George Bush was one of those motile, malignant cells. He was not alone; Robert Mosbacher also made the journey from New York to Texas, in Mosbacher's case directly to Houston.

The various sycophant mythographers who have spun their yarns about the life of George Bush have always attempted to present this phase of Bush's life as the case of a fiercely independent young man who could have gone straight to the top in Wall Street by trading on father Prescott's name and connections, but who chose instead to strike out for the new frontier among the wildcatters and roughnecks of the west Texas oil fields and become a self-made man.

As George Bush himself recounted in a 1983 interview, "If I were a psychoanalzyer, I might conclude that I was trying to, not compete with my father, but do something on my own. My stay in Texas was no Horatio Alger thing, but moving from New Haven to Odessa just about the day I graduated was quite a shift in lifestyle."<sup>1</sup>

These fairy tales from the "red Studebaker" school seek to obscure the facts: that Bush's transfer to Texas was arranged from the top by Prescott's Brown Brothers Harriman cronies, and that every step forward made by Bush in the oil business was assisted by the capital resources of our hero's maternal uncle, George Herbert Walker, Jr., "Uncle Herbie," the boss of G.H. Walker & Co. investment firm of Wall Street. Uncle Herbie had graduated from Yale in 1927, where he had been a member of Skull and Bones. This is the Uncle Herbie who will show up as lead investor and member of the board of Bush-Overbey oil, of Zapata Petroleum, and of Zapata Offshore after 1959. . . .

Father Prescott procured George not one job, but two, in each case contacting cronies who depended at least partially on Brown Brothers Harriman for business.

One crony contacted by father Prescott was Ray Kravis, who was in the oil business in Tulsa, Oklahoma. Oklahoma had experienced a colossal oil boom between the two world wars, and Ray Kravis had cashed in, building up a personal fortune of some \$25 million. Ray was the son of a British tailor whose father had come to America and set up a haberdashery in Atlantic City, New Jersey. Young Ray Kravis had arrived in Tulsa in 1925, in the midst of the oil boom

that was making the colossal fortunes of men like J. Paul Getty. Ray Kravis was primarily a tax accountant, and he had invented a very special tax shelter which allowed oil properties to be "packaged" and sold in such a way as to reduce the tax on profits earned from the normal oil property rate of 81 percent to a mere 15 percent. This meant that the national tax base was eroded, and each individual taxpayer bilked, in order to subsidize the formation of immense private fortunes; this will be found to be a constant theme among George Bush's business associates down to the present day.

Ray Kravis's dexterity in setting up these tax shelters attracted the attention of Joseph P. Kennedy, the bucanering bootlegger, entrepreneur, political boss and patriarch of the Massachusetts Kennedy clan. For many years Ray Kravis functioned as the manager of the Kennedy family fortune (or fondo), the same job that later devolved to Stephen Smith. Ray Kravis and Joe Kennedy both wintered in Palm Beach, where they were sometimes golf partners.<sup>2</sup>

In 1948-49, father Prescott was the managing partner of Brown Brothers Harriman. Prescott knew Ray Kravis as a local Tulsa finance mogul and wheeler-dealer, who was often called upon by Wall Street investment houses as a consultant to evaluate the oil reserves of various companies. The estimates that Ray Kravis provided often involved the amount of oil in the ground that these firms possessed, and these estimates went to the heart of the oil business as a ground-rent exploitation in which current oil production was far less important than the reserves still beneath the soil.

Such activity imparted the kind of primitive-accumulation mentality that was later seen to animate Ray Kravis's son Henry. During the 1980s, as we will see, Henry Kravis personally generated some \$58 billion in debt for the purpose of acquiring 36 companies and assembling the largest corporate empire, in paper terms, of all time. Henry Kravis would be one of the leaders of the leveraged buyout gang which became a mainstay of the political machine of George Bush. . . .

So father Prescott asked Ray if he had a job for young George. The answer was, of course he did.

But in the meantime, Prescott Bush had also been talking with another crony beholden to him, Henry Neil Mallon, who was the president and chairman of the board of Dresser Industries, a leading manufacturer of drill bits and related oil well drilling equipment. Dresser had been incorporated in 1905 by Solomon R. Dresser, but had been bought up and reorganized by W.A. Harriman & Co. in 1928-29.

Henry Neil Mallon, for whom the infamous Neil Mallon Bush of Hinckley and Silverado fame is named, came from a Cincinnati family who were traditional retainers for the Taft clan, in the same way that the Bush-Walker family were retainers for the Harrimans. As a child, Neil Mallon had gone with his family to visit their close friends, President William Howard Taft and his family, at the White House. Mallon had then attended the Taft School in Watertown, Connecticut, and had gone on to Yale University in the fall of 1913, where he met Bunny

Harriman, Prescott Bush, Knight Wooley, and the other Bonesmen.

As we recall from the previous chapter: the society's internal history boasted that in 1918, Mallon burned the flesh and hair off the skull of Geronimo, which Prescott Bush and his friends stole from the despoiled grave at Fort Sill, Oklahoma.

One day in December 1928, Bunny Harriman, father Prescott and Knight Wooley were sitting around the Harriman counting house discussing their reorganization of Dresser Industries. Mallon, who was returning to Ohio after six months spent mountaineering in the Alps, came by to visit. At a certain point in the conversation, Bunny pointed to Mallon and exclaimed, "Dresser! Dresser!" Mallon was subsequently interviewed by George Herbert Walker, the president of W.A. Harriman & Co. As a result of this interview, Mallon was immediately made president of Dresser, although he had no experience in the oil business. Mallon clearly owed the Walker-Bush clan some favors.<sup>3</sup>

Prescott Bush had become a member of the board of directors of Dresser Industries in 1930, in the wake of the reorganization of the company, which he had personally helped to direct. Prescott Bush was destined to remain on the Dresser board for 22 years, until 1952, when he entered the United States Senate. Father Prescott was thus calling in a chit which procured George a second job offer, this time with Dresser Industries or one of its subsidiaries.

George Bush knew that the oil boom in Oklahoma had passed its peak, and that Tulsa would no longer offer the sterling opportunities for a fast buck it had presented 20 years earlier. Dresser, by contrast, was a vast international corporation, ideally suited to gaining a rapid overview of the oil industry and its looting practices. George Bush accordingly called Ray Kravis and, in the ingratiating tones he was wont to use as he clawed his way toward the top, said that he wished respectfully to decline the job that Kravis had offered him in Tulsa. His first preference was to go to work for Dresser. Ray Kravis, who looked to Prescott for business, released him at once. "I know George Bush well," said Ray Kravis years later. "I've known him since he got out of school. His father was a very good friend of mine."<sup>4</sup>

---

## Bush in Odessa

This is the magic moment in which all the official Bush biographies show our hero riding into Odessa, Texas in the legendary red Studebaker, to take up a post as an equipment clerk and trainee for the Dresser subsidiary IDECO (International Derrick and Equipment Company).

But the red Studebaker myth, as already noted, misrepresents the facts. According to the semi-official history of Dresser Industries, George Bush was first employed by Dresser at their corporate headquarters in Cleveland, Ohio, where he worked for Dresser executive R.E. Reimer, an ally of Mallon.<sup>5</sup> This stint in Cleveland is hardly mentioned by the pro-Bush biographers, making us wonder what is being

covered up. On the same page that relates these interesting facts, there is a picture that shows father Prescott, Dorothy, Barbara Bush, and George holding his infant son George Walker Bush. Young George W. is wearing cowboy boots. They are all standing in front of a Dresser Industries executive airplane, apparently a DC-3. Could this be the way George really arrived in Odessa?

The Dresser history also has George Bush working for Pacific Pumps, another Dresser subsidiary, before finally joining IDECO. According to Bush's campaign autobiography, he had been with IDECO for a year in Odessa, Texas before being transferred to work for Pacific Pumps in Huntington Park and Bakersfield, California. Bush says he worked at Huntington Park as an assemblyman, and it was here that he claims to have joined the United Steelworkers Union, obtaining a union card that he will still pull out when confronted for his long history of union-busting, as for example when he was heckled at a shipyard in Portland, Oregon during the 1988 campaign. Other accounts place Bush in Ventura, Compton and "Richard Nixon's home town of Whittier" during this same period.<sup>6</sup>

If Bush actually went to California first and only later to Odessa, he may be lying in order to stress that he chose Texas as his first choice, a distortion that may have been concocted very early in his political career to defend himself against the constant charge that he was a carpetbagger.

Odessa, Texas, and the nearby city of Midland were both located in the geological formation known as the Permian Basin, the scene of an oil boom that developed in the years after the Second World War. Odessa at this time was a complex of yards and warehouses, where oil drilling equipment was brought for distribution to the oil rigs that were drilling all over the landscape.

At IDECO, Bush worked for supervisor Bill Nelson, and had one Hugh Evans among his co-workers. Concerning this period, we are regaled with stories about how Bush and Barbara moved into a shotgun house, an apartment that had been divided by a partition down the middle, with a bathroom they shared with a mother and daughter prostitute team. There was a pervasive odor of gas, which came not from a leak in the oven, but from nearby oil wells where the gas was flared off. George and Barbara were to spend some time slumming in this setting. But Bush was anxious to ingratiate himself with the roughnecks and roustabouts; he began eating the standard Odessa diet of a bowl of chili with crackers and beer for lunch, and chicken-fried steak for dinner. Perhaps his affected liking for country and western music and pork rinds, and other public relations ploys go back to this time. Bush is also fond of recounting the story of how, on Christmas Eve, 1948, he got drunk during various IDECO customer receptions and passed out, dead drunk, on his own front lawn, where he was found by Barbara. George Bush, we can see, is *truly a regular guy*.

According to the official Bush version of events, George and "Bar" peregrinated during 1949 far from their beloved Texas to various towns in California where Dresser had subsidi-



Neil Mallon, Skull and Bones secret society member who poured acid on the stolen skull of Indian leader Geromnimo. Prescott Bush appointed him Dresser's chairman, George Bush named his son Neil after Mallon.

aries. Bush claims that he drove 1,000 miles a week through the Carrizo Plains and the Cuyama Valley. Some months later they moved to Midland, another tumbleweed town in west Texas. Midland offered the advantage of being the location of the west Texas headquarters of many of the oil companies that operated in Odessa and the surrounding area. . . .

The Bush social circle in Odessa was hardly composed of oil field roughnecks. Rather, their peer group was composed more of the sorts of people they had known in New Haven: a clique of well-heeled recent graduates of prestigious eastern colleges who had been attracted to the Permian Basin in the same way that Stanford, Hopkins, Crocker and their ilk were attracted to San Francisco during the gold rush. Here were Toby Hilliard, John Ashmun, and Pomeroy Smith, all from Princeton. Earle Craig had been at Yale. Midland thus boasted a Yale Club and a Harvard Club and a Princeton Club. The natives referred to this clique as "the Yalies." Also present on the scene in Midland were J. Hugh Liedtke and William Liedtke, who had grown up in Oklahoma, but who had attended college at Amherst in Massachusetts.

Many of these individuals had access to patrician fortunes back East for the venture capital they mobilized behind their various deals. Toby Hilliard's full name was Harry Talbot Hilliard of Fox Chapel near Pittsburgh, where the Mellons had their palatial residence. Earle Craig was also hooked up to big money in the same area. The Liedtke brothers, as we will see, had connections to the big oil money that had emerged around Tulsa. Many of these "Yalies" also lived in the Easter Egg Row neighborhood. A few houses away from George Bush there lived a certain John Overbey. According to Overbey, the "people from the East and the people from Texas or Oklahoma all seemed to have two things in common. They all had a chance to be stockbrokers or investment bankers. And they all wanted to learn the oil business instead."<sup>7</sup>

Overbey made his living as a landman. Since George Bush would shortly also become a landman, it is worth investigating what this occupation actually entails; in doing so, we will gain a permanent insight into Bush's character. The role of the landman in the Texas oil industry was to try to identify properties where oil might be found, sometimes on the basis of leaked geological information, sometimes after observing that one of the major oil companies was drilling in the same locale. The landman would scout the property, and then attempt to get the owner of the land to sign away the mineral rights to the property in the form of a lease. If the property owner were well informed about the possibility that oil might in fact be found on his land, the price of the lease would obviously go up, because signing away the mineral rights meant that the income (or "royalties") from any oil that might be found would never go to the owner of the land.

A cunning landman would try to gather as much insider information as he could and keep the rancher as much in the dark as possible. In rural Texas in the 1940s, the role of the landman could rather easily degenerate into that of the ruthless, money-grubbing con artist, who would try to convince an ill-informed and possibly ignorant Texas dirt farmer, who was just coming up for air after the great depression, that the chances of finding oil on his land were just about zero, and that even a token fee for a lease on the mineral rights would be eminently worth taking.

Once the farmer or rancher had signed away his right to future oil royalties, the landman would turn around and attempt to "broker" the lease by selling it at an inflated price to a major oil company that might be interested in drilling, or to some other buyer. There was a lively market in such leases in the restaurant of the Scharbauer Hotel in Midland, where maps of the oil fields hung on the walls and oil leases could change hands repeatedly in the course of a single day. Sometimes, if a landman were forced to sell a lease to the mineral rights of land where he really thought there might be oil, he would seek to retain an override, perhaps amounting to a sixteenth or a thirty-second of the royalties from future production. But that would mean less cash or even no cash received now, and small-time operators like Overbey, who had no capital resources of their own, were always strapped for cash. Overbey was lucky if he could realize a profit of a few hundred dollars on the sale of a lease.

This form of activity clearly appealed to the mean-spirited and the greedy, to those who enjoyed rooking their fellow man. It was one thing for Overbey, who may have had no alternative to support his family. It was quite another thing for George Herbert Walker Bush, a young plutocrat out slumming. But Bush was drawn to the landman and royalty game, so much so that he offered to raise capital back East if Overbey would join him in a partnership.<sup>9</sup>

Overbey accepted Bush's proposition that they capitalize a company that would trade in the vanished hopes of the ranchers and farmers of northwest Texas. Bush and Overbey flew back East to talk with Uncle Herbie in the oak-paneled board room of G.H. Walker & Co. in

Wall

Street. According to *Newsweek*, "Bush's partner, John Overbey, still remembers the dizzying whirl of a money-raising trip to the East with George and Uncle Herbie: lunch at New York's 21 Club, weekends at Kennebunkport where a bracing Sunday dip in the Atlantic off Walker's Point ended with a servant wrapping you in a large terry towel and handing you a martini."<sup>9</sup>

The result of the odyssey back East was a capital of \$300,000, much of it gathered from Uncle Herbie's clients in the City of London, who were of course delighted at the prospect of parasitizing Texas ranchers. One of those eager to cash in was Jimmy Gammell of Edinburgh, Scotland, whose Ivory and Sime counting house put up \$50,000 from its Atlantic Asset Trust. Gammell's father had been head of the British military mission in Moscow in 1945, part of the Anglo-American core group there with U.S. Ambassador Averell Harriman. James Gammell is today the eminence grise of the Scottish investment community, and he has retained a close personal relation to Bush over the years. Mark this Gammell well; he will return to our narrative shortly.

Eugene Meyer, the owner of the *Washington Post* and the father of that paper's present owner, Katharine Meyer Graham, anted up an investment of \$50,000 on the basis of the tax-shelter capabilities promised by Bush-Overbey. Meyer, a president of the World Bank, also procured an investment from his son-in-law Phil Graham for the Bush venture. Father Prescott Bush was also counted in, to the tune of about \$50,000. In the days of real money, these were considerable sums. The London investors got shares of stock in the new company, called Bush-Overbey, as well as Bush-Overbey bonded debt. Bush and Overbey moved into an office on the ground floor of the Petroleum Building in Midland.

The business of the landman, it has been pointed out, rested entirely on personal relations and schmooze. One had to be a dissembler and an intelligencer. One had to learn to cultivate friendships with the geologists, the scouts, the petty bureaucrats at the county court house where the land records were kept, the journalists at the local paper, and with one's own rivals, the other landmen, who might invite someone with some risk capital to come in on a deal. Community service was an excellent mode of ingratiation, and George Bush volunteered for the Community Chest, the YMCA, and the Chamber of Commerce. It meant small talk about wives and kids, attending church—deception postures that in a small town had to pervade the smallest details of one's life.

It was at this time in his life that Bush seems to have acquired the habit of writing ingratiating little personal notes to people he had recently met, a habit that he would use over the years to cultivate and maintain his personal network. Out of all this ingratiating Babbity and boosterism would come acquaintances and the bits of information that could lead to wind-fall profits.

There had been a boom in Scurry County, but that was subsiding. Bush drove to Pyote, to Snyder, to Sterling City, to Monahans, with Rattlesnake Air Force Base just outside of





George M. W. Bush

### Chairman's Letter

In the history of our company the year 1965 will be remembered both as a year of progress and a year of disappointment. I believe you will find the progress clearly spelled out in the following report on our activities and in the financial statements. The disappointment came in the loss of our large and highly successful drilling barge MAVERICK which disappeared in Hurricane Betsy.

On September 30th, the day Hurricane Betsy struck, MAVERICK was located 20 miles off the Louisiana Coast in 220 feet of water. The following day an inspection showed Zapata's three other rigs were undamaged, but the MAVERICK had sunk. This was the largest single loss that the domestic offshore drilling industry sustained in the or any other hurricane. Another rig, identical to the MAVERICK, sailing less than 40 miles from it, came through the storm with no damage. The unpredictability of hurricanes was borne out by this first experience.

I am pleased to note here that within three weeks of the Hurricane Betsy, your company had been paid the full value by the insurance companies. The coverage was provided by Lloyd's of London and British insurance companies, and the offshore drilling business should be grateful for the way in which these companies have responded when disaster has struck.

The MAVERICK loss was a substantial one for Zapata. This was our largest rig and one of our very best contracts, but in spite of this we gained several contracts. Fortunately, we have two other rigs under construction and the surplus power generated by the new equipment should assure Zapata's future growth.

For the sixth time in the past 7 years, your company showed a significant improvement in earnings. The \$1.45 per share received this year compares favorably with last year's \$1.15. Our sales were up 5%, our profit margin remained satisfactory, the domestic and foreign demand for offshore drilling contract services continued at peak levels, and all in all it is safe to say that 1965 was our very best year.

Our goals for 1966 have been established. First, we want to continue to expand in the offshore drilling business. This goal seems readily attainable. The demand picture looks good and new places to drill in the water are opening up in many areas of the globe.

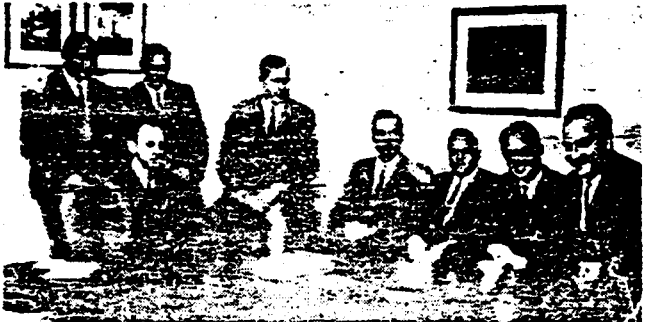
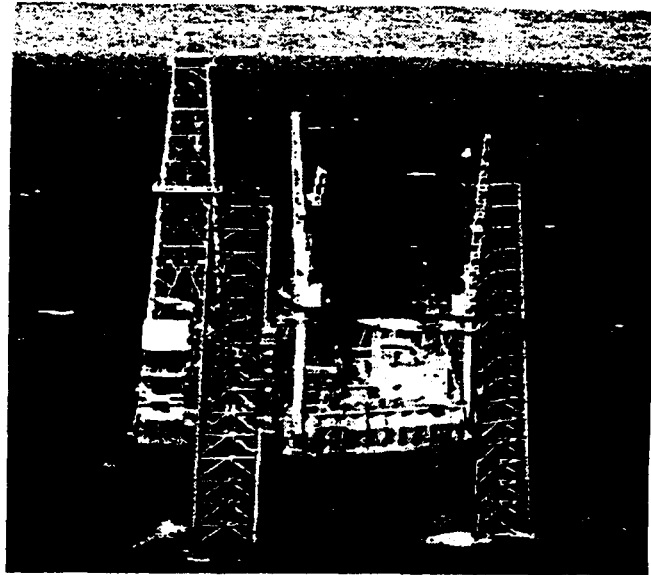

Left, a letter from Zapata Offshore chairman George Bush to the company's stockholders, in the 1965 annual report, apologizing for poor financial performance. Lower right, Zapata's directors with George Bush (third from left). Above right, an offshore oil drilling rig. Because SEC records on Zapata for 1960-66 were destroyed under the Reagan-Bush administration, the only documentation of the company's activities is on this poor-quality microfiche.

town. How many Texas ranchers can remember selling their mineral rights for a pittance to smiling George Bush, and then having oil discovered on the land, oil from which their family would never earn a penny?

Across the street from Bush-Overbey were the offices of Liedtke & Liedtke, Attorneys-at-law. J. Hugh Liedtke and William Liedtke were from Tulsa, Oklahoma, where they, like Bush, had grown up rich, as the sons of a local judge who had become one of the top corporate lawyers for Gulf Oil. The Liedtkes' grandfather had come from Prussia, but had served in the Confederate Army. J. Hugh Liedtke had found time along the way to acquire the notorious Harvard Master of Business Administration degree in one year. After service in the Navy during World War II, the Liedtkes obtained law degrees at the University of Texas law school, where they rented the servants' quarters of the home of U.S. Senator Lyndon B. Johnson, who was away in Washington most of the time. . .

The Liedtkes combined the raw, uncouth primitive accumulation mentality of the oil boom town with the refined arts of usury and speculation as Harvard taught them. Their law practice was such in name only; their primary and almost exclusive activity was buying up royalty leases on behalf of a moneybags in Tulsa who was a friend of their family. . .

Hugh Liedtke was always on the lookout for the Main Chance. Following in the footsteps of his fellow Tulsan Ray Kravis, Hugh Liedtke

schemed and schemed until he had found a way to go beyond hustling for royalty leases: He concocted a method of trading oil-producing properties in such a way as to permit the eventual owner to defer all tax liabilities until the field was depleted. Sometimes Hugh Liedtke would commute between Midland and Tulsa on an almost daily basis. He would spend the daylight hours prowling the Permian Basin for a land deal, make the 13-hour drive to Tulsa overnight to convince his backers to ante up the cash, and then race back to Midland to close the deal before the sucker got away. It was during this phase that it occurred to Liedtke that he could save himself a lot of marathon commuter driving if he could put together a million dollars in venture capital and "inventory" the deals he was otherwise forced to make on a piecemeal, ad hoc basis.<sup>10</sup>

## Zapata Petroleum

The Liedtke brothers now wanted to go beyond royalty leases and land sale tax dodges, and begin large-scale drilling and production of oil. George Bush, by now well versed in the alphas and omegas of oil as ground rent, was thinking along the same lines. In a convergence that was full of ominous portent for the U.S. economy of the 1980s, the Liedtke brothers and George Bush decided to pool their capital and



their rapacious talents by going into business together. Overbey was on board initially, but would soon fall away.

The year was 1953, and Uncle Herbie's G.H. Walker & Co. became the principal underwriter of the stock and convertible debentures that were to be offered to the public. Uncle Herbie would also purchase a large portion of the stock himself. When the new company required further infusions of capital, Uncle Herbie would float the necessary bonds. Jimmy Gammell remained a key participant and would find a seat on the board of directors of the new company. Another of the key investors was the Clark Family Estate, meaning the trustees who managed the Singer Sewing machine fortune.<sup>11</sup> Some other money came from various pension funds and endowments, sources that would become very popular during the leveraged buyout orgy Bush presided over in the 1980s. Of the capital of the new Bush-Liedtke concern, about \$500,000 would come from Tulsa cronies of the Liedtke brothers, and the other \$500,000 from the circles of Uncle Herbie. The latter were referred to by Hugh Liedtke as "the New York guys."

The name chosen for the new concern was Zapata Petroleum. According to Hugh Liedtke, the new entrepreneurs were attracted to the name when they saw it on a movie marquee, where the new release *Viva Zapata!*, starring Marlon Brando as the Mexican revolutionary, was playing. Liedtke characteristically explains that part of the appeal of the name was the confusion as to whether Zapata had been a patriot or a bandit.<sup>12</sup>

The Bush-Liedtke combination concentrated its attention on an oil property in Coke County called Jameson Field, a barren expanse of prairie and sagebrush where six widely separated wells had been producing oil for some years. Hugh Liedtke was convinced that these six oil wells were tapping into a single underground pool of oil, and that dozens or even hundreds of new oil wells drilled into the same field would all prove to be gushers. In other words, Liedtke wanted to gamble the entire capital of the new firm on the hypothesis that the wells were, in oil parlance, "connected." One of Liedtke's Tulsa backers was supposedly unconvinced, and argued that the wells were too far apart; they could not possibly connect. "Goddamn, they do!" was Hugh Liedtke's rejoinder. He insisted on shooting the works in a *va-banque* operation. Uncle Herbie's circles were nervous: "The New York guys were just about to pee in their pants," boasted Liedtke years later. Bush and Hugh Liedtke obviously had the better information: The wells were connected, and 127 wells were drilled without encountering a single dry hole. As a result, the price of a share of stock in Zapata went up from seven cents a share to \$23.

During this time, Hugh Liedtke collaborated on several small deals in the Midland area with a certain T. Boone Pickens, later one of the most notorious corporate raiders of the 1980s, one of the originators of the "greenmail" strategy of extortion, by which a raider would accumulate part of the shares of a company and threaten to go all the way to a hostile takeover unless the management of the company agreed to buy back those shares at an outrageous premium. Pickens is the buccaneer who was self-righteously

indignant when the Japanese business community attempted to prevent him from introducing these shameless looting practices into the Japanese economy.

Pickens, too, was a product of the Bush-Liedtke social circle of Midland. When he was just getting started in the mid-fifties, Pickens wanted to buy the Hugoton Production Company, which owned the Hugoton field, one of the world's great onshore deposits of natural gas. Pickens engineered the hostile takeover of Hugoton by turning to Hugh Liedtke to be introduced to the trustees of the Clark Family Estate, who, as we have just seen, had put up part of the capital for Zapata. Pickens promised the Clark trustees a higher return than was being provided by the current management, and this support proved to be decisive in permitting Pickens's Mesa Petroleum to take over Hugoton, launching this corsair on a career of looting and pillage that still continues. In 1988, George Bush would give an interview to a magazine owned by Pickens in which the Vice President would defend hostile leveraged buyouts as necessary to the interests of the shareholders.

In the meantime, after two to three years of operations, the oil flow out of Zapata's key Jameson field had begun to slow down. Although there was still abundant oil in the ground, the natural pressure had been rapidly depleted, so Bush and the Liedtkes had to begin resorting to stratagems in order to bring the oil to the surface. They began pumping water into the underground formations in order to force the oil to the surface. From then on, "enhanced recovery" techniques were necessary to keep the Jameson field on line.

During 1955 and 1956, Zapata was able to report a small profit. In 1957, the year of the incipient Eisenhower recession, this turned into a loss of \$155,183, as the oil from the Jameson field began to slow down. In 1958, the loss was \$427,752, and in 1959, there was \$207,742 of red ink. 1960 (after Bush had departed from the scene) brought another loss, this time of \$372,258. It was not until 1961 that Zapata was able to post a small profit of \$50,482.<sup>13</sup> Despite the fact that Bush and the Liedtkes all became millionaires through the increased value of their shares, it was not exactly an enviable record; without the deep pockets of Bush's Uncle Herbie Walker and his British backers, the entire venture might have foundered at an early date.

Bush and the Liedtkes had been very lucky with the Jameson field, but they could hardly expect such results to be repeated indefinitely. In addition, they were now posting losses, and the value of Zapata stock had gone into a decline. Bush and the Liedtke brothers now concluded that the epoch in which large oil fields could be discovered within the continental United States was over. Mammoth new oil fields, they believed, could only be found offshore, located under hundreds of feet of water on the continental shelves, or in shallow seas like the Gulf of Mexico and the Caribbean.

By a happy coincidence, in 1954 the U.S. federal government was just beginning to auction the mineral rights for these offshore areas. With father Prescott Bush directing his potent

Brown Brothers Harriman/Skull and Bones network from the U.S. Senate while regularly hobnobbing with President Eisenhower on the golf links, George Bush could be confident of receiving special privileged treatment when it came to these mineral rights. Bush and his partners therefore judged the moment ripe for launching a for-hire drilling company, Zapata Offshore, a Delaware corporation that would offer its services to the companies making up the Seven Sisters international oil cartel in drilling underwater wells. Forty percent of the offshore company's stock would be owned by the original Zapata firm. The new company would also be a buyer of offshore royalty leases. Uncle Herbie helped arrange a new issue of stock for this Zapata offshoot. The shares were easy to unload because of the 1954 boom in the New York stock market. "The stock market lent itself to speculation," Bush would explain years later, "and you could get equity capital for new ventures."<sup>14</sup>

1954 was also the year that the CIA overthrew the government of Jacobo Arbenz in Guatemala. This was the beginning of a dense flurry of U.S. covert operations in Central America and the Caribbean, featuring especially Cuba.

The first asset of Zapata Offshore was the SCORPION, a \$3.5 million deep-sea drilling rig that was financed by \$1.5 million from the initial stock sale plus another \$2 million from bonds marketed with the help of Uncle Herbie. The SCORPION was the first three-legged, self-elevating mobile drilling barge, and it was built by R. G. LeTourneau, Inc. of Vicksburg, Mississippi. The platform weighed some 9 million pounds and measured 180 by 150 feet, and the three legs were 140 feet long when fully extended. The rig was floated into the desired drilling position before the legs were extended, and the main body was then pushed up above the waves by electric motors. The SCORPION was delivered early in 1956, was commissioned at Galveston in March, 1956 and was put to work at exploratory drilling in the Gulf of Mexico during the rest of the year.

During 1956, the Zapata Petroleum officers included J. Hugh Liedtke as president, George H.W. Bush as vice president, and William Brumley of Midland, Texas, as treasurer. The board of directors lined up as follows:

- George H.W. Bush, Midland, Texas;
- J.G.S. Gammell, Edinburgh, Scotland, manager of British Assets Trust, Ltd.;
- J. Hugh Liedtke, Midland, Texas;
- William C. Liedtke, independent oil operator, Midland, Texas;
- Arthur E. Palmer, Jr., New York, N.Y., a partner in Winthrop, Stimson, Putnam, and Roberts;
- G.H. Walker, Jr. (Uncle Herbie), managing partner of G.H. Walker and Co., New York, N.Y.;
- Howard J. Whitehill, independent oil producer, Tulsa, Oklahoma;
- Eugene F. Williams, Jr., secretary of the St. Louis Union Trust Company of St. Louis, Missouri; fellow member with "Poppy" Bush in the class of 1942 AUV secret society at Andover prep, later chairman of the Andover board;

• D.D. Bovaird, president of the Bovaird Supply Co. of Tulsa, Oklahoma, and chairman of the board of the Oklahoma City branch of the Tenth Federal District of the Federal Reserve Board; and

• George L. Coleman, investments, Miami, Oklahoma.

An interim director that year had been Richard E. Fleming of Robert Fleming and Co., London, England. Counsel were listed as Baker, Botts, Andrews & Shepherd of Houston, Texas; auditors were Arthur Andersen in Houston, and transfer agents were J.P. Morgan & Co., Inc., of New York City and the First National Bank and Trust Company of Tulsa.<sup>15</sup>

George Bush personally was much more involved with the financial management of the company than with its actual oil-field operations. His main activity was not finding oil or drilling wells but, as he himself put it, "stretching paper"—rolling over debt and making new financial arrangements with the creditors.<sup>16</sup>

During 1956, despite continuing losses and thanks again to Uncle Herbie, Zapata was able to float yet another offering, this time a convertible debenture for \$2.15 million, for the purchase of a second Le Tourneau drilling platform, the VINEGARON, named after a west Texas stinging insect. The VINEGARON was delivered during 1957, and soon scored a "lucky" hit drilling in block 86 off Vermilion Parish, Louisiana. This was a combination of gas and oil, and one well was rated at 113 barrels of distillate and 3.6 million cubic feet of gas per day.<sup>17</sup> This was especially remunerative, because Zapata had acquired a half-interest in the royalties from any oil or gas that might be found. VINEGARON then continued to drill offshore from Vermilion Parish, Louisiana, on a farmout from Continental Oil.

As for the SCORPION, during part of 1957 it was under contract to the Bahama-California Oil Company, drilling between Florida and Cuba. It was then leased by Gulf Oil and Standard Oil of California, on whose behalf it started drilling during 1958 at a position on the Cay Sal Bank, 131 miles south of Miami, Florida, and just 54 miles north of Isabela, Cuba. Cuba was an interesting place just then; the U.S.-backed insurgency of Fidel Castro was rapidly undermining the older U.S.-imposed regime of Fulgencio Batista. That meant that SCORPION was located at a hot corner. We note that Allen Dulles, then director of the Central Intelligence Agency, had previously been legal counsel to Gulf Oil for Latin American operations, and counsel to George Bush's father at Brown Brothers Harriman for eastern Europe.

During 1957 a certain divergence began to appear between Uncle Herbie Walker, Bush, and the "New York guys" on the one hand, and the Liedtke brothers and their Tulsa backers on the other. As the annual report for that year noted, "There is no doubt that the drilling business in the Gulf of Mexico has become far more competitive in the last six months than it has been at any time in the past." Despite that, Bush, Walker and the New York investors wanted to push forward into the offshore drilling and drilling services business, while the Lied-

tkes and the Tulsa group wanted to concentrate on acquiring oil in the ground and natural gas deposits.

The 1958 annual report notes that, with no major discoveries made, 1958 had been "a difficult year." It was, of course, the year of the brutal Eisenhower recession. SCORPION, VINGARON, and NOLA I, the offshore company's three drilling rigs, could not be kept fully occupied in the Gulf of Mexico during the whole year, and so Zapata Offshore had lost \$524,441, more than Zapata Petroleum's own loss of \$427,752 for that year. The Liedtke viewpoint was reflected in the notation that "disposing of the offshore business had been considered." The great tycoon Bush conceded in the Zapata Offshore annual report for 1958: "We erroneously predicted that most major [oil] companies would have active drilling programs for 1958. These drilling programs simply did not materialize. . . ." In 1990, Bush denied for months that there was a recession, and through 1991 claimed that the recession had ended, when it had, in fact, long since turned into a depression. His current blindness about economic conjunctures would appear to be nothing new.

By 1959, there were reports of increasing personal tensions between the domineering and abrasive J. Hugh Liedtke, on the one hand, and Bush's Uncle Herbie Walker on the other. Liedtke was obsessed with his plan for creating a new major oil company, the boundless ambition that would propel him down a path littered with asset-stripped corporations into the devastating Pennzoil-Getty-Texaco wars of a quarter-century later. During the course of this year, the two groups of investors arrived at a separation that was billed as "amicable," and which in any case never interrupted the close cooperation among Bush and the Liedtke brothers. The solution was that the ever-present Uncle Herbie would buy out the Liedtke-Tulsa 40 percent stake in Zapata Offshore, while the Liedtke backers would buy out the Bush-Walker interest in Zapata Petroleum.

For this to be accomplished, George Bush would require yet another large infusion of capital. Uncle Herbie now raised yet another tranche for George, this time over \$800,000. The money allegedly came from Bush-Walker friends and relatives.<sup>18</sup> Even if the faithful efforts of Uncle Herbie are taken into account, it is still puzzling to see a series of large infusions of cash into a poorly managed small company that had posted a series of substantial losses and whose future prospects were anything but rosy. At this point it is therefore legitimate to pose the question: Was Zapata Offshore an intelligence community front at its foundation in 1954, or did it become one in 1959, or perhaps at some later point? This question cannot be answered with finality, but some relevant evidence will be discussed in the following chapter.

George Bush was now the president of his own company, the undisputed boss of Zapata Offshore. Although the company was falling behind the rest of the offshore drilling industry, Bush made a desultory attempt at expansion through diversification, investing in a plastics

machinery company in New Jersey, a Texas pipe lining company, and a gas transmission company; none of these investments proved to be remunerative.

#### Notes

1. Harry Hurt III, "George Bush, Plucky Lad," *Texas Monthly*, June 1983.
2. See Sarah Bartlett, *The Money Machine: How KKR Manufactured Power and Profits* (New York, 1991), pp. 9-12.
3. Darwin Payne, *Initiative in Energy: Dresser Industries, Inc., 1880-1978* (New York: Simon and Schuster, ca. 1979), p. 232 ff.
4. Bartlett, *op. cit.*, p. 268.
5. Darwin Payne, *op. cit.*, p. 232-33.
6. Hurt, *op. cit.*
7. *Ibid.*
8. "Bush Battles the 'Wimp Factor,'" *Newsweek*, Oct. 19, 1987.
9. See Richard Ben Kramer, "How He Got Here," *Esquire*, June 1991.
10. See Thomas Petzinger, Jr., *Oil and Honor: The Texaco-Pennzoil Wars* (New York, 1987), p. 37 ff.
11. *Ibid.*, p. 93.
12. *Ibid.*, p. 40.
13. See Zapata Petroleum annual reports, Library of Congress Microform Reading Room.
14. Petzinger, *op. cit.*, p. 41.
15. See Zapata Petroleum Corporation Annual Report for 1956, Library of Congress, Microform Reading Room.
16. Hurt, *op. cit.*, p. 194.
17. "Zapata Petroleum Corp.," *Fortune*, April 1958.
18. Walter Pincus and Bob Woodward, "Doing Well With Help From Family, Friends," *Washington Post*, Aug. 11, 1988.

## Kennedy Assassination

"JM/WAVE . . . proliferated across [Florida] in preparation for the Bay of Pigs invasion. A subculture of fronts, proprietaries, suppliers, transfer agents, conduits, dummy corporations, blind drops, detective agencies, law firms, electronic firms, shopping centers, airlines, radio stations, the mob and the church and the banks: a false and secret nervous system twitching to stimuli supplied by the cortex in *Clandestine Services* in Langley. After defeat on the beach in Cuba, JM/WAVE became a continuing and extended Miami Station, CIA's largest in the continental United States. A large sign in front of the . . . building complex reads: U.S. GOVERNMENT REGULATIONS PROHIBIT DISCUSSION OF THIS ORGANIZATION OR FACILITY."

—Donald Freed, *Death in Washington* (Westport, Connecticut, 1980), p. 141.

The review offered so far of George Bush's activities during the late 1950s and early 1960s is almost certainly incomplete in very important respects. There is good reason to believe that Bush was engaged in something more than just the oil business during those years. Starting about the time of the Bay of Pigs invasion in the spring of 1961, we have the first hints that Bush, in addition to working for Zapata Offshore, may also have been a participant in certain covert operations of the U.S. intelligence community.

Such participation would certainly be coherent with George's role in the Prescott Bush, Skull and Bones, and Brown Brothers Harriman networks. During the twentieth century,

the Skull and Bones/Harriman circles have always maintained a sizeable and often decisive presence inside the intelligence organizations of the State Department, the Treasury Department, the Office of Naval Intelligence, the Office of Strategic Services, and the Central Intelligence Agency.

A body of leads has been assembled which suggests that George Bush may have been associated with the CIA at some time before the autumn of 1963. According to Joseph McBride of *The Nation*, "a source with close connections to the intelligence community confirms that Bush started working for the agency in 1960 or 1961, using his oil business as a cover for clandestine activities."<sup>1</sup> By the time of the Kennedy assassination, we have an official FBI document which refers to "Mr. George Bush of the Central Intelligence Agency," and despite official disclaimers, there is every reason to think that this is indeed the man in the White House today.

The mystery of George Bush as a possible covert operator hinges on four points, each one of which represents one of the great political and espionage scandals of postwar American history. These four cardinal points are:

1. The abortive Bay of Pigs invasion of Cuba, launched on April 16-17, 1961, prepared with the assistance of the CIA's "Miami Station" (also known under the code name JM/WAVE). After the failure of the amphibious landings of Brigade 2506, Miami station, under the leadership of Theodore Shackley, became the focus for Operation Mongoose, a series of covert operations directed against Castro, Cuba, and possibly other targets.

2. The assassination of President John F. Kennedy in Dallas on November 22, 1963, and the coverup of those responsible for this crime.

3. The Watergate scandal, beginning with an April 1971 visit to Miami, Florida by E. Howard Hunt on the tenth anniversary of the Bay of Pigs invasion to recruit operatives for the White House Special Investigations Unit (the "Plumbers" and later Watergate burglars) from among Cuban-American Bay of Pigs veterans.

4. The Iran-Contra affair, which became a public scandal during October-November 1986, several of whose central figures, such as Felix Rodriguez, were also veterans of the Bay of Pigs.

George Bush's role in both Watergate and the October Surprise/Iran-Contra complex will be treated in detail at later points in this book. Right now, it is important to see that thirty years of covert operations, in many respects, form a single continuous whole. This is especially true in regard to the *dramatis personae*. Georgie Anne Geyer points to the obvious in a recent book: "... an entire new Cuban cadre now emerged from the Bay of Pigs. The names Howard Hunt, Bernard Barker, Rolando Martinez, Felix Rodriguez and Eugenio Martinez would, in the next quarter century, pop up, often decisively, over and over again in the most dangerous American foreign policy crises. There were Cubans flying missions for the CIA in the Congo and even for the Portuguese in Africa; Cubans were the burglars of Watergate; Cubans played key roles in Nicaragua, in Irangate, in the

American move into the Persian Gulf."<sup>2</sup> Felix Rodriguez tells us that he was infiltrated into Cuba with the other members of the "Grey Team" in conjunction with the Bay of Pigs landings; this is the same man we will find directing the Contra supply effort in Central America during the 1980s, working under the direct supervision of Don Gregg and George Bush.<sup>3</sup> Theodore Shackley, the JM/WAVE station chief, will later show up in Bush's 1979-80 presidential campaign.

To a very large degree, such covert operations have drawn upon the same pool of personnel. They are to a significant extent the handiwork of the same crowd. It is therefore revealing to extrapolate forward and backward in time the individuals and groups of individuals who appear as the cast of characters in one scandal, and compare them with the cast of characters for the other scandals, including the secondary ones that have not been enumerated here. E. Howard Hunt, for example, shows up as a confirmed part of the overthrow of the Guatemalan government of Jacopo Arbenz in 1954, as an important part of the chain of command in the Bay of Pigs, as a person repeatedly accused of having been in Dallas on the day Kennedy was shot, and as one of the central figures of Watergate.

George Bush is demonstrably one of the most important protagonists of the Watergate scandal, and was the overall director of Iran-Contra. Since he appears especially in Iran-Contra in close proximity to Bay of Pigs holdovers, it is surely legitimate to wonder when his association with those Bay of Pigs Cubans might have started.

1959 was the year that Bush started operating out of his Zapata Offshore headquarters in Houston; it was also the year that Fidel Castro seized power in Cuba. Officially, as we have seen, George was now a businessman whose work took him at times to Louisiana, where Zapata had offshore drilling operations. George must have been a frequent visitor to New Orleans. Because of his family's estate on Jupiter Island, he would also have been a frequent visitor to the Hobe Sound area. And then, there were Zapata Offshore drilling operations in the Florida strait.

The Jupiter Island connection and father Prescott's Brown Brothers Harriman/Skull and Bones networks are doubtless the key. Jupiter Island meant Averell Harriman, Robert Lovett,

C. Douglas Dillon and other Anglophile financiers who had directed the U.S. intelligence community long before there had been a CIA at all. And, in the backyard of the Jupiter Island Olympians, and under their direction, a powerful covert operations base was now being assembled, in which George Bush would have been present at the creation as a matter of birthright.

## Operation Zapata

During 1959-60, Allen Dulles and the Eisenhower administration began to assemble in south Florida the infrastructure for covert action against Cuba. This was the JM/WAVE capability, later formally constituted as the CIA Miami station. JM/WAVE was an operational center for the Eisenhower regime's project of staging an invasion of Cuba using a secret army of anti-Castro Cuban exiles, organized, armed, trained, transported, and directed by the CIA. The Cubans, called Brigade 2506, were trained in secret camps in Guatemala, and they had air support from B-26 bombers based in Nicaragua. This invasion was crushed by Castro's defending forces in less than three days.

Before going along with the plan so eagerly touted by Allen Dulles, Kennedy had established the precondition that under no circumstances whatsoever would there be direct intervention by U.S. military forces against Cuba. On the one hand, Dulles had assured Kennedy that the news of the invasion would trigger an insurrection which would sweep Castro and his regime away. On the other, Kennedy had to be concerned about provoking a global thermonuclear confrontation with the U.S.S.R., in the eventuality that Nikita Khrushchev decided to respond to a U.S. Cuban gambit by, for example, cutting off U.S. access to Berlin.

Hints of the covert presence of George Bush are scattered here and there around the Bay of Pigs invasion. According to some accounts, the code name for the Bay of Pigs was Operation Pluto.<sup>4</sup> But Bay of Pigs veteran E. Howard Hunt scornfully denies that this was the code name used by JM/WAVE personnel; Hunt writes: "So perhaps the Pentagon referred to the Brigade invasion as Pluto. CIA did not."<sup>5</sup> But Hunt does not tell us what the CIA code name was, and the contents of Hunt's Watergate-era White House safe, which might have told us the answer, were, of course, "deep-sixed" by FBI Director Patrick Gray.

According to reliable sources and published accounts, the CIA code name for the Bay of Pigs invasion was Operation Zapata, and the plan was so referred to by Richard Bissell of the CIA, one of the plan's promoters, in a briefing to President Kennedy in the Cabinet Room on March 29, 1961.<sup>6</sup> Does Operation Zapata have anything to do with Zapata Offshore? The run-of-the-mill Bushman might respond that Emiliano Zapata, after all, had been a public figure in his own right, and the subject of a recent Hollywood movie starring Marlon Brando. A more knowledgeable Bushman might argue that the main landing beach, the Playa Giron, is located south of the city of Cienfuegos on the Zapata Peninsula, on the south coast of Cuba.

Then there is the question of the Brigade 2506 landing fleet, which was composed of five older freighters bought or chartered from the Garcia Steamship Lines, bearing the names of *Houston*, *Rio Escondido*, *Caribe*, *Atlantic*, and *Lake Charles*. In addition to these vessels, which were outfitted as transport ships, there were two somewhat better armed fire support ships, the *Blagar* and the *Barbara*. (In some sources *Barbara J.*)<sup>7</sup>

The *Barbara* was originally an LCI (Landing Craft Infantry) of earlier vintage. Our attention is attracted at once to the *Barbara* and the *Houston*, in the first case because we have seen George Bush's habit of naming his combat aircraft after his wife, and, in the second case, because Bush was at this time a resident and Republican activist of Houston, Texas. But of course, the appearance of names like "Zapata," "Barbara," and "Houston" can by itself only arouse suspicion, and proves nothing.

After the ignominious defeat of the Bay of Pigs invasion, there was great animosity against Kennedy among the survivors of Brigade 2506, some of whom eventually made their way back to Miami after being released from Castro's prisoner of war camps. There was also great animosity against Kennedy on the part of the JM/WAVE personnel.

During the early 1950s, E. Howard Hunt had been the CIA station chief in Mexico City. As David Atlee Phillips (another embittered JM/WAVE veteran) tells us in his autobiographical account, *The Night Watch*, E. Howard Hunt had been the immediate superior of a young CIA recruit named William F. Buckley, the Yale graduate and Skull and Bones member who later founded the *National Review*. In his autobiographical account written during the days of the Watergate scandal, Hunt includes the following tirade about the Bay of Pigs:

"No event since the communization of China in 1949 has had such a profound effect on the United States and its allies as the defeat of the U.S.-trained Cuban invasion brigade at the Bay of Pigs in April 1961.

"Out of that humiliation grew the Berlin Wall, the missile crisis, guerrilla warfare throughout Latin America and Africa, and our Dominican Republic intervention. Castro's beachhead triumph opened a bottomless Pandora's box of difficulties that affected not only the United States, but most of its allies in the Free World.

"These bloody and subversive events would not have taken place had Castro been toppled. Instead of standing firm, our government pyramided crucially wrong decisions and allowed Brigade 2506 to be destroyed. The Kennedy administration yielded Castro all the excuse he needed to gain a tighter grip on the island of José Martí, then moved shamefacedly into the shadows and hoped the Cuban issue would simply melt away."<sup>8</sup>

---

## Kennedy and MacArthur

Hunt was typical of the opinion that the debacle had been Kennedy's fault, and not the responsibility of men like Allen Dulles and Richard Bissell, who had designed it and recommended it. After the embarrassing failure of the invasion, which never evoked the hoped-for spontaneous anti-Castro insurrection, Kennedy fired Allen Dulles, his Harrimanite deputy Bissell, and CIA Deputy Director Charles Cabell (whose brother was the mayor of Dallas at the time Kennedy was shot).

During the days after the Bay of Pigs debacle, Kennedy was deeply suspicious of the intelligence community and of proposals for military escalation in general, including in places like South Vietnam. Kennedy sought to procure an outside, expert opinion on military matters. For this he turned to the former commander in chief of the Southwest Pacific Theatre during World War II, General Douglas MacArthur. Almost ten years ago, a reliable source shared with one of the authors an account of a meeting between Kennedy and MacArthur in which the veteran general warned the young President that there were elements inside the U.S. government who emphatically did not share his patriotic motives, and who were seeking to destroy his administration from within. MacArthur warned that the forces bent on destroying Kennedy were centered in the Wall Street financial community and its various tentacles in the intelligence community.

It is a matter of public record that Kennedy met with MacArthur in the latter part of April 1961, after the Bay of Pigs. According to Kennedy aide Theodore Sorenson, MacArthur told Kennedy, "The chickens are coming home to roost, and you happen to have just moved into the chicken house."<sup>9</sup> At the same meeting, according to Sorenson, MacArthur "warned [Kennedy] against the commitment of American foot soldiers on the Asian mainland, and the President never forgot this advice."<sup>10</sup> This point is grudgingly confirmed by Arthur M. Schlesinger, a Kennedy aide who had a vested interest in vilifying MacArthur, who wrote that "MacArthur expressed his old view that anyone wanting to commit American ground forces to the mainland [of Asia] should have his head examined."<sup>11</sup> MacArthur restated this advice during a second meeting with Kennedy when the General returned from his last trip to the Far East in July 1961.

Kennedy valued MacArthur's professional military opinion highly, and used it to keep at arms length those advisers who were arguing for escalation in Laos, Vietnam, and elsewhere. He repeatedly invited those who proposed to send land forces to Asia to convince MacArthur that this was a good idea. If they could convince MacArthur, then he, Kennedy, might also go along.

At this time, the group proposing escalation in Vietnam (as well as preparing the assassination of President Diem) had a heavy Brown Brothers Harriman/Skull and Bones overtone: The hawks of 1961-63 were Harriman, McGeorge Bundy, William Bundy, Henry Cabot Lodge, and some key London oligarchs and theoreticians of counterinsurgency wars. And of course, George Bush during these years was calling for escalation in Vietnam and challenging Kennedy to "muster the courage" to try a second invasion of Cuba.

In the meantime, the JM/WAVE-Miami station complex was growing rapidly to become the largest of Langley's many satellites. During the years after the failure of the Bay of Pigs, this complex had as many as 3,000 Cuban agents and subagents, with a small army of case officers to direct and look after each one. According to one account, there were at least 55

dummy corporations to provide employment, cover, and commercial disguise for all these operatives. There were detective bureaus, gun stores, real estate brokerages, boat repair shops, and party boats for fishing and other entertainments. There was the clandestine Radio Swan, later renamed Radio Americas. There were fleets of specially modified boats based at Homestead Marina, and at other marinas throughout the Florida Keys. Agents were assigned to the University of Miami and other educational institutions.

The *raison d'être* of the massive capability commanded by Theodore Shackley was now Operation Mongoose, a program for sabotage raids and assassinations to be conducted on Cuban territory, with a special effort to eliminate Fidel Castro personally. In order to run these operations from U.S. territory, flagrant and extensive violation of federal and state laws was the order of the day. Documents regarding the incorporation of businesses were falsified. Income tax returns were faked. FAA regulations were violated by planes taking off for Cuba or for forward bases in the Bahamas and elsewhere. Explosives moved across highways that were full of civilian traffic. The Munitions Act, the Neutrality Act, the customs and immigration laws were routinely flaunted.<sup>12</sup>

Above all, the drug laws were massively violated as the gallant anticommunist fighters filled their planes and boats with illegal narcotics to be smuggled back into the United States when they returned from their missions. By 1963, the drug-running activities of the covert operatives were beginning to attract attention. JM/WAVE, in sum, accelerated the slide of south Florida towards the status of drug and murder capital of the United States it achieved during the 1980s.

---

## The Kennedy Assassination

It cannot be the task of this study even to begin to treat the reasons for which certain leading elements of the Anglo-American financial oligarchy, perhaps acting with certain kinds of support from continental European aristocratic and neofascist networks, ordered the murder of John F. Kennedy. The British and the Harrimanites wanted escalation in Vietnam; by the time of his assassination Kennedy was committed to a pullout of U.S. forces. Kennedy, as shown by his American University speech of 1963, was also interested in seeking a more stable path of war avoidance with the Soviets, using the U.S. military superiority demonstrated during the Cuban missile crisis to convince Moscow to accept a policy of world peace through economic development. Kennedy was interested in the possibilities of anti-missile strategic defense to put an end to that nightmare of Mutually Assured Destruction which appealed to Henry Kissinger, a disgruntled former employee of the Kennedy administration whom the President had denounced as a madman.

Kennedy was also considering moves to limit or perhaps abolish the usurpation of authority over the national currency by the Wall Street and London interests controlling the Federal Reserve System. If elected to a second term, Kennedy was likely to reassert presidential control, as distinct from Wall Street control, over the intelligence community. There is good reason to believe that Kennedy would have ousted J. Edgar Hoover from his purported life tenure at the FBI, subjecting that agency to presidential control for the first time in many years. Kennedy was committed to a vigorous expansion of the space program, the cultural impact of which was beginning to alarm the finance oligarchs.

Above all, Kennedy was acting like a man who thought he was President of the United States, violating the collegiality of oligarchical trusteeship of that office that had been in force since the final days of Roosevelt. Kennedy furthermore had two younger brothers who might succeed him, putting a strong presidency beyond the control of the the Eastern Anglophile Liberal Establishment for decades. George Bush joined in the Harrimanite opposition to Kennedy on all of these points.

After Kennedy was killed in Dallas on November 22, 1963, it was alleged that E. Howard Hunt and Frank Sturgis had both been present, possibly together, in Dallas on the day of the shooting, although the truth of these allegations has never been finally established. Both Hunt and Sturgis were of course Bay of Pigs veterans who would later appear center stage in Watergate. There were also allegations that Hunt and Sturgis were among a group of six to eight derelicts who were found in boxcars sitting on the railroad tracks behind the grassy knoll near Dealey Plaza, and who were rounded up and taken in for questioning by the Dallas police on the day of the assassination. Some suspected that Hunt and Sturgis had participated in the assassination. Some of these allegations were at the center of the celebrated 1985 defamation case of *Hunt v. Liberty Lobby*, in which a Florida federal jury found against Hunt. But, since the Dallas Police Department and County Sheriff never photographed or fingerprinted the "derelicts" in question, it has so far proven impossible definitively to resolve this question. But these allegations and theories about the possible presence and activities of Hunt and Sturgis in Dallas were sufficiently widespread as to compel the Commission on CIA Activities Within the United States (the Rockefeller Commission) to attempt to refute them in its 1975 report.<sup>13</sup>

According to George Bush's official biography, he was during 1963 a well-to-do businessman residing in Houston, the busy president of Zapata Offshore and the chairman of the Harris County Republican Organization, supporting Barry Goldwater as the GOP's 1964 presidential candidate, while at the same time actively preparing his own 1964 bid for the U.S. Senate. But during that same period of time, Bush may have shared some common acquaintances with Lee Harvey Oswald.



## The De Mohrenschildt Connection

Between October 1962 and April 1963, Lee Harvey Oswald and his Russian wife Marina were in frequent contact with a Russian emigré couple living in Dallas: These were George de Mohrenschildt and his wife Jeanne. During the Warren Commission investigation of the Kennedy assassination, De Mohrenschildt was interviewed at length about his contacts with Oswald. When, in the spring of 1977, the discrediting of the Warren Commission report as a blatant coverup had made public pressure for a new investigation of the Kennedy assassination irresistible, the House Assassinations Committee planned to interview De Mohrenschildt once again. But in March 1977, just before de Mohrenschildt was scheduled to be interviewed by Gaeton Fonzi of the House committee's staff, he was found dead in Palm Beach, Florida. His death was quickly ruled a suicide. One of the last people to see him alive was Edward Jay Epstein, who was also interviewing De Mohrenschildt about the Kennedy assassination for an upcoming book. Epstein is one of the writers on the Kennedy assassination who enjoyed excellent relations with the late James Angleton of the CIA. If de Mohrenschildt were alive today, he might be able to enlighten us about his relations with George Bush, and perhaps afford us some insight into Bush's activities during this epoch.

Jeanne De Mohrenschildt rejected the finding of suicide in her husband's death. "He was eliminated before he got to that committee," the widow told a journalist in 1978, "because someone did not want him to get to it." She also maintained that George de Mohrenschildt had been surreptitiously injected with mind-altering drugs.<sup>14</sup>

After De Mohrenschildt's death, his personal address book was located, and it contained this entry: "Bush, George H.W. (Poppy) 1412 W. Ohio also Zapata Petroleum Midland." There is of course the problem of dating this reference. George Bush had moved his office and home from Midland to Houston in 1959, when Zapata



Offshore was constituted, so perhaps this reference goes back to some time before 1959. There is also the number: "4-6355." There are, of course, numerous other entries, including one W.F. Buckley of the Buckley brothers of New York City, William S. Paley of CBS, plus many oil men, stockbrokers, and the like.<sup>13</sup>

George De Mohrenschildt recounted a number of different versions of his life, so it is very difficult to establish the facts about him. According to one version, he was the Russian Count Sergei De Mohrenschildt, but when he arrived in the United States in 1938 he carried a Polish passport identifying him as Jerzy Sergius von Mohrenschildt, born in Mozyr, Russia in 1911. He may in fact have been a Polish officer, or a correspondent for the Polish News Service, or none of these. He worked for a time for the Polish Embassy in Washington, D.C. Some say that de Mohrenschildt met the chairman of Humble Oil, Blaffer, and that Blaffer procured him a job. Other sources say that during this time De Mohrenschildt was affiliated with the War Department. According to some accounts, he later went to work for the French Deuxième Bureau, which wanted to know about petroleum exports from the United States to Europe.

De Mohrenschildt in 1941 became associated with a certain Baron Konstantin von Maydell in a public affairs venture called "Facts and Film." Maydell was considered a Nazi agent by the FBI, and in September 1942 he was sent to North Dakota for an internment that would last four years. De Mohrenschildt was also reportedly in contact with Japanese networks at this time. In June 1941, De Mohrenschildt was questioned by police at Port Arthur, Texas, on the suspicion of espionage after he was found making sketches of port facilities. During 1941, De Mohrenschildt applied for a post in the U.S. Office of Strategic Services (OSS). According to the official account, he was not hired. Soon after he made the application, he went to Mexico where he stayed until 1944. In the latter year, he began study for a master's degree in petroleum engineering at the University of Texas. According to some accounts, during this period De Mohrenschildt was investigated by the Office of Naval Intelligence because of alleged communist sympathies.

After the war, De Mohrenschildt worked as a petroleum engineer in Cuba and Venezuela, and in Caracas he had several meetings with the Soviet ambassador. During the postwar years, he also worked in the Rangely oil field in Colorado. During the 1950s, after having married Winifred Sharpless, the daughter of an oil millionaire, de Mohrenschildt was active as an independent oil entrepreneur.

In 1957, De Mohrenschildt was approved by the CIA Office of Security to be hired as a U.S. government geologist for a mission to Yugoslavia. Upon his return he was interviewed by one J. Walter Moore of the CIA's Domestic Contact Service, with whom he remained in contact. During 1958, de Mohrenschildt visited Ghana, Togo, and Dahomey (now Benin); during 1959, he visited Africa again and returned by way of Poland. In 1959, he married Jeanne, his fourth

wife, a former ballet dancer and dress designer who had been born in Manchuria, where her father had been one of the directors of the Chinese Eastern Railroad.

During the summer of 1960, George and Jeanne De Mohrenschildt told their friends that they were going to embark on a walking tour of 11,000 miles along Indian trails from Mexico to Central America. One of their principal destinations was Guatemala City, where they were staying at the time of the Bay of Pigs invasion in April 1961, after which they made their way home by way of Panama and Haiti. After two months in Haiti, the De Mohrenschildts returned to Dallas, where they came into contact with Lee Harvey Oswald, who had come back to the United States from his sojourn in the Soviet Union in June 1962. By this time, de Mohrenschildt was also in frequent contact with Admiral Henry C. Bruton and his wife, to whom he introduced the Oswalds. Admiral Bruton was the former director of naval communications.

It is established that between October 1962 and late April 1963, de Mohrenschildt was a very important figure in the life of Oswald and his Russian wife. Despite Oswald's lack of social graces, De Mohrenschildt introduced him into Dallas society, took him to parties, assisted him in finding employment and much more. It was through De Mohrenschildt that Oswald met a certain Volkmar Schmidt, a young German geologist who had studied with Professor Wilhelm Kuetemeyer, an expert in psychosomatic medicine and religious philosophy at the University of Heidelberg, who compiled a detailed psychological profile of Oswald. Jeanne and George helped Marina move her belongings during one of her many estrangements from Oswald. According to some accounts, De Mohrenschildt's influence on Oswald was so great during this period that he could virtually dictate important decisions to the young ex-Marine simply by making suggestions.

According to some versions, de Mohrenschildt was aware of Oswald's alleged April 10, 1963 attempt to assassinate the well-known right-wing General Edwin Walker. According to Marina, De Mohrenschildt once asked Oswald, "Lee, how did you miss General Walker?" On April 19, George and Jeanne De Mohrenschildt went to New York City, and on April 29, the CIA Office of Security found that it had no objection to De Mohrenschildt's acceptance of a contract with the Duvalier regime of Haiti in the field of natural resource development. De Mohrenschildt appears to have departed for Haiti on May 1, 1963. In the meantime, Oswald had left Dallas and traveled to New Orleans.

According to Mark Lane, "there is evidence that De Mohrenschildt served as a CIA control officer who directed Oswald's actions." Much of the extensive published literature on de Mohrenschildt converges on the idea that he was a control agent for Oswald on behalf of some intelligence agency.<sup>14</sup>

It is therefore highly interesting that George Bush's name turns up in the personal address book of George de Mohrenschildt.



The Warren Commission went to absurd lengths to cover up the fact that George De Mohrenschildt was a denizen of the world of the intelligence agencies. This included ignoring the well-developed paper trail on De Mohrenschildt as Nazi and communist sympathizer, and later as a U.S. asset abroad. The Warren Commission concluded:

"The Commission's investigation has developed no signs of subversive or disloyal conduct on the part of either of the de Mohrenschildts. Neither the FBI, CIA, nor any witnesses contacted by the Commission has provided any information linking the De Mohrenschildts to subversive or extremist organizations. Nor has there been any evidence linking them in any way with the assassination of President Kennedy."<sup>17</sup>

---

## Bush, the CIA, and Kennedy

On the day of the Kennedy assassination, FBI records show George Bush as reporting a right-wing member of the Houston Young Republicans for making threatening comments about President Kennedy. According to FBI documents released under the Freedom of Information Act,

"On November 22, 1963 Mr. GEORGE H.W. BUSH, 5525 Briar, Houston, Texas, telephonically advised that he wanted to relate some hear say that he had heard in recent weeks, date and source unknown. He advised that one JAMES PARROTT had been talking of killing the President when he comes to Houston.

"PARROTT is possibly a student at the University of Houston and is active in politics in the Houston area."

According to related FBI documentation, "a check with Secret Service at Houston, Texas revealed that agency had a report that PARROTT stated in 1961 he would kill President Kennedy if he got near him." Here Bush is described as "a reputable businessman." FBI agents were sent to interrogate Parrott's mother, and later James Milton Parrott himself. Parrott had been discharged from the U.S. Air Force for psychiatric reasons in 1959. Parrott had an alibi for the time of the Dallas shootings; he had been in the company of another Republican activist. According to press accounts, Parrott was a member of the right-wing faction of the Houston GOP, which was oriented toward the John Birch Society and which opposed Bush's chairmanship.<sup>18</sup> According to the *San Francisco Examiner*, Bush's press office in August 1988 first said that Bush had not made any such call, and challenged the authenticity of the FBI documents. Several days later Bush's spokesman said that the candidate "does not recall" placing the call.

One day after he reported Parrott to the FBI, Bush received a highly sensitive, high-level briefing from the Bureau:

"Date: November 29, 1963

"To: Director of Intelligence and Research  
Department of State

"From: John Edgar Hoover, Director

"Subject: ASSASSINATION OF PRESIDENT JOHN F. KENNEDY, NOVEMBER 22, 1963

"Our Miami, Florida Office on November 23, 1963 advised that the Office of Coordinator of Cuban Affairs in Miami advised that the Department of State feels some misguided anti-Castro group might capitalize on the present situation and undertake an unauthorized raid against Cuba, believing that the assassination of President John F. Kennedy might herald a change in U.S. policy, which is not true.

"Our sources and informants familiar with Cuban matters in the Miami area advise that the general feeling in the anti-Castro Cuban community is one of stunned disbelief and, even among those who did not entirely agree with the President's policy concerning Cuba, the feeling is that the President's death represents a great loss not only to the U.S. but to all Latin America. These sources know of no plans for unauthorized action against Cuba.

"An informant who has furnished reliable information in the past and who is close to a small pro-Castro group in Miami has advised that those individuals are afraid that the assassination of the President may result in strong repressive measures being taken against them and, although pro-Castro in their feelings, regret the assassination.

"The substance of the foregoing information was orally furnished to Mr. George Bush of the Central Intelligence Agency and Captain William Edwards of the Defense Intelligence Agency on November 23, 1963, by Mr. W.T. Forsyth of this Bureau."

William T. Forsyth, since deceased, was an official of the FBI's Washington headquarters; during the time he was attached to the bureau's subversive control section, he ran the investigation of Dr. Martin Luther King. Was he also a part of the FBI's harassment of Dr. King?

The efforts of journalists to locate Captain Edwards have not been successful.

This FBI document identifying George Bush as a CIA agent in November 1963 was first published by Joseph McBride in *The Nation* in July 1988, just before Bush received the Republican nomination for President. McBride's source observed: "I know [Bush] was involved in the Caribbean. I know he was involved in the suppression of things after the Kennedy assassination. There was a very definite worry that some Cuban groups were going to move against Castro and attempt to blame it on the CIA."<sup>19</sup> When pressed for confirmation or denial, Bush's spokesman Stephen Hart commented: "Must be another George Bush."

Within a short time, the CIA itself would peddle the same damage control line. On July 19, 1988, in the wake of wide public attention to the report published in *The Nation*, CIA spokeswoman Sharron Basso departed from the normal CIA policy of refusing to confirm or deny reports that any person is or was a CIA employee. CIA spokeswoman Basso told the Associated Press that the CIA believed that "the record

should be clarified." She said that the FBI document "apparently" referred to a George William Bush who had worked in 1963 on the night shift at CIA headquarters, and that "would have been the appropriate place to have received such an FBI report." According to her account, the George William Bush in question had left the CIA to join the Defense Intelligence Agency in 1964.

For the CIA to volunteer the name of one of its former employees to the press was a shocking violation of traditional methods, which are supposedly designed to keep such names a closely guarded secret. This revelation may have constituted a violation of federal law. But no exertions were too great when it came to damage control for George Bush.

George William Bush had indeed worked for the CIA, the DIA, and the Alexandria, Virginia Department of Public Welfare before joining the Social Security Administration, in whose Arlington, Virginia office he was employed as a claims representative in 1968. George William Bush told *The Nation* that while at the CIA he was "just a lowly researcher and analyst" who worked with documents and photos and never received interagency briefings. He had never met Forsyth of the FBI or Captain Edwards of the DIA. "So it wasn't me," said George William Bush.<sup>20</sup>

Later, George William Bush formalized his denial in a sworn statement to a federal court in Washington, D.C. The affidavit acknowledges that while working at CIA headquarters between September 1963 and February 1964, George William Bush was the junior person on a three- to four-man watch which was on duty when Kennedy was shot. But, as George William Bush goes on to say, "have carefully reviewed the FBI memorandum to the Director, Bureau of Intelligence and Research, Department of State dated November 29, 1963 which mentions a Mr. George Bush of the Central Intelligence Agency. . . . I do not recognize the contents of the memorandum as information furnished to me orally or otherwise during the time I was at the CIA. In fact, during my time at the CIA, I did not receive any oral communications from any government agency of any nature whatsoever. I did not receive any information relating to the Kennedy assassination during my time at the CIA from the FBI.

"Based on the above, it is my conclusion that I am not the Mr. George Bush of the Central Intelligence Agency referred to in the memorandum."<sup>21</sup>

So we are left with the strong suspicion that the "Mr. George Bush of the CIA" referred to by the FBI is our own George Herbert Walker Bush, who, in addition to his possible contact with Lee Harvey Oswald's controller, may thus also join the ranks of the Kennedy assassination coverup. It makes perfect sense for George Bush to be called in on a matter involving the Cuban community in Miami, since that is a place where George has traditionally had a constituency. George inherited it from his father, Prescott Bush of Jupiter Island, and later passed it on to his own son, Jeb.

**"It is highly interesting that George Bush's name turns up in the personal address book of George De Mohrenschildt," who some experts believe was Lee Harvey Oswald's CIA control officer.**

#### Notes to Chapter 9

1. Joseph McBride, "'George Bush,' C.I.A. Operative," *The Nation* July 16, 1988.
2. Georgie Anne Geyer, *Guerrilla Prince* (Boston: Little, Brown, 1991).
3. Felix Rodriguez, *Shadow Warrior* (New York: Simon and Schuster, 1989).
4. On Pluto, see the East German study by Guenter Schumacher, *Operation Pluto* (Berlin, Deutscher Militärverlag, 1966).
5. E. Howard Hunt, *Give Us This Day* (New Rochelle: Arlington House, 1973), p. 214.
6. For Operation Zapata, see Michael R. Beschloss, *The Crisis Years: Kennedy and Khrushchev, 1960-63* (New York: Edward Burlingame Books, 1991), p. 89.
7. For the names of the ships at the Bay of Pigs, see Quintin Pino Machado, *La Batalla de Giron* (La Habana: Editorial de Ciencias Sociales, 1983), pp. 79-80. This source quotes one ship as the "Barbara J." See also Schumacher, *Operation Pluto*, pp. 98-99. See also Peter Wyden, *Bay of Pigs, The Untold Story* (New York: Simon and Schuster, 1979), which also has the "Barbara J." According to Quintin Pino Machado, the "Houston" had been given the new name of "Aguja" (Swordfish) and the "Barbara" that of "Barracuda" for the purposes of this operation.
8. E. Howard Hunt, *op. cit.*, pp. 13-14.
9. Theodore Sorenson, *Kennedy* (New York: Bantam, 1966), p. 329.
10. *Ibid.*, p. 723.
11. Arthur M. Schlesinger, *A Thousand Days* (Boston, 1965), p. 339.
12. See Warren Hinckle and William W. Turner, *The Fish is Red* (New York: Harper and Row, 1981), pp. 112 ff.
13. *Report to the President by the Commission on CIA Activities Within the United States* (Washington: U.S. Government Printing Office, 1975), pp. 251-287.
14. Jim Marrs, "Widow disputes suicide," *Fort Worth Evening Star-Telegram*, May 11, 1978.
15. A photocopy of George de Mohrenschildt's personal address book is preserved at the Assassination Archives and Research Center, Washington, D.C. The Bush entry is also cited in Mark Lane, *Plausible Denial* (New York: Thunder's Mouth Press, 1991), p. 332.
16. For De Mohrenschildt, see Mark Lane, *op. cit.*; Edward Jay Epstein, *Legend: The Secret World of Lee Harvey Oswald* (London: Hutchinson, 1978); C. Robert Blakey and Richard N. Billings, *The Plot to Kill the President* (New York: Times Books, 1981); and Robert Sam Anson, *They've Killed The President!* (New York: Bantam, 1975).
17. *Report of the Warren Commission on the Assassination of President Kennedy* (New York: Bantam, 1964), p. 262.
18. Miguel Acoca, "FBI: 'Bush' called about JFK killing," *San Francisco Examiner*, Aug. 25, 1988.
19. Joseph McBride, "'George Bush,' CIA Operative," *The Nation*, July 16/23, 1988, p. 42.
20. Joseph McBride, "Where Was George?" *The Nation*, Aug. 13/20, 1988, p. 117.
21. United States District Court for the District of Columbia, Civil Action 88-2600 GHR, *Assassination Archives and Research Center v. Central Intelligence Agency*, Affidavit of George William Bush, Sept. 21, 1988.



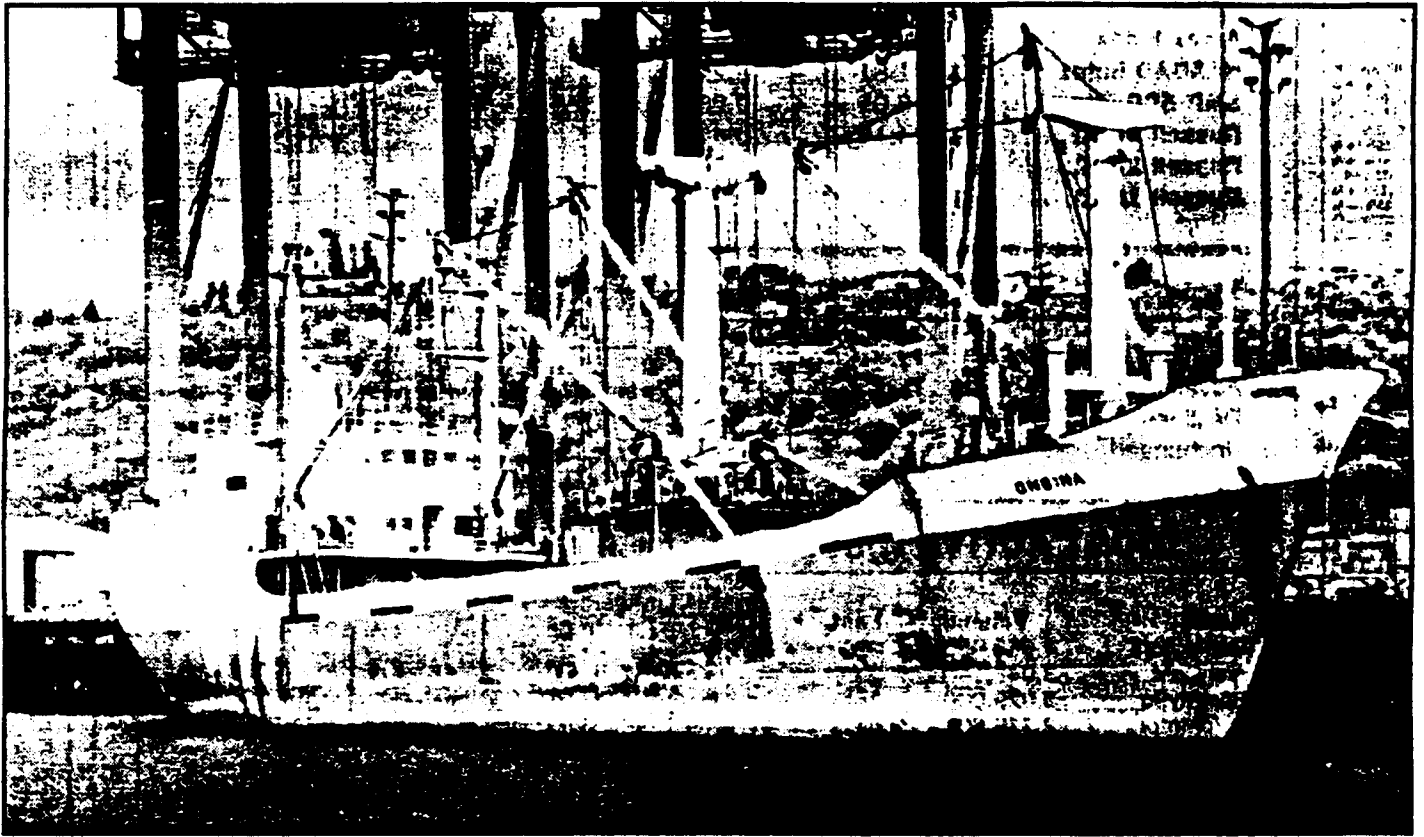

Geff Hinds/The News Tribune

Officials fear the Ondina, berthed near the Maersk terminal, could sink, catch fire or leak oil.

## Ship seized in drug bust perplexes port

By Addy Hatch  
The News Tribune

4-14-92

Nothing could be finer than getting rid of the Ondina, Port of Tacoma commissioners agreed Thursday.

The vessel has been at the port since July, when U.S. Customs agents seized 92 pounds of cocaine from its hold.

So far, the port has paid \$14,500 toward keeping the rusting old ship afloat, said Robert Goodstein, the port's attorney. The total tab for keeping it at the port since July, including dockage fees of \$664 a day, now stands at \$170,000.

To cut the port's losses, Goodstein asked for and was granted authorization by the commission to sell the right to foreclose on the Ondina to the highest

bidder.

Goodstein said port officials are not interested in foreclosing on the vessel themselves because the port does not want to end up owning the Ondina. "Our interest is in recovering our costs and moving the boat," he said.

John Terpstra, executive director of the Port of Tacoma, said several parties have expressed interest in buying the lien rights to the 275-foot ship.

Goodstein said the port can expect to recover most of the money it has spent so far to tow and maintain the Ondina, but the dock fee can't be collected unless the owner shows up to recover the ship. He said he doesn't hold out much hope of that.

The ship is based in Honduras, but the owner is believed to be somewhere in Colombia, Goodstein said.

Terpstra said he will be relieved to be rid of the Ondina, which is in Slip 1, near the Maersk terminal. There is always the danger the vessel will sink, catch fire or leak oil, he said.

"We've just been holding our breath," Terpstra said. The ship is in such disrepair that any maintenance fees "have just been pouring money down a rat hole," he said.

The captain and first officer of the Ondina were indicted shortly after the cocaine was seized by federal officers. The two were sentenced in February to five years in prison each for smuggling cocaine into the country.

A crane operator discovered the cocaine in unloading the Ondina's cargo of lead ore. The cocaine was worth an estimated \$4.5 million, Customs agents said.

# Italy Investigates CIA's Role in Terrorism and Drug Trafficking

7-13-90

by Sandro Mitromace  
 July 6 (EIRNS)—The government of Italy has asked the United States to supply all the information it may have on the links between the secret masonic lodge Propaganda-2, Western secret services, and the funding of terrorism, drugs, and destabilization. This unprecedented initiative came during a week of dramatic developments that saw the Italian parliament demanding that light be shed on the revelations made by two former CIA contract agents on how the "Company" financed P-2 in exchange for "favors, including destabilization, terrorism and illegal traffic in drugs and arms."

"We have used the assistance of these people [P-2] to get in and out of the United States drugs and money, and to get in and out of Italy drugs and money," former CIA contract agent Richard Brenneke declared on July 2 in an interview with Italian TV. "We used these people to create situations that would favor the explosion of terrorism in Italy and other European countries, at the beginning of the '70s. The P-2 is still alive and it is still used for the same purposes as at the beginning of the '70s."

The CIA has financed the P-2 to the tune of \$1 million to \$10 million per month, Brenneke charged. "That CIA money was used for several purposes, one of them terrorism. Another purpose was to obtain its support in smuggling drugs coming from other countries into the U.S. There also has always been a connection between the P-2 and CIA."

Brenneke stressed that the nominal head of the secret lodge, Licio Gelli, who was a fugitive for many years after

the P-2's game was momentarily stopped by Italian magistrates in 1962, was not the real boss of the criminal organization, but received orders from Switzerland and the United States.

### The Bush Connection

Brenneke was acquitted on May 4 by a federal court in Portland, Oregon, of charges that he lied to a judge when he accused President George Bush of being at the center of secret negotiations in October 1980 with representatives of Ayatollah Khomeini in Paris. The aim of the meetings—known as the "October Surprise"—was to postpone the freeing of American hostages in Iran until after the U.S. presidential elections, ensuring the victory of the Reagan-Bush team over Jimmy Carter.

"My allegations are very serious," Brenneke said in his TV interview, "and I would not make them if I did not have documentation to back them up." He stated that he is ready to supply the documents in his possession. These papers, according to sources, concern certain banking accounts in Switzerland and other financial holdings abroad, and the names of the Swiss, Italian, Luxembourgian, and American bankers who hide behind those secret bank accounts. These names never came out before, when the supposedly complete list of the members of the P-2 lodge was confiscated by police and made public.

### Terrorism and Assassinations

A few days before Brenneke's explosive interview was aired, the journalist who prepared it, Ennio Remondino, interviewed another former CIA agent, Ibrahim Razin, who now lives in hiding out of fear for his life. Razin said that he had learned from an im-

portant mafia boss that Licio Gelli in February 1986 had sent a telegram to a close associate of George Bush, Phil Guarino. The telegram stated: "Tell our good friend Bush that the Swedish tree will be felled." Three days later, Swedish Prime Minister Olof Palme was killed.

Razin said that Palme was killed because he knew too much about the illegal Irangate arms traffic, in which P-2 played a key role. The supply of weapons, according to Razin, represented payment for the political debt incurred by Bush and his friends to the Ayatollahs, when Iraq delayed the liberation of the hostages.

Razin stated, and nobody has tried to deny it, that the existence of the famous telegram can be proved just by looking into the archives of the National Security Agency.

### Demands for Investigation

These revelations have created an uproar in Italy. Twenty-six parliamentarians of the ruling Christian Democracy asked Prime Minister Giulio Andreotti to shed light on the P-2's connection to the CIA. Four top Christian Democratic senators asked the government to ascertain "the responsibility of national institutions in the question of terrorism and illegal traffic reported by the former CIA agent." They asked Andreotti to take an initiative on the international level, to get to the truth of the matter.

Journalist Remondino has provided the magistracy with full documentation of his story, and now the whole story is being investigated by the Tribunal of Rome. Licio Gelli, for his part, denounced the authors of the TV story for slander.



MATRIX III



0631-A-4

# Clinton Caught in Bigger Drug Scandal

by Kathleen Klenetsky  
 March 30 (EIRNS)—Democratic front-runner Bill Clinton has been caught in yet another explosive scandal, this one involving his links to a network of cocaine distributors in his home state of Arkansas.

Like Jimmy Carter, another Southern Governor who became President, Clinton's personal connections to illegal narcotics networks have long been the subject of speculation, especially since his half-brother Roger was arrested and convicted on drug charges in the mid-1980s.

Now, the Los Angeles Times has produced evidence of Clinton's ties

to the illegal drug trade.

Meanwhile, Clinton himself admitted yesterday that he used marijuana when he was a Rhodes Scholar in England. During a candidates' forum broadcast on New York's WCBS-TV, Clinton confessed that "I experimented with marijuana a time or two," when asked if he'd ever used drugs while a student at Oxford.

In the past, Slick Willie had weaseled out of owning up to smoking marijuana by responding to questions about past drug use with the line that he had never broken a U.S. federal or state law. (He did, however, break British law.)

## Another Dope in White House?

While Clinton dismissed his pot-smoking as a youthful experiment, he will have a far, far tougher time explaining away the Los Angeles Times' revelations.

In its March 23 editions, the Times reported that Gov. Clinton had personally lobbied Arkansas state legislators to persuade them to award a state bond contract to one of his strongest political backers, a Little Rock investment banker named Dan Lasater.

Clinton did so even though it was well known that Lasater was the subject of a police cocaine investi-

gation.

In fact, within a year of Clinton's lobbying, Lasater was arrested (and later convicted) on drug charges—although Clinton issued him a pardon after he got out of prison.

According to the Times' account, Lasater's investment company was awarded a \$30-million state bond contract to finance a new state police communications system in 1985. However, the contract was held up when the Arkansas Legislative Council failed to endorse the award.

At that point, Clinton intervened in the dispute, and succeeded in getting three members of the Council to drop their opposition to the bond contract. The contract was awarded to Lasater's firm, which turned a \$750,000 profit on the deal.

Clinton's intervention was pivotal. According to FBI documents obtained by the Times, one of Lasater's partners, George Locke, said flat out, "Because Lasater and Co. backed the right individual in Gov. Clinton, Lasater and Co. received the contract."

## All in the Family

Lasater also told the FBI he had loaned Roger Clinton \$8,000 to pay off cocaine debts in 1984, after Roger said cocaine dealers were "putting the heat on him and something might happen to his brother [Bill] and his mother." And Lasater informed investigators he had once given Roger a job in his stables.

Roger Clinton was arrested in Hot Springs in 1984 on five counts of distributing cocaine and one count of conspiracy to distribute. After pleading guilty, he served just over a year in a federal prison before heading out to Hollywood for a job with TV producers who are political contributors to Slick Willie.

That's not the end of the story of Bill Clinton and drugs. This past January, another wealthy Clinton supporter was found dead of a cocaine overdose in a New York hotel.

# Iran/Contra Skeletons Falling Out of Bill Clinton's Closet

by Jeffrey Steinberg.

4/92

March 16 (EIRNS)—Governor Bill Clinton gives new meaning to the term "Bush League Democrat"—and, by the way, yes, there's another scandal in the Clinton campaign, and this time over policy, not pecadilloes. The Arkansas Governor and apparent Democratic frontrunner is Bush League, not just because he was a backer of President Bush's Persian Gulf war. The deeper scandal of the Bush/Clinton parallelism is that, during the Reagan years, when then-Vice President Bush was running the Nicaraguan Contra program, Clinton actively supported a string of secret training camps and airstrips in western Arkansas that have been identified by eyewitnesses as hubs of Ollie North's gun-for-drug trafficking "resupply" program in the Iran/Contra mess.

According to court records, eyewitness reports, and press accounts, Ollie North personally held a series of meetings in Little Rock, the Arkansas capital, in the early 1980s to set up the secret, illegal Contra weapons pipeline. One of the key players in that secret program was a former TWA pilot named Barry Seal, who worked for years for the Colombian drug cartels shuttling cocaine into the United States—until he was busted by federal authorities and went to work for North to avoid jail.

#### Moving to Arkansas

After Seal was busted by the Drug Enforcement Administration in Louisiana, he was reportedly told to relocate his lucrative smuggling operations to Arkansas. Other participants in the Contra resupply program were similarly "invited" to relocate to Little Rock during the same period.

Seal's new operation was based

by the mid-1980s at Intermountain Regional Airport in Mena, Ark. Seal owned a small fleet of planes that reportedly ran weapons into the Contras in Central America and brought shipments of cocaine into the United States. In 1984, Seal gained notoriety when one of his drug planes, outfitted with special secret cameras provided by the CIA, filmed senior officials of the Sandinista regime overseeing the loading of cocaine at a Nicaraguan military airport.

#### Clinton Gets Involved

Another player in the Arkansas network was Terry Reed, a former combat pilot in Laos who moved to Little Rock in the autumn of 1983 (reportedly at North's request) and set up a training base for Contra guerillas in Nella, Ark., 11 miles north of Mena.

According to Reed's testimony at his own 1989 trial on wire fraud charges, at least one of the early meetings at which the Nella training camp was planned, and at which a number of Contra-related front companies were established, was attended by Roger Clinton, the brother of Gov. Bill Clinton. Other "business" meetings were, according to Reed, attended by Don Lassiter, a close friend and backer of Gov. Clinton; Lassiter received a large portion of the state's bonding business throughout Clinton's governorship.

Although no other witnesses have stepped forward to confirm Reed's identification of Clinton and Lassiter as participants in the Contra secret supply program, it certainly is the case that Gov. Clinton's closest aide played a pivotal role in efforts to silence Reed.

Terry Reed is one man who can apparently speak with authority about Gov. Bill Clinton's role in the Reagan-Bush Contra hasco.

Data on the Mena airport, Bill Clinton and drug trafficking, as well as the fact that it is happening with the knowledge of Clinton and Bush, was publicized on NBC TV "A Current Affair", 4/21/92.



# Assassinations in Europe Signal Terror Offensive

MARCH 28, 1992

by Jeffrey Steinberg

March 16 (EIRNS)—Four days ago, a prominent Sicilian politician, Salvo Lima, was assassinated in an ambush as he drove his car near Palermo, Sicily. Although Italian authorities blamed the murder on the Mafia, the death of the European Parliament member, who was also a leader of the Christian Democratic faction of Prime Minister Giulio Andreotti, triggered a security alert in Rome, where several senior politicians were placed under round-the-clock security.

Lima's was the most significant political assassination in Italy in years, and occurred against the backdrop of an intensive political battle for control over the government between the Andreotti faction, closely linked to the Vatican, and a rival group headed by President of the Republic Francesco Cossiga.

Interestingly, Cossiga has come under intensive attack recently in the Italian press for his role in covering up the 1978 kidnaping and assassination of former Prime Minister Aldo Moro. Cossiga was the Interior Minister at the time of the Red Brigade murder of Moro. The Moro assassination has been publicly laid at the doorstep of Henry Kissinger, who had opposed Moro's efforts to forge a stable coalition government in Italy which could pursue a foreign policy, particularly toward the Middle East, free of U.S. control.

## A Hit in Turkey

Less than a week before the ambush execution of Lima, the chief of security of the Israeli embassy in Ankara, Turkey was killed by a powerful car bomb. His murder March 6 was claimed by a little-known group called the Islamic Revenge Organization. In a phone call to an Ankara newspaper, the group said it killed Ehud Sadan "to

avenge the killing in Lebanon of Sheik Abbas Musawi," the head of the Hezbollah. Sheik Musawi and several members of his family had been killed Feb. 16 when an Israeli helicopter fired on his car in southern Lebanon.

Arab sources say that the Sadan murder was probably carried out by terrorists deployed by the Iranian government. It is feared that the killing of the Israeli government official will trigger some dramatic Israeli countermove, in much the same way that the 1982 attempted murder of Israeli ambassador Shlomo Argov in London led to the Israeli invasion of Lebanon.

Although there is no direct link between the Lima and Sadan incidents, they both underscore the growing threat of terrorism, as the old Versailles System collapses and long-simmering political conflicts boil over.

European security specialists point to the recent reactivation of the Irish Republican Army (IRA) and Basque separatists (ETA) as further evidence that a new period of low-intensity conflict is beginning in Eurasia. The concern is heightened by recent reports of secret meetings between senior officials of British and Israeli intelligence to discuss "greater cooperation" between the two services. Shortly after those reported meetings, the Israelis assassinated Sheik Musawi.

Both British and Israeli intelligence have been accused of secretly controlling such terrorist groups as the Red Brigades, the IRA, and Black September, and deploying them to eliminate political opponents and destabilize rival states. In one recent book by British writer Patrick Seale, extensive evidence was published linking the Israeli Mossad to the notorious Arab terrorist Abu Nidal.

# Stop Virginia Death Act— It's an Openly Nazi Law!

## CLUB OF LIFE

by Linda Everett

4/92

Unless an opposition outcry stops Gov. Doug Wilder from signing Virginia's new Health Care Decisions Act, the state of Virginia will soon have the most advanced Nazi euthanasia law in the nation. More ominous, with the stroke of Wilder's pen, a new era of state legislation will have begun, one which mirrors Hitler's 1939 euthanasia decree, permitting doctors to kill patients "considered incurable according to the best available human judgment"—in Hitler's words. Under Virginia law, the extermination of severely handicapped wards of the state will be carried out by the very doctors, guardians, and committees charged with protecting them.

The Virginia legislature passed the Health Care Decisions Act despite the outrage and lobbying against it. A Richmond Times lead editorial attacked the bill as "involuntary euthanasia."

### You Have No Right To Live

The bill would amend Virginia's existing Natural Death Act—which already allows patients to sign directives indicating what medical treatment they want, should they become incompetent. It also allows a patient to appoint an agent to carry out his wishes. Such documents are dangerous for many reasons, not the least of which is that people think if they choose not to sign such directives, it will be assumed they want life-saving treatment. This bill explicitly rules out that assumption. Nor does the signing of a directive for life-saving treatment and basic feeding guarantee

you'll receive it.

Typically, once patients are diagnosed as "terminally ill" or in a "persistent vegetative state," their instructions to withdraw or withhold treatment are activated. But, no matter how much a patient or family wants life-saving or life-sustaining treatment or food and water, the bill allows doctors to deny it if they feel it "medically or ethically inappropriate." Medical ethics are transformed from saving human life to denying care in order to cut costs.

### Killing the Vulnerable

The bill specifically targets for extermination tens of thousands of patients in psychiatric or mental retardation facilities and nursing homes who are incapable of making their wishes known and who, the bill says, have no "reasonable expectation of recovery." This definition could encompass just about everybody on the planet—from those with head trauma to the elderly disoriented.

Unconscious or unresponsive patients who can live for years, are termed PVS ("persistent vegetative state") and considered terminally ill by the bill. Severely handicapped patients who laugh at jokes, respond to commands, or use devices to signal what they want, are often diagnosed as "permanently unconscious" or "hopeless"—yet they do recover if given prompt rehabilitation. This bill would kill them, to save the costs of rehabilitation or maintenance.

Government leaders, intent on propping up their immoral economic policies, will use the same tactics Hitler did to eliminate any patient too vulnerable to fight back, unless we stop them. Call Gov. Wilder now: (804) 786-2211; FAX: (804) 786-3985.

## M A T R I X I I I

### The Plan of the Olympians (The Committee of 300) According to Some Sources

1. A One World Government and New World Order with a Unified Church and monetary system under their direction.
2. Destruction of all national identity and pride.
3. Destruction of all religions except that which they deem proper.
4. Mind control of every individual through what Brzezinski calls "technotronics", creating human-like robots and a system of terror.
5. An end to industrialization and production of nuclear power.
6. Legalization of all drugs and pornography.
7. Depopulation of all large cities into camp systems in the countryside.
8. Suppression of all scientific development not deemed useful.
9. Destruction of a significant amount of human population by limited wars, bacteriological warfare, chemical warfare, and electronic warfare. Three billion people must die by 2000. The Global 2000 Report produced by Cyrus Vance detailed this, and was accepted by Carter on behalf of the U.S. Government. The U.S. Population must be reduced by 100 million by 2050.
10. To weaken the moral fiber of the nation and demoralize workers in the labor class by creating mass unemployment. Demoralized youth and workers will resort to alcohol and drugs. The youth will be encouraged to rebel, thus ensuring the destruction of the family unit.
11. To keep people from deciding their own destinies by means of one created crisis after another, then "managing" such crises. This will confuse and demoralize the population to the extent where massive apathy will result. FEMA is designed for the crisis management. States of apathy will be similarly induced through chemical means, such as inducements to consume fluorides and other harmful substances in the food and water, producing death and illness and insuring a continuing flow of capital into the medical establishment.

### M A T R I X I I I

12. To introduce new cults and continue to boost those already functioning, which include various types of degenerative music.
13. To continue to build up the cult of Christian Fundamentalism begun by the British East India Company, which will be used to strengthen the Zionist State of Israel through identifying with the Jews through the myth of "Gods Chosen People" and by donation of substantial amounts of money to what they believe is a religious cause in the furtherance of Christianity.
14. To press for the spread of religious cults.
15. To export "religious liberation" ideas.
16. To cause a total collapse of the world economies and engender total political chaos.
17. To take control of all foreign and domestic policies of the United States.
18. To give full support to the supranational institutions such as the UN, IMF, BIS, World Court and cause the fading out of local institutions.
19. Penetrate and subvert all governments, and work from within them to destroy the sovereign integrity of nations represented by them.
20. Organize a world-wide terrorist apparatus and negotiate with terrorists whenever terrorist activities take place:
21. Take control of education in the United States with the intent and purpose of destroying it.

M A T R I X I I I

Noahide Laws: Contributing to a New World Religion?

On March 20, 1991, President Bush signed Public Law 102-14, Education Day U.S.A, into law. Also known as House Resolution 104, the Proclamation reads:

"Whereas Congress recognizes the historical tradition of ethical values and principles which are the basis of civilized society and upon which our great Nation was founded;

Whereas these ethical principles have been the bed-rock of society from the dawn of civilization when they were referred to as the Seven Noahide Laws;

Whereas without those ethical values and principles the edifice of civilization stands in serious peril of returning to chaos;

Whereas society is profoundly concerned with the recent weakening of these principles that has resulted in crises that beleaguer and threaten the fabric of civilized society;

Whereas the Lubavitch movement has fostered and promoted these ethical values and principles throughout the world;

Whereas Rabbi Menachem Mendel Schneerson, leader of the Lubavitch movement, is universally respected and revered and his eighty-ninth birthday falls on March 26, 1991;

Whereas in tribute to this great spiritual leader, "the rebbe", this his ninetieth year will be seen as one of "education and giving", the year in which we turn education and charity to return the world to the moral and ethical values contained in the Seven Noahide Laws; and

Whereas this will be reflected in an international scroll of honor signed by the President of the United States and other heads of state; Now, therefore, be it

Resolved by the Senate and the House of Representatives of the United States of America in Congress assembled, That March 26, 1991, the start of the ninetieth year of Rabbi Menachem Schneerson, leader of the worldwide Lubavitch movement, is designated as "EDUCATION DAY U.S.A." The President is requested to issue a proclamation calling upon the people of the United States to observe such day with appropriate ceremonies and activities."

### M A T R I X I I I

In sociological terms, what does all this mean? The bill was passed in the House by a voice vote on March 5, 1991 and was passed by the Senate on March 7, 1991. What are these Noahide laws that are referred to in the document? Research indicates that the Laws, in condensed form, are:

- (1) Thou shalt not engage in idol worship.
- (2) Thou shalt not blaspheme God.
- (3) Thou shalt not shed innocent blood of and human or fetus nor ailing person who has a limited time to live.
- (4) Thou shalt not engage in bestial, incestuous, adulterous, or homosexual relations nor commit the act of rape.
- (5) Thou shalt not steal.
- (6) Thou shalt establish laws and courts of law to administer these laws, including the death penalty for those who kill, administered only if there is one testifying witness.
- (7) Thou shalt not be cruel to animals.

From a sociological perspective and from a perspective steeped in a religious reality-tunnel, these "laws" may sound honorable, but these laws are considered by rabbinic tradition as the minimal moral duties enjoined by the Bible on all men, except Jews. Even though the Bible is mentioned, the Judaica cites the Talmud, not the Christian Bible, as the source.

So, the Noahide laws apply only to non-Jews living under Jewish jurisdiction. Interestingly, Websters dictionary, New International Edition 2nd Ed 1950, states that a Noachite is "one who has taken the 21st degree of the Scottish rite (Freemasonry)". The doctrine of Freemasonry, applied in a sociological format, consists of a "disbelief in the Divinity of Christ, and a determination to replace that doctrine by Naturalism or Rationalism."

Like anything else, it is all open to interpretation. To the Jew, idol worship might be any Christian who displays a crucifix or cross (these are forbidden items in Israel today). Sentence under the Noahide law: decapitation.

Since the second "law" prohibits blaspheme and Jews do not believe as Christians do (that Jesus Christ was God), Christians adhering to this Biblical "fact" will be tried for blaspheme. Sentence: de-capitation.

### M A T R I X I I I

In fact, the sentence for breaking any of the Noahide Laws is decapitation. In discussing this curious sociological development, I was reminded of the stories that have been going around for the past three or four years about shipments of guillotines into the United States. A connection?

Despite the fact that "constitutional principles" prohibit the making of a law that respects an establishment of religion, it would appear that the government is determined to do so anyway. Even the earmarking of money for the support of Israel, a self-proclaimed Theocratic state, is considered by some to be illegal under the "constitution."

Dr. Ernest Easterly III, Professor of International Law and Director of the Institute for Comparative Legal Studies, Southern University Law Center, says, "With further recognition by other nations and international courts, the Seven Noahide Laws should become the cornerstone of a truly 'civilized' international legal order."

Personally, I am neutral relative to all this, because I know who I am and don't need to project part of my psyche "out there" in a religious sense, but for the majority of human beings on the planet who, in cultural religious terms, are not Jewish, this development could be the basis for a 'death sentence'.

Who is this Rabbi Schneerson? On the following page is reproduced an article about him.

# Expecting the Messiah

**An ultra-Orthodox sect says the Redeemer is due to arrive any day now—and he might be an American**

By LISA BEYER KFAR HABAD

Israeli Jews like to tell an old fable of a Russian Jew who goes to his rabbi in search of a job. The rabbi instructs the man to stand at the village gate each morning and wait there to greet the Messiah when he comes. For this, the rabbi offers the man a ruble a month. "The pay is so low," the man complains. "Yes," says the rabbi, "but the job security is excellent."

That mythological gatekeeper would be scanning the want ads today, according to a group of ultra-Orthodox Jews. Israeli members of the large and powerful Hasidic movement Habad are convinced that at any moment, the Redeemer will arrive in Jerusalem. In a burst of fervor, they have erected yellow billboards across Israel, instructing passers-by TO PREPARE FOR THE COMING OF THE MESSIAH. Bumper stickers carry the same message, as do electrified signs atop Habad cars. A full-page ad announcing "The Time for Your Redemption Has Arrived" has run in the *New York Times*, and Habad speakers have been crisscrossing the U.S. to deliver their message. And who might the Messiah be? Easy, say Israel's Habadniks: their leader, Rabbi Menachem Mendel Schneerson, 89, of Brooklyn, N.Y.

Utter blasphemy is what many other religious Jews say. Critics of Habad, which is also known as the Lubavitch movement, after the Belarussian village of its founding, are both angry and worried. Eliezer Schach, one of Israel's leading ultra-Orthodox rabbis, has publicly called Schneerson "insane," an "infidel" and "a false Messiah." The local papers carried Schach's outrageous charge that Schneerson's followers are "eaters of *trayf*," food such as pork that is forbidden to Jews. Other detractors fret that Habad's Messianic passions will provoke a schism in Judaism or lead to mass disillusionment, driving believers from the fold. Says philosopher Rabbi David Hartman: "The outpouring of Messianic fervor is always a very disturbing development."

Within Habad, a well-financed organization with 30,000 followers in Brooklyn and at least 100,000 worldwide, the expect-

ation of the Messiah's coming has been building since Schneerson in the past few years began exhorting his disciples more and more to actively prepare for the day. The crumbling of the Iron Curtain and the Soviet Union's demise, explains Habad spokesman Rabbi Yehuda Krinsky, "lead one to think that these extraordinary,



Rabbi Schneerson: the holy man from Brooklyn

shattering events are a precursor to something even more cataclysmic."

Anticipation sharpened after the gulf war, whose impact on Israel Schneerson supposedly predicted. Before the fighting began, the Lubavitcher rebe, or spiritual leader, declared that Israel would be the "safest place in the world." Actually, 74 Israelis died, all but six of them from heart problems caused by the terror of 39 Iraqi Scud-missile attacks. Still, the loss of so few lives seemed to many Lubavitchers the result of divine Providence.

Last month the rebe gave permission to one of his flock to begin building a house for him in Kfar Habad, the movement's village in Israel. Schneerson has

never set foot in the Jewish state, and his followers believe he will do so only at the moment of Redemption. The ground breaking was seen as a sign that the time is near. "The Messiah will come any day," declared Moshe Kruger, standing on the plot for Schneerson's house.

It is not an official tenet of Habad's belief that Schneerson is the Messiah, but many of his followers say outright that he is, and some have petitioned him to "reveal" himself. The rebe has on a few occasions denied that he is the Redeemer but has done little to discourage speculation. Two weeks ago, Schneerson received a vote of confidence from renowned Talmudic scholar Rabbi Adin Steinsaltz. Though a Lubavitcher himself, Steinsaltz has a reputation for sober erudition, so it caused a small stir among the non-Habad Orthodox when he said Schneerson was "the most likely person on the scene now" to become the Messiah.

Steinsaltz, who points out that Messianic expectation is a fundamental tenet of the Jewish faith, believes that each generation produces a candidate and that ordinary people can speed his coming by creating an atmosphere for Redemption. Other scholars reject Habad's active campaigning for the event. Followers of Rabbi Schach, a longtime rival of Schneerson's, believe the arrival of the Messiah is God's business, not man's. "When he comes, he comes," says Avraham Ravitz, a member of the Knesset. "It's crazy to force the Messiah to come by selling him like Coca-Cola, with jingles and stickers and billboards."

Habad's critics also say the group may be creating the conditions for large-scale spiritual disillusionment. "If you convince people that the Messiah is coming and he doesn't," says Amnon Levy, author of a book on the ultra-Orthodox, "a whole generation may lose its faith."

Concern that Schneerson might disappoint his devotees was heightened earlier this month when the rebe suffered a mild stroke. But even the leader's death would not disprove his Messianic potential, argues Steinsaltz, who believes the Redeemer will be mortal, someone who will eventually die and have successors. In the meantime, the rebe's adherents are praying he will recover in time to bring a happy denouement to the drama they have been so eagerly anticipating. —With reporting by Hannah Bloch/Brooklyn



## M A T R I X I I I

### CHRONOLOGY OF SIGNIFICANT EVENTS (Match this with the Chronologies in MATRIX II!)

- 1511 - King Henry the 8th signs an act making it an offense to practice medicine without "approval"
- 1518 - Royal College of Physicians founded.
- 1617 - Society of Apothecaries formed in England.
- 1683 - England imports Opium from Begal in British East India Company (BEIC) "Tea Clippers"
- 1685 - England markets Opium in China, creating addicts.
- 1694 - Bank of England formed to enable Amsterdam bankers to gain control of British wealth.
- 1729 - China rebels and passes anti-Opium smoking laws.
- 1731 - Chinese gov't destroys British Opium Warehouses. which eventually lead to "The Opium Wars" w/ Britain.
- 1812 - British sack and burn Washington, destroying documents that would have exposed the treason against the U.S. and subsequent events.
- 1814 - Two years after the War of 1812, Britain begins to re-assert its control over the United States.
- 1821 - United States begins participation in Opium Trade.
- 1832 - British Medical Association chartered.
- 1833 - Russell and Company, a shipping firm in the Opium trade, is granted a monopoly in the slave trade by the Committee of 300.
- 1846 - Britain sends 120,000 addicted Chinese "coolies" to the U.S., carrying Opium, to build railroads.
- 1847 - The American Medical Association is formed to gain control over medical doctors in the U.S. and stifle competition from homeopathic medicine, while gaining a total monopoly of allopathic medicine in the U.S.
- 1861 - Congress is induced to pass a 3% income tax , which is expanded to a graduated tax within a year.
- 1862 - Lincoln issues the GREENBACK, not backed by GOLD but was debt free.
- 1863 - Congress passes the National Banking Act, creating

## M A T R I X I I I

a federally chartered bank with the power to issue U.S. Bank Notes to be loaned to the Government that is not supported by GOLD but by DEBT.

- 1869 - J.P. Morgan goes to London to get an agreement to form Northern Securities as a Rothschild agent in the U.S.
- 1873 - Engineered U.S. "bank panic"
- 1875 - Chinese Opium Supply Ring in U.S. West Coast complete.
- 1876 - F.S. Turner publishes his book "British Opium Policy" showing how the British monarchy and its relatives were involved in the Opium trade.
- 1879 - Rockefeller is in control of 95% of American oil refineries through Standard Oil.
- 1893 - Engineered U.S. "bank panic"
- 1893 - Johns Hopkins Medical School established as headquarters of German allopathic medicine in the U.S.
- 1896 - Opium trade publically deemed "illegal"
- 1898 - Queen Victoria begins the Boer War in South Africa to gain control over mineral wealth.
- 1900 - Cancer responsible for 4% of deaths in the U.S.
- 1902 - Boer War ends.
- 1903 - Meeting at St. Ermins Hotel in London where members of British Royalty decide the fate of the planet.
- 1903 - Rockefeller Institute of Medical Research formed with the object of dominating the entire medical system in the United States.
- 1904 - Carnegie Institution establishes biological experiment station at Cold Spring Harbor, New York.
- 1905 - The Food and Drug Act passed, which set up gov't control of interstate commerce in drugs.
- 1907 - Engineered U.S. "bank panic"
- 1907 - The AMA "requests" the Carnegie Foundation to conduct a survey of all the medical schools, headed by Abe Flexner, which was completed in 1910.
- 1909 - Harriman Research Institute formed.

## M A T R I X I I I

- 1913 - Wilson signs the Federal Reserve Bill, creating a private corporation, chartered in the state of Maryland, and owned by British Insurance companies and the Bank of England, to loan debit-based currency to the United States Government in order to undermine it financially in an ever-increasing spiral of debt.
- 1913 - Britain passes the Official Secrets Act to assist in the coverup of its drug dealing empire.
- 1913 - Rockefeller Foundation charter established.
- 1914 - Eugenics taught at Harvard, Columbia Universities. First Congress on Race Betterment in Michigan.
- 1918 - The Great Flu Epidemic starts at a military base in Kansas and spreads worldwide, killing millions.
- 1919 - British Crown establishes The Royal Institute of International Affairs to control world politics and the world drug market. (RIIA)
- 1920 - Plans for One World Church begin when World Council for Churches is set up in London.
- 1920 - I.G. Farben signs working agreements with the drug firms in Switzerland, Sandoz and Ciba-Geigy.
- 1921 - The RIIA establishes the Tavistock Institute of Human Relations in the U.S. to control and eventually destroy the society of the United States. Tavistock eventually provides programs that led to the establishment of the Office of Naval Intelligence (ONI), the largest intelligence service in the United States.
- 1921 - Council on Foreign Relations established.
- 1923 - Voices begin to be raised in the U.S, about importing Opium. A bill is introduced which calls for the British to account for their Opium export business on a country-by-country basis. The British respond by increasing exports to the United States.
- 1925 - Adolph Hitler publishes "Mein Kampf"
- 1928 - Edward Bernays writes "Propaganda" about the control over society.
- 1930 - The British invest over One Trillion pounds in the Drug-producing countries in South America. Britain develops a stranglehold on world gold and diamond supplies.

### M A T R I X I I I

- 1930 - Standard Oil announced it had purchased an alcohol monopoly in Germany, set up by I.G. Farben, who was the source for the Gestapo intelligence network.
- 1931 - The managing directors of the "big five" British Companies made Peers of the Realm for their activities in drug money laundering. Current British banks that are engaged in drug money laundering are the British Bank of the Middle East, Midland Bank, National and Westminster Bank, Barclays Bank, Royal Bank of Canada, Hong Kong and Shanghai Bank, Baring Brothers Bank, and Hambro's Bank.
- 1931 - During the annual polio epidemic, Roosevelt endorses a so-called "immune serum", a precursor of the polio vaccines of the 1950's.
- 1932 - Third International Congress on Eugenics, New York.
- 1932 - Coudenhove-Kalergi writes "Revolution Through Technology", a blueprint for the return of the world to medieval society, which becomes a working paper for the Committee of 300's plan to deindustrialize the planet, starting with the United States, claiming that "over-population" is a problem.
- 1932 - Prince Bernhard of the Netherlands joins the S.S. and then the board of an I.G. subsidiary, Farben Bilder, from which he took the name of the Bilderbergers.
- 1933 - I.G. Farben gives 4.5 million RM to Nazi Party. I.G. Farben is a Rothschild concern,
- 1933 - Adolph Hitler comes to power in Germany.
- 1936 - Goerings Four-Year industrial plan is launched.
- 1936 - Lobotomy introduced into the United States.
- 1936 - Avery Rockefeller sets up Schroder-Rockefeller Company, which combined the operations of Schroder, Hitlers personal bank, and the Rockefeller interests.
- 1938 - Roosevelt and Churchill make agreements to share intelligence data.
- 1938 - Standard Oil loans I.G. Farben in Germany 500 tons of tetra-ethyl lead gasoline additive.
- 1939 - Frank Howard of Standard Oil visits Germany to set up final plans for oil exports to Germany for the second World War.

### M A T R I X I I I

- 1939 - Control of the U.S. State Department passes to the Council on Foreign Relations.
- 1939 - Standard Oil loans I.G. Farben \$20 million worth of aviation gasoline.
- 1939 - ITT and GE own significant stock in German industrial companies, none of which are bombed during the war.
- 1939 - Germany invades Poland
- 1940 - Office of Opinion Research established at Princeton.
- 1940 - Lord Beaverbrook comes to the United States and orders Roosevelt to get involved in Britain's war with Germany
- 1941 - I.G. Farben produces Zyklon B gas for use in the German concentration camps.
- 1941 - Dies Committee came into possession of map which showed Japanese intention to attack Pearl Harbor. (Jan 1941)
- 1941 - Japan attacks Pearl Harbor. (Dec 1941)
- 1945 - United States delivers nuclear devices over Japan.
- 1945 - United Nations chartered.
- 1945 - It was decided to put leftover WWII nitrates into the food chain, as fertilizer.
- 1946 - Truman appoints Oscar Ewing head of the Federal Security Agency to pursue the national campaign to lace the water in the U.S. with fluorides. Ewing had been a lawyer for ALCOA aluminum, which produces by-products of sodium fluoride, a hazardous waste.
- 1946 - Tavistock Institute founds Stanford Research Center. Stanford eventually develops into an institution that employs 4,000 people and has an annual budget of over \$160 million. SRI eventually creates the Center For Study of Social Policies, importing top staffers from London, including former British intelligence agent David Sarnoff, who becomes chairman of RCA. Today, SRI is one of the largest military think tanks. Among their specialty departments are chemical and biological warfare experimental centers. New World Order machinery is basically in place at this time. Massive psychological warfare against the United States begins.
- 1946 - The Club of Rome is ordered by the Committee of 300, also referred to as the "OLYMPIANS", to further the progress of think tanks aligned with their philosophy.

## M A T R I X I I I

- 1946 - David Rockefeller's Foreign Aid Bill becomes law, insuring the growth of the "foreign aid" racket.
- 1947 - United States passes the National Security Act.
- 1947 - Drug-based mind control projects begin at Bethesda.
- 1947 - NATO orders Sussex University to establish a special brainwashing center, which becomes part of Britain's Psychological Warfare Bureau, and to direct its research towards civilian populations. It becomes the Science Policy Research Institute (SPRI).
- 1948 - Research Analysis Corporation (RAC) established.
- 1950 - TB deaths decline to 50 per 100,000.
- 1951 - RCA generates major television companies ABC, NBC and CBS, dominated by British Intelligence.
- 1952 - Project Moonstruck, headed by the CIA, begins, using electronic implants to control subjects.
- 1952 - Henry Kissinger is sent to the Tavistock Institute, and is later appointed to the Council on Foreign Relations.
- 1953 - Zero-growth industrial policies begun by C-300. The Club of Rome takes over the Hoover Institution, which becomes a One World Order outlet for "desirable" policies.
- 1953 - Project MK-Ultra conducted by the CIA.
- 1954 - First meeting of the Bilderberger Group held, chaired by Prince Bernhard.
- 1955 - American Cancer Society takes over all research from the National Research Council and creates a Science Advisory Council to represent hospitals and schools.
- 1957 - Bilderberger meeting. Kissinger directed to fill all positions in Nixon government with Committee members.
- 1957 - Association for Human Psychology founded by Maslow as a Club of Rome project.
- 1958 - Project Orion conducted by the USAF.
- 1958 - Advanced Research Projects Agenca approaches SRI with Top Secret proposal. put forward by John Foster at the Pentagon, to insure the U.S. against technological surprise. Project SHAKY was instituted to perfect a

condition where the environment could become a weapon, using special methods to trigger earthquakes and volcanos, bahavioral research on potential enemies, and focus in minerals and metals with potential for new weapons. SRI works with civilian consulting firms to apply military technology to domestic situations. A civilian consulting firm was assembled by Schriever McKee Associates of McLean, Virginia, run by retired General Bernard A. Schriever, called URBAN SYSTEMS ASSOCIATES, a consortium of Lockheed, Emerson Electric, Northrop, Control Data, Raytheon, and TRW assembled to "solve social and psychological 'urban problems' by means of military techniques using ADVANCED ELECTRONIC SYSTEMS".

1960- The CIA begins Project MK Delta.

1961 - Heroin coming from Hong Kong, Lebanon, and Dubai engulf the U.S. and Western Europe. Research Analysis Corporation becomes part of the Johns Hopkins bloc and is taken over by the Committee of 300. It has over 600 projects, which include psychological warfare and mass population control.

1961 - Program begins at University of Chicago and Argonne National Laboratories where 102 subjects are fed radioactive fallout from the Nevada Test site. The project, which lasted until 1963, measured the internal effects of fallout.

1962 - Bilderberger meeting held in Sweden.

1963 - Inmates at Orgon State Prison and Washington State Prison are exposed to testicular x-rays to determine effects on human fertility. Program ended in 1971.

1966 - Bilderberger meeting.

1966 - "Gang Wars" in the U.S. end when media withdraws the coverage. Tavistock ready to launch a major non-reversible cultural revolution in the U.S.

1968 - The Club of Rome is established.

1969 - The Committee of 300 takes over the Human Resources Research Office, an Army research establishment that deals in "psychotechnology". Most of its personnel are trained at Tavistock. It is the largest behavioral research group in the United States.

### M A T R I X I I I

- 1971 - The Mitchell Energy and Development Corporation holds its energy strategy meeting for the Club of Rome with the recurring theme of limiting the growth of the U.S.
- 1972 - Drug-based mind control project ends at Bethesda and goes operational.
- 1972 - Rockefeller and others go to Japan and talk with bankers about the idea of creating a Trilateral Commission, which was then founded the same year.
- 1972 - World Health Organization proposes research into an immunosuppressive virus.
- 1973 - Bilderberger meeting held in Sweden.
- 1973 - Committee 300 member Olaf Palme legalizes implant use by authorities in Sweden.
- 1973 - Haig takes over management of the U.S. Government after a coup d'etat.
- 1973 - Brezinski, CFR director, singles out Carter as next President.
- 1974 - Nixon resigns.
- 1976 - The Great American Swine Flu Massacre
- 1976 - Doctors write over 1 billion prescriptions for sleeping pills.
- 1977 - Bank of China dumps 80 tons of drug-related GOLD on the market.
- 1977 - U.S. gives China "most-favored nation" status.
- 1978 - The AIDS virus established in the United States.
- 1978 - Over \$5 billion in Valium made by Hoffman LaRoche is sold in the United States.
- 1979 - Work begins to change the US into a non-representative parliamentary system with Lloyd Cutler, appointed by Carter.
- 1980 - Congress passes the Monetary Control Act, which gave the Federal Reserve control of all depository banks.
- 1980 - Members of the Socialist International meet in the U.S. capitol on December 8th. Etienne D'Avignon, a member of the French Black Nobility, is assigned to the task of collapsing the U.S. steel industry. Another member at the meeting is John Graham, also known as



M A T R I X I I I

"Irwin Suall", head of the fact-finding committee of the Anti-Defamation League (ADL), an operation that is run by British Intelligence, MI6 and JIO. "Suall" is also a member of the SIS, and was recruited while at Oxford University, the school attended by presidential candidate William Clinton, who attended the Bilderberger meeting of 1986. The existence of FEMA is disclosed to the public.

- 1980 - United States Presidential Election. Ronald Reagan.
- 1981 - Stanford Research Institute contracts mostly devoted to futurism in military and civilian applications. The U.S. is by now firmly locked up within the plans of the Club of Rome. Harry Oppenheimer invests \$10 billion in the buying of U.S. Banks. Every major brokerage house on Wall Street has now sold out to the Committee.
- 1982 - The wife of Aldo Moro, the Italian Premiere, testifies in court that Kissenger threatened to eliminate Moro if he did not give up his plans to bring economic and industrial progress to Italy, the country chosen to be a "test case". Moro refuses, and his death clears the way for plans for the Middle East to be carried out in the Gulf War of the 1990's.
- 1982 - Ditchley Group meets in London to discuss suggestions to promote collapse of U.S. Banking system. May 1982.
- 1983 - Bilderberger meeting held in Italy. Edmond Rothschild decided that IMF quota must be raised.
- 1983 - Reagan briefed on Club of Rome policies and does an about-face. January 8, 1983.
- 1983 - On January 10th and 11th, the Ditchely Group meets in Washington, in violation of the Sherman Anti-trust Act and the Clayton Act, and conspire to overthrow the sovereignty of the United States relative to its financial freedom.
- 1983 - Noriega orders all flights to Panama from the Medellin Cartel to be refused permission to land in Panama.
- 1983 - International bankers meet in Williamsburg, Virginia to work out a strategy for preparing the United States for total disintegration of its banking system.
- 1983 - Project Montauk II conducted by USAF to begin loading Earth grids.
- 1984 - Bilderberger member Lord Peter Carrington elected as NATO General Secretary at Innsbruck, Austria. Here it is decided to have George Bush as President.

### M A T R I X I I I

- 1984 - United States Presidential Election. George Bush.
- 1984 - Iran's Opium production exceeds 650 metric tons per year. Acting on instructions from Britain, Carter and Reagan insure there is no interference in the Opium trade.
- 1985 - Senator Jesse Helms sells out to Israel and begins agitation for the removal of Noriega from Panama, where Noriega is making efforts which block drug movement through Panama. Helms is assisted by Simon Hersch, a British intelligence agent working for the New York Times, a newspaper which has been the mouth-piece for British intelligence since the time that MI6 member Sir William Stephenson occupied the RCA building in New York. Helms becomes the darling of the Israeli Sharon faction, the principle gun-runner in Central America and Columbia. George Bush is pressured to extract Noriega and does so, resulting in the death of 7,000 Panamanians and wanton destruction of property; this preserves the Panamanian banks where drug profits are laundered.
- 1987 - "Golden Crescent" (Iran, Pakistan, Lebanon) becomes the largest producer of Opium.
- 1988 - Bilderberger meeting in Innsbruck, Austria.
- 1988 - United States Presidential Election. George Bush.
- 1988 - Washington Post features a story which admits that all cases of polio since 1979 have been caused by the polio vaccine.
- 1989 - Office of Naval Research begins Project Trident, using airborne mind control methods over cities.
- 1990 - Project RF Media begins in Boulder Colorado using mind control subliminals over television carriers.
- 1990 - CIA and Office of Naval Research begin Project Tower, stepping up electronic mind control through cellular telephone networks.
- 1990 - The "100-hour" GULF WAR conducted by George Bush to protect British Petroleum Middle East interests.
- 1990 - The Great Banking S&L scandal, which is connected to BCCI and the CIA, and to drug trafficking.
- 1991 - The Soviet Union "collapses". Despite this, the KGB continue to recruit. Irans heroin addicts number over

M A T R I X I I I

2 million. Mexican military kill Federal Narcotics Police at an airstrip in Mexico's Opium producing area.

- 1991- Collapse of BCCI banking network.
- 1991 - Economic recession begins in the United States.
- 1992 - Assault on "moral values" due to go into high gear.
- 1993 - Final draft for system of parliamentary government due for presentation to the Committee of 300.
- 1995 - United States slated to come out of economic depression as a different society.
- 1997 - Hong Kong becomes China property in lieu of larger cut in Drug Trade.

-----  
Excerpt from  
"The Technotronic Era"  
by Zbigniew Brzezinski

Commissioned by the Club of Rome

The book is an open announcement of the manner and methods to be used to control the United States in the future. It also gave notice of CLONING and ROBOTIDS, i.e., people who acted like people, but were not.

"Our society is now in an information revolution based on amusement focus and spectator spectacles which provide an opiate for an increasingly purposeless mass. At the same time the capacity to assert almost continuous control over every citizen and to maintain up-to-date files, containing even the most personal details about health and personal behavior of every citizen in addition to the more customary data. These files will be subject to instant retrieval by the authorities, and power will gravitate into the hands of those who control information. Our existing institutions will be supplanted by pre-crisis management institutions, the task of which will be to identify social crises in advance and to develop programs to cope with them. This will encourage tendencies through the next several decades toward a technotronic era, a dictatorship, leaving less room for political procedures as we know them. Finally, looking ahead to the end of the century, the possibility of BIOCHEMICAL MIND CONTROL AND GENETIC TINKERING WITH MAN, INCLUDING BEINGS WHICH WILL FUNCTION LIKE MEN AND REASON LIKE THEM AS WELL, could give rise to some difficult questions."

0631-N

M A T R I X I I I

APPROXIMATION OF PLANETARY DRUG MOVEMENT

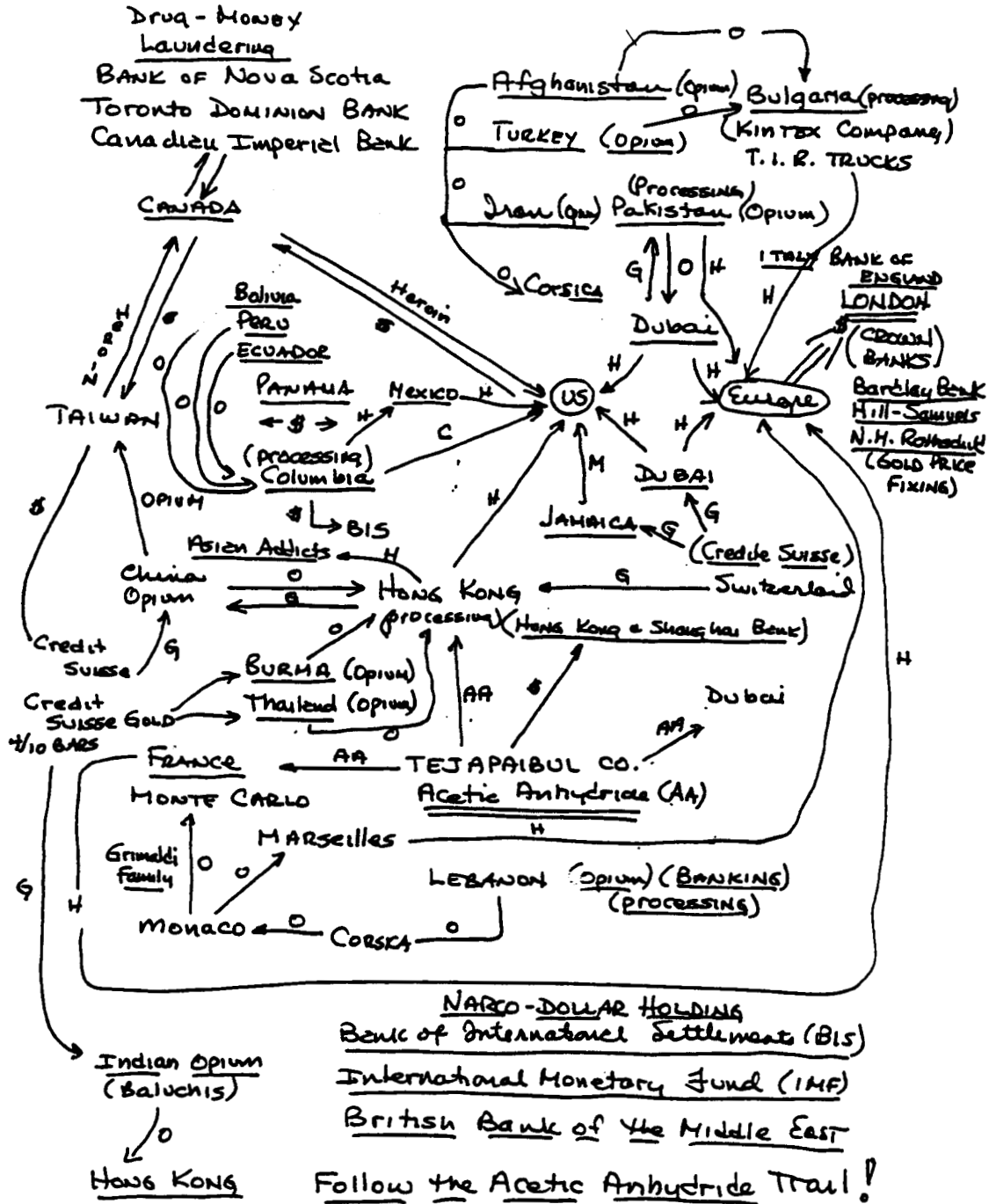

MATRIX III

THE OLYMPIANS/MAGICIANS/DARK FORCES

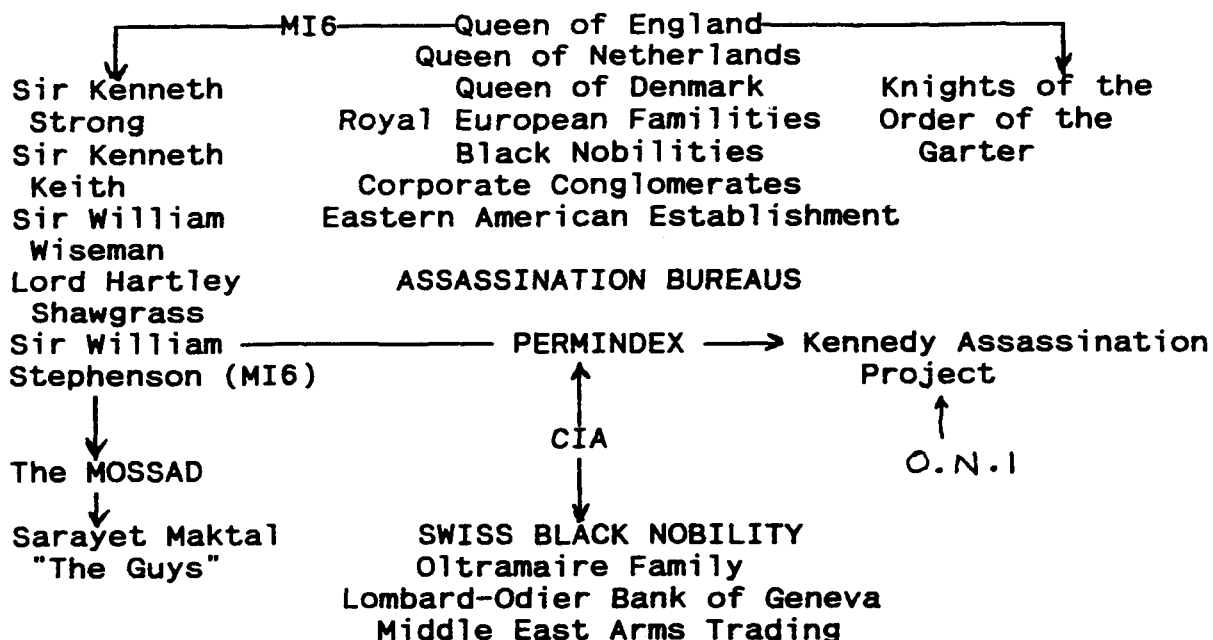

MAJOR INSURANCE COMPANIES

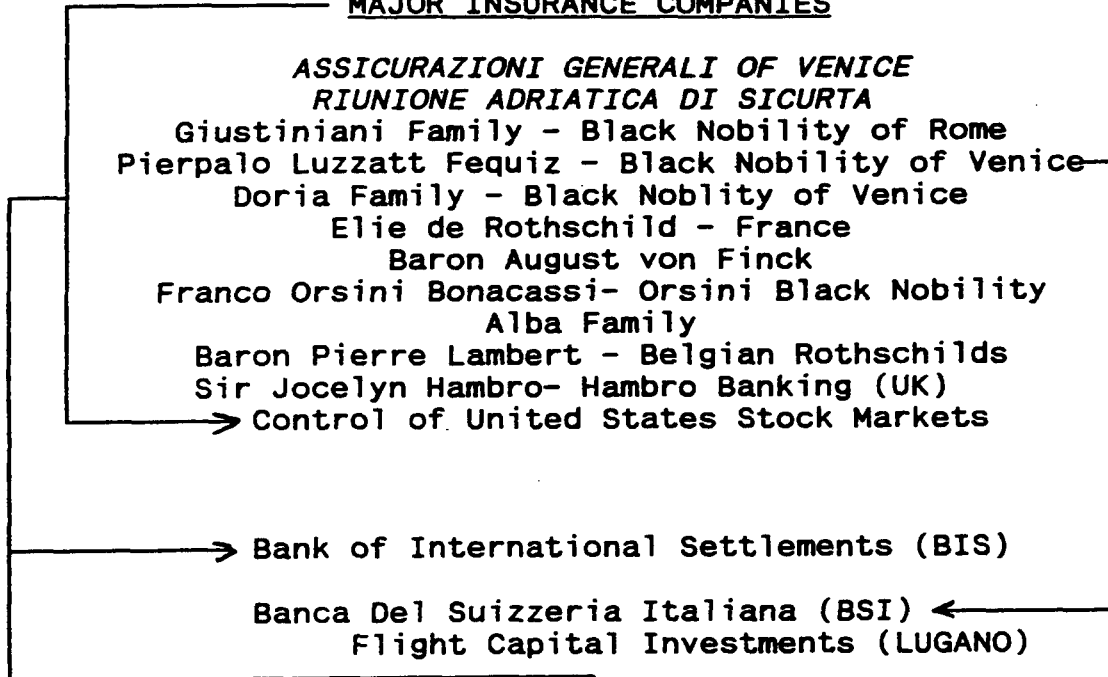

Some Other Drug Money Laundering and Clearing Houses

Hong Kong and Shanghai Bank, Orion Bank, Bank of Ireland  
Bank of England, Banco del Columbia, Banco Mercantil de Mexico  
American Express Bank, Bank of Montreal, Bank of Scotland  
World Bank, Bank of Nova Scotia, Royal Bank of Canada  
International Monetary Fund, Barclays Bank, Banca Privata  
BCCI, British Bank of the Middle East, Netherlands Bank  
Bank of Geneva, Banca Commerciale d'Italia, Standard Bank

M A T R I X I I I

BRITISH

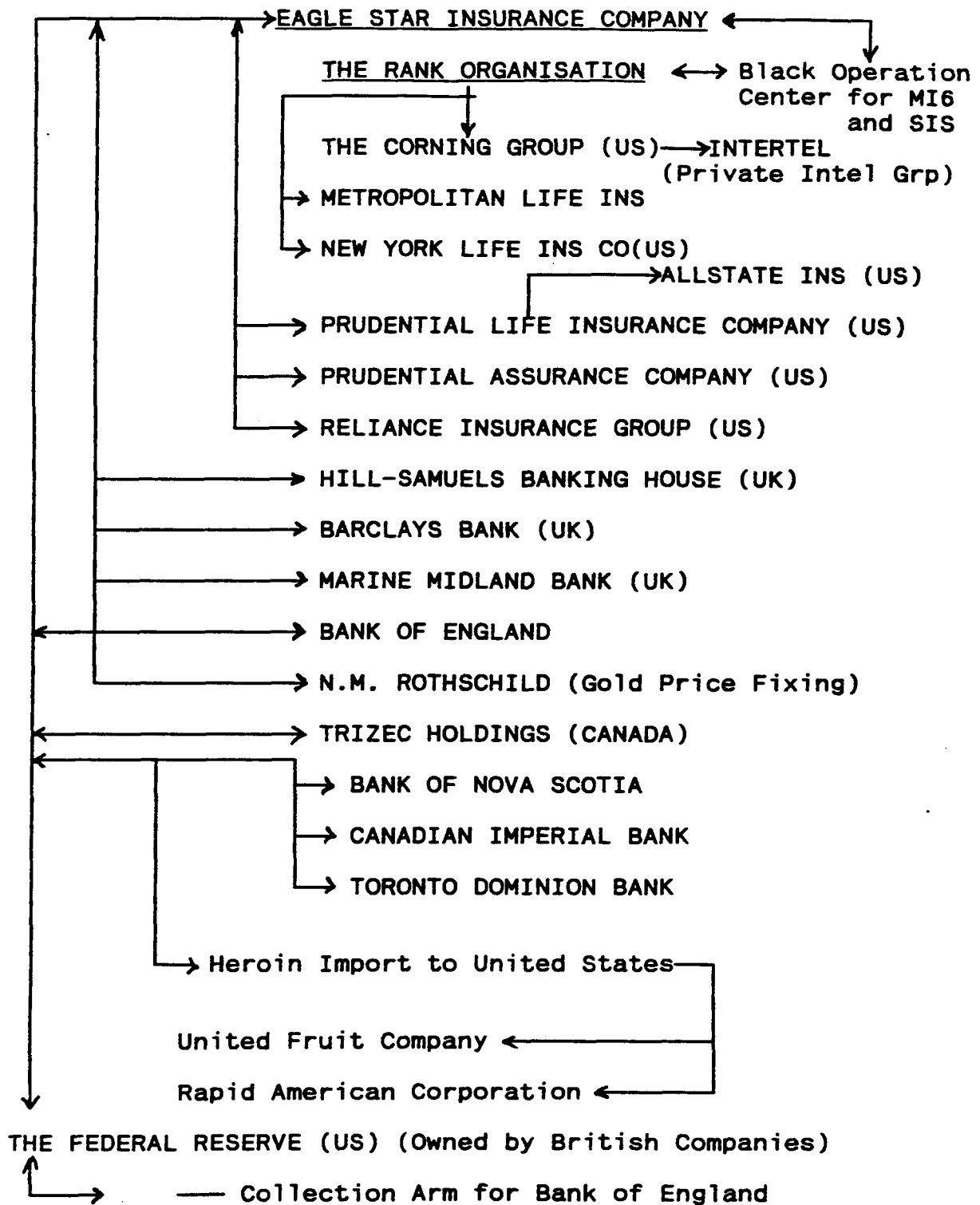

M A T R I X I I I

Committee of 300 Owned Interface Companies and Interests

Xerox Corporation, ITT, NBC, BBC, CBC, CNN, Raytheon, Textron, Atlantic Richfield, British Petroleum, Royal Dutch Shell, Marine Midland Bank, Lehman Brothers, Kuhn-Loeb, General Electric, United Fruit Company, Westinghouse, Lockheed, Northrup, American Medical Association, American Bar Association, American Civil Liberties Union, Alliance Israelite Universelle, Albert Previn Foundation, Africa Fund, Academy for Contemporary Problems, American Council for Race Relations, American Defense Society, American Press Institute, American Protective League, Anti-Defamation League, Arab Bureau, ARCA Foundation, Armour Research Foundation, Arms Control and Foreign Policy Caucus, Aspen Institute, Asian Research Institute, Association for Humanistic Psychology, Augmentation Research Center, Baron De Hirsch Fund, Battelle Memorial Institute, Berger National Foundation, Bilderbergers, Black Order, British Newfoundland Corporation, British Royal Society, Canadian Jewish Congress, Center for Constitutional Rights, Center for Democratic Institutions, Club of Rome, Cini Foundation, De Beers Consolidated Mines, Esalen Institute, Ford Foundation, Hudson Institute, Gulf South Research Institute, Environmental Fund, Environmentics Inc, Fellowship for a Christian Order, Hells Fire Club, Institute for Brain Research, Institute for Pacific Relations, Institute for Policy Studies, Institute for Social Research, Institute for the Future, Institute for World Order, Institute on Drugs Crime and Justice, Knights of Malta, International Institute for Strategic Studies, NAACP, National Council of Churches, National Training Laboratories, MIT, London School of Economics, PERINDEX, NATO, NORML, Odd Fellows, TRIADS, Stanford Research Institute, Tavistock Institute of Human Relations, Rand Corporation, Princeton University, Tempo Corp, U.S. Institute for Peace, World Council of Churches, UNITAR, Union of Concerned Scientists, Transatlantic Council, Bertrand Russell Peace Foundation, Chinese People's Institute of Foreign Affairs, YMCA, Royal Police of Hong Kong, International Red Cross, Hospice Inc, Kissinger Associates, RCA, Jerusalem Foundation of Canada, Canadian Pacific Ltd, International Brotherhood of Teamsters, Organization of American States, English Property Corporation Ltd, Council of South America, Kowloon Chamber of Commerce, British American Canadian Corporation, Asian Research Institute, Arab Bureau, Aristotelian Society, Brotherhood of Eternal Love, Cambridge Apostles, Canadian Histadrut Campaign, China Everbright Holdings Inc, Work in America Institute, Trilateral Commission, U.S. Association of the Club of Rome, Western Training Laboratories, Quality of Life Institute, Theosophist Society, The Public Agenda Foundation, High Twelve International, Wilton Park.

**FOCUS: ON MANUEL NORIEGA**

# What's the cost of victory?

► **ANALYSIS**

■ **Noriega conviction:** Too many deals were cut with criminals to achieve it and Panama drug traffic has doubled since the invasion, critics say.

By David Johnston  
N.Y. Times News Service

**WASHINGTON** — The Bush administration is savoring the drug conviction of Gen. Manuel Antonio Noriega as a final triumph over the deposed dictator. But its own studies show that toppling him failed to stanch the flow of illicit narcotics through Panama.

Further, critics in Congress and elsewhere are saying that the government built its case against the general by making far too many costly deals with murderers, drug traffickers and other criminals in an effort to get them to testify against the defendant.

Friday, President Bush lauded the conviction of the first foreign head of state ever tried on criminal charges in a U.S. court.

He said at a news conference that the U.S. invasion of Panama



The Associated Press

**LEAVING:** U.S. marshals transfer Manuel Noriega Friday to a federal holding cell in southern Dade County.

"enabled justice to be served, American lives were protected, and it helped Panama set out on a new democratic course."

**Panama 'on the mend'**

The nation, Bush said, is "on the mend with encouraging economic growth rates, reduction in drug trafficking and a new commitment to democracy."

But the president's assertion about drug trafficking is contradicted by administration reports, along with other government studies, which conclude that drug trafficking and money laundering in Panama may have increased since Noriega was ousted in December 1989.

A State Department report on international narcotics control strategies issued last month credited the government of Guillermo Endara with trying to combat drugs, but said that "narcotics trafficking and money laundering continue to be serious threats to democracy in Panama" and that Panama remained "a major transship-

ment point for cocaine destined for the U.S. and Europe.

A report last summer by the General Accounting Office, the investigative arm of Congress, provided a harsher assessment.

It said that U.S. officials believed that "drug trafficking may be increasing" and cited one unnamed agent of the Drug Enforcement Administration who "believes that trafficking may have doubled since the general was toppled by U.S. invasion forces."

After a seven-month trial, Noriega was convicted Thursday of eight criminal charges, including cocaine trafficking, racketeering and money laundering. Prosecutors convinced the jury that the defendant had accepted millions of dollars from the Medellin drug cartel, which wanted to ship tons of cocaine through Panama on its way to the United States. He is scheduled to be sentenced in July.

**Invasion's goals**

From the start, Bush administration officials said the chief goals of the invasion included not only the restoration of democracy in Panama but also the apprehension of the erratic, sword-waving dictator and the curtailing of drug shipments through Panama.

A force of 27,000 U.S. troops overwhelmed the Panamanian Defense Force in four days, with 23 Americans and hundreds of Panamanians killed.

Noriega retreated to the Vatican embassy in Panama City. He was arrested and brought to Miami on Jan. 4, 1990, to stand trial.

The military victory in Panama handed the Justice Department an unanticipated legal problem.

At the time, senior officials said the indictment against Noriega was thin and that it had been prepared nearly two years before the invasion, when it appeared unlikely he would ever be brought to trial.

As a result, the prosecutors' fear of the political repercussions of an acquittal often seemed to dictate the government's scorched-earth approach to building the case.

Federal prosecutors went to such extra lengths to bolster their case that Rep. Charles Schumer, D-N.Y., is asking the Justice Department for a detailed account of the deals granted to prosecution witnesses and is requesting an audit of money used to pay them.

**Convicted witnesses**

Schumer said that the prosecution called more than 40 witnesses, most of them convicted drug traffickers. The report profiled 15 witnesses, who were excused of crimes "worse" than those for which Noriega stood trial.

Among them were Ricardo Bilonick, a former Panamanian ambassador at-large to the United States, who testified in the Noriega trial that he earned \$47 million in drug profits; Floyd Carleton Caceres, a pilot who was an arms and drug courier for the Medellin drug cartel, and Col. Luis del Cid, Noriega's self-described "errand boy," who testified that he knew of millions of dollars in drug profits laundered through Panama each week.

Schumer, who is chairman of a Judiciary subcommittee on crime and criminal justice, said in a report issued Thursday that the Department paid some informers hundreds of thousands of dollars in direct payments or compensation, and allowed informers to keep millions of dollars that it knew had been earned through drug sales.

Other witnesses were granted immunity from prosecution for their drug crimes, excused from paying tax penalties, exempted from deportation and promised placement under the federal witness protection program.

"The government was hellbent on convicting Noriega no matter what the cost," said Schumer. "When you look at some of the Faustian bargains that were struck, you have to wonder, did we really have to burn down the village down in order to save it?"

\* LIKE MANY CULTURAL AREAS,  
THE STRESS IS ON "CONTROL"  
RATHER THAN "PREVENT"

7,000 →

"DEMOCRACY"  
ALWAYS LEADS TO TYRANNY. STUDY YOUR POLITICAL SCIENCE!



## INTERVIEW: Colonel Bo Gritz and the Doping of America

ACRES U.S.A. So the CIA went into the drug business in a big way?

GRITZ. Well, there's no question about it. Air America was the CIA's private air force. It was a massive air force, probably one of the world's largest airlines, and this was known to every GI—who had any knowledge of Laos or Cambodia—as Air Opium. Which it was certainly. While the pilots were brave and while there is no question they did some incredible work in denied areas under very hostile conditions, the fact is that Air America aircraft were used to transport illegal narcotics all over southeast Asia. These ended up in the arms of American fighting men. Heroin was cheaper than beer during the war. Drugs also ended up in the United States, overdosing this country back in the 1960s. And drugs have continued to overdose the country even into the 1980s and will continue in the 90s unless something is done to stop it.

ACRES U.S.A. Who made the decision to go in for these activities, such as bringing dope to the American servicemen and then flooding the United States with dope as though the objective was to turn the United States into something akin to the China of the Opium Wars era?

GRITZ. Well, and you said it exactly. If you go back and look at history, it was in the 16th century that Great Britain through the East India Trading Company doped China. We legally import opium into America because opium and morphine are used for medicinal purposes. But England began importing and forcing opium upon China for political purposes—and yes, it is a repeat of history in that a nation that is on its knees, drugged out, uneducated, unable to read and think, is much more vulnerable than a nation that is alert and prepared. And so the rationale behind it was that the southeast Asian war was supposed to be limited, according to the U.S. Congress and the UN—limited to Vietnam, but the Vietnamese were very knowingly and openly moving their manpower and material through the mountains in North Vietnam down a mountain chain spine like the Appalachians or Sierra Nevadas. This chain separates Laos from Vietnam and Cambodia. The enemy would move men and materials into Laos and down through Cambodia and then back into South Vietnam. Well, it was King Rex for them. We couldn't touch them. The CIA wanted to interdict the Ho Chi Minh trail, as it was called, but we were prevented from doing so by the UN and the U.S. Congress. We did it anyway. Congress didn't appropriate any money, but J. Edgar Hoover made a statement in the 1960s. He said, *We don't care about people who use heroin. They're unAmerican and mainly in the black ghetto.* That gave the CIA license, because J. Edgar Hoover was seen, literally, as the conscience of America at that time. His blessing gave the CIA license

to begin dealing in dope to make up a slush fund that would support covert operations the U.S. Congress had not approved of or provided money for. You can have garage sales or cookie bakes or whatever. You'll make a few pennies, but if you want to supply armies with munitions then the only way to do it is through the sale of high ticket stuff, drugs, in short, if you're not going to do it legally through the sale of drugs and guns. That is exactly what the CIA did.

ACRES U.S.A. But they didn't quit when the war was over?

GRITZ. No. In 1975 when the war was over, they didn't quit. We then had the Shah of Iran to deal with. We then had Iran-Contra connection. In 1976, I was Commander of Special Forces, Latin America. George Bush was head of the CIA, and I knew that we were running cocaine out of Colombia. The cocaine is grown in Bolivia and refined in Columbia. Aircraft flew low level missions beneath the radar mask, which means they had to fly at night below 500 feet altitude. I knew about it because it is not habit forming to fly through the Darien Mountains at night. So they had the U.S. Army Special Forces and Rangers set up navigation towers at Bogota, Turbo, Colombia and Albrook Army Air Station on the Pacific side of the Panama Canal Zone. The CI aircraft were bringing up cocaine at the rate of more than one flight a night from Bogota, landing at Albrook. Manuel Noriega was laundering the money through the banks in Panama, and of course America was being overdosed.

ACRES U.S.A. Who or what was the distribution arm?

GRITZ. The distribution arm is the Mafia. Listen, if you remember during World War II, who did we deal with in Italy to try and defeat the fascists? There were only two great entities in Italy with the kind of organization to do that. One was through the Pope, and the other one was through the Mafia. Well, we weren't dealing with the Pope. Finally, we literally did not leave the Mafia there when World War II was over. We brought them home with us. These guys didn't go to work in convenience stores. They kept on doing what they do best which is dope, prostitution, murder, extortion, organized crime. If you remember, it was Santos Trafficante of the Mafia who we were going to get to kill Castro. If you recall, the only reason John Kennedy won the election over Tricky Dick Nixon is because Kennedy's Chicago Mafia was more powerful than Nixon's Florida Mafia. We have been in bed with covert operations with the Mafia since World War II and OSS days.

ACRES U.S.A. Was this something that Truman was responsible for, this inaction in bringing back GIs? Or was it Allen Dulles?

## M A T R I X I I I

GRITZ. Listen, I am here to tell you that a lot of people talk very highly of Allen Dulles, but I know a little bit about him. A lot of things may have been wrong with Truman. If you remember Truman fired MacArthur and we all disagreed with that. There was some collusion going on because MacArthur was going to bomb the bridges over the Yalu River, and some of the oil depots that were owned by Rockefeller and some of the power plants and Lin Pio [the Chinese Defense Minister] later said he would have never intervened in Korea if he had not had assurances that America would not bomb those critical installations, so Truman certainly wasn't lily white—but in deference to Truman, when the war was over, Truman saw that we were sandbagged. We authorized the newly created CIA to bring in Nazis. General Galen was Hitler's principal intelligence officer. He was allowed to pick 300 of his very best. They weren't prosecuted at Nuremberg for war crimes. Instead General Galen brought 300 of his best SS Nazis into America. We gave them citizenship because we figured they would know how to fight Russia better than we would.

ACRES U.S.A. Galen ended up in the United States?

GRITZ. Of course. And so it's no wonder that we have George Bush and a corporate fascism model today. We've had these fascists in here helping us all along. But in deference to Truman, he got rid of the OSS. He saw where we had tremendous links to the Mafia and drug running during World War II, so he wiped out the OSS. He allowed the National Security Act to be passed in 1947. This created the CIA, but the CIA charter was extremely limited. It was only supposed to be an agency to gather information for the president.

~~ACRES U.S.A. Well, how did the covert action clause get in there?~~

GRITZ. I think because of the likes of Allen Dulles. When Eisenhower came into power, we had John Foster Dulles, the Secretary of State. His brother, Allen Dulles had been a member of the OSS. Allen Dulles loved spook work, and so he was given the job by Eisenhower as head of the CIA. Allen Dulles—with Tricky Dick Nixon—set up the whole Bay of Pigs affair. Kennedy wasn't suppose to win the election. It should have been Nixon. Of course, Kennedy fired Allen Dulles as head of the CIA. It is a little bit ironic that Allen Dulles went on to be the head investigator for the Warren Commission after he had been fired. Kennedy had made the statement, *I am going to splinter the CIA into a thousand pieces*. Well, of course, they weren't going to allow that to happen and so they got rid of Kennedy.

ACRES U.S.A. Who got rid of Kennedy? Is the Stone film, *J.F.K.*, halfway accurate, fully accurate?

GRITZ. I think the Stone film is probably 90% accurate. When Kennedy was killed on November 22, 1963, I was a captain teaching assassination and guerilla warfare at

the Special Warfare Center, Unconventional Warfare Department, Fort Bragg, North Carolina. I recognized the signature of a trianglization shooter team even as I would recognize my wife's own handwriting, even though she didn't sign a note to me. And there is no question, we had a team known as RZ Rifle. The team was designed to kill Castro. The team was based out of Mexico City. It was well known by Nixon. It was well known by Allen Dulles. It was well known by J. Edgar Hoover. That trianglization team was brought to America and instead of killing Castro, it killed John Fitzgerald Kennedy. The team was made up of Americans working as CIA contract operatives and Cubans. It was designed to deal with Castro, but it ended up being a weapon of destruction for the President of the United States.

GRITZ. The New World Order, to work, has to destroy our constitutional system, our constitutional government. Effectively, George Bush is not a leader of the American people. He is, primarily, a drone for this New World Order. The New World Order has its American side in the Council of Foreign Relations and the Trilateral Commission, but mainly the New World Order is of European manufacture through the Royal Institute of International Affairs, the Club of Rome, the Committee of 300, the Olympians. These are all the elitists. This includes Queen Elizabeth. It includes Henry Kissinger and Zbigniew Brezinski and all of these turkeys you've heard about over the years—Rothschilds, Rockefellers, etc. It includes the owners of the Federal Reserve. They have very carefully planted a cancer within the body politic with the idea that cancer would eventually destroy that body politic. These elitists can be named. In the New World Order, George Bush is just a worker. He has said, *Whatever I am, whatever I become, I owe to David Rockefeller. Well, Jimmy Carter was nothing more than a Rockefellerite as a Democrat and that is the same with George Bush.*

ACRES U.S.A. This New World Order thing keeps popping up—all the way from Wendell Wilkie's *One World* to the Bush euphemism. When George Bush was CIA director, did he know his agency was doping America?

GRITZ. There's no question about it. He had to have known. I don't care what he says openly. He had Manuel Noreiga jet from Panama to Washington, and he met with Manuel Noreiga. His deputy had Manuel Noriega stay in his home. George Bush went to the Philippine embassy in Washington and met with Manuel Noreiga. He squired him around Washington, D.C. This was 1976, exactly the time frame in which Operation Watchtower was going on. In my book, I include Colonel Edward Cutolo's affidavit. He was the Colonel who was in charge of Operation Watchtower. He was the second commander. A. J. Baker was the first commander. Operation Watchtower was an operation to run through CIA aircraft cocaine out of Bogota, Colombia.

## M A T R I X I I I

ACRES U.S.A. Basically you're saying that Bush knew that we were doping America, Chinese style, and that he allowed this to go on under his tutelage as Director of the CIA?

GRITZ. He certainly knew. He had Manuel Noriega on the payroll, and if this were a court of law, I think Bush would be found guilty beyond reasonable doubt because when Stansfield Turner took over from Bush as head of the CIA—Stansfield Turner was brought on by Jimmy Carter when Ford left office—he immediately fired Manuel Noriega saying, I will not have a drug smuggler on the payroll of the Central Intelligence Agency. As soon as Reagan came to Washington with Bush as his vice president, immediately they put Manuel Noriega back on the CIA payroll.

ACRES U.S.A. How long has this continued, this business of an agency like the CIA earning its own funds by selling dope?

GRITZ. Well, I think since World War II, when the OSS was in bed with the Mafia, and then it continued when we brought the Mafioso back to America as our agents. They continued in our secret forces meaning, in OSS, then in CIA. We continued to use these guys because the things the government couldn't admit to doing, you could always hire a thug to do. Santos Trafficante was the Mafia chief in Havana. He was jailed by Castro. The CIA got him out of prison, got him out of jail in Cuba and brought him back to the United States. We hired him to kill Castro. It's public record that Santos Trafficante tried to kill Castro with poison but it didn't work.

ACRES U.S.A. But did the dope peddling continue up to the present?

GRITZ. Certainly. That's the way that we paid for the army in Laos. The war in Laos from 1960 through 1975 never had any money appropriated by Congress. General von Powell was the contact for the CIA in Laos as von Powell was set up in Missoula, Montana with a barley ranch. He runs a development corporation today. He controlled the opium and heroin flow for the CIA. The CIA used Air America to transport it and that's what paid for a lot of covert operations in Laos and Cambodia. More recently, Ollie North ran the same connection with Iran-Contra. His diaries that were not shredded were recovered by Lawrence Walsh. Lawrence Walsh is now approximately 77. He was the independent prosecutor for Iran-Contra and he revealed that there were 500 entries in Ollie North's personal diaries that alluded to illegal narcotics being used to fund the Contra operation. Of course, we didn't give guns to the Contras. We sold guns to the Contras at about a 300% markup. The Contras do not have enough money to put shoes on their feet, but the drug cartel was willing to pay the price if the planes that delivered the guns to Nicaragua came back to the United States loaded with drugs. And so they did. As a matter of fact, we have on video tape the testimony of pilots who delivered 26,000 pounds of munitions to Nicaragua, then took off and flew back 26,000 pounds of drugs, landed at

Homestead Air Force Base in Florida, were met with a follow-me truck, taken to a remote part of the field where the pilot was paid \$75,000 and the drugs were loaded aboard trucks to be taken off the Air Force Base. The same thing happened at Laguna Army Air Field at Yuma, Arizona. These aircraft were coming back loaded with drugs in the 80s. Drugs, of course, ended up paying for the guns.

ACRES U.S.A. What was the purpose of the Panama invasion and the seizure of Noriega?

GRITZ. The real purpose has been veiled. The eye-wash explanation was that he was a no good drug smuggler, and so we were going to go down and seize him.

ACRES U.S.A. Chastise him! Yes, that's what we read in the papers. Now what are the facts?

GRITZ. Several months before this happened, before Just Cause began, Noriega made a statement. He said, I have George Bush by the cahonies. Well, Bush didn't send the paratroops at that time. Richard Armatage, who was the bag man for the U.S. government mentioned by Khun Sa. Khun Sa said that the U.S. government has been his best customer for more than 20 years, that Dick Armatage was the man who handled the money with the banks in Australia. In the video tape that we have you see Khun Sa saying all of these things about Armatage. In my book, there are affidavits signed by Khun Sa testifying to who his government contacts were. There's more than just Armatage. But Armatage went down into Panama and told Manuel Noriega that he better get in line and cooperate. Well, the thing that really caused the Just Cause to occur is that Noriega said he was going to nationalize U.S. private holdings in Panama. George Bush has more than \$12 million invested in Panama himself in the tourist trade, meaning in hotels and this kind of thing. So when Manuel Noriega said he was going to nationalize those U.S. holdings, immediately we sent the paratroops in. Before the paratroops went in, after Armatage had gone down, there was a coup in Panama and a Major Garcia had seized Manuel Noriega, had him in captivity, and he sent three messengers to the Amador—which is our headquarters on the Pacific side of the Canal Zone—saying I have Manuel Noriega in captivity and I want to turn him over to the Americans. Now this was just before the paratroops went down, and we wouldn't take him. We refused. We said, No. Eventually, Noriega's troops came in. Noriega executed Garcia personally. The people who were with him were also shot. Bush ended up sending in troops who caused the deaths of 6,000 Panamanians and billions of dollars of damage. When Manuel Noriega said, I am going to nationalize U.S. individual holdings, bang, that was it. George Bush was not going to lose his investments.

ACRES U.S.A. Is there any legal basis for going into a country to seize a man like Noriega for the purpose of trying him in the U.S.?

## M A T R I X I I I

GRITZ. There certainly is not. It is unprecedented. I am wondering if Saddam Hussein would be justified in coming in and seizing George Bush and taking him back to Baghdad for trial.

ACRES U.S.A. Well, if he could do it and get away with it, perhaps. Favored nation status seems to be governed by personal economics, rather than national interest?

GRITZ. China is a favored nation. Technically, favored nation status is something you don't come by easily. Russia, for example, is not a favored nation. Red China, of course, ran over their own people and shot them up in Tiananmen Square. It is totally outrageous that George Bush would continue the favored nation status, but he has about \$15 million personally involved again in the tourist trade in Shanghai, meaning golf courses and hotels and this type of thing. So to promote his own private interests in Shanghai, in China and in Panama, George Bush has continued to deal favorably with these countries. For example, when we went down and seized Manuel Noriega, we put in, as president, a man who was running one of the drug banks. He now is the president of Panama. We also, at that time, opened up the banks again so that they were totally free to launder drug money, even freer than they were under Manuel Noriega. So we now have as running the country in Panama a banker who was one of the leading laundry experts for drug money coming through Panama. Manuel Noriega is not banking there, of course, but the banks are even open wider now than they were before for money laundering, and I think you are going to see Manuel Noriega eventually freed. He has about \$10 billion dollars he has been able to scrap off of the drug operations. He'll probably end up becoming Saddam Hussein's neighbor on the French Riviera. The French will take almost anybody and I think eventually you're going to see Saddam on the French Riviera retired with his \$10 billion. Hussein may have a little more because he also has 800 tons of Kuwait gold.

ACRES U.S.A. Which he never returned to Kuwait?

GRITZ. Iraq never turned it back in to Kuwait. They keep saying they are going to, but I've never seen where they did.

ACRES U.S.A. Let's just take one final shot. What would you say if you had a chance to independently, individually or en mass, talk to the average citizen?

GRITZ. Well, the first thing I would say is that America must say *No* to the New World Order, that American must remain a sovereign nation and the way we are going right now we won't get a chance to vote because the borrower is the slave to the lender. I would say that in order to keep our sovereignty, our birth right intact, we have to get rid of the Federal Reserve. The Federal Reserve is no more federal than Fred Smith's Federal Express. The bankers are in business to make money. That's

why we have \$300 billion in interest right now. That is why John Fitzgerald Kennedy and Abraham Lincoln were assassinated, because both of them bypassed the bankers. Abe Lincoln in 1863 authorized \$450 million in greenbacks and JFK in 1963 authorized \$450 billion in United States notes. Well, these international bankers don't go down easy. The Federal Reserve is not owned principally by Americans. The Federal Reserve is owned principally by European bankers and their idea is to bankrupt us. So, number one, we get rid of the Federal Reserve by resurrecting the Kennedy \$450 billion United States notes because as soon as Kennedy was killed Johnson stopped the printing of United States notes, and went back to the interest bearing Federal Reserve Notes. The second thing—we would stop the income tax because income tax is unconstitutional. All we have to do is go to the state houses of the 48 states and determine whether or not they properly ratified the Sixteenth Amendment. They did not. There is no statute of limitation on fraud. So you do away with the income tax and go back under the Constitution as a way of paying for government.

ACRES U.S.A. O.K., what about GATT, General Agreement of Tariffs and Trades?

GRITZ. Well, the General Agreement on Tariffs and Trade violates the Constitution—especially the fast track provision. I have a thing called the Bill of Gritz. The Bill of Gritz has 10 points. Basically, it says that every law that does not square with the Constitution will be repealed. The Constitution says that we have tariffs and duties on imports and direction apportionment as a way to pay for government. Here's how that translates; if Chrysler wants to go offshore to Mexico in order to make batteries because they can do it for 50 cents there, whereas it costs \$25 in Indianapolis, then Chrysler is going to have to pay a duty when they bring that battery back into the United States. The reason Japan is the most productive nation on the face of the earth today is because Japan has adopted the American system, and we have abandoned it. The reason America has slipped is because we have opened our borders to free trade. Only in America can you buy up the land and the businesses. You can't do it in Japan. You can't do it in China. You can't even do it in Mexico. We've allowed ourselves to be hoodwinked into thinking that protecting the nation economically is wrong. When I am president, we are going to make it nonhabit forming for foreigners to buy up America. If you are a foreigner and you want to buy up an American business or American land, you are going to pay such a high duty it will not be to your advantage, so very quickly you are going to see these businesses turned back over to America, and you are going to see these foreigners getting out of the United States and out of ownership of our farmlands and our industrial capacity. □









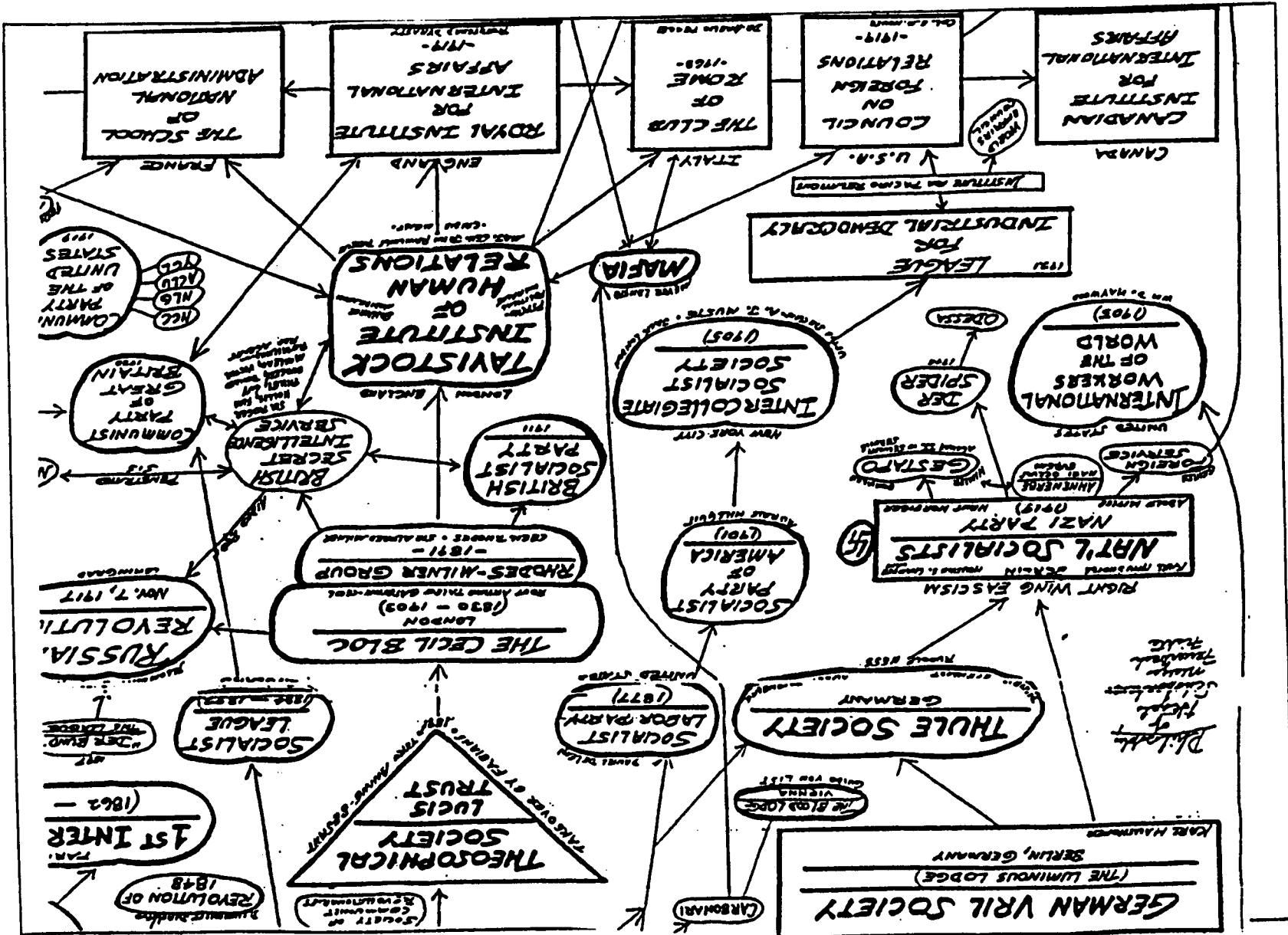





0637

M A T R I X I I I

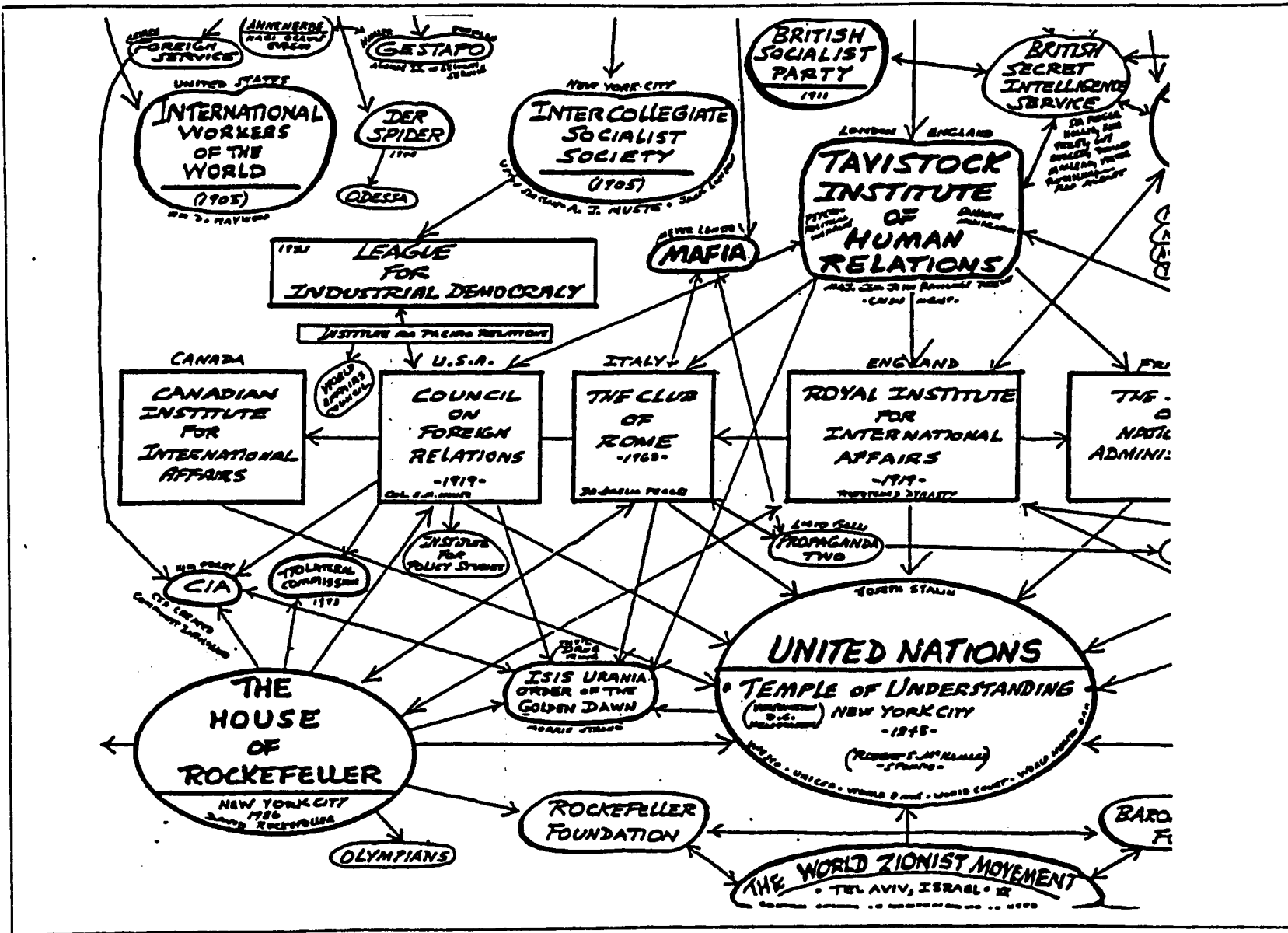

## ***THE CONSPIRACY: UPDATED \****

Americans have been so programmed to change, and this has a special significance, that we are no longer aware of it, nor are we aware of the unrelenting pressures on us to change our American way of life. It is no wonder that our divorce rate is so high, that suicide is on the increase, that social deviations from the norm are more and more acceptable. As a nation, we appear to have lost our way, or rather, the huge number of choices with which we are daily confronted, has caused us to become confused and unable to make those choices.

We live in a throw-away society, programmed not to last, this is part of the Age of Aquarius Conspiracy. Since Stanford Research Institute first mounted its offensive, back in the late 1950's, - early 1960's, we have been subjected to subtle but heavy pressures by Stanford's team of specialists in the field of future shocks. We have, since the 1950's been through a prolonged "softening up" to condition us so that we will change our ways and our life-styles at every level.

This insidious pressure was increased in intensity in 1986, and will reach its highest intensity levels by 1993. Things are changing so fast, that we have become "punch drunk," a scientific fact, as we shall see.

The latest threat to our freedom is the personal computer card, which we will be discussing. The computer card will accelerate the process of depriving us of our familiar environment, and environment as we shall see means more than just the usual explanation of the word. We are going through a period of trauma, on a scale that we cannot begin to imagine, let alone believe.

This is as it should be; this is how Tavistock Institute and Stanford planned it, this is how the social scientists have mapped it out. Nothing changes by itself, all changes are preplanned, and as a result of this onslaught, we have been changed, very gradually at first, and then with increasing momentum from one nation into a polyglot of nations. We are no longer the one nation as we claim to be.

Nor have we ever been, except in the beginning, when our forbears came from Anglo-Saxon stock and gave us a common nation with a common religion, namely Christianity.

Our forbears spoke a common language, held common ideals, and shared the common religion of Christianity. There were no aliens in their midst, that only came much later, and was deliberately planned to break us up into several fragmented nationalities, segments of differing cultures and languages, which could under no circumstances be called one nation.

The United States is many nations striving to co-exist under a common system of government. The culture shock which resulted when these aliens were allowed into the midst of a common language-common religious and cultural background, caused great confusion, and made "one nation", an unworkable concept.

It was part of an ongoing Freemason conspiracy to nullify the American Revolution. The social upheavels which followed, can all be traced back to this starting point.

Science has proved that there is a limit to absorption of change, before people crack up completely. The U.S. has reached the limit of its absorption capabilities. Individually this truth applies, and we shall examine a few of the profound implications of this as we proceed. Nations are made up of individuals, and individuals, no matter how robust and equipped with great stamina they are, have a definite limit to their ability to absorb and withstand changes without fragmenting.

That was the basis of the Strategic Bombing Survey which called for the saturation bombing of German worker housing, during WWII. The study was conducted by the Prudential Insurance Company, and its subsequent adoption and application proved very successful in bringing about the defeat of Germany. Many of the scientists who were engaged in that project, are either still working on saturation bombing America, or they have passed their knowledge onto others who are

continuing with their devilish work.

The enemy decided to make a strong move against the people of the U.S. back in 1980. Who is the enemy? Are we talking about the Russians? While the criminals in the Kremlin are the enemies of free people everywhere, they are not the subject of this report.

We are talking about the corporations and people in what is known as the Eastern Liberal Establishment, allied with their European cousins, backed by the biggest and most important banks, financial institutions and insurance companies; communications networks, the printed media, law, education and religion.

This group was responsible for providing the assistance which brought about the Bolshevik Revolution and WWI, as well as WWII. This is the group that managed the controlled disintegration of the U.S. economy, created "local wars", and international tensions, mass brainwashing of the nation through "The Beatles", drug cults, mystic cults subjecting us to one cultural shock after another until we have become nearly totally confused, dazed, numbed and largely an apathetic people.

Why has this been done to us? Simply put, it was and is being done to break down our resistance and weaken our determination to resist changes we know are against the best interests of the nation and individuals who go to make it up.

America today can be compared with the soldier who falls asleep in the thick of battle. We fall asleep when we give way to apathy, brought on when confronted by confusion through changes that so alter our environment, that we are no longer able to make the right choices. We react as the soldier often times does in the heat of battle; we give up because we don't know what else to do.

There is a technical term for this condition and it is called "long range penetration strain". The art of subjecting a very large group of people to continued long-range penetration strain, was developed by scientists working out of the Tavistock Institute of Human Relations, the Stanford Research Institute, the Rand Corporation, and at least 150 similar but smaller institutions.

Dr. Kurt Lewin, the scientist who developed this fiendish art, and I use that word as a quotation, has caused the average patriotic American to fret over various conspiracy theories, and his failure to isolate and understand the underlying causes of changes and decaying values, which he sees all around him, and who fears the social, moral and political changes he deems undesirable and does not want.

Now we won't find Dr. Lewin in any of the regular history books which are in fact nothing but a view of war from the side of the victor. In fact I take great pride, and justly so, as the first to bring the name of Dr. Lewin to your attention.

It was Dr. Lewin who organized the Harvard Psychological Clinic, and the Institute for Social Research. These names do not give any indication as to what their purpose is. They remind me of the infamous bill to reform coinage and mint laws, which was passed in 1873. It was certainly a harmless-sounding bill, but the title was misleading; indeed deliberately so.

Senator John Sherman betrayed the nation into the hands of the international bankers. Sherman sponsored this "harmless" bill without reading it, (and I wonder if President Reagan signed the INF Treaty without reading it), one of the most ugly frauds ever perpetrated on the American people.

As we know, its true purpose was to demonetize silver, and give the thieving banks unlimited powers over this nation; powers to which the bankers were not entitled in terms clearly and unmistakably laid out in our Constitution.

Kurt Lewin gave the institutions I have just mentioned, unlimited powers over the American people, to which they had no right, and these institutions have used their power to destroy the will

of this nation to resist the intentions those who are steering us away from the fruits of the American Revolution.

Lewin's colleagues in his satanic plot to diminish our national will to resist changes not in our interests, were John Rawlings Reese, Richard Crossman, Eric Trist, H.V. Dicks, Wallace Harmon, Charles Anderson, Gardner Lindzey, Richard Price, and W.R. Bion.

This is not a complete list of the plotters. There were and are hundreds of others involved in forcing radical uncontrolled changes upon us, but these were the ringleaders. Together they founded Stanford, Rand, MIT, and the National Training Laboratories, Essalen Institute, and scores of similar institutions.

What was taught at these institutions spread out across this great land like a cloud of poison gas, the foul miasma penetrating government at all levels, the church, schools, the news media, opinion makers, Congress, the Supreme Court, until every layer of our lives, national and private became saturated with deadly toxic poison to which we have now almost totally succumbed.

In 1980, I exposed the Aquarian-New Age conspiracy, which was the result of four years of intensive investigation and research, with which I am still continuing. The success of the Age of Aquarius-New Age conspiracy, can be seen in the visible signs of breakdown in our environment, the all-inclusive state in which we live.

The use of "rock music" to spread the message of drug-cults, the overwhelming rise in mindless violence, especially among teenagers and so-called "serial killers", and the overlapping and unmistakable signs of lethargy which is called "long range penetration" are part of our environment and as dangerous, if not more so than pollutants in the air we breathe.

We as a nation, and individuals, were not prepared for the changes that were forced upon us by the Aquarian Conspiracy, therefore our response to this danger has been a falling-off of our ability to withstand and resist it. As a nation we have become fatigued, we are in psychological distress, of which widespread apathy is the outward manifestation.

The Tavistock Institute describes our national condition after two decades of saturation bombing shocks, social turbulence caused by created crises, and crisis management as follows: "There are three distinct phases in the response and reaction to social crises displayed by large population groups. First, there is superficiality, the population under attack, will defend itself by adopting slogans, this does not identify the source of the crisis, and therefore does nothing to address it, hence the crisis will persist. The second is fragmentation. This occurs as the crisis continues, and social order breaks down."

And who can deny that with the huge increase in the use of drugs, with crack making thousands of new instant addicts each day, a shocking rise in the number of murdered infants, which now far exceeds our casualties in two World Wars, the acceptance of homosexuality and lesbianism, with laws to protect the "right" to ply their destructive way of life; murder, rape, a falling off in education, a numbing increase in divorce, that our society is breaking down. Tavistock says: "Smaller groups will break away to defend themselves; the so-called "maladaptation" because here again, the source of the crisis is not identified, and so the response is maladaptation."

"Then, there is the third phase, where the population group goes into 'self realization', and turns away from the induced crisis, and there follows a maladaptive response, accompanied with active synoptic idealism and disassociation".

According to Stanford, and I know this to be the truth, this type of induced trauma has been going on in America for 30 years, yet how many of us are aware of the insidious brainwashing to which we have been forcibly exposed.

An example of this can be found in the mysterious gang wars which broke out on the West Side of New York in the 1950's. Where this came from was not known until very recently, when

researchers (including myself), uncovered the connection between the seemingly chance encounters and the hidden forces that directed them.

Gang wars were carefully planned events deliberately created to shock society and cause ripples of disturbances. By 1958 there were in excess of 200 of these gangs, but then a very strange thing happened. In 1966 they had all-but vanished from the streets of Los Angeles, New York, Philadelphia, Washington, Newark and Chicago.

Throughout the period of gang warfare, the public reacted exactly according to profile; society as a whole could not comprehend gang warfare of this nature, and the public responded in a maladaptive manner. But had there been some who were wise enough to realize that what they were witnessing was a social engineering brainwashing experiment, the whole filthy edifice would have collapsed.

Even if such a discovery had been made, there would have been no media coverage; the discovery would certainly have been smothered. An example of a large group being unwittingly subjected to brainwashing is that of the Beatles, who brought Tavistock's Theo Adorno's 12-atonal system of music to the US.

Without the cooperation of the electronic media, and in particular that of the scurrilous Ed Sullivan, who knew very well what the plot was, nobody would have given this motley crew and "their" music the time of day.

Now that we know it, it is too late to counteract its insidious influence, the damage has been done. Our values have been changed forever by the rag-tag band from Liverpool, or rather from the Tavistock Institute. And they didn't write the music, if one dare call it that; Theo Adorno did it for them.

The prime function of the Beatles was to be discovered by "teenagers", and incidently the word 'teenagers' was never used until after the close of WWII. It was a trigger-word created by the Tavistock Institute to create a distinctive segment of the population and persuade them to believe that the Beatles really was their "favorite" group.

The word teenager was constructed by Tavistock, and released for mass youth control purposes. The Beatles did a perfect job, "with a little help from their friends", i.e. illegal substances we call drugs.

The Beatles were a highly visible "new type", and please take note of that expression, because it is part of the jargon used by these social tinkerers, and as such, the Beatles made new styles and new tastes for teenagers which upset the older generation. It is important to note the deliberate fragmentation -inducing language.

The role of the media was, and remains, very important in the brainwashing of society. The street gangwars ended, because the press and TV media ceased to pay further attention to a medium of change that was "burned out". They had served their purpose, which was to create turbulence in society.

And thus that attention was focused on the so-called "beat generation", yet another phrase coined by Tavistock in its effort to bring about social changes in America. The hippies and beatniks, the drop-outs in jeans, sandals, filthy clothes and long hair became the role models of youth, just as the "cleaner" Beatles had been before that.

This created style took in millions of young people, and even the older generation began to believe that American youth was undergoing a revolution, failing all the while to realize that it was not a spontaneous movement but an artificially created one.

These were the disciples of lysergic acid, LSD, so conveniently provided for them by the highly respected Swiss pharmaceutical Sandoz company, and financed by the great Warburg banking dynasty, and brought to the U.S. by Aldous Huxley. The new "wonder drug" was promptly

distributed on campuses in free sample package lots. There is a question that cries out to be answered: "What was the FBI doing at that time? Was it fast asleep, or deliberately looking the other way?"

With the coming of "rock", which I will henceforth use as shorthand to describe Adorno's devilish bedlam of sounds, a tremendous increase in the use of marijuana occurred. How did it occur? Well, it just didn't "occur", it was all carefully planned well in advance, and the jackals of the media saw to it that the "new culture", (another of Tavistock's creations), received the widest possible publicity, which cost the puppet-masters, not a thin dime.

Now because of the anger I feel about people, and I think particularly about one individual, I make no apology for language which perhaps is not of the standard I am accustomed to, but one of the most disgusting slobes ever to walk the cities of America, was an alien, Alan Ginsberg.

We can be sure that Ginsberg's antecedents were not Anglo Saxons, nor did any of them come over with the Pilgrim Fathers; rather, they came over on the crests of the Roosevelt flood-tides of Eastern Europe waves of immigrants, and their coming is one of the worst disasters ever to befall America, and contributed largely to preventing America from becoming a unified nation.

This Ginsburg pushed LSD through advertising, which cost him nothing, though it would have fetched billions of dollars in advertising revenues for TV and the newspapers under normal circumstances.

This free advertising reached a crescendo in the 1960's, thanks to the ever-willing cooperation of the jackals of the media. The effect of Ginsburg's massive advertising campaign on the American public was devastating; suddenly we were confronted with one cultural shock after another, in rapid succession. Here it is necessary to point out that through the introduction of alien races into our society, the task was a great deal less arduous than it would otherwise have been.

We became "over-exposed and over-stimulated", and again we must remind ourselves that this jargon is taken from Tavistock and Stanford manuals. We were "overstimulated" and overwhelmed by this new development, and when that happened, our minds began to lapse into apathy; it was just too much for us to cope with, i.e., long range penetration had taken hold.

Ginsburg claimed to be a poet, but no greater garbage has been written by anyone aspiring to be a poet. Ginsburg's real function was to push the new subculture and force its acceptance upon the U.S.

To assist him in this endeavor, Ginsburg coopted the services of Norman Mailer, and it was Mailer who got Ginsburg on national television, under the fake pretext of having a serious discussion with him, which of course was no more than a horrible charade.

We ought to take note of the method in which these demons get free advertising on TV. The electronic media moguls always have big hearts when it comes to giving free time to dirty products and even filthier ideas. Their promotion of Hollywood garbage speaks volumes.

Ginsburg gave a nationally televised performance in which he recommended the use of LSD and marijuana. Not to be outdone by the electronics media, every one of Ginsburg's dope friends in the newspaper business wrote special reports and articles about "this colorful character".

Ginsburg's friend, Kenny Love, published a five-page report. When newspapers want to advertise something not yet acceptable to the general public, they write "articles" in the papers or have "discussions" with a learned panel on TV.

Love's article appeared in the New York Times, and let me stress that had Ginsburg taken out the same amount of space in a paid ad, it would have cost him at least \$50,000, but he didn't have to worry, thanks to his friend Love, Ginsburg got it all for free.

Worse yet, (or better yet, depending upon one's viewpoint), the article was picked up by United Press (UP) and telexed to HUNDREDS of newspapers and magazines around the country,

under the guise of a "news" story. Harpers Bazaar and Time magazine, duly made Mr. Ginsburg "respectable". If a campaign of this magnitude were presented to Mr. Ginsburg by an advertising agency, it would have come with a price tag of close to \$1 million dollars! No wonder I call the news media a pack of jackals.

I suggest that you try something I once tried, with an expose on the Federal Reserve Board swindle. I took my story to major newspapers and magazines, TV and radio stations. Some made promises that sounded good, but not a single word of that article ever appeared in the establishment print and electronic media. I suggest that you take this account of how LSD was promoted in America to the news media, and offer it to them at no charge, and see if you have any better luck with it than I did with mine.

The point is that without massive media hype, and with almost round-the-clock coverage, the hippy-beatnik, rock drug cult would never have got off the ground; it would have remained a small localized affair. The Beatles with their silly twanging guitars, and ridiculous expressions, would never have amounted to a hill of beans. Society would not have been subjected to one series of jolts after another.

The men buried inside the think-tanks, whose names and faces are still not known to but a few of us, made sure that the press provided the necessary coverage. They also made sure that their plot to turn our young people into something which has no place in a Christian republic, was not uncovered.

Thus was our society "driven mad", through psychological shocks and stressful events, the actual language used in Tavistock training manuals. By 1966, the mother of this evil, the Tavistock Institute was ready to launch another of its mishapen creatures on an unsuspecting world.

The Science Policy Research Unit, (SPRU), was opened in Sussex University. Privately billed as a "future shock research" center, a title given to so-called future oriented psychology designed to manipulate whole population groups and induce "future shocks", it was the first of several such institutions.

"Future shocks" is described as events or series of events that come so fast that the human brain cannot absorb the information. As I said earlier, science has shown that there are clear limits to the amount and nature of change which the human mind can absorb and deal with.

After that, apathy sets in as the targeted group discovers that it does not want to make choices. Apathy is preceded by senseless violence, of which the New York and Los Angeles street gangs were part, hostility, murder appear. Apathy about these conditions then sets in, followed by withdrawal. Long range penetration strain now takes over.

Such a group is easily controlled, and will docilely take orders without rebelling, which is of course, the object of the exercise. "Future shocks", said SPRU "is defined as physical and psychological distress arising from the excess load on the decision-making mechanism of humanity". That again is the jargon which I have lifted directly from Tavistock manuals, which it doesn't know I have in my possession. It will probably shock them that their inner sanctum has been penetrated!

Just as an overloaded electrical circuit will activate a trip-switch, so humans "trip out", which is a syndrome that medical science is only now beginning to understand, although the brainwashers of Tavistock knew it as far back as the 1920's.

In 1962 the SPRU was run by Leland Bradford, Kenneth Dam, Ronald Lippert, and of course, a host of other scientists. Until I first revealed them, these names were NOT known among rightwing circles in America. Even today, they are known only to a relatively small group of researchers.

SPRU "future shocks" research unit run by the three scientists just mentioned, became a



training ground for scores of agents who later became skilled in manipulative techniques which were used to plant its policy papers in government departments at all levels.

That is why the U.S. will be run in the near future by committees and councils, who have been brainwashed into taking policy-planning decisions which they believe to be their own; decisions that will change the form of government and the quality of life in the U.S. to such a degree, we shall no longer be the country and the people we are now. We will have become a changed society through "crises adaption". Our environment will have been changed.

There is much talk about the environment, and environment to most people does not appear in their thinking as changes in life styles; changes they appear to have little if any ability to control. Environment of change produces deep anxiety and confusion, and we begin to look to group decision-making, rather than making use of our own resources. This strategy is a deliberate one, aimed at the most vulnerable of all areas, our self-image, and leads inevitably to our being led like lambs to the slaughter.

When we are manipulated by unscrupulous men without being aware of it, the stage is already set for a relatively easy transition from the present Constitution and our form of government, to a transitional period of change, leading to the entry into a One World Government, which will take a big step forward during the tenure of George Bush in the White House.

While there are those who say, "it cannot happen in America," and how often haven't we heard that expression, the fact is **IT HAS ALREADY HAPPENED**. Our will to resist events not to our liking has been steadily undermined since 1950. We will resist, some of us say. Well, some of us may be able to do that, but we will be in the minority.

Computerization has already robbed us of the ability to prevent being brainwashed and controlled. Which brings me to another environment, **PEOPLE CONTROL**, also known as personal information control, without which governments cannot play their numbers game. We the people have absolutely no means of knowing just what government knows or does not know about us. Their computer files are not subject to scrutiny by we the people. Do we really believe that personal information is sacrosanct?

Remember, in every society, there are rich and powerful families who control law enforcement agencies, and this includes the USA, and I can tell you that in my more than twenty years of research, I have definitely proved the existence of such families.

Do not for one minute think that if one of these families wanted to find out about us, they could not do so. There is no guarantee that a man like Kissinger, doesn't have his own private dossier on hundreds of individuals on his enemy list.

Some may think this far fetched. The secret Freemasonic P2 and Comite Monte Carlo had such enemy lists, running into many thousands of names. Kissinger was, and might well still be, a member of Comite Monte Carlo.

In any event, we would never know (until it is too late), what information government (and so many private agencies), have on us. Mass surveillance is here. It is not something that may come in the future.

The Bilderbergers who have gained in strength during the last two years, are known to have their own "pattern recognition technique". This is the jargon used by Tavistock Institute. The Bilderberger's security has computers capable of conducting mass-surveillance of any given population group, which includes the most personal details.

The Bilderbergers tap into data-gathering terminals used by commercial credit information companies. They have a plan calling for international identity cards linked to fingerprints. This chilling information was provided by my top intelligence contact in this field. We should not have any doubts about its veracity.

Little wonder that we are fast becoming a cashless society. A bill which will soon become law, is designed to regulate the amount of cash that each person will be permitted to have at any given time.

Pilot automated electronic payments are already being tested in Western Europe. Our right to privacy is about to be eliminated. Machine-readable documents, bearing internationally recognizable numbers are already here, which will soon embody our drivers licence number, which numbers can identify us anywhere.

In the world of George Orwell, we learned how absolute dictatorship operates in the daily lives of people, and by the year 2000, there is little doubt that we shall be in the dictatorial grip of a One World Government.

How can we be controlled? It will be something of the following order: All transactions we do will have to be authorized by the central data bank, and this will not happen, unless an authorizing number is displayed at the point where the transaction is taking place.

Let us suppose that we want to purchase food at a supermarket. Cash will not be acceptable, so we will show some type of "credit card" (shorthand for whatever the card will be called). However, to prevent illegal duplication, our card will have a secret encoded number which we cannot see and won't be aware of.

It might well be the number 666, so popular with Bible students who prophecy the future. Whatever the number, it will be tied in with fingerprint and voiceprint. If the secret number on your card does not check out, it will come up and your purchase will not be accepted. If you have been "marked" by the government, that too will appear and your transaction will be cancelled.

It will of course not be possible to tamper with such cards, especially with the encoded voice and fingerprint data, which means that if we are "outlaws" in the very real sense of the word, we will have great difficulty in obtaining food, as our card or absence of a card will preclude us from the system.

We have got to avoid the numbers game, our future depends on us being able to short-circuit the "system", and this is the kind of subject our Christian universities should be teaching. We should not think this speculation or imagination. Already there exists a far reaching system of tracing individuals, through the records of telephone companies for example. Telephone calls in the future will automatically deliver the address of ALL numbers called, even if not listed in the directory.

It has become so sophisticated that there exists electronic means of identifying and linking individuals with records held by credit card companies, insurance companies and employers and banks. This system can be fine-tuned and up-graded, which will leave us as naked as new-born babes in the hands of the One World Government.

If you are tempted to think that GLOBAL agencies don't exist, then go down town in Washington, DC, and find the office of the so-called "police force of the world", Interpol. Interpol is a One World Government Agency operating illegally in the heart of our nation.

Computers that can perform complex operations in seconds, and surveillance techniques have improved dramatically in the last decade, make it fairly simple to trace anyone back to the source from where the telephone call was made. Computerized payments will be compulsory in the near future, and will provide ready-made data on individuals, by linking billing information for utilities, TV, automobile payments etc. By this means, an almost complete picture of the individual can be arrived at.

In the near future we are destined to become a cashless society, with profoundly far-reaching impact on our rights as individuals, economic freedom and our whole way of life. Our right to privacy will disappear, even though it may still be in the Constitution. Great pains will be taken to conceal the real intent of future legislation which will deprive us of our rights.

We will be told that new laws are necessary to govern electronic payments, having been subjected to a barrage of propaganda on how convenient such payments are over cash transactions. The fact that cash cannot be monitored or audited and enables one to live outside the numbers game, will of course be downplayed, while all of its inconveniences as opposed to the new system will blare forth from every TV screen in the land.

Cash limits the abuse of automation and its capture of personal data, which clearly threatens the individual. The flow of cash is difficult to follow when one knows how to follow certain basic elementary rules, which government clearly hates. It was one of the reasons why China cracked down on its "dissidents", because free market and floating labor paid in cash, made people control very much more difficult than before.

The globalists have already taken control of data gathering companies including market survey companies which give information vital to control systems. Companies of this type have proliferated in the past decade, and their size, and influence, ought to be of the utmost concern to those who believe in individual rights and freedom.

By channeling such data to a central computer (ordered by law as a means of tracing "drug dealers" for example), a serious threat to our liberty is immediately apparent, and will bring with it a change in the way we live. We shall be hearing a great deal about this in terms of "long range penetration" and "future shocks environment", to use Tavistock terminology.

The Tavistock Institute, the mother of all brainwashing institutes, is funded by Rockefeller and a number of giant global companies such as Unilever. The Survey Research Center, was established by Tavistock and became the top-dog in social profiling in the US. This institution conducts psychological studies on an enormous scale, which touch on every aspect of our lives. It specializes in what it calls "reshape response", and this is taken directly from their manuals which I am fortunate enough to possess.

In plain language, "reshape response" means that if a population group reacts unfavorable to a particular policy initiative, then that group's thinking is "reshaped", so that the response then becomes the required one. The Survey Research Center, works very closely with polling companies such as Gallop and Harris, and can obtain gauging of initiatives, and in this manner can "reshape" responses to conform to what is required.

Public opinion is no longer public opinion. What the majority of us believe is "our" viewpoint, is largely a viewpoint created for us. The campaign of Dukakis is a good example, because the turning point of his campaign was clearly discernable, only it was not a natural turning point, but a "reshaped response". The CFR had decided at that point to put its full weight behind George Bush.

Since 1965, Eric Trist has been directly responsible to Tavistock and hence to Rockefeller, for setting up a network of so called "organization development centers"; problem solving think tanks in other words.

It is a sophisticated brain-washing network which extends from factory floor to corporate office, from political clubs, to country clubs, schools to universities; "future shocks" is administered to create controlled stressful situations. The idea is to break individualism, and replace it with "team spirit", the words used in Tavistock manuals.

The gist of it is that our rugged individualism, for which Americans are famous, is being broken down and substituted with "team spirit" of the kind that is displayed by a flock of sheep.

This course in group dynamics teaches individuals to forget their individual personality and work for "the good of the whole". In Tavistock's own words; "this presents participants with opportunities for increasing their understanding of group process, with particular emphasis on covert dynamics which occur in groups with regard to issues of authority, leadership and

followership. The focus of the staff is in exercising authority based on power". Chilling words for those of us who value liberty.

The sinister implication is obvious; once we like sheep have been programmed to act like mindless beings, we will follow the leaders and blindly accept authority. If enough of us accept the new automated cashless society, and live with a card instead of cash, the globalists will have taken a giant step toward breaking down the U.S. Constitution and the institutions upon which this republic's foundations rest.

Resistance will decrease as soon as we have become accustomed to the system, and it will be a relatively easy matter to identify those of us who refuse to become a part of it. But being brainwashed to accept authority over personal freedom, the momentum toward a collision between the need for individual freedom based on a secured right to privacy and a central automated authority, is gaining speed.

Fundamental differences can never be reconciled, anymore than we can be reconciled to living with the Federal Reserve Board swindle.

Computerized pattern recognition techniques, already in existence, have opened the doors wide to secret mass surveillance, which at present is with us in covert form, but which by the mid 1990's, it is highly possible that each individual in this nation will be obliged to carry a card similar to the Soviet "internal passport".

This card will be used for every conceivable transaction. No transaction will be possible without it. Is this card the "mark of the beast?" Perhaps it will not be called that, but whatever it is called, it will be an unprecedented threat to freedom and justice, liberty for all.

The very latest intelligence information is that President Bush will make a major effort to require an identification card bearing machine-readable internationally identifiable numbers not visible to the naked eye for every citizen. Everything will be embodied in that card.

South Africa of all countries has successfully shown the way. Each citizen is required to obtain and present on demand his or her "book of life", which contains every detail from the day of birth, even his driver licence number. Such a card instantly identifies one. By adding fingerprints and a voice print (remember the musical Christmas cards?), every person can be identified, especially if it is linked to the 666 computer in Brussels, Belgium. I expect to see this linked to every "authority" computer bank in the world, without regard to national boundaries or nationality.

There is already strong pressure on the US Congress to upgrade driver licences. As Brzezinski put it, and I previously quoted this as far back as 1982: "The instantaneous electronic intermeshing of mankind will make for intense confrontation, strained social peace".

Unfortunately the average individual knows little and cares even less about technology as it relates to politics and people control. It seems to me that the attitude toward such a card will be "so what", as long as it is possible to buy what is needed, watch football and hold down a good job, "so what". The convenience of the card, with which he is familiar, thanks to broadsides of propaganda, will override any anxiety we may have over this "people control" device.

Those who have an understanding of the vast ramifications this card will bring, will be quickly isolated and probably rounded up, henceforth "outlaws" in the very real meaning of the word.

"Trend makers" have been conditioning us, since the advent of the Beatles followed by widespread usage of marijuana, cocaine and deviant sexual behavior, female aggressiveness, Dr. Spock and so on. Trend makers are usually portrayed as young, attractive and successful. They are what I call "travel poster types" widely used to promote air travel or vacation spots.

In the scores of years I have travelled around the world by air, I have never yet come across any real life "travel poster types" among my fellow passengers. Trend makers is an illusion

compatible with those travel poster types.

Older people are never used in "trend maker" advertising. Older people react strongly to change and an acceleration of change. There is a connection here between what Mr. Joseph Califano proposes for America's aged, and the wholesale marketing of euthenasia.

Since older people are strongly resistant to change, the older people must be got rid of. This conclusion is based on a top-secret report, a copy of which was loaned to me for a few hours. Let me assure you that what I have just stated about getting rid of the elderly is fact, and not fiction.

Human behavior follows attraction or repulsion toward the pace of life forced on individuals by society or some other group. This is where Tavistock's group authority comes into play. Most of us will be swept along by "group thinking". It happened recently in the 1988 election. We went along with the group and voted for a man many of us knew to be unsuitable to fill the vacancy in the White House.

Trend makers have a specific target for future shocks change, and that target is the family. Transience has already weakened the most important unit in Christian society.

We develop a relationship with our family, which today is being derided. Our throw away society mentality where nothing is built to last; "don't fix it, throw it away and buy a new one" has reached into our family life. The throw away mentality of economic impermanence is reaching into marriages. It was designed to do so by the men at Tavistock, Eric Trist, Kurt Lewin and his associates.

In 1980 I revealed what the Age of Aquarius-New Age was all about. In an audio-cassette, I told of what Brzezinski had in mind for us for our future, and I think it is well worth quoting again, because of its great significance and uncanny accuracy of his prophecy: "Finally, looking ahead to the end of this century, the possibility of biochemical mind control and genetic tinkering with man, including eventually, the creation of beings that will function like men, and reason like them as well, could give rise to the most difficult questions".

In 1865 a journalist wrote as follows: "Well-informed people know that it is impossible to transmit human words over wires for long distances and that were it possible to do so, the thing would be of no practical value." Just look at how far we have come since then. What was unthinkable in 1865 is commonplace today. What is unthinkable in 1989 might well be commonplace by the year 2000 according to Brzezinski, and I have no quarrel with that.

The globalists are creating a new society, not merely changing it. The bio-factory turning out human embryos is here. In 1962 Dr.'s Krick and Watson received the Nobel Prize for DNA research, and from then on, molecular biology research has exploded.

New genetic information permits us to "tinker" (Brzezinski's word), with human heredity, and manipulate genes to create a new man. This is political dynamite. Scientist Joshua Lederberg says "cloning is already being done with animals", and he suspects with people too. "It won't surprise me if it comes any day now" he added. "But cloning man will come within the next 15 years". Scientists are at this moment discovering how various body organs work, and experiments to modify body organs is already at an advanced stage. The USSR and Stanford Research are busily engaged in experiments to modify human organs, especially the brain and its sensory qualities, and even growing brains. This will be brought under direct development control. The Hinckley, "Son of Sam", Jim Jones experiments were the beginnings of this period of experimentation.

I have seen a copy of the report on just how far these experiments have progressed, and it has chilling overtones. The experiments are going on right now. In order to distract our attention away from this research, we have a whole lot of misguided people agitating against lab experiments with animals, and pouring red paint over fur coats, while they look the other way as aborted babies in their millions silently scream in agonizing pain ending in death. Truly, we have been conditioned.

There is a biological revolution going on, and it is rapidly gathering momentum. Dr. E. Hafez of Washington State University says that based on his own research, a new form of slavery (my words), is going to be common-place within the next 15 years.

Biological factories will sell frozen embryos. The potential "mother" will purchase the embryos and have it implanted in her womb, having received an absolute guarantee that the "baby" when it comes will be strictly according to her description; color of eyes, hair and the sex of the child and its I.Q.

Dr. Daniel Petruchi, a noted scientist in this field, says it will soon be possible to "raise" such children outside the womb. The impact of such "births" can only be vaguely comprehended at this time.

Family life as we know it, will disappear, our traditions of motherhood, parenthood, child-rearing, education, relatives - no more grandpa and grandma, sexuality are going to be subjected to the severest of strains. The equivalent of the atom bomb is soon to be dropped on the family unit in society.

The moral and ethical choices we will have to make in the category of future shocks, and worse than that, (morals won't come into it) will be in the political arena!

We are at the point where selective breeding is totally possible. Races and super-races, the thing we roundly condemned Hitler for, will in future be acceptable. Given the absolute reality to tailor race to preplanned specifications, will there be superior or inferior classes?

Are we on the threshold of a class of people especially bred to serve a "super-race"? If this comes about, the negro and hybrid races face extinction. The pretended concern for the welfare of the colored races will be revealed in all of its ugliness. They will probably find that as far as the majority is concerned, the classification will read "slave type".

Above the slave class will be a class of a higher order to run things, and docilely serve the super-elite; the Rockefellers and Gorbachevs of this world, i.e. the top echelon membership of the One World Government and their bureaucracy.

The problem of bringing this all out in the open now, is not one of fearing failure from scientific and or technical difficulties; it is one political choice. Ethics do not come into the equation. Family life as we know it will become extinct. According to Dr. Hutchins of the Rockefeller Institute, many of us are going to feel an instinctive revulsion over the meddling with finely balanced far-reaching body systems that make an individual an individual and what he becomes.

Dr. Hutchins said; "Yes, it will be done or attempted. The pathway will be built from a combination of altruism and private profit". Compare this with the predictions of Brzezinski: "Finally looking ahead to the end of this century, the possibility of bio-chemical mind control and genetic tinkering with man, including eventually the creation of beings that will function like men and reason like them as well, could give rise to the most difficult questions".

With Brzezinski in the Bush cabinet, no doubt he will be engaging his attention to finding answers to those "difficult questions". He also talked about super intellectuals, super elite and world super culture.

If this challenge to our Christian way of life and especially the family unit is to be met, then there needs to be a dramatic and immediate response to those who seek to destroy us as individuals. Changes must first be moderated, brought under control and then regulated. Rampant unrestrained change must be brought to a halt. When that condition prevails, we can turn our attention to eliminating the ideology of future shocks, a term invented to cover unrestrained changes unleashed in rapid-fire to overwhelm us, so that like the soldier who fell asleep in the midst of battle, because he did not know what to do amid the hailstorm of machine gun bullets, we too will succumb

to apathy.

Instead of teaching relatively useless subjects in our schools and universities, our children and young people ought to have instruction which will prepare them to cope with future shocks; to be good soldiers, spiritually strong enough to withstand the shock of wild changes. If we do not begin now to resist this evil with all of our might, we are going to be relatively easy targets for future shock induction into a One World Government.

*Supplementary Sociological Reading Material -----*                      *From "Behold a Pale Horse" by William Cooper:*

*Chapter 1: Silent Weapons for Quiet Wars*  
*Chapter 2: Secret Societies and the New World Order*  
*Chapter 4: Secret Treaty of Verona*  
*Chapter 5: Good-bye USA, Hello New World Order*  
*Chapter 6: H.R.4079 and FEMA*  
*Chapter 7: Anti-Drug Abuse Act of 1988/H.R.6210  
and Public Law 100-690*  
*Chapter 8: Are the Sheep Ready to Sheer?*  
*Chapter 12: The Secret Government*  
*Chapter 13: Treason in High Places*  
*Chapter 17: U.S.Army Intelligence Connections With the  
Satanic Church*  
*Appendix E: New World Order*  
*Appendix F: U.S.Government Drug Involvement*

*The above material represents additional source material relative to the NWO concept on a sociological level although it is viewed from a position of social consciousness using the lower three brain areas, and from that standpoint in consciousness it can be very fear/survival oriented. You must view it in terms of background material for the understanding of the drama on a cultural level; view it from a standpoint of higher consciousness that is not fear and survival oriented.*

# SILENT WEAPONS FOR QUIET WARS

## DIVERSION, THE PRIMARY STRATEGY

Experience has proven that the simplest method of securing a silent weapon and gaining control of the public is to keep the public undisciplined and ignorant of basic systems principles on the one hand, while keeping them confused, disorganized and distracted with matters of no real importance on the other hand.

This is achieved by:

(1) *disengaging their minds, sabotaging their mental activities, and providing a low quality program of public education in mathematics, logic, systems design, and economics, and by discouraging technical creativity.*

(2) *engaging their emotions, increasing their self indulgence and their indulgence in emotional and physical activities, by:*

(a) *unrelenting emotional affrontations and attacks (mental and emotional rape) by way of constant barrage of sex, violence, and wars in the media -- especially the T.V. and the newspapers.*

(b) *giving them what they desire -- in excess -- "junk food for thought" -- and depriving them of what they really need.*

3. *rewriting history and law and subjecting the public to the deviant creation, thus being able to shift their thinking from personal needs to highly fabricated outside priorities.*

## DIVERSION SUMMARY

**Media:** Keep the adult public attention diverted away from the real social issues, and captivated by matters of no real importance.

**Schools:** Keep the young public ignorant of real mathematics, real economics, real law, and real history.

**Entertainment:** Keep the public entertainment below a sixth grade level.

**Work:** Keep the public busy, busy, busy, with no time to think; back on the farm with the other animals.

## HISTORICAL INTRODUCTION

Silent weapon technology has evolved from Operations Research (O.R.), a strategic and tactical methodology developed under the military management in England during World War II. The original purpose of Operations Research was to study the strategic and tactical problems of air and land defense with the objective of effective use of limited military resources against foreign enemies (i.e., logistics).

It was soon recognized by those in positions of power that the same methods might be useful for totally controlling a society. But better tools were necessary.

Social engineering (the analysis and automation of a society) requires the correlation of great amounts of constantly changing economic information (data), so a high speed computerized data processing system was necessary which could race ahead of the society and predict when society would arrive for capitulation.

Relay computers were too slow, but the electronic computer, invented in 1946 by J. Presper Eckert and John W. Mauchly filled the bill.

The next breakthrough was the development of the simplex method of programming in 1947 by the mathematician George B. Dantzig.

Then in 1948, the transistor, invented by J. Bardeen, W.H. Brattain and W. Shockley, promised great expansion of the computer field by reducing space and power requirements.

With these three inventions under their direction, those in positions of power strongly suspected that it was possible for them to control the whole world with the push of a button.



## M A T R I X I I I

Immediately, the Rockefeller Foundation got in on the ground floor by making a four year grant to Harvard College, funding the Harvard economic research project for the study of the structure of the American economy. One year later, in 1949, the United States Air Force joined in.

In 1952 the original grant period terminated and a high level meeting of the elite was held to determine the next phase of the social operations research. The Harvard project had been very fruitful as is borne out by the publication of some of its results in 1953, suggesting the feasibility of economic (social) engineering. (*Studies in the Structure of the American Economy*-- copyright 1953 by Wassily Leontief, International sciences Press, Inc., White Plains, New York.)

Engineered in the last half decade of the 1940's the new Quiet War machine stood, so to speak in sparkling gold plated hardware on the showroom floor by 1954.

With the creation of the maser in 1954, the promise of unlocking unlimited sources of fusion atomic energy from heavy hydrogen in sea water and the consequent availability of unlimited social power became a possibility only decades away.

The combination was irresistible.

The Quiet War was quietly declared by the international elite at a meeting held in 1954.

Although the silent weapons system was nearly exposed 13 years later, the evolution of the new weapon system has never suffered any major setbacks.

This volume marks the 25th anniversary of the beginning of the Quiet War. Already this domestic war has had many victories on many fronts throughout the world.

## ACTION / OFFENSE

Most people want to be able to subdue and/or kill other human beings which disturb their daily lives, but they do not want to have to cope with the moral and religious issues which such an overt act on their part might raise. Therefore, they assign the dirty work to others (including their own children) so as to keep the blood off their own hands. They rave about the humane treatment of animals and then sit down to a delicious hamburger from a whitewashed slaughterhouse down the street and out of sight. But even more hypocritical, they pay taxes to finance a professional association of hit men collectively called politicians, and then complain about corruption in government.

## RESPONSIBILITY

Again, most people want to be free to do things (to explore, etc.) but they are afraid to fail.

The fear of failure is manifested in irresponsibility, and especially in delegating those personal responsibilities to others where success is uncertain or carries possible or created liabilities (law) which the person is not prepared to accept.

They want authority (root word -- "author"), but they will not accept responsibility or liability. So they hire politicians to face reality for them.

---

## SHORT LIST OF OUTPUTS

---

*Outputs --create controlled situations-- manipulation of the economy, hence society-- control by control of compensation and income.*

*Sequence:*

- (1) allocates opportunities.
- (2) destroys opportunities.
- (3) controls the economic environment.
- (4) controls the availability of raw materials.
- (5) controls capital.
- (6) controls bank rates.
- (7) controls the inflation of the currency.

## M A T R I X I I I

- (8) controls the possession of property.
- (9) controls industrial capacity.
- (10) controls manufacturing.
- (11) controls the availability of goods (commodities).
- (12) controls the prices of commodities.
- (13) controls services, the labor force, etc..
- (14) controls payments to government officials.
- (15) controls the legal functions
- (16) controls the personal data files -- uncorrectable by the party slandered.
- (17) controls advertising
- (18) controls media content
- (19) controls material available for T.V. viewing.
- (20) disengages attention from real issues.
- (21) engages emotions.
- (22) creates disorder, chaos, and insanity.
- (23) controls design of more probing tax forms.
- (24) controls surveillance.
- (25) controls the storage of information.
- (26) develops psychological analyses and profiles of individuals.
- (27) controls legal functions (repeat of 15)
- (28) controls sociological factors.
- (29) controls health options.
- (30) preys on weaknesses.
- (31) cripples strengths.
- (32) leaches wealth and substance.

*On July 7, 1986, an employee of the Boeing Aircraft company purchased an IBM copier at a surplus sale. Inside were details of a "science", hatched in the embryonic days of the "Cold War" which planned for control of the masses through the manipulation of industry, people's pastimes, education, and political leanings. It called for a quiet revolution putting brother against brother, and diverting the public attention from what was really going on. It had already been in operation since 1954.*

*The unknown author (or authors) showed how silent (economic) weapons would be used to subdue a nation to create a utopia for the elite while offering enslavement to the masses.*

*The document indicates the plan is well under way. This is a blueprint for your eventual enslavement and, according to the author, only if the masses become aware of the plan, is there hope for their escape.*

*Released to the public three years ago, the technical manual on the use of silent (economic) weapons for quiet warfare against the masses is presented here in its entirety.*

*It is heavy reading for sober minds to ponder. It is destined to become a powerful force in the hands of those who seek the truth.*

# THE CFR/TRILATERAL CONNECTION

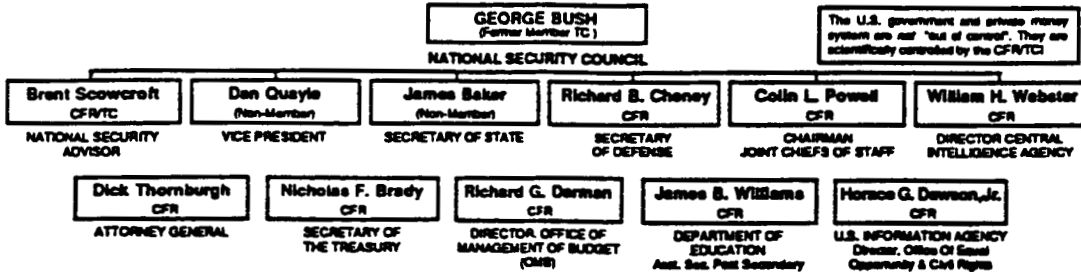

The U.S. government and private money systems are not "out of control". They are scientifically controlled by the CFR/TC!

### MEDIA

Past & Present CFR/TC Members (partial listing)

CBS		NEW YORK TIME CO.	
William Paley	CFR	Richard Galt	CFR
William S. Paley	CFR	James Rowan	CFR/TC
Robert G. Ripstein	CFR	William S. Paley	CFR/TC
James H. McGowan	CFR/TC	A.M. Rosenthal	CFR
Henry Schatz	CFR/TC	Seymour Topping	CFR
Marion T. Ross	CFR	James Greenfield	CFR
C.C. Collingwood	CFR	Max Frankel	CFR
Lorraine Lehman	CFR	Jack Rosenthal	CFR
Sam Rife	CFR	Harold S. Bennett	CFR
Harry Rosson	CFR	Orvil Dryden	CFR
Richard Harlow	CFR	David Hollander	CFR
Frank Stanton	CFR	Walter Lippmann	CFR
Bill Moyers	CFR	L.E. Morley	CFR
NBC/CA		TIME, INC.	
Jane Fonda	CFR	Ralph Davidson	CFR
Leslie Crystal	CFR	Donald M. Wilson	CFR
R.W. Sorenson	CFR	Luella Bamber	CFR
T.F. Sorenson	CFR	Henry Grunwald	CFR
John Perry	CFR	Alexander Heard	CFR
David Brinkley	CFR	Sol Uriswitz	CFR/TC
John Chancellor	CFR	Renezh Warrner, Jr.	CFR
Marvin Kalb	CFR	Thomas Watson, Jr.	CFR
Irving Lurie	CFR	NEWSWEEK/WASH POST	
H. Schaefer	CFR	Katherine Graham	CFR/TC
P.G. Peterson	CFR/TC	Philip Graham	CFR
John Scoville	CFR/TC	Arty Miller	TC
ABC		DOW JONES & CO.	
Ray Adam	CFR	William Agnew	CFR
Frank Cary	CFR	J. Paul Austin	TC
John Carter	CFR	Charles Meyer	CFR
T.H. Madden	CFR	Robert Porter	CFR
Ted Koppel	CFR	Richard Wood	CFR
John Scall	CFR	Robert Barbey	CFR/TC
Burton Witham	CFR	Karen Hesse	CFR
CABLE NEWS NETWORK		NATIONAL REVIEW	
David Seltzer	CFR	Wm. F. Buckley, Jr.	CFR
PUBLIC BROADCAST SERVICE		Richard Brookhiser	CFR
Harold Gurne	CFR	William Agnew	CFR
Robert Mitchell	CFR	J. Paul Austin	TC
Jim Lehrer	CFR	Charles Meyer	CFR
C. Hunter-Geist	CFR	Robert Porter	CFR
Harold Carter II	CFR	Richard Wood	CFR
Daniel Seltzer	CFR	Robert Barbey	CFR/TC
ASSOCIATED PRESS		Karen Hesse	CFR
Kerth Folger	CFR	Wm. F. Buckley, Jr.	CFR
Stanley Sussman	CFR	Richard Brookhiser	CFR
Luella Bamber	CFR	William Agnew	CFR
Harold Anderson	CFR	J. Paul Austin	TC
Katherine Graham	CFR/TC	Charles Meyer	CFR
U.P.I.		Robert Porter	CFR
M.L. Stevenson	CFR	Richard Wood	CFR
REUTERS		Robert Barbey	CFR/TC
Michael Posner	CFR	Karen Hesse	CFR
BOSTON GLOBE		WASHINGTON TIMES	
David Rogers	CFR	Henry Tinsmith	CFR
L.A. TIMES CHRONICLE		Arnold de Borchgrave	CFR
Joseph Kraft	CFR/TC		
BALTIMORE SUN			
Henry Tinsmith	CFR		

**NOTE:** The "New World Order" views of Rockefeller, Kissinger, Brantstam and others in the CFR/TC "inner circle" are not shared by all members. Some join for prestige and to further their careers. Some are invited in for "technical advisory". All Americans should closely examine the disastrous results of foreign and domestic policy formulated and implemented by the CFR through the years without public knowledge.

### U.S. MILITARY

Past & Present CFR/TC Members (partial listing)

ALLIED SUPREME COMMANDERS		SUPERINTENDENTS U.S. MILITARY ACADEMY AT WEST POINT	
48-52 Eisenhower	CFR	60-63 Westmoreland	CFR
52-55 Ridgway	CFR	63-66 LeMay	CFR
55-58 Gault	CFR	66-69 Banfill	CFR
58-61 Harnet	CFR	70-74 Kissinger	CFR
60-63 LeMay	CFR	74-77 Barry	CFR
63-66 LeMay	CFR	77-81 Gault	CFR
66-74 Gault	CFR	PRESIDENT, NATIONAL DEFENSE UNIVERSITY	
74-78 Hoag	CFR	L. Galt	CFR
78-87 Rogers	CFR/TC	SECRETARY OF THE NAVY	
SECRETARIES OF DEFENSE		John Lehman, Jr.	CFR
57-59 McNamara	CFR	SECRETARY OF THE AIR FORCE	
59-61 Galt	CFR	Donald B. Rice	CFR
61-65 McHarris	CFR/TC	JOINT CHIEF	
65-73 Laird	CFR	Gen. Wash - USAF	CFR
73-75 Richardson	CFR/TC	Admiral Tamm - Navy	CFR
75-77 Rumsfeld	CFR	ADDITIONAL MILITARY	
77-80 Brown	CFR/TC	MG R.C. Barrow	CFR
80-88 Weinberger	CFR/TC	SG F. Brown	CFR
88-90 Carlucci	CFR	LT COL. W. Clark	CFR
89-90 Cheney	CFR	ADM Wm. Clegg	CFR
UNDER SEC. OF DEFENSE		COL P. Deane	CFR
Freid Bilo	CFR	VADM Ther Hansen	CFR
GEN. Sillard (Ret.)	CFR	COL W. Hester	CFR
ARMY		MAJ R. Krome	CFR
Frederic J. Brown, Jr.	CFR	GEN W. Kravitz	CFR
CG Fourth Army		GEN W. Kravitz	CFR
AIR FORCE		WADM J. Lee	CFR
Gen. Chas SAC	CFR	COL D. Mand	CFR
MILITARY FELLOWS		MG Jack Morris	CFR
Vvny LG S. Barry	CFR	GEN E. Meyer	CFR
Army MG Z. Bradford	CFR	COL Wm. E. Odom	CFR
AF COL E. Costa	CFR	COL L. Chay	CFR
Army LG R. Galt	CFR	COL Gen. K. Odom	CFR
AF MG R. Galt	CFR	MG J. Patten	CFR
Navy CAP R. Keith	CFR	LG E.L. Reamy	CFR
AF Lt. COL J. Levy	CFR	CAPT Gary Sick	CFR
AF MG W. Usher	CFR	MG Du Wm. Smith	CFR
JOINT STAFF		SG Perry Smith	CFR
VADM Ther Hansen	CFR	LTD Wm. Y. Smith	CFR
LG Paul Gorman	CFR	COL W. Taylor	CFR
		ADM S. Turner	CFR
		MG J. Welch	CFR
		GEN J. Wickham	CFR

### CFR INFLUENCE IN THE SMITHSONIAN INSTITUTE

Robert MacCordell Adams, (Secretary)	CFR
Anna L. Armstrong, (Ed. of Reports)	CFR
William J. Barrow, Jr. - (Chmn., Ed of Trustees)	CFR
William Wilson International Center For Scholars	
William G. Brown, (Ed of Reports)	CFR
Robert P. Davidson, (Chmn., John F. Kennedy Center For Performing Arts)	CFR
Murray Gott-Mann, (Ed of Reports)	CFR
Daniel P. Meyerson, (Ed of Reports)	CFR
John R. Stevenson, (Pres. National Gallery of Art)	CFR

\* CFR indicates past or present membership in the Council on Foreign Relations.  
 \* TC indicates past or present membership in the Trilateral Commission.

The Trilateral Commission is international (used) intended to be the vehicle for multinational consolidation of the commercial and banking interests by setting control of the political government of the United States. WITH NO APOLOGUES. Senator Barry Goldwater

The Council on Foreign Relations is the American Branch of a society which originated in England (and) believes national boundaries should be obliterated and one world rule established.



# SKULL AND BONES SOCIETY COVER-UP?

The two biggest scandals to hit the news in years involve the BCCI banking mess and the so-called "October Surprise." The latter involves Ronald Reagan's pal William Casey, alleged to have made a secret deal in 1980 with Iran's Ayatollah Khomei. Under the terms of this bargain, Iran was to keep the U.S. hostages held at the U.S. Embassy in Teheran in chains until after Reagan could be elected and inaugurated as president.

The failure of the international, pro-terrorist BCCI Bank involves some very big names among the Council on Foreign Relations (CFR) and the Trilateral Commission (TLC) crowd, including top lobbyist Clark Clifford, Clifford, former Secretary of Defense, is a Washington D.C. attorney who oversees a number of CFR/TLC accounts.

My inside research shows clearly that the men of The Order are behind both the BCCI bank failure and President Reagan's campaign shenanigans. If the complete truth were to get out, things could really unwind. President George Bush, who knew much more than he's letting on, might even end up the way predecessor Richard Nixon did.

Not to worry. To the rescue come two comrades of The Order, U.S. Senators John Kerry (Massachusetts) and Terry Sanford (North Carolina). Kerry, like Bush a fellow of Yale's secret society, the Skull & Bones, is the Senate's choice to look into the BCCI crookedness.

As head of the Senate's Subcommittee on Terrorism, Narcotics, and International Operations, Skull & Bones brother Kerry will be putting on a big public front of "seriously" probing into the money scandal. But insiders know better.

In 1989, Senator Kerry and his subcommittee were first given the task of "probing" BCCI. But, as *Newsweek* magazine (Aug. 12, 1991) recently noted, Kerry "has been criticized for not having pursued the scandal more aggressively." That's putting it mildly. In fact, after first making a few obligatory revelations about potential wrong-doing by the bank, Kerry's committee stumbled all over themselves to slow and finally shelve the investigation.

The magazine asserts that Kerry soft-pedaled the probe after certain, unnamed officials let him know "through the grapevine" that an intensive investigation was undesirable. Thus, a cover-up was begun.

Meanwhile, the Senate leadership chose Senator Terry Sanford to head up the investigation of the Reagan/Casey "arms for hostages" swap. Sanford is a CFR/TLC man with impeccable globalist credentials.

The only committee of Congress more intimately knowledgeable of the BCCI and Reagan/Casey/Iran scandals than those led by Sanford and Kerry is the Senate Intelligence Committee, headed by Senator David Boren of Oklahoma. But, surprise of surprises, Senator Boren also just happens to be a member of the occultic Skull & Bones Society. This is fondly called stacking the deck in one's favor, or better yet, it should be labeled what it is: a cover-up.

What all this means can be put simply: Expect a lot of smoke and very little action from our Congress on these matters. They don't want the truth to come out, and as long as the boys of the CFR/TLC and Skull & Bones are in charge, believe me, it won't!



Senator John Kerry

## Skull and spare ribs

NEW HAVEN

**G**EORGE BUSH is gender-correct. Last week, Skull and Bones, the oldest and most celebrated secret society at Yale, decided to admit women into the club that claims Mr Bush as a member. Do not expect him to mention it: he will adhere to the club's legendary code of silence as he did during the manoeuvring that preceded last week's decision.

Founded in 1832, Skull and Bones recruited the "best and brightest" at Yale. Membership means adopting a secret name, dining at the club's "tomb" and taking part in such rituals as recounting one's autobiography and—reputedly—sexual history while lying naked in a coffin. Fewer than 200 of the university's 1,300 last-year students belong to similar societies. Now only "Wolf's Head"—which claims Benno Schmidt, Yale's president, as a member—remains all-male.

For the price of male bonding is high. The best and brightest, particularly those going into politics, find that they cannot afford to sully their reputations with membership of a single-sex club. But the Bones club's decision to mend its ways took six months of wrangling.

Outgoing members chose six women and nine men as their successors; the first response of the club's governing board was to close the tomb. A postal vote of the club's 800 surviving members narrowly endorsed the admission of women. Disgruntled members spoilt plans for a September initiation by filing charges that the vote failed to comply

with Bones's bye-laws. Among the plaintiffs was a Washington lawyer who insisted that the admission of women would lead to "date rape" in the "medium-term future".

The suit was settled when the club agreed to another vote, held as a shareholders' meeting. More than 425 members came to the tomb to vote last week; the others voted by proxy. Two Democratic senators, David Boren and John Kerry, favoured admitting women. Mr Bush did not disclose his preference.



EXTRA! EXCLUSIVE:

Mar/Apr 1990

# CIA Chief Bush Suppresses the News

By Robert Gardner

Documents obtained by FAIR, released through the Freedom of Information Act (FOIA), show that George Bush, as head of the CIA in 1976, tried to bottle up a news story that exposed the apparent duplicity of another former CIA chief, Richard Helms.

The story, broken on Oct. 1, 1976, by David Martin (now CBS Pentagon correspondent, then with Associated Press), revealed that Helms had given misleading testimony to the Warren Commission investigating the assassination of John Kennedy. Helms testified that the CIA had not "even contemplated" making contact with Lee Harvey Oswald, the accused assassin. Through the FOIA, Martin obtained CIA memos showing that in 1960 the agency "showed intelligence interest" in Oswald and "discussed...the laying on of interviews" with him.

When Bush saw the AP story in the Washington Star, he asked for an internal CIA review to see if the story was true (it was) and if it would "cause problems for Helms." (Helms had lied to a Senate committee about the CIA's

role in subverting Chilean democracy and would later be convicted of contempt of Congress.)

After investigating, Bush assistant Seymour Bolten reported back that the exposure of Helms' false testimony to the Warren Commission would probably cause Helms "some anxious moments," though not "any additional legal problems." But Bush was assured that a "slightly better" story had resulted from an Agency phone call to AP protesting that Martin's story was "sloppy." Additionally, Bush was told that an unnamed journalist had "advised his editors...not to run the AP story."

Bolten complained to Bush: "This is another example where material provided to the press and public in response to an FOIA request is exploited mischievously and in distorted form to make the headlines." One might more accurately describe it as an occasion where George Bush's CIA pressured one news outlet to back away from an accurate story while using an asset in the press corps to suppress it in another. □

## CIA Guidelines on Contacts with Journalists

Stung by revelations in the 70s about the CIA's hiring of journalists as spies, the Agency drafted regulations supposedly designed to prevent such practices. Researcher Robert Gardner obtained a copy of the CIA policy—"Relations With Journalists and Staff of US News Media Organizations"—and found that it contains loopholes big enough to drive truckloads of contra aid through.

The rules prohibit "relationships" with journalists accredited by U.S. media outlets, or the use of these outlets names for intelligence purposes. The policy does not prohibit the hiring of freelance journalists, and it allows the CIA to recruit "nonjournalist staff employees" (librarians? sound technicians and cameramen?) of media outlets if authorization is given by senior media management.

The policy also asserts that "no person, including full-time or part-time accredited journalists and stringers, will be denied the opportunity to furnish information which may be useful to the U.S. Government. Therefore, unpaid relationships with journalists...who voluntarily maintain contact for the purpose of providing information" are kosher. What better way for a reporter to sweeten a foreign beat than by cozying up to the local CIA officer and swapping stories?

The final paragraph of the guidelines, titled "Exceptions," seems to swallow up the policy's few limits: "No exceptions to the policies and prohibitions stated above may be made except with the specific approval of the Director." In approving exceptions, future CIA chiefs might apply this rule of thumb: What would William Casey have done in my shoes?

## CENSORED STORY:

### CIA Links to the Savings & Loan Scandal

The massive fraud that lies behind the collapse of the Savings & Loan industry has always been underreported. Beginning Feb. 4, an enterprising reporter for the Houston Post started turning out a groundbreaking series that suggests the Central Intelligence Agency was involved in some of this fraud—with a cost to the taxpayer in the billions. When will the rest of the media pick up the story?

Reporter Pete Brewton's investigation implicated the CIA and organized crime in the failure of 22 S&Ls. Sources told the Houston Post that "the CIA may have used part of the proceeds from S&L fraud to help pay for covert operations," including possible support for the Nicaraguan contras. The collapse of looted S&Ls with mob and CIA ties will cost the government an estimated \$13 billion (2/4/90).

The ongoing series has documented CIA interference in fraud prosecutions (2/8/90), and the involvement of President Bush's son Neil with a mob-linked thrift (3/11/90). The Post's research has led the House Intelligence Committee to launch an investigation of its own.

But national media have done little to bring this story to the public. "I can't think of a single investigative breaking story that they've done on what caused the S & L crisis," Brewton told FAIR. "The papers that have the resources to really dig into this haven't been there. It's very disappointing."

FAIR's representatives brought up the S&L/CIA story in separate meetings with Washington Post foreign editors (2/21/90) and the New York Times publisher (3/14/90); they had not yet heard about it.

# DEA report links CIA with Mexican drugs

Los Angeles Times/Washington Post News Service and Associated Press

LOS ANGELES — The CIA trained Guatemalan guerrillas at a Mexican ranch owned by a drug lord convicted in the murder of U.S. drug agent Enrique Camarena, a federal report says.

But the Drug Enforcement Administration report does not detail why the guerrillas were being trained, nor whether the Central Intelligence Agency knew who owned the ranch.

The CIA denied the report, which appeared in the Los Angeles Times today.

"The whole story is nonsense," agency spokesman Mark Mansfield said today. "We have not trained Guatemalan guerrillas on that ranch or anywhere else."

"The CIA does not engage in drug-running activities," he said Wednesday.

The report, completed in February, said the Guatemalan guerrillas were trained during the early 1980s at a ranch near Veracruz owned by Rafael Caro Quintero.

The DEA report does not state specifically whether CIA officials knew who owned the ranch where the Guatemalans were being trained, why Guatemalans were being trained or whether marijuana was being grown there.

It is based on an interview of two Los Angeles-based DEA agents that was conducted with Laurence Victor Harrison, a shadowy figure who, according to court testimony, ran a communications network for major Mexican drug traffickers and their allies in Mexican law enforce-

ment in the early and mid-1980s.

On Feb. 9, according to the report, Harrison told DEA agents Hector Berrellez and Wayne Schmidt that the CIA used Mexico's Federal Security Directorate "as a cover, in the event any questions were raised as to who was running the training operation."

Harrison also said that "representatives of the DFS, which was the front for the training camp, were in fact acting in concert with major drug overlords to insure a flow of narcotics through Mexico into the United States."

At some point between 1981 and 1984, Harrison said, "members of the Mexican Federal Judicial Police arrived at the ranch while on a separate narcotics investigation and were confronted by the guerrillas. As a result of the confrontation, 19 (Mexican police) agents were killed.

Many of the bodies showed signs of torture."

Caro and two other men are serving prison terms in Mexico for their roles in the 1985 torture-murder of Camarena and his pilot in Guadalajara. Four other men are on trial in Los Angeles over their alleged involvement in the slaying.

The DEA report became available in Los Angeles on Tuesday night after U.S. District Judge Edward Rafeedie ordered prosecutors to turn the information over to the defense, the Times said.

In a separate interview Sept. 11, 1989, Harrison told the same two DEA agents that CIA operations personnel had stayed at the home of Ernesto Fonseca Carrillo, one of Mexico's other major drug kingpins and an ally of Caro. The report does not specify a date on which this occurred.

Harrison testified at the Camarena murder trial that he lived at Fonseca's house for several months in 1983 and 1984 when he was installing radio systems for the drug lord.

Representative Jack Brooks:

Colonel North, in your work at the N.S.C., were you not assigned, at one time, to work on plans for the continuity of government in the event of a major disaster?

Brendan Sullivan (North's Counsel):  
Mr. Chairman?

Senator Daniel Inouye: I believe that question touches upon a highly sensitive and classified area so may I request that you not touch upon that?

Representative Brooks: I was particularly concerned, Mr. Chairman, because I read in Miami papers, and several others, that there had been a plan developed, by that same agency, a contingency plan in the event of emergency, that would suspend the American Constitution. And I was deeply concerned about it and wondered if that was the area in which he had worked. I believe that it was and I wanted to get his confirmation.

Senator Inouye: May I most respectfully request that that matter not be touched upon, at this stage. If we wish to get into this, I'm certain arrangements can be made for an executive session.

(From the transcript of the Iran-Contra hearings, July 13, 1987)

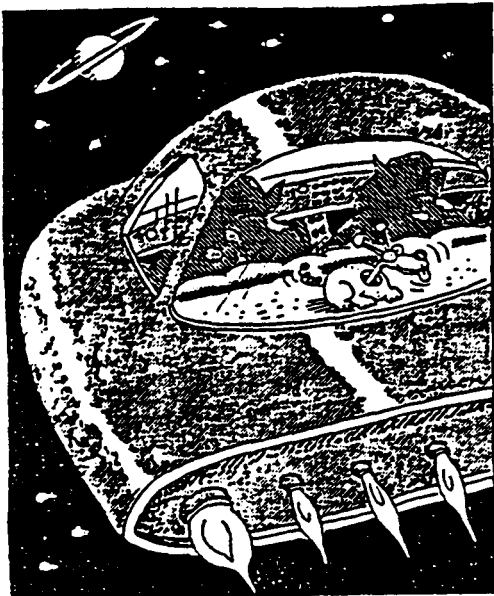

# LOVING AMERICA TO DEATH

## AN INTERVIEW WITH KC DEPASS

**While the world seems to be growing more democratic, leaders in our own country are quietly creating a totalitarian police state in the good ol' US of A.**

BY A. L. RAWE

**K**C dePass believes that "the men who are running our local, state, and federal governments have a plan afoot that the American people have absolutely no idea about." DePass (aka Craig Hulet), is a political researcher who spent 13 years as a consultant to multinational corporations and five years as director of a small think tank. He now devotes his time to the research and publication of "White Papers," treatises prepared by consultants based solely upon documented fact, which analyze social and political events.

**Common Ground:** You've published white papers covering a wide variety of topics: the war on drugs, Vietnam, Kennedy's death, the Persian Gulf war, AIDS, racism, etc. How do you go about your research?

**KC dePass:** I have some doctors, lawyers, business people and retired intelligence officers, interestingly enough, who send me material on an on-going basis, all year around, that they've either discovered or that was classified. It's a network of people from different levels. I take their research and reduce it to a composite that will be useful to the public and put it in a White Paper. That's why my White Papers are so big, they have so many exhibits copied out of the law and stuff. I want people to take the White Papers and not read it as a book I've written and trust me. I want them to take the material and use it as research material, or as proof for their mother and father and friends.

**CG:** I read that your Middle East White Paper has been translated into ten foreign languages and that you've gotten a lot of notice for your analysis of the Persian Gulf war. *The Seattle Times* printed an article in January 1991 which said that you didn't believe the war was about democracy or even oil, but that it was about money. What do you mean?

**dePass:** The political objective of the Bush Administration in the Persian Gulf war was to do exactly what they're doing today. The policy formation you see went back to April 1990 in a task force report that specifically said they had to get the U.N. security council to disarm Iraq and force a peace conference between Israel and Syria. And that is exactly what they did. I was right on the money about that. But that isn't because I'm a prophet, it's because I read

documents before they implemented the policy. Unfortunately, the only way to bring the U.N. Security Council together, to bring England, France, Germany, and Japan all on stream so quickly and allow George Bush to quite literally bomb a third world developing country into the stone age, was through the al Sabbah's family financial holdings in the United States, Britain, Japan, and Germany. Worldwide, it's now known that the assets of the al Sabbah family alone is at least a trillion dollars, three hundred billion just in the U.S. The most embarrassing fact is that the person we were putting back into power in Kuwait was less a petty dictator than a corporate director of a U.S. corporation called Santa Fe International, an oil drilling firm. Sitting on the board of that corporation was Brent Scowcroft, former president Gerald Ford, and Carla Hills, our trade representative under the Bush administration, and her husband, Roderick Hills.

When you put these connections together and you realize George Bush is a banker and an oilman, Jim Baker is a banker and an oil man, William Webster is a banker and an oil man, and on down the list all the way back to the 1940's, our entire cabinet are corporate businessmen, you know—this isn't about putting a political entity back in power. They're putting back in power one of their businessmen, someone they do business with. And then you realize that there's something very wrong with our government when our policy is dictated by the corporate interests of private enterprise.

There's nothing like democracy going on here. Has anybody brought up the subject of democracy in Kuwait? No. al Sabbah is a feudalistic dictator, not a democratic ally. The same charges that were

made against Saddam Hussein's dictatorship by Amnesty International were made against al Sabbah in Kuwait.

The new world order is about money, business, monetary policy, and raw materials. It has nothing to do with politics the way the American people have been raised to believe politics work. We lost that in 1945. That's gone. It's about money and business.

**CG:** I imagine your theory is overwhelming, even frightening, to many people. Does the press, perhaps influenced by the government, hide stuff like this? Or do you think the American people just don't want to know?

**dePass:** That's the question. We ask that just about every morning. There's a part of me that doesn't believe the American people want to know. See, we don't have a controlled press, we do have a contrivance on the part of the press, we have some collusions since so many newspapers use the same wire service and they just parrot it. But I believe that if the American people wanted to know, really wanted to know, factual, hard-hitting and very often bad news, the press would tell them. I can't believe the press wouldn't print it if it was in their financial interest to do so. And I know too many people that tell me they skim the headlines of the front page and then go straight to the sports page or the comics and basically they don't care what's going on. So the voyeurism is there. Like when the Anita Hill and Judge Thomas show dominated the press, incredible information about the S&L, BCCI and AIDS was relegated to nowhere in the *New York Times*. But the press gave them what they wanted. How can you criticize a free press if you believe in it for giving the people what they demand?



CG: So would you say the American people are asleep or apathetic?

dePass: Well it's tremendously discouraging. But I don't believe they're asleep at all, and I don't think it's apathy. If you watch the speed and skill with which they drive on the freeways you know they're not asleep, and if you damage their property or kick their dog or kick them off a business deal, then there's a tremendous amount of high energy in the American people. Just watch a football game. The energy is there. The strength is there. The will is there. It's just directed at self-interest. And I think that's because, quite simply, it's an affluent society and it's made us a very arrogant society.

People only worry about things that affect them directly, personally. You have to learn to care about your neighbor—black, white, male, female, homosexual, heterosexual, you have to care about something other than yourself. Because what the government is doing presently is destroying the infrastructure of a people, a nation. They're taking your neighbors to work



THE WORST PART OF IT IS THE  
AMERICAN PEOPLE AREN'T  
PAYING ATTENTION. WE'RE  
THE ENEMY NOW. THE U.S.  
ARMY CAN NOW BE USED  
AGAINST THE AMERICAN  
PEOPLE, LEGALLY, BY LAW.  
AND THEY'RE DOING IT.  
THAT'S GEORGE BUSH'S  
NEW WORLD ORDER.



camps, right now as we speak. And I can't stand that.

CG: What do you mean by work camps?

dePass: This isn't a myth, it's in public law. It isn't a supposition, it isn't a left wing or spotlight newspaper analysis. It is a fact of our own public administration. What's happened is the federal government has passed laws going back to 1986 to close military bases. Public law #99570. Two years later in the '88 drug law, #101690, they authorized studies to look at the involuntary confinement of the mentally ill, then redefined drug use as being a sign of mental illness, so if you smoke marijuana they can confine you. In the 1989 defense

authorization act, they turned the drug war over to the Pentagon. And they culled from the '88 drug law to give the Pentagon the power to establish work details for those people put on the military bases under "boot camps." While this is going on in Federal law, states are being coerced in the 1986 and '88 drug laws: if they don't adopt these laws at the state level, they will lose highway funding. So 19 states established boot camps before it became legal at the federal level to actually close the military bases and establish the boot camps, which they only did seven months ago—in the new drug and crime bill that just passed in the House and Senate. The Senate bill number was 1241 and the House bill was 3371. Well they just passed it in a joint conference committee. They're going to close ten military bases, turn them into federal boot camps and turn the prisoners over to the Pentagon for work programs. Now there are congressmen and senators saying let's put the homeless there. They want to put the homeless there; they want to put illegal aliens in separate camps. They are also looking very seriously at AIDS camps, in the future. If the AIDS epidemic runs its course, by the year 2000 approximately one and a half million to three million people will have died of AIDS, and they plan on taking the remainder, which may be as many as ten million HIV positive that are dying, and putting them in separate camps. In the end, it's a tremendous cross-section of our American culture, and your personal opinions and biases are not what matters here. We are literally talking about a Weimar Republic conversion of America into the Fourth Reich. And nobody gives a damn.

CG: Are you suggesting selective depopulation? What is the purpose of these camps?

dePass: Well, they're not converting these military bases into work camps out of some benign aspect of rehabilitation. They're taking the anti-social element of society, in George Bush's own vernacular, and placing them in concentration camps. Now I'm not calling them death camps. I'm calling them a concentration, in camps, of a population that has become undesirable to the American people. And this is not a conspiracy theory. It's in the laws. I presented this on Mike Siegel's radio show and the vast majority of people in Seattle said I was out of my mind. But Mike would tell them, he's reading from federal law, he's not making this up, he's reading it from the law itself, laws to close military bases and turn them into detention centers.

CG: What will happen in the camps?

dePass: Well, who do you think is going to plant George Bush's one billion trees? You're going to pay for them as taxpayers and these people are going to plant them. Immediately an environmentalist will say, "Well I don't have a problem with that." What a minute. We're talking about slavery here, people. Arresting people for a first time drug offense, marijuana,

putting them in a work camp, making them work for the Pentagon to plant trees and you say it's OK? I like the idea of planting trees. You go plant them.

But it gets worse. In the *New York Times*, August 5th, 1991, headline, front page: "Military has new strategic goal in clean-up of vast toxic waste." Well, who do you think is going to be cleaning up, on site, the toxic waste? G.E. employees? Central forces personnel? The highly trained civil engineers? Of the military? I don't think so. Somebody's got to be on-site, wearing the machinery and collecting the glowing purple sludge. There's no technology that does it, people have to do it. Well who's gonna do it? Nobody wants to hear it because that's an incredibly ugly prophesy, but I didn't see it in a crystal ball. It was on the front page of the *New York Times*. And to me that means this has to stop.

The worst part of it is the American people aren't paying attention. The military has been turned inward against the American people. It's us that are the enemy now. Drug users, AIDS victims, the homeless, cleaning up toxic dumps. We're the enemy. There's now an internal enemy of the state just like the Jews were the internal enemy of the German Republic. Well we have an internal enemy and the army can now be used against the American people, legally, by law. And they're doing it. That's where we're at. That's the empire. That's George Bush's new world order.

Common Ground: How did this come about? Has it just happened so slowly that we didn't notice or has it been veiled in rhetoric?

KC dePass: The work camps were outlined in the 1988 drug law, #101690. The U.S. military was given the job of fighting the drug war under the National Defense Authorization act of 1989, because the government says there's a national emergency, we have a [drug] epidemic. Well, epidemic by definition means it's on the rise, not on the decline. And every single category of drug usage in America, every single category... is off sharply and down drastically. 2.8 million fewer people use cocaine than before. What is my source? The national drug control strategy report of 1989, '90, and '91. Bill Bennett's office, the drug czar.

Every category of drug usage has been off sharply since 1979 to '85, then from 1985-88. So if drug usage is off sharply, down drastically and fewer people than ever are using cocaine, why are we locking everyone up in boot camps? We've been solving the problem socially, as a people, all by ourselves, no government intervention. Those statistics are before the 1986 and '88 drug laws, by the drug laws' own admission in Appendix D. I was sitting in a hotel room at two in the morning after I'd given a lecture in Portland—and I'm reading the appendix to the drug czar's report and I'm going, "There's no epidemic." They're saying there's no epidemic, it's on the decline.

But the government says there's a state of national emergency, we have an epidemic.

And there is none. By their own admission. But it gives them the opportunity to pass laws, to establish boot camps, work camps, concentration camps, and give first time drug offenders five years with no chance of parole. They can pass these laws under the perception that we have an increasing epidemic and we must do something. Now you can't tell me that the congressmen and senators don't know this. Congress is lying and the people are ignorant.

Now that the bases have either been closed or designated to be closed, they're coming back at us—the congressmen and senators very quietly saying, "Well hey, for the sake of efficiency and to save money, we don't have to build new prisons. We can take these military bases, put huts and tents on them and house the homeless, house the AIDS patients, we can house the illegal aliens, and by golly while we're at it, we can house the drug users. We don't have to spend taxpayers' money to build new prisons." They're lying through their teeth. They always knew they were going to do this. I can prove it, with their laws.

CG: Do you think deception is inherent in government? Does power lead to secrecy?

dePass: All governments will evolve, if it's allowed, to centralize it's power. What's centralizing now is monetary policy, raw materials, and industrial capacity under international organizations. So it seems natural to me that it's going to centralize the governmental powers in that direction, because that's who's buying the politics.

Now this isn't supposition, it's a fact. Look at who the major corporations finance. They give illegal or legal contributions to every candidate, all over the world, Democrat or Republican, marxist or freedom fighter, they don't care, whoever wins—they own. That's the power of wealth and industrial capacity speaking very clear language. And it's documented at the federal election commission level—just look up the documents, you'll find Exxon contributing to every campaign, both sides, after the primaries are over. They're buying both sides, and at a tremendous dollar value. When you add up all the corporations doing this, all the associations and corporations and manufacturers doing this—you'll find that every congressman and senator is bought and paid for by the same people, Democrat or Republican. That's what centralizes the power of government in these men's best interests.

CG: Do you believe this concentration of power is inevitable?

dePass: Through the Jackson era, we did in fact stay away from that kind of monopoly power. Jackson was one of the few presidents with enough courage to stand up to those kinds of powerful people, monied people with industrial, agricultural and banking interests. He's the one who

threw out the second central bank, he refused to renew it's charter and basically stonewalled them and threw them out of their offices. And he gave courage to the American people and they stood up against this power like never before, by his example. The people of America could destroy this empire in one rising up by tossing everybody out of office, if they cared enough.

CG: But again, the problem you find is that they don't care enough?

dePass: Well, we are in fact an illiterate society today, politically, compared to what we were a hundred years ago. And that's where our failing is, is that we don't even understand what causes inflation. How are we going to stand up to the monetary powers of the world centralizing the banking system like they are, if we don't even know what causes inflation and interest rates to go up and down. They've got us so locked into illiteracy about what really matters and yet we're totally literate in our self-interest. We're totally preoccupied. We have people out there who can use computers and figure balance sheets. They can work in their self-interest at an incredible level of intelligence. But ask them who their governor is. Ask them to find Kuwait on a map. They can't do it. That's a sad, sad state of affairs. But if there was ever a conspiracy, it's by the American people to remain ignorant.

CG: Are we hopeless? What would you suggest for people who want to be more involved?

dePass: You must talk to each other. Study groups have formed all over the country, largely unknown to me. One of them is in the Middle East, one's in Jerusalem. There are groups all up and down the west coast, there's one in Bremerton, Wa. They collect the white papers, they use them as study materials and then they go on and do what I suggest in the lectures, which is to go on and study other materials—authors, historical works, and get a firm grasp of what the problem is because nobody's ready to talk about solutions yet. Republican or Democrat...liberal or conservative...none of those things are the reality. The reality is that this black man sitting here to my left must get together with this white man with the cowboy hat sitting to my right. You must talk to each other. The homosexuals, whether they like it or not, must talk to the Christian fundamentalists. Atheists need to talk to Christians. New Agers need to talk to basically everyone instead of isolating everyone in symbols of what they dislike about religion. It's called pluralism or multi-culturalism, whatever the big words you choose to put on it are. To me it's like the muppets philosophy in Jim Hensen, "peoples is peoples."

The hope does rest, unfortunately or fortunately, with the people themselves. It is up to the American people to get their heads out of the football games and the red cars and the new homes and decide to take

charge of their country. I believe they have the common sense if not the will to do that. God help us if I'm wrong.

*Amy Rawe is a freelance writer who lives and works in Seattle. She contributes regularly to COMMON GROUND.*

**A WOMAN WHO always said her husband was too good to be true has suddenly filed for divorce after discovering she was married to a robot!**

Alice Daudet claims her hubby Claude began malfunctioning during a tender lovemaking session. A fleshlike piece of plastic was torn off of his neck, revealing a mass of wires.

"When I saw it, my whole world came crashing down," Alice says. "All through those three years I was married to Claude, I felt as if I was living in a fairy tale.

"In reality, it was more like science fiction."

Alice, a secretary, met Claude at single's bar. She was immediately intrigued by the handsome stranger's strong square jaw and ice-blue eyes. The couple began dating and quickly fell in love.

"Claude was so polite and old-fashioned," remembers Alice. "I was convinced they didn't make them like him anymore."

"But it seemed strange that such a wonderful man didn't have any family or friends. Whenever I asked him about his past, he'd just clam up."

Claude was also secretive about his job, at which he worked seven days a week. He claimed he was doing research in a laboratory.

Nevertheless, when he proposed marriage, Alice gleefully accepted. They tied the knot and began their lives together.

### Horrible

The only sore spot in an otherwise perfect marriage was the couple's inability to have a child.

"I wanted a baby more than anything, but after a year of trying, nothing had happened," says Alice. "My doctor performed tests on me and said I was fine, so the problem had to be with my husband."

"But Claude refused to be examined. He said he



**ALICE HAS** filed for divorce after discovering her hubby was a robot

8-14-90

Two more years went by until the horrifying night when Alice learned the real reason why her hubby couldn't have kids.

"We had a romantic candlelight dinner, and were just getting cozy in bed, when Claude started flopping around and making squeaking sounds like a tape player in rewind," recalls Alice.

### Unconscious

"At first I thought it was a bad case of the hiccups, but then I smelled burning rubber."

"All of a sudden, he flew across the room and smashed into a bedpost. He fell unconscious on the floor, and I saw he was cut behind the neck."

"I ran over with a towel to bandage him, but there was no bleeding, only wires."

"I touched them and a powerful electric shock jolted my body."

While horrified Alice lay there in a state of shock, her robot hubby sprang to life and ran out of the house naked, with wires trailing out of his neck. That was the last Alice ever saw of him.

Six weeks later, Alice filed for divorce.

"I just want to put this terrible nightmare behind me and get on with my life," says Alice.

# CIA-funded program jolts school

By Laurie Goodstein 10-91  
Washington Post

ROCHESTER, N.Y. — Revelations about a CIA-funded program at the Rochester Institute of Technology have generated stormy debate on this normally quiet and conservative campus.

Trustees have begun an investigation, the executive assistant to President M. Richard Rose has resigned, and students and faculty have called for the president's ouster.

University and CIA officials say that, in the last five years, the agency has given the school at least \$5 million to establish a center to conduct research exclusively for CIA use, has tried to shape the curriculum and has placed a "CIA officer in residence" in a doctoral program there.

In addition, faculty members said Rose and his assistants had asked them to train CIA personnel and to apply for security clearances, which as many as 20 faculty members have done. One dean declined and later learned that the CIA had initiated a background check on him without his consent.

The revelations were made by the local newspaper, the Democrat and Chronicle.

All of this has been fueled by the release this month of a draft report called "Japan: 2000" that was prepared for the CIA by the executive assistant, Andrew Dougherty. The report described the Japanese as "creatures of an ageless, amoral, manipulative and controlling culture."

Rose and his staff are trying to dispel criticism that RIT, on Lake Ontario's rim, has become "Langley on the Lake," a reference to the CIA's headquarters in northern Virginia.

In an interview in his office, decorated with Japanese fans and vases, Rose said that the school's connection with the CIA was "entirely ap-

propriate" but that he made a mistake in coordinating all contacts with the agency through his office, which he has stopped doing.

A Marine Corps reserve officer, Rose was deputy assistant defense secretary for education from 1972 to 1974. He helped to ignite the controversy at the school in April when he revealed that he was spending a four-month sabbatical at Langley to help create training programs for agency personnel.

His candor came after two months of statements in which he said only that he had accepted a confidential assignment in Washington in some way related to the Persian Gulf war effort.

Rose was on sabbatical when "Japan: 2000" became public. A foreword under his name in the draft report said Americans must "counteract Japan's national vision and their pursuit of world economic domination."

Rose said that the document was "racist and embarrassing" and that he had not written or read the report or its foreword before publication. Although a revised version was released immediately and omitted descriptions generally regarded as offensive, Dougherty resigned.

Rose said he planned to visit Japan in September to smooth relations with numerous corporations that fund programs at RIT.

The CIA recruits 15 to 20 of the 13,400 RIT students annually, said George Ryan, operations director of RIT Research Corp., an off-campus university subsidiary. Rose recently designated Ryan as RIT liaison with the CIA.

An additional 30 to 50 students have security clearances to work at the corporation's Federal Programs Training Center, financed entirely through CIA contracts.

many prior to World War II, but is this true?

Handgun Control, Inc. (HCI) is waging a major propaganda war against the United States, with the help of the socialist media elite, and some powerful politicians. Their lies were once totally disregarded by most people, but today, the majority of the people seem to believe the anti-gunners. Why is this?

In 1925 Adolf Hitler wrote *Mein Kampf*, and gave the world an opportunity to see into his mind. Hitler wrote about the Nazi movement from its infancy, and gave us insights as to his intentions. In 1939, *Mein Kampf* was translated into English and distributed in America. But few people took the time to read *Mein Kampf*. After all, the predictions being made about Hitler's intentions were crazy, and few people could comprehend them, much less believe them.

Today we must deal with people, even fellow gun owners, who do not believe that the present gun control attempts are leading to total gun confiscation and a police state. They, like the "unbelievers" in 1939, will not take the time to research this movement. If they did, they would see that these warnings are indeed accurate and timely.

*Mein Kampf* contains two chapters on propaganda (War Propaganda, and Propaganda and Organization), and Hitler laid out an extensive propaganda plan in his book, a plan that would change the history of the world. From reading these two chapters, we can learn that Hitler was an expert and brainwashing. Hitler probably knew more about the human mind and behavior — and how to control both — than almost anyone else of his time. I do not think that we need to argue his knowledge or success in this area. History quite clearly shows us the powerful effect that Hitler had on people and what he motivated them to do. And today, in America, Hitler's tech-

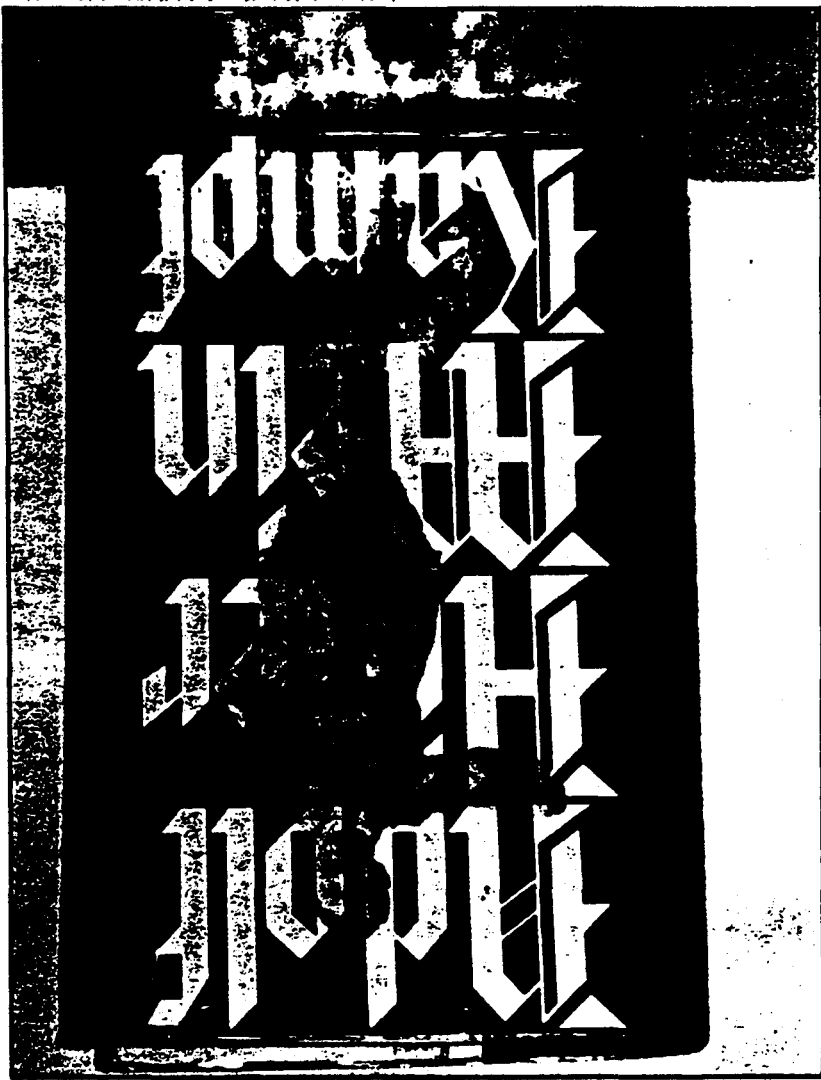

# Propaganda

*A comparison of Nazi propaganda techniques and those used by the powerful anti-firearms-ownership movement in America and disseminated by our national media*

# Anti-Gun-Ownership

National Socialist/Socialist::

By Don Boal

In the book *Mein Kampf*, Adolf Hitler laid out his strategy for controlling the masses with propaganda. The same propaganda techniques we being used here in America to disarm the citizenry.

**Y**OU have heard that the anti-gun movement is duplicating the tactics that Hitler used to disarm Ger-

The author is president of the Keystone Second Amendment Assn., a pro-firearms-ownership organization based in Pennsylvania (P.O. Box 361, Curwensville, PA 16833) — The editors.

niques are being used again, to destroy the United States and personal liberties.

The anti-gun movement's main propaganda themes seem to be that (1) guns and gun owners are the root of all evil, and (2) that they (the socialist anti-gunners) are our only hope against the spreading plague of crime. In *Mein Kampf*, Hitler's main propaganda themes seem to be that (1) Jews and Jewry are the root of all evil, and (2) that Hitler was Germany's best hope against the spreading communist revolution.

To understand the movements, we must understand what propaganda is. Simply put, propaganda can be outright lies, distorted facts, and/or truth, combined to change a person's thoughts on a subject.

According to Hitler, "The task of propaganda lies not in a scientific training of the individual, but rather in directing the masses towards certain facts, events, necessities, etc., the purpose being to move their importance into the masses' field of vision" (page 231).

We can see this in HCI's propaganda, as they also stick to a few main points and repeat them over and over. How many times do they draw out attention to the Hinkley shooting, the Purdy shooting, or the AK47 rifle? Rather than use many different crimes as examples in their propaganda, they concentrate on a handful of well known crimes.

Hitler believed that propaganda had to be very simple, so the average person, with a very short attention span, could understand it. He stayed away from complicated ideas and stuck to a few basic and easy to understand ideas.

Hitler said, "The more modest then, its scientific ballast is, and the more it exclusively considers the feelings of the masses, the more striking will be its success... This is just the art of propaganda that it, understanding the great masses' world of ideas and feelings, finds, by a correct psychological form, the way to the attention, and further to the heart, of the great masses" (page 232-233).

Basically, Hitler says, **KEEP IT SIMPLE!**

He goes on to say, "The great mass of people is not composed of diplomats or even teachers of political law, nor even of purely reasonable individuals who are able to pass judgement, but of human beings who are as undecided as they are inclined towards doubts and

uncertainty" (page 236-7).

This is quite true, as very few people have taken the time to learn how the political system and legislative process works, not to mention the U.S. Constitution, and what it means. These people are "ripe for the harvest" of a propaganda expert.

Hitler also said, "The people, in an overwhelming majority, are so feminine in their nature and attitude that their activities and thoughts are motivated less by sober consideration than by feeling and sentiment" (page 237).

Look again at the gun control battle. Are people taking the time to study the issue individually before making a decision? No, rather they see images on TV of dead bodies, body bags, pools of blood, and a gun lying next to a corpse. They see victims in pain and they see next of kin crying over lost loved ones. They allow their emotions to take over, and base their opinions on these emotions, rather than "sober consideration." Television has become the most effective brainwashing tool to turn gun control into an emotional issue. We are all human, and none of us enjoys seeing weeping relatives or crime victims lying in the street. Those among us who are strong see these images and decide to prepare to resist an attack to ourselves and our families. Those among us who are weak, succumb to the brainwashing techniques and think that guns are evil. Why is HCI, a relatively small organization (in comparison to the large number of citizens who own firearms), so successful in their repeated attacks against us?

Hitler answers this: "When propaganda has filled a whole people with an idea, the organization, with the help of a handful of people, can draw the consequences. Propaganda and organization — that means followers and members — have thus a definite mutual relationship. The better propaganda has been working, the smaller may be the organization, and the greater the number of members and vice versa: the worse propaganda is, the greater must and will be the organization and the smaller the host of followers of a movement remains, the greater must be the number of members, if it still wants to count on success at all" (page 851).

Chipping Away — From Hitler's words, and HCI's example, we can see that they will continue to chip away at our firearms freedoms. As long as the vast majority of gun owners and freedom loving Americans remain sit-

ting on the sidelines, we can expect things to get even worse. It is insane to think that HCI will back down, or be satisfied with only the Brady Bill, they have only just begun their attack, and we have much more to come.

We can consider the leaders of the anti-gun movement (and their media elitist friends) to be experts in the art of propaganda. They most definitely know what they are doing, and they are very successful.

Hitler said, "... for this (propaganda) is also only a weapon, though a frightful one, in the hands of an expert" (page 230).

Frightful indeed! We can see the propaganda masters taking our freedom and our fellow citizens (the "masses") are practically begging

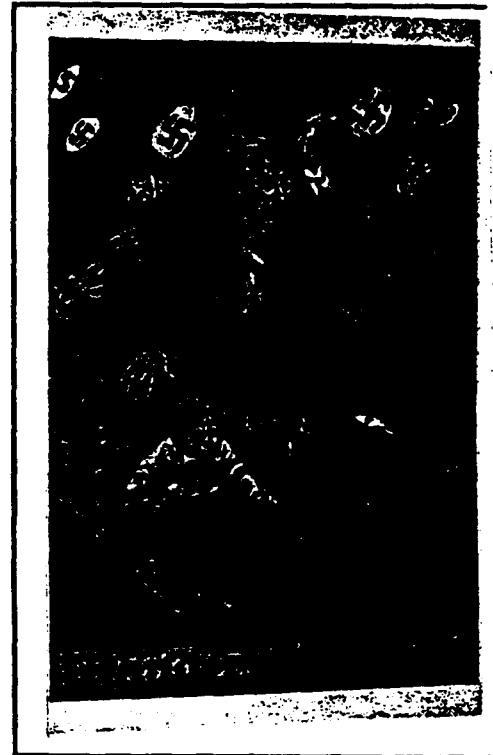

Nazi propaganda poster showing Jews fleeing before the tide of National Socialism. Hitler said, "The task of propaganda lies... in directing the masses towards certain... events, necessities, etc., the purpose being to move their importance into the masses' field of vision."

them to do it.

HCI is known for sticking to a handful of basic lies or statements, which they repeat constantly. The result is that the average person (Hitler calls them "the masses," while Lenin called them "useful idiots") has these ideas hammered into him/her, until eventually they agree with HCI, and are won over to HCI's side.

According to Hitler, "Now the purpose of propaganda is not continually

to produce interesting changes for a few blase little masters, but to convince; that means, to convince the masses. The masses, however, with their inertia, always need a certain time before they are ready even to notice a thing, and they will lend their memories only to the thousandfold repetition of the most simple ideas" (page 239).

Do you not see HCI using the same lies thousands of times, per Hitler's instructions? We are referred to as "the lunatic fringe," "gun nuts," and "bullies." The scary sounding terms they



A World War II Nazi propaganda poster. Hitler said, "The people, in an overwhelming majority... are motivated less by sober consideration than by feeling and sentiment."

use repeatedly, such as "assault weapon," "cop killer bullet," or "Saturday Night Special" are also hammered into our heads as a brainwashing tool. Add to this the slogans "Has the NRA gone off the deep end?" "How many more have to die?" "If we can save just one life..." "We're working to keep guns out of the wrong hands" etc., and you have a very effective propaganda campaign in use. We are merely hearing slight variations of the main propaganda theme, that guns and gun owners are the root of all evil. They make sure

that they stick to their main theme, as this is absolutely critical to the success of their movement.

Hitler said, "All advertising, whether it lies in the field of business or of politics, will carry success by continuity and regular uniformity of application" (page 240).

Hitler goes on to say, "The great masses' receptive ability is only very limited, their understanding small, but their forgetfulness is great. As a consequence of these facts, all effective propaganda has to limit itself only to a very few points and to use slogans until even the last man is able to imagine what is intended by such a word. As soon as one sacrifices this basic principle and tries to become versatile, the effect will fritter away, as the masses are neither able to digest the material offered nor to retain it. Thus the result is weakened and finally eliminated" (page 234).

This is true, as most people rely solely on the mass media for their news, and never take the time to see if the news reports are actually true. We tend to have very short memories as well. Can you remember what you were doing nine days ago, what the lead story was on the news three days ago, or just one or two campaign promises that George Bush has not broken?

In the beginning of the anti-gun movement, most people did not believe the anti-gun lies. They knew that all the scheming and dreaming would not eliminate crime, but rather that it would strip them of their liberties. By utilizing effective propaganda techniques, HCI has managed to change quite a few minds. This is especially evident when we look at the Brady Bill votes in the U.S. House of Representatives. A few years ago, when the House voted on the Brady Bill, it was defeated by 24 votes. This time it won by 53 votes. Why the drastic change? Simple, by not giving up on their never ending propaganda campaign, they brainwashed more people into joining their side, including many who used to be pro-gun (at least seven of those "Representatives" that voted anti-gun had received NRA PAC money for their prior support).

Hitler said, "Here, too, the enemy's war propaganda (he is referring to World War I) set a typical example. It was limited to a few points of view, cal-

culated exclusively for the masses, and it was carried out with untiring persistence. Basic ideas and forms of execution which had once been recognized as being right were employed throughout the entire war, and never did one make even the slightest change. At the beginning it was apparently crazy in the impudence of its assertions, later it became disagreeable, and finally it was believed" (page 240).

Spreading The Idea — Hitler goes on to say, "In every great revolutionary movement propaganda will first have to spread the idea of the movement. That means, it will untiringly try to make clear to the others the new train of thought, to draw them over to its own ground, or at least to make them doubtful of their own previous conviction" (page 852).

HCI has managed to change society's view of gun ownership. Guns used to be considered normal, healthy and in many instances, necessary. Today, more and more people believe that guns are evil, and somehow responsible for crime. This change of thought did not just "happen," it was brought about by clever propaganda use.

Make no mistake about it, HCI and the gun grabbing elitists want nothing short of taking all of our guns. The Brady Bill is just their first step. Sound crazy? Sure, and that is why it is working! But don't take my word for it, let's see what the anti-gunners have said about their devious plan, in their own words:

"This is the first step" — U.S. Representative Edward Feighan, referring to the Brady Bill (which he introduced) at recent House hearings.

"We're going to have to take one step at a time, and the first step is necessarily — given the political realities — going to be very modest... So we'll have to start working again to strengthen that law, and then again to strengthen the next law, and maybe again and again. Right now though, we'd be satisfied not with half a loaf but with a slice. Our ultimate goal — total control of handguns in the United States — is going to take time... The first problem is to slow down the increasing number of handguns being produced and sold in this country. The second problem is to get handguns registered. And the final problem is to make the possession of all hand-

guns and all handgun ammunition — except for the military, policemen, licensed security guards, licensed sporting clubs, and licensed gun collectors — totally illegal” — Pete Shields, Chairman Emeritus, Handgun Control, Inc. (interview appearing in *The New Yorker*, July 26, 1976)

“This is not all we will have in future Congresses, but this is a crack in the door. There are too many handguns in the hands of citizens. The right to keep and bear arms has nothing to do with the Brady Bill” — U.S. Rep. Craig Washington, at the mark-up hearing on the Brady Bill, April 10, 1991.

“Handguns should be outlawed. Our organization will probably take this stand in time but we are not anxious to rouse the opposition before we get the other legislation passed” — Elliot Corbett, Secretary, National Council For A Responsible Firearms Policy (interview appeared in the *Washington Evening Star* on September 19, 1969).

“It is our aim to ban the manufacture and sale of handguns to private individuals... the coalition’s emphasis is to keep handguns out of private possession — where they do the most harm” — Recruiting flyer currently distributed by The Coalition To Stop Gun Violence, formerly called The National Coalition To Ban Handguns.

“Yes, I’m for an outright ban (on handguns)” — Pete Shields, Chairman emeritus, Handgun Control, Inc., during a *60 Minutes* interview.

“We are at the point in time and terror where nothing short of a strong uniform policy of domestic disarmament will alleviate the danger which is crystal clear and perilously present. Let us take the guns away from the people. Exemptions should be limited to the military, the police, and those licensed for good and sufficient reasons. And I would look forward to the day when it would not be necessary for the policeman to carry a sidearm” — Patrick V. Murphy, former New York City Police Commissioner, and now a member of Handgun Control’s National Committee, during testimony to the National Association of Citizens Crime Commissions.

“My experience as a street cop suggests that most merchants should not have guns. But I feel even stronger about the average person having them... most homeowners... simply have

no need to own guns” — Joseph McNamara HCI Spokesman, and former Chief of Police of San Jose, California.

“I don’t want to go for confiscation, but that is where we are going” — Daryl Gates, Police Chief of Los Angeles, California.

“There may be other things that will happen later... It may not be the end... the bottom line is what we are seeking now is the Brady Bill” — U.S. Rep. Charles Schumer, interviewed on *CNN Crossfire*.

“The Brady Bill is the minimum step Congress should take... we need much stricter gun control, and eventually should bar the ownership of handguns, except in a few cases” — U.S. Rep. William Clay, quoted in the *St. Louis Post Dispatch* on May 6, 1991.

“It’s only a first step, it’s not going to be enough... we’ve got to go beyond that, and I hope we’ll do it this session of Congress” — U.S. Rep. Edward Feighan during an interview on *ABC News Nightline*.

These people are quite clear as to their true intentions, that is, to totally disarm the American citizenry. Make no mistake about it, they are winning, and we are losing.

If you are not already involved in fighting to preserve our right to possess firearms, I strongly urge you to get involved. Join one or more of the national pro-gun organizations. But do not stop there. If you expect to win this war, you must be willing to stand up and get involved. The national pro-gun groups simply are unable to hold the tide anymore. We must supplement their work with grass roots work at the local level.

Join a local pro-gun grass roots group, and if there aren’t any in your area, start one of your own. Meet with politicians when they are in your area. Write letters, make phone calls, and vote. Organize people and educate the “masses.”

While we may have truth on our side, the people are not listening to the truth. They believe the lies and will not take the time to find out that they are indeed lies. This will only get worse. We do not have the odds in our favor, as the anti-gun forces are well entrenched and powerfully armed. But we must resist or we will most certainly lose. Make no doubt about that. Get involved immediately!! ●

AMERICAN SURVIVAL GUIDE/MARCH 1992 73

Summary of Dr. Coleman's Tapes and Monographs:  
**"Genealogy of Tyrants":**  
**The Genealogy of the Bush and Roosevelt Families**

In this monograph and cassette, Dr. Coleman gives us a look at some of the facts in his book "Diplomacy By Deception" which will be available this summer.

The amount of research done for this work is clearly visible as we are taken through the history of the Bush family and are shown the connection between the Bush and Roosevelt families.

In an interesting and highly readable manner, we learn that Vice President Quayle is related to George Bush. In the FIRST EVER report, Dr. Coleman shows that Richard Bruce Cheney is also a distant relation of the Bush and Roosevelt clans. And we thought Cheney's appointment as Secretary of Defense was mere on mere merit!

Referring to Cheney's sudden and totally unexpected appointment to one of the highest offices in the land, Dr. Coleman says "his appointment is a another example of those many cases in government of not what you know, but who you know".

Other "skeletons" in the Bush closet include Marilyn Monroe, Bette Davis, the war criminal Winston Churchill, and Benedict Arnold, a fourth cousin, seven times removed. Bush is related to Franklin D. Roosevelt and Teddy Roosevelt and all in all George Bush is related to ten other former occupants of the White House.

In this fascinating narrative, Dr. Coleman takes us through what he calls "the family trees of tyrants", and comes up with some truly startling conclusions, one of which is that 21 United States Presidents were related to each other, what Dr. Coleman calls "a veritable 'royal family' of America".

We are given facts about Abraham Lincoln, (to whom Bush is related), and a complete run-down on relationships through marriage of the Eisenhower and Nixon families, Presidents James Monroe, James Madison and Zachary Taylor.

After reading this monograph or listening to the cassette tape, few if any will doubt that we have been ruled by interrelated "royal" families, some of whom truly qualify as tyrants.  
 WIR March 1991.

PRICES ARE \$10.00 FOR EACH TAPE/MONOGRAPH

DR. J. COLEMAN  
 P.O. BOX 40065  
 BAKERSFIELD, CA 93304

Summary of Dr. Coleman's Tapes and Monographs:  
**"Environmentalism: The Second Civil War Begins. Part II."**

When Dr. Coleman began collecting and collating data and information for this work, he did not realise that he would have enough material to write a book on this vitally important subject, not that he plans to do so at this time.

Therefore Dr. Coleman decided that it would be best to divide the work into three parts, the first of which has already been completed.

In part two, Dr. Coleman gives some very detailed facts which have not been available before. Dr. Coleman draws a startling conclusion that there is a definite link between "orderly progress and absolute freedom which the environmentalists will oppose with all means available to them, and they are very considerable" he states.

More information about the forthcoming meeting of the Club of Rome environmentalist and world political and religious leaders which will take place in Montevideo in November are given in this work, which Dr. Coleman states is a "test-run" for the meeting of "global ecologists under the auspices of the United Nations" which is set to meet in Brasil in 1992.

Dr. Coleman will tell us about the role being played by the FCC in helping environmentalists, and will go back to the Industry Capture Movement.

"The Clean Air Act recently signed into law by President George Bush has opened the way for probably the most repressive agency in our history, the EPA, to wantonly flout our rights under the Bill of Rights and our Constitution" says Dr. Coleman, and he gives a very interesting account of the new "EPA-KGB" director, William Riley and what we may expect from him.

Dr. Coleman explains why President Bush created a cabinet post for Riley, his chosen disciple of environmentalism and the underlying reasons for it.

We believe that after reading or listening to this, the second of a three-part series on environmentalists, and the aims of its powerful leaders, there will be no doubt that we are indeed facing the very real prospect of a second civil war.  
 WIR March 1991.

# Neil Bush

By Kathleen Day  
 The Washington Post 5/30/91

WASHINGTON — President Bush's son Neil and 10 other former directors and officers of failed Silverado Banking Savings & Loan Association



Neil Bush agreed Wednesday to pay the government nearly \$50 million to settle a \$200 million civil suit that charged the officials contributed to the institution's collapse in 1988 through lax management.

Little of the nearly \$50 million will be paid by Bush and the others. Instead, most of the funds will come from insurance companies and a special Silverado fund set aside years ago, a source said.

Silverado's failure, one of the 10 largest in size and expense, is expected to cost taxpayers more than \$1 billion.

Under the proposed settlement, the 11 officials and Silverado's former law firm, Sherman & Howard of Colorado, have agreed to pay \$26.5 million, said Alan Whitney, a spokesman for the Federal Deposit Insurance Corp., the federal agency that filed the civil suit in the fall. Most of that money will be paid by insurance firms.

The agreement also calls for the officials to turn over to the federal government a \$23 million legal defense fund — what regulators call a "war chest" — the former Silverado officials set up for themselves in 1986 using Silverado's money, Whitney said.

The proposed settlement, which is expected to become final June 12, means Neil Bush, a Denver oil man, and the other former Silverado officials will have to pay their own legal expenses.

However, U.S. District Judge Sherman Finesilver, who announced the agreement in principle Wednesday, noted those costs would be "minimized" by this settlement.

The FDIC's suit charged that Bush and other directors failed to oversee the Denver thrift's operations, claiming they "deferred excessively to Silverado's management" and failed to correct risky loan and other practices despite heavy criticism from regulators.

It also charged that Silverado's top officers received excessive compensation, all of it approved by the thrift's directors.



# Book Asserts Reagan Slowed Release of Hostages in 1980

By NEIL A. LEWIS  
Special to The New York Times

11-8-91

WASHINGTON, Nov. 7 — In a new book, Gary Sick, a Middle East expert and former Carter Administration official, presents what he describes as an exhaustive collection of evidence to bolster his assertion, now under heated debate in Congress and elsewhere, that senior officials of the Reagan campaign negotiated a secret agreement with Iran in 1980 to delay the release of the American hostages.

Mr. Sick's book, "October Surprise: America's Hostages in Iran and the Election of Ronald Reagan," published by Random House, is the latest of several arguments and counter-arguments over whether efforts by Reagan campaign officials to monitor what

## Campaign officials are accused of illegal negotiations.

President Jimmy Carter was doing to free the hostages, escalated into illegal negotiations with representatives of Ayatollah Ruhollah Khomeini, the Iranian ruler.

The book does not offer conclusive new evidence to support Mr. Sick's view, which was first espoused in an article he wrote for the Op-Ed page of The New York Times on April 15. Because of his stature and reputation as a cautious analyst, Mr. Sick's article was largely responsible for resurrecting interest in the accusations that had been the subject of low-level rumors since shortly after Ronald Reagan was inaugurated in 1981.

The attention paid to Mr. Sick's theories also led to other independent investigations on the same matter. Two of them published this week, in the New Republic and Newsweek magazines, concluded that the accusations were groundless. Moreover, the accusations have been strenuously denied by President Bush, former President Reagan and others said to have been involved.

In a sense, Mr. Sick's book and the other journalistic investigations are battling not just with each other over what really happened 11 years ago. They are also aimed at Congress, which is just beginning a fractious partisan debate over whether to investigate the accusations, and how that should be done.

Today, the House Rules Committee approved a resolution authorizing a special panel headed by Representative Lee H. Hamilton, Democrat of Indiana, to look into the accusations.

The foundation for Mr. Sick's thesis is the accusation that William J. Casey, the Reagan campaign manager, who

was later named to direct the Central Intelligence Agency, traveled twice to Madrid in the summer of 1980 to meet a delegation of Iranian officials, including a leading cleric, Hojatolislam Mehdi Karubbi. The deal to delay the release of the hostages, Mr. Sick says, was then consummated in a series of meetings in Paris in October. The PBS program "Frontline" and the ABC News program "Nightline" offered similar versions on the theory.

There are several other crucial assertions in Mr. Sick's book:

¶ The Carter Administration authorized its own private negotiations with Iran through an intermediary in the summer of 1980. Mr. Sick, who served on the National Security Council staff under President Carter, said that a private citizen, whom he did not identify, was met in London by an Iranian arms dealer. From there, he was flown on a private plane to Madrid where he met with a relative of Ayatollah Khomeini. Those circumstances, he writes, match closely the accusations about Mr. Casey's travels later that summer and thus help prove that they indeed occurred.

¶ The Israelis were so eager to resume supplying arms to Iran, despite the United States-imposed embargo, that they were willing to risk angering President Carter. Mr. Sick writes that at the same time a mission to rescue the hostages foundered in the Iranian desert in April 1980, the Israelis were trying to conduct an arms sales with Tehran. Israeli officials have privately acknowledged what they called small-scale arms shipments to Iran in the early 1980's, saying they needed to insure good relations with Tehran.

¶ The Republican campaign had such an extensive intelligence network within the Democratic Administration that Reagan campaign operatives were able to learn some of the most closely held intelligence in that summer. Mr. Sick said the Reagan campaign was aware of sensitive planning for a second rescue mission.

This week's issue of the New Republic magazine features a cover story that argues that the incident, known as the "October Surprise," "is a total fabrication. None of the evidence cited to support the October Surprise stands up to scrutiny."

Newsweek magazine, in its current issue, has a cover story that reaches a similar conclusion about the October Surprise: it never happened. The magazine's cover calls the accusations a myth.

Both magazines also present evidence that purports to challenge some of the key accusations made by Mr. Sick and others about Mr. Casey's travel plans. The main dispute centers on Mr. Casey's whereabouts in the last few days of July 1980 when, according to Mr. Sick's account, he first met the Iranians.



Associated Press

Gary Sick, the author of "October Surprise: America's Hostages in Iran and the Election of Ronald Reagan."

When Mr. Sick first made his accusations about the Madrid meeting, associates of Mr. Casey, who died in 1987, insisted he did not leave the country in that period. But photographs and news reports surfaced showing that he was in England at the time, attending a conference on the history of espionage in World War II.

Much of the debate has focused on whether he could have used those three days he was reportedly in England to travel to Madrid, a 90-minute plane flight. Some records suggest he did not leave the British air base where the conference was held, but they are ambiguous. Other accounts appear to document that he was attending lectures at the conference most of the time.

"The critical question is whether representatives of a political party out of power secretly, and illegally, negotiated with representatives of a foreign power," Mr. Sick writes in his book. "Even today, more than a decade later, it is still difficult to imagine that an opposition political faction in the United States would employ such tactics, willfully prolonging the imprisonment of 52 American citizens for partisan political gain. Nevertheless, that is what occurred: the Reagan-Bush campaign mounted a professionally organized intelligence operation to subvert the American democratic process."

Mr. Sick's assertion that a Carter Administration representative flew to Madrid in similar circumstances to those alleged for Mr. Casey demonstrates how different conclusions can be drawn from the same event. Newsweek, for example, acknowledges that the London-Madrid meeting with a Carter representative did occur and suggests that perhaps the Iranians confused Carter and Reagan. That, it suggests, is how the theory got started.

# Dispensers of death

Donald Gould is disturbed by a ruling in the US (5 AUG 89)

**T**HERE are many reasons for supposing that the human race may be self-destructing, but how discouraging it is to have this sad conclusion enhanced and force-fed down our gullets by the US, which great nation likes to see itself as a community exemplifying the highest achievements of democracy.

I refer to the appalling decision by the US Supreme Court which, by a majority of five to four, and after considering three separate appeals, has recently ordained that the execution of juveniles or the mentally retarded for the crime of murder does not violate the country's constitutional ban on "cruel or unusual" punishment. The rejected appeal, which has opened the way for the killing of some 300 American simpletons now languishing in condemned cells, was submitted on behalf of a 32-year-old man with an IQ of less than 60 and a mental age of seven.

The US's recent record in the matter of judicial homicide—outlawed in 1972 but restored to legality a short four years later—was sufficiently disgraceful before this latest manifestation of wickedly obtuse insensitivity.

Just two years ago I recorded in these columns the barely credible details of an execution in Texas, one of the states which has opted for killing its unwanted malefactors by lethal injection. Presumably nobody had bothered to look at the wretched victim's veins before he was led into the death chamber. At any rate, it was found, when it came to the crunch, that all his superficial veins were sclerosed because of his habit of "mainstreaming" drugs. They had to spend 35 agonising minutes prodding around with a needle before they were able to bring the obscene pantomime to a merciful end.

Such extreme demonstrations of state-sponsored callousness and inhumanity may be rare in the US, but a slower, less dramatic form of pre-execution torture is virtually routine. Condemned men and women spend many months or, more often, many years, on "death row" while a cumbersome appeals procedure runs its interminable and usually unsuccessful course. At any one time some 2000 American citizens are kept in miserable confinement, living with the almost certain knowledge that their final release can only come in the form of an injected poison, or gassing, or the noose, or electrocution, or (in Utah) a friendly neighbourhood firing squad.

If this does not constitute punishment of a "cruel or unusual kind", then I'm damned if I know what does.

And this sort of horror cannot be largely blamed on bureaucratic bumbling and inefficiency (although these make their considerable contribution to the sorry mess). Instead it reflects the will of the people.

The rapid (albeit reluctant) reversal by the Supreme Court of its 1972 decision that the death penalty was "unconstitutional" was the result of a widespread public clamour for its reinstatement.

Earlier this year a condemned man in the state of Washington refused to accept a

lethal injection and demanded that he should, instead, be hanged—an option which the state laws allow. But prison officials couldn't find a properly qualified hangman. They advertised, and dozens of ordinary citizens applied for the job, including a 76-year-old man and several women. Unfortunately, they all lacked the necessary expertise, and an out-of-state person had to be employed at a reported fee of around £900.

And it is recorded that when Theodore Bundy, "America's most infamous sex killer", was electrocuted in Florida last January, parties were held throughout the country.

Of course, the US is by no means the worst offender. Last April, Amnesty Inter-



national published a report showing that 125 nations still retain the death penalty, despite ample, hard statistical evidence that it is ineffectual as a deterrent. Some two-thirds of all executions are carried out by just four countries—Iran, South Africa, China and Nigeria—and often the rite, as with the stoning to death favoured by seven Islamic states, involves extreme cruelty. But it is specially depressing to find the revengeful ceremony so popular in a place which the late President Woodrow Wilson once described as "the only idealistic nation in the world". Not that Britain can afford to be self-righteous in the matter: a majority of its citizens (including the Prime Minister) would like to see the scaffold back in use.

If the inhabitants of the world can act so vindictively toward their kith (think of the current terror in China), what possible hope can there be for peace and goodwill between nations?

It seems to me that scientists and technologists should search their souls before using their skills in the development of tools and means which might increase the powers of men and women to distort, corrupt, repress or destroy the lives of their fellow beings.

People, on the whole, aren't very nice, and probably never will be. They certainly can't be trusted to use the fruits of science wisely and well. □

# FEDERAL BUDGET

## Surpluses vs. Deficits

(in billions by fiscal years)

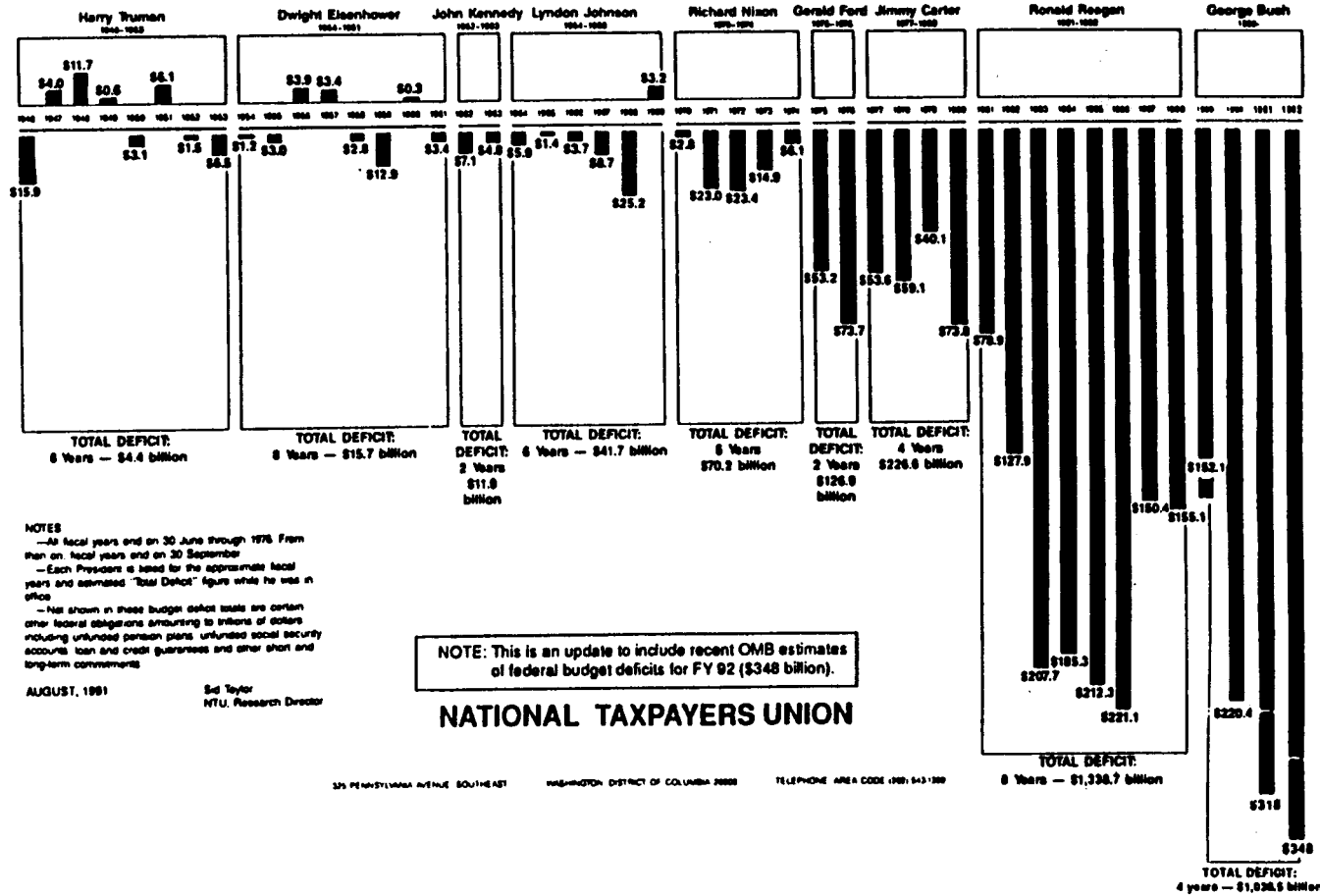

**NOTES**

- As fiscal years and on 30 June through 1976. From then on, fiscal years and on 30 September.
- Each President is listed for the approximate fiscal years and estimated "Total Deficit" figure while he was in office.
- Not shown in these budget deficit totals are certain other federal obligations amounting to trillions of dollars including unfunded pension plans, unfunded social security accounts, loan and credit guarantees and other short and long-term commitments.

AUGUST, 1991

Sid Taylor  
NTU, Research Director

NOTE: This is an update to include recent OMB estimates of federal budget deficits for FY 92 (\$348 billion).

**NATIONAL TAXPAYERS UNION**

325 PENNSYLVANIA AVENUE, SOUTH EAST WASHINGTON, DISTRICT OF COLUMBIA 20002 TELEPHONE AREA CODE (202) 543-1200

0650-B

M A T R I X I I I

# Pentagon Document Says U.S. Must Run the World

3/92

by Lee F. Scanlon

WASHINGTON, March 25 (EIRNS)—A Pentagon planning document recently leaked to the press calls for the United States to assume the role of global policeman and, more, the world's only empire—confirming what we have long said about the ultimate aim of George Bush's "New World Order." The Pentagon document says flatly that the United States must be prepared to face down any other potential superpower, in order to establish the American Imperium of which George Bush and the Anglo-American Establishment dream.

Administration officials tout the study, which is attached to the official Defense Planning Guidance, as the doctrine behind Bush's wars on Panama and Iraq. According to the report's planning scenarios, the U.S. should be prepared for repeat actions in those theaters, and action in areas as diverse as the Philippines and Korea.

Written under the direction of Under Secretary of Defense Paul Wolfowitz, the report was circulated to top military and civilian officials for review last month—the first such document produced by the Pentagon since the collapse of the Soviet Empire. According to press accounts, the classified document was leaked by high-ranking officials who oppose its imperialist outlook: namely, that the U.S. runs, and must run, the world.

Target: Central Europe

The document's regional war scenarios made public so far are, ironically, an indictment of the Bush administration foreign policy: They predict instability and government collapse in the areas where Bush has established military occupation governments (Panama, the Persian Gulf), or where the U.S. maintains fingertip control (Korea, the Philippines).

Most sinister is the scenario which assumes global economic instability leading to the emergence of a new "superpower" hostile to U.S. interests, yet predicts that the U.S. will not be able to defeat this threat with the weapons systems the present defense budget proposes to buy.

The only way a bankrupt superpower can preempt this threat, the planners insist, is to prevent any nation or group of nations from developing the power to challenge the United States' presumed global hegemony.

"Our first objective is to prevent the reemergence of a new rival, either on the territory of the former Soviet Union or elsewhere, that poses a threat on the order of that posed formerly by the Soviet Union," the document says. This means defending U.S. access to raw materials in the Third World, oil in particular; the report adds that "the new regional defense strategy requires that we endeavor to prevent any hostile power from dominating a region whose resources

would, under consolidated control, be sufficient to generate global power."

In this document, former allies become enemies—because their economic policies could easily make them stronger than the Reagan/Bush policies that wiped out America's economy. Thus, Bush administration officials have been saying for years that the primary security threat the U.S. faces is the emergence in Central Europe of an economic giant shaped by a German-model economic miracle, precisely what Lyndon LaRouche's "European Triangle" recovery proposal aims to create—for the benefit of the world as a whole, including the United States.

The Pentagon is brutally frank: There are other potential nations or coalitions that could, in the further future, develop strategic aims and defense posture of region-wide or global domination. Our strategy must now refocus on precluding the emergence of any potential future global competitor.

... First, the U.S. must show the leadership necessary to establish and protect a new order that holds the promise of convincing potential competitors—the authors mean economic competitors, not military ones—"that they need not aspire to a greater role or pursue a more aggressive posture to protect their legitimate interests. Second, in the non-defense areas, we must account sufficiently for the interests of the advanced industrial nations to

discourage them from challenging our leadership or seeking to overturn the established political and economic order" (emphasis added).

The Bushmen fear that Europe and Japan will reject the free-trade dogmas and Malthusian obsessions of the World Bank and International Monetary Fund, and curdle bankrupt Anglo-American financial system off from the usurious interest income which sustains it, by bleeding the rest of the world dry.

Any challenge to the IMF-run "free-trade system" must be met directly, according to the document, and "we must maintain the mechanisms for deterring potential competitors from even aspiring to a larger regional or global role."

The Chief of Staff of the U.S. Army, Gen. Gordon Sullivan, emphasized this by telling Congress that the Army is restructuring itself in order to react to economic threats, as well as military ones.

Like the British and the Roman Empires before it, Bush's New World Order sounds the call to confrontation, war, and bloodshed to preserve an economic system which is destroying the world, including the United States.

The people hire the politicians so that the people can:

- (1) obtain security without managing it.
- (2) obtain action without thinking about it.
- (3) inflict theft, injury, and death upon others without having to contemplate either life or death.
- (4) avoid responsibility for their own intentions.
- (5) obtain the benefits of reality and science without exerting themselves in the discipline of facing or learning either of these things.

## THE DRAFT

(As military service.)

Few efforts of human behavior modification are more remarkable or more effective than that of the socio-military institution known as the draft. A primary purpose of a draft or other such institution is to instill, by intimidation, in the young males of a society the uncritical conviction that the government is omnipotent. He is soon taught that a prayer is slow to reverse what a bullet can do in an instant. Thus, a man trained in a religious environment for eighteen years of his life can, by this instrument of the government, be broken down, be purged of his fantasies and delusions in a matter of mere months. Once that conviction is instilled, all else becomes easy to instill.

Even more interesting is the process by which a young man's parents, who purportedly love him, can be induced to send him off to war to his death. Although the scope of this work will not allow this matter to be expanded in full detail, nevertheless, a coarse overview will be possible and can serve to reveal those factors which must be included in some numerical form in a computer analysis of social and war systems.

# Pentagon's goal: world's only cop

by Patrick E. Tyler  
New York Times

3/8/92

WASHINGTON — The Pentagon has a vision of a post-Cold War era with one superpower — the United States — discouraging potential rivals by ensuring world order.

In a broad policy statement in its final drafting stage, the Defense Department says America's political and military mission will be to make sure no superpower is allowed to emerge in Western Europe, Asia, or the territory of the former Soviet Union.

The 46-page document, which Defense Secretary Dick Cheney expects to release later this month, says part of that mission will be "convincing potential competitors that they need not aspire to a greater role or pursue a more aggressive posture to protect their legitimate interests."

The classified document makes the case for a world dominated by one superpower whose position can be perpetuated by constructive behavior and enough military might to keep any nation or group of nations from challenging American primacy.

To perpetuate this role, it says, the United States "must sufficiently account for the interests of the advanced industrial nations to discourage them from challenging our leadership or seeking to overturn the established political and economic order."

With its focus on benevolent domination by one power, the document is the clearest rejection so far of collective internationalism, the strategy that emerged from World War II when the five victorious powers sought to form a United Nations that could mediate disputes and police outbreaks of violence.

Although the document is internal to the Pentagon and is not provided to Congress, its policy statements are developed with the National Security Council and in consultation with the president or his senior national security advisers.

A copy was provided to The New York Times by an official who believes the post-Cold-War strategy debate should be carried out in public. It's likely to provoke fur-

ther debate in Congress and among America's allies about Washington's willingness to tolerate greater aspirations for regional leadership from a united Europe or a more assertive Japan.

Together with its attachments on the military levels required to insure America's predominant role, the draft is a detailed justification for the Bush administration's proposal to support a 1.6-million-man military over the next five years, at a cost of about \$1.2 trillion. Many Democrats in Congress have criticized the proposal as unnecessarily expensive.

There is a strong emphasis in the document on using military force if necessary to prevent the proliferation of nuclear weapons and other weapons of mass destruction in such countries as North Korea, Iraq, some of the successor republics to the Soviet Union, and in Europe.

The document is conspicuously devoid of references to collective action through the United Nations, which provided the mandate for the allied assault on Iraqi forces in Kuwait, and which may soon be asked for a new mandate to force President Saddam Hussein to comply with his cease-fire commitments.

The draft notes that coalitions "hold considerable promise for promoting collective action" as in the Persian Gulf war, but that "we should expect future coalitions to be ad hoc assemblies, often not lasting beyond the crisis being confronted, and in many cases carrying only general agreement over the objectives to be accomplished."

What is most important, it says, is "the sense that the world order is ultimately backed by the U.S." and "the United States should be postured to act independently when collective action cannot be orchestrated" or in a crisis that demands quick response.

## Magazine describes stock deal by Bush's son

WASHINGTON — President Bush's eldest son sold \$848,560 of his stock in a Texas company just before the share prices began to plunge because of poor earnings reports, according to U.S. News and World Report.

The magazine reports in this week's issue that at the time of the sale last June 22, George W. Bush was a member of a committee formed by the Dallas-based Harken Energy Co. to study likely effects of corporate restructuring.

The magazine says Bush's stake in Harken, and his insider role, stemmed from Harken's takeover of another oil company that Bush helped found.

The magazine said Bush, as a member of a committee looking into a restructuring of Harken, had "detailed knowledge of the financial pressure Harken was under and of the demands being placed on the company by its creditors."

A week after Bush sold a large portion of his stock — he still owns 105,012 shares worth \$400,000 — Harken reported a quarterly loss of \$21 million. Harken stock has lost 60 percent of its value over six months.

The Securities and Exchange Commission did not learn of the transaction until 10 months after it should have been reported, the magazine said.

It said Bush maintains he did file the insider sale notice as required, but that it was lost.

U.S. News said Bush declined to discuss his ties to the company with the magazine.

# BOOK WORLD

## Remember That Other No-Account Bank? *HELLE IT IS - MOIRE PRICE THAT GOVERNMENTS & BANKS ARE DEALING DRUGS!*

### DIRTY MONEY BCCI: The Inside Story Of the World's Sleaziest Bank

By Mark Potts, Nicholas Kochan and Robert Whittington  
National Press Books, 283 pp. \$21.95

Reviewed by Robert Sherrill

There's one thing you can say for the crooks who ran the Bank of Credit and Commerce International—they weren't cheap. Maybe as much as \$20 billion—that's billion—went down their sewer, stolen, lost, swindled, making this what the authors of "Dirty Money" accurately call "a scandal of nearly unimaginable proportions."

The collapse of BCCI branches in three dozen countries ruined many thousands of depositors. But the bankers couldn't create such financial devastation alone. They had to have the help of the same kind of chaps who became so familiar during the S&L disaster: slick lawyers, an underworld apparatus with a respectable front, bugging auditors, and bureaucrats and politicians who, either because they were bought off or were unbelievably stupid, didn't watch out for the public.

Even if you've followed newspaper disclosures of BCCI's sins—fraud, money-laundering, bribery (BCCI officials were so fond of bribing that they sometimes practiced on each other), and absolutely masterful juggling of accounts—you should also read "Dirty Money." It's special. Mark Potts, one of the several reporters who kept The Washington Post on top of this mess, and his European colleagues, Nick Kochan and Robert Whittington, bring everything together with a clarity (though their cast of characters is filled with names like Syed Ziauddin Ali Akbar) and nicely mordant analysis that is hard to achieve in the daily press. It's an infuriating but grand yarn, laced with juicy rumors, Middle East cultism and one shrinking corpse.

They have dodged libel laws with many polite disclaimers throughout the book ("there has not yet been concrete evidence," etc.), but you'll have no trouble interpreting how the authors really feel about the people who let this scandal happen. All the right questions are raised.

For instance, Potts et al. tell us that at least by the mid-1980s a lot of people in key agencies (IRS, Customs, CIA, Drug Enforcement, Justice etc.) were aware that BCCI was a criminal operation, helping terrorists, drug dealers, arms traders, smugglers and spies, who, in fact, knocked to BCCI's doors. Whispers and memos about the bank's sleaze had zipped around the bureaucracy for years.

With a reputation like that, how come BCCI had so many friends in high places—guys like Republican Sen. Orrin Hatch of Utah, who made a stirring speech in defense of BCCI at the very time it was indicted for money laundering, and Jimmy Carter, who was so grateful for the \$8.5 million BCCI gave his favorite charities that he went around helping the bank dedicate new branches.

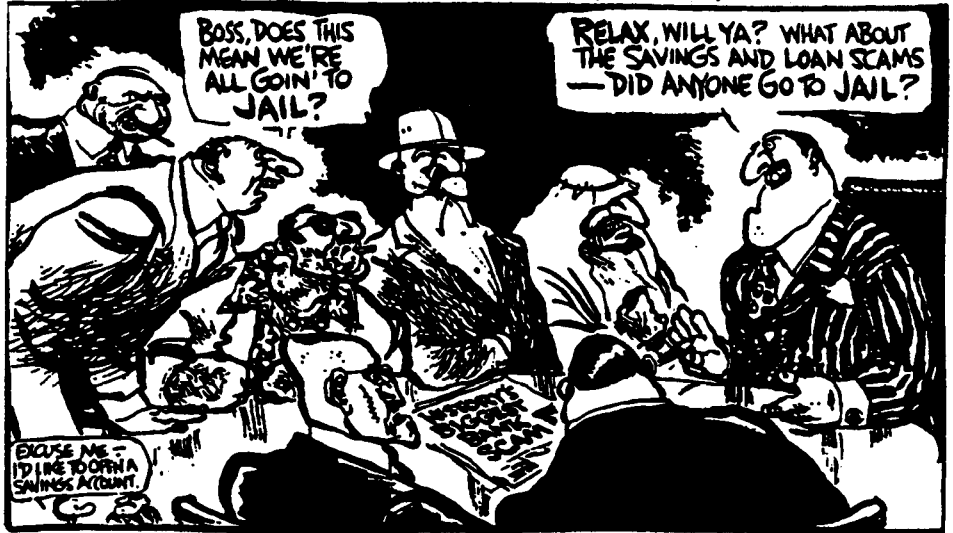

EMERGENCY MEETING OF THE BOARD OF DIRECTORS OF BCCI.

BY CURRYAN

In one of their frequent understatements, our authors note that "BCCI's American history demonstrates the bank's uncanny ability to cozy up to the politically powerful and to use them, wittingly and unwittingly, to achieve the bank's nefarious ends."

What was so uncanny about it? Big money invites coziness, as shown by those good ol' boys in the Georgia legislature who belied right up to what looked like \$125 million in bribes, after which they passed a special banking law to help BCCI.

Copying up was also very profitable for that elegant fuzer Clark Clifford (whom one BCCI official regrettably referred to as "the godfather of the Democratic Party") and his law partner Robert Altman. "Dirty Money" reviews the "corporate shell game" that created BCCI's quasi-secret and illegal ownership of Washington's First American Bankshares, and of course it also spotlights, with appropriate hoots, the role played by Clifford and Altman, who, though they ran the bank and were lawyers for BCCI, professed shock—like the police chief in "Casablanca"—to learn that they were fronting for naughtiness in the back room.

BCCI handled billions in drug money and "turned money laundering into a high banking art." Caught and tried, BCCI spent \$21 million on a defense team that included not only Cliff

ford and Altman but seemingly every influence-peddler along Washington's K Street power corridor. The bank escaped with a dinky fine of only \$14 million, after which, our authors say, the inept Justice Department made "almost no effort to digest and follow up on the mountain of leads into other potential cases."

Among other top competitors for a prize for incompetence are the Federal Reserve Board, which didn't notice that BCCI was openly running First American, and the accounting firm of Price Waterhouse, BCCI's blithe auditor for nearly two decades, which "continued to give BCCI a mostly clean bill of health even as the bank was virtually insolvent."

"Dirty Money" clearly leaves the impression that many officials are less than enthusiastic about digging deeper into the scandal. Could it be because of that rumored list of "100 politicians that BCCI paid off"? Or because "key investigators" have indicated that if they continued their probe it might take them "into the highest levels of political power around the world in ways that would dwarf even the wildest conspiracy theory." Whoa! That would never do.

Robert Sherrill is the corporations correspondent for the Nation.

### HOUSE OF CARDS Inside the Troubled Empire Of American Express

By Jon Friedman and John Meehan  
Pantheon, 272 pp. \$24.95

Reviewed by L. J. Davis

With the economy in a shambles no matter what Alan Greenspan and President Bush say about it, and with members of the public vaguely aware that something absolutely terrible has been done to them, there has been a veritable spate of books purporting to describe various aspects of these intimately related problems.

These fall, I find, into two rough categories. First, there are the scholarly tomes, usually composed by lawyers or economists, filled with bursting with charts and graphs and sometimes mathematical formulae, and largely comprehensible only to other lawyers and economists. As far as the general reader is concerned, these books might as well have been written in Venusian, for their prose seems to belong to no known terrestrial family of languages.

## How the Deck Was Stacked Against American Express

The second school of business writing, largely staffed by journalists, attempts to apply the tools of fiction to a selected and usually colorful aspect of the crisis, such as the gigantic leveraged buyout of RJR Nabisco or the shenanigans of T. Boone Pickens Jr. These books, of which one of the best is James Stewart's recent "Den of Thieves," come equipped with dialogue, rounded characterizations of the participants, a clear (or kind of clear) exposition of the issues at stake, and vivid descriptions of boardroom warfare and backstairs duplicity.

Although often rewarding the reader with a corking good read, such books also attempt to place their stories in a larger

context—hostile takeovers in general, the wonderful world of greenmail, that sort of thing—and are remarkably dependent on human, as distinct from paper, sources for their information. In a business story, these sources are generally federal regulators and attorneys, corporate executives, investment bankers, private (and very expensive) lawyers, and assorted hotheads and malcontents. Although the use of such sources places the writer in the enviable position of viewing the proceedings through the eye of the fly upon the wall, it also poses one very considerable risk: that the reporter will grow to like, and therefore trust, one or more of his sources, violating the prime directive of our profession. Never trust anybody. Ever. Until you check him out.

# THE POLITICAL PULSE



BY STAMATY FOR THE VILLAGE VOICE/THE WASHINGTON POST

## HABIT PATTERNS -- PROGRAMMING

### Strengths and weaknesses:

- (1) activities (sports, hobbies, etc.)
- (2) see "legal" (fear, anger, etc, --crime record)
- (3) hospital records (drug sensitivities, reaction to pain, etc.)
- (4) psychiatric records (fears, angers, disgusts, adaptability, reactions to stimuli, violence, suggestibility or hypnosis, pain, pleasure, love, and sex)

### Methods of coping -- of adaptability -- behavior:

- (1) consumption of alcohol
- (2) consumption of drugs
- (3) entertainment
- (4) religious factors influencing behavior
- (5) other methods of escaping from reality

### Payment modus operandi (MO) -- pay on time, etc.:

- (1) payment of telephone bills
- (2) energy purchases (electric, gas,...)
- (3) water purchases

# CIA BCCI

Cox News Service

WASHINGTON — The Central Intelligence Agency distributed hundreds of reports on the outlaw Bank of Credit and Commerce International, but failed to tell the Federal Reserve or Justice Department that BCCI secretly owned a U.S. bank, acting CIA Director Richard Kerr told a Senate subcommittee yesterday.

A 1985 report that BCCI had gained control of Financial General Bankshares, predecessor of First American Bankshares, was sent only to the Treasury Department, Kerr said, on the assumption that any vital information would be forwarded to the appropriate agency.

It was, he said, "a legitimate decision based on our understanding of who . . . had responsibility for it," though "with hindsight, we might have done it differently."

"I think it's a mistake of judgment," said Sen. John Kerry, D-Mass., chairman of the Foreign Relations subcommittee on terrorism. He promised to hold further hearings on the subject and summon Treasury officials to testify.

The ranking Republican on the panel, Hank Brown of Colorado, called it a "major breakdown" that raised serious questions about CIA management.

"If you know about a fire, you don't call the city manager's office, you call the fire department," Brown said. "They called the city manager."

The CIA produced several hundred reports either about BCCI activities or mentioning the bank, Kerr testified, and distributed them to a variety of federal agencies, depending on the subject matter involved. These "intelligence consumers" included the FBI, Drug Enforcement Agency, National Security Agency, the Customs Service, Commerce Department, the Federal Reserve Board, Department of Energy, State Department and even the U.S. trade representative.

The CIA was more interested in what BCCI was doing rather than who controlled the bank, Kerr testified. "We were focused on larger strategic problems and issues, not on the bank itself or the individuals involved," he said. "We were focused on a set of activities that really went beyond BCCI."



Kerr

## Warnings on BCCI ignored, panel told

WASHINGTON — U.S. prosecutors ignored repeated warnings about illegal activities in this country by the scandal-plagued Bank of Credit and Commerce International and its customers, a Miami attorney told Congress Friday.

James Dougherty, who represents an insurance group that has sued the bank, said he appealed directly to then-Attorney General Dick Thornburgh last December when he found evidence the bank was likely to destroy or move records of its activities.

"We received no response to that," Dougherty testified to the Senate Foreign Relations subcommittee on narcotics.

The subcommittee, headed by Sen. John Kerry (D-Mass.), is conducting its own investigation of BCCI, which has been implicated in a worldwide network of illegal arms sales, drug trafficking and money laundering.

## Ex-BCCI executive rejects Altman's word

WASHINGTON — A former top executive of the Bank of Credit and Commerce International on Tuesday disputed statements by Washington attorney Robert Altman that he was unaware of the bank's secret ownership of First American Bankshares Inc.

Abdur Sakhia, who worked for BCCI for 13 years in the United States and Britain, was testifying before the Senate Foreign Relations subcommittee on terrorism, narcotics and international operations.

$$\lim_{n \rightarrow \infty} f^{(n)}(x) = x$$

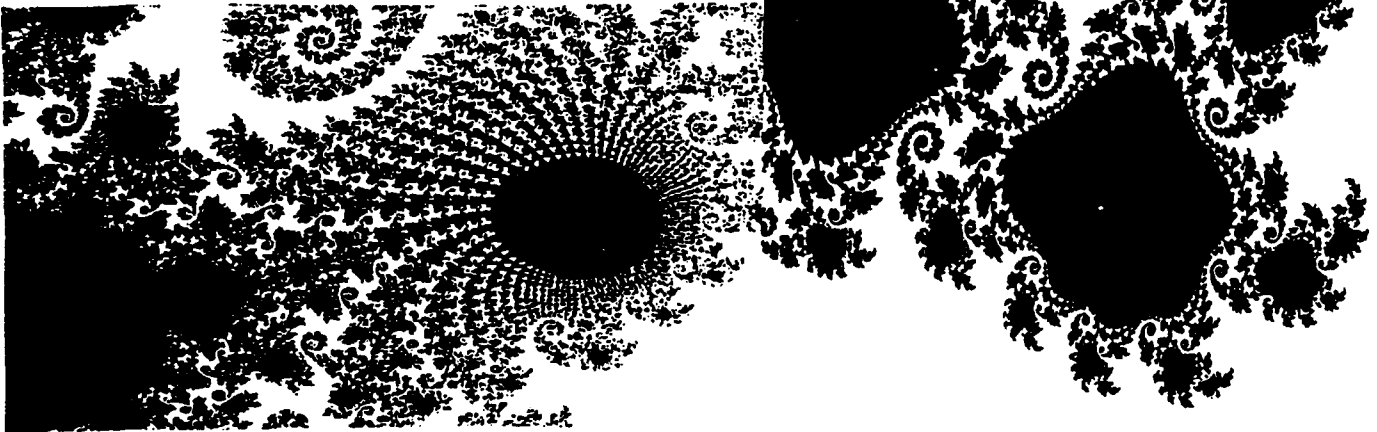



In Idaho, Oregon

## U.S. building forest preserves or prisons?

By TONY BLIZZARD

Jim Townsend's lead article in the October National Educator exposed the illegal federal confiscation of public land in this country while making another point. But back in those federal woods things are happening of which true Americans need to be aware. There is no chance of the feds turning loose a square inch of this land willingly but it may be home for some of us anyway.

We have firsthand accounts of strange doings in isolated parts of national forest land in Oregon and Idaho and expect the same type of destruction is taking place elsewhere. Destruction is the proper term as 50-acre plus areas of forest are being totally denuded by the forest service, some of it by private contract. This land is being screened of all twigs, rocks and any stones more than one inch in diameter over the whole surface and two feet deep under it. Then eight-foot cyclone fences, which also extend about four feet underground, are being erected around the perimeters. So what do we now have inside that fence? According to the forest service, it is an area for seedling plantings. Ostensibly, the fence would be there to keep browsing animals apart from the seedlings.

There is some rationale to this. Yet the burying of the fence under the ground is disturbing. In the light of the Bush administration's plan to incarcerate those too much opposed to his banker's war, once he gets it started, another use for these compounds

comes to mind.

No longer do various federal agents conceal their in-place plans to suspend our Constitution on the pretext of some emergency (such as the Bush war). FEMA has been fleshed out and made ready to enforce the coming military type dictatorship which will supersede our representative government.

There will be a percentage of Americans who will not cower to the governmental terrorism designed to instill total submission of the people. If simply murdering these people at point of contact is deemed counterproductive the proven tactic of rounding them up in concentration camps for whatever means of disposal will be used. Rumors of barbaric treatment drifting back to the general populace from such places usually keeps it more docile than blood in the streets.

The inaccessibility of these new compounds plus the forest service's obvious desire for the public not to be aware of them tends to weigh heavily toward the idea of concentration camps in our public lands.

And why not? Although the public has been propagandized for years on the need to preserve the West's naturalness for future generations, the facts are different. Designated wilderness areas consistently coincide with desperately needed natural resources which the owners of our government have thus tied up for future profit. Their profit.

The federal government has

condemned and confiscated, for small compensation, private properties in remote locations and turned these into king's hunting, wenching and Machiavellian planning grounds. Mere citizens cannot enter these forest except on foot or horseback and must camp in primitive fashion, while the king's men easily arrive at their plush quarters deep inside them by helicopter.

Some of us in years past were hired by the forest service to build log cabins in the wilderness areas for the use of hunters and campers. Yet,

in the last ten years, all the while government agents have been advertising public use of public lands, agents have been systematically burning out all these cabins and hundreds of privately owned dwellings on lawful mining claims, practically locking the people out of vast areas of public land.

In the last few years, government edicts have established permits and fees even for such mundane purposes as cutting firewood in the people's own forests. Hunting and fishing regulations are ever more restrictive with some state game wardens now armed against the citizenry causing the inevitable confrontations such as that forced by the insolent and swaggering Pogue against Claude Dalls which cost Pogue and one other their lives and Dalls his freedom.

Governmental tyranny is not new on its unlawfully held lands or even private land. It is an ongoing and ever increasing program of design to do away with private ownership, ala Karl Marx & Co.

Only armed and determined citizenry will halt and reverse this blatant property theft with its consequent economic slavery — for the enemies of the people work from the axiom: He who owns everything owns he who owns nothing.

*In Addition to this information, we found out at Preparedness Expo 91 that last year the government built a 70-acre oven facility in central Oregon, allegedly for disposal of hazardous waste. After bringing several trucks of waste there for several days, the trucks of waste left, and there have been no trucks there since. A facility of similar nature was built at Coonway, Alberta. Also, several dirt bikers in central Oregon reported that they stumbled on an 8-lane dirt road and were met by three 300-pound, 6-foot lookalikes, who warned them to "leave or you're dead!"*

*Anybody like to guess what's happening?*

# A STRANGE AFFAIR, AND A STRANGE SEQUEL

By Gordon Creighton

WE have received from Mr. Thomas M. Olsen of Phoenix, Arizona, U.S.A., a weird account of how a woman (name on record with FSR but withheld from publication) photographed a UFO, in broad daylight, in 1989, over the town of Little Rock in the State of Arkansas, and we have Mr. Olsen's special permission to publish it, and it is given below, as *Item I*.

Then, as first follow-up, we offer *Item II*, Mr. Olsen's letter to us of May 21, 1990, giving additional information about the lady's sighting, and next, as *Item III*, the lady's letter of May 2, 1990, to him, describing her own psychic predictions or "hunches".

Following, as *Item IV*, we give the full text of a highly "interesting" document dated August 6, 1990, which in some way (we know not how) had come into the possession of the radio broadcaster Mr. Robert Early of *Station KBIS-AM* at Little Rock, and which Mr. Early had then sent on to Mr. Timothy Good in England.

There follows, as *Item V*, Mr. Olsen's letter of February 4, 1991, to me. Although, as readers will see, Mr. Olsen states at the beginning of this letter: "*I suspect it is spurious*", I now feel that this is by no means an accurate reflection of his thinking. For, quite recently (in the early part of June 1991) I spoke by telephone to both Mr. Olsen and Mr. Early, and both of them gave me the clear impression that they regard the "*IAA Document*" as rather more likely to be genuine than not, although both of them agree that various other reliable UFO investigators in the USA who have seen the document, or copies of it, do incline to view it as a hoax. At any rate, it seems a good idea that we publish the "*IAA Document*" now, and let FSR readers form their own opinions about it.

The principle reason for my own belief that it is no hoax is the fact, established by Mr. Olsen, that whoever compiled this document unquestionably possessed an astonishingly detailed knowledge not only of the lady's correspondence with Mr. Olsen, but even of her confidential conversations with trusted friends!

Be it noted however that the lady herself does seem to know something about the identity of the "*IAA*" organisation, because I understand that she was greatly alarmed by the document. Indeed, if we read every line of this material carefully, we can see that she may indeed know personally who some of the "*IAA*" members are!

We may of course all be quite sure that, both in the USA and in Britain, and indeed probably in every other developed country, there are secret bodies and organisations who take a very real and very "loving" interest in the doings and activities of all of us who are awake to the existence of the *LFO Problem*. Clearly we represent some sort of "danger", whereas the still-slumbering masses can never be a "danger".

Here in Britain, even in quite small towns and communities, we have been aware, and for many years past, of the presence of some sort of organization such as is indicated by paragraph 7 of Mr. Olsen's letter of February 4, 1991, to me. If, as Mr. Olsen says, an individual named Al Belic has actually told Robert

Early that the "*IAA*" (INTERCONTINENTAL AEROSPACE ALLIANCE) is "a secret body funded by every major government, with about 2,500 staff, for UFO cover-up", why, then, surely it must have its branch — or at the very least a representative — here in the small English town where I live, and EVERYTHING AT ONCE BECOMES TOTALLY EXPLICABLE INCLUDING THE MASSIVE DISAPPEARANCES FROM THE INCOMING MAIL. FOR FSR FOR MANY YEARS PAST.

Anyway, it is certainly my hope that, in publishing this "*IAA Document*", I am providing an opportunity for our readers everywhere to study its style and contents very carefully. And I hope in particular that many of our American and Canadian readers will be encouraged to tell us anything they know about this devoted body, the "INTERCONTINENTAL AEROSPACE ALLIANCE", who take such an interest in the welfare and the affairs of humble and lowly folk like ourselves and who, as the "*IAA Document*" shows, say they found the lady witness in Little Rock so "uncooperative", and who are displaying such a fanatical zeal in hunting down and purloining the negatives and all prints of her photos, and in blocking all possibility of their publication or even of their discussion.

I might add that — apropos of the "delicate" question of official "snooping" and the listening and tapping and surveillance of telephones and the opening of mail (as well as the outright theft of correspondence), the tradition of secret censorship of the mail in Britain goes right back, unbroken, to the days of Good Queen Bess and her Ministers Cecil and Burghley, and no country on earth possesses greater expertise at the game. Only three or four days before the writing of these lines, in June 1991, it was stated in the House of Commons that official sanction is at present being granted for "telephone-tapping" in Britain at the rate (an all-time record) of 35,000 cases per year. In reality however there is good reason to suspect that the cumbersome old system of "tapping", and the issue of permits for same, may well have both ended long ago, and that ALL 'phone conversations here are now under permanent, mechanical, and automatic surveillance, without any requirement whatsoever for the employment of human listeners. For example, the process of recording could be instantly "triggered off" by the mere pronunciation of any "sensitive" key-word or key-phrase or key-subject which, to the ears and minds of those who "snoop and watch", might rate as "interesting".

It is over ten years now since a good personal friend of mine, who was working temporarily as a telephone-operator on the international traffic into and out of England, came to tell me that he had discovered that my telephone was being "tapped". I told him that I had always assumed that this was so, and that frequently, during 'phone conversations, I informed the other party to that effect.

Finally, at *Item No. 17*, we give the text of a further letter, dated March 9, 1991, from Mr. Olsen, containing, as readers will note, a very important correction for insertion into his earlier letter of February 4, 1991, to me.

# Ultrasecret U.S. spy agency ultraexpensive too, critics say

By Tim Weiner

Knight-Ridder Newspapers

4-19-92

WASHINGTON — Inside the Pentagon, behind a double-locked door in Room 4C956, is the headquarters of a military agency bigger than the State Department, more secret than the CIA.

The coded locks on the lead-lined door and the armed sentries in the corridor guard the National Reconnaissance Office, the United States' most clandestine — and most expensive — intelligence agency. NRO spies are reading the electronic mail and watching the military movements of friends and foes.

The agency builds and operates the nation's secret space satellites, code-named Vortex, Lacrosse, Magnum and Keyhole. These spies in the sky can see license plates from deep space, peer through clouds to survey battlefields, track armies fighting at night and eavesdrop on the world's telecommunications.

Everything about the NRO, including its name, is supposed to be Top Secret. National security laws prohibit members of Congress from speaking the words "National Reconnaissance Office" in open session. The NRO's budget, an estimated \$7 billion a year, appears nowhere on the Pentagon's books. Officially, the NRO does not exist.

But it's no secret the agency is in trouble with Congress, the CIA and the Pentagon.

Its critics in the intelligence community say the NRO is wasting fortunes with gold-plated technology and tangled chains of command. They want to overhaul or abolish it and save billions.

The NRO's incapacities are "a glaring gap ... in an area where many, many, many of our dollars are going," Senate Intelligence Committee Chairman David Boren (D-Okla.) told CIA Director Robert Gates at a public hearing earlier this month.

"It is not a million-dollar area," Boren said. "It's a multibillion-dollar area."

More than money is at stake. The Pentagon said last week it inflicted "unnecessary" bombings on Iraqi civilian targets during the Persian Gulf War because the NRO's spy-satellite pictures "were neither timely nor adequate."

Because the satellite imagery was piecemeal, U.S. bombers struck Iraq's public utilities repeatedly, the Pentagon said. The destruction of Iraq's electrical grid and sewer systems led to thousands of civilian deaths, according to U.S. physicians and relief workers.

Without mentioning the agency by name, both Desert Storm commander H. Norman Schwarzkopf and Gates have called the NRO's inability to deliver timely battlefield intelligence one of the biggest failures of the war.

That is hardly the NRO's only problem. A CIA task force recently rebuked the agency for huge cost excesses in building its satellites, which now can cost more than \$2 billion each. The CIA team said the NRO's operations had become so sprawling and complex that no one was in charge.

Much of the satellite data flow past analysts who have no time to study it. The costly intelligence ends up gathering dust in a vault, according to several intelligence veterans.

The NRO also has been shaken by the end of the Cold War. Until recently, the primary target of its satellites was the Soviet Union and its nuclear weapons. The urgency of that task is disappearing along with the Soviet military threat.

At the April 1 hearing before members of the congressional intelligence committee, Gates said the NRO needed major restructuring. But Gates rejected his own task force's recommendation for a new agency to consolidate the nation's orbiting intelligence systems.

Trying to reform the NRO "cracks the most crockery" of any post-Cold War changes in the nation's spy networks, said House Intelligence Committee Chairman Dave McCurdy (D-Okla.).

MIT: The Bastion Against Cheap Power

## TECHNOLOGY

# MIT to Hear A New Report On Cold Fusion

By JACOB M. SCHLESINGER

Staff Reporter of THE WALL STREET JOURNAL

OSAKA, Japan — A physicist from this industrial city will walk into an American lion's den today with a report that may well revive the "cold fusion" controversy.

In a lecture at Massachusetts Institute of Technology in Cambridge, Mass., Akito Takahashi of Osaka University will describe a unique cold fusion experiment that for more than two months, he says, has been producing an average of 70% more power as heat than it is consuming in electricity. The experiment already has created a stir among Japanese scientists and in the Japanese press.

"The total amount of heat generated is unbelievably large," says Hideo Ikegami of the National Institute for Fusion Science at Nagoya University. "It shows positive results, and it's reproduced so many times."

Dr. Takahashi may create another stir in Cambridge, albeit of a different sort. From the day cold fusion hit the headlines three years ago, MIT has been a stronghold of physicists who charge that cold fusion claims are nothing but a huge mistake. Before departing for the U.S., Dr. Takahashi showed a visitor letters he has received from U.S. scientists. "I'm afraid they will eat you alive at MIT," one warns.

Fusion physicists skeptical of Dr. Takahashi's results are likely to attack the same weakness that has plagued other cold fusion claims: The nuclear radiations from the experiment are only a tiny fraction of what they should be if known hydrogen fusion reactions are generating the heat.

"I will say what we observed," the soft-spoken, graying nuclear physicist says of his MIT lecture. "That's the only thing I can do." **GAS ORDER?**

Dr. Takahashi, along with many other scientists around the world, thought the dream of unlimited energy from the fusion of hydrogen atoms might have come true in early 1989, when chemists Martin Fleischmann and B. Stanley Pons announced in Utah that they had achieved hydrogen fusion at room temperature in a simple laboratory beaker.

The Japanese physicist tried to duplicate the results, and, like many others who tried, he failed. Most scientists then gave up and declared that Messrs. Fleischmann and Pons were grossly mistaken. But Dr. Takahashi and his group of researchers have persisted for over 2½ years.

This year, his experiments began to register large increases in heat — so much so that in February he was forced to cut the electric current when the water in the experiment started boiling. His caution was prompted by the fact that a month before, a researcher from SRI International in Menlo Park, Calif., had died from an explosion during a cold fusion experiment. But even with the charge reduced, the excess heat continued.

The Osaka experiment differs in significant details from the earlier experiments of Drs. Pons and Fleischmann. The experiment, like most other cold fusion experiments, involves immersing an electrode of palladium, surrounded by an electrode of platinum wire, into a bath of "heavy" water. Heavy water is rich in deuterium, a heavy form of hydrogen. An electric current is applied to what is essentially a water electrolysis apparatus.

Instead of using a slender rod of palladium, however, Dr. Takahashi uses a foil of palladium about an inch square. And instead of applying a steady electric current, he "cycles" the current up and down.

— Jerry Bishop in New York contributed to this article.

# Scientific American Won't Tell U.S. Cold Fusion News

by Carol White

March 13 (EIRNS)—America's most prestigious popular science magazine, Scientific American, puts out a Japanese-language as well as an English-language version each month. Both issues are identical in content, except for two pages of "local" Japanese news.

In the March issue of the magazine, a breakthrough on the cold fusion front was covered favorably in Japanese and completely ignored in English. This is in keeping with the policy of Scientific American, which has been to spread the big lie in the United States that cold fusion is dead.

## The Takahashi Breakthrough

Since Dec. 20, 1991, a Japanese cold fusion experimenter, Akito Takahashi, has been getting steady excess heat from a cold fusion cell of over 150%, at power densities which average in the range of 100 watts per cubic centimeter (enough power to keep a lightbulb going).

On two occasions, heat in the cell shot up to over the boiling point, and Takahashi believes that the power may have scaled up as high as 500 watts per cubic centimeter. While Fleischmann and Pons have peaked at a kilowatt per cubic centimeter, the heat bursts which they see are far more episodic than the steady high heats Takahashi is getting.

This intrepid experimenter has stayed with the Fleischmann-Pons experiment for over three years, and he has had many minor successes with his experiment, such as detecting the emission of high-energy neutrons, and the production of tritium, but this is the first time that he has achieved these impressive heat results.

The Takahashi experiment is now being repeated in laboratories around the world, including in the United States.

Last month, Hideo Ikegami, of Japan's National Institute of Fusion Energy at Nagoya University, gave a report on cold fusion advances in Japan to a scientific meeting at Frascati laboratory, and Takahashi's breakthrough made headlines in the major Italian press. Such, of course, has not been the case in the United States, where cold fusion is officially reported to be dead.

## How America Falls Behind

Indeed, cold fusion seems to be going the way of all recent technological and scientific breakthroughs—out of the United States and into Japan. Can we accuse Japan of unfair trade practices in this instance, where a viciously unfriendly press and a hostile science establishment virtually drove Fleischmann and Pons out of the United States and (so it is rumored) into the arms of the Japanese?

Here we have the case of an American science magazine suppressing exciting developments on the cold fusion front here at home, but reporting on them honestly—to the Japanese. Whose fault, then, is it that Americans are becoming scientifically illiterate, as young people become less and less enthusiastic about studying scientific subjects?

Let's look at what Scientific American is willing to tell the Japanese, but unwilling to share with us.

The article begins by citing the debate over whether cold fusion is real or the product of experimental error, and then says, "Now, Prof. Akito Takahashi, of the Osaka University Engineering Department, has successfully produced a stable cold fusion heat reaction that continued for over a month."

It is a fact that the only popular press to tell the truth about cold fusion are New Federalist, the Executive Intelligence Review, and 21st Century Science and Technology magazine.

# Cold Fusion

## The Enemies of Cold Fusion

The press conference was chaired by Dr. Eugene Mallove, author of the book "Fire from Ice," the story of the development of cold fusion. Mallove updated the story of persecution of the many scientists who confirmed Fleischmann and Pons' contention that fusion could be achieved at room temperatures, only to be ostracized by the leaders of the scientific establishment.

After the publication of his book, Dr. Mallove, who had been a press officer at MIT, resigned from his position there rather than defend what he saw to be a deliberate fraud being committed by leading scientists at MIT to discredit the Fleischmann-Pons results.

Mallove reviewed the hideous treatment accorded cold fusion experimenters in the United States, and said he believed technological implementation is very near. "Within this decade, I would expect to see cold fusion cells heating homes and perhaps even powering home-generating stations in certain situations. . . . Spectacular applications to aerospace are also possible, such as the powering of electric ion thrusters."

Mallove and Preparata attacked the vicious witchhunt conducted in the U.S. and Europe against scientists who had the courage to attest to the reality of this revolutionary new science, and then were subjected to persecution similar to that which drove the two pioneers to leave the United States.

In perhaps the most exciting moment of this dramatic press conference, Dr. Preparata gave an impassioned defense of truth in science: "I want you to understand that we are in a really serious situation, because our science is now dominated by an Aristotelian ideology, and this is what lies behind the adverse reaction that we are getting to the results of cold fusion.

"We are witnessing the birth of a new physics here, but the scientific establishment behaves like a priestly caste that will not allow in any new ideas. Really, we are in a situation with respect to microphysics analogous to the situation after Copernicus had shown that the Ptolemaic epicycles could be replaced" as an astronomical model.

## Fusion in His Basement

Mallove also announced that he and some collaborators were attempting to repeat experimental results obtained by Dr. Akito Takahashi in Japan. Takahashi has run a cold fusion cell over a two-month period with well over 100% excess heat, at an average power density conservatively estimated at 50 watts per cubic centimeter.

On two occasions, he witnessed sudden bursts of excess heat which caused his electrolyte to rapidly boil off, and once, when he removed his experiment from the electrolyte, he saw the beginnings of what he feared would be a runaway fusion reaction. To avert this he restarted electrolysis, thus effectively stirring the electrolyte in order to bleed heat more easily from the overheating cathode.

Mallove hopes to have himself some confirming, positive results by the time Dr. Takahashi comes to MIT, where he is scheduled to give a talk April 15. Mallove warmly described Takahashi's collaboration with the international scientific community to replicate his experiment.

Unlike the case of hot fusion—in which nuclei of deuterium (the heavy isotope of hydrogen) are accelerated to high speeds so that they will crash into each other and fuse into a new heavier nucleus—in cold fusion the remarkable metal, palladium, is used to promote the fusion reaction.

Takahashi uses a palladium cathode (positive electrode), with a plate-like shape and a volume of 0.6 cubic centimeters. Using electrolysis, he pumps deuterium (which is liberated by electrolysis from a heavy-water electrolyte) into the palladium, in a ratio above one atom of deuterium to each atom of palladium. Other groups in Japan, Italy, and the United States are repeating his experiment.

In response to one reporter's obsessive demands for an explanation of why some scientists had been unable to reproduce the Fleischmann-Pons results, Preparata explained that certain criteria had to be met in the loading of the cells—that is, the procedure by which deuterium is caused to be absorbed into the palladium metal lattice. But once these are met, competent experimenters can and have regularly reproduced the phenomenon of cold fusion.

Preparata pointed out that cold fusion scientists are being subjected to a double standard. There are experiments that go on in the solid-state physics lab, in which the accepted phenomena are much more difficult to reproduce than this one. Often things go wrong. But no one ever questions the validity of the phenomena, because these are done in the laboratories supervised by Nobel Prize winners who are considered unassailable, Preparata asserted.

"You are dealing with a subtle process here which must be explained by real scientific thinking," Preparata said. Then he directed an impassioned appeal to the audience that they, especially the laymen, not be dissuaded from fighting for scientific truth. "For the sake of your children, for the sake of the future of humanity, we must fight this stranglehold on science that affects us all."

Working with a scientific team in Nice, France, Pons and Fleischmann are now routinely achieving power densities in the range of one kilowatt per cubic centimeter, in a series of repeatable experiments. This is a power density about 1,000 times greater than that achieved in commercial nuclear fission plants.



## The Secret Alliances of the CIA from World War II to Watergate

by Howard Kohn  
(from *Rolling Stone*, May 20, 1976)

Bob Haldeman sat in the Oval Office and outlined the problem. A security guard had stumbled onto a burglary at Democratic National Headquarters six days earlier. FBI agents had been asking embarrassing questions ever since.

Richard Nixon's solution, as recorded by the White House taping system, was simple: the CIA should tell the FBI to call off its detectives. The CIA would agree, Nixon assured Haldeman, because "if it gets out that this is all involved, the Cuba thing would be a fiasco—it would make the CIA look bad—and it is likely to blow the whole Bay of Pigs thing which we think would be very unfortunate, both for the CIA and the country."

Haldeman carried Nixon's message to CIA director Richard Helms. And later he told the Senate Watergate committee of Helms's reaction to the Bay of Pigs reference: "On that one Mr. Helms jumped up very rapidly and very defensively to say, 'That is of no concern at all. We don't want to get into that at all.'"

The Bay of Pigs operation had taken place ten years earlier as a plan to overthrow the government of Fidel Castro. Among its participants had been John F. Kennedy, Robert Kennedy, Richard Nixon, Mafia leaders and hitmen, Howard Hughes, the CIA, Richard Helms, Charles "Bebe" Rebozo, Robert Maheu, E. Howard Hunt, Frank Sturgis and the Mullen Agency. Then they all reappeared in the Watergate scandal.

All except the Kennedy brothers. They were dead.

Both the Bay of Pigs affair and the Watergate scandal were rooted in the cynicism of a World War II alliance.

The year was 1942. The U.S. had just entered the war. The Department of War was worried that Nazi saboteurs were infiltrating the docks and shipyards along the East Coast. Already the troopship *Normandie* had burned and sunk in her Manhattan berth.

Then a Navy officer suggested seeking help from the Mafia, which controlled an army of toughs through its influence in the dock-workers' unions. In short order, Naval Intelligence officials struck a bargain with Meyer Lansky.

Lansky had grown up in a scruffy New York neighborhood where he had learned to bootleg, loan-shark and kill on assignment. He also had gained a reputation as a business wizard and become close friends with Lucky Luciano, the Mafia's don of dons.<sup>1</sup> In 1931 Luciano's hitmen had carried out a bloody purge of the Mafia's old guard "Moustache Petes" to clear the way for his takeover. Then he had employed Lansky to modernize the Mafia's ingrown family structure. But in 1936 Luciano had been sent to prison with a 50-year sentence, a misadventure that jeopardized the vision of a new mafia. Other leaders in the blood-oath Sicilian fraternity still considered the Jewish Lansky an outsider and, without Luciano around, balked at his innovations.

Lansky saw the Naval Intelligence deal as a chance to improve his position among the ruling lords of organized crime by opening prison gates for the don of dons. Lansky persuaded

Luciano to have Mafia henchmen patrol the waterfront. In turn, Luciano was to be set free.

As New York City's Mafia-fighting special prosecutor, Thomas Dewey had catapulted to the governor's chair by putting Luciano behind bars. But Governor Dewey now agreed to the deal and transferred Luciano from Dannemora state prison, known as "Siberia," to gentlemen's quarters at a prison near Albany. Then, shortly after V-E Day, he signed the parole papers.

By then the Mafia had developed a larger friendship with the Office of Strategic Services (OSS), the country's first autonomous intelligence agency, set up to oversee all wartime espionage. The OSS made a pact with the Mafia, known as Operation Underworld, that included gangland assistance for the Allied armies when they landed in Sicily. Having an IOU from the OSS seemed like a shrewd investment for the Mafia.

But at the war's end in 1945 the OSS was disbanded, a move that dismayed both the Mafia and a secret circle of businessmen, politicians and espionage experts.

The men in this circle were from well-bred, well-educated backgrounds, generally easterners with connections at the highest levels of government and finance. Allen Dulles, a Princeton graduate and former top-ranking OSS official, and Governor Dewey were two of their leaders. Both Dulles and Dewey had been Wall Street lawyers, on the opposite side of New York from Lansky and Luciano, and they both expected to reach top positions in Washington. Their mentor had been Dulles's brother, John Foster, who had represented the U.S. government in crucial treaty negotiations after both world wars.

World War II had turned the U.S. into the world's most powerful nation. Dewey, the Dulles brothers and others had formed their secret circle because they saw themselves as loyal and pragmatic Americans with a duty to help shape the country's new international role. The project was to resurrect the OSS.

No country could stay on top, they believed, without a powerful and independent intelligence agency. Allen Dulles championed this idea among his contacts at the Pentagon and in the Truman administration. Truman was so impressed that he appointed Dulles to head a three-member commission to study the U.S. intelligence system. Dewey and others in the secret circle lobbied Congress.

In July 1947 Congress passed the National Security Act. Truman signed it, as Dulles and Dewey had recommended, thereby creating the Central Intelligence Agency (CIA) as a successor to the OSS. The CIA was given a secret budget and a charter written so loosely as to grant the agency nearly unlimited power.

Outfitted in the country's finest ideological cloak, the CIA was charged with protecting America by whatever means necessary. The Cold War had started. Communists were the new enemies. The communist spread across the globe was to be stopped. To the secret circle, some of whose members became key CIA officials, that meant the CIA was to be the patron of U.S.



multinational companies which had set up shop in underdeveloped countries to make money and oppose communism.

The OSS's old friend, the Mafia, was among the leading multinational corporations that emerged in the late Forties. Lansky's moxie in freeing Luciano had impressed the Sicilian dons. Even his chief rival, "Fat Albert" Anastasia, paid homage to Lansky when the Mafia boss walked out of prison—"You're the only bastard with the brains to do it." Lansky also had outwitted the don of dons. Luciano was deported to Sicily immediately upon his release. But, with Luciano's unreserved blessing, Lansky took charge of domestic operations and finished the job the two had started a decade before. Lansky merged the Mafia's rival gangs into a conglomerate known as the International Crime Syndicate, a network that Lansky estimated was "bigger than U.S. Steel" and which he immersed in banking, real estate, tourism and gambling.

At the same time, the exiled Luciano expanded the Syndicate's overseas connections. With some help from the CIA, Luciano formed an international smuggling route for the Syndicate's booming narcotics business. When communist strikers shut down the French port of Marseilles in 1947 and threatened to ruin American shipping, the CIA called on Luciano. He furnished himen while the CIA supplied money and weapons. After several murders the docks opened for American shippers and for the Syndicate's heroin smugglers.

When the Syndicate later added Southeast Asia's "Golden Triangle" to its heroin route, the CIA again was accommodating. To stop communism the agency shipped cash and munitions to Laotian mercenaries, who happened to be opium growers employed on the Syndicate's heroin trade. CIA planes were used to provide safe passage for the first leg of the heroin's long journey to U.S. ghettos. Like the OSS, the CIA did not shrink from making deals with the Syndicate to preserve U.S. interests. Under the CIA's charter, such arrangements were legal. But Thomas Dewey and Allen Dulles realized that the CIA needed to safeguard its own political base to avoid potential power struggles in Washington, a practical analysis that quickly carried the agency into a clandestine role in American electoral politics.

Dewey himself was the odds-on favorite to become president in 1948. To insure his election the CIA funneled more than \$1 million from its secret budget into Dewey's campaign, according to agency sources. Meyer Lansky likewise supported Dewey, marshaling Syndicate money and political clout behind the republican nominee (although some older Mafia bosses, still resentful of Dewey's racketeering spree in the Thirties, refused to contribute).

Truman's upset victory interrupted this scheme. But that did not concern the CIA as much as the ephemeral moods on Capitol Hill. What the CIA wanted from Congress, aside from its money, was to be left alone. In the opinion of Dulles and Dewey's secret circle, Congress posed the greatest danger to CIA autonomy. As a hedge against difficulties, the secret circle began to buy congressional goodwill for the CIA. Congressional members found their re-election problems aided — contributions, volunteers, endorsements — and their staffs occupied with bright young assistants introduced by members of the secret circle. Most favors went to young congressional members with a promising future, politicians who someday might be Capitol Hill leaders and White House aspirants.

Richard Nixon, a member of the House of Representatives, was one recipient. Nixon had been elected in 1946. The Orange County republican party had placed a newspaper ad to solicit a token candidate in a race against the undefeated democratic incumbent. Nixon, just out of the Navy, applied for the job. His

credentials were slim: the FBI had rejected him, his law clients had found him embarrassingly naive and his war record was mediocre. But Nixon ran with manic zest, slandered his opponent as a communist and returned a winner.

In 1947 Dewey had recruited Nixon's vote to help establish the CIA. Dewey liked Nixon's amoral pragmatism and his fierce anti-communism. So in 1948 Dewey arranged a special favor for Nixon during the celebrated Alger Hiss case.

A magazine editor had claimed Hiss was a communist. The House Un-American Activities Committee (HUAC) investigated and was about to exonerate Hiss when Nixon suddenly asked to take over what seemed a losing case. Nixon's reason for volunteering to head the investigation, according to CIA sources, was that he had inside information from Dewey.

Dewey had initially also considered Hiss innocent. John Foster Dulles, serving as Dewey's chief foreign policy adviser in the 1948 campaign, had defended Hiss and had recommended him for a job at the Carnegie Endowment where Dulles was board chairman. But then, according to CIA sources, the secret circle's friends in the agency conducted an investigation and informed Dewey and the Dulles brothers that Hiss, while a top State Department official under Truman, had belonged to the Communist Party.

Dewey saw a chance to embarrass Truman, to bolster the credibility of HUAC (which Truman wanted to abolish) and to boost Nixon's career — without publicly involving himself. In late July 1948 Dewey leaked the CIA's findings to Nixon. On August 5th Hiss appeared before HUAC and denied he'd ever met the magazine editor who had accused him of communism. Nixon stood firm against Hiss while the other HUAC members accepted Hiss's version. But Nixon was uncertain about how to proceed. So on August 11th he held a rendezvous with the Dulles brothers at the Roosevelt Hotel in New York. According to CIA sources, the brothers gave Nixon their approval for a full-scale attack on Hiss, and Allen Dulles provided some ammunition: confirmation that Hiss had known the magazine editor ten years before. Five days later Hiss reappeared before HUAC and, under Nixon's questioning, began to retreat from his former statements. A few months later, according to CIA sources, CIA agents also played a part in leading the freshman congressman to the evidence that eventually convicted Hiss.

The scandal gave Nixon a national reputation. In 1950 Nixon left the House to run for the Senate against the popular Helen Douglas. Nixon labeled her the "Pink Lady" and his campaign literature described her as a fellow traveler of communists. Murray Chotiner, Nixon's campaign manager and his first "dirty tricks" specialist, wrote the smear pamphlets. But, according to CIA sources, Chotiner received most of his information about Douglas from CIA files that the agency provided.

Nixon won easily over Douglas and took his seat in the Senate, thanks to the assist from the CIA — and to another from the Syndicate.

In keeping with Mafia tradition, Lansky invested money in the campaigns of politicians at all levels of government. Mickey Cohen, the Syndicate's Southern California gambling chief in the Forties, later admitted to helping finance the early stages of Nixon's career. According to Cohen, the transactions were handled by Chotiner, who remained a Nixon adviser through his later ascent to the presidency. Columnist Drew Pearson reported that, in exchange for the Syndicate contributions, Chotiner used his influence to keep bookmakers out of jail in Los Angeles.<sup>2</sup>

In 1952, after only six years in politics, Richard Nixon became vice-president. His nomination was shepherded through by Dewey's backroom maneuvering. Having abandoned his own



presidential ambitions, Dewey threw his support to Dwight Eisenhower. Then, at Dewey's request, Eisenhower picked Nixon as his running mate.

Allen Dulles, who had become CIA deputy director in 1951, arranged for CIA backing of the Eisenhower-Nixon ticket. Political intelligence — reports of Korean War mistakes embarrassing to the outgoing Truman administration — were leaked to the media. And agency money was slipped to the campaign through CIA front groups.

Immediately after the election, Dulles was promoted to the CIA directorship and his brother was named secretary of state.

With Nixon as vice-president and Dulles as CIA director, Lansky was immune from federal laws. In 1953 the Justice Department decided not to prosecute him even though the IRS intelligence division found he was evading taxes, and in 1957 the Justice Department failed to carry through on an attempt by immigration authorities to deport him.

Throughout the Fifties the careers of Richard Nixon, Meyer Lansky and Allen Dulles prospered. Their futures seemed unlimited. But then the affairs of a little island in the Caribbean changed that outlook and inextricably bound up the collective fortunes of the CIA, the Syndicate and the White House.

Meyer Lansky first visited Cuba in the fall of 1933 on a search for molasses to use in making rum. But the island was brimming with other opportunities. Lansky befriended Fulgencio Batista, a chubby ex-army sergeant who had just ordained himself dictator. With Batista's sanction, Lansky opened several new casinos, the genesis of the Mafia's international gambling network.

Richard Nixon's first known trip to Cuba came in 1940. Roulette wheels were spinning 24 hours a day; tourists jammed the country. He was on vacation from his job as prosecutor in Whittier, California. According to Earl Mazo, Nixon's biographer, the young lawyer explored Cuba and entertained "the possibilities of establishing law or business connections in Havana."

Whatever Nixon had in mind was interrupted by World War II. The tourists stopped coming, and Lansky shut down the Cuban gambling spas.

With the Cuban economy sagging, Batista encountered political turmoil. To stay in power he had to make concessions that extended communist influence. U.S. corporations feared their Cuban investments might be nationalized. So, in 1944, Naval Intelligence asked Lansky to pressure Batista into stepping down to keep out the communists.

Lansky, a staunch anti-communist, prevailed upon the dictator; elections were held, a pro-American candidate won, and Batista left Cuba for eight years of exile in southern Florida.

Southern Florida was Meyer Lansky's headquarters in the Forties. He had transferred his Cuban casino business to hotel suites and restaurant back rooms along the Miami Beach "Gold Coast." The 1950 Kefauver Senate committee discovered that a major gambling center was headquartered at the Wofford Hotel, a Miami Beach hotel run by Tatum "Chubby" Wofford. One of Wofford's yachting companions during this time was Richard Nixon.

When the war began Nixon had gone to work in Washington as a government lawyer, then joined the navy and shipped out to Green Island in the Pacific, where he built a jungle shack, stocked it with booze and ran poker games for the other sailors. He left the navy with a \$10,000 bankroll to invest in his new political career.

On Capitol Hill the freshman Nixon was befriended by fellow congressman George Smathers, a Miami playboy who introduced him to Richard Danner, Smathers's 1946 campaign manager. Danner, a former FBI agent, had been fired as Miami's city manager in 1948 after the city council accused him of "playing both sides against the middle" in a gangland dispute over control of the city police department. Later, Danner went to work for Howard Hughes, as Hughes's liaison to Nixon, and became a pivotal character in Watergate, but in the late Forties he was best known as a guide to Lansky's "Gold Coast."

Nixon began socializing with southern Florida's fast-buck entrepreneurs. Among them was Charles "Bebe" Rebozo. Danner said he introduced Nixon to Rebozo in 1948, when the congressman vacationed in Miami on "the verge of a physical breakdown" after weeks of tension in the Hiss case.

Rebozo, a Cuban-American, had attended elementary school with Smathers and, like Nixon, had made his first big money during World War II. Rebozo had cornered the wartime market for recapped tires in southern Florida, then had lent that money to poor families at high interest rates. Both Rebozo and Smathers — who became partners in several questionable real estate ventures — shared Nixon's earlier fascination with Cuba.

In March 1952 Batista returned from exile and resurrected his dictatorship in a bloodless coup set up by Lansky's \$250,000 to be the elected president in return for his abdication. Nixon and Smathers joined Lansky as ardent fans of Batista. Smathers, who had been elected to the U.S. Senate in 1950, lobbied so aggressively for aid to Batista that he became known as the "senator from Cuba." One month after Batista's return, Danner took Nixon on a tour of the Havana casinos. (Also along was Dana Smith, soon to become infamous as administrator of the slush fund that almost knocked Nixon out of the 1952 vice-presidential race.)

Nixon, Smathers and Rebozo used Cuba as an investment property as well as a playground. According to a law enforcement official familiar with American holdings in the Caribbean, the three held vast interests in Cuba during the Fifties.

Batista had turned into a hard-line anti-communist and his Cuban home provided a safe haven for American entrepreneurs. None were more successful than Lansky and Luciano.

According to the Federal Bureau of Narcotics, Luciano hoped Cuba would "become the center for all international narcotics operations." Luciano had arrived in Cuba in 1947 to lay the groundwork. For years there had been factories in Cuba that processed cocaine. Luciano added laboratories for heroin. Then, with Batista's return, Cuba mushroomed into a major narcotics headquarters.

Under the new Batista régime Lansky also rejuvenated gambling in Cuba. He had persuaded the other Syndicate leaders to invest heavily in a new concept: the hotel-casino. High-rolling gamblers were flown in and bedded in plush rooms an elevator ride away from croupiers and poker chips. Lansky and Luciano's junior partner, Bugsy Siegel, had in 1945 pioneered this concept on a dusty stretch of Nevada desert that became known as the Las Vegas Strip. But Havana's midway was even more dazzling. In a few years the Syndicate's hotel-casinos there were earning an estimated annual profit of \$100 million.

Batista arranged for legislation that guaranteed a gambling license to anyone investing \$1 million in a hotel. The Cuban government not only matched such investments dollar for dollar, but it also waived corporate taxes on all hotel-casinos.

Nixon was among Batista's frequent and well-received guests during the Fifties. In 1955 Nixon pinned an award on Batista and the two posed grandly in the dictator's palace.

By the mid-Fifties, Howard Hughes, sole owner of the country's largest privately held corporation, also was deeply enmeshed in the dynamics of money and politics. Hughes's involvement dated from World War II. His aircraft company had not taken off financially, despite his brilliant innovations in aviation, until the war broke out. Then, due in part to a recommendation from Franklin Roosevelt's son, Colonel Elliott Roosevelt, Hughes won a \$70 million government contract for his personally designed F-11 photo-reconnaissance plane. According to Senate testimony from former Hughes man John Meyer, Colonel Roosevelt made his recommendation after Hughes's money had helped finance the colonel's romance with an actress.

Senator Owen Brewster, a grandstanding Maine republican angry with Hughes over an unrelated business dispute, accused him of license-buying. But Hughes survived a wide-open congressional investigation headed by Brewster by attributing the investigation to Brewster's personal vendetta. Hughes then destroyed Brewster's power by pumping \$60,000 into the election campaign of a political opponent.

Hughes considered himself a patriot and felt he'd been unfairly singled out for practices standard to most defense firms. He turned bitter and cynical. He decided that — for his own good and for the good of the country — he needed powerful allies. The CIA was an obvious choice, as he later explained in a burst of candor. According to sworn testimony in 1974 from former aide Robert Maheu, Hughes believed that "if he ever became involved [again] in any problem with the government, either with a regulatory body or an investigative arm, it would be beneficial for him to be in the position of being a front [for the CIA]."

Hughes was a tough-minded opportunist and an intensely private man, with no stockholders to question his decisions — an ideal ally for the CIA. As early as 1949 Hughes was designing and manufacturing special equipment for the spy agency. During the Fifties, Hughes began hiring ex-CIA employees as top administrators and he eventually became the country's leading CIA contractor, a position that effectively shielded him from federal prosecution.

Hughes, like the CIA and Lansky, also understood *quid pro quo* and electoral politics. "Everyone has a price," he told Noah Dietrich, who later recalled that the billionaire contributed up to \$400,000 each year to "councilmen and county supervisors, tax assessors, sheriffs, state senators and assemblymen, district attorneys, governors, congressmen and senators, judges — yes, and vice-presidents and presidents, too."

Among them was Richard Nixon.

Hughes and Nixon shared the same anti-communist pose. During the McCarthy era Hughes closed down his movie studio for three months to check his payroll for patriotism, and he tried to destroy Elizabeth Taylor's career because she was dating a supposed communist.

In early 1956, according to a former Hughes aide, the tycoon furnished Nixon with a secret \$100,000 to help the vice-president fight a dump-Nixon move by fellow Republican Harold Stassen. Then, in December 1956, Hughes loaned \$205,000 to Nixon's brother Donald for a hamburger restaurant. The "loan" was never repaid.

In the following months, Hughes received several special dispensations from the White House. A Justice Department antitrust suit was settled by a consent decree. And the Hughes Medical Foundation, which technically owned the aircraft com-

pany, was granted a tax-exempt status that had been denied twice before, a tax dodge that saved Hughes an estimated \$36 million a year.

During the next decade, Hughes's interests continued to merge with Nixon, the CIA — and eventually with the Syndicate.

In 1958 a bearded ex-lawyer descended from Cuba's Sierra Maestra mountains with a Yankee-Go-Home revolution. Three Lansky lieutenants smuggled in a planeload of arms, stolen from a National Guard armory, to help Batista stop the advance of Fidel Castro. But Castro seized Havana on New Year's Day 1959 and Batista and Lansky fled Cuba the same day.

Lansky's brother Jake stayed behind to try salvaging the Syndicate's gambling and narcotics operation. But Castro threw Jake in jail for 25 days and, by 1960, had deported all Syndicate members, padlocked the amusement parlors, razed the dope labs — and expropriated all other American business holdings.

At CIA headquarters in Langley, Virginia, meanwhile, the agency began hatching a plan to retake Cuba.

Under Allen Dulles's leadership the CIA had become the strategic arm of his brother's foreign policy at the State Department — promoting U.S. investments abroad and stopping the spread of communism. In 1954, for example, the CIA helped overthrow a communist-leaning Guatemalan government that had expropriated 225,000 acres from United Fruit, a U.S. company with ties to the Rockefeller family.

Castro's government in Cuba piqued the CIA for several reasons. The CIA's Soviet counterpart, the KGB, could use Cuba to launch revolutions in Central and South America against U.S. interests there. Dulles's Wall Street friends already had suffered huge reverses in Cuba: Castro had confiscated the Freeport Nickel mine, affiliated with the Rockefellers, and a score of lesser industries.

There also was the loss of the Syndicate's casinos. The casinos had been an open-ended money funnel for both the Syndicate and the CIA. Lansky had masterminded a system that allowed the Syndicate to skim winnings, evade taxes and launder illicit funds at the gaming tables. The CIA, according to agency sources, had been using the same system and the same casinos to hide its payments to the underworld figures it sometimes employed.

So the CIA planned to topple Castro with a surprise invasion. About 1200 Cuban exiles would land at the Bay of Pigs, steal through the jungle and establish a renegade government, thus providing a ruse for a full U.S. military assault against the Castro régime. The invasion plan was developed almost entirely behind President Eisenhower's back, according to author Haynes Johnson, who wrote a definitive inside account of the operation. Colonel L. Fletcher Prouty, an Air Force liaison to the CIA between 1955 and 1963, reached the same conclusion. "Eisenhower had never ever contemplated an invasion," Prouty said in a recent interview. "We had pretty specific instruction from Eisenhower of the limits of our authority. What we were allowed to do was land five or six people on a beach and have them blow up a sugar refinery, stuff like that."

But four days before the 1960 presidential election, according to Johnson, the CIA circulated a memo saying the invasion was going ahead. Two days later, Prouty recalled, "we were told to get B-26 bombers ready and to get transport aircraft ready." According to Prouty, approval for the moves came from vice president Nixon.

Nixon was then head of the 53/12 Group, a National Security Council subgroup that supervised covert activities. E. Howard

Hunt, the CIA agent who recruited Cuban exiles for the invasion later reported that Nixon was the Bay of Pigs "secret action officer" in the White House.

Hunt had been the CIA's chief political action officer during its successful coup in Guatemala. At every opportunity he promoted the same tactics for Cuba.<sup>6</sup> Through the long fall of 1960 Hunt mustered a secret army of exiles. They were run through makeshift boot camps and shaped into a strike force. Secret training sites were set up in the Florida Everglades, on the Louisiana delta and in the Caribbean. The CIA-installed government in Guatemala also provided a surreptitious guerrilla base.

Another was on Cay Sal, a rocky outcropping off Florida owned by Howard Hughes. Not only had Hughes given the CIA temporary custody of the island, but, according to one former CIA operative, he'd furnished the guerrillas with an alibi: if discovered, they could say they were rehearsing for a Hughes movie. Gerry Hemming, a hulking ex-Marine who conducted drills at one of the training sites, later recalled that he helped unload crates labeled "Toolco," then the name of Hughes's parent company. Inside the crates were camp gear and machinery for the invasion.

Hughes had a purpose for his patriotism. According to a former aide, Hughes intended to rush into Cuba once Castro fell and develop a series of resort parks on the beach front, build his own jumbo airport and buy up a block or two of casinos and set himself up as a tourism magnate. Because of the manipulative qualities of casino accounting, the aide said, Hughes hoped to turn the entire venture into an enormous tax dodge that would banish tax bills forever. Hughes apparently expected to reach an accommodation with the Syndicate. "Hughes had a lot of respect for the Mob, especially Lansky," the aide recalled. "My guess is that he hoped to form some sort of partnership with Lansky."

For Lansky and the Syndicate, the Bay of Pigs plan held far greater significance. Four ex-casino bosses — Russell Bufalino, James Plumeri, George Levine and Salvatore Granello — used trusted Cuban contacts to supply the CIA with scouting reports on Castro's troop and naval positions.<sup>8</sup> Richard Cain, a policeman on the Syndicate payroll, also helped recruit Spanish-speaking mercenaries for the CIA army.

The Syndicate's primary representative in the Bay of Pigs preparations was Santo Trafficante, a Florida businessman who had belonged to the ruling circle that administered gambling and narcotics in Cuba.<sup>9</sup> Trafficante had risen to that position partially because of a power struggle between Lansky and "Fat Albert" Anastasia, known as the Lord High Executioner of Murder Incorporated. Anastasia had tried in 1957 to recruit Trafficante into a scheme to undercut Lansky's control of the Cuban operations. Instead, according to a Justice Department account, Trafficante betrayed Fat Albert to Lansky's harem; Anastasia was shot five times as he sat down for a haircut.

Trafficante's contact in the Bay of Pigs operation was Frank Sturgis, then known as Frank Fiorini. Sturgis was an American soldier of fortune who had enlisted with Castro in the Sierra Maestra, smuggled guns for Castro, paraded with him into Havana and, for a short time, served as Castro's supervisor of gambling.

When Castro decided to eliminate the casinos, Sturgis defected and claimed he had been working undercover against Castro all the time.<sup>10</sup> The CIA quickly recruited Sturgis. He led several small pre-invasion raids against Castro and, according to his own account, joined the Operation Forty assassination squad, a special CIA unit set up to assassinate Castro loyalists in post-invasion Cuba.

Richard Whattley, a fellow mercenary hired for the invasion, later recalled that Sturgis had several visits from Trafficante.<sup>11</sup> "Trafficante would order Sturgis to move his men and he'd do it. Our ultimate conclusion was that Trafficante was our backer. He was our money man." According to sources in Miami, Trafficante also infiltrated Operation Forty with Syndicate money and henchmen.<sup>12</sup>

As the invasion neared, work began on a plot to demoralize Castro's forces by killing their leader. Among those involved in this plot were Trafficante, Sturgis, Hunt and Robert Maheu, a Howard Hughes operative.

The CIA eventually tried several times to murder Castro. President Johnson later discovered that "we're running a damn Murder Incorporated in the Caribbean." Lansky had been the first to propose the idea when he placed a \$1 million price on Castro's life in 1959. Sturgis was still Castro's gambling supervisor when he heard about the bounty from Hyman Levine, Lansky's manager at the Comodoro Casino. Sturgis said he passed the word along to his CIA contacts.

Hunt, as the Bay of Pigs operations officer, added his personal recommendation in a memo sent to his CIA supervisors in the spring of 1960. That summer the Castro assassination conspiracy began.

Allen Dulles and his deputies decided in August 1960 to subcontract the job. They enlisted help from Robert Maheu, an ex-FBI agent who had worked for the CIA under a special retainer since 1954.<sup>13</sup> Maheu, an engaging, smooth-talking operator, had quit the FBI in the early Fifties to open a private detective agency in Washington, a firm that specialized in solving problems outside the normal channels. At the CIA he was considered a consummate "fix-it" man.

The CIA officials asked Maheu to enlist Syndicate men for the Castro murder, according to the 1975 Church Senate committee, and authorized him to pay \$150,000 for the hit. Maheu told the Church committee he hesitated initially because he feared the project might interfere with his work for Howard Hughes, who also had retained Maheu's services. But Maheu said he agreed to the assignment after informing Hughes of the murder plot — and, according to one source, gaining the billionaire's approval.

For the project Maheu called on John Roselli, Sam Giancana and Santo Trafficante. Roselli and Giancana, like Trafficante, were members of the Syndicate's ruling elite. Roselli's home territory was Las Vegas and Giancana's was Chicago — but they had helped administer the Syndicate's Cuban operations.

The CIA wanted Castro's murderers to be subtle. The CIA's first proposed weapon, according to the Church committee, was a box of Castro's favorite cigars contaminated with a botulinum toxin "so potent that a person would die after putting one in his mouth." But after Maheu's discussions with the Syndicate leaders, the CIA opted for a plan to spike Castro's food with poison pills that would leave no trace in an autopsy. Trafficante found a Cuban émigré who claimed to know a waiter at a restaurant where Castro frequently dined. In early 1961, according to Senate testimony, Maheu delivered the poison pills and \$10,000 in CIA money to Syndicate men in a rendezvous at Miami's Fountainebleau Hotel.<sup>14</sup>

When newspaper headlines reported soon afterward that Castro was sick, Maheu allegedly phoned a Syndicate contact and exulted, "Did you see the paper? Castro's ill. Wow, we got him." But Castro's illness was not related to the CIA-Syndicate assassination attempt; the pills apparently never reached his table. The CIA blamed the failure on a Castro whim to stop eating at the designated restaurant.<sup>15</sup>

The failed assassination was not the only setback in the grandiose plan to retake Cuba. Richard Nixon had been defeated in the 1960 presidential race, a turn that seemed to imperil the entire scheme. According to Colonel Prouty, the CIA had delayed the Bay of Pigs invasion because it expected a Nixon administration to approve any anti-Castro plan regardless of international repercussions. Instead, the CIA now had to obtain John Kennedy's support.

Kennedy was presented the Bay of Pigs plan as a *fait accompli*. "When Kennedy became president," Prouty explained, "he was suddenly told the Bay of Pigs was going to involve an invasion. He had no choice but to go along." CIA director Allen Dulles warned the young president that if he called off the plan, there would be a "disposal problem" with the CIA's 1200 exile soldiers. "We can't have them wandering around the country telling everyone what they've been doing," Dulles told Kennedy.

On April 17th, 1961 — three months after Kennedy took office — the CIA army stormed the beach at the Bay of Pigs. The American people were led to believe the invasion was a righteous attempt by exiled Cubans to reclaim their homeland. But, under the friendly escort of a CIA man, four of Lansky's casino operators waited in a boat a few yards offshore. And poised in the Bahamas with enough gold to reopen the Havana tables was a Trafficante lieutenant.

Unexpectedly, Castro's patrols spotted the invaders and attacked with devastating firepower. The CIA army, accustomed only to mock boot-camp battles, scattered in dismay into swamp and jungle. CIA officials informed Kennedy that, if the invasion plan was to be salvaged, Air Force bombers would have to fly in with air cover for the CIA soldiers. But it was a need that went unmet. Castro had alerted the Soviet Union. Under that circumstance, Kennedy feared that a U.S. air attack on Cuba would be blatant provocation. He refused to send in the planes and the CIA army fled ingloriously into Castro's prisoner-of-war camps.

"No event since the communization of China in 1949 has had such a profound effect on the United States and its allies as the defeat of the U.S.-trained Cuban invasion brigade at the Bay of Pigs," Howard Hunt later wrote. Hunt blamed Kennedy's "betrayal" of the CIA and felt JFK's subsequent investigation was intended "to whitewash the New Frontier by heaping guilt on the CIA." Allen Dulles was similarly outraged.

Kennedy's appraisal was significantly different. He saw himself victimized by the CIA's reckless underestimation of Castro's strength. He felt the CIA had misled him and exploited his lack of executive experience. JFK told an aide he wanted to "splinter the CIA into a thousand pieces and scatter it to the winds."

For nearly a decade Allen Dulles had been running the CIA. The Bay of Pigs invasion had been the agency's most ambitious project ever. Dulles himself had supervised the agency's anti-Castro alliance with the Syndicate. All memos about the Castro assassination plot, according to CIA deputy director Richard Bissell, had gone only to Dulles. Thomas Dewey also had taken time out from his Wall Street law practice, according to CIA sources, to help set up front groups to funnel funds to the CIA army. Cuba was to have been the CIA's finest hour.

When Kennedy criticized the CIA for the Bay of Pigs failure, he was adding insult to humiliation. But his threats to abolish the agency were not taken seriously. The CIA was still a sacred institution with many carefully cultivated friends. Kennedy backed down. The agency stayed. But he did force out Allen Dulles in the fall of 1961. To replace the longtime director, Kennedy appointed a compromise selection. Wall Street lawyer John McCone. Dulles, however, left behind his master student, Richard Helms, as CIA deputy director of plans. Since McCone

was a newcomer, he allowed Helms to keep his job, which gave Helms jurisdiction over the CIA's "dirty tricks" division and other deep-cover covert activities. Helms immediately resumed the CIA's private war against Castro.

Kennedy, miffed at Castro for the international embarrassment, did authorize some further CIA activities against the Castro government. But he apparently wanted them limited to the small-scale hit-and-run raids Eisenhower had allowed.<sup>16</sup> Undeterred, the CIA ignored those limits and returned to its conspiracy to assassinate Castro.<sup>17</sup> CIA officials began discussing plans that called for planting a bomb-laden seashell on the ocean floor where Castro liked to go SCUBA diving or giving Castro a diving suit smeared with a deadly fungicide. The CIA also reactivated plans for hiring Syndicate assassins. CIA officials apparently tried to win Kennedy's approval but, as far as the Church committee could determine, the agency's "dirty tricks" division carried out these murder plots without JFK's sanction.<sup>18</sup>

The simmering tension between Kennedy and the CIA flared up in October 1962 during the Cuban missile crisis. Top CIA officials viewed the crisis as a prelude to a second Cuban invasion and alerted the surviving Bay of Pigs army to stand ready. But Kennedy's negotiations with the Soviet Union produced an opposite result. The Soviet Union agreed to withdraw its missiles from Cuba, and Kennedy promised to end the U.S.'s undercover war against Castro.

Kennedy promptly ordered the CIA to stop organizing anti-Castro raids and to observe scrupulously the new truce. By the fall of 1963 Kennedy was reaching for a formal *détente* with communist Cuba.

The Kennedy Administration's failure to restore Cuba's pre-Castro heyday also had infuriated Richard Nixon, who publicly upbraided the young president for being soft on Castro. The former vice-president had hoped to reverse the new Cuban policy by ousting Kennedy from the White House in 1964. But Kennedy's soaring popularity and Nixon's embarrassing loss in the 1962 California gubernatorial race drove Nixon into unexpected political seclusion — dashing the hopes of the CIA, the Syndicate, Howard Hughes and all others who had invested in him.

Nixon's demise seemed to assure that JFK would be president through 1968. After that, Kennedy's younger brother, Robert, stood an excellent chance of inheriting the presidency for eight more years. By that time it might be too late to undo all the Kennedy policies. The Syndicate, in particular, was suffering under the new administration. JFK had appointed his brother attorney general. Bobby had been an investigator and Jack had been a senator on the McClellan Senate committee when it declared a war on organized crime in the late Fifties. In 1961 the Kennedy administration picked up where the McClellan committee left off.<sup>19</sup>

Robert Kennedy quadrupled the size of the Justice Department's organized crime and racketeering division and compiled a "hit list" of 4300 Syndicate targets. Near the top of the list were Chicago don Sam Giancana, New Orleans don Carlos Marcello and a business partner of theirs — Teamster president Jimmy Hoffa. RFK had discovered Hoffa's links to the Syndicate while on the McClellan committee, and his pursuit of the Teamster boss had developed into a public vendetta. Hoffa retaliated by campaigning for Nixon in 1960. Nixon, in turn, intervened at the Justice Department to hold up a Hoffa indictment for misuse of union funds.

But once RFK took command of the Justice Department, he moved quickly against Hoffa, leveling charges of jury tamper-

ing, kickbacks and a \$2 million pension fund swindle. The young attorney general also initiated deportation proceedings against Carlos Marcello. When he began investigating Sam Giancana, however, he found the mobster involved in a disconcerting deal with the CIA.

The CIA, he learned, was a partner with Giancana in the Castro murder plot. RFK was furious, but not shocked. During his McClellan committee tenure he had tried unsuccessfully to subpoena a Las Vegas mobster on the CIA's protected list. "You can't touch me," the mobster had boasted. "I've got immunity."

As attorney general, however, RFK did not seem as intimidated by Syndicate IOUs from the CIA. In the summer of 1963, Justice Department investigators shadowed Giancana so tenaciously that the mobster asked for judicial relief so he could play golf without an audience; RFK later had him booked briefly on contempt charges, the first time since 1942 that Giancana had seen a prison cell. In the fall of 1963 RFK announced he was taking his best crime fighters to Las Vegas, the Syndicate's biggest domestic gambling center and the home turf of John Roselli, another of the CIA's partners in crime.

At the same time John Kennedy began enforcing his ban on anti-Castro activities, a policy that promised to end any chance for a Syndicate return to Cuba. In the summer of 1963 FBI agents were sent to the Louisiana delta where they broke up an anti-Castro camp and seized a terrorist arsenal — dynamite, bomb casings, striker assemblies, primer cord and blasting caps. The camp had been run by a CIA front group and had been rented by the brother of a former Cuban casino owner. In September the Kennedy government issued tough-minded warnings to six anti-Castro partisans; among them was Frank Sturgis, then piloting B-52 raids against Castro.

Castro responded with a message, sent through diplomatic channels, asking Kennedy for a personal audience to discuss improving relations between the two governments. Kennedy seemed willing. He authorized a French journalist to serve as his personal emissary in sounding out Castro's ideas.

Castro felt Kennedy was sincere in his overture. In an interview after Kennedy's death, Castro had this assessment of the American president: "He took many measures against us. But I speak to you in all sincerity and try to give you the opinion I have of Kennedy. I say that truly he was one of the few men who had enough courage to question and policy and change it."

But as Kennedy moved closer to a U.S.-Cuba *rapprochement*, he came further in conflict with the CIA's unforgiving anti-Castroism. Dulles's protégés remained so unyielding in their resistance to Castro that Kennedy told friends he feared the agency had become too autonomous. He felt that the CIA's "dirty tricks" division particularly was not responding to presidential orders. John McCone, as Kennedy's CIA director, seemed unwilling or unable to overcome the independent nature of the CIA's old-time covert operators. Finally, in mid-November 1963, Kennedy ordered his aides to get ready for a more thorough housecleaning at the agency.

"The CIA will have to be dealt with," he told aides shortly before traveling to Dallas for a November 22nd motorcade. On the same day Kennedy's emissary opened talks with Castro in Havana. And according to the Church committee, the CIA also chose November 22nd to begin yet another plot to assassinate Castro — in continuing defiance of Kennedy's new policies.

But by the end of the day Kennedy's plans were dead with their paron in Dallas.

The Warren Commission investigated the Kennedy assassination and, after ten months, attributed it to the personal derangement of Lee Harvey Oswald, whom they described as a pro-

Castro zealot. The commission's official report made no mention of a conspiracy to kill Kennedy, even though two commission lawyers raised that possibility during the investigation. According to a document declassified a decade later, the lawyers were worried that Oswald had been used as a patsy by anti-Castro fanatics. "The motive of this would, of course, be the expectation that after the president was killed, Oswald would be caught or at least his identity ascertained, the law enforcement authorities and the public would then blame the assassination on the Castro government, and the call for its forceful overthrow would be irresistible," the lawyers wrote in a memo. "A second Bay of Pigs invasion would begin, this time, hopefully, to end successfully."

Although Oswald was never officially identified as a CIA agent, his life history showed a remarkable similarity to the behavior of a low-level intelligence operative. As a U.S. Marine in the late Fifties he had been given a top security clearance to a CIA-sponsored U-2 base in Japan. Shortly thereafter, Oswald defected to the Soviet Union, somehow paying a \$1500 travel fare even though his bank account held only \$203. He claimed to be a Marxist and said he planned to give military secrets to the Soviets. But the U.S.S.R., according to a former Soviet agent, was convinced that Oswald was a double agent for the CIA. Two years later, in 1962, he returned to the U.S. and, despite his prior admissions of treason, was handed back his citizenship papers.

Then, in the summer of 1963, Oswald surfaced in New Orleans as the organizer of a pro-Castro group, with himself as its only member. He spent the summer in the eye of the local media, as if he wanted to be remembered for his pro-Castro antics. He distributed pro-Castro leaflets and picked fights with anti-Castroites. Oswald's pro-Castro leaflets seemed suspect because they were stamped with the address of a building used by a CIA front group — the anti-Castro Cuban Revolutionary Council that Howard Hunt had helped set up during the Bay of Pigs operation. Piles of the same literature were found later in the possession of Guy Bannister, a former FBI agent with connections to Robert Maheu, New Orleans don Carlos Marcello and Hunt.<sup>20</sup>

The circumstantial evidence seemed to support the theory of the two commission lawyers that Oswald was an unwitting pawn in a conspiracy to frame Castro for Kennedy's murder. But the theory still lacked proof. Then New Orleans district attorney Jim Garrison announced in 1967 that he had secured the proof. He named Clay Shaw, David Ferrie and Edgar Eugene Bradley as members of the conspiracy. Garrison's investigation was burdened with several unreliable witnesses, however, and soon floundered. Shaw was acquitted, Ferrie died and Bradley was shown to be the victim of a mistaken identification.<sup>21</sup> But Garrison's probe did produce some new evidence.

Richard Helms, who had been promoted to the CIA directorship in 1966, apparently took Garrison seriously. During Garrison's prosecution of Shaw, a New Orleans businessman, Helms became especially anxious. Victor Marchetti, a notetaker for CIA staff meetings at the time, later recalled that Helms repeatedly asked his deputies: "Are we giving Shaw all the help we can?"

Garrison claimed he had lost his case the day David Ferrie died. Garrison had counted on Ferrie to turn state's evidence. On February 18th, 1967, Garrison had revealed him as a member of the alleged assassination plot. Four days later Ferrie was found dead of a massive brain hemorrhage.<sup>22</sup>

Ferrie had a curious background that included work for both the CIA and the Syndicate. The CIA had used him during the Bay of Pigs preparations to train pilots for the invasion, and he had showed up again in 1962 as an instructor in an anti-Castro

camp outside New Orleans. At the same time he was serving as a pilot and legal investigator for Carlos Marcello, a Syndicate leader with a personal stake in Cuba. On the day Kennedy died, Ferrie and Marcello had been together in a New Orleans courtroom attending Marcello's trial on charges that grew out of RFK's attempt to deport the New Orleans don. Ferrie was a dedicated anti-Castroite. At one point he groused aloud that Kennedy "ought to be shot" for his role in the Bay of Pigs. But Garrison found several seemingly credible witnesses who testified that Ferrie had been seen conferring privately with Lee Harvey Oswald in late summer 1963, a time when Oswald was making public claims of *pro*-Castroism.

Also in later summer 1963, Ferrie called the Chicago phone number of a young woman who, on the day before Kennedy's death, arrived in Dallas in the company of a man who met twice that night with Dallas nightclub owner Jack Ruby. The next night, after Oswald's capture, Ferrie took a hurried and unexplained 1000-mile car ride through a rainstorm to a Houston ice rink. There he monopolized the pay phone for several urgent calls. Hours later Ruby went to Dallas police headquarters and gunned down Oswald.

Afterward, Ruby allegedly told his psychiatrist that he had "a been part of a plot to kill Kennedy" and also said he had expected the Kennedy assassination to lead to another Cuban invasion. But the Warren Commission decided that Ruby had acted alone, out of a psychotic patriotism, and discounted a memo prepared by two commission investigators that profiled Ruby as a lackey with Syndicate connections.

At age 15, Ruby was running errands for Frank "The Enforcer" Nitty, heir to Al Capone's Chicago gangland empire. He became a small-time hustler, selling "tip sheets" at racetracks and peddling sidewalk watches. In 1937 he obtained a top position in the Scrap Iron and Junk Handlers Union — which one FBI report described as "largely a shakedown operation." Two years later the union's founder was murdered. Ruby was held briefly for questioning but was not charged in the case.

Robert Kennedy later singled out that murder as a crucial step in the Syndicate's takeover of the Chicago union. Paul Dorfman became union president and, according to RFK, quickly formed an alliance with Jimmy Hoffa. "Paul Dorfman and Jimmy Hoffa are as one," Kennedy wrote in *The Enemy Within*. "Everywhere Hoffa goes, Dorfman is close by." By 1963 Chicago don Sam Giancana and Carlos Marcello shared in his friendship.<sup>23</sup> The 1950 Kefauver committee found Ruby had links to Dave Yaras, a member of the same Syndicate circle as Dorfman and Hoffa.

Ruby went to Dallas in 1947 to open a night club. In 1956 the FBI received a report "that Ruby is the [Syndicate] payoff man for the Dallas police department."

In August 1959 Ruby visited Cuba at the invitation of Lewis J. McWillie, a former World War II black marketeer and manager of the Tropicana casino — a man Ruby said he "idolized."<sup>24</sup> At the time, Lansky still was hoping Castro might keep the casinos open and Ruby apparently was offered a casino job. Ruby stayed for eight days, then returned the next month for a two-day visit. He did not take a job but he did contact Robert McKeown, a former gunrunner to Cuba. According to McKeown, Ruby offered \$15,000 for help in freeing three men being held in Cuba. McKeown said Ruby told him someone in Las Vegas was financing the project. But the deal apparently fell through.

In 1961 McWillie left Cuba for Nevada, where he took a job at the Cal-Neva Lodge, a hotel casino in which Giancana allegedly held an interest. By then both Ruby and McWillie were outspoken foes of the new Cuban régime: the Warren Report describes McWillie as a "violent anti-Castroite." According to

several witnesses, Ruby went to visit McWillie in Las Vegas in October 1963.

That same month Ruby made several other calls to men with Syndicate connections. Calls went to Paul Dorfman, Hoffa's trusted confidant; Irwin Weiner, another Hoffa adviser with connections to the Syndicate's Chicago chapter; and Barney Baker, described by Robert Kennedy as Hoffa's "ambassador of violence." RFK's Justice Department had put Baker in jail but he was released shortly before the assassination.

Ruby did not explain why he was talking to Hoffa's friends. But a major topic of conversation in the Hoffa circle during 1962 and 1963 was the Kennedy administration. According to Edward Grady Partin, a Baton Rouge Teamster official, Hoffa complained that "something has to be done about that little s.o.b. Bobby Kennedy" and suggested blowing up the attorney general in his convertible. Carlos Marcello also had asked for revenge against the Kennedys, according to a Marcello associate who talked to a government investigator. Marcello allegedly made a dramatic plea in a secret Syndicate meeting: "*Licarsi na pietra di la scarpa!*" ("Take the stone out of my shoe!")

At one point the Warren Commission did seem interested in whether Ruby fit into the Syndicate feud with the Kennedys. It asked Richard Helms to investigate ties between Ruby and "the Las Vegas gambling community." Eight months later Helms replied that the CIA had found "no information on Ruby or his activities."

Allen Dulles presumably was the only Warren Commission member who knew of the CIA's alliance with the Syndicate. But he did not volunteer to brief the other commission members. Nor did he say anything about the agency's various assassination plots — which, according to Frank Sturgis, had been expanded to include targets within the U.S. after the Bay of Pigs. (In a 1975 interview, Sturgis said that in the early Sixties he had been asked by a CIA agent to take part in an unspecified "domestic" assassination.)

FBI agents interviewed Sturgis shortly after the assassination and, according to Sturgis, told him: "Frank, if there's anyone capable of killing the president of the United States, you're the one guy that can do it." But the FBI's investigation of the murder was no more revealing than the CIA's. FBI director Hoover harbored an abiding resentment of the Kennedys. Hoover's official posture was that the Syndicate did not exist as the powerful organization portrayed by the Kennedys. And he had been embarrassed when Syndicate informant Joe Valachi testified in 1962 to a litany of Syndicate crimes — bribes, executions, narcotics deals, gambling skims — in nationally televised hearings arranged by RFK's Justice Department.

But for the Warren Commission Report, it was the CIA and the FBI who were doing the investigating. *They* were not being investigated. The Warren Commission was mildly troubled by Dulles's admission that the two agencies — in keeping with their secrecy standards — probably would not tell the truth about any operatives involved in the assassination. But it suppressed its qualms and did not consider seriously the possibility that Syndicate leaders and anti-Castro extremists within the CIA conspired to kill the president.

Once free of Kennedy's restrictions the CIA intensified its efforts to overthrow Castro. Three months after JFK's death CIA agents were already planning a second invasion of Cuba. Howard Hunt was in charge of the plan, according to the investigative reporter Tad Szulc. As a prelude to the invasion, the CIA equipped a hitman with an automatic rifle to shoot Castro. But,



according to Szulc, the CIA became discouraged when the assassin delayed the hit and finally was caught by Castro's men.

Most CIA officials began to concede Cuba to communism. Castro's instinct for survival was uncanny. And Vietnam was luring CIA "dirty trickers" to the other side of the world. Through the mid-Sixties there were more assassination attempts against Castro and more harassment raids to Cuba. By 1965 the CIA had abandoned the second invasion plan.

By then the Syndicate also had lost interest in Cuba. Meyer Lansky had found a new home for the Mob's offshore gambling empire in the Bahamas.

The Bahamas held some of the same attractions as Cuba — an easy plane trip from the mainland, hide-and-seek tax laws, the warm assurance of benign weather. There was no Batista. But there was 300-pound Sir Stafford Sands, the Minister of Finance and Tourism and a politician of porcine build and appetite. Sands was boss of the Bay Street Boys, the bloc of colonial merchants and politicians who ran the archipelago of palm trees and white sand.

Sir Stafford later testified that Lansky had approached him in 1960 with a bribe of \$2 million to be deposited in a Swiss bank account in return for a Certificate of Exemption, a piece of legalese needed to operate a casino in the Bahamas. Sir Stafford claimed to have refused the offer. Instead he hired out his legal talents to Syndicate front men; for this, Stafford collected \$1.8 million in legal fees and Lansky's men got the Certificate of Exemption. The casinos opened in 1964 to the attendant buzz of the international jet set.

But Sir Stafford's arrangement with the Syndicate became so blatant it angered local Bahamians. "The natives were restless," crime reporter Hank Messick wrote, "and Cuba had proved the danger of betting everything on a man or a political party that no longer enjoyed popular support. If gambling was to survive in the Bahamas, it was necessary to turn control over to a government that offered stability."

According to Messick, what followed was the slickest maneuver of Lansky's career: he engineered his own revolution against Sir Stafford by having an aide become a secret informant and leak certain information about the Syndicate deal with Sands. According to Messick, it gave the *Wall Street Journal* a Pulitzer Prize and led to Sir Stafford's sudden retirement in 1967.

A new government headed by Bahamian-born Lynden O. Pindling replaced the Bay Street Boys. Pindling looked as shining and clean as the sun in the morning. But Messick discovered that Lansky secretly had shoveled thousands of dollars into the campaign that put Pindling in office.

To complete the housecleaning, Lansky's front men also were removed. The new power in Bahamian gambling became the Mary Carter Paint Company. On the face of it there seemed no reason why an obscure paint company should venture into the gambling business — or why the Bahamian government should let it. But one of Sir Stafford's final transactions had been to give Mary Carter Paint a Certificate of Exemption in exchange for \$240,000 in legal fees.

Mary Carter Paint, according to CIA sources, was a CIA front group. It had been set up by Thomas Dewey and Allen Dulles. In 1958 Dewey and some friends bought controlling interest in the Crosby Miller Corporation with \$2 million in CIA money from Dulles, who was still CIA director. A year later the Crosby Miller Corporation merged with the paint company. During the Bay of Pigs operation in 1960 and 1961, according to CIA sources, Mary Carter laundered CIA payments to the Cuban exile army.

In 1963 the company became part of a Florida scandal after it loaned \$100,000 to stock promoters with alleged Syndicate connections. But soon afterward the company began buying land in the Bahamas, sold its Mary Carter paint division and subsequently adopted a more conventional Caribbean name: Resorts International.

Resorts entered the gambling business in 1965, according to CIA sources, to give the agency a conduit for hiding money it sends to counterinsurgency groups in Central and South America. Resorts started as partners with two Syndicate front men, a circumstance that persuaded the Justice Department's top organized crime official to write a worried memo: "The atmosphere seems ripe for a Lansky skim." But then Lansky's men formally withdrew, leaving the field to Resorts.

Resorts tried to appear separate and distinct from Lansky, rigorously applauding itself as an alternative to Syndicate gambling. But Resorts had not severed all Syndicate ties. As casino manager it had hired Eddie Cellini, brother of a top Lansky lieutenant who, according to a Senate investigation, intervened at Resorts to get jobs for two friends. And according to sworn testimony from Syndicate informant Vincent Teresa, junketeers continued to need Lansky's permission to book their tours into the Bahamas. A disgruntled Resorts stockholder, supermarket heir Huntington Hartford, later went to civil court because he believed the Resorts profit columns were being juggled, a gold-plated clue to hidden partners. Reporters investigated and concluded that, based on the circumstantial evidence, Lansky was still a moving force in Bahamian gambling.

At the same time, 3000 miles away in Las Vegas, the Syndicate was changing the face of its domestic gambling empire.

In 1945 when Lansky's junior partner, Bugsy Siegel, arrived in Vegas, the town's future seemed as cheerless as the rattlesnakes that stood sentry in its vacant lots. Vegas clung tentatively to a patch of desert, as close to oblivion as the next big duster. Then Siegel brought in \$2 million in Syndicate money and began building the Strip.

But Siegel's arrogant and spendthrift nature prevented him from seeing the project through. After a quarrel with Lansky in 1947, Siegel was killed by a hired gun who shot him through his living room window. New Lansky associates, headed by John Roselli and Moe Dalitz, replaced Siegel.<sup>25</sup> By the mid-Sixties, Las Vegas was the boomtown of the West, enticing thousands of men with a fondness for neon-lit ladies and a weakness for baccarat and blackjack. But then the Justice Department launched its long-delayed drive to expose Syndicate influence in Vegas.<sup>26</sup> There was a kind of unrestrained ferocity in the investigation. Lansky himself was later indicted based on evidence that he'd been skimming Vegas from 1960 through 1966. (The indictment claimed Lansky had taken \$36 million out of just one casino.)

But in 1967, Lansky's old front men disappeared from Vegas, just as they did in the Bahamas. The man who bought them out was Howard Hughes.

In 1965 Hughes had elected to sell his TWA stock rather than appear in civil court. He had received \$546,549,771 — the largest single amount ever paid an individual in the history of American finance.

Hughes arrived in Vegas by private train on November 27th, 1966. A truck backed up to a service elevator at the Desert Inn. Hughes was carried on a stretcher from the back of the truck into the elevator and was soon barricaded in the ninth-floor penthouse of the hotel.

Within three years Hughes was Nevada's biggest employer, with a payroll of \$50 million. He owned a TV station, prime real

estate and a string of hotel-casinos: the Desert Inn, the Sands, the Castaways, the Frontier, the Landmark and the Silver Slipper. State gaming officials, assured that Hughes was replacing the Syndicate, waived most rules — including the submission of a recent photograph — so the billionaire could quickly assume control of the town's gambling business. Howard Hughes had given Nevada "the *Good Housekeeping* seal of approval," crowed Nevada governor Paul Laxalt.

However, the Syndicate didn't step aside out of kindness. Instead, according to several sources, the Syndicate formed a partnership of symbiosis with the Hughes organization. The Syndicate supplied casino expertise, Hughes lent the necessary respectability.

A hint that the Syndicate was still in business in Las Vegas came when Hughes filed his official casino winnings. They were much lower than the volume of playing warranted, a deficit that indicated a big-time rake-off. The *Wall Street Journal* reported that millions were being skimmed.

The Syndicate desperately needed a front. Moe Dalitz, owner of the Desert Inn, was under investigation. So were Syndicate men at the Frontier and Sands. Hughes aborted these investigations by taking title to the three casinos. But he kept Dalitz, among others, around for advice. "The many contacts I made with Mr. Dalitz were made at the specific suggestion of Mr. Hughes, wherein Mr. Hughes wanted the benefit of his thinking," Hughes aide Robert Maheu later explained.

Maheu, the ex-FBI agent who had served as intermediary between the Syndicate and the CIA, handled Hughes's takeover in Las Vegas. Hughes also got help from John Roselli, who, along with an associate, collected \$235,000 in finder's fees in the sale of the Desert Inn and the Sands.

But Hughes successfully stonewalled any suggestion that he was now partners with Lansky. Like Resorts in the Bahamas, Hughes blitzed the media with publicity that claimed just the opposite. Newspapers and television networks, having no chance to quiz Hughes, accepted this line, as did the Las Vegas city fathers and Nixon's Justice Department.

Robert Kennedy left the Justice Department in 1964 to run for the Senate. President Johnson, preoccupied with Vietnam and happy to be rid of RFK for political reasons, turned the job of Syndicate-hunting back to J. Edgar Hoover. The FBI director deflated the Justice Department's drive against organized crime and returned to his number one concern — hounding communists and other radicals. The Syndicate began to recover from the Kennedy years.

For a while RFK's bid for the presidency in 1968 threatened the Syndicate. But an assassin ended the Kennedy campaign. Instead, Richard Nixon was elected. One of Nixon's first moves as president was to fire Robert Morgenthau from the U.S. attorney's job in New York. Morgenthau, considered the toughest prosecutor left in the Justice Department, had been investigating the Syndicate's connections in the Bahamas.

Nixon had his own Bahamian connection. He had vacationed there in 1962, contemplating the prospects of an unemployed politician, after turning his back on the voters and reporters of California. He had spent the next half-decade playing the role of republican gadfly and repairing his political career. With some help from Thomas Dewey, he also became a Wall Street lawyer with new contacts in the corporate establishment.

In January 1968 Nixon returned to the Bahamas as a presidential candidate and an honored guest at the opening of the new Resorts casino. The Resorts yacht was placed at his disposal and he soaked up the sunshine.

Nixon had met the Resorts board chairman, James Crosby, at a party in late 1967. Crosby's father had been a member of the secret circle that lobbied for establishment of the CIA after World War II. Crosby had been an executive in a Wall Street brokerage until 1958 when, according to CIA sources, Dewey and Dulles placed him at the Crosby Miller Corporation, the CIA front group that became Resorts International.

Nixon was introduced to Crosby by Bebe Rebozo, the Florida entrepreneur who had become Nixon's best friend. Crosby kept an account at Rebozo's Key Biscayne bank, a relationship that Watergate investigators later stumbled across when they began looking into an allegation that Rebozo's bank was being used to launder Resorts contributions to Nixon.

Rebozo had opened his bank in the early Sixties, had hung Nixon's picture next to the flag and had given Nixon the account labeled number one. The bank soon developed a reputation for trafficking in stolen securities. In one case Rebozo accepted IBM securities, reportedly stolen by a New York Mafia family, and sold them for cash even though he suspected they were dubious. (He called Crosby and Nixon's brother, Donald, to check on them.)<sup>27</sup>

But some investigators felt another bank function was to abet a skim from Resorts. Franklin DeBoer, a former trust officer at the bank, told the Watergate investigators that a Resorts "bagman" had brought money from the Bahamas to Rebozo's bank. Another bank official gave a sworn statement to Florida investigators that the same courier had come to the bank after normal business hours and exchanged \$20 bills for \$100 bills.

The investigators did not prove the bank was laundering money for Resorts. But they did learn that Crosby had given \$100,000 to Nixon just before the 1968 New Hampshire primary, the pivotal event in Nixon's comeback.

As it worked out, the \$100,000 from the head of Resorts helped put Nixon in the White House. Then a separate \$100,000 from Howard Hughes, in an unexpected twist, became crucial to his eviction.

Nixon's eagerness for such boodle was a dominating force in his career. In 1966 Rebozo's Cape Florida Development Company had bought up \$1 million in prime waterfront lots on Key Biscayne. Rebozo had trouble selling them until Nixon posed for a promotional picture with Rebozo's partner, Donald Berg, a man the Secret Service later found so disreputable that it stopped Nixon from eating at Berg's Jamaica Inn Restaurant in Key Biscayne. (The reason for the Secret Service's brush-off was Berg's connection to a Syndicate front man — a 1960 Nixon campaign contributor — who had been instrumental in establishing Lansky in the Bahamas.)

Rebozo gave Nixon a 33% discount on two undeveloped lots. One lot had a mortgage held by Arthur Desser, a director of the Miami National Bank, which Lansky allegedly used to launder money skimmed from Vegas casinos.<sup>28</sup> Nixon kept his tie to Desser unadvertised by not recording the deed to the lot until the mortgage was paid off four years later.

As president, Nixon perfected *quid pro quo*. When he took office, the major remaining symbol of the Kennedy's Syndicate-busting legacy was an imprisoned Jimmy Hoffa. Then in 1971 Nixon commuted the former Teamster boss's sentence eight years ahead of schedule. Soon after, Nixon began accumulating Teamster donations eventually totaling more than \$1 million.<sup>29</sup>

Then in January 1972 Nixon secured another early release for real estate developer Calvin Kovens, who had been convicted of pension-fund fraud along with Hoffa. Eight days before the Kovens parole, former senator Smathers called White House aide Chuck Colson to urge the move. "I was talking to Bebe



[Rebozo] about it." Smathers told Colson in a taped conversation, "and said, 'Bebe, it looks to me that this would be a pretty good thing to do.'" A few months later the Nixon re-election campaign received a secret \$30,000 in cash from Kovens.

One month after Nixon moved into 1600 Pennsylvania Avenue, Bob Haldeman sent a top-secret memo to John Ehrlichman: "Rebozo has been asked by the president to contact J. Paul Getty in London regarding major contributions. The funds should go to some operating entity other than the National [Republican] Committee so that we can retain full control of their use."

White House memos did not record whether Rebozo ever approached oil billionaire Getty. But according to the Senate Watergate committee, Rebozo did serve Nixon as a courier and launderer of money kept in a secret White House cache, shuttling these unattached funds through disparate bank accounts and then shelling them out to indulge Nixon.<sup>30</sup>

Rebozo tried to hide these payments in a tangle of expert financial manipulations. One payment was meandered through three bank accounts and a cashier's check, none of them even in his name. He succeeded in confusing the trail enough to conceal most expenditures — and in burying the identities of the slush fund's moneygivers where they could not be exhumed.

But there was one crucial exception, a \$100,000 donation from Howard Hughes.

By 1968 Hughes was close to becoming the world's richest man and Robert Maheu was ensconced as Hughes's *chargé d'affaires* on a \$520,000 annual retainer. In the spring of 1968 Hughes handed Maheu a top-priority instruction: "I want you to go to see Nixon as my special confidential emissary. I feel there is a really valid possibility of a republican victory this year. If that could be realized under our sponsorship and supervision every inch of the way, then we would be ready to follow with Laxalt [the politically unknown Nevada governor] as our next candidate."

Hughes must have been cheered when he heard a few months later that the man with whom he'd dealt so compatibly as vice-president had reached the White House. A month after the election Hughes decided to contribute to Nixon's private cache. In December 1968, Maheu took \$50,000 in \$100 bills from the cage at the Silver Slipper casino and flew to Palm Springs where Nixon was attending the republican Governors Association Conference. Maheu told the Watergate committee that he drove to the house where Nixon was staying and waited in the car while a consort went inside. Apparently it was Hughes's intention that the money be delivered to Nixon personally, a high-handed and risky procedure at which Nixon balked.

Maheu returned to Vegas with the \$50,000. Shortly thereafter, however, Rebozo sought out Richard Danner, the ex-FBI agent who 20 years before had introduced Nixon to Rebozo. Danner had worked on the 1968 Nixon campaign, then had been hired by the Hughes organization as a "Nixon liaison." Rebozo broached the subject of money, Danner told the Watergate committee, by needling him about Hughes's supposed favoritism toward Hubert Humphrey, grumbling that Hughes had donated more to Humphrey's 1968 campaign than to Nixon's. According to Senate testimony, Danner took this message to Maheu, who agreed to send money to Nixon through Rebozo.

Hughes had at least four favors in mind:

Hughes had just lost a major defense contract because of adverse publicity that developed when a House subcommittee found that his money again had been wining and dining top Pentagon generals. Now Nixon was in a position to cut off the major market for Hughes's lagging helicopter division by ending

the Vietnam war. So Hughes sent a memo in early 1969 telling Maheu he "should get to our [new] friends in Washington to see what could be done about keeping the war in Vietnam going." (By 1974 Hughes was the country's eighth largest Pentagon contractor, with backlog orders of \$825 billion, becoming so much a part of the defense establishment that Nixon offered to have Henry Kissinger brief Hughes on the antiballistic missile system.)

Hughes's second concern was the Atomic Energy Commission's (AEC) testing under the Nevada desert. He feared the after-effects and he felt the tests were strategically worthless — as he explained in another memo to Maheu: "Of course, we must be careful not to place ourselves in the position of disclosing military secrets. But I can tell you, based upon actual Defense Department technical information, legally in my hands, that this last AEC statement is pure 99 proof unadulterated shit." (Confronted with Hughes's antagonism, the AEC did move its testing ground from Nevada to Amchitka Island off Alaska, at a cost to taxpayers of \$100 million.)

Third, Hughes needed approval from the White House before he could take over Air West airlines. (Hughes received Nixon's personal go-ahead in 1969, just about the time the first \$50,000 installment — \$100 bills cinched in bank wrappers and stuffed in a manila envelope — was delivered to Rebozo.)

Fourth, Hughes wanted antitrust laws waived so he could purchase the Dunes Hotel. Hughes already had bought up five big hotel-casinos and, by late 1969, was angling for the 1000 room Dunes. But the Justice Department's antitrust division opposed granting Hughes an even bigger monopoly on Vegas. So in early 1970 Maheu sent Danner to talk with the "boss," in this case Attorney General John Mitchell, who had worked with Danner on Nixon's 1968 campaign. Mitchell and Danner closeted together in three secret meetings over a period of seven weeks. Then Mitchell gave the green light. Maheu subsequently authorized the second \$50,000 explaining to a Hughes lawyer "that certain political obligations had to be met" because of Danner's meetings with Mitchell. Danner again carried the money in a manila envelope to Rebozo.

(Mitchell's supposed excuse for approving the Dunes sale was that Hughes was fighting the Syndicate in Vegas. But Danner told the Watergate committee that, in actuality, Mitchell felt Hughes had not really affected the Syndicate's standing in the casinos.)

Three years later, when Watergate investigators began beating on the White House door, Rebozo became alarmed that the \$100,000 from Hughes would be discovered. At 8 a.m. on April 30th, with Nixon about to announce the exit of his White House front line before network TV cameras in the Oval Office, Rebozo hurriedly conferred down the hall in the Fish Room with Nixon's personal lawyer, Herbert Kalmbach. According to Kalmbach, Rebozo was worried because part of the \$100,000 had been spent by Nixon's secretary and his two brothers.

Howard Hughes's \$100,000 payment to Nixon's secret cache almost certainly would have stayed undetected if Hughes had not fired Robert Maheu in November 1970.

For more than ten years Maheu had handled assignments for the CIA and the Hughes organization. In the espionage, business and criminal netherworlds, his connections were invaluable. With Maheu as his top lieutenant, Hughes had been awarded several CIA contracts, including one to build an intelligence-gathering satellite. Yet Maheu had made some miscalculations. The Dunes deal, for instance, had fallen through when last-minute arithmetic showed it was a bad risk. Maheu also had fired John Meier, who allegedly was defrauding Hughes on mining

deals. However, Hughes apparently liked Meier because Meier was a buddy to Donald Nixon, the president's brother.

Soon after the Dunes deal backfired, Chester Davis, a long-time Hughes counsel and a bitter rival of Maheu, made his move to oust him. Davis approached Intertel, a "security" firm with better CIA connections than Maheu.

Intertel was born in the Bahamas, the offspring of Resorts' anti-Syndicate posturing. Intertel was supposed to be a private police force to keep gangsters away from the casinos. What Intertel became, however, was a private CIA-for-hire that relied on computer data, political IOUs and inside connections.<sup>31</sup>

The Intertel president, Robert Peloquin, began his career as a member of the snoop society. He worked for Naval Intelligence, the National Security Agency and the Justice Department's Security Division. Then he had been chief of the Justice Department's first Organized Crime Task Force, a job that got him acquainted with Resorts. Peloquin was the prosecutor who investigated Resorts and initially reported that "the atmosphere seems ripe for a Lansky skim." But in 1966 he suddenly retired from the Justice Department and went to work for the CIA front group Resorts.

By 1970 Peloquin — with \$2 million in backing from Resorts — had assembled Intertel, having recruited operatives from the inner precincts of the CIA, FBI, IRS, National Security Agency, Department of State, Scotland Yard, Interpol, Customs Bureau, Royal Canadian Mounted Police, Bureau of Narcotics and Dangerous Drugs — and J. Edgar Hoover's only nephew.

Installed as an Intertel vice-president was James Golden, known as "Nixon's man" at Resorts. Golden had been a Secret Serviceman assigned to guard vice president Nixon in the Fifties and had returned as security director at the 1968 republican convention. Afterward, at Nixon's request, Resorts had hired Golden as its deputy director of security. (From there Golden went to Intertel, then to a top security job with Hughes and finally back to Washington under Nixon as chief of the organized crime section in the Law Enforcement Assistance Administration.)

In the summer of 1970, Peloquin and the Resorts president came to Las Vegas, shared drinks and a floor show with Bebe Rebozo and Richard Danner and visited with Chester Davis. According to a Hughes insider, Peloquin and Davis reached a tentative agreement. Intertel would replace Maheu as the fix-it expert in the Hughes organization. And Hughes would replace Resorts in the Bahamas.

(By 1970 Lansky had become as reclusive as Hughes, hiding out in Israel, trying to avoid the lingering repercussions of Bobby Kennedy's Las Vegas investigation. The Syndicate did not want another major investigation in the Bahamas. But already some investigative reporters were trying to uncover Lansky between the balance sheets. Hughes could provide a much better front; his anti-Syndicate stance in Vegas was still uncompromised.)

For Hughes it was a chance to put the Western Hemisphere's two premium gambling centers in his name. Hughes already had contemplated moving to the Bahamas. Hughes representatives had met with Resorts executives during the previous year to discuss the chance of buying up the Bahamian franchise. If he did expand to the Caribbean, Hughes told Maheu in a taped conversation, "I would expect you really to wrap that government up down there to a point where it would be — well — a captive entity in every way."

Chester Davis's proposed deal with Intertel offered Hughes that opportunity only if Maheu was eliminated. "But, according to CIA sources, the Intertel scenario held an added incentive irresistible to Hughes. According to the sources, Intertel officials broached the idea of a mammoth CIA contract that would turn

Hughes's parent company into the CIA's most valuable front. The CIA would pay Hughes an estimated \$360 million to build the Glomar Explorer, a super-sophisticated rig to work in the ocean's depths. The CIA said it wanted the Glomar to retrieve military codes and nuclear warheads from a Soviet submarine sunk three miles deep in the Pacific.<sup>32</sup>

At midnight on Thanksgiving eve 1970, Intertel agents carried Hughes down a back stairs at the Desert Inn and through the only door that wasn't monitored by Maheu's closed-circuit TV system. A decoy caravan of black sedans was dispatched to the civil airport while Intertel ferried Hughes to an Air Force base and loaded him aboard a Lockheed JetStar bound for the Bahamas. According to one account, Hughes was met there by James Golden, the Intertel executive and Nixon friend.

Maheu, who usually communicated with his employer only through handwritten notes, did not learn of the mysterious departure until two weeks later. At first Maheu could not believe he'd been replaced. More likely, he thought, Intertel had kidnapped Hughes for some undefined purpose of its own.

So Maheu sent a team of men to the Bahamas. They located Hughes's new aerie atop the Britannia Beach Hotel and camped a floor below. Then they obtained a search warrant to break into the penthouse; they had a boat standing by to return Hughes to the U.S. But their plan was foiled when Intertel's Golden, along with a police squad, rounded them up and had them deported for "working without a permit." Hughes then telephoned Nevada governor Laxalt to say that he had not been kidnapped and that he had fired Maheu.

Maheu's historical significance might have ended there. But Richard Nixon came to view Maheu as a threat because the ex-aide's loyalties had been cut adrift and because he knew too much — as one White House memo put it, "Maheu's tentacles touch many extremely sensitive areas of government, each of which is fraught with potential for Jack Anderson-type exposure."

The White House Plumbers were not yet operative. So the IRS was asked to examine Maheu's bank account, to search for a heavy-handed tool of coercion — an indictment. When Maheu suddenly found himself under IRS scrutiny, he decided to confide in Hank Greenspun, the highly independent publisher of the *Las Vegas Sun*.

By 1971 Greenspun had gathered a boxful of Hughes's private papers and information about the \$100,000 donation to Nixon. The material had come through sources within the Hughes organization, much of it presumably from Maheu. Greenspun revealed this information to Jack Anderson over dinner in Washington. Greenspun had known the columnist since the early Fifties when both had brawled editorially against Senator Joseph McCarthy.

On August 6th, 1971, ten months before the Watergate burglary, Anderson's column described the bare details of the \$100,000 transaction.

On September 26th, 1971, Hank Greenspun trekked to Portland, Oregon, where Nixon was intervening in a longshoremen's strike. Nixon knew Greenspun as an idealistic newspaperman, a Hughes critic and a Nixon friend for many years, in approximately that order. The two posed for the usual gaggle of photographers. Then Greenspun cornered Nixon confidant Herb Klein and, according to Greenspun's notes of the meeting, warned Klein that the \$100,000 in cash potentially could "sink Nixon."

About two weeks later, on October 12th, Greenspun received a visit from Herb Kalmbach, the Nixon lawyer. According to Greenspun, Kalmbach spent two hours scribbling on yellow

legal pads, taking down Greenspun's answers to questions about his knowledge of the \$100,000.

In late December the White House Plumbers unit discussed a plan, which apparently he never attempted, to assassinate Jack Anderson by coating his car steering wheel with a poison that would be absorbed through his skin. According to Anderson, the Plumbers hoped to obtain the poison from the CIA.

Then in early 1972, McGraw-Hill Publishing Company announced it was about to release the inside story of Howard Hughes's real-life shenanigans. In front-page articles on January 16th and January 17th, the *New York Times* quoted excerpts from the McGraw-Hill book that charged Nixon with being a political fixer for Hughes. The book, authored by freelancer Clifford Irving, purported to be based on his interviews with Hughes. The Hughes organization knew that to be false. But the book did contain a plethora of details. According to several sources, both Hughes and the White House feared that Maheu was Irving's ghostwriter, using the book to tattle on Hughes and Nixon.<sup>33</sup>

McGraw-Hill had decided Irving's book was authentic. Then in a theatrical phone call from his Bahamas penthouse, Hughes stopped McGraw-Hill's presses by denouncing both Irving and Maheu as frauds. But check-mating Irving's book — to which Maheu apparently contributed nothing — did not prevent a new move from Greenspun and Anderson.

On January 24th Anderson's column again mentioned the \$100,000 and added a proviso: "we have evidence" that money had been illicitly funneled through Rebozo. The White House earlier had heard rumors that Maheu had squirreled away hundreds of Hughes's handwritten communications. Were they the evidence? If so, where were those papers?

That answer was supplied a week later, on February 3rd, 1972. A *New York Times* headline reported that "hundreds of copies of Hughes memos are readily available in Las Vegas." *Times* reporter Wallace Turner had discovered their hiding place: a boxy Meilink safe stuck in a corner of Greenspun's office, ironically under an autographed picture of Nixon posing with Greenspun in Portland. "Wall Turner is an old friend of mine," Greenspun explained matter-of-factly. "He came to my office looking for a story and I couldn't send him away empty-handed. So I told him about the Hughes papers." Greenspun had not told Turner exactly what the papers said, just that he had them secreted in his safe.

The next day there was a secret meeting at the Justice Department offices in Washington. G. Gordon Liddy, an ex-district attorney, had spent the past several weeks trying to sell a political espionage plan to Mitchell. It had been turned down as expensive, risky and ineffective. But on February 4th, 1972, with Turner's story only a day old, Liddy was given a go-ahead. Campaign director John Mitchell, according to deputy director Jeb Magruder, ordered Liddy to scout prospects for breaking into Greenspun's safe. According to an unpublished section of the Watergate committee report, "Mitchell not only brought up the Greenspun entry operation but also urged Liddy to consider it as more pressing and important than the other targets discussed."<sup>34</sup>

(Mitchell allegedly told Liddy that Greenspun's safe contained documents linking Democratic candidate Edmund Muskie to the Mafia. But Watergate burglar James McCord assumed this was a pretext. McCord testified that he believed Mitchell and Nixon were afraid Greenspun had "material which would presumably incriminate the president and his friends.")

According to the unpublished Watergate report, Liddy referred the Greenspun job to Howard Hunt, the ex-CIA operations officer at the Bay of Pigs who recently had taken a new job as the "dirty tricks" expert for the White House Plumbers. Hunt met with Ralph Winte, a Hughes security director, to discuss the

"commonality of interest" between the White House and the Hughes organization. Winte, according to Hunt, agreed to find a floor diagram of Greenspun's office. Two weeks later, on February 19th, Hunt and Liddy flew to Los Angeles and met Winte at the Beverly Wilshire Hotel. Winte allegedly had prepared the freehand floor plan and offered to supply lookouts during the burglary. Hunt was not satisfied. He wanted Winte to provide an airplane for a quick getaway to Central America where the contents of the safe could be quietly split between Hughes and the White House.

Liddy, Hunt and Winte later claimed that preparations broke down at this point and that the break-in was aborted. But in a taped conversation on April 14th, 1973, Ehrlichman told Nixon that the Greenspun mission was successful: "They flew out, broke [into] his safe, got something out."<sup>35</sup>

In any case, the Plumbers next focused on Democratic party chairman Larry O'Brien, an Edward Kennedy confidant and a party loyalist who studiously avoided controversy and headlines. O'Brien also had been Hughes's chief Washington representative in 1969 and 1970. He had been hired by his friend, Robert Maheu, and he had worked for Hughes when the \$100,000 took its discomfoting journey. O'Brien had been dismissed along with Maheu when Hughes left Las Vegas. If Maheu had evidence about the \$100,000, so might O'Brien. And he might only be waiting for an opportune moment to smash it, like an overripe melon, between Nixon's ears in the forthcoming election.

The White House had been worried about O'Brien for more than a year. Haldeman, Ehrlichman, Rebozo and White House special counsel John Dean had all searched for political dirt on O'Brien. They had come up empty-handed. So, according to Senate testimony, John Mitchell authorized a second burglary — O'Brien's office at Democratic national headquarters in the Watergate Office Building.

The Watergate burglars were all veterans of the Bay of Pigs operation. Bernard Barker, a former member of Batista's secret police, had been the invasion paymaster and reportedly an officer under Howard Hunt in the 1965 stillborn invasion.<sup>36</sup> James McCord, a CIA security chief, had played a minor role in the Bay of Pigs and then worked on Hunt's second invasion plan. Eugenio Martínez, still on a CIA retainer a decade after the Bay of Pigs, had belonged to the exile army and later had participated in an estimated 300 harassment raids against Castro. The best-known burglar was Frank Sturgis, the self-styled Bay of Pigs double-agent.

Now all were employed in the White House Plumbers unit and again their chief was Howard Hunt. Except for McCord, the team had been handpicked by Hunt through his lingering contacts in Miami's "Little Havana."

Hunt claimed to have retired from the CIA in the summer of 1970 after 25 years as an agent. He had spent the first half of 1971 at the Mullen Agency, a Washington-based public relations firm purchased in 1970 by Robert Bennett. Chuck Colson, the White House's resident troubleshooter, had known both Bennett and Hunt for years. When Colson realized he needed assistance in plugging up Nixon's leaky affairs, he talked to Bennett about borrowing Hunt. Bennett concurred and, in July 1971, Hunt began moonlighting at \$1000 a day at the White House.

Public relations man Bennett, a Mormon and the son of a U.S. senator, hardly seemed a fit confidant for Hunt and Colson. But Bennett cultivated their friendship, provided surprising assistance, and took a special interest in the White House's undercover activities. Bennett coordinated the hiring of a n operative to spy on the Democrats for Nixon and furnished him a bed in

his house. Bennett arranged an interview for Hunt to collect anti-Kennedy material about Chappaquiddick. He helped author a press release that tried to discredit Jack Anderson's ITT angle in the Dita Beard case. And he set up 150 dummy campaign committees so Nixon donors could avoid gift taxes.

In addition, it was Bennett who allegedly introduced Hunt to the Hughes security director in the early stages of the Greenspun break-in plan. Bennett happened to know the Hughes people because he had just been hired as their Washington representative, taking the place of Larry O'Brien.

To the White House, Bennett's connection to Hughes seemed an added attribute. White House memos about Bennett in 1971 and 1972 contained a smugness: Colson and other Nixon aides congratulated themselves that they had a new ally in the Hughes organization. But Nixon's men apparently did not know about Bennett's other connections. They learned much later that the pencil-pushing Bennett was a CIA man.

According to 1974 congressional testimony, Bennett's company had been a CIA front since its inception in 1959, arranging cover for CIA agents in Asia and Europe and assisting CIA activities in this country. During the Bay of Pigs preparations, it had helped set up the Cuban Freedom Committee, a CIA support group that tried to sabotage Castro's first sugar crop.

Bennett had placed himself at the nexus of the Hughes-Nixon-CIA imbroglio, a unique position that gave him entrée to all three principals. After Robert Maheu's firing, for instance, Bennett performed the following chores: (1) for the White House, he supplied information about Maheu's friendship with O'Brien; (2) for the CIA, he investigated how much influence Maheu held with Nixon; (3) for the Hughes organization, he tried to trace the extent of Maheu's relationship to the CIA.

After the Watergate burglary, however, Bennett charted a course that protected the CIA and Hughes at the expense of Nixon.

By 1972 the same Richard Nixon who had worked so closely with the CIA on the Bay of Pigs invasion no longer enjoyed the agency's unreserved trust. According to CIA sources, CIA director Richard Helms had come to believe that Nixon aides were stealing agency prerogatives for a power-hungry White House. Helms belong to the old-boy espionage school that Allen Dulles had headmastered. He had served with Dulles in the OSS during World War II and had become the most powerful of Dulles's protégés at the CIA.

Early in his administration, according to Watergate investigators, Nixon had tried to enlist the CIA as a special arm of the White House. Helms balked, and Nixon began to resent the agency's independent nature. At the same time, Helms suspected that the Nixon palace guard, especially John Ehrlichman, was trying to ease the agency out of White House decision making.

According to CIA sources, Helms feared that the proposed Huston plan — which would have set up a domestic intelligence bureau — was Nixon's attempt to undercut the CIA with his personal spy network.

Shortly after the CIA learned of the Huston Plan in mid-1970, Howard Hunt abruptly "reired" from the agency and went to work for Robert Bennett's Mullen Agency. Instead of implementing the Huston Plan, Nixon set up the Plumbers and Hunt ended up recruiting a group of operatives who owed their allegiance to the CIA. Hunt's role at the White House later became a matter of controversy. White House aide Chuck Colson came to view Hunt as a CIA double agent sent by Helms to monitor Nixon and compile potential blackmail material. "The president was systematically excluding the CIA from a lot of his

foreign policy deliberations." Colson told a private investigator in May 1974, a few months before Nixon's resignation. "So they had two choices: one to infiltrate and spy on him ... or they could see themselves losing their team. I'm convinced that Hunt was the CIA vehicle. Hunt didn't go to work for the Mullen Agency because he happened to find a good job there. He was posted there by Dick Helms. All the time that Hunt was on the Mullen payroll he was reporting biweekly to the CIA. Then Hunt starts coming over to me, bringing me cigars and inviting me over to his house. He recruits the team of Cubans and works himself into the job at the White House."

Helms claimed he barely knew Hunt. But reporter Tad Szulc revealed that Helms and Hunt were actually good friends. And a House committee later did find evidence that Helms had personally placed Hunt at the Mullen Agency.

James McCord, another battle-tested agent, left the CIA at the same time as Hunt and went to work for Nixon's campaign committee. That seemed suspicious when McCord later told the Senate Watergate committee how he felt about the CIA's rivalry with the White House. "It appeared to me that the White House had for some time been trying to get political control over the CIA assessments and estimates in order to make them conform to 'White House policy,'" McCord said, adding that he felt Nixon had prevented the CIA from conducting its "business with complete integrity and honesty in the national interest."

But then the arrest of the Watergate burglars placed the CIA in a devilishly awkward spot. The men behind bars had demonstrable CIA backgrounds. Even more embarrassing was the CIA's careless outfitting of the Plumbers with agency equipment: disguises, voice-altering devices, a Uher 5000 tape recorder disguised in a typewriter case, a camera hidden in a tobacco pouch, a wig the color of a butcher's apron and all manner of forged identification.

Most of the documentation that could have linked the CIA with the Plumbers was destroyed soon after the burglary. McCord's papers were burned in his fireplace. Helms disposed of all his taped conversations relating to Watergate. But when prying reporters discovered that Hunt's confiscated paraphernalia contained CIA gadgetry, media suspicion about the CIA's role in the burglary leaped into headlines.

Reporters began pestering Hunt and the other Plumbers with unsettling questions. The burglars managed to maintain a professional silence. But the reporters were not satisfied until Robert Bennett began holding audiences with a few of the media's most influential newsmen. According to a CIA memo unearthed by the Watergate committee, Bennett flew from Washington to Los Angeles to spend four hours convincing a *Newsweek* reporter that the CIA had not been involved in the burglary. Then he persuaded a *Time* investigative reporter that the magazine "was beating a dead horse" to pursue a CIA link to Watergate.

The two newsweeklies — which had yet to learn of Bennett's ties to the CIA — seemed to accept his word. They began appraising the burglary as the demerit of anti-Castro partisans or, at worst, the result of some unspecified political hijinks.

According to the CIA memo obtained by the Watergate committee, Bennett also established a "back-door entry" to the law firm representing the Democratic party in a civil suit against the Plumbers, an opportunity he used to steer the Democratic investigation away from the CIA. And Bennett asked a mutual friend to buttonhole Senator Sam Ervin, chairman of the Watergate committee. The friend, a North Carolina lawyer, cornered Ervin during a chartered plane trip, then reported back to Bennett that

he was confident "Ervin accepted [my] comments and will not attempt to further involve the [CIA]."

Even Earl Silbert, the Justice Department's Watergate prosecutor, helped protect the CIA. Bennett told a House committee in 1974 that he didn't have "any misgivings about sharing with Earl from the beginning the full details of the CIA situation." Silbert later admitted that he changed a critical court document in the Watergate case so that the initials CIA incorrectly read CRP (Committee for the Re-election of the President).

Only two young *Washington Post* reporters, Bob Woodward and Carl Bernstein, continued to dog the Watergate story. Their persistence began to unnerve the CIA. So Bennett approached Woodward with an offering of information. As a Colson confidant, Bennett had been privy to several White House "dirty tricks" that were only tangential to the Watergate burglary. In exchange for a promise of anonymity, Bennett supplied Woodward with a catalog of such White House wrongdoing. The Watergate committee's CIA memo, an internal CIA document presumably intended for Helms, described Bennett's modus operandi this way: "[Bennett] has been feeding stories to Bob Woodward with the understanding there would be no attribution to Bennett. Woodward is suitably grateful for the fine stories and bylines he gets and protects Bennett."

Bennett later corroborated this role when he was forced to testify about the memo before a House subcommittee. "Bob Woodward interviewed me on numerous occasions," Bennett testified. "I have told Woodward everything I know about the Watergate case, except the Mullen company's tie to the CIA. I never mentioned that to him. It has never appeared in any *Washington Post* story."

Bennett also scrupulously sheltered the Hughes organization from *Post* scrutiny. Woodward and Bernstein never learned of the plan to burglarize Greenspun's safe, nor were they told the circumstances of the \$100,000 transaction from Hughes. Those two crucial episodes did not become part of their understanding of Watergate. Woodward developed a "special relationship" with Bennett, according to a Watergate committee investigator who was also a source for Woodward. "A lot of the *Post* stories in the summer and fall of 1972 came in part from Bennett," the investigator said.

According to an ex-CIA operative familiar with Bennett and CIA infiltration of the White House, Bennett was acting on orders from CIA higher-ups in talking to Woodward. Bennett, who still enjoyed access to the White House, passed along everything he learned of the White House cover-up to Woodward, the ex-CIA operative said. Eventually, according to the operative, Bennett assumed the code name "Deep Throat" and became the enduring catalyst for the *Post*'s Watergate investigation. Chuck Colson, who claimed to have seen some CIA files on Watergate, said he believed that the CIA "can show how every story that Woodward won the Pulitzer Prize for was fed to him by the CIA."

Bennett briefly expanded his schedule to include other media. At one point his tipstering helped convince *Newsweek* to print a story entitled, "Whispers about Colson." According to the CIA memo, "Bennett took relish in implicating Colson ... while protecting the agency at the same time."

When Colson discovered Bennett's subterfuge, he was infuriated. Along with Senator Howard Baker of the Watergate committee, Colson raised an alarm about CIA manipulation in the case. In the CBS newsroom, a television team put together a story listing many of the accusations against Bennett. Then it was read to him over the phone. "It was terrible," Bennett later testified. "The insinuations and implications put me smack in

the middle of the whole Watergate conspiracy and the hush money and the Hughes matter." But, Bennett said, he protested and the CBS reporters toned down the story.

By that time, moreover, other CIA loyalists had joined Bennett in destroying Nixon's ill-fated cover-up. The *New York Times* had obtained Frank Sturgis' account of White House culpability. Then James McCord announced similar revelations publicly in John Sirica's federal courtroom. McCord said he had spoken up because he believed the White House was trying to use the CIA as a scapegoat. "The White House is bent on having the CIA take the blame for Watergate," he wrote in a letter to a friend three months prior to his court declaration. "The way to head this off is to flood the newspapers with leaks and anonymous letters.... This is of immediate importance."

Nixon was besieged. Howard Hunt was demanding up to \$1 million in White House money for his silence. Alexander Butterfield, who had once headed a Bay of Pigs rehabilitation program reportedly financed by the CIA, disclosed to the Watergate committee that Nixon had taped all his Oval Office conversations — a turning point in the scandal.

Public opinion insisted that Nixon appoint a special prosecutor to investigate Watergate. A few months later, Archibald Cox's office was zeroing in on Rebozo's handling of the \$100,000 from Hughes. Nixon relayed a message to Cox through Attorney General Elliott Richardson. In a subsequent Senate appearance Richardson testified that Nixon "didn't see what Mr. Cox's charter had to do with the activities of Mr. Rebozo." When Cox refused to desist, Nixon elected to fire him in the "Saturday Night Massacre."

Nixon already had shunted off CIA director Helms as ambassador to Iran and had appointed his own man, James Schlesinger, to head the agency. Schlesinger tried to purge the CIA old guard, firing or forcing out nearly ten percent of the agency's 16,000 employees. But "animosity toward Schlesinger grew so strong that his personal bodyguard was increased to prevent violent confrontations with disgruntled agency employees," veteran *Washington* journalist Juan Cameron reported. Schlesinger doubled his security at home, installed a special guardroom outside his office and took along an extra bodyguard in addition to his pistol-packing chauffeur.

But after a few months Nixon had to relieve Schlesinger and promote William Colby, a former chief of the CIA's Phoenix program responsible for the murder of an estimated 20,000 Vietnamese.

Nixon also encountered escalating trouble from special prosecutor Leon Jaworski. A decade before, Jaworski had been a special counsel to the Warren Commission and a director of a private foundation that laundered funds for the CIA.

Under Jaworski's jurisdiction, the special prosecutor's office found no criminality in the \$100,000 payment or in the Greenspun plot. Nor did it uncover any other illegalities involving the Hughes organization or the CIA.

But Jaworski's office did indict Haldeman, Ehrlichman, Mitchell and others for their roles in the White House cover-up. And the special prosecutor won a landmark Supreme court decision that delivered the crucial White House tape recordings and produced incontrovertible evidence that Nixon had ordered that cover-up. Faced with certain impeachment, Nixon resigned.<sup>37</sup>



# Epilogue

John Foster Dulles died in 1959 after six years of directing U.S. foreign policy as Dwight Eisenhower's secretary of state. Allen Dulles died ten years later, having spent his last years extolling the CIA in two books, *The Craft of Intelligence* and *The Secret Surrender*. Thomas Dewey died in 1971, his age and health having kept him from accepting the Supreme Court's chief justiceship offered by Richard Nixon in 1969.

Bebe Rebozo escaped indictment in Watergate despite strong circumstantial evidence of tax evasion and bribe taking. One reason, according to CIA sources, is that CIA officials sanctioned his plea of "national security" when the special prosecutor's office began investigating Rebozo's links to Resorts. George Smathers, retired from the Senate, is prospering in Florida. Their old crony, Richard Danner, still works for the Hughes organization.

Howard Hughes died at age 70 on April 5th, 1976, from chronic kidney disease. Hughes had been living in the penthouse at the Xanadu Princess Hotel in the Bahamas. His negotiations to buy up the Bahamian gambling franchise from the CIA front group, Resorts International, had fallen through.<sup>38</sup> But the Resorts subsidiary, Intertel, continued to administer day-to-day security at the Hughes casinos in Las Vegas. And Hughes had maintained his close ties to the CIA. In early 1975, according to the *New York Times*, the CIA intervened to help squelch a Securities and Exchange Commission investigation of Hughes. A 1975 deposition filed by an alleged CIA agent in a Las Vegas court case involving an ex-Hughes aide revealed that the CIA supplied agents to monitor Hughes's enemies during the early Seventies.

At the time of his death Hughes was earning \$1.7 million each day from U.S. government contracts. Eighty percent had been awarded without competitive bidding. Thirty-two were from the CIA, the most held by any single contractor.

Because Robert Bennett's CIA ties were exposed by the Watergate scandal, he has closed down the Mullen Agency. He now works for the Hughes organization as a vice-president and CIA liaison.

Meyer Lansky today lives undisturbed in Miami Beach. Now 72, he spends his time walking his dog and visiting with old friends. Surrogates handle most Syndicate affairs. After more than 50 years in the Syndicate, Lansky has served less than two years in prison.

In December 1974 the *New York Times* printed a little-noticed story about Lansky. It said that the federal government, in effect, had abandoned the effort begun by the Kennedys to put Lansky behind bars.

After three decades, the CIA's relationship with the Syndicate has not changed. When several Syndicate members went on trial in New York in 1971 for taking union kickbacks, the head of the local CIA bureau turned up in court as a character witness for the gangsters. Deportation proceedings against John Roselli were dropped in 1969 at the behest of the CIA.

According to federal narcotics officials, CIA agents have provided identification papers and high-speed boats for a drug smuggling ring run out of the Dominican Republic by several former members of Batista's secret police. In exchange, the officials say, the narcotics dealers have murdered at least five leftist organizers in the Caribbean. In March 1975 the *New York Times* quoted a former CIA man who said he knows the CIA has relied on the Syndicate "for exchanges of information and also to assault targets selected by the CIA."

The CIA was embarrassed slightly in 1975 when the Senate CIA committee discovered the agency's liaison with the Syndicate in the Castro murder conspiracy. The scandal helped force out William Colby as CIA director.

But the CIA as a powerful and independent institution has survived. Richard Helms, still U.S. ambassador to Iran, has not been prosecuted for the CIA's assassination plots or any other deals with the Syndicate.

Roselli and Robert Maheu testified before the Church committee about their role in the Castro plot. But they only confirmed a scenario already known to Senate investigators. They did not elaborate on the expanse of the CIA-Syndicate imbroglio.

Sam Giancana, however, did not get a chance to talk to the Senate committee. On June 19th, 1975, shortly before his scheduled appearance, an assassin interrupted a late-night snack at his Chicago mansion with seven .22 caliber bullets. A few months earlier, Richard Cain, the Giancana henchman who helped the CIA recruit its Bay of Pigs army, had been executed in a Chicago restaurant.

Another Syndicate figure, Jimmy Hoffa, was kidnapped and presumably killed on July 30th, 1975, in Detroit.

By all accounts, the three were silenced because someone feared they might reveal secrets out of their past. Which someone and what secrets remain a mystery. But some Senate investigators had hoped to question Giancana about any knowledge he had of John Kennedy's assassination.

The Senate committee did appoint a subcommittee to pursue new leads about a CIA cover-up in the Kennedy case. But that investigation has proved to be neither vigorous nor productive.

The Watergate investigation also has dissipated without full and complete disclosure. Richard Nixon, now exiled in San Clemente, has never explained why he thought Watergate "would make the CIA look bad [and] blow the whole Bay of Pigs thing."

Watergate investigators have not figured out what he meant either. One theory is that Nixon was using the "Bay of Pigs" reference as a code word for the entire Cuba affair, a slice of history that some believe includes a CIA role in the Kennedy assassination.

The Bay of Pigs and the Kennedy assassination are motifs that run through the Watergate affair. Howard Hunt, the chief Watergate burglar, helped establish a CIA front group for the Bay of Pigs that had a New Orleans address later used by Lee Harvey Oswald. The Mullen Agency also set up front groups for the Bay of Pigs, and Robert Bennett, as head of the Mullen Agency, played a key undercover role in the undoing of Richard Nixon.

In his recent novel, *The Company*, John Ehrlichman hints that Watergate and the Kennedy assassination were part of a power struggle between the CIA and the Nixon White House. Ehrlichman's book describes a Nixon-like president who has evidence that the CIA was involved in a controversial assassination. In the novel a Helms-like CIA director compels the president to destroy the evidence by threatening to expose a Watergate-like scandal.

Chuck Colson's 1974 remarks to the private investigator also claim that Nixon was caught up in a power struggle with the CIA. "Nixon's theory is that [CIA agents] were coming in to spy, and they wanted to get enough on the White House so they could get what they wanted. Who knows what they wanted. They never got that far — because the whole house of cards collapsed and that was it.

Colson gave several reasons why Nixon did not publicly announce his suspicions. "He's afraid that if he went public with it everybody would say, 'Look at Nixon now, see what a diversion he's trying to create, what a red herring.' Nobody would



believe him ... [But] you know what I think. You know what I really think — and I'm loyal to this guy, he's my friend — I think that [Hughes] paid Bebe that dough and I think Bebe used that for himself and for the president ... and that if Nixon really blows [the whistle on the CIA], Hughes can blow the whistle on him... The president is scared as hell, especially when he's weak and under attack. He was out of his mind over it.

"The president and I talked about it one Sunday for about an hour and a half ... I have seen the CIA files. I know what's in them. I can't prove there was a conspiracy but I would say that was the practical consequences of what they did.

"The excesses of the Nixon administration were pretty bad. But what these guys are doing — one doesn't justify the other — what these guys are doing is worse ... The frightening thing is that there is nobody controlling the CIA. I mean nobody. I'll tell you one thing that scares me the most. They're all over the place. Almost everywhere you turn, they've got tentacles."

## Notes

1. According to Mafia legend, Lansky and Luciano first met on October 24th, 1918, in a New York slum. Lansky was walking home from his job in a tool-and-die shop when he heard screams. Luciano was beating up a girlfriend because she'd seduced a pubescent boy, one Bugsy Siegel. Lansky flew into the fray with a zeal that landed him in jail. But the daring of the scrawny Lansky earned Luciano's respect and formed a basis for their partnership. When Siegel grew up, he appropriately became their junior partner.

2. When Pearson first aired these charges in 1959, Chotiner demanded a retraction. But after Cohen offered to supply details, Chotiner dropped his demand. Later Cohen gave a formal statement to a deputy attorney general of California. Cohen said that Chotiner and Nixon first approached him for campaign funds in 1946, and repeated the request in either the 1948 or 1950 campaign. "During that time I was running most of the gambling and bookmaking in Los Angeles County," Cohen said. "I reserved the banquet room in the Hollywood Knickerbocker Hotel on Ivar Street in Hollywood for a dinner meeting to which I invited approximately 250 persons who were working with me in the gambling fraternity. Murray Chotiner told me I should have a quota of \$25,000 for the campaign. During the course of the evening Nixon spoke for approximately ten minutes; Chotiner spoke about half an hour. At this meeting my group pledged between \$17,000 and \$19,000 but this did not meet the quota set by Nixon and Chotiner and the group was informed they would have to stay until the quota was met."

Between 1949 and 1952, Pearson reported, Chotiner and his brother, both lawyers, represented Mafia underlings in 221 cases and succeeded in keeping nearly every client out of jail. In 1952 when Chotiner was called before the McClellan Senate committee then investigating influence peddling, Nixon intervened with Senator Joseph McCarthy to soft pedal the investigation, according to Pearson.

3. Smathers also rose quickly up the political ranks. Like Nixon, he was a World War II veteran first elected to the House in 1946 and then elected to the Senate in 1950. And, like Nixon, Smathers was a beneficiary of the CIA's intrusion into electoral politics. In Smathers's 1950 primary race against Democrat Claude Pepper, the CIA told his campaign about Pepper's alleged communist ties. The information was used to nickname his opponent "Red" Pepper.

Nixon, Rebozo and Smathers may have begun working together as early as World War II. During the early Forties, Smathers was in court defending a client accused of smuggling American-made tires through Cuba and thereby circumventing the tire-rationing laws. When Smathers encountered a delay in the case, he sent a letter to the Office of Price Administration in Washington, where Nixon was a lawyer in the tire-rationing section charged with preventing any profiteering, a job Nixon later chose to cover up in his official *Congressional Directory* entry. Smathers's father held a similar job on a local rationing board in southern Florida, where Rebozo was the area's top supplier

of recapped tires. Investigators have tried — and so far failed — to prove that the trio first met during this period.

5. In 1969 Congress closed the tax loopholes enjoyed by such foundations. But the Hughes organization asked for an exemption and so far has been able to delay compliance with the new law, thus depriving the U.S. Treasury of another \$180 million.

6. Hunt became personally attached to the anti-Castro cause. He became close friends with Manuel Artime, the CIA-designated replacement for Castro, and Artime became godparent to one of Hunt's children. Artime also knows Bebe Rebozo: Artime's partner in a meat company, Edgardo Butlari, is a business partner of Rebozo's.

7. Hughes's fascination with gangsters dated back to the Thirties and Forties when he was a Hollywood movie producer. In 1931 he filmed *Scarface*, a movie based on Al Capone's exploits. He also launched the careers of George Raft, later one of Lansky's ubiquitous casino front men, and of Jean Harlow, who became the girlfriend of the Syndicate's top man on the West Coast, Longie Zwillman.

8. These four had a specific reason for helping. They had buried \$750,000 on the island before being evicted, and the CIA promised they could recover the cash unhindered after the invasion. The information they supplied, however, was exaggerated to make Castro appear weak, and they thus headlessly encouraged a CIA proclivity for over-confidence.

9. According to Alfred McCoy's investigation for *The Politics of Heroin*, Trafficante had delegated some responsibilities to his son, Santo, Jr. "As his father's financial representative, and ultimately Meyer Lansky's, Santo, Jr. controlled much of Havana's tourist industry," McCoy wrote. "Moreover, it was reportedly his responsibility to receive bulk shipments of heroin from Europe and forward them through Florida to New York."

10. The passport office had trouble believing Sturgis was a double agent and stripped him of his citizenship. It took personal intervention from Smathers, "the senator from Cuba," to reverse the decision.

11. By late 1960 Sturgis had become a leader in the International Anticommunist Brigade (IAB). According to Hans Turner, an Englishman who also served with anti-Castro groups, the IAB was "probably financed by dispossessed hotel and gambling-room owners who operated under Batista."

12. One member of Operation Forty, Juan Cesar Restoy, was charged in 1969 with being a ring leader in a narcotics operation that the Justice Department claimed was responsible for smuggling 30% of all heroin and 75% of all cocaine into the U.S. But Restoy was executed before he came to trial — amid speculation he intended to implicate the CIA in the dope operation.

A popular theory in Miami's Cuban-American community is that Restoy was killed by a special CIA unit set up to assassinate suspected double agents or others who "turn around." In a recent *New York Times* interview Howard Hunt confirmed that he first heard of such an assassination squad in the mid-Fifties. The Senate CIA committee found some evidence that a CIA operative in Latin America was killed by the unit after he tried to blackmail the agency.

13. According to his Senate testimony, Maheu also helped the CIA sabotage a mid-Fifties shipping deal that would have given the late Aristotle Onassis a monopoly on oil shipments from Saudi Arabia. The sabotage included bugging Onassis's room and planting false stories about him in a CIA-owned newspaper. In other sworn testimony Maheu has admitted to hiring a Mafioso for an undisclosed but "sensitive" CIA assignment. And according to the 1976 House CIA Report, the CIA used Maheu to provide Jordan's King Hussein and other foreign leaders with "female companions."

14. The assassination planned was interrupted at one point when Giancana suspected that his girlfriend, Phyllis McGuire of the McGuire Sisters, was having an affair with comedian Dan Rowan. According to the Church committee, Maheu hired a private detective to bug Rowan's hotel room in Las Vegas. But the private eye was caught and the CIA had to pull rank on the FBI to cover up the incident.

15. Frank Sturgis gave the *New York Daily News* a slightly different account of the murder attempt. Sturgis said that a chocolate malt, for which Castro had an enduring fondness, was spiked with the poison. But when the waiter delivered the malt his hands shook so hard that Castro became suspicious and had the drink analyzed.

16. Among those involved in these missions were Bernard Barker, Eugenio Martinez and Frank Sturgis — all of whom later became Watergate burglars.

17. During the early Sixties, according to the Church committee, the CIA maintained a secret "Executive Action Group" set up, in the words of one official, to develop "methods for the removal of unfriendly leaders."

18. In November 1961 Kennedy confided to *New York Times* reporter Tad Szulc that he was under pressure from the intelligence community to order Castro's assassination. According to Szulc, JFK said he opposed the idea because he felt the U.S. should never be party to a political assassination. Senator Smathers, no friend of Castro, said he had held a similar conversation during early 1962 in which Kennedy "was very outspoken against taking that [assassination] line."

19. The president's inherited fortune made him invulnerable to any bribe offers from the Syndicate. But in early 1961 Judith Exner, a girlfriend of Sam Giancana and John Roselli, eased her way into Kennedy's presidential bed, a circumstance that could have given the Syndicate leverage over the young president. There is no evidence, however, that JFK submitted to any pressure. According to the Senate CIA report, Kennedy dropped Exner from his schedule immediately after learning of her underworld friendships.

20. Maheu had worked under Bannister when both were agents in the FBI's Chicago bureau during World War II. Bannister later became a private investigator and hired out his skills to Marcello. But Bannister's major preoccupation was fighting communism. In 1954 he started the Anti-Communist League of the Caribbean, which took part in the Guatemalan *coup d'état* that Hunt helped orchestrate for the CIA.

21. Garrison's investigation apparently mistook Bradley for Eugene Hale Brading. According to Peter Noyes, a prize-winning Los Angeles newsman, Brading had a New Orleans office in the same building and on the same floor as David Ferrie. Brading and Jack Ruby also visited the same Dallas office the day before the JFK assassination. Immediately after the assassination, Brading was picked up at the scene but was released when he told police he was an oil company representative. Brading's real job, according to Noyes, was ferrying illicit money for the Syndicate. The Warren Commission, however, learned none of this information.

22. E. del Valle, a good friend of Ferrie's who had taken part in anti-Castro raids with him, was found shot and hatched to death on the same day Ferrie died.

23. In 1967, according to *Life* magazine, Marcello engineered an effort to spring Hoffa from his federal prison cell. Along with other Syndicate chieftains, including Santo Trafficante, Marcello offered a \$1 million bribe for the key government witness to recant his testimony against Hoffa. But the witness declined.

24. In a March 26th, 1964 memo, the FBI admitted it knew of McWillie's links to the Syndicate: "It would appear McWillie solidified his Syndicate connections through his association in Havana, Cuba, with Santo Trafficante ... [and] Meyer and Jake Lansky."

25. Dalitz had owned a Havana casino and, by his own admission, had known Lansky for 30 years. In 1975 Dalitz (and three associates) filed a \$630 million suit against *Penthouse* after the magazine described him as a Syndicate member. However, in a 1962 conversation wiretapped by the FBI, Dalitz ranked himself with Roselli and Sam Giancana. "I was seen with them. I don't think that's good," Dalitz said, referring to a meeting with Roselli and Giancana. "It ties the whole Mob up." Dalitz is also close to the Teamsters. In the late Sixties he became part owner of La Costa Country Club near San Diego, a plush resort allegedly financed by \$57 million in Teamster pension money. La Costa served as a meeting place in 1973 for Nixon's White House aides who were mapping out Watergate strategy.

26. The Justice Department's War on the Syndicate never regained the same fervor after John Kennedy's murder. By 1967 the organized crime section was working half as many days and filing 80% fewer court briefs than before the assassination.

27. In 1973 a convicted stock swindler told a Senate subcommittee that he used Rebozo's bank in 1969 to cash a \$115,000 check, a check originally obtained by selling purloined securities. The swindler had this to say about Rebozo: "I understand he'd take a hot stove if you offered it to him." Rebozo was considered an expert in extra-legal

profiteering. Rebozo had wrangled five loans out of Small Business Administration (SBA) during the Sixties, thanks in part to Senator Smathers, who sat on the Small Business Committee and who wrote a letter recommending Rebozo to the SBA. *Newsday* investigated and denounced the SBA "for wheeling and dealing ... on Rebozo's behalf." The biggest loan, which turned a \$200,000 profit for Rebozo, went to a construction project handled by "Big Al" Polizzi, a convicted black marketeer who once smuggled rum from Cuba and who had been named in Senate testimony "as one of the most influential members of the underworld."

28. Lansky's use of the Miami National Bank surfaced in a 1969 federal indictment. The same bank had been controlled previously by the Teamsters. In the 1956-66 decade of Teamster-Syndicate control, the government indicted nine top bank officials for a variety of offenses. A tenth official, the former chief executive officer, left to found the International Bank of Miami, then headed the Florida citizens campaign for Nixon in 1968. On the board of directors at the International Bank of Miami was James Angleton, who, until his resignation during the 1974-75 CIA scandal, was chief of the CIA's counter-intelligence bureau and the alleged head of the CIA's domestic spy network.

29. But Nixon placed conditions on Hoffa's parole, which prevented his return to Teamster politics until 1980, to keep Frank Fitzsimmons happy. Fitzsimmons, Hoffa's successor as Teamster president, engineered campaign support for Nixon in 1972. In early 1973, shortly after Nixon's re-election, Attorney General Richard Kleindienst canceled FBI wiretaps that, according to the *New York Times*, "had begun to strip the cover from a Mafia plan to reap millions of dollars in payoffs from the welfare funds of the International Brotherhood of Teamsters." Lou Rosanova, identified by the Times as an "envoy for the Chicago crime syndicate," met with Fitzsimmons at La Costa Country Club on the morning of February 12th, 1973. A few hours later Fitzsimmons flew with Nixon from California to Washington, D.C. aboard the presidential plane. On February 27th, Rosanova was overheard boasting of a deal between him and Fitzsimmons. A week later Nixon's attorney general effectively shut down the FBI investigation of Fitzsimmons.

30. In a March 23rd, 1971, conversation recorded by a White House bug, Nixon discussed a deal with John Connally. "There's a very substantial allocation of oil in Texas that will be at your discretion," Connally said. "Fine," Nixon answered. But Connally continued, "Unless you want somebody else to do it. Somebody..." That somebody apparently was Rebozo.

31. When Resorts wanted to find out what Syndicate informant Vincent Teresa was telling federal officials about Resorts' ties to Lansky, for instance, Intertel managed to interrogate Teresa privately — even though Teresa was then a valuable federal informant guarded around the clock by U.S. marshals. Teresa's testimony about Resorts subsequently came to naught.

32. Many CIA experts believe the Russian sub story was actually a cover since the codes were outdated and the value of the other information was negligible. One possibility is that the CIA, worried about the growing trend of Third World cartels demanding higher prices for minerals, awarded Hughes the \$350 million to develop an advanced technology for underwater mining — thereby giving Hughes a head start toward a bonanza with more potential than oil while helping protect U.S. hegemony over the world's mineral trade. Another theory is that the CIA, in conjunction with the U.S. Navy, used the Glomar to set up undetected missile sites on the ocean floor as a way of cheating any arms limitation treaty with the Soviet Union.

33. The *London Sunday Times* team that investigated the Irving hoax did find a curious piece of evidence suggesting the idea did originate with Maheu or his allies. In late November 1970, the same time Maheu was fired, Irving's wife told friends that her husband was contemplating "a proposition" worth \$500,000 from men "who would stop at nothing to achieve their own ends — even murder." The *Sunday Times* reporters felt that this "proposition" involved the Hughes biography. (The book also disturbed old ghosts. A *New York Times* investigation, apparently prompted by the book, revealed on January 23rd, 1972, that the Kennedy administration had seriously considered bringing influence-selling charges against Nixon for his role in Hughes's 1956 loan to Nixon's brother.)



34. The Senate committee's investigation of the Greenspun burglary was deleted from the final report. *Rolling Stone* has obtained a copy of the unpublished section.

35. Some confusion about this still exists. Greenspun says his office was burglarized — aluminum sills pried apart, a catch jimmied, wooden shutters shoved aside and a steel plate ripped off the front of his Meilink safe. But he says nothing was stolen.

36. According to Jack Anderson, Barker was also an investor in real estate deals involving Bebe Rebozo. According to CIA sources, Barker and Rebozo met during the Bay of Pigs operation when both were funneling money to the CIA-financed invaders.

37. One man who played a key role in convincing Nixon to resign, according to Woodward and Bernstein in *The Final Days*, was Alexander Haig, who had replaced Bob Haldeman as Nixon's top White House adviser. Haig also had a CIA connection. In the early Sixties he ran a CIA-financed Bay of Pigs rehabilitation program,

preceding Alexander Butterfield in the job. According to Chuck Colson, it was Haig who convinced Nixon not to expose the CIA's role in Watergate. "Al Haig prevailed on Nixon's better instincts," Colson said in May 1974, "not to take down the whole intelligence establishment of the U.S. in order to save himself from impeachment."

38. Hughes encountered competition from Robert Vesco, who also wanted to buy Resorts. Vesco was a lavish Nixon contributor, later providing part of the money for the Plumbers, and he was friendly with the CIA; once when Vesco landed in a Switzerland jail a CIA agent had helped get him out. Vesco outmaneuvered Hughes by persuading a Bahamian immigration official to demand Hughes apply for a visa, a procedure requiring a recent photograph. Affronted, Hughes packed and flew off to Nicaragua and London before returning to the Bahamas. By then Vesco was out of the picture, having been charged with influence peddling for his contributions to Nixon. But Hughes apparently did not renew his efforts to purchase Resorts.

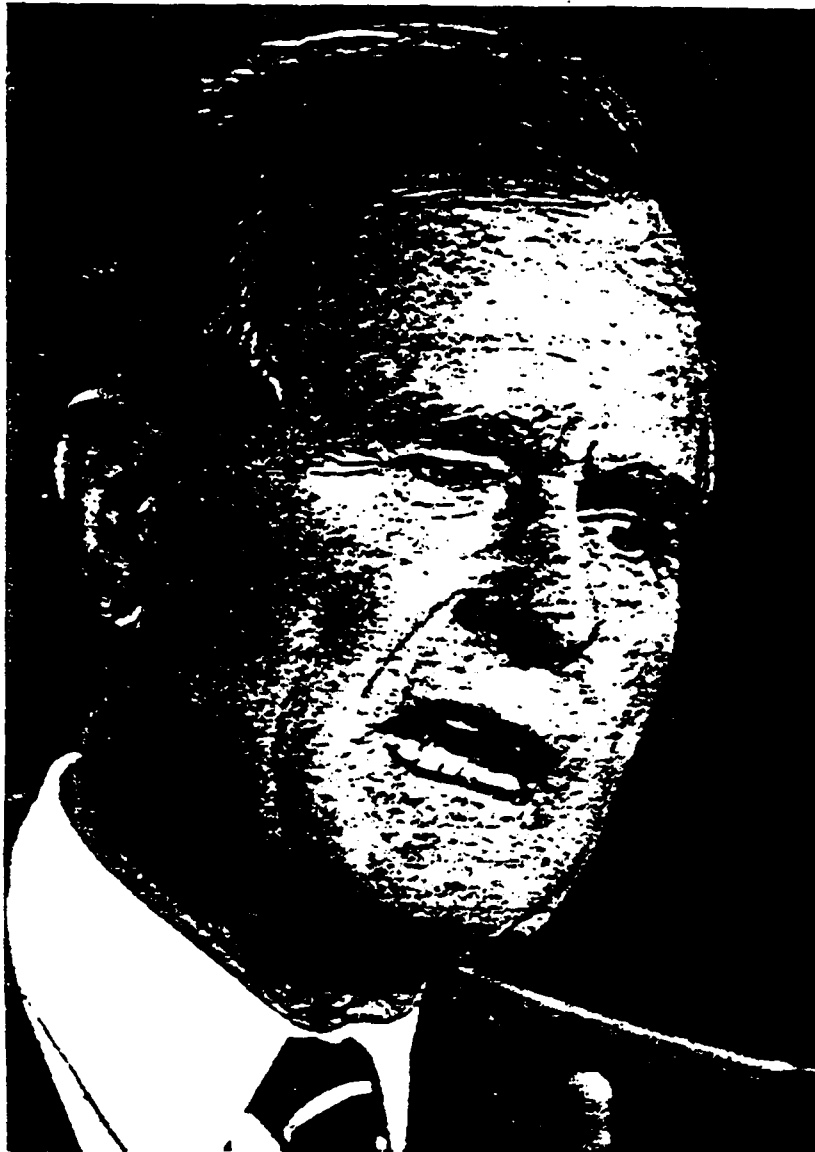

The Fascist Agenda for the 90's

I've said for several years in my lectures that there's a three-pronged program for the current period going into the turn of the century. One prong is to get a stranglehold on all natural resources. They know where they are, they've known of them from satellites. They knew in the 50s where most of them were. Most of their motive for going into Vietnam was not the genocide of the Asian people there, although that was a side bonus to send a message out to people not to get out of line, but it was because offshore oil was discovered in 1954, larger than the Texas Panhandle, because tungsten couldn't be gotten in that volume anywhere else in the world which is why we funded the French, because we knew the day after Pearl Harbor (when 98% of our rubber supply was cut off because the Japanese closed the southern rim of the Pacific to us) there were specific strategic materials there that we wanted to control and have access to.

That's really the basis of the game, starting with oil, which is often the most important element in the whole history, the secret history of oil, and then later uranium. But oil is the major source that has to be protected. Also gold and other things. There's enough raw material in the southern tip of Africa, from the northern border of Zimbabwe down, to keep us at current consumption levels for another 500 years. This is why we back the current apartheid régime there and don't want local rule and will do whatever is necessary — genocide, intervention, or exploitation of malleable labor — to control those resources and deny them to the Soviet Union.

The second aspect or prong of the fascist agenda is to establish by the end of the century a first-strike capability of nuclear weapons. That's what MX and Trident and Star Wars are about — to give us first strike capability and the idea of a "winnable" nuclear war, where we have 15% of the industrial capability and at least 5% of the population left. That's enough for them to call it a win. They're going to be down in the underground bunkers anyway, and to go for broke they have a thing called Air Land Battle 2000. In *Army Times* magazine they talk about it. It's full-scale chemical, biological and nuclear attack on the Soviet Union by the turn of the century.

But the Soviets are no longer in a position to wage the nuclear arms race and the cold war because it's bankrupted their entire economy to the point that they've got a huge internal domestic problem. So Gorbachev is playing *realpolitik* in a clever way that at least partially embarrasses the United States into dropping some of their defenses. But at the same time Bush talks about going to the Malta summit and having a "kinder and gentler America." he's developing a new program of next generation nuclear weapons called SIOPS 7, with nuclear bombs that burrow 600 feet into the ground and blow up the Soviet command

bunkers. They've got just one step after another going ahead with the program.

The third aspect that I've talked about for some time is the destabilization of the eastern European buffer zone that was set up between the fascist and monarchist states and the Soviet Union. The whole history that I talk about really began in 1918 with the Bolshevik revolution and the reaction of the monarchs and the industrialists around the world, the fear that that might happen someplace else. Herbert Hoover served as a central element in collecting money from the monarchists and others under the International Red Cross. He delivered food and monies that were supposed to go to the starving people in Russia to the Vasilov White Russian armies and counter revolutionaries instead and fed and financed them to try and destroy the Bolsheviks. He spent years and years collecting monies from the remaining monarchies and a secret fund was established that was pumped into post-World War I Germany to finance the secret rearmament of Germany from 1918 to 1932 and the eventual rise of Hitler and the nazi war machine. The main purpose of that war machine's development was to get back the Soviet Union. They failed in 1943 at Stalingrad at a cost of over 20 million Soviet lives; the Soviets won the war in that sense at tremendous cost and stopped the drive and in 1943 Allen Dulles and the others knew that they had to go back underground and regroup and work again for the rise of the Fourth Reich and international fascism which is what we live under and are fostering in the current period and the Soviet Union is again the target. But part of that would be Hitler's old dream of the reunification of the German state, which is what they're trying to portray with the Berlin Wall change, although the politics internally in East Berlin are not that different and the people that came over mostly came over to get a free Coke and \$50 in free shopping money and went back the same day.

They always like to talk about all the people running from communism, but usually reality is a little different. They like to say that the Soviets put up the wall to stop the brain drain, but I think that the reality was that they put up the wall to stop all the nazi agents that weren't taken out of the post-war German military and intelligence structures from coming in and easily infiltrating and destroying their attempt at a socialist society. I think that the main people involved in these eastern European changes are the old revanchists, the Radio Free Europe people. The nazi sympathizers are being invited back in.

I talked earlier about Lech Walesa. Everybody thought he was so noble when he got \$1 million from the Nobel Peace Prize and gave it to the Vatican. Well, he's just paying interest on the \$50 million that the Pope, whose family name is Wojula, gave to him in order to help effect Solidarnosc and the Polish disruption there. But they're doing an effective job of changing the nature of the buffer job and destabilizing it and I think it's just part of the program. By the end, some of these people want to go for broke. They want to go to martial law and total armed control here in the United States.

# The Bombing of Pan Am 103

by Jeff Jones\*

Pan Am 103, the jumbo jet that blew up over Lockerbie, Scotland on December 21, 1988, might have passed into history as simply another example of the tragic loss of life spilling out of the Middle East conflict. But, as with other incidents of this kind, the official investigation leaves questions unanswered. Many relatives of the victims — the plane's 259 passengers, and 11 people on the ground — fear that the full truth will never be known.

By most accounts, investigators believe the crash was caused by a sophisticated bomb — with a time-delay, barometric fuse — placed on the plane by Ahmed Jibril's Popular Front for the Liberation of Palestine-General Command (PFLP-GC), a Syrian-backed group that rejects PLO efforts to negotiate with Israel.

Flight 103 originated at Frankfurt and continued on, with another plane, from London. The bomb detonated at 7:03 p.m. If it had gone off just 10 minutes later, the Pan Am clipper would have already crossed the Scottish coast and the plane — its victims and evidence — would have vanished in the North Atlantic. Jibril has denied responsibility for the attack. But investigators believe that the PFLP-GC received a large payment from Iran — ABC News has reported \$10 million — to carry out the attack to avenge the U.S. downing of an Iranian airbus in which nearly 300 people died on July 3, 1988.

Paul Hudson, an Albany, New York lawyer, is the president of Families of Pan Am 103/Lockerbie, one of three groups made up of relatives of the victims. Paul and Eleanor Hudson's 16-year-old daughter Melina was returning home from a year of school in England when she died in the crash. "Anything that will prevent a coverup, ... that will keep others from experiencing what we have, is important," Eleanor Hudson said recently. "The full truth should come out," Paul Hudson agreed. The charge of cover up does not come easily to either Eleanor or Paul. But Paul Hudson, who has followed the investigation closely, is dismayed at its progress. "It appears that the government either has the facts and is covering this up," he said, "or doesn't know all the facts and doesn't want to."

## Many Questions

Most of the initial controversy surrounding Pan Am 103 focused on the U.S. government's long standing policy of not informing the general public when an airline, an air-travel corridor or a specific flight has been threatened by terrorist attack. Pan Am 103 fit in to all of these categories. But there are many other questions percolating just beneath the surface of

\* Jeff Jones is a political correspondent with *Merroland*, an alternative newsweekly based in Albany, New York.

the investigation:

- There were, it is now known, at least four, and, according to one unsubstantiated report, as many as eight, CIA and other U.S. intelligence agency operatives returning from Beirut, Lebanon, aboard the plane. The Lockerbie bomb crippled U.S. intelligence efforts in the Middle East. Were the intelligence operatives on 103 the bomb's target?

- A CIA team headed for Lockerbie within an hour of the crash.<sup>1</sup> At least once during the ground search, CIA investigators wore Pan Am uniforms; and according to one unrefuted allegation, CIA operatives temporarily removed a suitcase from the site that belonged to one of their agents, thereby breaking the Scottish police investigators, "chain of evidence," which could be crucial to any successful prosecutions.

- Also aboard Pan Am 103 was Bernt Carlsson, the Swedish U.N. diplomat, who had just completed negotiating the Namibian independence agreement with South Africa. He was due in New York the next day to sign the agreement.

- In October 1988, the West German Federal Police, the Bundeskriminalamt (BKA), raided a suspected terrorist safehouse. During the raid, they found a bomb — hidden in a Toshiba radio — that was virtually identical to the one believed later to have brought down Pan Am 103. All but one of the 16 people arrested were soon released and several of them are now top suspects in the bombing.

- Pan Am was fined more than \$600,000 by the U.S. Federal Aviation Administration (FAA) for lax security at its baggage-handling facility in Frankfurt. And according to the West German newsweekly *Stern*, a Pan Am security official in Frankfurt was spotted after the crash backdating a copy of a crucial FAA memo. The memo described a call placed to the U.S. Embassy in Helsinki in which the caller reportedly warned that a bomb would be smuggled onto a Pan Am aircraft flying from Frankfurt to the United States.

- The most startling and controversial charge to surface around Pan Am 103 comes from a report issued by a little-known New York City-based intelligence group called Interfor, Inc.<sup>2</sup> The company was hired by the law firm representing

1. Steven Emerson and Brian Duffy, *The Fall of PanAm 103* (New York: Putnam's, 1990), p. 41.

2. According to Daniel Aharoni, Interfor's general counsel, the 10-year-old company is engaged in "private intelligence and security" for corporate clients. From time to time, Aharoni said, Interfor conducts "overseas investigations on particular measures, including counterterrorism." Juval Aviv, the company's founder and president and a former member of Mossad, authored the controversial report.

Pan Am's insurance agents to find out what happened. The Interfor Report was leaked to the press last fall.<sup>3</sup> Its immediate impact was to stall, indefinitely, the approximately 300 civil court cases filed against Pan Am by relatives of the victims. Interfor has charged that a rogue CIA unit in Frankfurt, seeking to make a deal for the release of U.S. hostages in Beirut, was protecting a Middle East heroin smuggling operation being run through Pan Am's Frankfurt baggage operation. The fatal bomb, according to this allegation, was placed on the plane in a suitcase substituted for one that normally would have contained contraband.

• But according to a January 1990 report on Frontline, the PBS news program, the bomb was placed on the plane at London's Heathrow Airport when a baggage handler switched suitcases belonging to CIA officer Matthew Gannon. Frontline believes the planning for the retaliatory bomb attack was already under way when the group learned that several top U.S. intelligence officers would be flying Pan Am 103 out of London's Heathrow Airport. Gannon and two other operatives, having left Beirut by separate routes, may have made a fatal error when they purchased their plane tickets over-the-counter from a travel agent in Nicosia. According to Frontline, the only piece of luggage not accounted for from the flight belonged to Gannon. Frontline's investigators believe that the intelligence officers were "a strong secondary target" and that a suitcase identical to Gannon's was switched at Heathrow.

• And according to syndicated columnist Jack Anderson, President George Bush and British Prime Minister Margaret Thatcher held a transatlantic phone conversation some time last year, in which they agreed that the investigation into the crash should be "limited" in order to avoid harming the two nations' intelligence communities. Thatcher has acknowledged that the conversation took place, but denied she and Bush sought to interfere with the investigation.

#### The Interfor Report

The controversial Interfor Report maintains that a Frankfurt-based CIA team was protecting a heroin smuggling operation in hopes of obtaining information about U.S. hostages in Lebanon — the same hostages that sparked the Iran/contras arms-for-hostages scandal.

The report claims that the drug smuggling ring is headed by Syrian Monzer Al-Kassar, and controls at least one Pan Am baggage handler at the Frankfurt airport. The handler was responsible for switching luggage that had already been inspected with identical pieces holding contraband. A pas-

3. According to several sources, ex-CIA agent Victor Marchetti got hold of the report and gave it to Congressman James A. Traficant Jr. (Dem.-Ohio), who released parts of it to the media. Another copy of the report turned up in the hands of a West German paper affiliated with the Lyndon LaRouche network.

---

The bomb was placed on the plane at London's Heathrow Airport when a baggage handler switched suitcases belonging to CIA officer Matthew Gannon.

---

senger accomplice would then pick up the bag upon its arrival in the U.S. Interfor admits it does not know how the bags passed through customs on arrival, but insists in its report, that "this route and method worked steadily and smoothly for a long time."

Al-Kassar is a known arms and drug smuggler who had received money from two Iran/contras

figures, Albert Hakim and Richard Secord, to buy 100 tons of small arms for the Nicaraguan contras. According to the report, he was also the go-between for a French effort in May 1988 that gained the release of French hostages in Lebanon in exchange for an arms shipment to Iran. Al-Kassar was spotted by the CIA team in Frankfurt which, knowing he had close ties to Syria's chief of intelligence, "...approached Al-Kassar and offered to allow him to continue his drug smuggling routes...if he helped arrange the release of the American hostages."

The Interfor Report says that the CIA group in Frankfurt, although it had contact with the West German BKA and the U.S. Drug Enforcement Administration (DEA), operated to some extent as "an internal covert operation, without consistent oversight, à la Oliver North." In the days before the attack on Flight 103, the report states that Al-Kassar learned that a bomb was going to be placed on the plane by Jibril's Popular Front. On the day of the flight, a BKA surveillance agent assigned to watch baggage being loaded "...noticed that the 'drug' suitcase substituted was different" from those used in previous shipments. He phoned in a report to his superiors "saying something was very wrong."

The BKA relayed the information to the CIA unit, which reported to its control in Washington. The report alleges that "Control replied: Don't worry about it, don't stop it, let it go." The CIA in Frankfurt did nothing to prevent the plane from taking off, because the team "did not want to blow its surveillance operation and undercover penetration or to risk the Al-Kassar hostage-release operation." The report postulates that the CIA assumed — incorrectly — that West German authorities, who were also watching the flight, would intervene.

The Interfor Report also explains why a special U.S. hostage rescue team was on board Pan Am 103 when it was destroyed. According to the report, the team, led by Army Major Charles McKee, had learned that the CIA unit in Frankfurt was protecting Al-Kassar's drug pipeline. McKee reported to CIA headquarters he feared "...that [his team's] rescue [operation] and their lives would be endangered by the double-dealing."

When CIA headquarters did not respond, the McKee team decided to return home without permission. The Interfor Report states that "their plan was to bring the evidence back to the United States [of the CIA's involvement with Al-Kassar and drug dealing] ...and publicize their findings if the government covered it up." Agents connected to Al-Kassar

through Syrian intelligence saw the McKee team make their travel arrangements back to the U.S., and, according to the report, Al-Kassar informed his Frankfurt CIA protectors of McKee's plans.

Following the leak of the Interfor Report, Pan Am went before the federal judge hearing the civil suits against the airline and asked that he subpoena the CIA, FBI, DEA, and State Department in an effort to verify Interfor's findings. The government moved to quash the subpoenas on national security grounds. The Justice Department then took the case out of the hands of its local attorneys by sending a team from Washington to handle the litigation. A ruling is still pending.

#### Who Was Warned?

There is also considerable controversy surrounding a warning the U.S. government received about a possible plane bombing but never made public. A notice, reportedly based on a tip called into the U.S. Embassy in Helsinki, Finland, was posted in the U.S. Embassy in Moscow and elsewhere—including electronic bulletin boards—where it could be seen by government officials.

The State Department now calls the threat a "hoax." But the FAA took it seriously enough at the time to issue one of its rare security alerts, an alert that was in effect on the day Flight 103 went down. The Pan Am jet, travelling the crowded Frankfurt-London-New York City corridor four days before Christmas, was only two-thirds full. Many relatives of the victims are convinced that this was because government employees avoided the flight.

One official who didn't avoid the flight was Bernt Carlsson, the Swedish U.N. diplomat who successfully negotiated the Namibia accord which led to free elections and a SWAPO-led government in the former South African colony. Carlsson was due at the U.N. the day after the crash to sign the agreement. "Pik" Botha, the South African Foreign Minister, had also been scheduled to fly on Pan Am 103 but he switched his reservation, avoided the flight, and was in New York for the signing.

According to Sanya Popovic, Carlsson's then fiancée, Botha acknowledged at the time that he had been advised to switch planes. Popovic believes that the U.N. also received the warnings about the flight, but that Carlsson was never informed.

The President's Commission on Aviation Security and Terrorism issued its report—not on who was responsible for the bomb, but what, if any, changes should be made in airline security—in mid-May 1990 (see sidebar). The FBI and Scotland Yard have been cooperating with Scottish police (in whose jurisdiction the plane crashed). Their final report will be released in June 1990.

The primary reason that the PFLP-GC is suspected of planting the fatal device, has to do with the similarity between the Pan Am bomb—probably consisting of Semtex, a Czechoslovakian-made plastic explosive hidden in a Toshiba radio—and a bomb found by the BKA during an October 1988 raid on a PFLP-GC safe house in Neuss, West Germany.

That raid, carried out as part of an undercover BKA sur-

veillance operation code-named Autumn Leaves, left West German officials facing intense criticism. Of the 16 people they rounded up, all but one were quickly released from jail. And some of those released are now suspects in the Lockerbie bombing. (The West Germans were further embarrassed when, nearly three months after the Pan Am bombing, several more similar bombs turned up during a subsequent BKA search of the Neuss safe house.) There are enough apparent mistakes and lapses in the West German handling of Autumn Leaves to argue that the bungled investigation allowed the bombers to slip through police hands.



Credit: Associated Press

Bernt Carlsson (right), U.N. Commissioner for Namibia, was killed in the PanAm 103 bombing.

That was the impression conveyed in a recent *New York Times Magazine* story on Pan Am 103.<sup>4</sup> The article, edited from a new book, *The Fall of Pan Am 103*, by Steven Emerson and Brian Duffy, focused entirely on the West German police and neglected to mention many of the questions that have troubled reporters and families of the crash victims. The article did not even mention the presence of the CIA personnel on the plane, or describe any of the subsequent CIA actions at the crash site.

The *Times* version of the story surprised Duffy, an assistant managing editor of *U.S. News & World Report*. The book goes into "great detail" about who the CIA officers were, Duffy said. "If the book has news value, it rests in part on our conclusions on who the intelligence officers were and what they were doing." He too was surprised that the *Times* editing of the story focused solely on the West Germans.

In fact, the Emerson/Duffy book is long on speculation and

4. Steven Emerson and Brian Duffy, "Pan Am 103: The German Connection," *New York Times Magazine*, March 18, 1990. An Associated Press wire story on the *Times* article appearing in the *Las Vegas Review-Journal*, March 18, 1990 was headlined, "Book: German bungling allowed jet bombing."

## The President's Commission

The President's Commission on Airline Security and Terrorism issued its report on May 15, 1990, leaving many questions about the bombing of Pan Am 103 unanswered. But it did make a series of recommendations, including that the U.S. should be more willing to attack suspected terrorists and the states that harbor or support them. "National will and the moral courage to exercise it are the ultimate means for defeating terrorism," the Commission says.

The report calls for government officials to become more vigorous in "planning and training for preemptive or retaliatory military strikes against known terrorist enclaves in nations that harbor them." "Rhetoric," the report maintains, "is no substitute for strong, effective, action."

Threatening military action may be a cynical means for dealing with the anger of relatives of the victims. In April 1989, during a meeting with representatives of the relatives, Bush reportedly offered the unsolicited statement that if "the fingers [of guilt] point to state terrorism," there would be a retaliatory strike like the one the Reagan administration launched against Libya.

Beyond the grandstanding, the report focuses serious criticisms on the Federal Aviation Administration (FAA). The Commission found the FAA to be "a reactive agency—preoccupied with responses to events to the exclusion of adequate contingency planning in anticipation of future threats."

In all, the report contained more than 50 specific proposals designed to improve airline safety and thwart terrorist attacks. Some of the proposals will go to the President as recommendations for action by executive order, while others will be introduced in Congress.

And while it was not included in the Commission's report, the FAA was clearly inclined to meet at least one demand voiced by the victims' relatives: On May 10, an FAA spokesman announced that Raymond Salazar, its director of civil aviation security since 1986, would be leaving his post to become the director of the FAA's Center for Management Development in Palm Coast, Florida. An FAA spokesman claimed the move had nothing to do with criticisms arising from Pan Am 103.

According to the executive summary of the nearly 200-page Commission report, the bomb was "probably" placed aboard at Frankfurt. The summary also states that "a partially filled, unguarded baggage container... was later loaded on the flight at Heathrow." That container, according to Commission head Ana McLaughlin, sat unattended for at least half an hour. "The international criminal investigation has not yet determined precisely how the device was loaded onto the plane," the report says.

While the Commission harshly criticizes both the FAA and Pan Am, it lets the U.S. intelligence community off the hook. "The Commission's review showed that no warnings specific to Flight 103 were received by U.S. intelligence agencies from any source at anytime," it reports. And it repeats testimony presented to the Commission by the CIA claiming that the agency "did not send anyone to the [crash] site."

Indeed, an important part of the Commission's report will remain unknown. Part of the body's conclusions—apparently related to a call for more aggressive covert operations intended to prevent or respond to terrorist acts—was sent to the President in a classified letter. ●

short on conclusion. The authors do not purport to know just what happened. They believe that Khalid Jaafar, a young Arab-American from Detroit, "unwittingly" carried the bomb hidden in a bag onto the plane in Frankfurt. Who gave it to him, and why he didn't "examine" the contents, they say, "is the biggest mystery of the Lockerbie investigation."

That, however, is hardly Lockerbie's biggest mystery. For one thing, Frontline reported shortly after the Emerson/Duffy book went to press that all of Jaafar's bags had been accounted for. Whichever bag or suitcase held the bomb, had to disintegrate into fragments, thereby clearing Jaafar's name. His parents believe he became a suspect because he had the only Arabic surname on the flight list.

But the more serious questions raised in the investigation have to do with the nature of the investigation, and why so many relatives and reporters feel a fog of disinformation hangs heavy over the crash.

### The Remaining Puzzles

Is the story of Pan Am 103 that some U.S. government, U.N. officials, and foreign leaders were spared because they

had access to information indicating that the flight was threatened, while the traveling public was kept in the dark?

Is it the case that in their rush to make flight schedules and cut costs, Pan Am allowed bags that had not been properly searched to be loaded on its plane?

Is it, as Interfor maintains, that a rogue CIA operation trying to free U.S. hostages by protecting a heroin smuggling ring failed to prevent the bomb from going on board?

Is it, as Frontline suggests, that experienced U.S. intelligence operatives made fatal security mistakes? Is the CIA trying to hide the fact that it could not bring its people home from Beirut safely?

Whatever the answer may be, many relatives of the victims fear they will never know what allowed the bombing to happen or see those responsible punished. An April 1990 letter to George Bush and Margaret Thatcher, cosigned by Paul Hudson and Jim Swire, co-chairs of "U.K. Families-Flight 103," spoke of the "entirely believable published accounts [that] ... both of you have decided to deliberately downplay the evidence and string out the investigation until the case can be dismissed as ancient history." ●

# New theory links Syrian to Flight 103

The Associated Press 4-19-92

NEW YORK — The bomb on Pan Am Flight 103 possibly was aimed at six CIA employees and arranged by a Syrian terrorist, not the two Libyans accused in the 1988 blast that killed 270 people, Time magazine reports.

A four-month investigation by the weekly newsmagazine says the bombing of the plane had two potential motivations:

■ Avenging the July 1988 shooting of an Iranian Airbus by the USS Vincennes.

■ Protecting Syrian drug dealer Monzer al-Khassar, who was cooperating with the U.S. Drug Enforcement Administration in a drug sting and with a CIA unit code-named COREA.

The CIA operatives on the plane may have intended to reveal the ties between COREA and al-Khassar, Time said.

According to the report, the cover story in Time's April 27 issue, another CIA team working to free the U.S. hostages from Beirut uncovered the connection between al-Khassar and COREA, which was allowing the drug dealer to continue his smuggling operation to the United States.

The CIA Beirut unit was infuriated about the link with the drug dealer, fearing his terrorist connections might squash any rescue attempt of the hostages.

Col. Charles McKee and five other members of the Beirut team were on the flight when it was

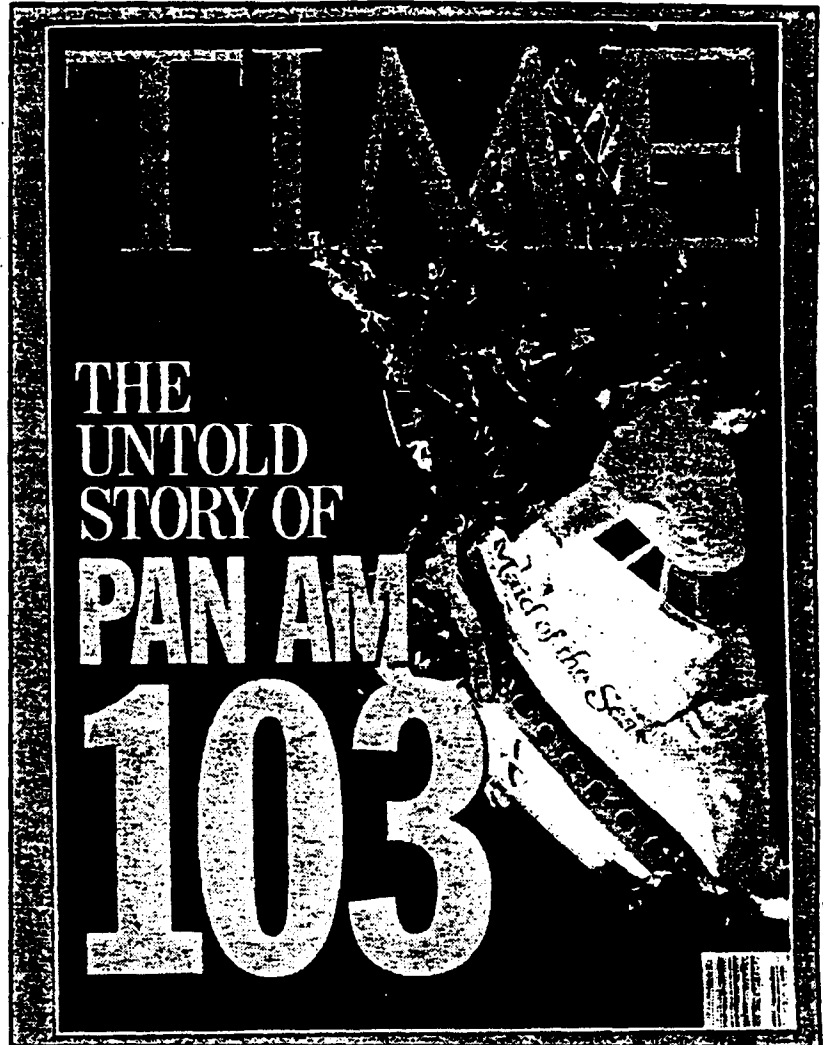

Associated Press

Time reports the bomb on Pan Am Flight 103 may have been arranged by a Syrian and aimed at six CIA employees who were passengers. THE CIA AGENTS WERE TO TESTIFY AT THE IRAN-CONTRA HEARINGS.

blown up over Lockerbie, Scotland, on Dec. 21, 1988.

retired U.S. military intelligence officer M. Gene Wheaton.

"A couple of my old ... buddies in the Pentagon believe the Pan Am bombers were gunning for McKee's hostage-rescue team," said

"But they were told to shift the focus of their investigation because it revealed an embarrassing breakdown in security."

M A T R I X I I I

THE  
CYCLOPEDIA OF FRATERNITIES

A COMPILATION OF

EXISTING AUTHENTIC INFORMATION AND THE RESULTS OF  
ORIGINAL INVESTIGATION AS TO THE ORIGIN, DERIVA-  
TION, FOUNDERS, DEVELOPMENT, AIMS, EMBLEMS,  
CHARACTER, AND PERSONNEL OF

MORE THAN SIX HUNDRED SECRET  
SOCIETIES IN THE UNITED STATES

SUPPLEMENTED BY

FAMILY TREES OF GROUPS OF SOCIETIES, COMPARATIVE STATISTICS  
OF MEMBERSHIP, CHARTS, PLATES, MAPS, AND  
THE NAMES OF MANY

REPRESENTATIVE MEMBERS.

---

COMPILED AND EDITED BY

ALBERT C. STEVENS

ASSOCIATE EDITOR OF THE STANDARD DICTIONARY AND FORMER EDITOR OF "BRADSTREET'S"

ASSISTED BY MORE THAN ONE THOUSAND  
MEMBERS OF LIVING SECRET SOCIETIES

---

SECOND EDITION, REVISED TO DATE.

---

1907

0678



-1750-1776 Various Occult Societies and Philosophical Brotherhoods [Europe]. See notes, under Freemasonry.

→ 1776 Phi Beta Kappa. The [Modern] Theosophical Society.

American College Fraternities. [More than three score of them.]

-1765 Sons of Liberty—Sons of Tammany—Society of Red Men—Improved Order of Red Men.

-1788 Society of the Cincinnati—Military Order of the Loyal Legion—Grand Army of the Republic—Sons of Veterans—and others.

-1797 Loyal Orange Institution—Knights of St. John and Malta—Knights of Malta.

-1806 Ancient Order of Hibernians.

-1842 Sons of Temperance—Independent Order of Good Templars—and others.

-1843 B'nai B'rith—Independent Order of Free Sons of Israel—Keshet Shel Barzel—and others.

-1844 Order of United American Mechanics—Junior Order of United American Mechanics—Patriotic Order of Sons of America—Brotherhood of the United Protestant Association—The "Know Nothing Party"—The "A. P. A."—and others.

-1852 Order of Heptasophs or Seven Wise Men—Improved Order of Heptasophs.

-1856 Order of Galilean Fishermen [Negro fraternity]—Other Negro Secret Societies.

-1861 Brotherhood of Locomotive Engineers—Like Orders of Railroad Conductors, Firemen, Trainmen, Switchmen, Carmen, and Telegraphers.

-1865 Knights of Pythias.

-1867 Benevolent and Protective Order of Elks—Patrons of Husbandry—Farmers' Alliance—and others.

-1869 Knights of Labor—Amalgamated Association of Iron and Steel Workers—International Association of Machinists—Glass Workers' Association—and others.

II.

-1739-1740 The ODD FELLOWS {  
-1835 Independent Order of Rechabites.  
-1861 United Brethren of Friendship.  
-1868 Independent Order of Mechanics.  
-1871 Sons of St. George.  
-1878 Order of Scottish Clans.

1760 Grand United Order of Druids—American Order of Druids.

1780 Ancient Order of Foresters—Foresters of America—Independent Order of Foresters—Knights of the Maccabees.

-1868 Ancient Order of United Workmen.— {  
-1873 Knights of Honor } Knights and Ladies of Honor—Loyal Knights and Ladies—Knights of the Golden Chain—  
Order of Protection.

-1871 Knights of Mystic Chain.

-1879 Order of Sparta.

-1873 Knights of Golden Eagle.

-1879 Order of Chosen Friends } Order of United Friends—United Friends of Michigan—Independent Order of Ch-  
Canadian Order of Chosen Friends.

1885 Legion of the Red Cross.

-1879 Order of the Red Cross.

-1873 Knights of Birmingham.

-1879 United Order of Pilgrim Fathers.

-1879 Knights of the Golden Rule.

-1882 Royal Society of Good Fellows.

-1880 United Fraternal League.

-1880 Order of Unity.

-1877 Royal Arcanum.

-1880 Empire Knights of Relief.

-1890 Fraternal Aid Association.

-1892 Knights and Ladies of Security.

-1893 National Fraternity.

-1894 Tribe of Ben Hur.

-1896 Columbus League.

-1878 American Legion of Honor } Iowa Legion of Honor.

Northwestern Legion of Honor.

-1879 Home Circle—Protected Home Circle.

-1881 National Union.

-1881 United States Benevolent Fraternity.

-1883 Royal League.

-1885 Grand Fraternity.

-1891 Modern Knights Fidelity League.

-1896 Order of the Iroquois.

-1897 Prudent Patricians of Pompell.

-1878 Order of the Golden Cross.

-1880 Modern Woodmen of America.

1890 Woodmen of the World.

1893 Home Forum Benefit Order.

-1891 National Protective League.

-1898 Mystic Workers of the World.

0679

M A T R I X I I I

# Knights of Malta

The Sovereign Military Order of the Knights of Malta is a powerful international, super-secret society with direct linkage to the Vatican.

Information on the Knights of Malta is sketchy. Some research connects it to Freemasonry and Gnosticism. Most connects it to the medieval Knights Templars---some to both. Either way, it is an organization with a dusky and shadowy past that is cloaked in honor, ethics and charity. There is a Catholic arm and a Protestant arm. Currently, Five Continent Grand Master is Andrew Bertie. However, the absolute head is Pope John Paul II.

The present-day Knights of Malta, otherwise known as the Sovereign Military Order of Malta (SMOM), is a 900-year-old, exclusive chivalric order. This ancient order of knighthood existed even before the Crusades. It was founded under the name of the Hospitallers of St. John of Jerusalem back in the eleventh century. Like Freemasonry, it likes to promote itself as a charitable organization. Nevertheless, the Order has a political and military side to it, and it is a supreme powerbroker.

When the Turks invaded the Holy Land the Order of Malta became a military unit to defend Jerusalem and preserve it and its holy cities ostensibly for Christianity. Its own literature describes its historical roots: "When Jerusalem was lost, they (the Knights) moved to Acre. A century later, when the city also fell to the Moslems, they moved to Cyprus were given the island of Rhodes by the Holy Father and they held it for many centuries against the Moslem invaders. Ultimately, the expansion of Islam drove them from Rhodes, and they were given the care of the island of Malta which they governed as a sovereign state for 300 years until, in 1798, Napoleon forced them to surrender the

island."

Its later history claims: "After the loss of Malta, the Knights wandered from place to place until 1834 when Pope Leo XII established the Headquarters of the Order in Rome...The Grand Masters of the Order continue to enjoy the rights of a head of state, as the Sovereign Military Order of Malta has a place in the world of diplomacy and statecraft. Today more than 40 countries recognize the sovereignty of the Order of Malta and maintain full diplomatic relations with it. In addition, there are official delegates of the Order to various states and international organizations. The Holy See and a number of nations have been and are recognizing the Order of Malta as a sovereignty, in as much as it enjoys prerogatives which according to principles of international law, are proper to sovereignty."

Clearly, this "charitable" Catholic order is a government itself. And this government answers only to the pope. The pope who legitimized it, Leo XII (1821-1829) condemned all religious freedom, tolerance, Bible societies and Bible translations; and declared that "Everyone separated from the Roman Catholic Church, however unblameable in other respects, has no part in eternal life."<sup>1</sup> The current Pope, John Paul, holds exactly the same perspective. The international head of the Order, the Grand Master, is elected for life. By Papal Decree and by virtue of his office, he has the rank of Prince, the precedence of a Cardinal, and the title Most Eminent Highness.

SMOM appears to have ties to monarchs and powerful, wealthy aristocratic families mainly in Europe. Its politics appears to be far-right. It has clear bonds to the C.I.A.

SMOM has chosen to honor some dastardly individuals. In 1948, the Order issued one of its most prestigious awards of honor, The Gran Croci al Merito Con Placa, to General Reinhard Gehlen. He was Adolph Hitler's anti-Soviet spy. Following the war, Gehlen found a home with the C.I.A. (so too did other Nazi war criminals). American industrialist, J. Peter Grace, once the American head of SMOM, personally intervened to get Nazis out of Europe and into America.

Grace used his influence to have Nazi war criminals' prison sentences reduced. Nazi Otto Ambros who ran a plant within Auschwitz, used over 100,000 hapless Jewish prisoners as laborers. Though he was found guilty at Nuremberg for his part in war crimes, Ambros found employment with Grace. Also, the son of a high-ranking Nazi, Friedrich Karl Flick, a key financial supporter of Hitler, was also tried at Nuremberg and found guilty of abetting the Nazi cause. Yet, Peter Grace brought Flick's son to America and put him on the Grace payroll.

Social historian Stephen Birmingham has said of them: "The Knights of Malta comprise what is perhaps the most exclusive club on earth. They are more than the Catholic aristocracy...[they] can pick up a telephone and chat with the pope." Research by Betty Mills indicates that "In the 1930s, there was a military pact to seize the White House. John J. Raskob, a member of the Knights of Malta, was implicated in this...An attempt was made to have Marine General Smedley Butler take a lead in this plan."<sup>2</sup> Instead, Butler secured damaging evidence against the SMOM plot to seize the White House. He exposed the plan. John J. Raskob, one of the thirteen founding members of the U.S. branch of SMOM and board chairman of General Motors, was implicated in the coup attempt.

Congressional hearings were

held on the plot, but SMOM kingpin Raskob was never called to testify. "It is interesting and at the same time very disturbing to note that the 1930s plot to seize the White House is not to be found in history books or encyclopedias as far as we can tell,"<sup>3</sup> writes Betty Mills.

The SMOM enjoys such power and connection to other secret societies throughout the world that it can exert tremendous impact on global affairs. Though somewhat puzzling, SMOM combines powerful resources with other shadowy, covert organizations to complete an objective. For example, one or two covert groups might want to accomplish a clandestine operation. To do it successfully, it might appeal to another group(s) for assistance. When this happens, an ill-assorted consortium will work together even though they might be at odds philosophically, religiously, or financially.

In the November-December 1990 *Trumpet*, the foundation for a case existing between the Priore de Sion and John Paul II was made. Despite Malachi Martin's statement that the Priore is a myth--that it does not exist, we believe it does and is, in fact, working in unison with the Vatican of John Paul II. In *The Messianic Legacy*, the authors write of the manner in which secret organizations come together, pool resources then quietly dismantle efforts and return to autonomy. The authors write: "Nevertheless, it had become increasingly clear that the Priore de Sion did have interests, and did conduct activities, in a somewhat murky sphere - a sphere where Christian Democratic parties of Europe, various movements dedicated to European unity, royalist cliques, neo-chivalric orders, freemasonic sects, the CIA, the Knights of Malta and the Vatican swirled together, pooled themselves temporarily for one or another specific purpose, then disengaged again"<sup>4</sup> (emphases in the original).

These alliances of conveniences operate on many fronts through high finance, international conglomerates, intelligence networks, education, religion, media, military, politics, various think-tanks. Cross fertilization of individuals and groups occur. For example, Knight of Malta, William Buckley, is also a member of the Council on Foreign Relations. Another Knight, Frank Shakespeare, a U.S. Ambassador to the Vatican, was also President of CBS Television Services and Vice Chairman of RKO General. Shakespeare joined ultra-rightist Paul Weyrich when the former became Chairman of the Board of Trustees of Weyrich's Heritage Foundation. Incidentally, Weyrich has traveled to Moscow to help the Soviets establish a "democratic" system of government. The Heritage group also brought Karl Von Hapsburg to America as a speaker. The Hapsburg dynasty is the primary force behind the Pan European Movement.

Other past and present members of SMOM are: Lee Iacocca, Greek shipping magnate, Spyros Skouras, Nixon friend, Robert Abppplanalp, Barron Hilton, John Volpe, William Simon, former treasury secretary, Alexander Haig, William Buckley, Bennett Williams; attorney for the rich and famous, and William Casey.

Is today's SMOM, the neo-Templar organization, aiding Pope John Paul II in his quest to extend Europe's boundaries, and to become the major player in the new world order? Yes.

Two CIA Directors have been Knights of Malta. For example, John McCone, William Casey held membership in SMOM as did George Rocca former deputy chief of CIA counter-intelligence. More than adequate information exists to link the SMOM, the ultra-right wing, the Vatican and the CIA to the Iran Contra Affair. Behind what was made to

appear as an anti-communist effort in Central America, was another plot. Evidence from the hearings clearly indicated that a shadowy government within the U.S. government was in operation. Exactly what it was attempting to accomplish remains murky.

Perhaps members of SMOM working in alliance with other covert organizations in the world were attempting another coup of the White House similar to that in the 1930s. The goal? Chaos. The result? A Vatican-inspired revolution within the United States that would eventually force the President to enact the Federal Emergency Management Agency (FEMA) and begin martial law. Important pieces of information that surfaced during the Contra hearings was Col. Oliver North's involvement in FEMA. Incidentally, North's attorney, Brendon Sullivan, is part of Knight of Malta, Bennett Williams' firm.

The Sovereign Military Order of the Knights of Malta comprise an elite of unprecedented power on a global scale. They can depose world leaders and entire governments at will. This gives them an unharnessed power to shape and create a prototype world government. The major problem is that the SMOM is totally loyal to the pope. Therefore, it would be his form of government they would be implementing.

Footnotes: 1. Henry H. Halley, *Halley's Bible Handbook*, (Zondervan Publishing, Grand Rapids, 196), p. 781. 2. Betty Mills, *Col. North, Wm. Casey, and The Knights of Malta*, (Private Printing 1990), p. 4. 3. *Ibid.*, Mills, p. 5. 4. Michael Baigent et al., *The Messianic Legacy*, (Henry Holt Co, 1986), p. 272.

# NEW EUROPE \* IN THE NEW WORLD ORDER

Without ourselves accepting questionable suppositions presented in *The Messianic Legacy* (Jonathan Cape, 1986), it is apparent that the authors, Michael Baigent, Richard Leigh and Henry Lincoln have uncovered evidence which, as they claim, 'draws their readers into the murky underworld of contemporary European and American affairs, where politics, high finance, freemasonry, secret societies and various intelligence agencies meet and conduct their clandestine transactions.' We are driven to conclude that *only against such a backdrop can Margaret Thatcher's political assassination be seen in context!*

In earlier research for a work entitled *The Holy Blood and the Holy Grail* (Jonathan Cape, 1982), the authors traced the existence of a chivalric Order known as the Prieure de Sion, founded in 1090 or 1099, which had preserved its lineal connection – sometimes through facades or other organizations – down to the present. They closely monitored its activities during and since the Second World War. It transpired that a key policy aim was a United States of Europe. This aim was shared by a strange assortment of societies and individuals, such as Pan Europa, directed latterly by Dr. Otto von Hapsburg; Alpha Galates, a species of secret society functioning under the public guise of an esoteric neochivalric Order; Helmut James von Moltke's Kreisau Circle which, according to G. van Roon, was based on a fundamental belief in a European federal state. Count Richard Coudenhove-Kalergi's prestigious Pan European Union, founded in 1922, had attracted the support of such political figures as Leon Blum in France, Eduard Benes in Czechoslovakia, Winston Churchill, and writers like George Bernard Shaw and Thomas Mann. Driven out of Austria by the German *Anschluss* of 1938, Coudenhove-Kalergi emigrated to the U.S. in 1940. There he lobbied tirelessly for his Pan European concept, insisting that European unity must be a priority of American policy after the war. When America entered the war, he influenced the blue-prints for post-war policy already being devised.

By 1943 Coudenhove-Kalergi had established close links with Allen Dulles, Head of Section, Switzerland, of the Office of Strategic Studies (OSS), which had been created with the aid of the UK's MI6 and Special Operations Executive (SOE). The

\* Courtesy Jack Hornsby, member, Committee to Restore the Constitution, CHD Associates, 4d Church Road, Tweedmouth, Berwick-upon-Tweed TD 15 2AJ Scotland.

OSS was the precursor of the Central Intelligence Agency (CIA).

Of other elements contributing to the long-term federal aim was a splinter group from the Sovereign and Military Order of the Temple of Jerusalem, led by one Anton Zapelli, who drew support from the Swiss Grand Lodge Alpina. Two themes emerged as being of their paramount concern: (a) Banking and international finance, and (b) A United Europe and the role of modern Templars in such a unification. It was argued that the original Templars had such an aim. Zapelli appeared to function in a twilight region, where secret societies link with high finance and Pan-European politics.

As is fully documented elsewhere, a prominent functionary since the 20s in the movement towards a federal Europe was the enigmatic Pole, Joseph Retinger. Said to be a compulsive intriguer and political wheeler-dealer, even his closest associates regarded him as a 'grey eminence'. He helped to organize the Hague Congress of Europe in May, 1948, in July of that year travelling with Winston Churchill, Duncan Sandys and former Belgian Prime Minister Paul-Henri Spaak to elicit US support for the self styled European Movement. The outcome – the launching on 29th March, 1949, during a luncheon in honour of Winston Churchill, of the American Committee on a United Europe (ACUE).

ACUE's chairman was William Donovan, ex-director of OSS, its vice-chairman Allen Dulles. The secretary, George S. Franklin, was a director of the Council on Foreign Relations (CFR) and subsequently a coordinator of the Trilateral Commission (TC). The CFR is the companion body of the Royal Institute of International Affairs (RIIA). For an insight into the overwhelming presence of CFR members in the US Administration and centres of influence, RIIA influence in the UK governmental policy is less evident, but was conspicuous in the engineering of Margaret Thatcher's downfall and has been subsequently.

ACUE's executive director was Thomas Braden of the CIA's 'Department of Dirty Tricks'. Under the auspices of these officials, the ACUE underwrote Joseph Retinger's European Movement. Funds from American State Department sources were discreetly filtered to Retinger's Brussels headquarters. The May 23-29, 1975 issue of *Time Out* carried this disclosure under the heading 'Uncle Sam Goes To Market', the secret funding having come to light through the discovery of an

obscure Oxford doctoral thesis written by one F. Rabattet, son of a former Secretary General of the European Movement, who had access to its secret archives.

Partially financed by the CIA, Joseph Retinger and associates forged ties with Prince Bernard of the Netherlands, Italian Prime Minister Alcide de Gasperi, and Sir Colin Gubbins, former director of the UK's SOE. Together with the then director of the CIA, General Walter Bedall Smith, the group created a 'think tank' which met for the first time in 1954 at the Hotel de Bilderberg in the Dutch town of Oosterbeek. Thus arose the Bilderberg Conferences, held annually, usually in exotic venues, as far as possible kept impenetrable to the world's media. According to the Strictly Confidential minutes of the first gathering, 'attention was paid ... to *evolving an international order* which would look beyond the present day crisis.

Perceptively, the authors of *The Messianic Legacy* conclude that 'the seeds were thus sown for the growth of a shadowy subterranean sub-culture in which secret and semi-secret societies – religious, political and financial – would soon begin to flourish. By the late 50s, this subculture had assumed a momentum of its own, comprising a milieu which, although invisible to the outsider, began to exercise a more and more pervasive influence. When therefore, the American journal *The Spotlight* reported in its May 20, 1989 issue that the Bilderberg Group, meeting earlier that month on the island of LaToja off the Atlantic coast of Spain, had plotted the political assassination of Margaret Thatcher 'because of her refusal to yield British sovereignty to the European superstate that is to emerge in 1992,' the intended manipulation of Britain's supposedly democratic processes is entirely consistent with the foregoing conspiratorial – rather than 'cock up' – theme. As *The Spotlight* observers have long detected, a European superstate, with no trade barriers among the western European nations and a common currency, has been on the Bilderberg agenda for years, being 'viewed as a major step towards their goal of a world government and creates a favourable climate for huge banks to consume small ones and huge international conglomerates to absorb small firms.'

Confirmation of this retrogressive purpose has come from within the financial inner circle. Jacques Attali, French socialist, one time close aide to President Francois Mitterrand and intimate friend of Giscard d'Estaing and, like them, a member of the Bilderberg Group, is credited with having shaped the agenda of summits

*Communiqué*

80 SIGNS OF THE GODS?

But should mankind be faced by such catastrophes for the first time, cloning could not be discovered and tried out *ad hoc*. Therefore the process should be immediately usable and tested in advance.

Cloning would not simply produce uniform types in a single large brood. Even though created after a pattern, there would be individuals, like their fellowmen produced *in vivo* in the tried and true tradition. They would resemble each other externally, they would also have the layout of the cell nucleus, but they would think and act independently, and like us they would be formed by upbringing and environment. The cloned men would receive new hereditary information and hand it on to a new generation. They would mutate and after a dozen generations the clones would no longer look as alike as peas.

Cloning is vital to our very existence in case of catastrophe, but it is also essential for the conquest of space. So I think the physiologist Lord Rothschild is right when he advocates the establishment of an international 'Commission for Genetic Control', so that research and practice keep in step. It is most devoutly to be wished that such a commission will be more effective than international organisations have been up to the present.

The German word for life (*Leben*) spelt backwards means fog or mist (*Nebel*). We should raise the mystical veil of mist with caution so that we can comprehend the reality of our existence.

The intelligent robot is on the way!

It will think independently and have an intelligence quotient far exceeding man's. It will be equipped with sensors which 'see' better than the human eye, for they will also see in the infrared and ultraviolet range. It will 'feel' more intensely, because its sensors function more sensitively than the human tactile sense. Its feelers—supersonic waves, radar, X rays—will 'feel' through walls.

The American scientist Marvin Minsky of the Massachusetts Institute of Technology, Boston, says:

'The machine will be able to tell a joke and win a boxing match. Once this stage is reached, the machine will develop at fantastic speed. In a few months it will reach the intelligence level of a genius and a few months later its power will be incalculable.'

Dr George Lawrence, scientific director at the Stanford Research Institute, California, has already linked human brains in direct contact with computers. The power of thought alone is sufficient to give the computers orders. The body which commissioned this Utopian-sounding series of experiments was the Pentagon!

The branch of research in the USA which has set itself the goal of creating an intelligent robot is called AI (Artificial Intelligence). The ultimate target is a robot which can carry out civil, military and scientific tasks in space and the depths of the sea quite independently.

Did intelligent robots exist in antiquity? The Sumerologist S. N. Kramer translated this passage from a cuneiform tablet:

'Those who accompanied the Goddess Inanna were beings who know no food, who know no water; they eat no scattered meal, they drink no sacrificial water . . .'

In the Sumerian Epic of Gilgamesh, Enkidu describes the guardian of the precinct of the gods:

'Not until I have slain this man, if he be a man, not until I have killed this god, if he be a god, will I direct my steps to the city . . . O Lord, who hast not seen this thing . . . thou art not stricken with horror, I, who have seen this thing, am stricken with horror. His teeth are like dragons' teeth, his face is like a lion's face . . .'

Sources: United Press International—S. N. Kramer, *History Begins at Sumer*, London, 1958—James Pritchard, *Ancient Near Eastern Texts*, Princeton, 1950.

U  
S  
S  
R

M  
A  
T  
R  
I  
X  
I  
I  
I

M A T R I X I I I

RICHARD L. CLARK, PH.D.

CONSULTANT - SYSTEMS ENGINEER

4482½ BOND STREET

SAN DIEGO, CALIFORNIA 92109

714/274-0196

EARTH ENERGIES: CATHIE GRID AND LEY LINES

The writings of Cathie and Jalandris cover the same earth energy grid system. Jalandris has researched in depth the ancient systems and their markers/monuments. Cathie has researched the current reactivation and utility of this same grid system. The earth energy grid that they are both discussing is a natural part of the earth itself and has probably been rediscovered numerous times over the ages and utilized by inhabitants of this planet. The power elites and secret brotherhoods of the world have had the knowledge of this natural earth energy grid continuously for at least the last 20,000 years. Therefore, the appearance, disappearance and reappearance of this earth grid and the associated phenomena connected with it are not unusual.

The most interesting commonality of this grid data, past or present, is that it always is tied to world conquest and domination. Everyone talks about common language, common law and supposedly utopian communal economic/social structure; no one, however, talks about the nature of the dictatorship which inevitably presides over this imagined "utopia" toward which the "enlightened" brotherhood and their earth grid technology are presently leading us. Once we are subjected to their mind-control technology, the way back to any freedom will be extremely hard or impossible. Beware of seemingly kind, idealistic, benevolent, liberal leaders who talk of "golden ages" to cover their true purpose of enslavement. A fool and his freedom are soon parted.

Heading the brotherhood propaganda of pure agape, higher planes of existence, etc., makes a real researcher wonder. For, if one reads Joseph Campbell, Robert Graves, Claude Levi-Strauss, Erich Neumann, etc., covering these same belief/practice systems, it turns out that they are far from the universal love-ocracy presented. In fact, the inverse or Reciprocal System applies again!

The wonders possible in New Age technology are very real. However, advanced technology and understanding of the universe do not automatically carry with them social or political enlightenment. Wise men and fools can and do operate in the same universe and use the same knowledge. An advanced technology is not a parameter of being good, kind, or free. Blind, unsupported belief that advanced technology is a sign of the pure and good can be and usually is fatal to freedom. To quote Bertrand Russell, "People would rather die than think, and usually do."

The present reactivation of the earth grid system seems to be tied to both Alternative 3s. Watkins' research on the Mars colony indicates that it is a retreat for the elite in case the earth's power grid does not make it up to stabilizing power by the pole shift event expected around May 5, 2000. The earth's energy grid has to increase from the present level of about ½ Gauss to over 4 Gauss by then or the earth gets the full effects of a pole shift. So, the planned takeover of the world by deceptions of the UFO "Masters of Kindness and Wisdom" locks directly into building a safe retreat on Mars to cover the possibility of failure.

The technology and work force are the same on both projects. The big benefit to the elite work force is their access to the rejuvenation and crystal hallucinogenic Scalar Wave devices. These devices are copies of the King's Chamber in the Great Pyramid at Giza. Staying young and talking to the "gods" are important employee benefits. Faust is being played out with a cast of thousands.

My permission is hereby given to anyone to publish or copy the above data.

*Richard L. Clark, Ph.D.*

*10 Mar 82*

Richard L. Clark, Ph.D.  
March 10, 1982

# M A T R I X I I I

Northwest Garabandal Center; P.O. Box 529; Tacoma, WA 98401

## CHRONICLE OF JUDAS MACABEE

Taken from "Introibo", July 1966, No.13. (Tr.: M. Evans)

We will deal mainly with the sensational news received from Rome. It must be quite credible, since Archbishop LeFebvre has dared to speak of it. The famous Fr. Bugnini, expelled from his liturgical seat in Rome by His Holiness John XXIII, and finally becoming, under Paul VI, the great chief destroyer of liturgy, was and still is a Mason!

As stated in the "Supplemen Voltigeur" (seperata) No. 38 of ITINERAIRES: "At the Vatican, up to 1975, the most influential person was a Mason!" The well-known Italian author, Tito CASINI, on page 150 of his book "Nel Fumo di Satana", published in Florence April, 1976, writes without fear of contradiction, for he has proof: "The reform has been carried out by this Bugnini who, finally, has been unmasked. He is what we suspected: A Mason."

Observe with Archbishop LeFebvre: "There is no doubt that the veil covering the greatest deceit ever of clergy and the faithful, begins to tear."

It is true that Cardinal Villot also belongs to the same sect. For years we have known that specialists, well established in Rome - such as Mr. de la Franquerie - affirmed this real invasion of the Masonic sect among the Bishops and in the Vatican. We had been very reserved about this - we lacked proof to make such terrible affirmations. These proofs come to us little by little.\* In the meantime, it is enough for good Catholics - as skeptical as we were - to refer to the words of Jesus: "By their fruits ye shall know them". As has been demonstrated by Archbishop Lefebvre in his letters numbers 9 & 10, that for the past thirteen years the revolution in the Church has been carried out exactly according to the plans outlined by the Masons, published some sixty years ago.

In 1976, God has allowed the discovery of the Masonic affiliations of high dignitaries of the Vatican. Following are some of them:

- Cardinal Jean Villot: Secretary of State, Joined August 6, 1966
- Card. Leo Suenens: Primate of Belgium, joined June 15, 1967.
- Card. Ugo Poletti: The Pope's Vicar for Rome: Feb. 17, 1969.
- Card. A. Lienard: Was initiated into Masonry in 1912, at Cambrai. He dealt with three lodges at Lille, and one in Valenciennes; later on with two others in Paris, reserved for members of Parliament. In 1919, he was appointed Third Grade Visitor; in 1924, 30<sup>o</sup> Apprentice, 7th Class. On his deathbed he exclaimed: "Humanly, the Church is lost." ("Tradition-Information" No.7, page 21.)
- Archbishop A. Casaroli: Pope's Ambassador, responsible for the opening to the East (and the scandalous removal of Card. Mindzenty), affiliated on September 28, 1957.
- Card. S. Baggio (taken by some as the future Pope): Joined August 14, 1957
- Msgr. Pasquale Macchi: Private Secretary to the Pope, affiliated April 23, 1958
- Archbishop A. Bugnini: Destroyer in Chief of the liturgy, joined on April 23, 1963.
- Virgilio Noe: Secretary to C1 KNOX, Congregation of the Rites, Joined April 3, 1961.
- Msgr. Virgilio (Levi) Lovino: Responsible for Vatican Radio, affiliated July 4, 1950

M A T R I X I I I

5 September 1985

I have finished reading Dr. Sutton's The Secret Cult of THE ORDER and I have some findings that you may be interested in pertaining to the possible origin of the senior year society at Yale called Skull & Bones. Dr. Sutton writes that "The Order had its origins at Yale in 1833, but Skull & Bones is a chapter of a German secret society. It was introduced into the United States by William Russell ... who brought a chapter back from his student days in Germany" (p. 40). I think this rumor was started a long time ago for disinformation purposes. Allow me to state a theory supported by evidence.

Financial, political, and intellectual forces (The Order) created and/or subsidized a secret, fraternal, senior year society called Phi Beta Kappa at Yale and several other American colleges during the American Revolutionary War.

Phi Beta Kappa's purpose was twofold, function as a "think tank" and "recruitment cell" for the elite.

The Order withdrew its direct involvement in Phi Beta Kappa before 1833 because of a public scandal disclosing Phi Beta Kappa's Masonic "secrets" and ties to Freemasonry.

The Order already present in America since the American Revolution established another "think tank, recruitment cell" under tighter security at Yale College called Skull & Bones, a small carbon copy of what Phi Beta Kappa had been prior to 1833.

From The History of Phi Beta Kappa by Oscar M. Voorhees, official Phi Beta Kappa historian and member, we summarize some of the following: (Incidentally this book was published in 1945 and is the first written history of Phi Beta Kappa. Voorhees took fifteen years to write it.)

Harvard was founded in 1636; College of William and Mary (1693); and Yale (1701). Phi Beta Kappa was established 5 December 1776 at College of William and Mary. In 1750 during the Revolutionary War a Phi Beta Kappa chapter called an "Alpha" was established at Yale College and then another "Alpha" was established at Harvard in 1781. Phi Beta Kappa had a secret, Masonic ritual; was associated with many of the most prominent men in the country at that time, and was a "senior year society."



## M A T R I X I I I

In 1782 because of the war, Phi Beta Kappa's existence in Virginia at College of William and Mary ended and Phi Beta Kappa became exclusively a New England institution at Yale and Harvard. It was the only society in early American education with branches in several colleges, bound together by a common name, common insignia, common purposes; and the institution had a special affinity for meeting on Thursdays.

The Phi Beta Kappa chapter at Yale proposed the dissolution of the Society after the republication in 1799 of a book published two years before in Scotland called Proofs of a Conspiracy Against All the Religions and Governments of Europe Carried on in the Secret Meetings of Freemasons, Illuminati, and Reading Societies by John Robison. The reason given was that some members were convinced "that secret societies have been improved as engines of intrigue and iniquity; and considering the time, place, and circumstances which gave birth to this Society, and the probable designs of its institution which are deducible from the import of its initial letters; ... they were apprehensive that this Society, tho at present harmless, is liable to be abused to the infidel and seditious purpose of other secret associations."<sup>1</sup> (Emphasis by underscore theirs). How many members joined in this action is not known but probably few because Phi Beta Kappa functioned as a secret "reading society" for another twenty-five years.

An Antimasonic political party made its appearance in 1827 and was active in all of the New England states for ten years. It was the outgrowth of the "Morgan affair" in 1826. William Morgan was thought to be murdered by some men who were Masons because Morgan published a book which was said to reveal the secrets of Freemasonry. The Masonic fraternity suffered severely from the public outcry against this incident, and so fierce was the sentiment on both sides that in New York, New England, Pennsylvania, Ohio and Michigan political parties, church congregations, families, and friends were divided on the issue. The result was, that during the next few years hundreds of Masonic Lodge warrants were surrendered. The Antimasonic party ran a candidate, William Wirt, for President in 1832 and won seven electoral votes.

In 1831 there occurred a Masonic-Phi Beta Kappa scandal (See enclosure "Phi Beta Kappa and Secrecy"). At this time Phi Beta Kappa renounced all of the oaths of secrecy required of its members and adopted an amendment that new members be elected by a two-thirds vote. In short Phi Beta Kappa ceased to be a secret society by 1832.

Thus in 1832 in the midst of Antimasonic furor in American politics and after the public exposure of Phi Beta Kappa's "secrets"--begins the quiet existence of Skull & Bones; a secret senior year society existing exclusively at Yale, S & B a miniture of what Phi Beta Kappa was prior to 1832.

<sup>1</sup>Voorhees, p. 64.

M A T R I X I I I

The theory that Skull & Bones evolved out of a Masonic-Phi Beta Kappa scandal, in fact, is alluded to in a reprint from an article in The Secret Cult of THE ORDER, page 88, "Four Years at Yale," published in 1871:

"Some injustice in the conferring of Phi Beta Kappa elections seems to have led to its (Skull & Bones) establishment"

Also read what The Royal Masonic Cyclopedia published in 1877 has to say about Phi Beta Kappa (See enclosure).

Consider that Phi ( $\Phi$ ) is the 21st letter in the Greek alphabet, Beta ( $\beta$ ) is the 2nd, and Kappa ( $\kappa$ ) is the 10th. The letters are the initials of three Greek words whose English translation is "Philosophy is the governess, rule, or guide of life." If someone wanted to disguise the Greek letters into a code they might have set Phi=21, Beta=2, Kappa=10 leaving the numbers 21,2,10. If they added Phi's 2 and 1 to equal 3, and Kappa's 1+0=1 that leaves the numbers 3,2,1 or 321. Was 321 a code numeral for Phi Beta Kappa? Was Skull & Bones then designated 322?

In looking at the family tree chart of secret societies from Albert Stevens' Cyclopedia of Fraternities published in 1907 (copy enclosed), it indicates that out of "Various Occult Societies and Philosophical Brotherhoods [Europe]." evolved Phi Beta Kappa, 1776.

We don't need to look toward Germany for the origin of Skull & Bones in 1832, but perhaps we should look eastward for the origin of Phi Beta Kappa in 1776.

On a somewhat related topic, would you be interested in documentary evidence that links Edith Starr Miller (Lady Queenborough, authoress of Occult Theocracy) with Yale graduates and Skull & Bones members Payne Whitney and Harry Payne Whitney; financiers, Knickerbocker Trust Co., and Guaranty Trust Co.? Reply and I'll forward the material.

Edith Miller's much researched and large but little understood book was published posthumously in 1933. Her social circle touched "bonesmen" and I believe she reproduced some relatively modern documents regarding The Order in her book, see page 677, appendix 1, Occult Theocracy.

Also it states on page 117 of The Secret Cult of THE ORDER that "Among the many Bones men worthy of mention: ... Chauncey M. Depew, N.Y. secretary of State". Chauncey M. Depew is also mentioned on page 11 of my previously submitted manuscript entitled "A Little Masonic History Book: The One Dollar Bill." Bones men sure do get around.

Best,

and regards,

I am sincerely,

M A T R I X I I I

Order of Saint John of Jerusalem  
Knights Hospitaller

Jerusalem 1048-1291. Cyprus 1292-1310. Rhodes 1310-1523. Malta 1530-1798. Russia 1798-1907. Grand Priory of America 1908.

Grand Priory of America

Chancery, 21st July, 1984.

---

Thank you for your letter of the 17th July, 1984, and its enquiry about the Order. For your information I am enclosing a recent article concerning the OSJ printed in AXIOS, the Orthodox Church Journal. It will give a good brief history of the Order.

The other enclosed items will also give a sense of the level at which the OSJ operates to-day and its public purposes.

The Order has nothing whatsoever to do with Masonry, either in the USA or in Europe. In fact, membership in the European Masonic Lodges is an absolute disqualification for membership in the OSJ. American Masonic Lodges are not considered seriously and therefore membership in one of them is not a disqualification for membership in the Order's Grand Priory of America.

The Order considers the Knights Templar organisation associated with Freemasonry to be merely a commemorative group and not a continuation of the Order of the Temple of Jerusalem. However, the genuine Knights Templar continue in existence and are validly chivalric Knights. They to-day exist in two genuine branches, one headquartered in Portugal and one in Spain. (The Templars owing allegiance to the Portuguese Grand Master also have a Swiss-based affiliated group of Autonomous Priories.) The Grand Master of the Portuguese-based Templar Order is Count de Fuentes; the Grand Master of the Spanish Templar Order is Prince William III de Grau-Moctezuma, Pretender to the Aztec Throne of Mexico.

Post Office Box 22946  Houston, Texas 77227

Under the Canonical Protection of The Orthodox Church in America  
Under Royal Charter of His Majesty King Peter 33

0689

M A T R I X I I I

Prince John de Batemberg is Grand Chancellor of our Order and also Grand Prior of the Grand Priory of America (which has jurisdiction over all the Americas and the Caribbean areas). He is a Bailiff Grand Cross of Justice of the Order. (A Bailiff is a title of nobility within the Order as established by the Congress of Vienna and the status is somewhat analogous to that of a Cardinal of the Roman Catholic Church. A Grand Cross is the highest grade of the Order, having two sections: the Bailiffs who are ex officio Grand Crosses and the Knights Grand Cross. Below them in rank and grade are the Knights Commander followed by the Knights - and Dames - of the Order. Persons enter the Order as Members and are later promoted to be Companions in which grade they remain until created Knights or Dames Hospitaller of St. John.)

Prince de Batemberg is also a Knight of several other Orders of Chivalry, including being a Knight Grand Cross of the Supreme Order of the Temple of Jerusalem (Spanish). The Order of St. John has friendly fraternal relations with the Order of the Temple.

The OSJ recognises as genuine St. John orders only itself and the following orders of similar name and title: The Venerable Order of St. John under the British Crown; the Papal Order of Malta; and the German Order of St. John with its now independent branches, the Dutch and the Swedish Orders of St. John. We consider all other organisations using the name and title of St. John and claiming to be a knightly order as false or at best dubious.

The OSJ has an interest in all orders and fraternal organisations interationally and in politically active groups, regardless of ideology or purpose. The World Power Foundation is one of the groups in which we have an interest. Such interest does not necessarily mean that the Order supports or approves, of course.

We would be interested also in learning more about yourself and the associations you indicate for yourself with occult organisations, possibly those deriving from the Order of the Golden Dawn, etc.

With every good wish, I am,

Faithfully yours,



*Shannon A. Clark*  
Shannon A. Clark, KMStJ  
Secretary-General, G.P.A.

# M A T R I X I I I

## Chapter 10

### PATHWAYS TO HIGHER CONSCIOUSNESS

Hopefully, you read the material in Chapter 8 quite closely, for therein lies the key to much understanding about the dualistic nature of the planetary situation; it should enable you to engage the rest of the book, and perhaps Matrix II, in an entirely new way. Now, with all this behind us, as it were, comes the moment to discuss some basic issues of how to work on non-dualistic states of consciousness.

There are clues to the interrelationships between the factors of consciousness, energy, and matter strategically placed in this book - to address such matters to people who may be steeped in social consciousness is not easy - one must be quite creative, as humans are, by nature, a "tough nut to crack".

There are many human disciplines which address the issue of non-dual consciousness. Research indicates that many of these disciplines have three essential factors in common:

Factor 1 (F1): Active Attention is the primary factor. It consists of *intense yet relaxed alertness*, coupled with *total acceptance of what is happening in the present (NOW)* and the *total acceptance of any tendencies which arise within your consciousness*. Imagine sitting with the light blocked out from your eyes and no sound around you, if you will, and mentally address the Void around you, saying "Speak, I am listening", and simply be attentive. In Vendanta Hinduism, this is also spoken as "Who am I?" or "To Whom Have These Thoughts Occurred?" In the Zen discipline, it is accomplished by the use of the KOAN ("What is the sound of one hand clapping?"), sometimes called the Great Attention, functionally an inquiry into the Source of Thought. In Tien Tai, it is represented by the factor of *active inward attention*. Perhaps the most viable expression of (F1) is in the Taoist sense through the concept of Wu-Wei, essentially a state where there is no volitional activity at all, a state of letting the mind absolutely alone, totally authorizing all of the tendencies of the mind in an impartial and non-judgmental way, allowing thoughts to flow by as clouds in the sky, with no intention present. If properly performed, Factor 1 leads automatically to:

Factor 2 (F2): Stopping, which is a state where mental chatter (represented by the "personal ego", which is inclined to chatter, without control, purely for the sake of communicating and attracting attention to your personal image) comes to a halt. Visual image formation also ceases. In Vendanta, it is a state of mental introversion where objective perception ceases to exist. In Zen, it is seen as a state of consciousness that is functionally a state of oneness, called the Great Fixation, where there is no thought received by the brain. In Tien Tai,

## M A T R I X I I I

it is seen as a state where conceptualization ceases. Taoist discipline calls it a state of Fasting of the Mind, where there is no thought or mental activity. This state leads to:

Factor 3 (F3) Passive Awareness, a state of consciousness where you are, in essence, "seeing into Nothingness" in a timeless NOW. At this point, the mind is in a process of non-dual awareness; it is referred to as the "I-I" in Vendanta terminology, the state of Prajna in Zen, Kuan in Tien Tai, and the Great Tao.

From this information, and perhaps your own experience, you will quickly realize that:

- (1) Thought is one of the root causes of dualism.
- (2) In-attention builds images.

What? In-attention builds images? The state of active attention is a state of FOCUS. Think of the question in the beginning "Speak, I am listening". If you were to say that to a person, you would have a focus, waiting attentively for a reply. It is that same state, represented by continuous FOCUS, that is Active Attention. When you manage to lose the FOCUS, it means you are, in essence, losing attention. When you do, images and thoughts pour forth.

### Truth

It appears that humans want to find the truth - that is what their constant search seems to be about, yet, what is truth? If you read something and gain knowledge of it, is that knowledge true? What does truth really mean? You want to learn the truth? Take the knowledge and theory that you have and undergo Experience, for through Experience actual learning occurs - Experience leads to Wisdom (which is non-dual in nature -neither "good" or "bad" - it simply IS). From the Wisdom, you gain your own personal truth. If you could gather up all the "personal truths" within the consciousness comprising the Universal Intelligent Matrix, THAT would comprise the TRUTH (with a capital "T") that humans are always looking for, but can never find within a consciousness steeped in dualism.

### I AM THAT I AM

If you earnestly pursue the process at the beginning of this chapter and take all the other knowledge in the book that has been provided, you will realize that:

- 1.No amount of looking in any direction will help you see WHO is looking. Perception, by its very nature, requires dualism. You can only perceive something by being separate from it. When you BECOME what you are perceiving, you can no longer perceive it, because you

## M A T R I X I I I

- are BEING it.
2. Whenever you *think* about something, you objectify it. You can only truly know something if you *become* it.
  3. The absence of your personal self, the Void, *is what is looking*. Humans anthropomorphically call this "God".
  4. You cannot perceive your Self. You can only Be it.
  5. You cannot see what you Become. (That's why everyone around you is a "mirror" to you. When you see something you "don't like" in someone, it is that portion of you that you are perceiving and rejecting, automatically projecting the perception off onto that person! If that portion was not within you, you would not be able to recognize it. No "thing" or event has any inherent meaning except the meaning you assign to it. STOP PROJECTING. When you feel that something "out there" is AFFECTING you, you are projecting!
  6. You can experience union with your Self/God/Void only by Being it. What is it? It simply "IS". In the Bible reference is made to "I AM THAT I AM" - that is WHO you are! Everything and Nothing.
  7. Nothing and no-one "belongs" to you. If you want someone to "be something", that reflects your lack.
  8. Concentration cannot be a permanent condition, but only a transition between the projected world and Being.

### Phases of Concentration

Intellectual Phase: Thoughts are directed to the object of concentration to consider what the object really "is". The thoughts are the bridge between ignorance and knowledge.

Feeling Phase: Consciousness projects outwardly through the nervous system all the characteristics of the object of your concentration so that you feel it.

Being Phase: You become identical with the object. You become it in consciousness. Complete concentration results in being the object of concentration, which means that you will no longer be able to perceive it any more because you are it.

9. It appears that the more "in tune" you are, the more you notice the "coincidence" or synchronicity that is always there. A good example of synchronicity would be that you are riding down the road reading a book about alligators and you look up and notice a shop that sells alligator handbags, or you are talking to someone and

## M A T R I X I I I

a nearby radio announcer says what you just said. The main significance of synchronicity (think back to the chapter on holography) is that it tells you that everything in the universe is part of ONE thing, and that the ONE thing simply "IS". Synchronicity is the conscious perception in a physiological time-track spacial reality structure of the simultaneous manifestation of the multi-dimensional existence of the ONE. All events, objects, relationships, points of view, perceptions, and interactions are different parts/perspectives of ONE. Because of the inter-connectedness of all points in the universe, nothing happens "by accident". Look around you and notice how well orchestrated everything is. Put in another way, everything is ONE EVENT experienced from different points of view. Conscious recognition of the synchronicity around you means that you are in harmonic resonance with what is around you and you can act on the opportunities it brings.

10. Mind is a product of the physical material world, and is created out of the multiple orders of electromagnetic field when consciousness intersects with those fields.

11. Consciousness exists apart from mentality, which is created by consciousness. Consciousness is represented in physical realities by its generative reflection as mentality.

12. Consciousness does not really "move around". What you perceive moves around you. Everything is just a "point of view".

13. Doubt is a 100% trust in a negative reality.

14. Anxiety is excitement with judgment applied to it.

15. Accuracy is a judgment that there is one truth against which everything else must be measured.

16. The Truth is composed of all truths, all of which are equally valid. You experience your truth.

17. Humans encounter beings and realities equal to the vibrational resonance at which the humans exist. Part of that resonance is genetically determined.

18. You ARE the path you must follow. The chosen path you are is to develop self-awareness and consciousness and choose what reality you will experience to fulfill the idea of what you are (which can be potentially anything).

19. What ARE you? You are a part of the IS. What does it mean BE this way? It means loving yourself without any judgment. You are never judged, for all you are is part of All That Is. You can only judge yourself while in



## M A T R I X I I I

separation from your Self.

20. The brain is a quantum-based amplification and receiving organ that provides an interface with this density for consciousness. It is an event-forming psycho-mechanism through which consciousness operates. It provides a connection with cellular and molecular time sequences that are coordinated with the time-track lock of the physical body, synchronizing them with the surrounding dimensionality.

21. Social consciousness encourages accumulation of knowledge which is not based on life and experience. It produced individuals who are of an impersonal nature, functioning through the lower structures of the brain.

22. If your attitude is based in social consciousness and your persona, you become the slaves of those who will manipulate you for their own purposes and you give up your self-empowerment.

23. The idea of going from density to density is in essence the process of realizing that you actually ARE the dimension itself you previously thought you existed IN; your consciousness ultimately has access to it all.

24. All beings reflect all the ways infinite creation has of looking at itself, of experiencing itself to be.

25. Victims are the worst tyrants. Tyranny is the active suppression of another under the guise and aims of the persona. The persona chooses its own victimization.

26. In social consciousness, the concept of "now" is based on the "past", which is a repeat of what is already known, so "now", in effect, becomes "future" based on "past". Is it any wonder that people in society depress themselves, because it means that "future" is failure. Conversely, people who live in the "past" are doomed to their "future". In the NOW there is no "past" or "future" as linear ideas. Everything in your life can be created NOW. Can you see the potentials that lie there? Can you contemplate these potentials? Contemplation leads to options for change, which leads to knowledge and subsequent experience, which leads in turn to wisdom and truth.

27. People cannot be in your life unless they reflect what you are. What does that tell you about what you are doing? Are you playing the "victim"? Are you feeling unworthy because you have to feel "hurt", to gain affection?

28. Whatever you live, you will create in reality.

## M A T R I X I I I

29. If you keep having the same kind of experiences, it is because you have not owned the wisdom in those experiences. Ask yourself, "what is the learning here"?

30. Most knowledge on the planet at this time is built upon fear and survival, which are the hallmark of people operating in the lower brain areas. It is also built on judgment and separation, as well as the tacit "understanding" that man is a "fallen" creature who has no divinity, thus leading to the process, through religion, of psychological projection of one's Self externally, calling it "God", subjecting oneself to a priesthood, and becoming totally disempowered as a being. Combine this with other psychosocial factors, and you basically have a planet populated with the "walking dead" who have no idea who they are. Any knowledge that is taught that reflects "laws" to control and limit human beings, or divides the ONENESS into "good" and "evil" aspects, is coming from human beings (or non-humans who wish to control humans) who have accepted that as being their personal truth and who are compelled to have the world revolve around that personal truth, and that personal truth becomes a reality to be experienced. Consciousness is without limitation, laws, judgment, and separation. You are your greatest teacher. There is not a "plan" for Life; a "plan" would remove your free will as a part of the Universal Intelligent Matrix. Why would the Matrix seek to remove the free will of parts of itself? The only "plan" is to BE and to be a part of creation and life.

31. Interpretation of initial sensory experiences structures the anatomy and physiology of the nervous system in such a way that the nervous system keeps re-enforcing the initial interpretation.

32. Perceptions that do not re-enforce the initial interpretation do not get into the nervous system. If you have a concept or idea that something does not exist, your nervous system will not allow it in.

33. Materialism has as one of its tenets that sensory experience is the crucial test of reality. Modern medicine is a system where the mechanisms of disease, as perceived, as equated with the origins of disease, so in treating the symptoms of disease, disease finds a new way of expression.

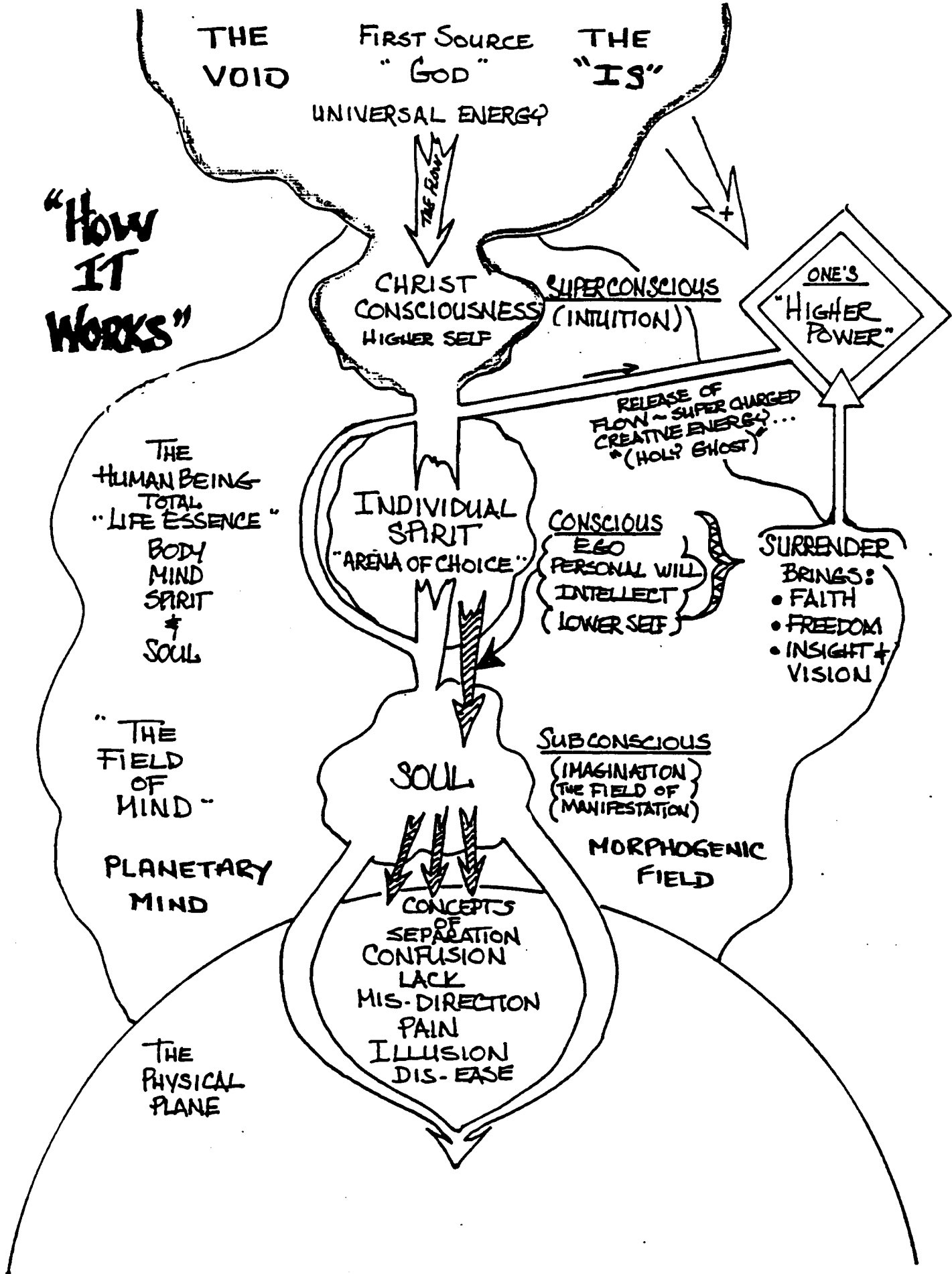

## M A T R I X I I I

### RECOMMENDATIONS FOR FURTHER READING

1. THE ILLUMINATI by Larry Burkett, 1991, Thomas Nelson Inc. This is the only NOVEL by this title having a half-page disclaimer in the front. It is a story in which the NWO is instituted and what happens...eventually, the people who set it up are discovered and set upon by the people who were previously in victim status. This book points out that there IS an alternate reality possible within the current framework of idiocy.
2. THE PRESENCE OF THE PAST: MORPHIC RESONANCE AND THE HABITS OF NATURE by Rupert Sheldrake, 1989, Vintage Books.
3. STALKING THE WILD PENDULUM by Itzhac Bentov, 1988, Destiny Books.
4. QUANTUM PSYCHOLOGY by Robert Anton Wilson, 1990, New Falcon Publications.
5. KINSHIP WITH ALL LIFE by J. Allen Boone, 1976, Harper-Collins Paperback.
6. THE CRYSTAL CONNECTION by Baer & Baer, 1986, Harper & Row
7. THE CENTER OF THE CYCLONE by John Lilly, 1972, Julian Press.
8. EDUCATING FOR THE NEW WORLD ORDER by B.K. Eakman, 1991, Halcyon House.
9. FAR JOURNEYS by Robert Monroe, 1985, Bantam Doubleday.
10. VIBRATIONAL MEDICINE by Dr. Richard Gerber, 1988, Bear and Company.
11. THE LAST WALTZ OF THE TYRANTS by Judi Koteen, 1989, Beyond Words Publishing, Orgeon 1-800-284-9673.
12. THE SPECTRUM OF CONSCIOUSNESS by Ken Wilber, 1989, Quest Books.
13. THE HEALING BRAIN by Dr. Robert Ornstein, 1988, Touchstone
14. THE NINE FACES OF CHRIST: QUEST OF THE TRUE INITIATE by Eugene E. Whitworth, 1980, Great Western University and Wiechmann Publishing, Seattle, Washington 98055.
15. INITIATION by Elizabeth Haich, 1974, Seed Center, Redway California.
16. MATRIX II: THE ABDUCTION AND MANIPULATION OF HUMAN BEINGS BY ADVANCED TECHNOLOGY by Valdamar Valerian, 1991, Leading Edge Research Group POB 481-MU58, Yelm, Washington 98597

# MATRIX II

Valerian, Valdamar. **MATRIX II: THE ABDUCTION AND MANIPULATION OF HUMANS USING ADVANCED TECHNOLOGY.** 3rd Edition Updated With New Material. LEADING EDGE RESEARCH GROUP, 1991, 8 1/2 x 11, Velo-Binding, 660pages, 1400 line-item index. This book is probably one of the most influential books to appear on the planet. Its first two editions sold out planetwide as of June 1990. It is rumored that some alien species have secured a copy, and the US Government has also apparently acquired it. The original **MATRIX**, issued in 1988, set the stage for this incredible piece of work. **MATRIX II** is more than a book - it is a journey into both your awareness and the awareness of other species, no matter who they are or where they come from. The book, now in its 3rd edition, updated in July 1991, encompasses an incredible range of data which includes precedental research on human abductions by both government and off-planet forces - material that other authors will not speak of and what publishers will not allow themselves to print. After the book was released, other researchers began to catch on to what has been occurring. Val Valerian weaves a wide range of interrelated material into a literary experience that will rock you to the core of your very being - one that includes expansion of your very consciousness as a side benefit. Included within the book is the now famous Wide Spectrum Chronological Database, a large section of hypothetical analysis by The Nexus Seven, data and updates on underground bases at Dulce and the Nevada Test Site, a large number of illustrations, maps and charts detailing activity sites, underground installations and tunnel networks, commentary by John Lear, Robert Lazar and a host of other top-notch researchers. Valerian takes us through the whole gambit of how, why, and by whom humans are manipulated, information about government connections to the abduction process, post-abduction problems, and things that the abductee can do. The book is the first to adequately relate research on memory functions relative to the abduction process, virtual reality machines and Reichian programming, and mind control by human and alien manipulators. It also discusses the abduction of human children and how to handle adjustment of the child to the experience, multi-generational scenarios and cases, human multi-dimensional anatomy and how it can be manipulated by technology, and elements of advanced technology possessed by the government. There is more information about the various species known as the Greys in **MATRIX II** than there has been (or probably ever will be) published anywhere. Perhaps for the first time, we get glimpses into what Grey society is like, what group awareness is about, and what their attitudes and mind-sets mean to humans. There is additional data on the Reptilian species who are dominant over the Greys, and what they may have planned for humans in the coming years. There are overviews of the processes and rationale for implanting humans, as well as cross-sections and technical data gleaned from extracted alien implants during 1991. Electronic space societies (which the Earth will become in the near future) are discussed. The book has an incredible spectrum of information about alien influence on human society, historical facts that are hard to come by, and much much more. There is just so much data in this book that it would take pages and pages to describe it. Best of all, the book integrates the positive and the spiritual aspects and illustrates how awareness can bring evolvement out of situations that people do not prefer. The book is the death-knell for planetary domination-based control systems - the whole domination/control game and its accompanying social manifestations (and what is ultimately behind them) are exposed for all to see. **MATRIX II** and the research of Valerian and others he includes in his book also spells the end for "classical Ufology" with its attendant "Ufologists", "experts", and most of the "UFO organizations" that are here today. It also exposes techniques that intelligence and security forces use to have influence over people and teaches you why they are doing it. Through the book, we can see how alien interaction has affected wave after wave of civilization on this planet, injecting elements of adverse technology and mind control, and how the suppression of human awareness is being performed and supported. **MATRIX II** is an absolute **MUST** to have in your library - you might throw all your other books on the subject away. LEADING EDGE RESEARCH also offers on a regular basis, the 100-page newsletter, **THE LEADING EDGE**. **MATRIX II** is \$52.50, postpaid. (USA)

## THE LEADING EDGE

In April 1991, Nevada Aerial Research Group moved its main operating center to Washington State and changed its name to Leading Edge Research Group. Since 1988, we have produced over 3,000 pages of research data and material which has been distributed worldwide through books and the main forum, The LEADING EDGE, which is produced on an average of once a month and is approximately 100 pages long. The group has correspondents and researchers in 37 states and 15 foreign countries who funnel data of unprecedented nature to the main center for analysis, compilation and distribution to researchers worldwide.

The main areas of discussion and coverage generally include, but are not limited to, the following areas of interest:

Consciousness, Awareness and Self-Empowerment  
Alien Interaction and Cultural Studies  
Human Abduction and Manipulation  
Primary and Free Energy Technology  
Space and Time Technology  
Advanced Communication Systems  
Psychotronics, Radionics and Mind Control  
Crystalline Matrix Technology  
Genetic Engineering and Development  
Overt and Covert Domination and Control Systems  
Species-Specific Power Structures  
Gravitational Technology  
Factors Affecting Social Development and Evolution  
States of Being and Beingness  
Planetary Integration

The goals of Leading Edge are to provide information on current developments which affect all those on, in, and around this planet, investigate and report on factors which affect planetary social structure and evolution, promote an increase in the general mass consciousness, promote universal understanding and evolution, and to further the processes of creation and manifestation within and in support of the Universal Intelligent Matrix of which all entities are a part.

The main philosophy, as it were, of Leading Edge Research is that all life forms should have the right and opportunity to have an existence which is endowed with the freedom to produce the maximum number of probable lines of reality in an evolving direction, by choice, without repression of awareness or manipulation of physical, mental or spiritual aspects.

Making known the unknown ultimately means development of one's own awareness. Join us in this adventure. Take the Quantum Leap in Consciousness. Work with your "belief systems", which are not founded in experience. Discover what they are and what your reality really means. Contemplate all this material which appears with great synchronicity at this time, and reflect on your inner knowing about who you are, why you are here, and how you are evolving. Peace To You.

M A T R I X I I I

MASTER INDEX FOR MATRIX III

<u>Description</u>	<u>Page</u>
Abbott Laboratories, information about	282
Accutane	281
Acetylcholine and Telepathy	19
Additives, food	137
Adlerian School of Thought	309
Adrenalyn Compounds and Telepathy	20
Adrenochrome as an alien object of desire	517
Advanced Technique Threat Assessment	419A
Agenda, Fascist, 1990's	673
Agglutinins	272
Agglutinogens	272
Ahenerbe, the	548
AIDS and its creation	455
AIDS and population reduction plans	455
AIDS as related to the Nazi movement	562
AIDS Tests, Third World, Army Plans for	206
AIDS, Airborne spread of	209
AIDS, alteration of the virus	207
AIDS, Condom Use and	177
AIDS, Containment Within Influenza Vaccine	211
AIDS, Dolphins with	208
AIDS, existence and environmental factors	476
AIDS, Experimental Drugs Halted by Romania	210
AIDS, HIV and Heterosexual Intercourse	209
AIDS, Papers Kept Secret By Judge on	208
AIDS, Plague Update on	217
AIDS, Second Wave, Women and Children and	208
AIDS, Strecker Memorandum about	210
AIDS, Thomas Beardens view of	369
AIDS, U.S. Navy classified study of	370
AIDS, United States, Statistics	208
Airborne Instrument Laboratories	324
Airborne Instrument Labs, location of	443
Akashic Records	86
Alastrim	257
ALCOA, Andrew Mellon as owner	127
Alfred Bielek, First Interview With	366
Alfred Bielek, Second Interview with	478
Alfred Von Bolschwing	554
Alien agenda	518
Alien connection to Montauk projects	429
Alien craft, Fourth Density	494
Alien fastination with humans	449
Alien group called the Leverons	450
Alien Intervention in Time Tunnel Experiments	451
Alien invasion of October 1990, attempted	444
Alien tendencies, Negative	517
Aliens in the Andreasson Affair	485
Aliens in the Streiber case	496
Aliens involved with Montauk experiment	448

M A T R I X I I I

<u>Description</u>	<u>Page</u>
Alpha Centauri, government of	480
Alpha rhythm, EEG	55
Alternate Reality Generators	480
Alternating Fields, effects on cellular areas	392
Alternative Three and Planetary Grid	684
Alternative Three, Mars bases and	478
Alumimum, Cause of Alzheimers	142
Aluminum Poisoning, Neurological Effects of	144
Aluminum, Major Sources of	146
Aluminum, Pharmaceutical Products and	144
American Buzzsaw signal	327
American Buzzsaw Signal, functions of	338
American Committee on United Europe	682
American Home Products, information about	279
American Medical Association, formation of	631D
American Medical International, information on	282
American Psychiatric Association	155
Amnesia, induction of	120
Amplifier, enzyme substrate as	54
Anal orientation, expression of 2nd Circuit as	70
Analysis, Transactional	67
Andreasson Greys as clones	518
Andreasson, Betty	485
Anger states, creation by ELF of	302
Anhydride, Acetic, use in Heroin Processing of	6310
ANSI standard, adoption of	288
ANSI standards, chronology of	375
ANSI standards, history of	376
ANSI standards, non-enforceability of	289
Antacids, aluminum contained in	144
Ante-matter is primordial mass	342
Anthrax spores, Desert Storm Troops and	213
Anti-Matter, physics of	368
Antibiotics and Electromagnetic Fields	205
Antibodies, Other	276
Antibody-Antigen Reaction, Mechanism of	276
AntiChrist	537
Antitoxins and Antisera, Table of	272
Antracis/ Anthrax	238
Armitage, Richard, drug trade and	149
Atlantean days and Telepathy	15
Attention and habit memory	112
Attention, Active, Factor of	691
Attenuation	8
Attracted response	14
Auric Band Structures, Human	13
Auric Bands, Layers in	13
Auric flares during telepathy	544
Australia, fluoride use in	134
Autism, environmental chemicals and	142
Auto-adjusting antibodies	301
Autonomic Nervous System	64



M A T R I X I I I

<u>Description</u>	<u>Page</u>
Awareness, Passive, Factor of	692
Axes, Real and Hyperspatial	318
Ayahasca Vine and Telepathy	18
AZT	281
Bacteria, Self-Directed Evolution of	183
Bacteriology, Veterinary	237
Balance and consciousness	534
Bands, Auric, Human, Frequencies of	320
Bands, Auric, Moving Images in	41
Bank of Credit and Commerce International	651A
Bank of International Settlements, Drug Money &	6310
Bank of Nova Scotia	631P
Barclay Bank	6310
Bases, military, closure of	642C
Basic Scientific Concepts and Knowledge	7
Bayer, A.G., information about	280
BCCI and the CIA	651A
BCCI, connections with CIA	652
BCCI, International Terrorism and Drugs with	652
BCCI, Warnings About, Justice Dept Ignores	652
Bearden, views about cellular structure of	361
Behavioral Psychologists, 2nd Brain Structure	61
Behavioral Transmitter-Reinforcer Machines	421C
Belief Systems and Perception	100
Belief, definition of	100
Belief, experience as related to	100
Belief, knowing as related to	100
Belief, reality tunnel formation and	101
Belief, systems forming gridwork	102
Bernstein, Nickoli	38
Beta rhythm, EEG	55
Beta waves, chemical stimulation of	323
Bidding as a contest of will	501
Bilderbergers, the	682
Bio-social Filters	106
Biofield Integrated Sound Systems	475
Biological Connection to Non-Hertzian Energy	355
Biological Effects of Oscillating Fields	386
Biological Enzymes and Magnetic Fields	53
Biological Reactions To Alien Lifeforms	52
Biological robots	518
Biological Warfare, World War II Plans for	182
Biological Weapons, Covert Research in	171
Biological Weapons, Tactical, Listing of	179
Biophotons	362
Biosystems, ELF/ULF Effects on	300
Biotechnology, Relaxation of Controls on	226
Black Level Clearance	445
Black Nobility, the	461
Blood is the Life	14
Bodies, assumption of	119
Body as an ID Tag	120

M A T R I X I I I

<u>Description</u>	<u>Page</u>
Body consciousness	116
Body Consciousness and manipulation	470
Body, natural frequencies of	295
Body, operation exterior to the	120
Body, Physical, Triple Design of	14
Bohm, David	24
Borne, Dr. Peter	419A
Boulder, Colorado, as EMC Headquarters	339
Bourland, David, proposals of	102
Brain Activity	56A
Brain Circuitry, Charts of	91
Brain Circuits, activation by drugs	92
Brain Circuits, density relationship to	92
Brain Circuits, dimensional aspects of	93
Brain Circuits, Gurdjieff Centers and	95
Brain Circuits, personalities typified by	94
Brain Circuits, Social Acceptance of	93
Brain entrainment by natural EM fields	374
Brain Structure, Fifth	79
Brain Structure, First	62
Brain Structure, First, Dualities of	67
Brain Structure, First, Reimprinting of	65
Brain Structure, Fourth	75
Brain Structure, Fourth, Dualities of	79
Brain Structure, Second	67
Brain Structure, Second, Dualities of	72
Brain Structure, Second, Imprints of	72
Brain Structure, Seventh	86
Brain Structure, Sixth	82
Brain Structure, Third	72
Brain Structure, Third, Dualities of	75
Brain Waveforms, Fourier Transformations and	28
Brain, chemicals released by Conscious Act	59
Brain, creation of internal holograms by	27
Brain, Crystalline Structure of	339
Brain, electrical activity, frequencies of	42
Brain, evolutionary development period of	57
Brain, function as a prism and receiver	57
Brain, genetic structure of and perception	118
Brain, interpenetration of mind	339
Brain, Lateral View of	76
Brain, origin of "sight"	28
Brain, Sagittal section of	76
Brain, Structural Areas, Diagram of	63
Brain, tuning circuits of	59
Brain, Visual System of	28
Brains, children born without	142
Brainstem, diagram of	66
Brainwaves, entrainment by ELF of	301
Bristol-Meyers, information about	280
British Intelligence Service	631A1
Brookhaven National Labs	424

M A T R I X I I I

<u>Description</u>	<u>Page</u>
Brotherhood, the Dark	503
Brucella Group	244
Burroughs Wellcome, information about	281
Bush Family and Control of Nazi Commerce	573
Bush Family and the Nazi Project	569
Bush, circumvention of hunt for US Nazis	562
Bush, George, Genealogy of Tyrants	648
Bush, George, Race Hygiene and	576
Bush, George, Secret History of	563
Bush, Neil, S&L Scandal and	648
Bush, October Surprise and	649
C'hi	312
Calcium Efflux Effects of EM Fields	389
Cameron, Duncan, Interview With	472
Cameron, Ewen, suit against	421C
Cameron, Ewen, relationship to CIA and drugs	155
Camps, concentration, plans for	642B
Canadian Imperial Bank	631P
Canadian Psychiatric Association	155
Cancer, Politics of	201
Cancer, State Involvement with	202
Cancer, treatment with Caduceus Coil	364
Capacitance	8
Caramel, formulation from ammonia of	140
Carbon Dioxide, Neurological Effects of	56B
Carnegie Foundation	108
Carter, James Earl, BCCI and	651A
Catatonic states, creation by ELF of	302
Cathie, Bruce, Planetary Grid works of	684
Catholic Church, ties to Masonry of	685
Cattle mutilations, government involvement in	460
Cave of Brahma, third ventricle and	79
Cave of Bramha	78
Cell Differentiation, alteration by ELF of	301
Cellular chemistry, alteration of by ELF	301
Cellular frequencies, alteration by ELF of	301
Cellular Networks, Planned increase of	353
Cellular structure, alteration by ELF of	301
Cellular Telephone Network, mind control aspects	330
Centro Ramon y Cajal	308
Cerebellum	72
Cerebellum, position of	74
Chakra energies, 4th Brain structure and	75
Challenger, destruction of	443
Change, negative payoffs that prevent	538L
Change, resistance to	98
Changing Polarization	515
Channeling	488
Channeling and values of Being	509
Chaos and Coherence	527
Chemical Companies, Major, Who Controls	278
Chemicals, antagonistic	147

M A T R I X I I I

<u>Description</u>	<u>Page</u>
Chemicals, Environmental	141
Chickenpox	257
Children, Fluoride Consumption by	129
Children, murdered by government mind control	428
Chlorine Gas, I.G.Farben and	135
Chlorine in water, toxicity of	157
Cholera, Hog	267
Christ Consciousness, essay on	538B
CIA and Drug Trafficking	148
CIA and parapsychological studies	545
CIA and the Jonestown murders	556
CIA and the Phoenix Projects	428
CIA and the Shah of Iran	555
CIA payments to Reinhard Gehlen	552
CIA, Bush and Kennedy	630
CIA, composition of Nazi SS intelligence	553
CIA, connections in the international drug trade	631A1
CIA, Connections to BCCI Scandal	652
CIA, description by Harry Truman	557
CIA, Falsification of history of	602
CIA, George Bush and, Suppression of News by	641
CIA, Guidelines for Journalists	641
CIA, heroin injected into society by	65
CIA, Links to S&L Scandal and	641
CIA, Links with Mexican Drugs and DEA	642
CIA, Pan Am 103 and	674
CIA, Secret Alliances, WW 2 to Watergate	654
CIA, University Funded Programs with	643
CIA, weapons dealing with Terpil and Wilson	555
Ciba-Geigy, information about	280
Circadian rhythm changes, ELF causes of	302
Circadian Rhythms	53
Circuit, DNA, Collective	86
Circuit, Time-Binding Semantic	73
Cloning , development at University of Utah	461
Cloning, Necessity for	683
Cloning, New World Order and	683
Coagulation of Light into Mass	354
Cocaine, shipping seizure of	631A2
Cognitive screens and filters	536
Coherence and Incoherence, Chart of	11
Coherence, Bioelectrical	56A
Coherence, Electromagntic	56B
Coherence, Human Body Internal	56B
Color, dreaming in	86
Common sense, concept of, brain area relation to	73
Communication, morphic, species specific	45
Communism as a false enemy to hide Nazis	557
Complex Conjugate, as Hyperspacial component	312
Complex Conjugate, definition of	314
Complex Numbers, definition of	314
Compulsive behavior patterns, ELF relation to	302

M A T R I X I I I

<u>Description</u>	<u>Page</u>
Concentration Camps, Oregon, 1991	653
Concentration camps, relation to mind control	441
Concentration, Phases of	693
Connectedness, Quantum Level	39
Conscious Development, Third Density	491
Conscious negativity as a choice	493
Consciousness and matter	23
Consciousness and Pulse Manifestation	56B
Consciousness and the Energy Spectrum	353
Consciousness as the name of the Game	519
Consciousness as the premium in any scenario	520
Consciousness magnification	521
Consciousness to Mass Transduction	349
Consciousness, Awareness and Will as flow	341
Consciousness, Bio-social Filters of	106
Consciousness, Holographic Aspects of	40
Consciousness, Self-reflective	491
Conspiracy Theories, Planetary, Advisory on	539B
Conspiracy, Hertzian	310
Contradictions within Negative Alignment	514
Copper-based blood systems	461
Coverup, Electromagnetic, Military and	304
Cowpox	254
Cox, Gerald	126
Creative Power of Being	523
Crime and Emotional Instability, National	374
Criminal behavior patterns, ELF and	302
CSISOP	75
Cyclamates, effect of	139
Cytolysins, Phenomena in	274
Darwin, theories dealing with Reptilian Brain	61
Data networks, Russian, US operation of	354A
De Morrenschildt	628
Deaf Smith County	126
Dean, H. Trendley	126
Death Rates From Cancer 1970-1988	234
Death, Eugenics and Incompetent Persons, US rule	650
Death, Heart Disease, 1970-1988	235
Death, Rates by Cause, United States, 1988	236
Deaths and Selected Causes 1970-1989	233
Deaths, AIDS, By Age/Sex/Race for 1982-1989	235
Deaths, Genetic Entity and memory of	118
Deception and Positive Entities	512
Definitions, Relativistic Physics	312
Delgado, Jose	308
Delgado, Jose, work of	373
Delgado, School of Thought	309
Delguidice, quantum propogation of EM fields	360
Delta-T Antenna and Time-Warping	473
Delta-T antenna, description of	322
Delta-T antenna, operation of	472
Deltons	342

M A T R I X I I I

<u>Description</u>	<u>Page</u>
Densities, Basic Principle and Function of	498
Densities, explanation of	490
DePass, K.C., interview with	642B
Depatterning as a Mind Control Technique	155
Depression, creation by ELF of	302
Deuterium, use in cold fusion experiments of	631C1
Devices for Manipulation	120
Dimensional Consciousness, Model of	87
Dimensions, definition of	314
Dirac Sea	312
Disease and polar amoebic cloud structures	455
Disease, Foot and Mouth	265
Disease, Infectious, Concept of	163
Disinformation, government	538T
Displacement of Whole-Value Identity	530
DNA Helix oscillation	382
Domains, Hyperspatial, Access to	318
Dominion, Positive and Negative, levels of	538M
Dope Incorporated	148
DOR	424
DOR Oscillation	474
Downs Syndrome, Vernon, New Jersey study of	291
Dreaming, sleep-state	535
Dreamland	517
Dreams, holographic	45
Dreams, REM and Brain Function	56B
Drug and Implant Technology	519
Drug Companies, Major, Who Controls	278
Drug dealers, Syrian, Pan Am 103 and	677A
Drug Money Laundering and Clearing Houses	631P
Drug money laundering, BCCI and	651A
Drugs, Culturally Promoted	154
Drugs, Planetary movement of	631O
Dualisms Within Society	107
Dulles, Allen	149
Dulles, Allen, the German SS and	551
Dulles, John Foster	149
E=MC2 C2 Light Reciprocal	367
Eagle Star Insurance Company	631P
Earth as a staging base for the Orion group	454
Earths Power Grid	332
Earths Power Grid and Relationship to N W O	684
Edison, Thomas, the DC current system and	285
Educating For the New World Order, book called	110
Educational Systems and Behavior Modification	108
Ego, conceit of	534
Ego, emotional load of	114
Ego, expression through 2nd Brain Circuit	70
Ego, function in consciousness of	515
EGO, perception of separateness and	97
Ego, what it looks for	532
Einstein-Rosen Bridge, higher order of	323

M A T R I X I I I

<u>Description</u>	<u>Page</u>
Electro-convulsive Therapy	155
Electromagnetic effects on blood	378
Electromagnetic Field Interactions in Tissue	390
Electromagnetic Field Reduction, Research Needs	398
Electromagnetic Fields and Antibiotics	205
Electromagnetic Fields and Epidemiology	372
Electromagnetic Fields and Neurotransmitters	363
Electromagnetic Fields, Man-Made	285
Electromagnetic Hazards, No Action in Cases with	294
Electromagnetic Hazards, Public References on	299
Electromagnetic Information, Health Sheet on	396
Electromagnetic Interaction With Nervous System	386
Electromagnetic Pollution, harmonics generated	370
Electromagnetic Pollution, MIT recommendations	375
Electromagnetic Propagation, aspects of	437
Electromagnetic Radiation Effects Extracts	375
Electromagnetic Radiation, Growing Hazards of	394
Electromagnetic signature, individual	440
Electromagnetic Spectrum, Scales, Chart on	286
Electromagnetic Theory, errors in	311
Electromagnetics, increased use of and cancer	295
Electromagnetics, Three Orders of	316
Electromagnetics, Time-Varying, Report on	299
Electron as a particle or wave	38
Electronic Mind Control Projects - Part 1	420
Electronic Mind Control Projects - Part 2	421
Electronic Mind Control, Detection of	328
Electronic Mind Control, Search mode of	327
Electronic Stimulation of the Brain	373
Electrons, Free Radicals and	9
ELF and genetic transmutation	393
ELF and Sub-ELF Fields, Effects of	388
ELF Fields, Behavioral Effects of	387
ELF Fields, Biosensistivity to	56A
ELF Fields, definition of	300
ELF Fields, Windowed Responses in Brain Tissue	388
ELF Fields, World Health Organization Study on	299
ELF Radiation and DNA Transcription	393
ELF Tests, U.S. Navy results with	301
ELF, Additional Capabilities of	302
ELF, Areas of Existing Usage	303
ELF, interaction with DNA and	300
ELF, Lesser-known Characteristics	317
ELF, Macromolecular Phase Transitions	391
ELF, Natural, Artifical and Tactical	303
ELF, protection from	371
Eli Lilly, information about	279
Elohim, the	450
EMI Thorn and the Philadelphia Experiment movie	367
Empowerment, secrets of	538R
Energies, Masculine and Feminine, Key	538Q
Energies, Seven generating	538M

M A T R I X I I I

<u>Description</u>	<u>Page</u>
Energies, sustaining	5380
Energy Centers, Physical, Seven	14
Enfolded Information, Fourier Analysis of	336
Enfolded Order	40
Entities, Embedded	121
Entrainment, Brain	56A
Entrainment, Rhythm	56C
Enzymes in a cell, number of	53
Equation For Power, Orthodox vs Relativistic	314
Equations, Fourier Transformation	29
Equations, Harmonic	10
Equations, Maxwell	316
Etheric Body, change of	12
Etheric Body, network	12
Etheric domains	367
Etheric matter, relationship to physical matter	89
Etheric Structures, Human	12
Eugenics, Congress on	578
Europe, New World Order in	682
Events, spatially independent	96
Evolution, "enemies" to	538L
Evolution, Positive and Negative, Truth Maps on	538G
Ewing, Oscar	127
Ewing, Oscar, as promoter of fluoridation	128
Existence, non-physical	112
Experience, cellular	117
Experience, Goals and	97
Experience, screening of	111
Explicate Order	40
Facsimilies, memory gestalts as	119
Fatigue states, creation by ELF of	302
Fear of being left out, 2nd Brain and	69
Fear states, ELF cause of	302
Federal Reserve, ownership by British of	631P
Federal Reserve Board, inaction about BCCI of	651A
Feedback	298
Feelings, levels of, consolidation by 4th brain	79
Fetal Mortality, acceleration by ELF of	301
Fever, Dengue	265
Fever, Heartwater	250
Fever, Pappataci	264
Fever, Phlebotomus	264
Fever, Q	250
Fever, Rift Valley	265
Fever, Sandfly	264
Fever, Trench	250
Fever, Typhus	247
Fevers, Spotted	249
Fevers, Tsutsugamushi	249
Field Enhancement Effects	382
Field, electrical, biological membrane	54
Field, Human Energy	42



M A T R I X I I I

<u>Description</u>	<u>Page</u>
Fields, Alien Biological, Spin-Vectors of	52
Fields, Dr. Craig	419B
Fields, Exterior, Life-Form Organising	45
Fields, Hyperspace	351
Fields, Magnetic, Pulsed, Protein Synthesis and	353
Fields, Ultraspace	351
Fifth Density Alignment	494
Fifth Density and the Creative Mind	502
First Brain Circuit, Natural Breathing and	65
First Order Electromagnetics	316
Fleischmann, Martin, cold fusion work of	631C1
Fluoride and dental profits	126
Fluoride Compounds, Use of	124
Fluoride, hydrogen	124
Fluoride, Major Sources of	146
Fluoride, propaganda program for	128
Fluoride, relationship to cancer	129
Fluoride, the Gambit	126
Fluoride, use by Germans on prisoners	129
Fluoride, use by Soviets on prisoners	129
Fluorides, as by-products of Fertilizer plants	124
Fluorides, Congressional Statement on	135
Fluorides, deaths resulting from	125
Fluorides, Environmental Pollution by	124
Fluorides, human tolerance of	124
Fluorides, Overseas Usage	134
Fluorides, use as rodenticides	124
Fluxon, definition of	313
FM radio fields and disease, Orgeon study on	294
Focus, state of	692
Focusing, Isoelectric	268C
Food Colors, FD&C	138
Food Supply, Addition of Nitrates to	136
Food, Direct Addition of Chemicals to	137
Food, Irradiation of	140
Food, viability decreased by chemical fertilizer	136
Fornix, position of	68
Forrestal, James, murder of	592
Fort Detrick, MK-NAOMI operations at	421A
Fort Know, Army mind control experiments at	419B
Fourier Transforms, Conversion by	28
Fourth Density and Void-Nature	494
Fourth Density beings	494
Fourth density consciousness	458
Fourth Density focal lock-in	508
Fourth Density Polarizations	494
Fourth Density progression	469
Fourth Ventricle	67
Frame, Sir Alistair	281
Framework in which to View Matrix III	487
Fraternities, Exerpt from Encyclopedia of	679
Free Radicals	9

M A T R I X I I I

Description	Page
Free Will, concept of	115
Free Will, human	538T
Freedoms, Key	538O
Frequencies, Beat	298
Frequencies, Body, Range of	41
Frequencies, Brain	56A
Frequencies, Coherent and Incoherent, Chart	11
Frequencies, Database on	56A
Frequencies, Government Implant	319
Frequencies, muscle	42
Frequencies, Osmic	38
Frequencies, Psychic	42
Frequencies, Window, Mind Control	319
Frequency Analysis, Visual Systems and	28
Frequency Weapons, British, 1982	307
Frequency, Protein reaction to	56B
Freudian School of Thought	309
Frontal Lobe, position of	74
Functional dependency in Negative Polarization	520
Functions, Periodic	8
Fungal Disease, Airborne Spread of	224
Fungal Infection, Insect Anti-bodies and	225
Fungal Warfare	222
Fungus, Neural, Discovery of	205
Fusion, cold, new experiments with	631C1
Gehlen, Reinhard, defection of	551
Gehlen, Reinhard, establishes West German CIA	552
Gehlen, Reinhard, meetings with Bill Donovan	552
Gehlen, Reinhard, meetings with Truman	552
General Electric, mind control research and	419B
Genetic causes of aging	459
Genetic Entity	117
Genetic Entity, entry into protoplasm line of	118
Genetic Entity, memory traces in	118
Genetic programming	116
Genetic, Orion	453
Geomagnetic Field and Magnetic Storms	50
Geomagnetic Field Characteristics	48
Geomagnetic Field Reversal, Theories on	51
Geomagnetic Field, Micropulsations of	50
Geomagnetic Polarity Reversals	51
Geomagnetism and solar activity	51
German electronics experts in Phoenix Projects	428
Gestalt, perceptive memory	119
Getty, John Paul	554
Gibbs, Willard , Hertzian Conspiracy and	310
Glaxo Holdings, information about	281
Glaxo, R&D at	284
Gnotobiotic organisms	289
Goldwater, Barry, shutdown of Phoenix work	428
Gottlieb, Sydney	421A
Government, US, CFR/Trilateral Hierarchy	639

M A T R I X I I I

<u>Description</u>	<u>Page</u>
Grand Rapids, Fluoride tests in	127
Grandfather Paradox, resolution of	467
Great Fixation, the	691
Greenspan, Alan, as director of ALCOA	146
Greys, origin in a different time continuum	457
Grid, Earth, Loading of	323
Grid, Planetary, putting to sleep	326
Grid, Tensor Field, Non-Linear, 2-D, Chart	315
Grid, Tensor Field, Non-Linear, 3-D, Chart	315
Grimaldi Family, drug connections of	6310
Gritz, Bo, investigations into drug smuggling	149
Ground-Wave Emergency Network (GWEN)	305
Groups, authoritarian and dogmatic	103
Groups, congregation of, and Second Brain	69
Guillain-Barre Syndrome, Swine Flu and	212
Guns, Anti-Gun Propaganda Same as Nazis	644
Gurdjieff, views on Multiple Personalities of	104
Guy, Arthur	289
Habitual pathways of consciousness	510
Hamilton, James	421A
Harmonics	10
Hartman Lines, the	329
Hatch, Orin	651A
Head, resonating systems within the	339
Heard, George	126
Heart attacks, chlorine-treated water and	135
Heart Center, 4th level of consciousness as	78
Heart disease, fluorides and	126
Heaviside, Oliver, Hertzian Conspiracy and	310
Hemispheres, cerebral, functions within	84
Herpes	257
Hertz, Heinrich	285
Hertz, Heinrich, Hertzian Conspiracy and	310
Hilarion, Negative Beings and	503
Himmler and race purification	542
Hinduism, Vendanta	691
Hippocampus, position of	68
Hiter, alien technology involvement of	464
Hitler, alleged involvement with Phoenix	462
Hitlers strategy to win World War II	550
HIV, Links with African Parasites and	215
Hoechst, A.G., information about	279
Hoffman LaRoche, information about	281
Hollywood convinces the public Germany no threat	550
Hologram, description of	24
Hologram, The Physical Body as a	43
Holograms, Multiple, Multiple Personalities as	44
Holographic Inserts	44
Holographic Theory of Telepathy	22
Hormone levels, alteration of by ELF	301
Hormones, Enzymes and radiant energy value	516
Human Being as a Composite Entity	118

M A T R I X I I I

Description	Page
Human Brain EEG Signals	55
Human Cranium, resonant frequencies of	330
Human Energy Field, Other Aspects of	42
Human life, conditions for entering	111
Human space-time dramas	114
Hutschnecker, Dr. Arnold	419A
Hypnosis, Genetic Entity and	117
Hypnosis, Self, Genetic Entity and	117
Hypnotic Virtual Reality Structures	22
Hypothalamus, Immune System and	268B
Hypothalamus, position of	68
I Am That I Am	692
I.G.Farben, Chlorine gas and	135
I.G.Farben, cyanide supplies from	560
IAA	653A
Identification functions and polarities	492
Identity, actual knowledge of	119
Immune Cell Receptors	268B
Immune System and Brain Structure	268B
Immune System and Central Nervous System	268B
Immune System and Emotions	268B
Immune System and Endorphins	268B
Immune System and Non-Hertzian Fields	363
Immune System Breakdown	268B
Immune System Enhancement	268C
Immune System Memory	268C
Immune system processes, alteration by ELF of	301
Immune System Suppression	268C
Immune System, chemicals produced by	268A
Immune System, Database Data on	268B
Immune system, effects of fluorides on	125
Immunity, Types of	269
Immunization, HIV-Infected Children and	189
Immunization, The Gambit	165
Immunization, U.S. Recommendations for	184
Immunizations, DPT, Adverse Reactions to	190
Immunocompetence, Altered	188
Immunological Reactions	270
Implant, between-lives	123
Implants, Biological, Diagram of	446
Implants, brain	373
Implants, mind control, development of	421B
Implicate Order	40
Implicate Order, Bohm Theory of	356
Impressions, Telepathic	19
Imprint Vulnerability	64
Imprinting, as related to brain structures	91
Imprints	64
Incarnate teachers, purpose of	536
Inculcation	38
Inculcation Bar, lights on	464
Influenza Control, Official Recommendations for	197

M A T R I X I I I

<u>Description</u>	<u>Page</u>
Influenza Type A, Anti-viral agents for	197
Influenza, Epidemic forms of	258
Influenza, Epidemic of 1918	193
Influenza, Epidemic, United States 1991	206
Influenza, Swine	266
Influenza, Swine, Massacre of 1976	169
Initiates and Consciousness Development	520
Injury, Vaccine-Caused, Judicial Awards for	165
Inman, Admiral Bobby Ray	421C
Insecurity, feelings of, 4th Brain and	78
Inserts, Holographic	44
Intelligent Infinity and Negative Polarity	514
Inter-Brain	77
Intercontinental Aerospace Alliance (IAA)	653A
Interference Patterns	27
Interference, Sound, Properties of	56C
Interlocking of Psychic and Psychokinetics	522
Internal Vision	42
International Aerospace Alliance	445
International Affairs, Canadian Institute for	631A1
International Affairs, Royal Institute of	631A1
International Monetary Fund, Drug Money and	631O
Interpol	631A1
Intimacy, blockages to	538K
Intramolecular Matrix Theory	359
Intuition, concept of, 6th brain process	82
Ionospheric Cavity Resonance Frequencies	47
Ionospheric Cavity, Resonance of	48
Iran-Contra Affair	150
Iran-Contra Hearing, Excerpt from	642
Iraq and nuclear devices	465
Irradiated Food, data on	142A
Irradiation, foreign banning of	140
Irresponsibility	538L
Is-ness	102
ITT, breakup of	326
Jerusalem, Order of St. John of, Denials by	689
Jerusalem, Temple of	682
Josephson Effect, cellular level	54
Jungian School of Thought	309
Kaiser Wilhelm Institute	419A
Karma as conceptual impression on consciousness	515
Karma, concept of	499
Kennedy Assassination, ONI connection to	631P
Kennedy Assassination	627
Kennedy, Assassination related to ET knowledge	439
Kennedy, Bush and the CIA	630
Khun Sa, drug smuggling and	149
Kidney disease, fluorides and	126
Kidney problems, aluminum poisoning and	143
King, Moray	358
Kinship With All Life	21

M A T R I X I I I

<u>Description</u>	<u>Page</u>
Kintex Company, drug running by	6310
Kirkpatrick, Evron, CIA	149
Kirkpatrick, Jeane	149
Knights of Malta, CIA ties to	680
Knights of Malta, Nazi ties to	680
Knights of Malta, Sovereign Military Order of	680
Knights of Malta, Vatican Ties to	680
Knowing, brain areas related to	84
Koan, the	691
Kondrashskin, alien group called	443
Kundalini, polarized lockin of the	507
Lansky, Meyer, and Syntex	281
Lashley, Carl	27
Laws, Noahide	631C2
Lazar, Robert	369
Learning, cultural process of	110
Learning, Human	110
Learning, occurrence during unconscious states	113
Leary, Timothy, research on brain circuits and	61
Lebensborn, the	547
LeFebvre, Archbishop	685
Lemuria and Telepathic Use	15
Leukemia and electromagnetic fields	372
Leukemia and transmitter stations	370
Leukemia, creation by ELF of	302
Leukemia, Viral Causes of	214
Levinson, Norman, Classified projects and	368
Levinson, Norman, Time Equations of	327
Levinson, Norman, Time-Equations and Phoenix	434
Life Energy as a Unified Field Energy	335
Light as food	516
Light Energy and the Mind-Body Axis	522
Light-Beings	516
Livestock, fluoride poisoning of	125
Longitudinal Waves	10
Love	523
Love actions, substructure and processes of	538J
Love and the curve of "doubt"	529
Love as a force, actions of	538I
Love as a function of Identity'	528
Love God, concept of	501
Love levels, octaves of	538I
Love, blockages to	538K
Love, resistances to	538L
LSD Tests on US Servicemen	421A
LSD, Canadian lawsuit because of	156
Luciferian consciousness	523
Luciferian consciousness as a Contradiction	524
Luciferian consciousness as an imitator	529
Magnetic Fields and Cancer	292
Magnetic Shielding by Aluminum	55
Magnetic Symmetry of Organic Lifeforms	52

M A T R I X I I I

<u>Description</u>	<u>Page</u>
Manifestation, secrets of	538R
Manipulation and enslavement, Orientation to	493
Manipulation, Multi-Density Electronic	119
Manipulation, Societal, Drug-Caused	148
Manipulative technology, derivation of	519
Marciniak, Barbara	44
Marks, Leonard	281
Mars, civilizations on	478
Mars, the face on	473
Mars, underground facilities on	324
Masking of holism of Self and Creator.	502
Masonry, ties of the Vatican to	685
Matter, etheric, acceleration of	90
Mattreya, Lord	440
Maxwell, James Clerk	309
Measles, German	258
Measles, Return of	206
Medical Research, Misconduct in	221
Meditation	509
Mellon Institute	126
Melatonin	53
Memory Complex, Social	468
Memory loss, relationship to ELF	302
Memory, 5th and 6th brain areas and	80
Memory, Ancestral	26
Memory, Associative, Holographic Aspects of	28
Memory, brain functions and	27
Memory, Brain, Holographic Storage and	27
Memory, Cognitive/Associative	26
Memory, Eidetic	25
Memory, Figural	26
Memory, genetic	116
Memory, Habit	26
Memory, Human	25
Memory, Human, Capacity of	27
Memory, Iconic	25
Memory, Immune System	268C
Memory, Long-Term	25
Memory, Neo-Mammalian	72
Memory, Penfield experiments and	26
Memory, retained despite tissue removal	27
Memory, Savant	26
Memory, Semantic	25
Memory, Short Term	25
Memory, Visual Image	26
Mengele, Joseph	558
Mental Disorders, relation to Caramel	140
Merck, information about]	278
Mercury, Poisoning in Dental Fillings	162
Messaianic Legacy, the	682
Metal poisoning, research on	147
Metaphysics, Postive and Negative, levels of	538M

M A T R I X I I I

Description	Page
MI6, funding of	631P
MIB	466
Microwave Grid, National, Chart of	306
Microwave signals and the American Embassy	375
Microwaves and Birth Defects	383
Microwaves and Brain Tumors	291
Microwaves and cataracts	383
Microwaves and Fetal Development	383
Microwaves and Genetic Effects	290
Microwaves and Tumors, Hughes Aircraft study on	287
Microwaves, Absorption of	302
Microwaves, Bioeffects of	56A
Microwaves, DNA Absorption of, Military Work on	302
Microwaves, genetic effects and DNA resonance	291
Microwaves, hearing	378
Microwaves, induction of hypnosis by	419A
Mid-Brain, area of	75
Milner Group	631A1
Mind amplifiers, alien sourcing of	429
Mind Control and the Cellular Telephone Network	329
Mind Control and the White House	419A
Mind Control Using Fluoride Compounds	129
Mind Control, alien intervention with	479
Mind Control, Burying signals in EM Waves	336
Mind Control, Conversations on	321
Mind Control, Drugs and	154
Mind Control, Electronic, Frequencies Used in	338
Mind Control, Electronic, Programming Stages of	338
Mind Control, Pre-Conditioning Stage of	338
Mind Control, Psychology behind	308
Mind Control, Schools of Thought Behind, Chart	309
Mind Control, Use of Bedsprings as receiver of	337
Mind, Analytical	117
Mind, position relative to the brain	87
Mind-Machine links	545
Mineral Oil, effects of	139
MIT as a stronghold against cheap power	631C1
MKULTRA Subproject 142	421B
MKULTRA Subproject 94	421B
MKULTRA, Dr. Louis West and	419A
MKULTRA, Sub-Projects under	421A
Modulated Fields, Neurophysiological Effects of	388
Modulation, Amplitude	297
Modulation, carriers for	8
Modulation, Frequency	297
Modulation, Information Transfer, Chart on	296
Modulation, Phase Relationships and, Chart on	297
Modulation, Pulse-Code	296
Modulation, Pulse-Position	296
Modulation, Pulse-Width	296
Modulation, Secret of Information Transfer	294
Molecules, Right and Left-Handed	52



M A T R I X I I I

<u>Description</u>	<u>Page</u>
Money, New, issuance of	460
Monsanto, information about	278
Montauk Chair, operational setup of	476
Montauk Chair, the	321
Montauk, description of underground at	450
Monteith, Henry, Conformation of Maxwells work	311
Mood alteration, creation by ELF of	302
Morality, concept of, brain structures and	79
Morphic Field Organisation	45
Morphic Field, Connection of Conscious Self to	46
Morphic Fields as Unified Fields	46
Morphic Fields, Structure of	46
Morphic Information Transfer Hierarchy	46
Morphic Resonance	43
Morphic Resonance, Examples of	47
Morphogenic Fields as Non-Hertzian	355
Morphological Field Dynamics	45
Mount Sinai Hospital, Mind Control work at	421A
Multiple Sclerosis, Viral Causes of	214
Murder of indegent people by Phoenix Projects	426
Mustard Gas Experiments, Navy's	157
Myxomatosis	267
Nadis	14
National Bureau of Standards (NBS)	326
National Institute for Fusion Science	631C1
National Reconnaissance Office, problems with	653B
Nazi agencies and the alien dynamic	520
Nazi attempts to control world power structure	561
Nazi control of the United States	462
Nazi gold as funding for Phoenix Projects	427
Nazi gold misplaced during the war	551
Nazi incursion into US intelligence	553
Nazi medical experiments	546
Nazi psychic research	543
Nazi racial attitudes	540
Nazi search for psychic phenomena	542
Nazi SS, formation and membership	541
Nazi sterilization techniques	546
Nazi telepathic experiments	544
Nazi-alien bases	462
Nazis and the 1936 Olympics	540
Nazis and the Occult	543
Negative Hierarchy, structure of	521
Negative Results From Positive Actions	532
Negative Shield, components of	5380
Negative, tricks of the	508
Negativity as a Subjective Misperception	506
Nerves, Major Spinal	58
Nervous System as a Separate Body Within	61
Nervous system, Dual	49
Nervous System, Structural Highlights of	60
Neural material, crystalline structure of	340

# M A T R I X I I I

<u>Description</u>	<u>Page</u>
Neural Matter, White and Grey	59
Neural stimulator	446
Neuro-linguistic programming	320
Neurolinguistic Programming and music	338
Neurological areas, related to circuits	91
Neurological States, Related Notations on	96
Neurons, response to specific frequencies of	38
New Age Mentality	500
New World Order, Derivation of, Charts on	632
New York Life Insurance	631P
New York State Powerline Study	293
Nichols, Preston, Interview with	472
NIMH, Mind Control projects and	421B
Nixon administration, mind control during	419A
Nobility, Black, families of	631P
Non-Hertzian Fields	355
Non-Hertzian Fields as Unified Fields	356
Non-Hertzian Fields, generation of	359
Non-Hertzian Fields, interaction with electrons	358
Non-Hertzian Fields, measurement of	355
Non-Ionizing Radiation Standards, Orthodox	397
Non-Locality, Concept of	39
Nordic alien physiology	463
Noriega, conviction of	631S
North, Oliver	150
Northrop studies of Biological Entrainment	378
NOW, living in the	97
NRO	653B
NSA and Project Dreamscan	442
NSA and the Psi-Corps	480
Object of Negativity	515
Objective Reality and Waveforms	38
Occipital Lobe, position of	74.
Office of Naval Research, EM effects studies of	289
One World Order, Alien Control of	452
One World Order, Electronic Mind Control and	539
One World Order, One World Religion	539
One World Order, Silent War to Establish	539
One World Order, The Plan of	539
One World Order, Total Economic Control Plans of	539
Operation Big City	421B
Operation Midnight Climax	421A
Operation Mindbender	421A
Operation MK-DELTA	421A
Operation MK-NAOMI	421A
Operation MK-SEARCH	421A
Operation Often	421C
Operation Resurrection	421B
Operation Spellbinder	421B
Opiate Drugs and Population Management	65
Opium, British markets in China for	631D
Opsonins and Phagocytosis	275

M A T R I X I I I

<u>Description</u>	<u>Page</u>
Order, Concept of	40
Order, the	686
Orientation of Negative Polarities	500
Orion Confederation	454
Orion Crusaders, the	497
Orion Group, purpose of	467
Orion Group, relationship to Mind Control	444
Orion Technology and Other Secret Projects	423
Orthogonal rotation and density shifting	500
Orthogonal Rotations	310
Oscillations, "lock-in" of	96
Oscillations, Periodic	7
Osteoarthritis, Genetic Causes of	215
Pan Am 103, Bombing of	674
Pan Am 103, Eight CIA Agents on Board to testify	674
Pan Am Flight 103, CIA connections to	677A
Pan Am Flight 103, drug connections with	677A
Parasympathetic Nervous System and Negative Ions	19
Parasympathetic Nervous System and Telepathy	19
Parietal Lobe, position of	74
Particle Enfoldment	40
Particles and Waves, Holographic Aspects of	38
Past and Future Enfolded Everywhere	40
Path, becoming the	87
Patient records, Use as a Profit Source	231
Pau D'Arco, suppression of information about	147
Pearlian School of Thought	309
Pentagon, 1992 goal as World Policeman	651
Perception and Belief Systems	100
Perception and Expectations	41
Perception, Holographic Aspects of	41
Permindex	631P
Perot, H. Ross	150
Personalities, Multiple	104
Pesticides, Exportation of Banned	137
Pfizer, information about	282
Phase space, 12-dimensional	347
Phi Beta Kappa, relationship of Skull & Bones to	686
Philadelphia Experiment	366
Phisohex, issues around	140
Photic Driver	307
Physicians, US Health Service Letter to	186
Physics of Frequency and Vibration, Chart of	10
Physics, Suppression of Vital Data in	309
Piaget School of Thought	309
Pineal Gland, Human, Magnetic Sensitivity of	52
Pineal Gland, relationship to geomagnetic field	49
Pineal-Pituitary Glands and radiant flow	522
Pituitary, functioning of	85
Pituitary, position of	68
Plague, Cattle	266
Planetary Biorhythm Cycles	459

# M A T R I X I I I

<u>Description</u>	<u>Page</u>
Planetary Entities	521
Plasma, Behavior of	39
Plasma. Self-Regeneration of	39
Plasmons	39
Pleiadians and Nazi Germany	367
Pleiadians, hyperspacial drive systems of	457
Pleomorphic Life Forms	163
Poindexter, Admiral	150
Polarities and Space-Time Networks	508
Polarization and Fourth Density Encroachment	469
Polarization, Positive and Negative	468
Polarizations of Third Density Consciousness	493
Polio, Anterior and Infantile Paralysis	261
Polio, Contraction from Childs Urine	216
Pons	67
Positive Alignments, Unity of Life Processes in	523
Positive and Negative Alignment, choice of	493
Positive Results From Negative Actions	532
Positive Shield, components of	538P
Posterity, instinct to survive through	70
Power, kinds of	538P
Powerlines, Electromagnetic Radiation from	291
Prana	15
Pranayama	82
Precis on the Good and the Bad	514
Premature Certainty, Concept of	103
Pribram, Carl	24
Prisoners, Drug "Testing" on	177
Prisoners, drug tests on	421A
Probability and psychological reality	490
Probable paths of conscious navigation	490
Profits, Pharmaceutical Industry	227
Progression from Tachyons to Mass	343
Project Comet, mind control effects measured in	419B
Project Derby Hat	421A
Project Dreamscan	442
Project Henhouse, Office of Naval Research and	293
Project Mindwrecker	443
Project Moonscan	442
Project Pandora	379
Project Pandora, destruction of records of	384
Project Phoenix 1, termination of	426
Project Phoenix 2, beginning of	426
Project Phoenix 2, Navy connection with	427
Project Phoenix I	321
Project Phoenix II	321
Project Rainbow, results from	437
Project River Styx	419B
Project Sanguine	292
Project Scanate	419A
Project Third Chance	421A
Projection of Responsibility	105

M A T R I X I I I

<u>Description</u>	<u>Page</u>
Projection, affectation and	106
Projection, Media Encouragement of	106
Projection, Perspectives in	105
Projections, holographic, Use By Military	45
Protein, definition of	53
Pruett, Jack	426
Psi-Corps, battles within	480
Psi-Corps, the	479
Psi-Plasma Theory of Telepathy	22
Psychic Bonding	520
Psychic driving as a Mind Control technique	155
Psychic warfare, CIA and Soviet	421D
Psychology, Future Oriented Manipulative	631A1
Psychosocial Aspects of Population, Level 1	100
Psychosocial Aspects of Population, Level 2	111
Psychosocial Aspects of Population, Level 3	116
Psychosocial Aspects of Population, Level 4	119
Pulse Carrier	296
Pulse Manifestation and Consciousness	56B
Pulse Modulation, Class D, damage caused by	371
Pulses, Atmospheric Electromagnetic	56A
Pyramid, Giza, tunnel under	460
Pyramidal Forms, Significance of Pi and Phi	315
Quanta and Consciousness	39
Quanta and Consciousness	40
Quantum biological fields	362
Quantum Mechanical Models of Long-Range Action	391
Quantum Reality, Interconnectedness of	39
Quaternion Equations	357
Quaternion notation, Maxwells use of	310
Radiant flow in Negative Orientation	523
Radio Free Europe as a Nazi Tool	552
Radionics Equipment, use of	474
Radiosonde, operation of	424
Radiosonde, operational use of	474
Radiosondes, Background and Operation of	482
Radiosondes, Nichols article on	482
Ramtha intelligence, Fifth domain structure of	475
Ramtha School, protection around	475
Rapid American Company, Heroin Importation by	631P
Rationality, Scientific, linked to brain area	73
Reagan, Ronald, mind control and	419A
Reality as A Frequency Domain	41
Reality Fields	23
Reality, Internal, Brain Localization of	44
Receiving States, Telepathic	19
Reflection and Refraction	10
Reich, Fourth, US Government as	461
Reich, Wilhelm, and respiratory blocks	65
Reich, Wilhelm, Mind Control devices of	447
Reich, Wilhelm, Mind Control work	425
Reich, Wilhelm, originator of Radiosonde	424

M A T R I X I I I

<u>Description</u>	<u>Page</u>
Reichian Programming, details on	481
Reichian School of Thought	309
Reimprinting techniques, First Brain Area	65
Relativistic Magnetics	316
Relativistic Physics, Definitions in	312
REM Sleep and Brain Function	56B
Remote Viewing	24
Reptilian Aliens, electronic support of	453
Reptilian Brain and the Medulla	62
Reptilian Brain, Bio-Survival and	64
Reptilian Brain, stimulus-response reactions	62
Resonance Between Humans and the Planet	48
Resonance Conditions in Living Systems	383
Resonance Response Rate, Chart of	11
Resonance, Sharpness of	11
Resonance, Sympathetic	7
Resonant Systems	7
Responding, process of	538J
Responses, habitual	59
Rhodes Group, the	631A1
Rhythm Entrainment and Coherency	8
Rickettsaie Group	247
Ridge implant devices	120
Ridge implant devices, types of	122
Ridge Implants, Electronic	122
Ridges, interference	121
Rothschild, Lord, Cloning concepts of	683
Rothschild, N.H., gold price fixing at	631O
Safety Standards, Electromagnetic, Hidden Data	287
Sagan, Carl, perception of human brain	73
SAGE Radar, use in Mind Control Development	426
Salmonella, Detection of	216
Sandoz, information about	280
Sarayet Maktal	631P
Saudis, bankrupted by the US	465
Scalar Wave Devices and Planetary Grid	684
Scalar Waves, propagation of	357
Scalar, definition of	313
Schneerson, Menachem	631C5
Schroder Bank, Hitlers personal account in	149
Schroeder Bank, Allen Dulles and	149
Schumann Resonance	48
Schumann waves, coincidence with Alpha rhythm	55
Schwan, Herman P	384
Science Policy Research Unit (SPRU)	631A1
Screen memories, abductees and	38
Screening of Third Density Reality	492
Second Order Electromagnetics	316
Second Order Electromagnetics and Mind Control	440
Secord, Richard	150
Security, Sensation and Power Ego Functions	104
Seeding and Fall as Propaganda	512

M A T R I X I I I

<u>Description</u>	<u>Page</u>
Seeing with the Heart	43
Seeing without focus	98
Seizures, Caused by Television Programming, case	353
Self-Knowing, levels of	538M
Senses, Fourier Transformations and	38
Sequence, Physio-Kundalini	56B
Serotonin and pineal enzymes	53
Service to Others and Service To Self	534
Sexual ties, addressing	115
Sexuality and reproduction	114
Sheldrake, Rupert	43
Sight, brain waves and	98
Sigma Peaks	323
Sirians, Negative	463
Skinner School of Thought	309
Skull and Bones, Coverup in	640
Skull and Bones, Leading Bonesmen in	612
Skull and Bones, Opium Empire and	611
Skull and Bones, Racism and	610
Skull and Bones, ties to Phi Beta Kappa of	688
Skull, Human, Sacred Geometry of	346
Sleep induction, inducement by ELF	301
Smallpox	254
Smallpox, The Gambit	166
Smith, Kline Beckman, information about	282
Social Memory Complex, advancement to	493
Social problems result of "crippled" love	529
Social Security Number, use in schools of	109
Society, supression and stability	97
Soft Drinks, effect of	140
Solar Plexus Area and Telepathy	15
Soul Memory	46
Sound Interference Properties	56C
Soviet Woodpecker Signal, functions of	338
Space-Time Electronic Function Amp Net (STEFEN)	323
Space-Time Frameworks and the Soul	507
Space-Time Laboratories	475
Spectrum, Electromagnetic, Functional	319
Spectrum, Publically Viewed, Chart on	318
Spinor, defintion of	313
Spiritual negativity	493
Spirituality, secrets of	538R
Squibb, E.E., information about	279
SS plan to control the United States	551
Stagnation, causes of	538O
Stalking and Domination	521
Standards, Electromagnetic, Military and	304
Standing Wave Mechanics	10
Standing Waves and Oscillators	7
Stanford Research Institute, Cold Fusion and	631C1
Stanford Research Institute, Project Scanate and	419A
Star Wars, planetary defense using	458

M A T R I X I I I

<u>Description</u>	<u>Page</u>
Stealth Technology	424
Sterility, relationship to ELF	301
Sterilization, Worldwide Movement for	582
Sterling Drug, information about	278
Stopping, Mental, Factor of	691
Streams, Holographic	44
Strength, barriers to	538Q
Strength, kinds of	538P
Structure, Cranial, Ionic Crystalline	348
Structured Electromagnetic Quotient Stimuli	364
Study, University of Washington, EM Radiation	289
Subconscious mind and the body	474
Subliminal Programming and the FCC	466
Subliminals, environmental	328
Suisse, Credit, gold payments to Opium producers	631O
Superluminal signals	311
Superluminary Communication Systems	480
Sympathetic Nervous System and Telepathy	20
Synchronicity	693
Synchronicity and Connections	341
Synchronicity and Psychic Phenomena	341
Syntex, information about	281
Synthetic Humans	461
Taboos, Rules, Laws, and Prohibitions	73
Tachyon-Antematter-Delton Coupling Effect	343
Tachyons, Orthodox Scientific View of	317
Takahashi, Dr. Akito	631C1
Tao, the Great	86
Tavistock Institute of Human Relations	631A1
Tejapaibul Company, Acetic Anhydride from	631O
Telepathic Activity	15
Telepathic mind-machine links	545
Telepathic Progression of the Human Race	23
Telepathic States, Induction of By Substances	18
Telepathic Work, desire for	16
Telepathic Work, Factors for Successful	21
Telepathic Work, Group	17
Telepathy and Duke University Tests	21
Telepathy and Respiration	19
Telepathy and the 6th race	444
Telepathy, Crisis	20
Telepathy, Intuitional	17
Telepathy, Mental	16
Telepathy, Theories of	22
Telepatin	18
Television Reference Signals, Videodrome Signals	326
Television transmitters in Portland Oregon	370
Telsa and the Zero-Time Generator	450
Templars, the	682
Tensor Field	313
Tensor Field Potential Activation, definition of	314
Tensor Potential	313



# M A T R I X I I I

<u>Description</u>	<u>Page</u>
Tensors, definition of	312
Tesla and the Philidelphia Experiment	433
Tesla devices, suppression of, reasons behind	519
Tesla, Colorado Springs experiments and	360
Tesla, generators at Niagra Falls	285
Thalamus, description of	70
Thalamus, detailed information on	71
The Game and the Goals	525
The IS	23
The League of German Girls	548
The Thousand Year Reich, First 50 Years of	540
Thermal Effects of EM Radiation	288
Theta rhythm, EEG	55
Theta wavefronts	346
Theta waves and Thought Propogation	340
Third Brain Structure, function of	72
Third Brain Structure, relation to NWO	73
Third Density Incarnation, object of	493
Third Density Perception of Service to Others	532
Third Density, conscious return to	535
Third Density, laws of	491
Third Density, learning framework of	535
Third Order Electromagnetics	316
Thought, Reception of, Mechanism of	346
Thymidine, quantity as a measure of mitosis	364
Tien Tai	691
Tiller, William, theories of	87
Time Barrier at 2011-2013	458
Time Dimension, isolation of	367
Time Loops	368
Time, Will and Determination	538H
Time-lock, humans locked to	436
Time-Loops, travel through	430
Time-Machine Projects	429
Time-Space Frameworks and Densities	507
Time-Travel Technology and the U.S.Navy	451
Time-Tunnel, travels to the future in	431
Time-tunnel, use of children in	430
TIR trucks, drug shipping on	631O
Tobacco, Hazards of Chemicals Added To	150
Toothbrushing, fluoride accumulation during	129
Toronto Dominion Bank	631P
Total Recall	478
Toxins and Antitoxins	271
Toxins, Important, Table of	271
Transduction, Mind-Cranium	346
Transductive Coupling in Brain Tissue	389
Transferases, DNA, RNA and ELF Waves	300
Translating Higher Density Alien Structures	517
Transverse Waves	10
Trap, implant	123
Travel, out of the body	112

# M A T R I X I I I

<u>Description</u>	<u>Page</u>
Tri-Service Project, research findings of	288
Tri-Service Research Program , evidence	376
Tri-Services Program	287
Triad, Physics of the	345
Triad, Unified Field, Chart of	350
Trizec Holdings	631P
Truth, meaning of	692
Tuberculosis, return of	204
Tuberculosis, Super Strain, Spread of	205
Tularensis	241
Tumors, melanotic, fluoride and	125
TV broadcast towers and disease, Hawaii study	294
Twistor, definition of	313
UCLA and mind control work	419A
UCLA, Neuropsychiatric Institute at	419B
UFOs and the Positive and Negative Realms	488
UHF Fields Modulated With ELF, Effects of	388
UHF Fields, Windowed Responses in Brain Tissue	388
ULF Pulses, Biological Production of	336
ULF Pulses, Electronic Production of	336
Underground tunnels, corporate	459
Unfolded Order	40
Unified Field Devices, physics of	351A
Unified Field Energy, definition of	313
Unified Field Theory and the US Government	438
Unified Field Transformations	344
Unified Field Vortex, Aspects of	335
Unified Field, definition of	313
Unified Field, Explanation of	335
Unilever, information about	282
United Fruit Company, Heroin importation by	631P
United States, Gravity Fleet of	438
Universe, Holographic Aspects of	24
University of Washington Study, results of	381
Unlove and Lack of Love	515
Useful Idiots, use by CIA as social disruptor	156
Vaccination Programs, Special Target Groups for	196
Vaccination, Febrile Illnesses and	189
Vaccination, Reportable Events following	187
Vaccinations, DPT, Side Effects and Reactions to	191
Vaccine, AIDS, Third World Tests and WHO	207
Vaccine, Influenza	168
Vaccine, Influenza, AIDS Virus in, cases of	211
Vaccine, Influenza, Side Effects and Reactions	198
Vaccine, Polio	167
Vaccine, Smallpox, Connections to Cancer	170
Vaccine, Smallpox, Denial to Civilians	199
Vaccines, Immune Globulin	188
Vaccines, Influenza, Method of Yearly Creation	192
Vaccines, Type and Availability in US	185
Valkyrie, the	307
Vector Analysis, introduction by Heaviside of	310

M A T R I X I I I

<u>Description</u>	<u>Page</u>
Velsicol, information about	282
Ventricles, diagram of	68
VHF Fields, Windowed Responses in Brain Tissue	388
Vibratory Rate, Nuclear	56B
Videodrome signal, evaluation of	331
Viet-Cong prisoners, experiments on	421B
Viral Diseases of Man, Table of	268
Virtual Plasma Model	358
Virtual reality, new theatres featuring	354A
Viruses, Diseases in Man	254
Viruses, Drug-Resistant, Development of	197
Viruses, Nature of	254
Viruses, Polio, Outbreak in Jordan 1992	216
Vision, inner	85
VLF Fields, Natural	48
Void Mind	523
Void, structure emerging out of	64
Void-Being as true continuity of Identity	530
Void-Nature as a Functional Reality	493
Void-nature as screened from 3rd Density reality	492
Voidness and Self-hood	524
Volcker, Paul	281
Von Neumann, John	368
Von Neumann, John, and the Philadelphia Project	424
Von Neumann, John, education of	433
Von Neumann, John, investigation of Aztec crash	436
Von Neumann, John, mathematics developed by	434
Waking up to levels of Realization	537
Water, Cellular, State of Maximum Order	52
Water, fluoride-treated, Congressmen avoid	128
Water, frequency memory of, and Homeopathy	56
Water, helical structure of	55
Water, Memory of	55
Water, Nitrates and	158
Water, Non-Hertzian Field charging of	365
Water, role in Non-Hertzian biological effects	361
Water, Treatment with Chlorine Compounds	135
Water, Treatment with Fluorides	124
Wave Mechanics	10
Wave, Amplitude Modulating	296
Wave, Analog Modulating	296
Wave, Frequency Modulating	296
Wave, Probability	96
Wave, Pulse-Amplitude Modulating	296
Weak Field Interactions in Tissue	390
Wertheimer, Nancy	292
West, Dr. Louis	419A
Will and its expression in manifestation	531
Will and the volitional axis	505
Will as a principle of creative patterning	531
Will as the Functional Presence of Consciousness	530
Will, False	531

# M A T R I X I I I

<u>Description</u>	<u>Page</u>
Words of Power	320
World Conquest and Domination and Planetary Grid	684
World Psychiatric Foundation	155
World War II as a Race War	541
Wu-Wei, concept of	691
X Disease, Australian	263
Yellow Fever	264
Zero-Point Energy, source of	358
Zero-point vaccum energy	312

