

BRITISH MUSEUM

HIEROGLYPHIC TEXTS

FROM

EGYPTIAN STELAE, etc.

PART VIII

EDITED BY

I. E. S. EDWARDS, M.A.

*Assistant Keeper in the Department of Egyptian and Assyrian Antiquities*

PRINTED BY ORDER OF THE TRUSTEES  
THE BRITISH MUSEUM

1939

HARRISON AND SONS, LTD.  
PRINTERS TO HIS MAJESTY THE KING  
44-47, ST. MARTIN'S LANE, LONDON, W.C.2

## PREFACE

The eighth part of this series contains fifty half-tone plates, illustrating hieroglyphic texts on statues, stelae, stone sarcophagi, offering tables and a pyramidion, together with an introductory description which gives the texts in the printed characters. This method of publication replaces the reproduction of drawings and hand copies employed in Parts I–VII.

The monuments from which these texts have been taken are either dated specifically, by reference in the text or by excavations, to the time of the XVIIIth Dynasty or can be assigned, on the grounds of style and epigraphy, to the time of the New Kingdom. The texts of historical importance are the inscriptions of Kames and Sennefer in the reign of Thothmes III (Plates IV–V), Ámenhetep in the reign of Thothmes IV (Plate IX), Ámenhetep III (Plate XIV), Merimes, viceroy of Nubia in the reign of Ámenhetep III (Plate XX), and other officers of that Pharaoh (Plates XI–XIII), Tutánkhâmen (Plate XV), H̄eremheb (Plates XXVII–XXVIII). Exceptional interest for the study of religion attaches to the stele of H̄er and Suty (Plate XXI), frequently translated, of which a corrected text is here presented, to the statuette of Ámenemheb (Plate XXX), in which the deceased harpist is presented playing his instrument to the words of the hymn to the sun inscribed below, to the stele of Mery-Ámen (Plate XXXI), which shows Ámen in the forms of ram and goose, and to the stele of Thothmes (Plate XXXIX), which contains an unusually elaborate prayer for blessings in the next world.

The description of the plates has been written by Mr. I. E. S. Edwards, Assistant Keeper in the Department.

SIDNEY SMITH.

DEPARTMENT OF EGYPTIAN AND ASSYRIAN ANTIQUITIES.

*February 7th, 1939.*

## SIGNS AND ABBREVIATIONS

	..	..	..	..	Signs or groups of signs so marked are restorations of obscure or partly destroyed text in the original.
[ ]	..	..	..	..	Signs or groups of signs so marked are completely destroyed in the original.
( )	..	..	..	..	Signs or groups of signs so marked are written once only in the original, but are to be read with each of two contiguous inscriptions.
(←)	←..	..	..	..	Texts or signs so marked read from right to left in the original.
(→)	→..	..	..	..	Texts or signs so marked read from left to right in the original.
<i>Ann. Arch. Anthr.</i>	..	..	..	..	University of Liverpool, <i>Annals of Archaeology and Anthropology</i> , 1908 —.
<i>Ä.Z.</i>	..	..	..	..	<i>Zeitschrift für aegyptische Sprache und Altertumskunde</i> , 1863 —.
<i>B.M.Q.</i>	..	..	..	..	<i>British Museum Quarterly</i> , 1926 —.
BUDGE, <i>Egyptian Sculptures</i>	..	..	..	..	E. A. WALLIS BUDGE, <i>Egyptian Sculptures in the British Museum</i> , 1914.
BUDGE, <i>Sculpture Guide</i>	..	..	..	..	British Museum, <i>A Guide to the Egyptian Galleries (Sculpture)</i> , 1909.
HALL, <i>Introductory Guide</i>	..	..	..	..	<i>A General Introductory Guide to the Egyptian Collections in the British Museum</i> , 1920.
<i>J.E.A.</i>	..	..	..	..	<i>Journal of Egyptian Archaeology</i> , 1914 —.
<i>P.S.B.A.</i>	..	..	..	..	<i>Proceedings of the Society of Biblical Archaeology</i> 1878–1918.
<i>Rec. de Trav.</i>	..	..	..	..	<i>Recueil de Travaux relatifs à la Philologie et à l'Archéologie égyptiennes et assyriennes</i> , 1870–1923.
<i>T.R.S.L.</i>	..	..	..	..	<i>Transactions of the Royal Society of Literature</i> , 1827 —.
<i>T.S.B.A.</i>	..	..	..	..	<i>Transactions of the Society of Biblical Archaeology</i> , 1872–86.





On each side of the spout is incised a kneeling figure with hands uplifted in an attitude of adoration.









*Preservation.* The edges of the upper surface are slightly chipped. The placing of the figure on the right-hand side nearer to the spout than that on the left suggests that the block was broken before use.
































BUDGE, *Sculpture Guide*, p. 99; HALL, *Introductory Guide*, p. 336.




























## PLATE II

No. 1708

Fragment of a lintel. Limestone. Length 2 m. 17 cm. Height 48 cm. From the Bucheum, Armant. Reign of Āāḥmes I. Presented by Sir Robert Mond through the Egypt Exploration Society, 1929.

The fragment, carved in sunk relief, is divided into two parallel scenes separated by a vertical column of inscription<sup>1</sup> (←)  (sic)       . The inscriptions throughout are incised.

On the right: The god Menthu receives offerings from King Āāḥmes I. The god, who is seated on a throne  is falcon-headed and wears a long wig surmounted by a disk and two uraei, a bead collar and a short skirt with tail. In his right hand he holds  and in his left a sceptre . In front of him is inscribed vertically: (←)    . The king, wearing the crown of Lower Egypt, a bead collar and short stiffened skirt (?), bears in each hand a bowl of offerings. Above him is an inscription in two vertical columns: (→)      . Beneath the hands is an inscription in one vertical column: (→)    . Behind the king is a pillar, terminating in a papyrus flower, around which is entwined a serpent with  and . Behind the serpent are the signs . At the sides of the pillar is inscribed vertically: (←)  (→)   . On the right margin is inscribed, in one vertical column: (→)        .


On the left: The figures of both the god and the kings are represented as in the right-hand scene, except that the objects  and  which the god holds are in the opposite hands, and the king wears the crown of Upper Egypt. In front of the god is inscribed, in one vertical column: (→)      . Above the king is inscribed: (←)        . Beneath his hands is inscribed, in one vertical column: (←)    . Behind the king is a pillar, similar to the one in the right-hand scene, but with lily capital surmounted by a vulture with  and  placed on the sign . At the sides of the pillar is inscribed vertically: (←)  (→)   . On the left-hand margin is the same inscription as on the right, but written in the reverse direction (←).

*Preservation.* The fragment consists of three pieces, of which the two on the left-hand side join. Between them and the third piece there is a small lacuna.<sup>2</sup> At the top and bottom portions of the stone have been cut away in antiquity.

GLANVILLE, *B.M.Q.* IV, p. 77 (Pl. XLVIII); MOND and MYERS, *The Bucheum*, II, p. 50 (Pl. III, LIV, 1); PORTER and MOSS, *Topographical Bibliography*, V, p. 159.

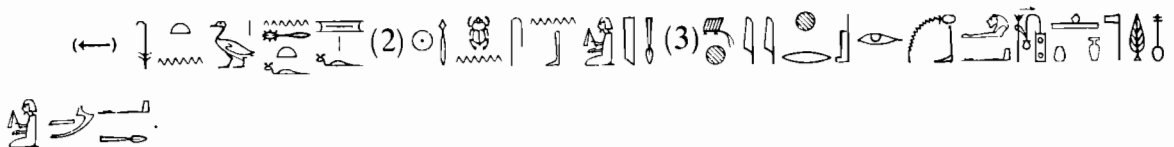
<sup>1</sup> Another parallel column of inscription may originally have been carved, but is now missing.

<sup>2</sup> If the lacuna included a column of inscription as suggested, above (n. 1), a larger space should be allowed between the two fragments.

Lower portion of a seated statuette of  Aam-nefer (*ism-nfr*). Grey granite. Height 46 cm. Width 20.5 cm. Provenance unknown. Reign of Thothmes II (?).

The inscriptions are incised on the front of the long garment of the figure and on the back and sides of the chair.

Front inscription, in two horizontal lines and one vertical :



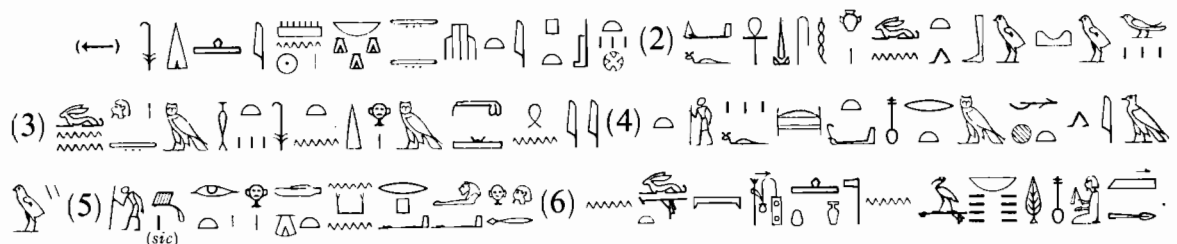
On back of chair, in one vertical column :



On left side of chair, in six vertical columns :



On right side of chair, in six vertical columns :




*Preservation.* Only the lower portion of the body from the waist downwards, the seat and pedestal remain. Apart from minor abrasions, the fragment is well preserved.

*B.M.Q.*, XI, p. 191.

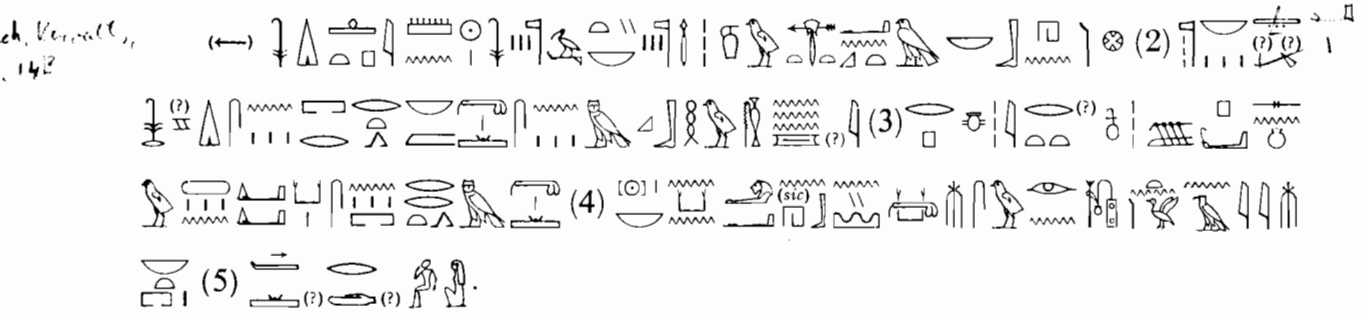
## PLATE IV

No. 1022

Fragment of a statuette of  Ka-mesu (*ks-msw*). Grey granite. Height 44.5 cm. Width 25 cm. From Buhen. Reign of Hatshepsut or Thothmes III. Presented by Major-Gen. Sir C. Holled Smith, K.C.M.G., 1887.

The statuette, mounted on a pedestal, is in a squatting position, with right leg crossed under the body and left bent sharply at the knee. The figure wears a short skirt and a garment with sleeves, and over the left shoulder is slung a scribe's outfit, with palette in front and water-bowl and reed-holder behind. A partly-opened roll of papyrus, held in the left hand, rests on the left knee and extends over the lap, passing under the right hand to the side of the skirt. On the papyrus

is an inscription incised in five horizontal lines, beginning at the end nearest to the roll.



*Preservation.* The head and neck are missing and the left hand, which holds the papyrus roll, is badly mutilated. Small abrasions have occurred all over the figure, and the text on the roll is much weathered.

BUDGE, *Sculpture Guide*, p. 127; *The Egyptian Sudan*, I, facing p. 578; WIEDEMANN, *Rec. de Trav.* XVII (1895), pp. 6-7.

No. 1019

Door-jamb. Sandstone. Height 1.5 m. Width 32 cm. Depth 22 cm. From the Temple of Thothmes III at Buhen.

Incised on the front, in one vertical column :



*Preservation.* The monument has been reassembled from the two pieces into which it was broken. Small portions have been broken off from the top and sides, but the text, although slightly weathered, remains legible throughout.

BUDGE, *Sculpture Guide*, p. 106; ID., *The Egyptian Sudan*, I, p. 584; WIEDEMANN, *Rec. de Trav.*, XVII (1895), p. 6.

PLATE V

No. 48

Statuette of  $\frac{1}{2}$  Sen-nefer (*sn-nfr*). Black granite. Height 87 cm. Width 37 cm. From behind the Colossi at Thebes. Reign of Hatshepsut or Thothmes III. Salt Collection.

The figure, wearing a long wig, short beard and long garment, is represented in a squatting position on a pedestal, with arms crossed over the knees. The text is incised in fourteen horizontal lines on the front of the dress, in two vertical columns, one on each side of the upper surface of the pedestal, and in five horizontal lines on the front of the pedestal.









*Preservation.* The top of one side is broken off to a maximum depth of 12·5 cm. and the lower part of the monument, including the feet of all six figures, is missing. Both the figures of the king are headless, and on each figure of the god mortices have been cut into the shoulders for an unknown purpose. The inscriptions accompanying the figures are carved on a sunken surface, which indicates that earlier inscriptions have been deleted.

ARUNDALE and BONOMI, *Gallery of Antiquities*, p. 81 (Pl. 34); BARNETT, *Iraq* II, pp. 187-8 (Pl. XXIII, 1); BUDGE, *Sculpture Guide*, p. 105; PRISSE, *Revue archéologique*, III, pp. 701-2.

## PLATE VII

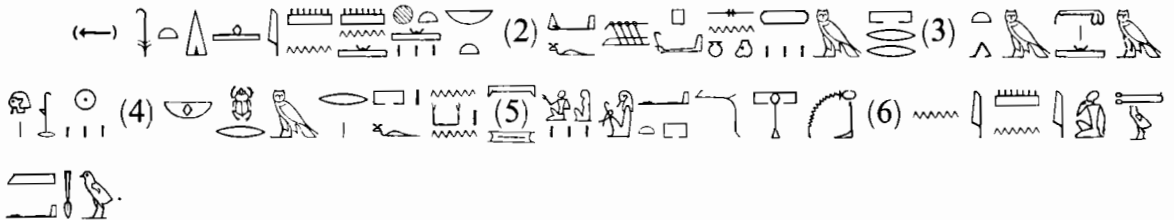
No. 31


Seated statuettes of  Áthu (*itw*) and  Henut-urt (*hnwt-wrt*). Sandstone.  
Height 78 cm. Width 32 cm. Provenance unknown. Reign of Amenhetep II.

The figures are represented seated, each with one arm on the far shoulder of the other, on a high-backed chair. Between them and reaching to the level of their knees is a figure of their son.  wears a long braided wig, short beard, bead collar, long skirt and sandals. In his left hand, which rests on his lap, he holds a folded cloth.  wears a long braided wig, bead collar and long tight-fitting dress. In her left hand she holds a lotus flower and two buds.

The monument is inscribed on the sides of the seat, on the skirts of the two figures and on the pedestal in front of the small figure of their son.

On the seat by the side of , incised in six vertical columns :




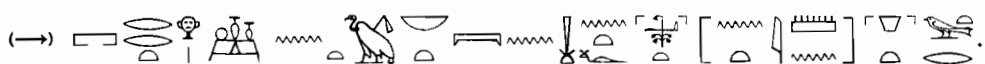
On the skirt of , incised in one vertical column :




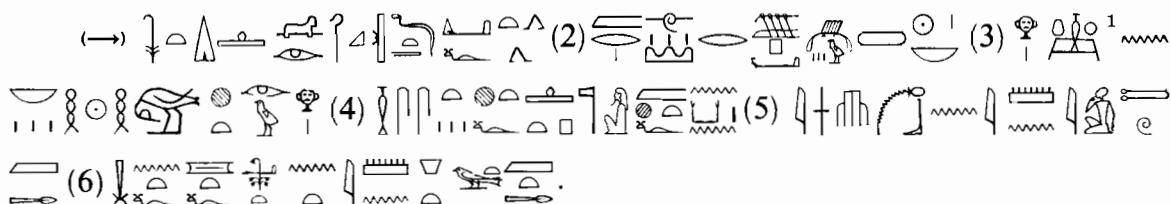
On the pedestal in front of the figure of the son, incised in one vertical and one horizontal line :





On the skirt of , incised in one vertical column :



On the seat by the side of , incised in six vertical columns:





*Preservation.* Apart from the erasure of  from the skirt inscriptions (but not from those on the seat) and a mutilation at the beginning of the skirt inscription on the figure of , the text is undamaged. Traces of black on the wigs of both figures, blue in the skirt inscriptions and red in the dividing lines of the seat inscriptions are visible.

ARUNDALE and BONOMI, *Gallery of Antiquities*, p. 120 (Pl. 52); BUDGE, *Egyptian Sculptures*, p. 13 (Pl. XX); ID., *Sculpture Guide*, p. 109.

## PLATE VIII

No. 113

Statue-group of  Sen-nefer (*sn-nfr*) and  Sent-nay (*snt-nay*). Black granite. Height 50·5 cm. Width 58·5 cm. From Thebes. Reign of Amenhetep II.

Four figures, two male and two female, are seated arm-in-arm on a long chair mounted on a pedestal, the whole group being carved in one piece. On the right side of the chair a female figure, wearing a long wig and a long tight-fitting dress and holding a lotus flower in her right hand, is carved in slightly sunk relief. The inscriptions are incised in one vertical column on the front of the long skirt worn by each seated figure, and in one vertical column in front of and in three vertical columns behind the figure on the right side of the chair.

First figure<sup>2</sup>:



Second figure:



Third figure:



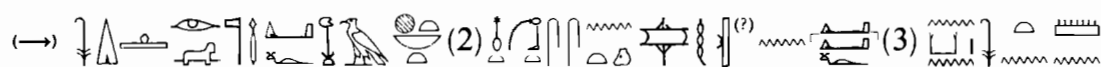
Fourth figure:





In front of side figure:



Behind side figure:



<sup>1</sup> The sign in the original is composed of  and  upon a stand.

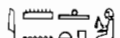
<sup>2</sup> Numbered from left to right.



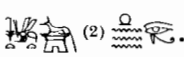
*Preservation.* The heads of all the figures are missing and the upper portion and back right-hand corner of the seat are badly mutilated. Minor abrasions have occurred throughout.









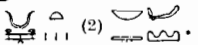
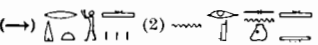



BUDGE, *Sculpture Guide*, p. 187; NEWBERRY, *P.S.B.A.*, XXII, pp. 59-60; PORTER and MOSS, *Topographical Bibliography*, I, pp. 125-7.






## PLATE IX

No. 902





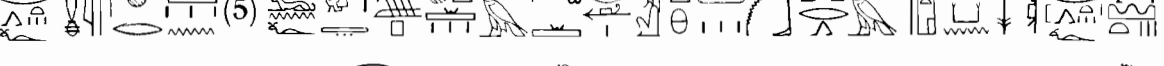
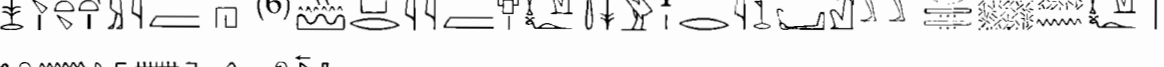
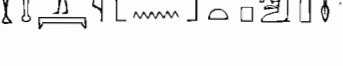
Round-topped stele of  Amen-hotep (*imn-hotp*). Limestone. Height 85 cm. Width 57·5 cm. Provenance unknown. Reign of Thothmes IV.

THREE REGISTERS. In the arch, carved in low relief, is the winged disk, with pendent uraei wearing the crowns of Upper (left) and Lower Egypt (right). Beneath the disk, written vertically between the uraei: ; beneath the right wing, written vertically: (→) ; and horizontally in two lines: (→) . The same inscriptions are repeated under the left wing, but in the reverse direction (←).

FIRST REGISTER: In the centre, carved in low relief, is a shrine, on the cornice of which are sixteen uraei, nine facing to the left and seven to the right, surmounted by solar disks. Within the shrine are figures of the gods Osiris and Wepwawet, seated on thrones , back to back. Osiris is represented in mummy form, wearing the crown of Upper Egypt, beard, bead collar and counter-poise, and holding in the hands , , , and . Above the figure, incised in two vertical columns: (←) . Wepwawet is represented with jackal's head, wearing a bead collar and a short skirt with tail and holding  in the right hand and  in the left. Above the figure, incised in two vertical columns: (→) . Outside the shrine on the right side, carved in low relief, stands a figure of the deceased clad in a tight cap, a bead collar, short skirt and leopard-skin, adoring Osiris. Above the deceased, incised in four vertical columns: (→)  (3)  (4)  [  ].

On the left another figure of the deceased, similarly carved and attired, stands adoring Wepwawet. Above the deceased, incised in four vertical columns: (←)  (2)  (3)  (4)  [  ].

SECOND REGISTER: An inscription, incised in six horizontal lines:

(←)  (2)  (3)  (4)  (5)  (6)  

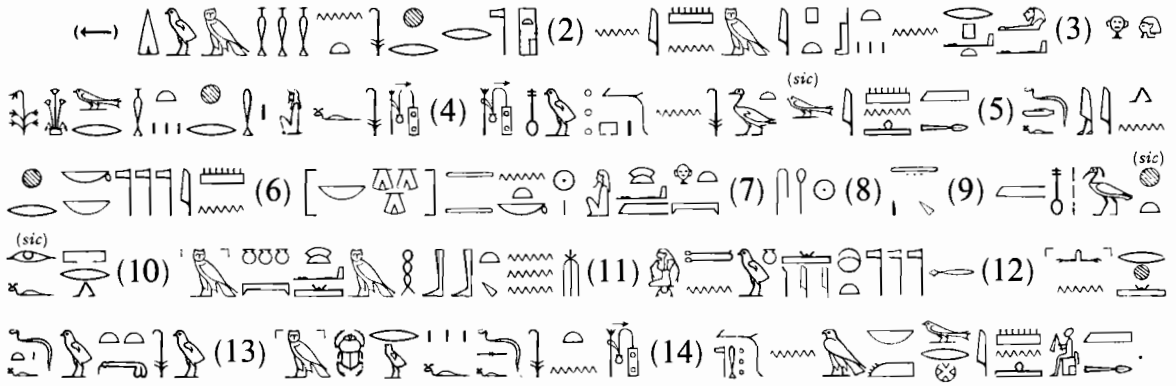




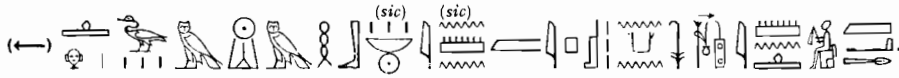




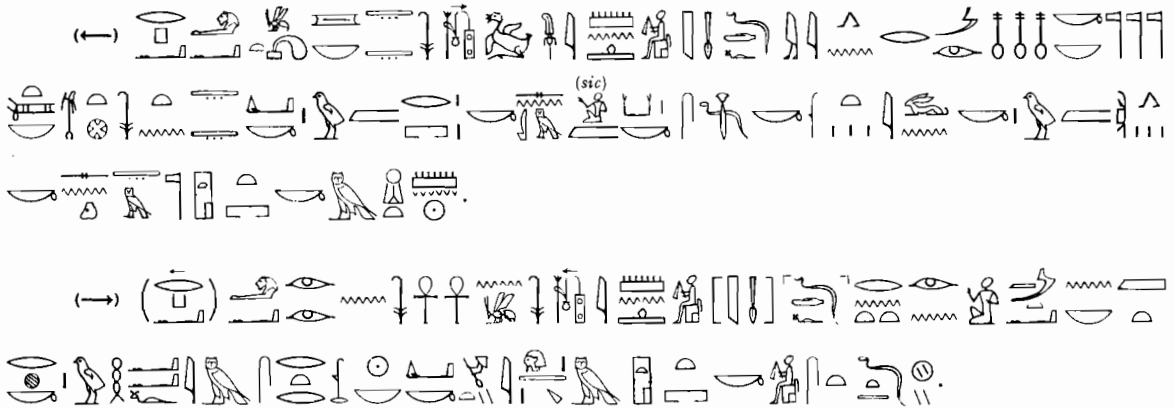
On the papyrus roll, in fourteen vertical columns:



On the upper surface of the pedestal, in one horizontal line:



On the front, sides and back of the pedestal, in one horizontal line reading in both directions from the centre of the front to the centre of the back:




**Preservation.** The entire body is missing, with the exception of the legs and mutilated remains of the hands. The text throughout, apart from slight abrasions, is well preserved.

*The British Museum; Egyptian Antiquities, II, pp. 30-1 (The Library of Entertaining Knowledge); BUDGE, Sculpture Guide, p. 154; GLANVILLE, J.E.A., XV, pp. 2-5 (Pl. II, Fig. 2).*

PLATE XIII

No. 1210

Statuette of  Ka-mes (*ka-ms*). Grey granite. Height 58.5 cm. Width 26 cm. Provenance unknown. Reign of Amenhetep III.


The figure is represented in a squatting position, bearded and wearing a long garment reaching to the ankles. The hands are crossed upon the knees, and in the right hand is a lotus flower. The inscriptions are incised on the front of the right arm, on the lower part of the garment in front of the legs and on the back support.



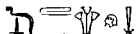
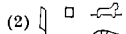


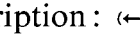


On the right arm, in one vertical column:







Inner coffin of  Mery-mes (*mry-ms*). Grey granite. Length 1 m. 96 cm. Maximum width 60 cm. Depth 60 cm. From Semneh. Reign of Amen-hotep III.

The coffin, which is anthropoid in shape, is decorated on the outside with figures and inscriptions carved in low relief. On the lid the deceased is represented wearing a long braided wig, short beard, and a bead collar with falcon-head terminals. On the left side beneath the collar are the two eyes, . A figure of Nut, kneeling with arms and wings outstretched, spans the chest. On the crown of the head Nephthys, with arms uplifted, kneels on the sign . In front of and behind her is carved an inscription in three vertical columns, (←)  (2)   (3) . Beneath the feet is a figure of Isis, standing with arms uplifted between two vertical columns of inscription: (←)   (2) . On the lid inscriptions are carved in vertical and horizontal bands (the latter being continued on the lower section) to represent the principal bandages, as shown in Fig. 1. On the lower section, in addition to the continuation of the horizontal bands, are figures of gods, each accompanied by an inscription.

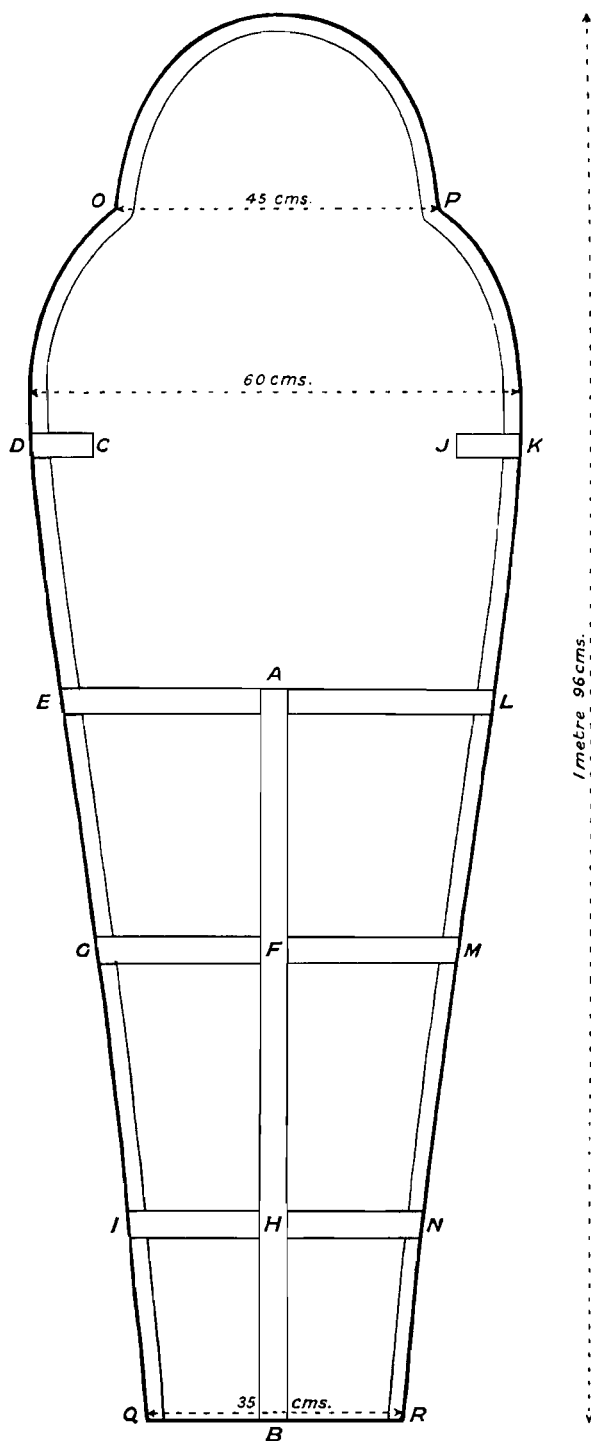









FIG. 1.—COFFIN. NO. 1001. LID

The lid (see Fig. 1):

A-B (←)     
 C-D (←)  (on base)    
 A-E (→)  (on base)    






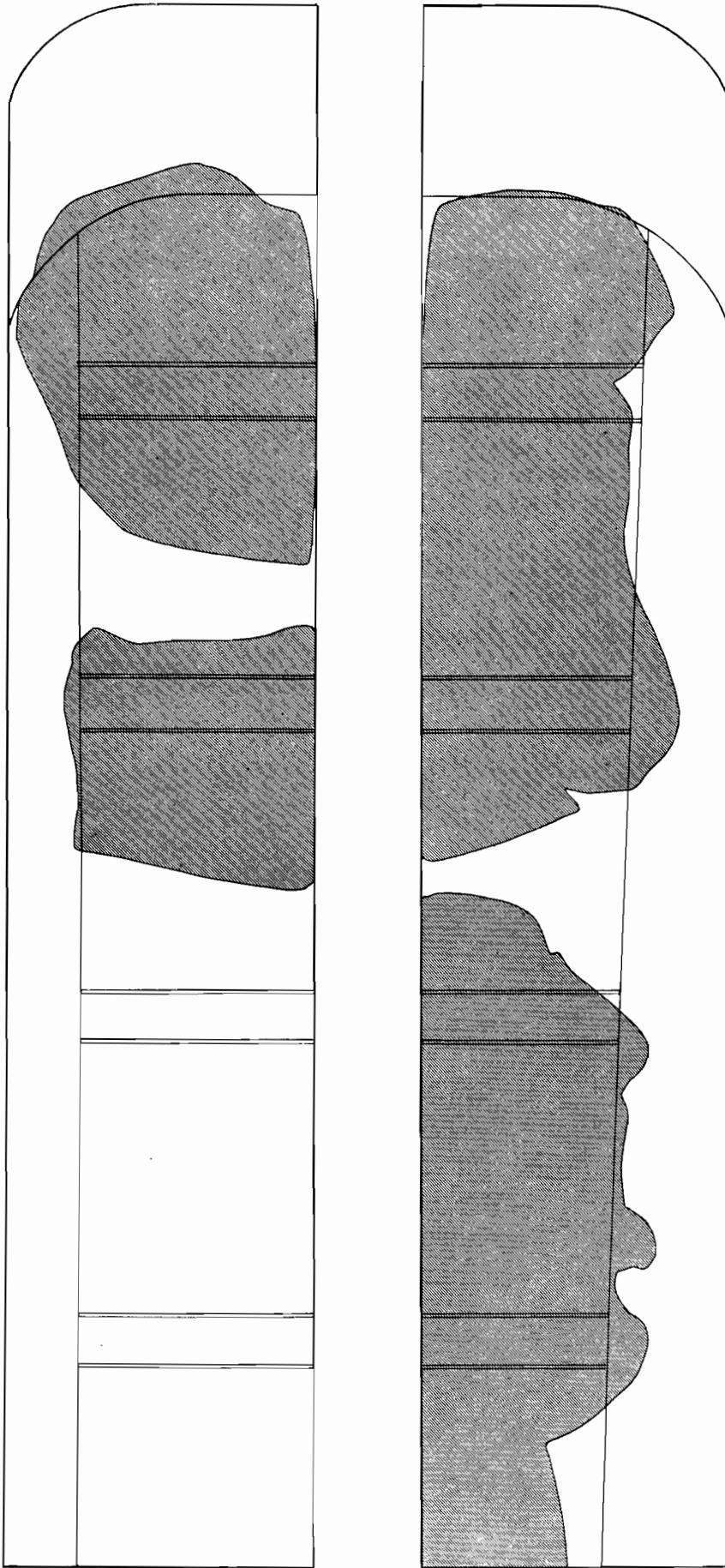


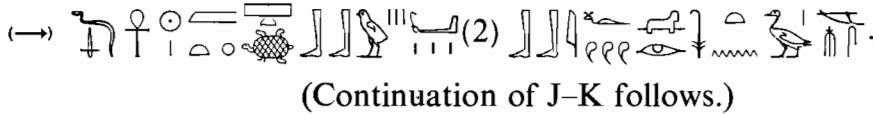
FIG. 2.—COFFIN. No. 1001. Lower section.

Third division.—The three vertical columns of inscription which preceded the figure of Anubis are preserved :



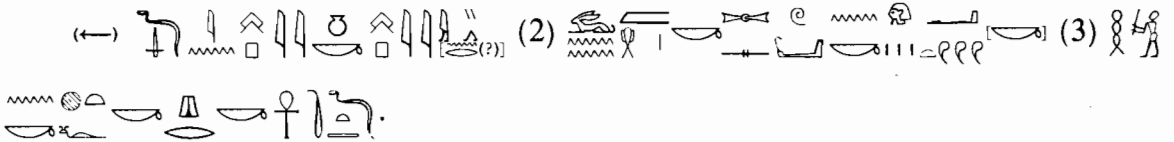
LEFT SIDE :

First division.—In front of a figure of Thoth is inscribed in two vertical columns :



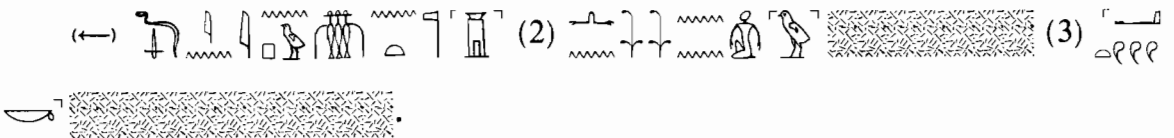
(Continuation of J-K follows.)

Second division.—In front of a figure of Hapi is inscribed in three vertical columns :



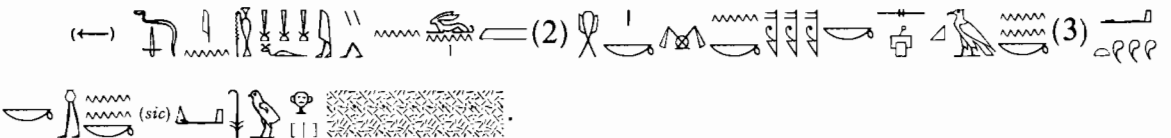
(Continuation of A-L follows.)

Third division.—In front of a figure of Anubis is inscribed in three vertical columns :



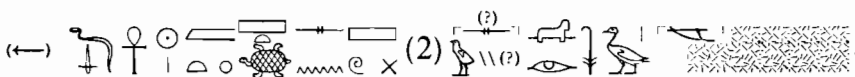
(Continuation of F-M follows.)

Fourth division.—In front of a figure of Qebehsenuf is inscribed in three vertical columns :



(Continuation of H-N follows.)

Fifth division.—In front of a figure of Thoth is inscribed in two vertical columns :



*Preservation.*—The coffin has been reassembled from the numerous pieces into which it was broken. The lid is almost complete, but considerable portions of the lower section are missing.

BUDGE, *Sculpture Guide*, pp. 117-8.

<sup>1</sup> The formation of the sign in the original is very exceptional (see Plate XVII).

Fragments of the outer coffin of the same person. Grey granite.

The pattern and style of carving of the outer coffin correspond exactly with those of the inner. Only six fragments, two from the lid and four from the lower section, have been preserved (see Fig. 3).

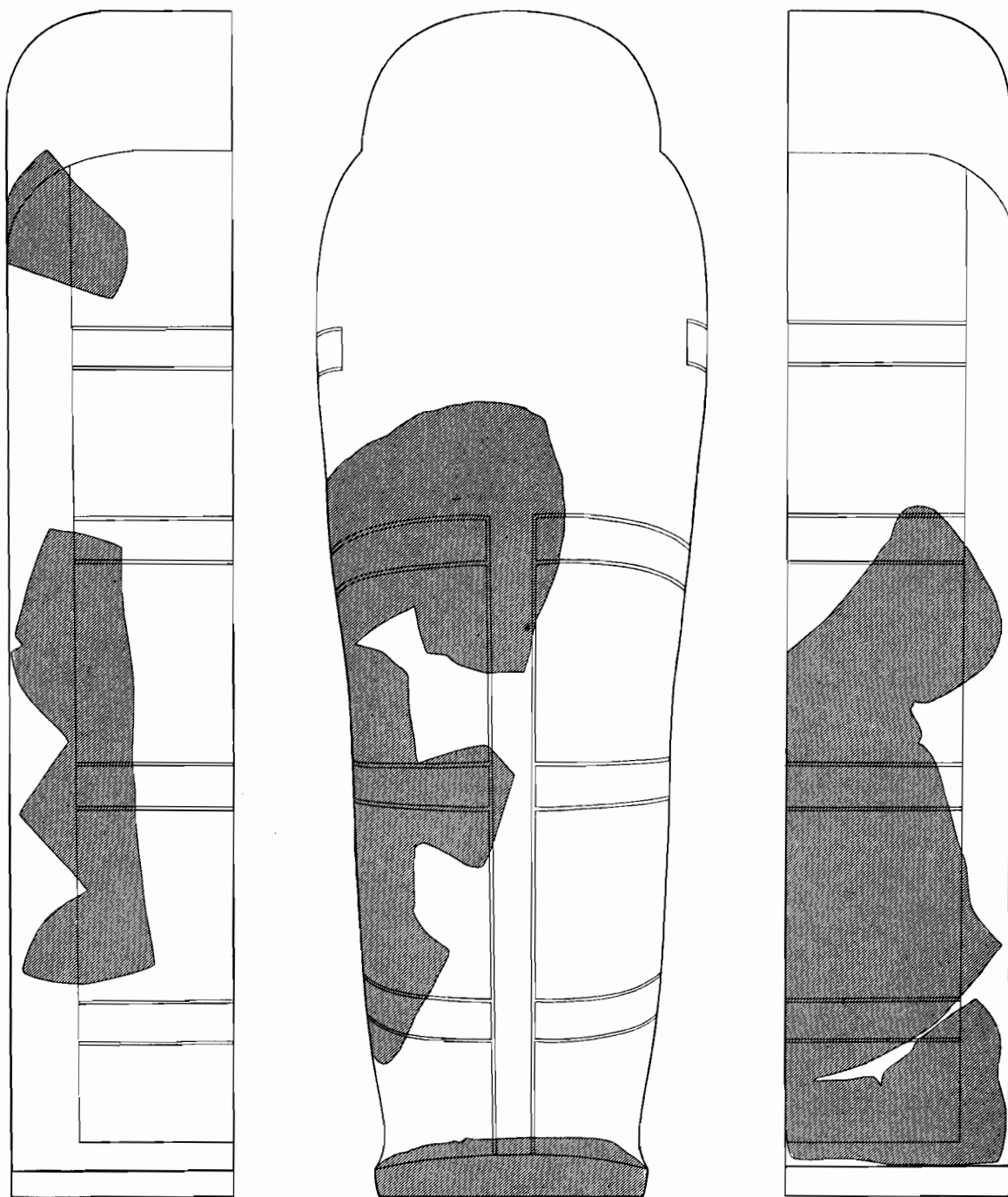


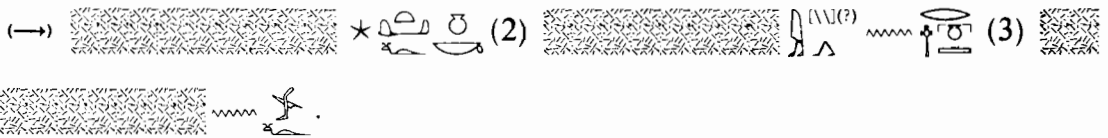
FIG. 3.—COFFIN. No. 1001A.

THE LID :

Fragment No. 1.—A portion of the right side, containing part of a figure of Nut kneeling with arms and wings outstretched, and parts of the vertical and



## Fourth division :

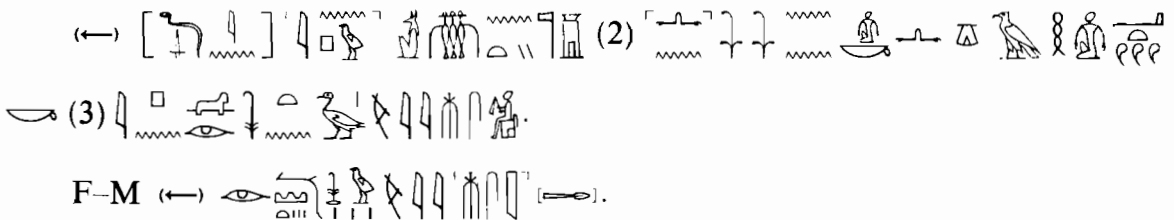


## LEFT SIDE :

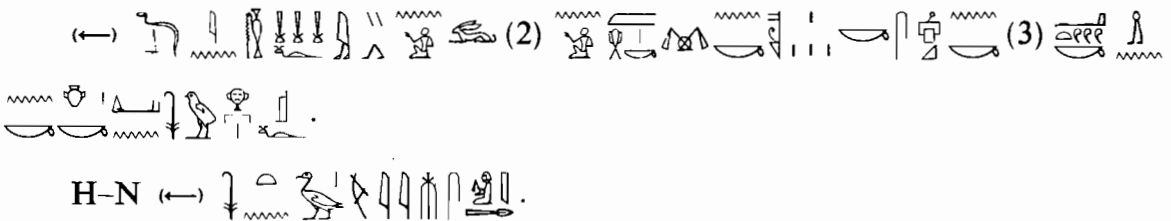
Almost the whole of the side, from the continuation of A-L which precedes Division 3 to the figure of Thoth at the foot, has been preserved. Length 1 m. 13·5 cm.



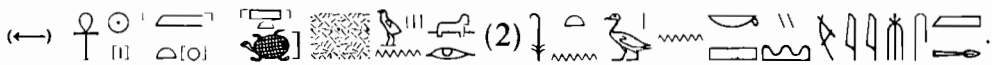
Third division.—Three vertical columns of inscription precede a figure of Anubis :



Fourth division.—Three vertical columns of inscription precede a figure of Qebḥsenuf :



Fifth division.—Two vertical columns of inscription precede a figure of Thoth :



The sixth fragment, on which is carved a large ♀, formed the end of the lower section of the coffin.

*Preservation.* All the fragments have been reassembled from the numerous pieces into which they were broken.

Fragment of a stele of ♀ Mery-mes (*mry-ms*). Sandstone. Height 82 cm. Width 90 cm. From Semneh. Reign of Amenḥetep III. Presented by Lord Prudhoe, 1835.

An inscription is incised in thirteen horizontal lines:







*Preservation.*—Several lines from the beginning of the inscription are missing and the whole of the upper portion is badly mutilated and weathered. The greater part of the last half of the sixth and seventh lines is destroyed and the ends of many others are damaged.

BIRCH, *Archaeologia*, XXXIV, facing p. 388; ID., *Archaeological Journal*, VIII, p. 399; BREASTED, *Ancient Records*, II, pp. 340-2; BUDGE, *Sculpture Guide*, p. 115; GAUTHIER, *Dictionnaire Géographique*, I, p. 64; III, p. 14; VI, p. 25; ID., *Le Livre des Rois*, II, p. 308, n. 1; HALL, *Introductory Guide*, p. 350; LÉVY, *Rec. de Trav.*, XV (1893), pp. 171-2. *Uch*<sup>1</sup>, 1651-63;

## PLATE XXI

No. 826

Stele, in the form of a door, of   Her (*hr*) and   Suty (*swty*). Grey granite. Height 1.44 m. Width 88 cm. Provenance unknown. Reign of Amenhetep III. Anastasi collection.

<sup>1</sup> In the original the lion's head is surmounted by a disk.

A round-topped stele is carved within the rectangular framework of the door. The inscriptions throughout are incised and the figures carved in sunk relief.

The door.—On the lintel, in three horizontal lines reading from the centre outwards:

(→) (1)

(2)

(3)

(←) (1)

(2)

(3)

On the right side, in three vertical lines:

(→) (1)

(2)

(3)






At the base of the right panel above a figure of seated at a table of offerings (almost entirely obliterated), in four (?) vertical lines: (→) (2) (3) (4)


On the left side, in three vertical lines :

(←) (1)





















(2)

(3)

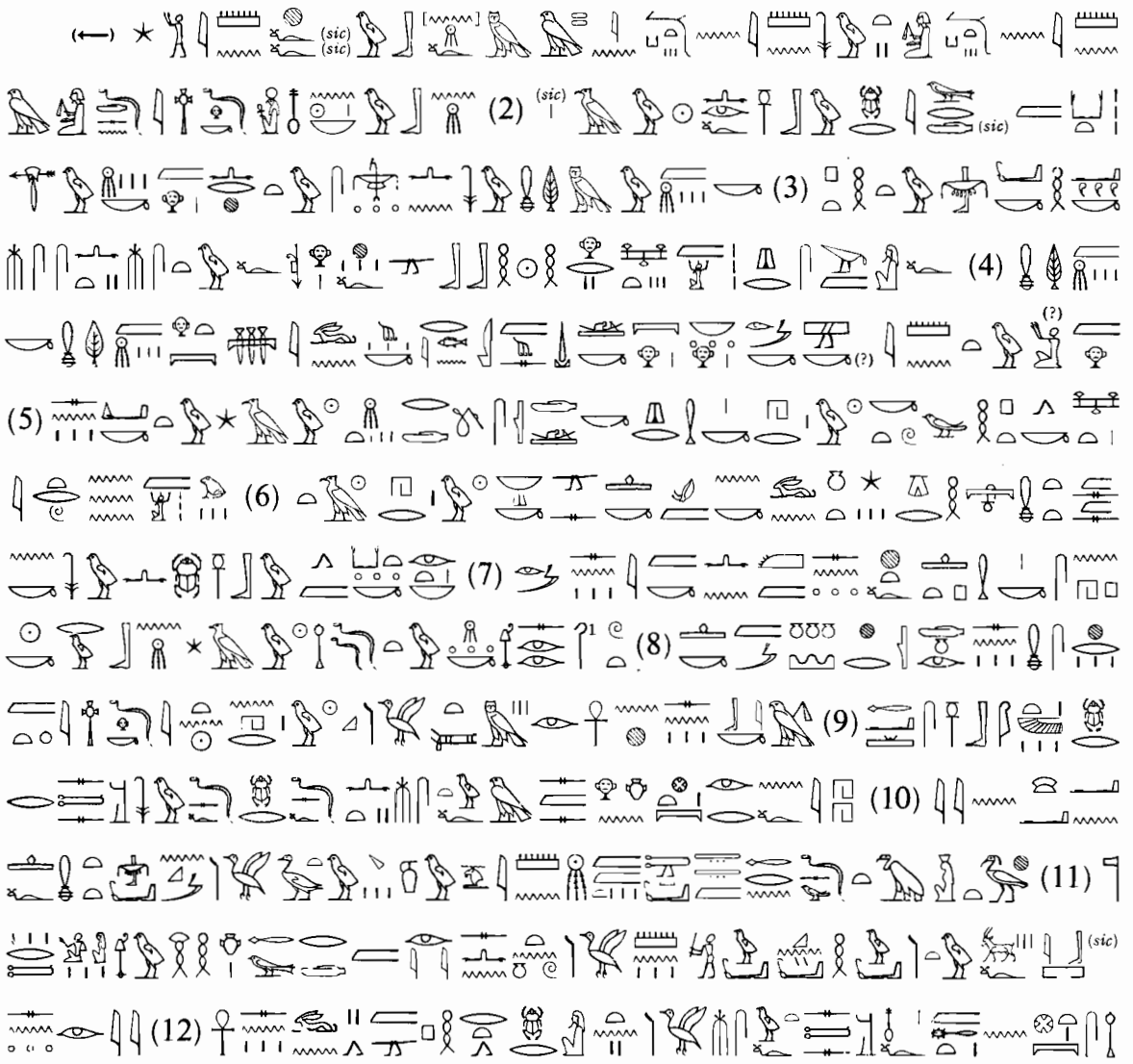
At the base of the left panel above a figure of , seated at a table of offerings (almost entirely obliterated), in four vertical lines: (←)  (2)  (3)  (4) .

The stele.—On the right and left of the top of the arch, in the angle formed by the frame of the door: .

Two registers. In the arch of the stele is the winged disk.

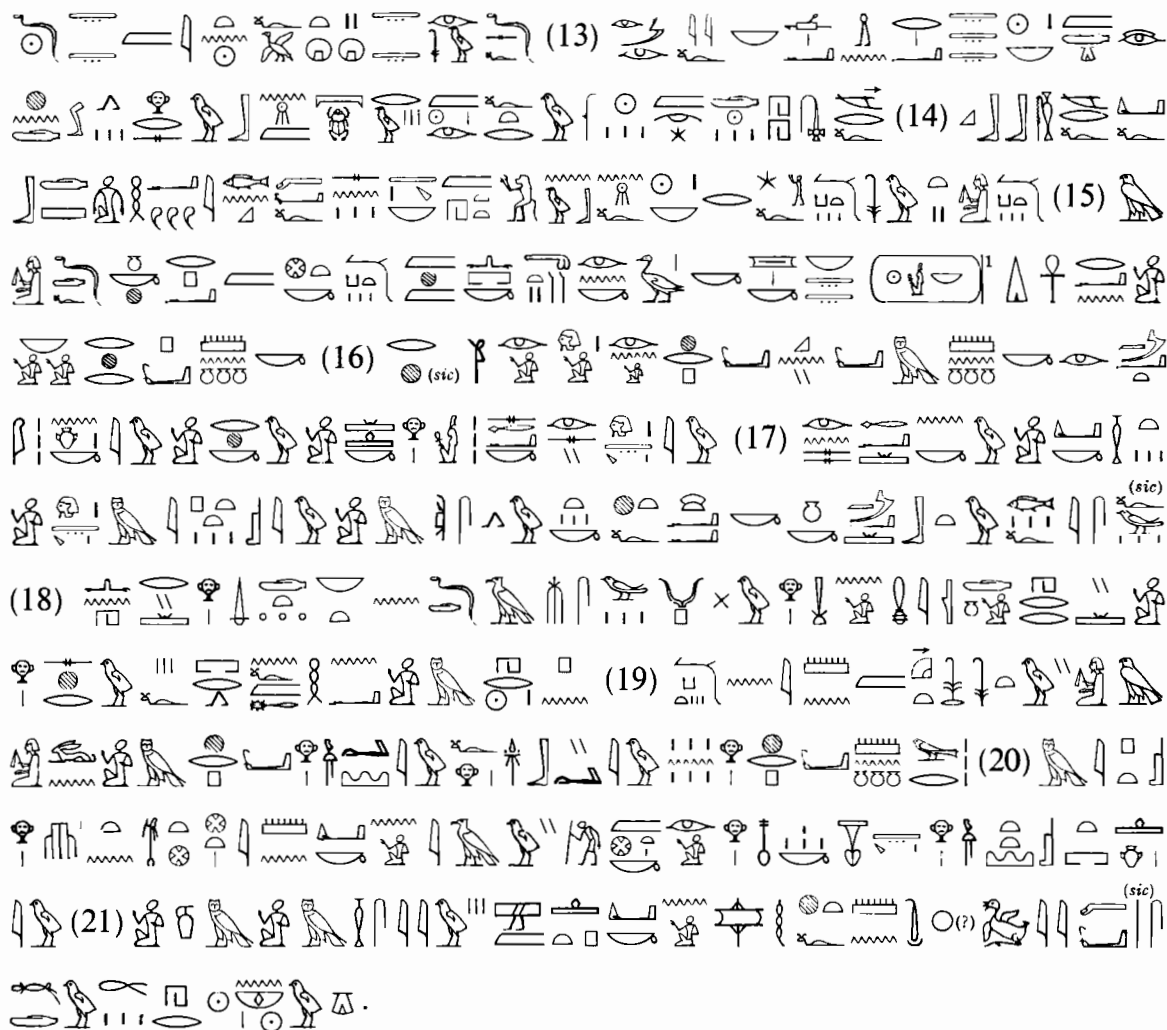
FIRST REGISTER, divided into two symmetrical scenes : On the right Anubis, shown with jackal's head, wearing a short skirt and holding  a sceptre in the left hand and  in the right, is adored by  and a woman (both almost entirely obliterated). Above Anubis, in two vertical columns : (←)  (2) . Above  and the woman, in four vertical columns: (→)  (2)  (3)  (1) . On the left Osiris, shown in mummy form, wearing , beard, necklace and counterpoise, and holding a sceptre  in his hands, is adored by  and a woman (both obliterated). Above Osiris, in two vertical columns: (→)  (sic) (2)  (sic). Above  and the woman, in four vertical columns, (←)  (2)  (3)  (4) .


SECOND REGISTER. An inscription in twenty-one horizontal lines :



<sup>1</sup> The sign in the original is the crook without the backward curve.



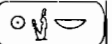


**Preservation.** The stele is well preserved, but there are minor abrasions. The name of  in the left-hand panel of the door and all the figures with their accompanying inscriptions, apart from those of the gods, were erased in antiquity.

BIRCH, *T.S.B.A.*, VIII, pp. 142-1; BREASTED, *The Dawn of Conscience*, pp. 275-7; ID., *The Development of Religion and Thought*, pp. 315-7; BUDGE, *Sculpture Guide*, p. 134 (Pl. XX); ID., *Tutankhamen, Amenism, Atenism, etc.*, pp. 46-54; LACAU, *Stèles du Nouvel Empire*, pp. 90-2; PIERRET, *Rec. de Trav.*, I (1870), pp. 70-2. *BIFAO* 41, 25-30. - *JEA* 35, 63 ff. - *ZdS* 94, 29 ff.

## PLATE XXII

No. 57399

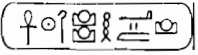
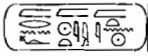
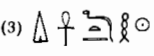


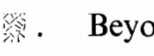

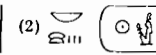

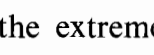
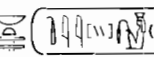
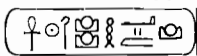
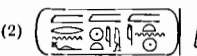
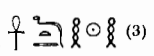

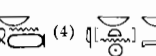



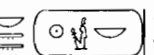
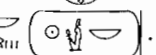
Rectangular stele of  Neb-maāt-Rā (*nb-mꜣt-rꜥ*) and  Tiy (*tyy*).

Limestone. Height 30 cm. Width 30 cm. Reign of Akhenaten. From Tell el-Amarnah. Presented by the Egypt Exploration Society, 1924.

The stele is in the form of a shrine, with cavetto cornice surmounted by uraei wearing disks. At the base of the architrave is a frieze composed of clusters of grapes. On the side panels are bunches of lotus buds and flowers, each surmounted by a leaf, which on the right-hand side reaches to the edge of the frieze and on the left covers it completely. Inside the shrine, in a scene carved in low relief, Amenhetep III and Queen Tiy are seated before a stand of offerings. Behind

<sup>1</sup> Written vertically.

them is a second and smaller stand of offerings. Above them, carved in sunk relief, is the sun's disk with uraeus and ♀, and radiating arms, one of which extends ♀ towards the king and another towards the queen. The king wears the *hprš* helmet with streamers, and a long gauffered garment with waistband, fringed at the ankles. The queen wears a wig with vertical markings and streamers, and a long gauffered dress with waistband. She places her right hand on the king's right shoulder and her left across her lap. The feet of both figures are sandalled and rest on cushions placed on a mat.



The inscriptions are incised on each side of the disk: On the right, in the six (one obliterated) immediately adjacent vertical columns: (←)  (2)  (3)  (4)  (5)  (6) . Beyond, in two vertical columns: (→)   (2)  . On the extreme right, in one vertical column: (→) . On the left, in the four immediately adjacent vertical columns: (→)  (2)   (3)   (4)   . Beyond, in two vertical columns: (←)  .


*Preservation.* The monument has been reassembled from the numerous fragments into which it was broken. The upper left-hand corner, much of the upper portion of the queen's body and parts of the right-hand panel and base are missing. A considerable amount of the original paint is still visible: blue and red on the uraei, cavetto cornice, architrave, bunches of grapes, side panels and offerings; blue on the top of the shrine (representing the sky), the queen's head-dress, the king's bead collar, the mat beneath the cushions and on some of the hieroglyphs and dividing lines; red on the bodies and dresses of the king and the queen and on the cushions beneath their feet. The *hprš* helmet is painted black.

GLANVILLE, in BRUNTON, *Great Ones of Ancient Egypt*, pp. 116-7; GRIFFITH, *J.E.A.*, XII, pp. 1-2 (Pl. I); HALL, *Introductory Guide*, p. 348 (fig. 189).

## PLATE XXIII

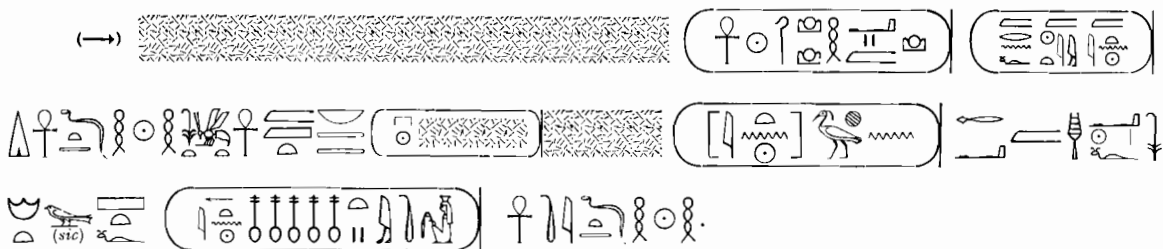
No. 24431

Fragment of a rectangular stele of   Nefer-kheperu-Rā-wā-en-Rā Akhen-āten (*nfr-hprw-r'-w'-n-r' šh-n-itn*). Limestone. Height 27·5 cm. Width 14·5 cm. From Tell el-Amarnah. Reign of Akhenāten.

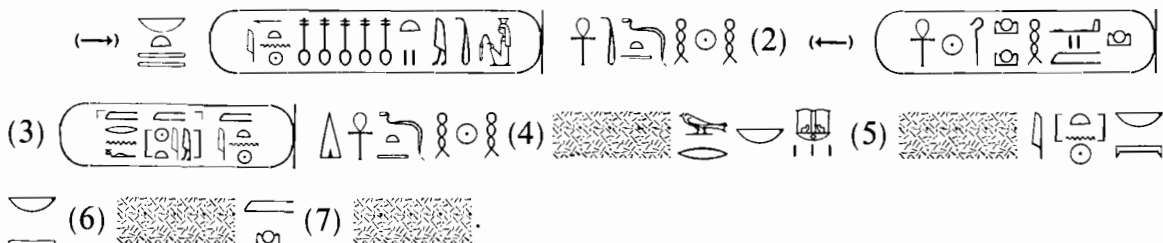
The fragment consists of a part of the right side of a rectangular stele with raised border. On the central portion is a scene, carved in sunk relief under an elongated , of Akhenāten, seated on a chair with lion-paw legs and with a decoration of papyrus flowers and lilies intertwined, receiving offerings. Above him are the radiating arms of the sun's disk (missing). He wears a short braided wig with uraeus, fillet and streamers and a long gauffered skirt with girdle. Under the feet is a cushion placed upon a low foot-stool. Both chair and foot-stool are set on a mat.

The inscriptions are incised on the raised border, and on the sunken central portion on the right of the sun's disk and in front of the king.

On the raised border, in one line:



On the right-hand side of the disk, in seven vertical columns:



In front of the king, in two vertical columns:



*Preservation.* The fragment has been reassembled from the two pieces into which it was broken.<sup>1</sup> There are considerable lacunae in the raised border and sunken central portion, as shown in the text above, and the whole of the left half of the stele is missing. Traces of the original paint are still visible: blue on the king's wig, the hieroglyphs and the dividing lines, and red on the king's body, the streamers, girdle and cushion.

BUDGE, *Guide to the Fourth, Fifth and Sixth Egyptian Rooms and the Coptic Room*, p. 127; *Id.*, *Tutankhamen, Amenism, Atenism, etc.*, Pl. VII; HALL, *Introductory Guide*, p. 355 (fig. 195).

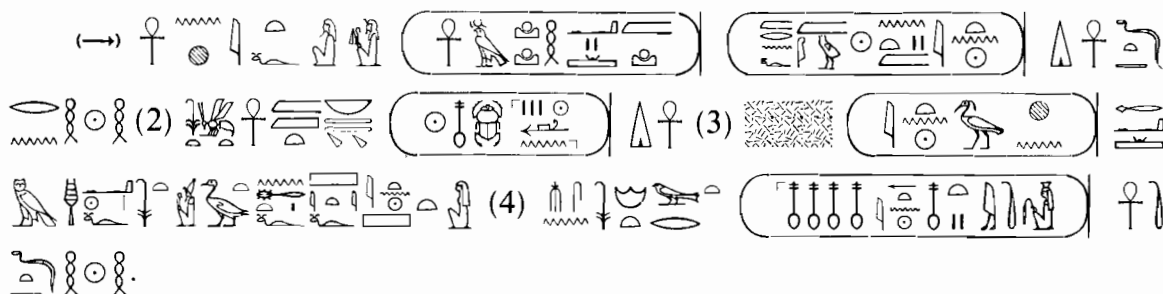
## PLATE XXIV

No. 1000

Rectangular base of statue (?). Black granite. Length 90 cm. Width 52 cm. Height 30 cm. From Tell el-Amarna. Reign of Akhenaten.

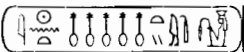
Two inscriptions, incised, run in parallel lines around the four sides of the stone, the first in the upper line and the second in the lower.

Upper line:



<sup>1</sup> The two pieces were acquired separately; the lower in 1891 and the upper in 1933.



Statuette of  Nefer-neferu-Āten Nefertiti (*nfr-nfrw-itn nfr-titi*).  
Sandstone. Height 69 cm. From Tell el-Amarnah. Reign of Akhenāten.  
Presented by the Egypt Exploration Society, 1924.

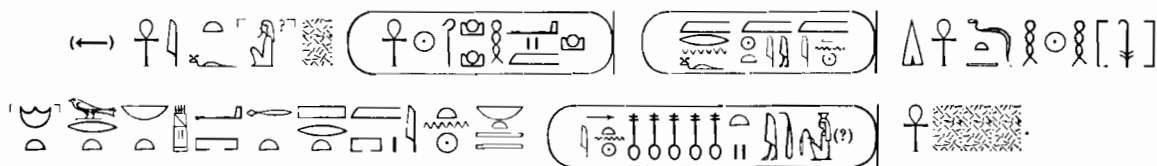
The figure, wearing a bead collar and long gauffered gown, stood, when complete, with arms bent at the elbow, holding an offering-table in both hands. The head and neck were made separately from the body and morticed to it at the back of the shoulders.

The inscriptions are incised beneath the offering-table and on the back support of the statuette.

Beneath the offering-table:







On the back support, in one vertical column:



*Preservation.* The figure, which has been reassembled from several fragments, is severely mutilated throughout. The face, fore-arms and feet are missing, and of the offering-table only the portion nearest the body remains. Much of the original paint is still visible: red on the body, white on the garment and blue on the bead collar, hieroglyphs and dividing lines.

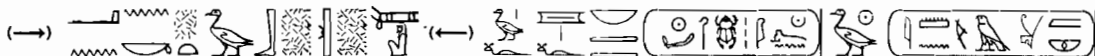
No. 21

Statue group of  Jeser-Kheperu-Rā-setep-en-Rā (*dsr-hprw-r'-stp-n-r'*)  
 Herun-em-ḥeb-mery-Āmen (*hrn-m-ḥb-mry-ḥmn*) and the god  
 Āmen-Rā-ka-mutef (*ḥmn-r'-k3-mwt.f*). Grey granite. Height  
1 m. 48 cm. Width 70 cm. From Thebes (?).

The figures are carved, almost in the round, in one piece with a back support and low pedestal. The god is represented shrouded and bears the attributes of the ithyphallic god Min. When complete he wore the plumed head-dress, a beard and a bead collar, and held in the right hand a flail. The left arm is placed under the shrouds and grasps the base of the phallus (missing). Beneath the right arm stands the king, wearing a beard, bead collar and short skirt with a girdle on which his pre-nomen (←)  is incised. In the right hand he carries a roll; the left hand rests against the right side of the god.

An inscription is incised on the front of the back support between the two figures, and another on the upper surface of the pedestal.

Between the two figures, in one vertical column:



On the pedestal, in two vertical columns:

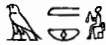


*Preservation.* The monument has been reassembled from the four fragments into which it was broken. The following portions are missing: the plumes which were morticed on to the god's head-dress, part of the beard, nearly the whole of the right arm, and the phallus; the king's head, right arm as far as the wrist, and left foot; the upper portion of the back support behind the figure of the king and a large piece from the left-hand side of the pedestal.

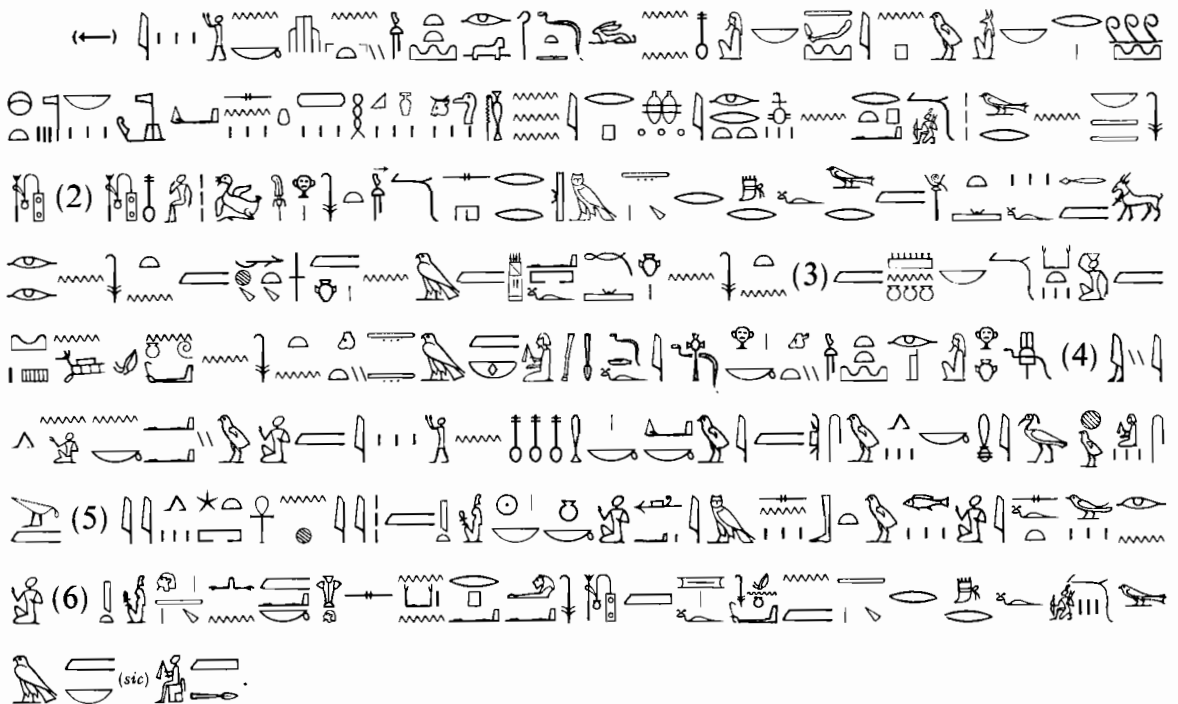
ARUNDALE AND BONOMI, *Gallery of Antiquities*, pp. 86-7 (Fig. 152); BUDGE, *Sculpture Guide*, p. 125, No. 5; GAUTHIER, *Le Livre des Rois*, II, p. 491.

## PLATE XXVII

No. 550

Inscribed panel from the tomb of  Herun-em-ḥeb (*hrn-m-ḥb*). Limestone.  
Height 1 m. 80 cm. Width 41 cm. From Sakkarah. Reign of Tutānkhāmen.  
Salt Collection.

A figure of the deceased, carved in sunk relief, stands with hands uplifted in an attitude of adoration. He wears a long braided wig with uraeus, a long gauffered garment over a stiffened short skirt, and sandals. A fan symbolising his office is attached to his back. Above and in front of him is an inscription incised in six vertical columns:

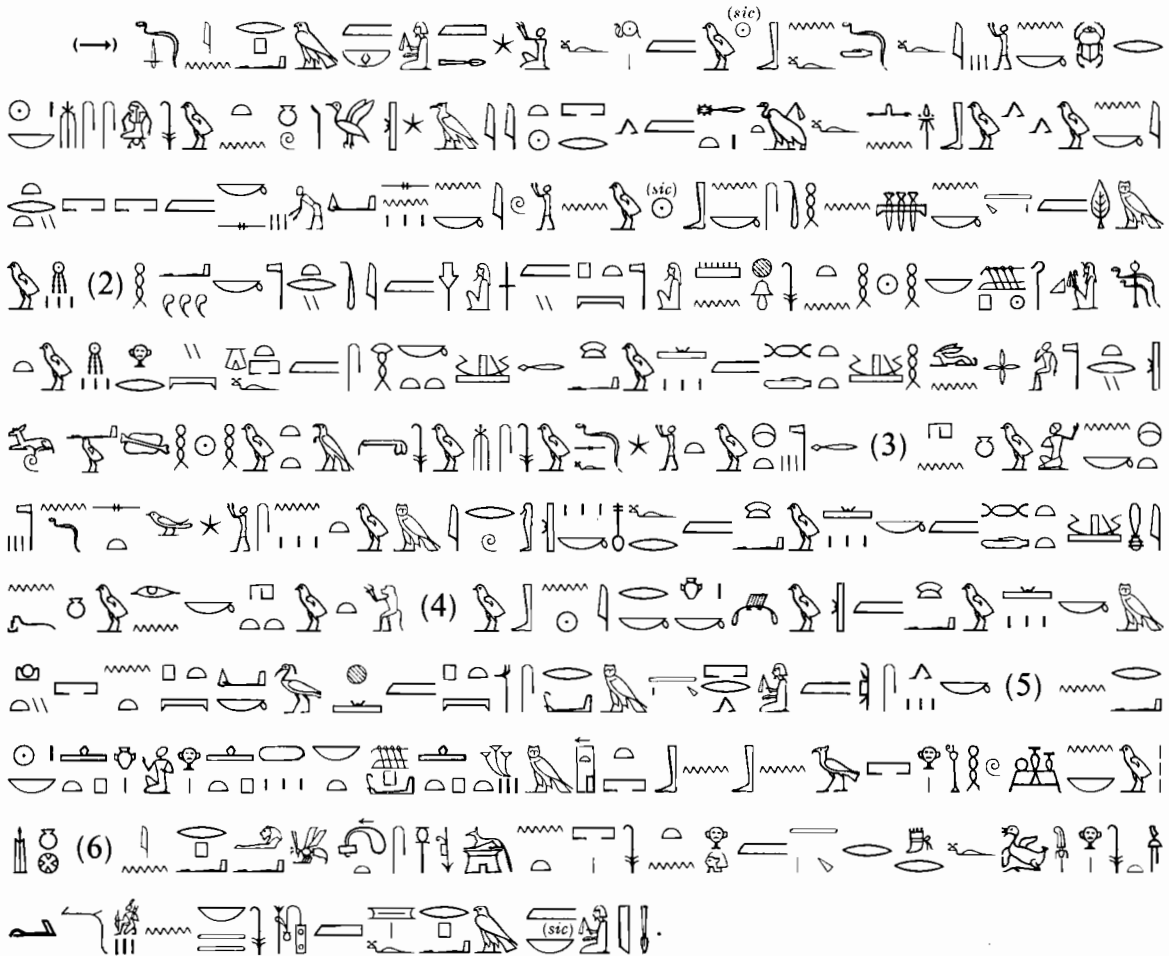


*Preservation.* Slight mutilation has occurred at the base and on the raised border, but the text and relief, apart from minor abrasions, are perfectly preserved. Some very faint traces of red paint on the body and blue within the hieroglyphs are still visible.

BUDGE, *Sculpture Guide*, pp. 130-1; PORTER AND MOSS, *Topographical Bibliography*, III, p. 196; SHARPE, *Egyptian Inscriptions, 2nd Series*, p. 92.

Inscribed panel from the tomb of the same person. Limestone. Height 1 m. 75 cm.  
Width 42 cm. From Sakkarah. Reign of Tutānkhāmen. Salt Collection.

A figure of the deceased, carved in sunk relief, stands with hands uplifted in an attitude of adoration. He is clad as in the foregoing panel, except that he has bangles on wrists and forearms. Above and in front of him is an inscription incised in six vertical columns:



*Preservation.* The panel has been reassembled from the four pieces into which it was broken, but the text and relief, apart from minor abrasions, are perfectly preserved. Some very faint traces of red paint on the body and blue within the hieroglyphs are still visible.



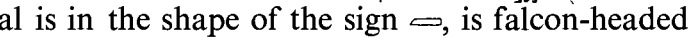
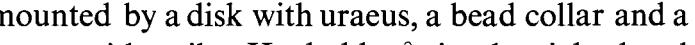
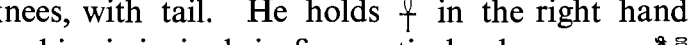



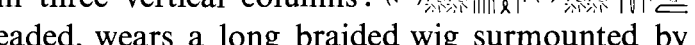
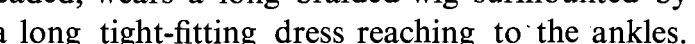
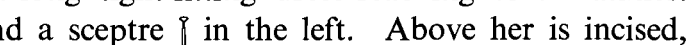

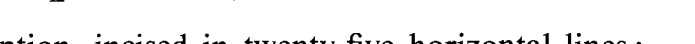
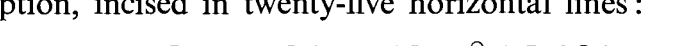


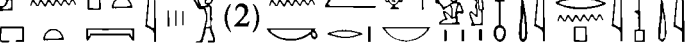

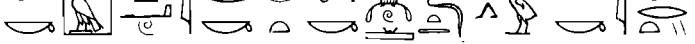




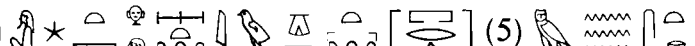
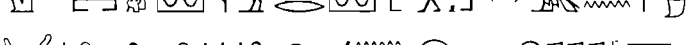

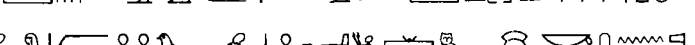
BUDGE, *Sculpture Guide*, p. 131; GARDINER, *Egyptian Grammar*, pp. 291-2; PORTER AND MOSS, *Topographical Bibliography*, III, p. 196; SHARPE, *Egyptian Inscriptions, 2nd Series*, p. 92.

### PLATE XXVIII

No. 551

Round-topped stele of the same person. Limestone. Height 1 m. 95 cm. Width 1 m. From Sakkarah. Reign of Tutānkhāmen. Salt Collection.


Two registers. In the arch, carved in low relief, is the winged disk with pendent uraei.

**FIRST REGISTER :** In a scene carved in low relief the deceased stands with arms uplifted in an attitude of adoration before the deities Rā-Ḥerakhti, Thoth and Maāt, who stand on pedestals. The deceased is clad as in the foregoing panels, but without uraeus or fan and wearing a bead collar. In front of and behind him is incised in four vertical columns: (→)  (1)  (2)  (3)  (4) . Rā-Ḥerakhti, whose pedestal is in the shape of the sign , is falcon-headed and wears a long braided wig surmounted by a disk with uraeus, a bead collar and a short garment reaching to the knees, with tail. He holds  in the right hand and a sceptre  in the left. Above him is incised, in five vertical columns: (←)  (1)  (2)  (3)  (4)  (5) . Thoth, who is ibis-headed, is attired like Rā-Ḥerakhti, and also holds  in the right hand and a sceptre  in the left. Above him is incised, in three vertical columns: (←)  (1)  (2)  (3) . Maāt, who is human-headed, wears a long braided wig surmounted by a fillet and the feather , and a long tight-fitting dress reaching to the ankles. She holds  in the right hand and a sceptre  in the left. Above her is incised, in three vertical columns: (←)  (1)  (2)  (3) .

**SECOND REGISTER :** An inscription, incised in twenty-five horizontal lines:



<sup>1</sup> In the original the uraeus is added to the sun's disk above the god's head.

<sup>2</sup> In the original the seated figure holds a sceptre .

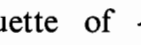
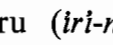


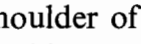
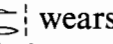
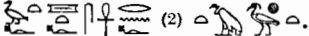



**Preservation.** The upper portion of the stele is considerably mutilated and small abrasions have occurred at the edges. Some superficial cracks are visible, but otherwise the text is in an excellent state of preservation. The bodies of the males, the disk of Herakhti, the dress and fillet of Maät bear considerable traces of red paint. Yellow is visible in many of the hieroglyphs and some bright blue remains at the edges.

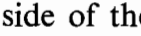
BUDGE, *Sculpture Guide*, p. 130 (Pl. XIX); HALL, *Introductory Guide*, p. 359; MEYER, *Ä.Z.*, XV, pp. 149-51; PORTER AND MOSS, *Topographical Bibliography*, III, p. 196; SCHARFF, *Sonnenlieder*, pp. 58-60. *U.A. 17, 2094 //*

<sup>1</sup> In the original the uraeus is added to the sun's disk above the god's head.

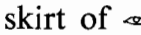
Seated statuette of  Iri-neferu (*iri-nfrw*) and  Apu (*ipw*).  
Limestone. Height 56 cm. Width 27.5 cm. From Thebes (?). XVIIIth  
Dynasty. Sams Collection.

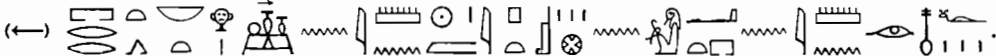
The two figures are seated on a high-backed chair, each with one arm resting on the far shoulder of the other.  wears a long braided wig, bead collar and skirt reaching to the ankles.  wears a long braided wig and a long tight-fitting dress; in her left hand she holds a sistrum. On the front of the seat between the two figures is carved in sunk relief a figure of their daughter, wearing a long wig surmounted by a fillet and a lotus-bud, and a long tight-fitting dress; in her right hand she holds a lotus flower with a long stem. On each side of her is an inscription, incised in two vertical columns : ( $\rightarrow$ )  (2) .

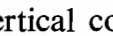
The main inscriptions are incised on the sides of the chair and on the front of the garments of the two seated figures.


On the side of the chair below , in six vertical columns :

( $\rightarrow$ )  (2)  (3)   
 (5)   
 (6) 

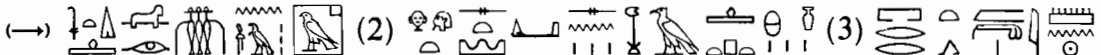
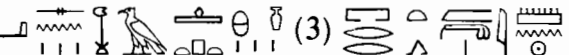

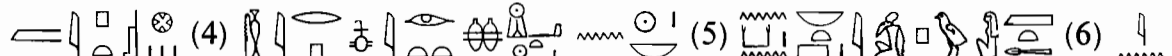
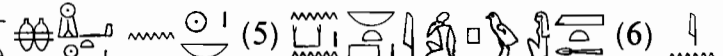



On the skirt of , in one vertical column :

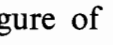
( $\rightarrow$ ) 



On the skirt of , in one vertical column :

( $\rightarrow$ ) 

On the side of the chair below , in six vertical columns :





( $\rightarrow$ )  (2)  (3)   
 (4)  (5)  (6)   
 (sic)

*Preservation.* The head of the figure of  and the corner of the seat behind it are missing. The lower portion of the pedestal is damaged and there are some minor abrasions, but otherwise the monument is well preserved. Traces of paint remain: black on the head-dress of the man, red on his body and in the dividing lines of the inscription, and blue in some of the hieroglyphs on the side of the seat.

Statuette and round-topped stele of  Amen-em-ḥeb (*imn-m-ḥb*), called  Meḥ (*mḥ*). Grey granite. Height 41 cm. Width 15 cm. Provenance unknown. XVIIIth Dynasty.

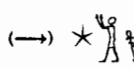

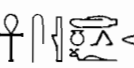



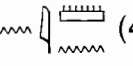

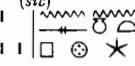
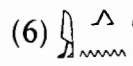
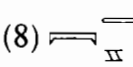

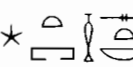
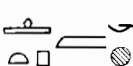

The deceased, wearing a long wig, is represented kneeling on a pedestal and holding before him a stele.

The inscriptions are incised on the stele, the front, back and sides of the pedestal and on the central support connecting the stele with the figure.

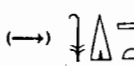


In the arch: In a scene carved in sunk relief the deceased plays on the harp before the rising sun . An inscription is incised in three horizontal lines in front of him and in one vertical column behind him: (→)  (2)  (3) 

(4)  (sic).

Below, in eleven horizontal lines (the last two are on the front of the pedestal):

(→) \*  (1)  (2)  (3)   
 (4)  (5)   
 (6)  (7)   
(8)  (9)  (10)   
 (11)  (12)

On the left side of the pedestal, in two horizontal lines:

(→)  (2)   


On the back of the pedestal, in two horizontal lines:

(→)  (2)   


On the right side of the pedestal, in two horizontal lines:

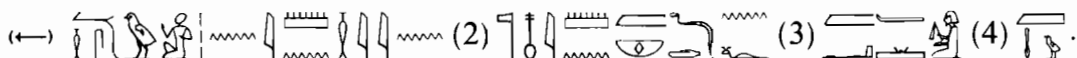
(→)  (2)   


Below the left arm, incised in four vertical columns:

(→)  (2)  (3)  (4) 

<sup>1</sup> ♀ is omitted from this sign in the original.

Below the right arm, incised in four vertical columns :



*Preservation.* The nose of the figure is mutilated and there are small abrasions around the bottom of the pedestal. In other respects both figure and stele are in a perfect state of preservation.

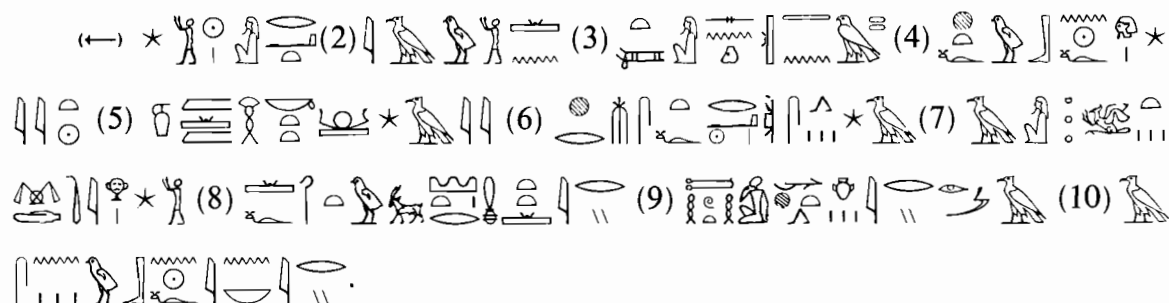
PLATE XXXI

No. 48033

Statuette and stele of Neb-ary (*nb-iry*). Limestone. Height 14 cm. Width 8 cm. Provenance unknown. XVIIIth Dynasty.

The deceased is represented kneeling on a pedestal and holding before him a stele. He wears a long wig and a long skirt reaching to the ankles.<sup>1</sup>

The inscription is incised in ten horizontal lines, beginning on the stele and continuing on the skirt above the knees :



*Preservation.* Apart from minor abrasions, both stele and statuette are well preserved.

No. 1571

Round-topped stele of Mery-Amen (*mry-ynn*). Brown quartzite. Height 21 cm. Width 17.5 cm. Provenance unknown. XVIIIth Dynasty.

TWO REGISTERS.

**FIRST REGISTER :** In a scene carved in sunk relief a ram, wearing the head-dress of two plumes with sun's disk and uraeus, and a goose stand facing each other, separated by a small stand holding a vase. Above the ram, incised in three vertical columns : (←) . Above the goose, incised in two vertical columns : (→) .

**SECOND REGISTER :** On the right-hand side is a figure of the deceased, carved in sunk relief, kneeling on one knee with hands upraised in an attitude of adoration. An inscription is inscribed in front of the deceased in four vertical columns, and behind him in one vertical column,

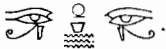


*Preservation.* Apart from minor abrasions, the preservation is perfect.

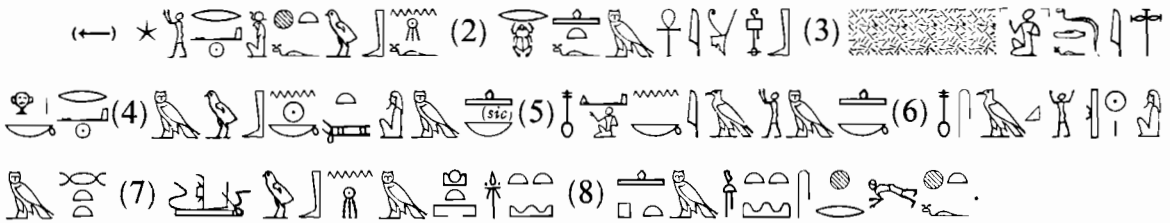
<sup>1</sup> In order to secure a good photograph of the lower portion of the inscription it was found necessary to exclude part of the wig.

Statuette and round-topped stele of a person whose name is erased. Limestone.  
Height 19·5 cm. Width 11·5 cm. Provenance unknown. XVIIIth Dynasty.

The deceased is represented kneeling on a pedestal and holding before him a stele. He wears a long braided wig, a short beard and a long skirt reaching to the ankles. The top of the stele is shaped in the form of an offering-table, some of the offerings being carved on the top of the support connecting the stele with the figure.

In the arch is incised .



Below, incised in eight horizontal lines,





*Preservation.* The name of the owner has been erased, but otherwise both figure and stele are well preserved. Traces of red paint still remain on the body.


BUDGE, *Guide to the Fourth, Fifth and Sixth Egyptian Rooms and the Coptic Room*, p. 125.

No. 2304


Seated statuettes of  Pa-shedu (*ps-šdw*) and  Ruâu (*rwîw*). Limestone. Height 26·5 cm. Width 15·5 cm. Provenance unknown. XVIIIth Dynasty.

The two figures are seated on a high-backed chair, each with one arm resting on the far shoulder of the other.  wears a long braided wig and a long skirt.  wears a long braided wig and a long tight-fitting dress.

The inscriptions are incised on the front of the garments of the two figures and on the back of the chair, which is in the form of a round-topped stele.

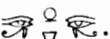
On the front of , in one vertical column:



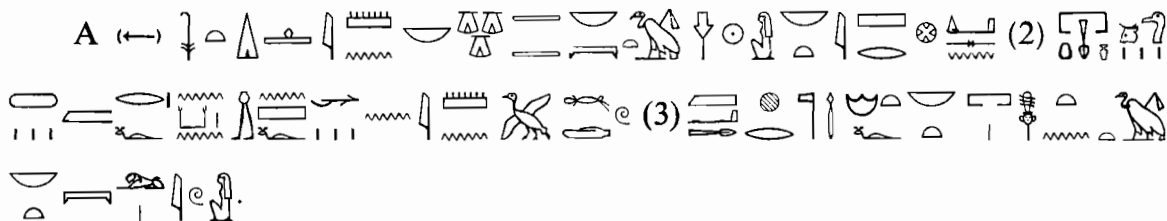
On the front of , in one vertical column:



On the back of the chair:

In the arch: .

Below, in five vertical columns, reading from the centre outwards :



*Preservation.* The monument is in an excellent state of preservation. Much of the original paint is still visible: black on the wigs, and red on the bodies, fringes of garments and border lines of the front inscription.

BUDGE, *Guide to the Fourth, Fifth and Sixth Egyptian Rooms and the Coptic Room*, p. 126.

### PLATE XXXIII

No. 1332

Round-topped stele of Auna (*iwnꜣ*). Limestone. Height 1 m. Width 54 cm. Provenance unknown. XVIIIth Dynasty.








#### THREE REGISTERS.

In the arch is the winged disk with pendent uraei.

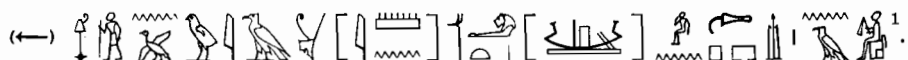
**FIRST REGISTER :** The dead man stands with hands uplifted adoring the *nšmt* bark. He wears a short braided wig, a bead necklace and a long transparent garment covering a short gauffered skirt, and on his left arm and both wrists he wears bangles. The figure is carved in slightly sunk relief. Below the right wing of the disk is an inscription incised in six vertical columns : (→) (2) (3) (4) (5) (6) . Between the dead man and the bark is incised in one vertical column : (→) . Behind him is incised in one vertical column : (→) . Below the left wing is incised in five vertical columns : (←) (2) (3) (4) (5) (6) .

The *nšmt* bark, whose hull, carved in sunk relief, takes the form of the papyrus boat with incurving ends and streamers at the bow and stern, bears in the middle a canopy protecting the fetish of Abydos , two standards surmounted by rams and a box. Above the cornice of the box are incised twelve uraei with disks, and on its side two registers are carved in very low relief. In the first register the signs and are repeated alternately in one horizontal band. In the second register there are two parallel scenes: on the left the dead man, wearing a long wig and short skirt, stands with hands outstretched presenting offerings to Osiris, represented in mummy form and wearing the crown of Upper Egypt , beard, necklace with counterpoise, and holding and in his hands. On the right, in a similar scene, another figure, probably a woman, wearing a wig and tight-fitting dress, presents offerings to a deity, now obliterated. In front of the canopy,












<sup>1</sup> In the original the boat has incurving ends and carries a shrine.

carved in sunk relief, are two stands, each surmounted by a lotus flower with a long stem. Between the stands and the bow are incised four standards, two surmounted by jackals , one by a cult object  and one apparently by an ibis . Below the standards is a casket surmounted by six uraei with disks and raised on four legs. The side is decorated with the signs  and  twice repeated. Beneath the casket are the signs  and . At the stern of the boat are the steering-oars, lashed to two posts surmounted by falcons' heads.










Between the first and second registers is incised in one horizontal line :















SECOND REGISTER : Two parallel scenes. On the right-hand side the father and mother of the deceased are seated, each on a chair with lion-paw legs, before a table of offerings, with a low pedestal under their feet. The father wears a short braided wig surmounted by a cone, a short beard, a bead collar and a long garment reaching to the ankles. In his right hand he holds a lotus flower with a long stem, and in his left hand a folded cloth. In front of him is incised in five vertical columns :

(→)   (2)   (3)  (4)  (sic) (5) . The mother wears a long wig surmounted by a cone and fillet with lotus flower, a bead collar and a long tight-fitting dress. Her left hand is placed on her husband's left arm and the right on his right shoulder. Above the mother is incised : (→)    .

On the left-hand side, in a similar scene, the dead man and his wife, clothed like the parents, receive offerings from two daughters. In front of the man is incised in five vertical columns :

(→)   (2)   (3)   (4)   (5) . Behind the woman,

incised in one vertical column : (→)  . The daughters wear long wigs surmounted by cones, and long tight-fitting dresses. The one in front carries in her right hand a vase  from which she pours libations, and in the left a vessel containing incense . Above her is incised, in two vertical columns : (→)  .


(2)  . The one behind carries two birds in her right hand and a loaf of bread  in her left. Above her is incised, in one vertical column : (→)   .

THIRD REGISTER : An inscription is incised in eleven horizontal lines :



<sup>1</sup> This line of inscription forms the beginning of the main text and is continued in the third register.




*Preservation.* The surface of the stele has suffered severely from the effects of salt, and despite treatment much disintegration has occurred. The name of  has been erased in antiquity wherever it appears.

BUDGE, *Sculpture Guide*, p. 142; GLANVILLE, *A.Z.* 68, pp. 39-41 (Pl. II). *U.A. 17*, 1630-1632

### PLATE XXXIV

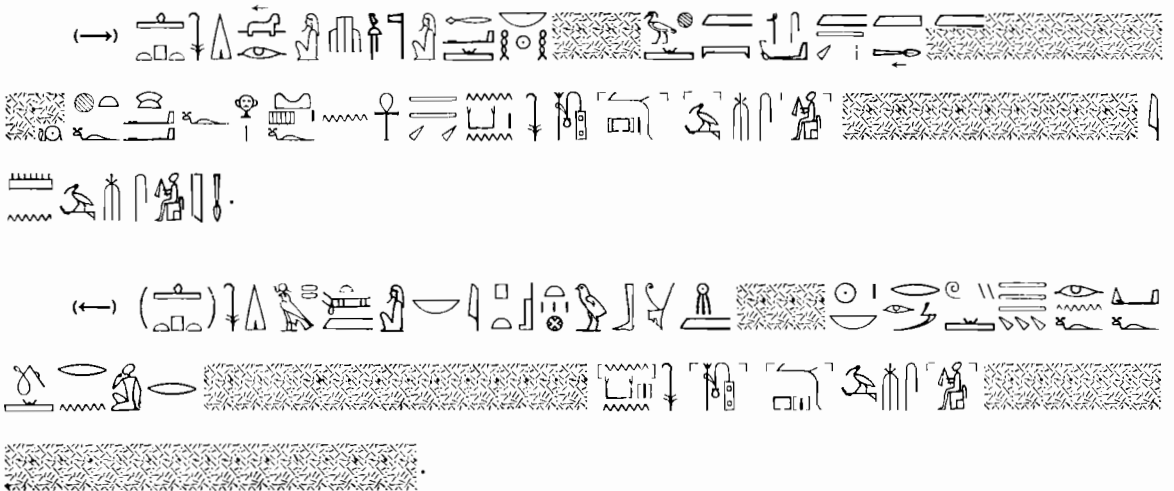
No. 170

Rectangular stele, in the form of a door, of  Jehuty-mes (*dhwtj-ms*). Limestone. Height 87 cm. Width 53.5 cm. From Deir el-Bahri. XVIIIth Dynasty. Presented by the Egypt Exploration Fund, 1906.






The inscriptions are incised on the lintel and sides of the frame, and on the door itself.

#### THE FRAME:

Two inscriptions, arranged symmetrically, run in opposite directions from the centre of the lintel to the ends and continue to the bottom of each side.



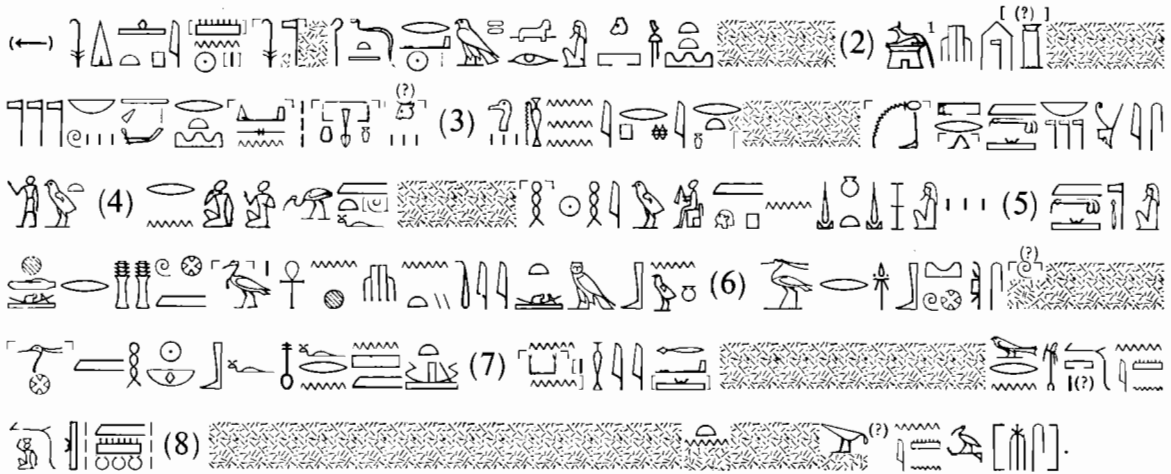
#### THE DOOR:

FIRST REGISTER: The scene, carved in sunk relief, shows the dead man, wearing a long braided wig and a long gauffered garment, standing with hands raised in an attitude of adoration at a table of offerings before Osiris and Isis. Above him is incised in five vertical columns: (→)  (2)  (3)  (4)  (5) 



𓂏𓂏. Osiris, represented in mummy form, with beard, wears the *Ātef* crown on his head and holds the crook 𓏏 in the right hand and the flail 𓏏 in the left. Above him is incised in three vertical columns: (←) 𓏏 𓏏 𓏏 (2) 𓏏 𓏏 𓏏 (3) 𓏏. Isis, on whose head is a long wig surmounted by a disk with horns and uraeus, is clad in a tight-fitting garment reaching to the ankles. She holds 𓏏 in the right hand and rests the left hand on the shoulder of Osiris. Above her is incised in one vertical column: (←) 𓏏 𓏏 𓏏.

SECOND REGISTER: An inscription incised in horizontal lines:



*Preservation.*—The stele has been reassembled from numerous fragments and contains considerable lacunae throughout. The cavetto cornice is badly damaged and almost the whole of the lower portion and base are missing.<sup>2</sup> Traces of the sculptor's red guiding lines are visible throughout the inscription.

NAVILLE AND HALL, *Deir el-Bahari*, III, p. 23 (Pl. XV).

PLATE XXXV

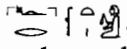
No. 803

Fragment of relief. Limestone. Height 51·5 cm. Width 57 cm. Provenance unknown. XVIIIth Dynasty.

The fragment, carved in low relief, shows three men performing the ceremony of "Opening the Mouth." On the right-hand side, outside this fragment, stood the mummy of the deceased person. In front of the mummy there was a table of offerings, the upper part of which can be seen in the bottom right-hand corner. Above it are arrayed the following objects connected with the ceremony: two *nms.t* vases 𓏏, four *dšr.t* vases 𓏏, three (?) adzes 𓏏, the *wr-ḥkꜣw* instrument, another vase, a chisel, a finger 𓏏, a *psš-ḳf* amulet 𓏏, the fore-leg of an ox 𓏏 (?), a feather 𓏏, two censers (?) and a scribe's casket (?). The first of the three men, wearing a short wig, and a leopard-skin over a short skirt and long transparent garment with sleeves, stands with hands outstretched holding an adze 𓏏 (?) before the mummy. Above him is incised in one vertical line: (←) 𓏏 𓏏 𓏏

<sup>1</sup> In the original the jackal has a flail 𓏏.

<sup>2</sup> The missing portion possibly consisted of six lines of inscription. Only the lower portion of a bird and part of another sign at the beginning of line 9 and 𓏏 at the beginning of the next remain.


. The second, wearing a long wig and a long transparent garment over a short skirt, holds in his hands a partly opened roll of papyrus. The third, wearing a short skirt and leopard-skin, holds a censer in his left hand.


*Preservation.* The fragment is well preserved, with the exception of the lower portion of the right-hand side, which is severely mutilated.





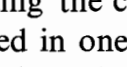
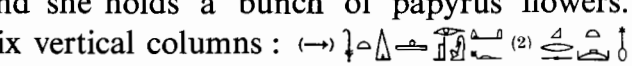

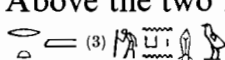




BUDGE, *Sculpture Guide*, pp. 128-9.

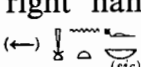


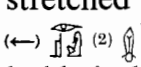



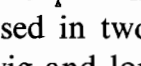

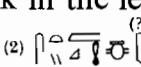

PLATE XXXVI

No. 301

Combined libation-trough and stele with angular top of  Thuthu (*tw-tw*). Limestone. Height 56 cm. Width 21.5 cm. Provenance unknown. XVIIIth Dynasty.

TWO REGISTERS. In the angle: .


FIRST REGISTER: In a scene carved in sunk relief the dead man and a wife stand in adoration before Osiris. Osiris, seated on a throne  set on a pedestal in the form of the sign , is represented in mummy form, wearing the Atef crown, beard and bead collar, and holding the crook  in the left hand and the flail  in the right. Before him is incised in one vertical column: ( $\leftarrow$ )  (sic). Between Osiris and the dead man is a stand bearing a vase and a lotus flower and bud. The dead man wears a long braided wig and a gauffered skirt reaching to below the knees. His wife wears a long wig surmounted by a cone and the usual long tight-fitting dress. In her right hand she holds a bunch of papyrus flowers. Above the two figures, is incised in six vertical columns: ( $\rightarrow$ )  (2)   (3)  (4)  (5)  (sic) (6) .

SECOND REGISTER: The dead man and another wife are seated before a table of offerings in the presence of a son and daughter. The wife, wearing a long wig surmounted by a cone and a long tight-fitting dress, is seated on a chair with lion-paw legs. Her left hand is placed on her husband's left shoulder, and her right hand on his right arm. Above her is incised in three vertical columns: ( $\leftarrow$ )  (2)  (3) . The dead man, seated on a similar chair, wears a long braided wig, surmounted by a cone, and a long garment. His left hand is stretched towards the offerings. Before him is incised in three vertical lines: ( $\leftarrow$ )  (2)  (3) . His son, wearing a short skirt and leopard-skin, holds in his right hand a vase  from which he pours a libation, and in his left a censer. Above him is incised in two vertical columns: ( $\rightarrow$ )  (2) . The daughter, wearing a long wig and long tight-fitting dress, holds a papyrus flower in the right hand and a duck in the left. Above her, incised in one horizontal and two vertical lines, ( $\rightarrow$ )  (2)  (2)(2).


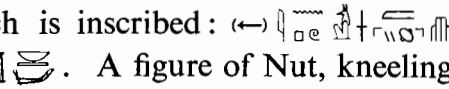


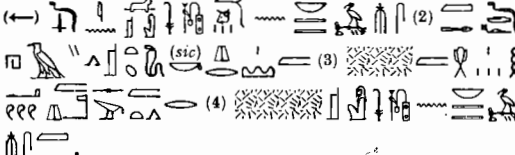
Below and protruding in front of the stele is a libation trough, roughly carved and unincised.

*Preservation.* The face of the daughter in the second register has been badly mutilated, but the remainder of the monument, apart from minor abrasions, is well preserved. Almost every trace of the original paint has disappeared.

BUDGE, *Sculpture Guide*, pp. 152-3.

Coffin of  Jehuty-mes (*dḥwtj-ms*). Brown quartzite. Length 2 m. 33 cm. Maximum width 85 cm. Depth 1 m. 17 cm. Provenance unknown. XVIIIth Dynasty.

The coffin is anthropoid in shape. On both the lid and the lower section are incised figures of deities and inscriptions.

The lid (see Fig. 4): The deceased is represented with hands crossed over the breast and wearing a long wig, bead collar and wrist bangles. On the left shoulder is a figure of Isis and the inscription: (←) . Below the left arm at the side is a figure of the jackal of Anubis recumbent on a shrine, over which is inscribed: (←) . A figure of Nut, kneeling with arms and wings outstretched, spans the chest and bears above the head the inscription (←) . On the bottom of the "slipper" is a figure of a goddess kneeling, with arms uplifted, on the sign . An inscription in four vertical columns, two on each side, accompanies the figure: (←) .

Vertical and horizontal bands of inscription, representing the principal bandages, are arranged as shown in Fig. 4.

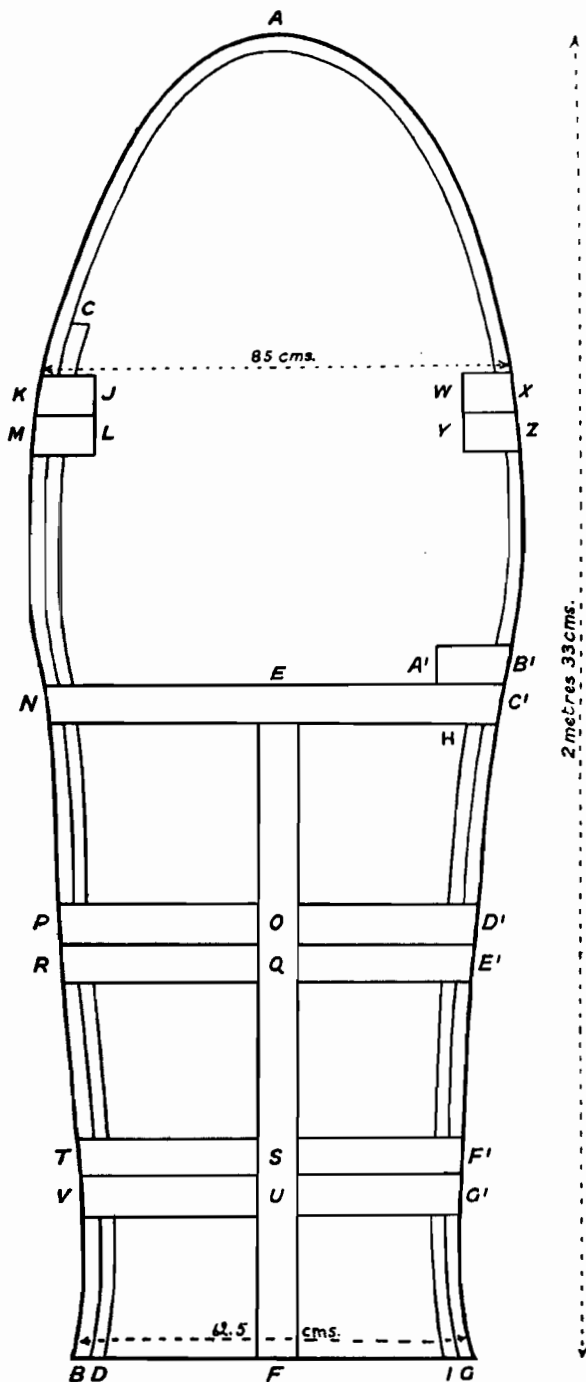
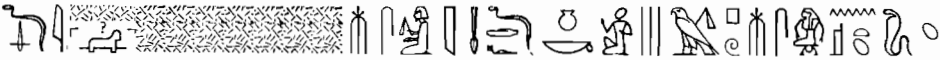


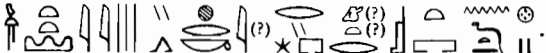


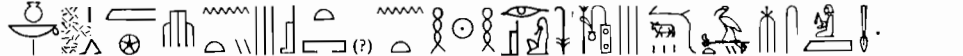



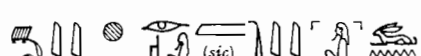


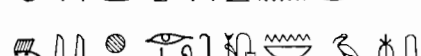
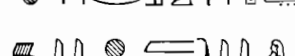

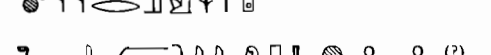
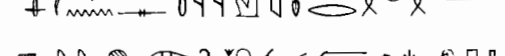
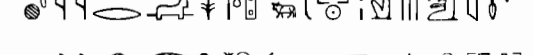
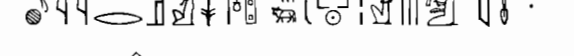




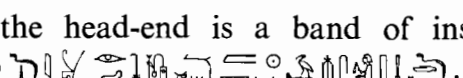
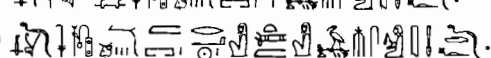
FIG. 4. COFFIN NO. 1642.


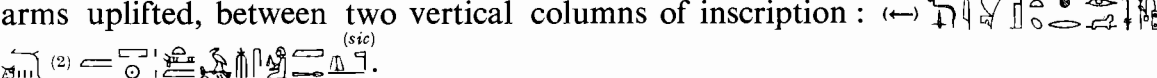
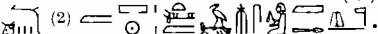
A-B (←)   
  
 C-D (←)   




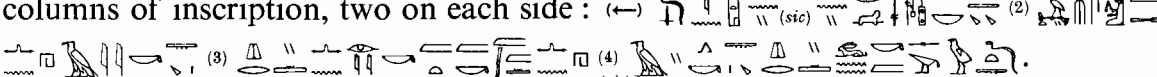



- E-F (→) .  
 A-G (←) .  
 H-I (←) .  
 J-K (→) .  
 L-M (→) .  
 E-N (→) .  
 O-P (→) .  
 Q-R (→) .  
 S-T (→) .  
 U-V (→) .  
 W-X (←) .  
 Y-Z (←) .  
 A<sup>1</sup>-B<sup>1</sup> (←) .  
 E-C<sup>1</sup> (←) .  
 O-D<sup>1</sup> (←) .  
 Q-E<sup>1</sup> (←) .  
 S-F<sup>1</sup> (←) .  
 U-G<sup>1</sup> (←) 

The lower section: The unfinished inscriptions on the horizontal bands of the lid are not continued on the lower section, which forms a unit complete in itself.

#### OUTSIDE:

Around the head-end is a band of inscription reading from the centre outwards: (→) .  
 (←) 

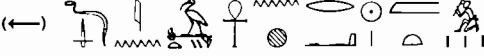
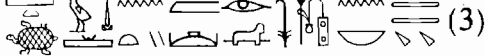


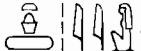
Beneath, in a panel behind the head, is a figure of Isis, wearing a short wig surmounted by the sign , a bead collar and tight-fitting dress and standing, with arms uplifted, between two vertical columns of inscription :  (2)  (sic).

On each side of the panel are large  figures, to which streamers are attached. At the foot is a figure of Nephthys, clad like Isis except that her wig is surmounted by the sign , and standing with arms uplifted between four vertical columns of inscription, two on each side :  (2)  (3)  (4)  (sic).

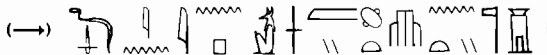
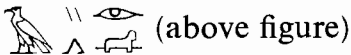


On each side are figures of deities and vertical columns of inscription.

RIGHT SIDE:

In front of a figure of Thoth holding a standard, in three vertical columns :

 (2)  (3)   
 (above figure) .

In front of a figure of Anubis in two vertical columns :

 (2)  (above figure)   
.



Then follows an inscription in two vertical columns :

 (2) .

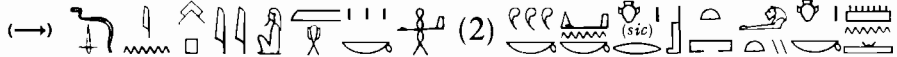


In front of the figure of a deity (Geb ?), in one vertical column :

 (above figure) .

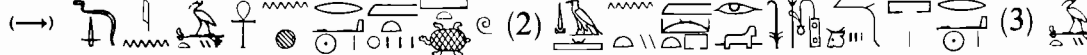


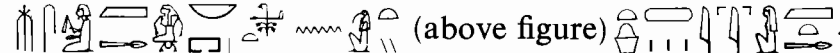

Then follows an inscription in two vertical columns :

 (2) .

In front of a figure of Hapi, in three vertical columns :

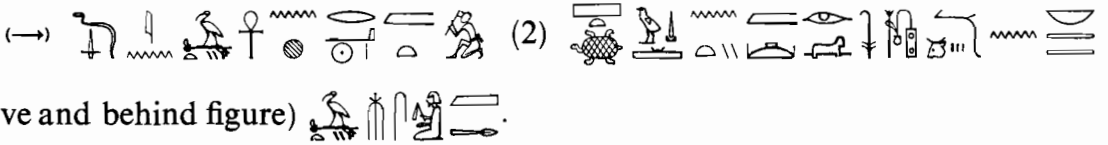
 (2)  (above figure)  
 (sic).

In front of a figure of Thoth holding a standard, in four vertical columns :

 (2)  (3)   
 (above figure) .

## LEFT SIDE :

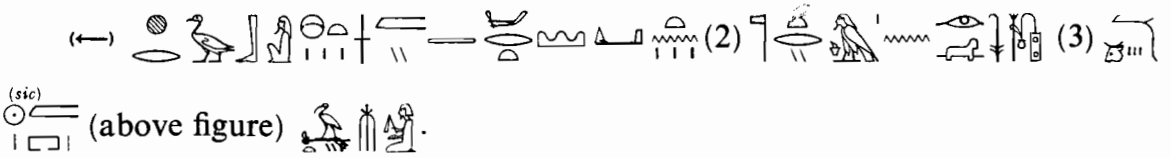
In front of a figure of Thoth holding a standard, in two vertical columns :



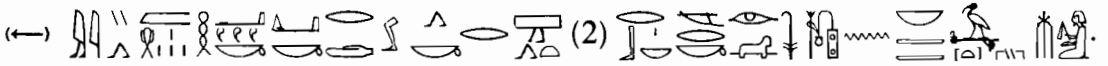
Then follows an inscription in two vertical columns :



In front of a figure of Geb, in three vertical columns :



Then follows an inscription in two vertical columns :



In front of a figure of Hapi,<sup>1</sup> in two vertical columns :



Then follows an inscription in two vertical columns :




In front of a figure of Anubis, in one vertical column :



In front of a figure of Thoth holding a standard, in four columns :



<sup>1</sup> The name  precedes the figure.

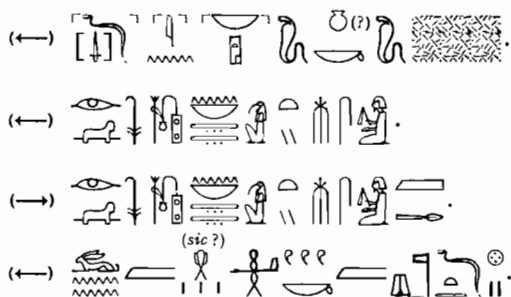
## INSIDE :

Figures of Isis at the head and Nephthys at the foot are incised on the inside, each being clad like the corresponding figure on the outside. Four vertical columns of inscription, two on each side, accompany the figures :

With the figure of Isis :




With the figure of Nephthys :






























*Preservation.* Both the lid and the lower section have been reassembled from the numerous pieces into which they were broken. Neither is, however, complete. Some faint traces of yellow paint on the figures and red on the inscriptions of the lower section are still visible.









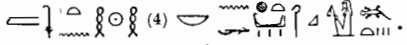
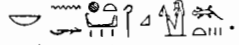

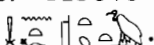
## PLATE XXXIX

No. 155

Round-topped stele of a  Jehuty-mes (*dhwtj-ms*). Limestone. Height 1 m. 21 cm. Width 27 cm. From Memphis. XVIIIth Dynasty. D'Athanasi Collection.

## TWO REGISTERS.

**FIRST REGISTER :** In a scene carved in sunk relief the deceased, accompanied by his sister and brother, is represented standing with hands uplifted in an attitude of adoration before Osiris and Isis. He wears a long braided wig surmounted by a cone, a short beard, bead collar and long transparent garment over a short gauffered skirt. In front of and above him is an inscription incised in seven vertical columns : (→)    (2)      (3)    (4)    (5)    (6)    (7) . The sister, who carries in her right hand a duck, wears a long braided wig with streamers surmounted by a cone and fillet with lotus-bud, a bead collar and a long transparent garment reaching to the ground. Above her is an inscription incised in one vertical column : (→)   . The brother, who carries in his left hand five ducks, wears a long wig braided at the edges and surmounted by a cone, a bead collar and a short gauffered skirt. Above him is an inscription incised in one vertical column : (→)   . Between the three figures and those

of the deities is a table of offerings. Osiris, represented shrouded, is seated on a throne , and under his feet is a foot-stool in the form of the sign . He wears the *Atef* crown , a long beard, bead collar and wrist-bangles. In his right hand he holds the flail  and in his left the crook . Above and behind him is an inscription incised in four vertical columns: (←)  (2)  (3)   (4) . Isis wears a long wig with streamers surmounted by the sign , a bead collar, long tight-fitting dress fringed at the ankles, and wrist-bangle. Above and beside her is an inscription incised in one vertical column (←) .








SECOND REGISTER: An inscription incised in seventeen horizontal lines:



<sup>1</sup> In the original the disk above the falcon's head has no uraeus.

<sup>2</sup> In the original there is no disk on the falcon's head.




In the bottom left-hand corner, in a scene carved in sunk relief within a rectangle, a son pours out a libation to his parents from a vase. He wears a long wig braided at the edges, a short gauffered skirt and a leopard-skin. Above him is an inscription incised in two vertical columns, (←)  (2) . The parents are seated on chairs with lion-paw legs and under their feet are foot-stools. The man, who is clad like  in the first register, holds in the right hand a lotus flower with a long stem. Above him an inscription is incised (←) . The woman, who is clad like  in the first register, places her left hand on her husband's left shoulder and her right hand on his right arm. In front of and behind her is an inscription incised in two vertical columns, (←)  (2) . Beside the chairs is a bouquet composed of a lotus flower and buds.


*Preservation.* The stele, apart from slight mutilation at the edges and minor abrasions, is in a perfect state of preservation. Faint traces of red paint on the bodies of the male figures are visible.

BUDGE, *Sculpture Guide*, p. 130 (Pl. XVIII); ID., *T.S.B.A.*, VIII, pp. 320-8; PORTER AND MOSS, *Topographical Bibliography*, III, p. 225; SHARPE, *Egyptian Inscriptions*, 1st Series, p. 105.

## PLATE XL

No. 1016

Fragment of the stele of  Nu (*nw*). Limestone. Height 22·5 cm. Width 31 cm. Provenance unknown. XVIIIth Dynasty.

The fragment, carved in very low relief, shows a female figure kneeling on one knee before an array of offerings. She wears a long wig, bead collar and tight-fitting dress and holds a lotus flower in her left hand, the right being placed on her knee. In front of the figure is incised in one vertical column: (←) . The main inscription, also incised, begins in four vertical columns on the right of the offerings and continues in three horizontal lines beneath:

(←)     (2)    (3)           

(4)      (5)           (6)    

     (7)              


 .

*Preservation.* The upper portion of the stele is missing, but apart from some small abrasions the remaining fragment is well preserved. There are no traces of paint.

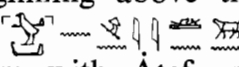
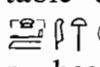










BUDGE, *Sculpture Guide*, p. 140.



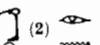













## PLATE XLI

No. 295

Round-topped stele of  Äpu (*ipw*). Limestone. Height 50 cm. Width 38·5 cm. Provenance unknown. XVIIIth Dynasty.

The stele is divided into three registers.

**FIRST REGISTER:** The dead man, wearing a long wig and long skirt arranged with a triangular fold falling in front, stands in an attitude of adoration before the deities Osiris, Horus and Isis. Between the dead man and the deities is a table of offerings. The whole scene is carved in very slightly sunk relief. An inscription, beginning above the table of offerings, is incised in three vertical columns: (→)  (2)  (3) . Osiris, who is represented in mummy form with Átef crown, beard and back pendant, sits on a throne  and holds the crook  and the flail  in his hands. Above and in front of him is incised in two vertical lines: (→)  (2) . Horus, with falcon head, wears the double crown of Upper and Lower Egypt  and a short skirt. In the right hand he holds  and in the left . Isis, with right hand raised, wears a long wig surmounted by the sun's disk with horns and uraeus, and a tight-fitting dress reaching to the ankles. Beneath the deities is a pedestal in the shape of the sign .

**SECOND REGISTER:** The dead man, wearing on his head a short wig and clad in a short skirt, stands with hands outstretched before four relatives, each sitting with the right leg doubled under the body and the left knee raised. In his right hand he holds a vase from which he pours libations and in his left a vessel containing incense . Between him and the relatives is an array of offerings. The whole scene, like that of the first register, is carved in very slightly sunk relief. Above the offerings and in front of the deceased is an inscription incised in four vertical columns: (→)  (2)  (3)  (4) . The first relative, who wears a long wig surmounted by a cone, and a long sleeved garment reaching to the ankles, holds in his right hand a sceptre and raises his left hand towards the deceased. Before and above him is an inscription, incised in three vertical columns: (→)  (2)  (3) . The second relative, who wears on the head a long wig surmounted by a fillet, cone and lotus-bud, raises the right hand towards the deceased and rests the other on the left ankle. Above and in front of her is an inscription incised in four vertical columns: (→)  (2)  (3)  (4) . The third relative, who wears a long wig surmounted by a lotus-bud, raises the right hand towards the deceased and rests the left on the shoulder of the second relative. Above him is an inscription, incised in two vertical columns: (→)  (2) . The fourth relative, clad like the second except that the fillet is omitted from the wig, grasps the right arm of the third relative with her right hand and places her left hand on his right shoulder. Above her is an inscription, incised in two vertical columns: (→)  (2) .

**THIRD REGISTER:** An inscription is incised in four horizontal lines:

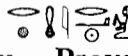
(→)  (2)   
 (3)   
 (4)   





*Preservation.* The top of the arch is missing and there is a severe abrasion in the upper left-hand corner. Almost all the original paint has disappeared, but faint traces of red remain on all the figures except that of Osiris, on some of the offerings and on the dividing lines of the inscriptions.

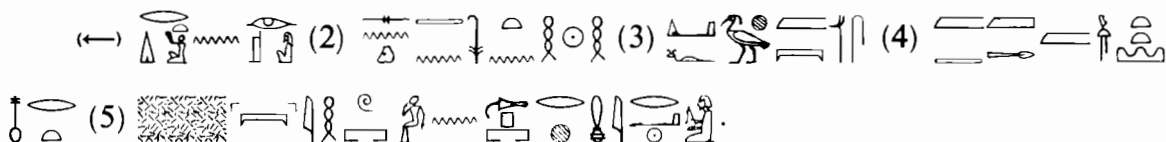
BUDGE, *Sculpture Guide*, p. 129; SHARPE, *Egyptian Inscriptions, 2nd Series*, p. 75.

## PLATE XLII

No. 1743

Fragment of a stele of  Rekh-mä-Rä (*rh-mi-r*). Sandstone. Height 57 cm. Width 44 cm. Provenance unknown. XVIIIth Dynasty.

In a scene carved in sunk relief, the deceased kneels in an attitude of adoration before Osiris, who is not visible in this fragment. He wears a long wig, short beard, bead collar and long garment with short sleeves. In front of the deceased, similarly carved, is a table of offerings. Above the figure of Osiris is incised in vertical columns: (→)  (2) . Part of the sign  can be seen above this inscription. Five vertical columns of inscription, incised, extend from above the table of offerings to the back of the figure of the deceased :




*Preservation.* The stele is severely mutilated on the right-hand side. The upper portion of the left side is also damaged, and minor abrasions have occurred throughout. Traces of red paint are visible on the body of the man and on some of the offerings.

GLANVILLE, *B.M.Q.*, VI, p. 6 (Pl. VI).

## PLATE XLIII

No. 1735

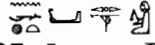
Statuette of  Sen-nether (*sn-nt*). Limestone. Height 49·5 cm. Provenance unknown. New Kingdom.

The figure, clad in a long skirt, is represented kneeling on a pedestal. The arms are bent upward at the elbow, and a casket, supported by the backs of the hands, is held against the chest. The inscription, which is incised, begins on the casket in two horizontal lines and continues in seven horizontal lines on the skirt.

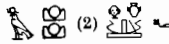

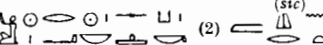








*Preservation.* The surface of the stone throughout is badly weathered and parts of the inscription, especially above the knees, are scarcely legible. Traces of red paint on the body and blue paint on the wig and hieroglyphs are visible.

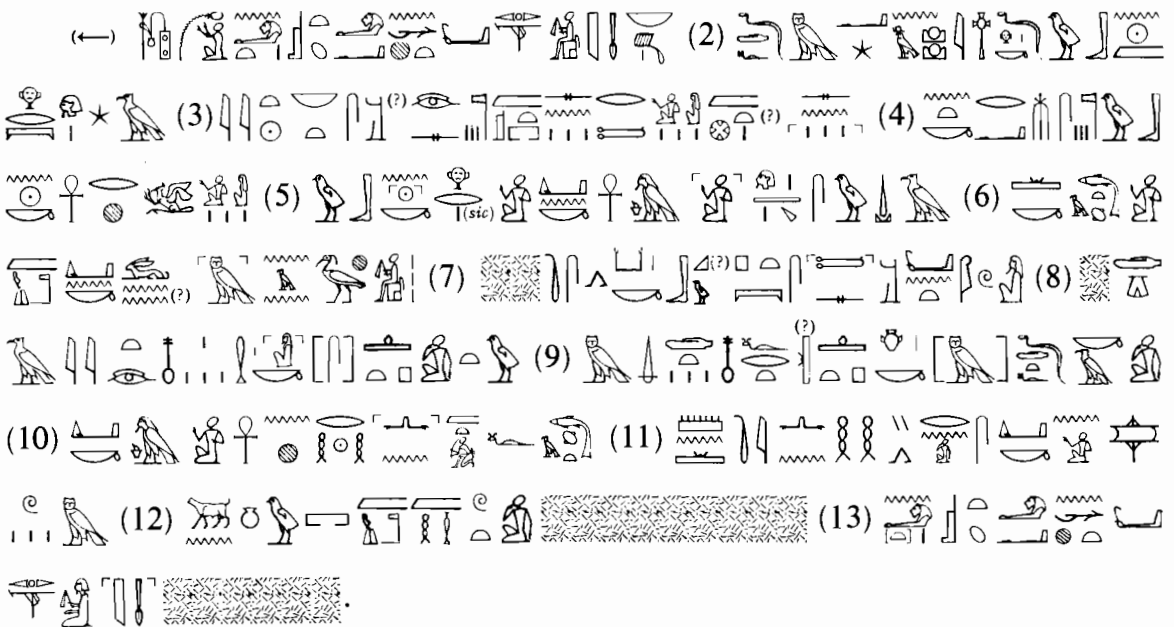
H. R. HALL, *B.M.Q.*, V, p. 50.




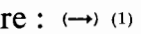
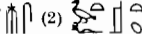

Statuette and round-topped stele of  Nekht-Menu (*nht-mnw*). Sandstone (?). Height 56 cm. Width 27.5 cm. Provenance unknown. New Kingdom.



The figure, wearing a long braided wig and long gauffered garment, is represented kneeling on a pedestal. The hands are outstretched holding a stele, which is carved in one piece with the figure and connected by a central support. The inscriptions are incised on the front and back of the stele, on the top and sides of the central support and on the left side of the pedestal.




The stele: In the arch, carved in sunk relief, the deceased person and his wife kneel in adoration before the Boat of the Sun, on the bows of which is seated a figure of Harpocrates. Above the Boat is incised in two vertical columns: (←)  (2)  ←. In front of and above the deceased is incised in five vertical columns: (←) \*  (2)  (sic)  (3)  (4)  (5)  (sic). In front of the wife is incised in one vertical column: (←) .



Below, in thirteen horizontal lines:

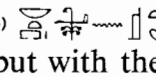



On the back of the stele, carved in sunk relief, are six figures, three on each side of the central support, kneeling with arms outstretched in an attitude of adoration. On the right is incised in vertical columns in front of each figure: (←) (1)  (2)  (3) . On the left, similarly incised in front of each figure: (→) (1)  (2)  (3) .

Central support. On the top, carved in sunk relief, are two figures kneeling with arms outstretched one on each side of a table of offerings. Above the table of offerings is incised in two vertical columns: (←)  (2) .




Above the figure on the right is incised in two vertical columns: (→)  (2)  .

Above the figure on the left is incised in two vertical columns: (←)  (2) .

On the right side, carved in sunk relief, is the figure of a woman, kneeling with arms outstretched in an attitude of adoration. She wears a long braided wig surmounted by a cone, and a long tight-fitting dress. Above and in front of the figure is incised in three lines, two vertical and one horizontal: (→) . On the left side, similarly carved, the same figure is repeated, but with the inscription reading in the reverse direction (←) and with the determinative  added after the name.

Pedestal. Of the two horizontal lines originally incised on the sides of the pedestal, only the first few words of the inscription on the left side remain.

(1) (→)  .


(2) (→)   .

*Preservation.* Both statuette and stele have suffered severe mutilation. The sides of the pedestal and the right arm and foot of the figure have been broken off. Some of the original paint remains: black on the wig; red on the bodies both of the statuette and of most of the figures in relief; blue on some of the hieroglyphs.

BUDGE, *Sculpture Guide*, p. 125.

## PLATE XLV















No. 1515








Round-topped stele of  Khā (*h<sup>r</sup>*). Limestone. Height 51 cm. Width 35 cm. Provenance unknown. New Kingdom.<sup>1</sup>








### TWO REGISTERS:

In the arch, carved in very low relief, is the winged disk.


FIRST REGISTER: Thothmes IV, holding in his right hand a cluster of papyrus and lotus flowers and in his left a censer, is represented standing before Amen-Rā and Aāhmes-*nefertāry*. The king wears the *hprš* helmet with uraeus and streamers, a bead collar, a short stiff skirt with girdle and tail, and bangles on wrists and arms.

Above him is incised in four vertical columns: (→)     (2)   (3)    (4) . Amen-Rā, seated on a throne  which is placed on a pedestal in the form of the sign , wears the plumed head-dress, beard, bead necklace, short gauffered skirt with tail, and bangles on wrists and arms. In his right hand he holds  and in his left . Above him is incised in two vertical columns:


(←)    (2)  . Behind Amen-Rā stands Aāhmes-*nefertāry*, wearing a vulture head-dress surmounted by two plumes, a bead collar, a long tight-fitting dress with girdle, and bangles on wrists and arms. In the right hand she holds  and in the left a fly-whisk. Above her is incised vertically: (→) 

   (2)  . Behind Amen-Rā stands Aāhmes-*nefertāry*, wearing a vulture head-dress surmounted by two plumes, a bead collar, a long tight-fitting dress with girdle, and bangles on wrists and arms. In the right hand she holds  and in the left a fly-whisk. Above her is incised vertically: (→) 

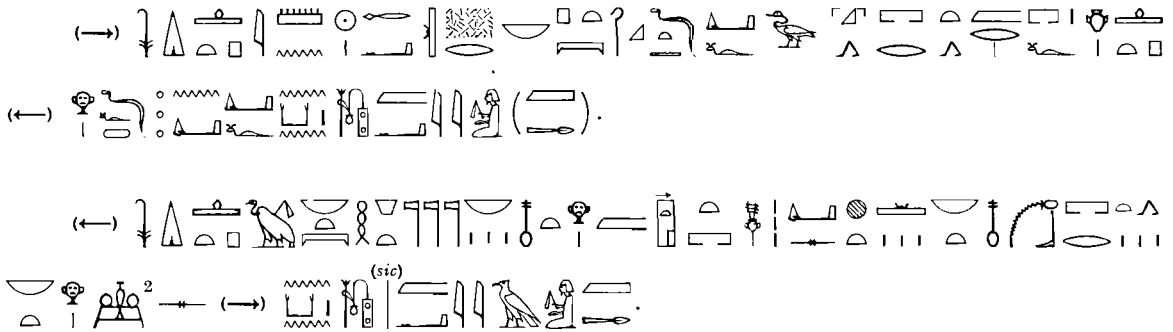
   (2)  .

<sup>1</sup> It seems improbable that the owner of this stele was the  whose tomb furniture is now in the Turin Museum. The style of decoration of the monument suggests that it is the work of XXth-XXIst Dynasties.




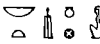
Offering-table of  Mây (*mry*). Limestone. Length 39 cm. Width from spout to front 38 cm. Provenance unknown.

The customary offerings of food and drink, carved in low relief, occupy the whole of the table, with the exception of a raised rim. On the rim are incised two inscriptions, beginning on either side of the spout and continuing in opposite directions to the middle of the front.

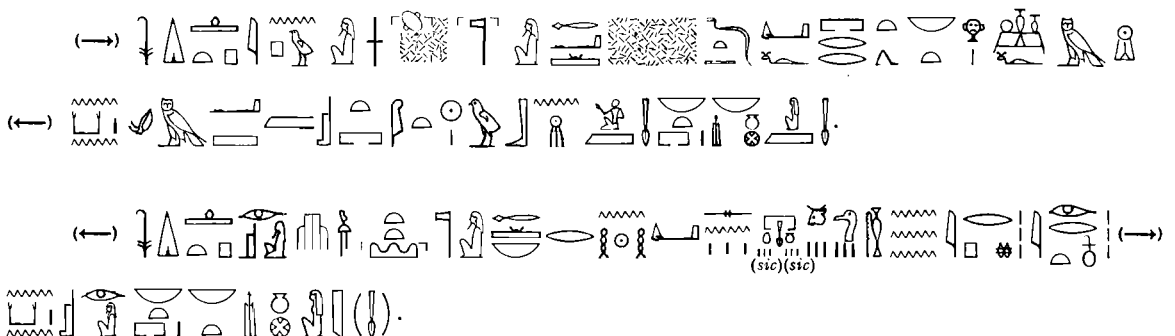


*Preservation.* There are small abrasions both on the raised rim and on the table itself, but some of the damage, notably that in the upper left-hand corner, must date from antiquity, because the inscription has been cut over it. There is no trace of paint.

BUDGE, *Sculpture Guide*, p. 153.

Offering-table of  Râ-uben (*rt-wbn*) and  Nebt-Āunu (*nbt-iwnw*). Limestone. Length 49 cm. Width from spout to front 43 cm. Provenance unknown. New Kingdom.

The customary offerings of food and drink, carved in low relief, occupy the whole of the table, with the exception of a raised rim. On the rim are incised two inscriptions, beginning on either side of the spout and continuing in opposite directions to the middle of the front.



*Preservation.* Apart from several abrasions and slight mutilation of the raised rim, the table is well preserved. There is no trace of paint.

BUDGE, *Sculpture Guide*, p. 153.

<sup>1</sup> In the original there are no loaves of bread on the table.

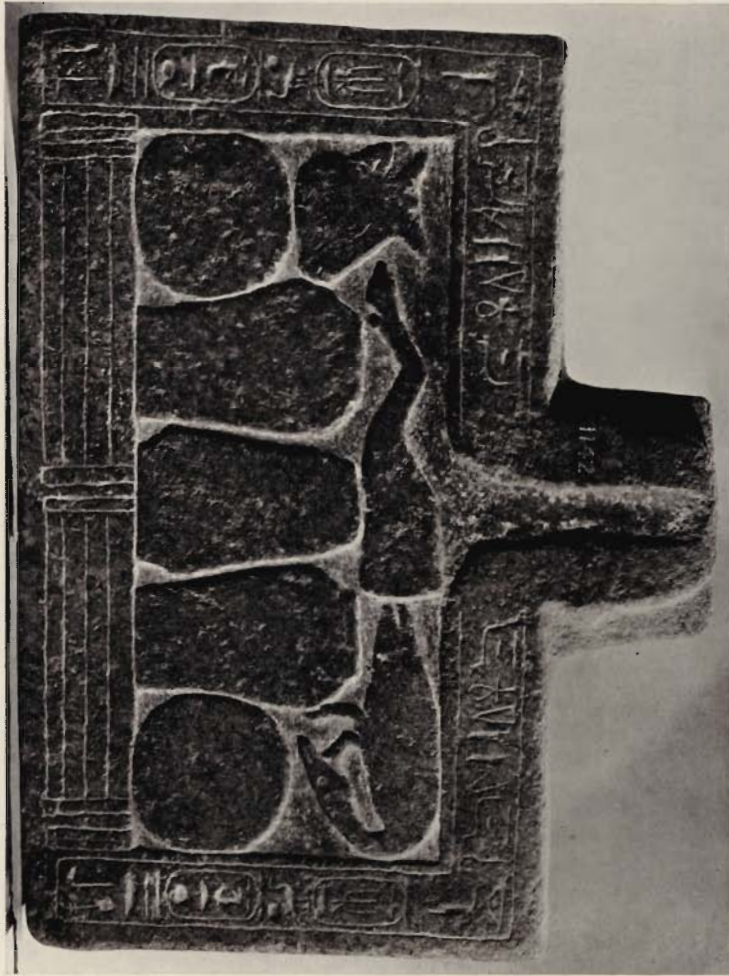




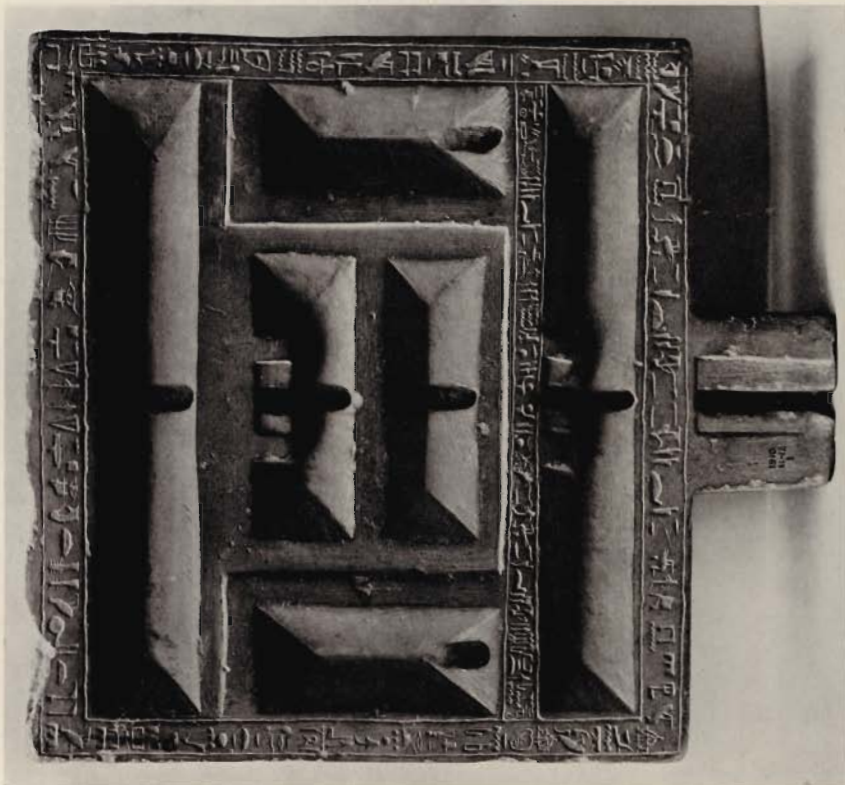


## INDEX TO NUMBERS

No.	Plate.	No.	Plate.
1	XIV	1000	XXIV
2	XV	1001	XVI & XVII
5	XI	1001A	XVIII & XIX
12	VI	1016	XL
21	XXVI	1019	IV
29	XXIX	1022	IV
31	VII	1068	XI
38	XI	1142	I
48	V	1210	XIII
103	XII	1222	XLIV
113	VIII	1332	XXXIII
155	XXXIX	1387	X
170	XXXIV	1511	I
295	XLI	1515	XLV
301	XXXVI	1571	XXXI
422	XLVII	1642	XXXVII & XXXVIII
468	XLIX & L	1708	II
550	XXVII	1735	XLIII
551	XXVIII	1743	XLII
552	XXVII	1782	II & III
593	XLVII	2304	XXXII
594	XLVIII	22557	XXX
657	XX	24430	XXXII
803	XXXV	24431	XXIII
826	XXI	48033	XXXI
902	IX	55616	XXV
935	XXVI	57399	XXII
989	XLVI		



No. 1142



No. 1511



No. 1708

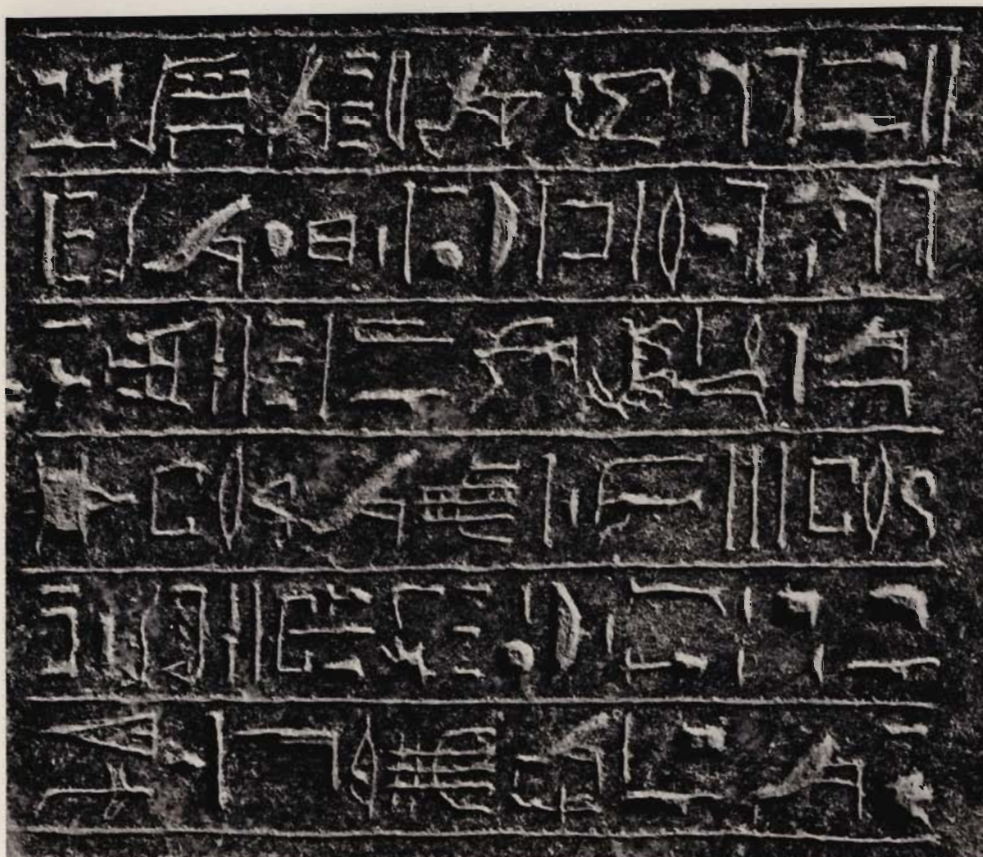


No. 1782 FRONT

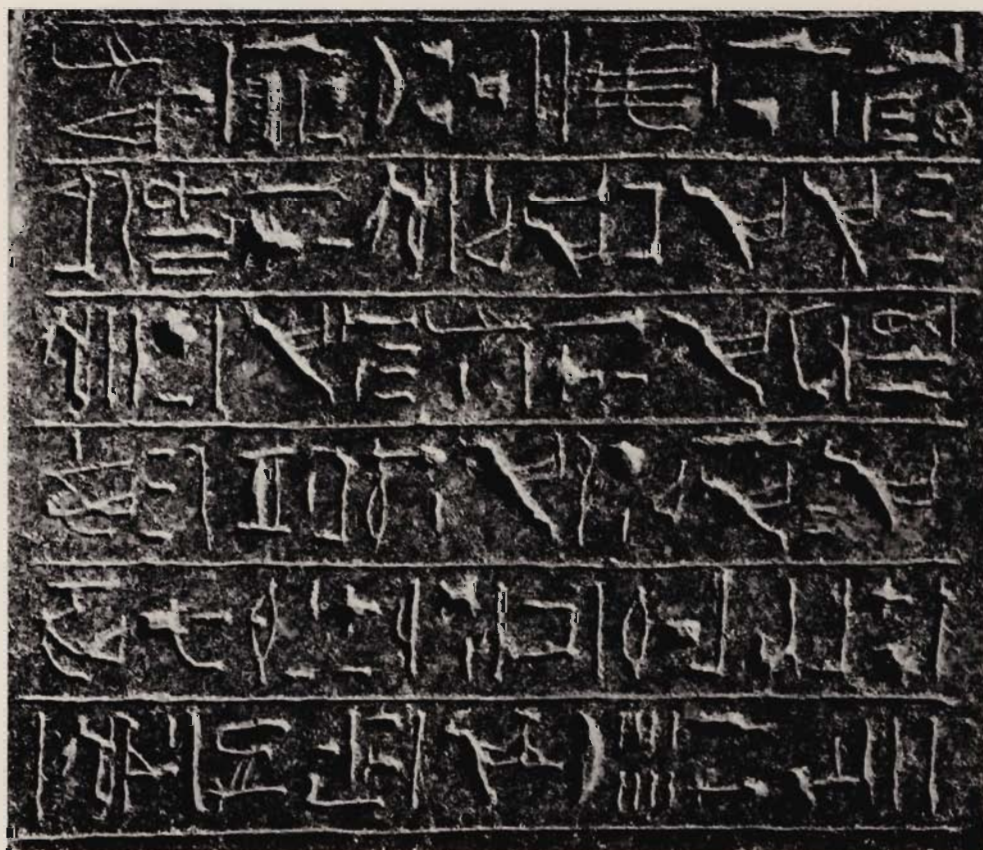


No. 1782 BACK





LEFT SIDE



RIGHT SIDE

No. 1782



No. 1019



No. 1022





No. 48





ABOVE—MENTHU-RĀ:  
LEFT



ABOVE—MENTHU-RĀ:  
RIGHT



ABOVE—KING: RIGHT



ABOVE—KING: LEFT



ABOVE—HATHOR B



ABOVE—HATHOR A



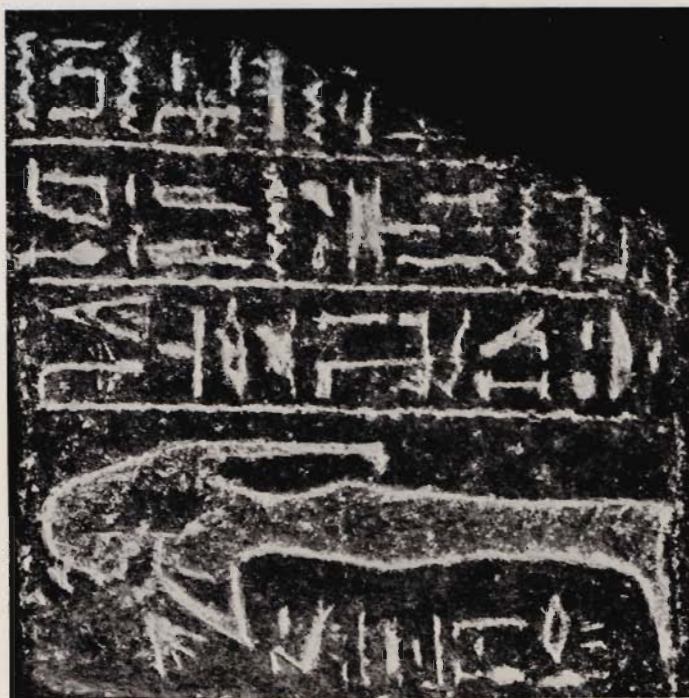


RIGHT



LEFT





LEFT OF CHAIR



SENT-NAY :  
RIGHT



SENT-NEFER :  
RIGHT



SENT-NAY :  
LEFT



SENT-NEFER :  
LEFT



No. 902





No. 1387



BACK OF THRONE

No. 5



RIGHT  
PANEL

No. 5



LEFT  
PANEL

No. 5



PEDESTAL OF BABOON

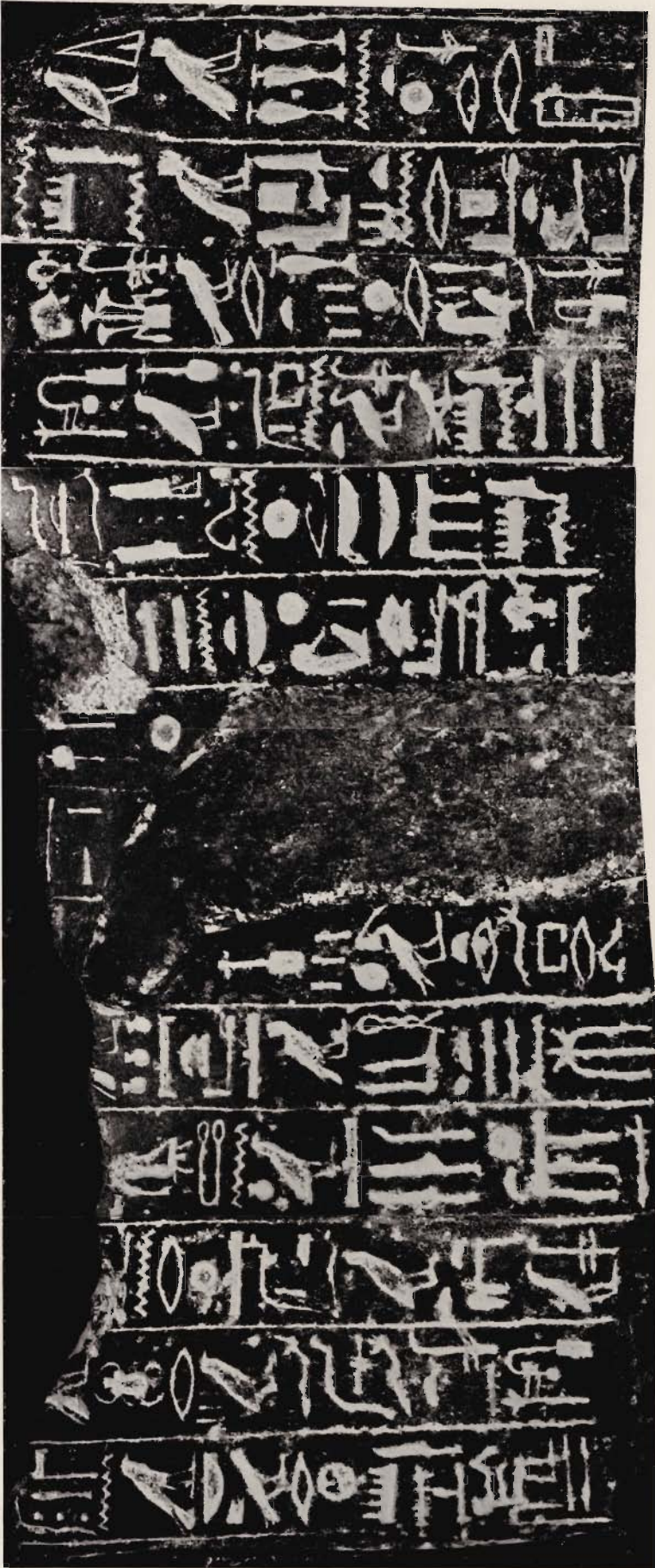
No. 38



CENTRAL BAND

No. 1068





PAPYRUS ROLL

No. 103



No. 1210



No. 1210 BACK SUPPORT





UPPER SURFACE OF PEDESTAL



FRONT AND ENDS OF PEDESTAL



BACK AND ENDS OF PEDESTAL



BACK AND ENDS OF PEDESTAL



BREAST



FRONT AND ENDS OF PEDESTAL



CONTINUES FROM RIGHT OF ABOVE







BREAST



PAW



FRONT OF PEDESTAL



FRONT AND END OF PEDESTAL CONTINUED

No. 2



No. 1001



TOP OF HEAD



FOOT





LEFT SIDE



LEFT SIDE CONTINUED



RIGHT SIDE

No. 1001



LID



LID: FOOT END



BOTTOM: FOOT END

No. 1001A





RIGHT SIDE



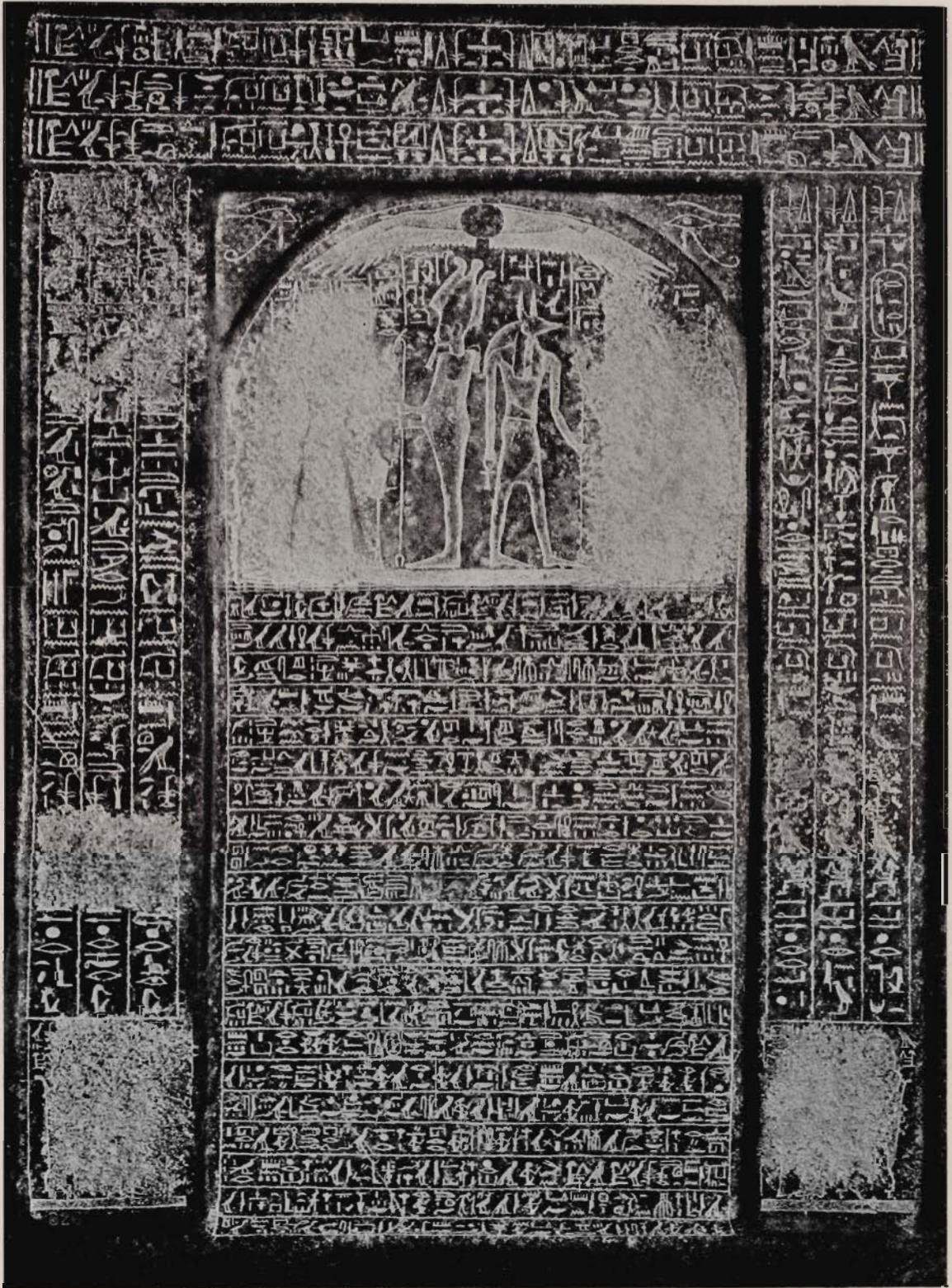
LEFT SIDE

No. 1001A









No. 826





No. 57399





No. 24431



SIDE



FRONT



SIDE



BACK

No. 1000





No. 55616



BACK SUPPORT

No. 935



CENTRAL COLUMN

No. 21



PEDESTAL

No. 21

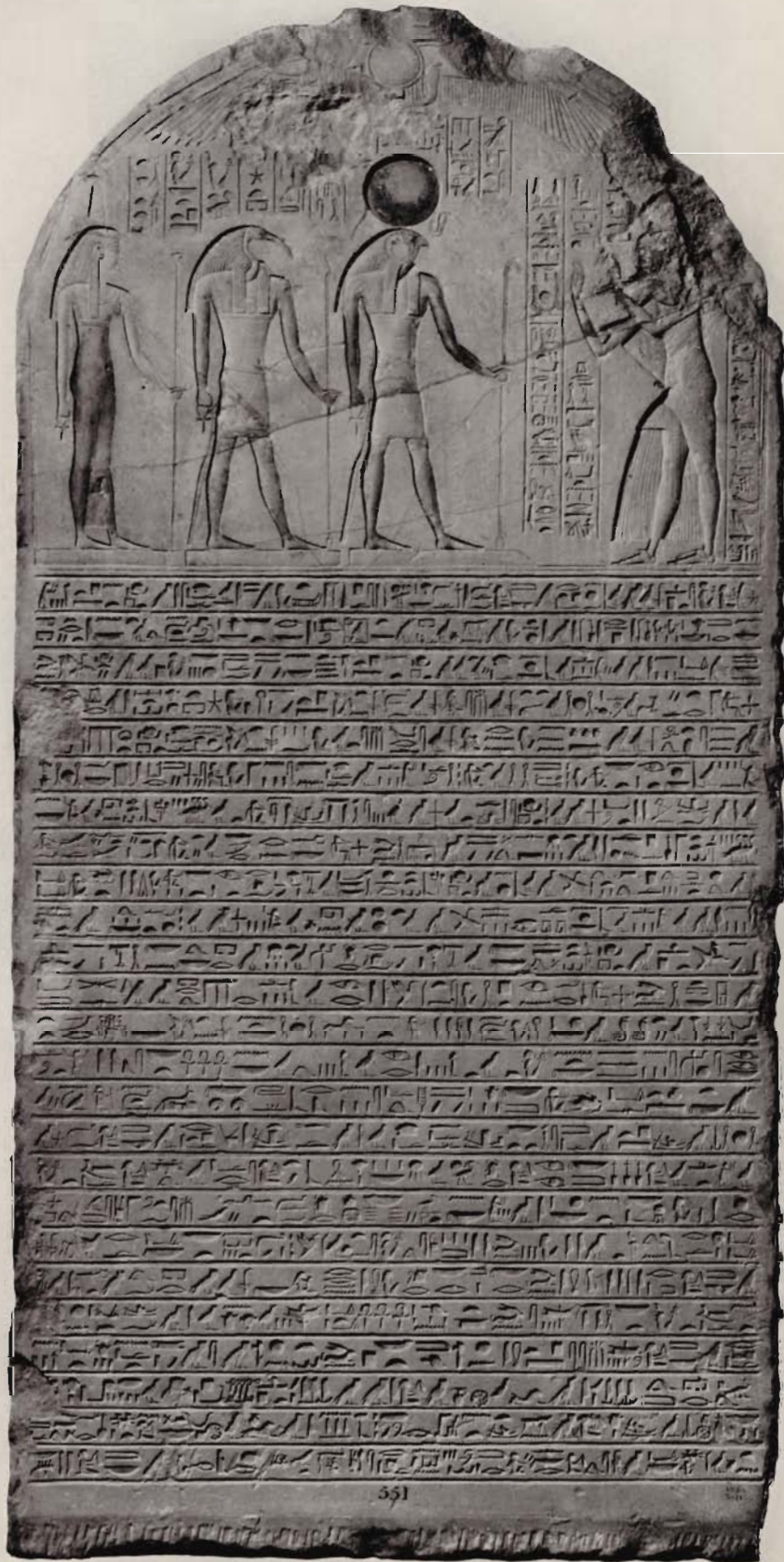




No. 550

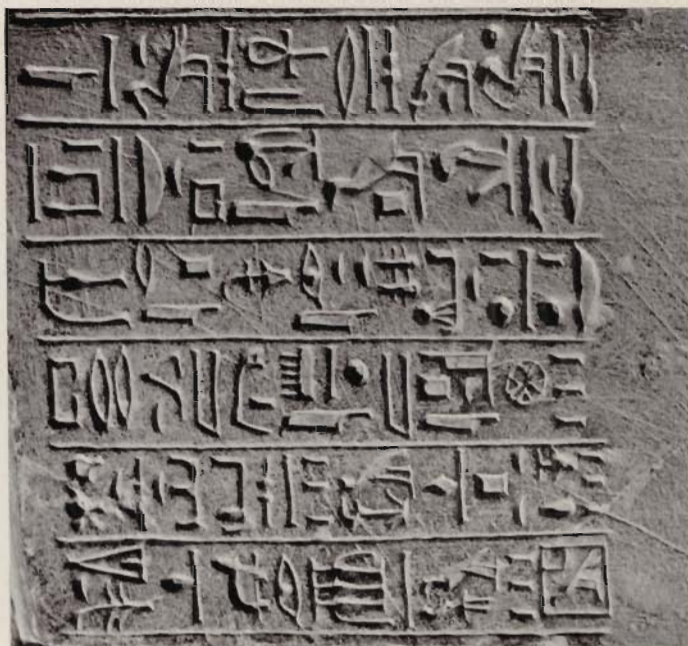


No. 552



No. 551

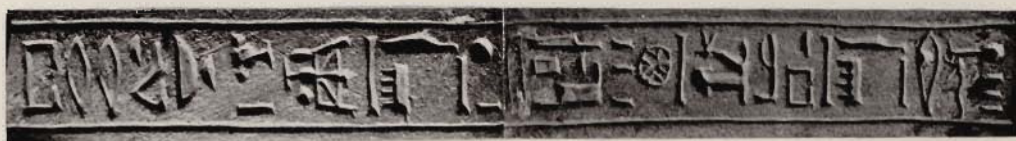




LEFT SIDE OF CHAIR



SKIRT OF ĀPU



SKIRT OF  
ARY-NEFERU

No. 29



RIGHT SIDE OF CHAIR



No. 22557





No. 1571



No. 48033





No. 2304

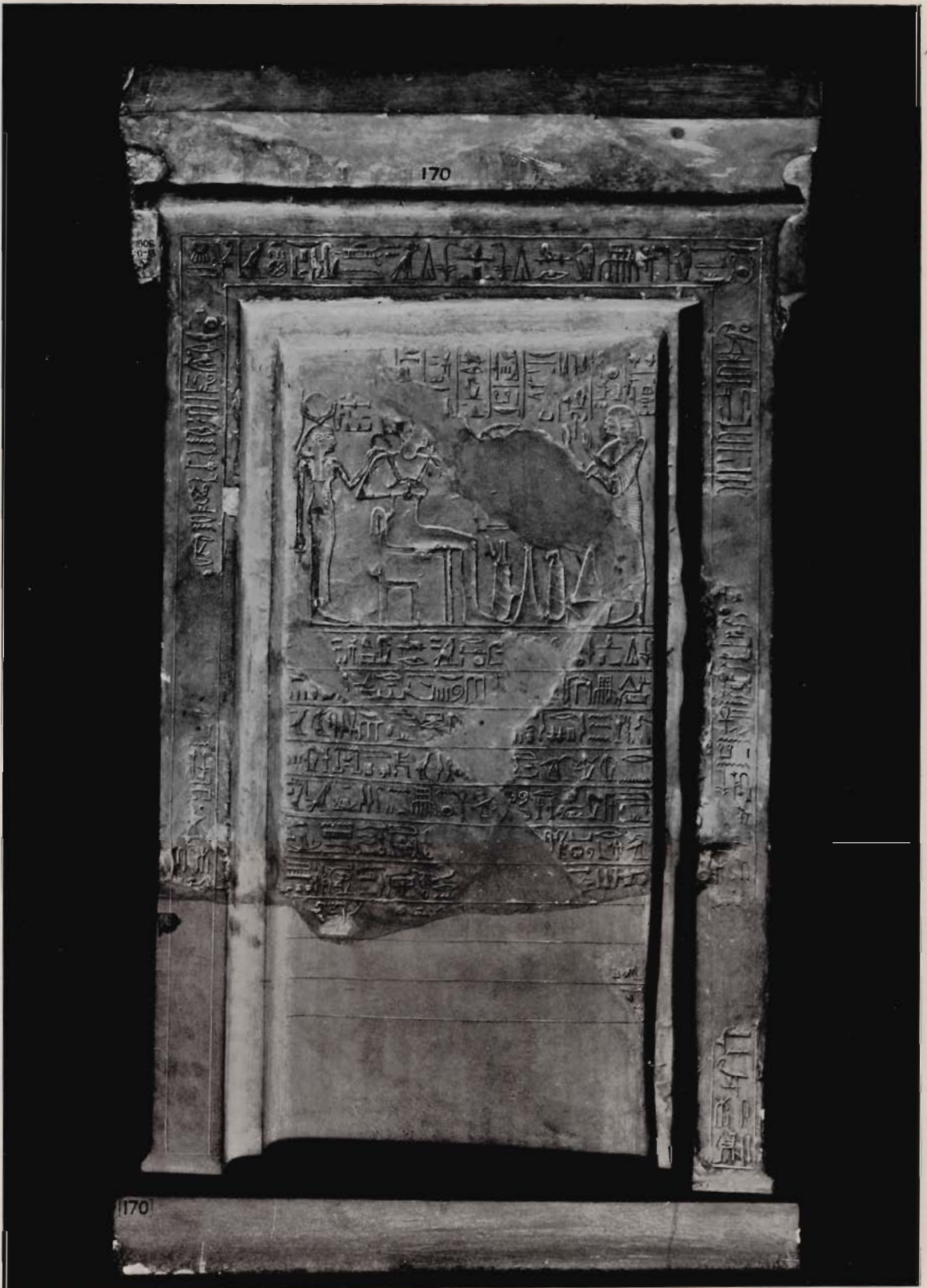


No. 24430



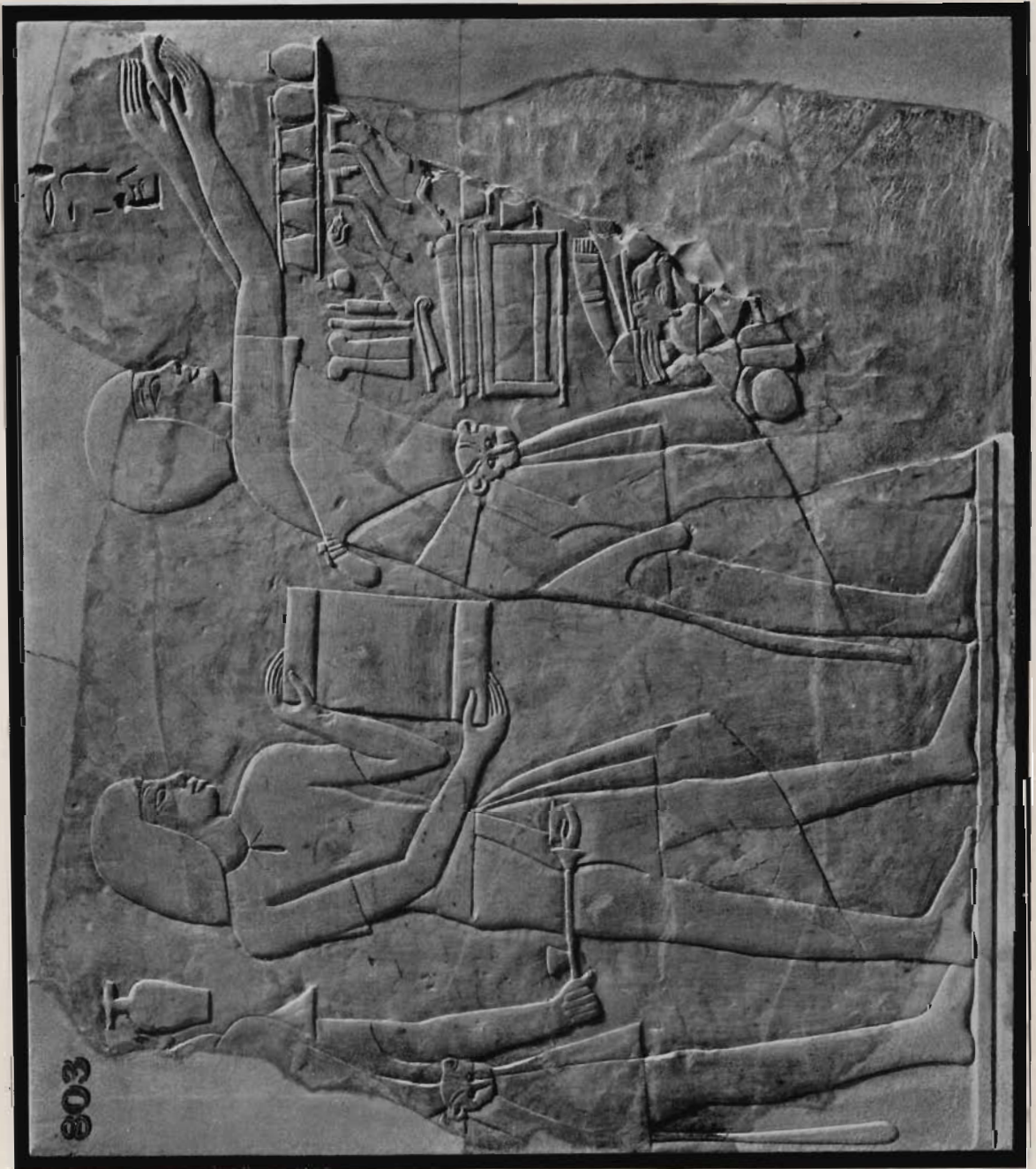


No. 1332



No. 170





No. 803



No. 301





No. 1642





HEAD END



FOOT END



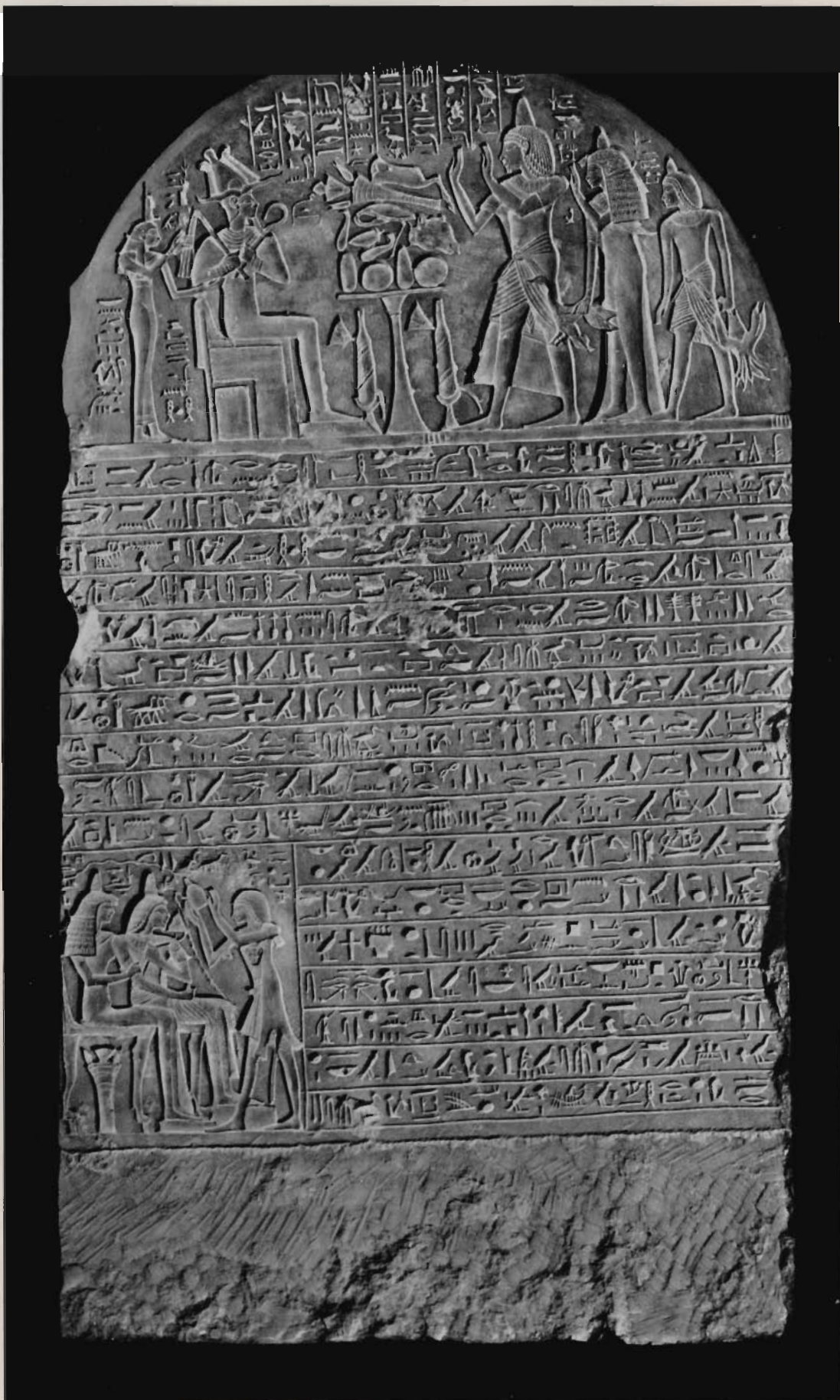
RIGHT SIDE



LEFT SIDE

No. 1642





5  
10  
15

No. 155







No. 295





No. 1743



CASKET



SKIRT



SKIRT BELOW KNEE

No. 1735





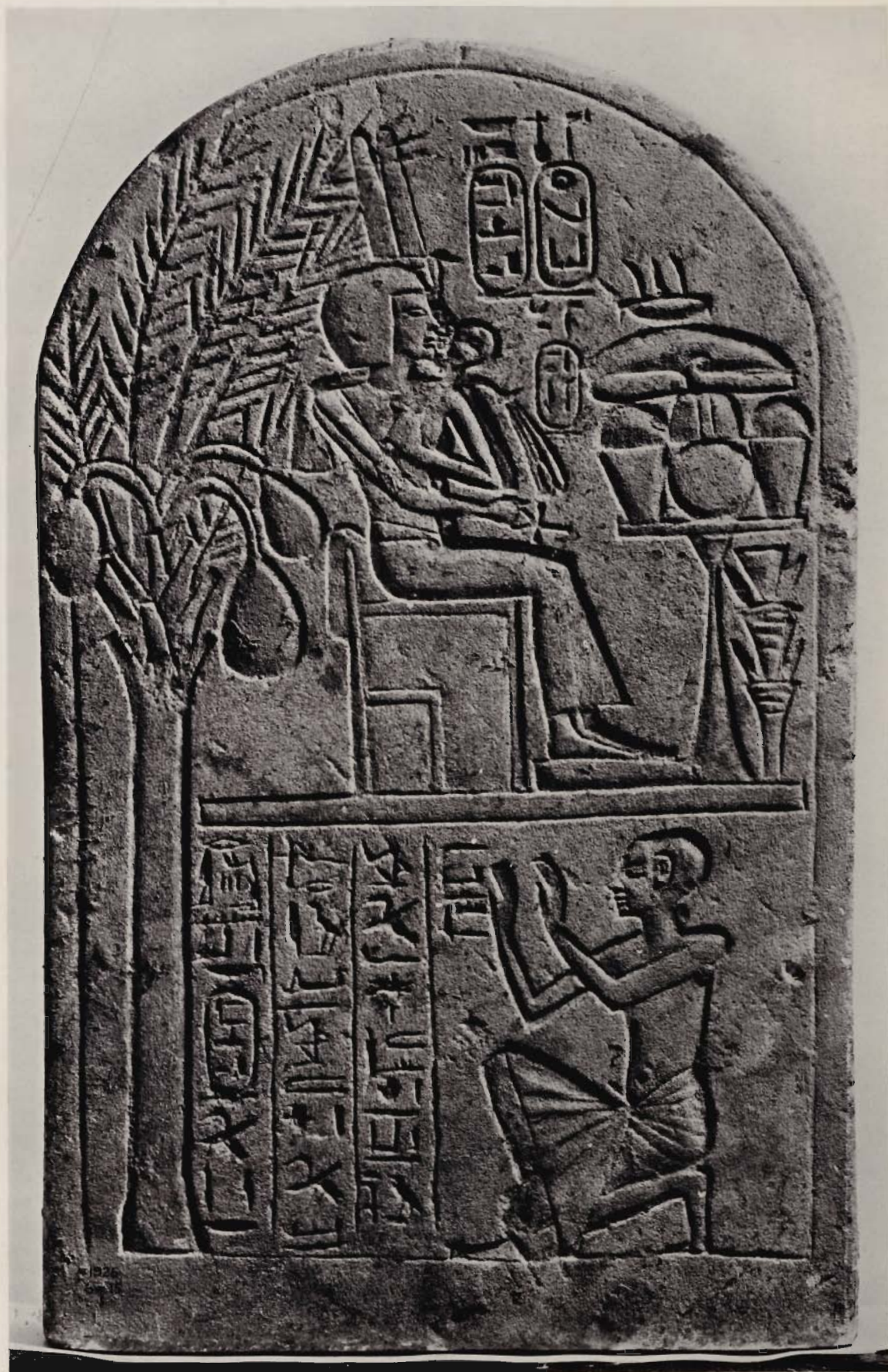
No. 1222





No. 1515





No. 989





No. 422



No. 593



No. 594



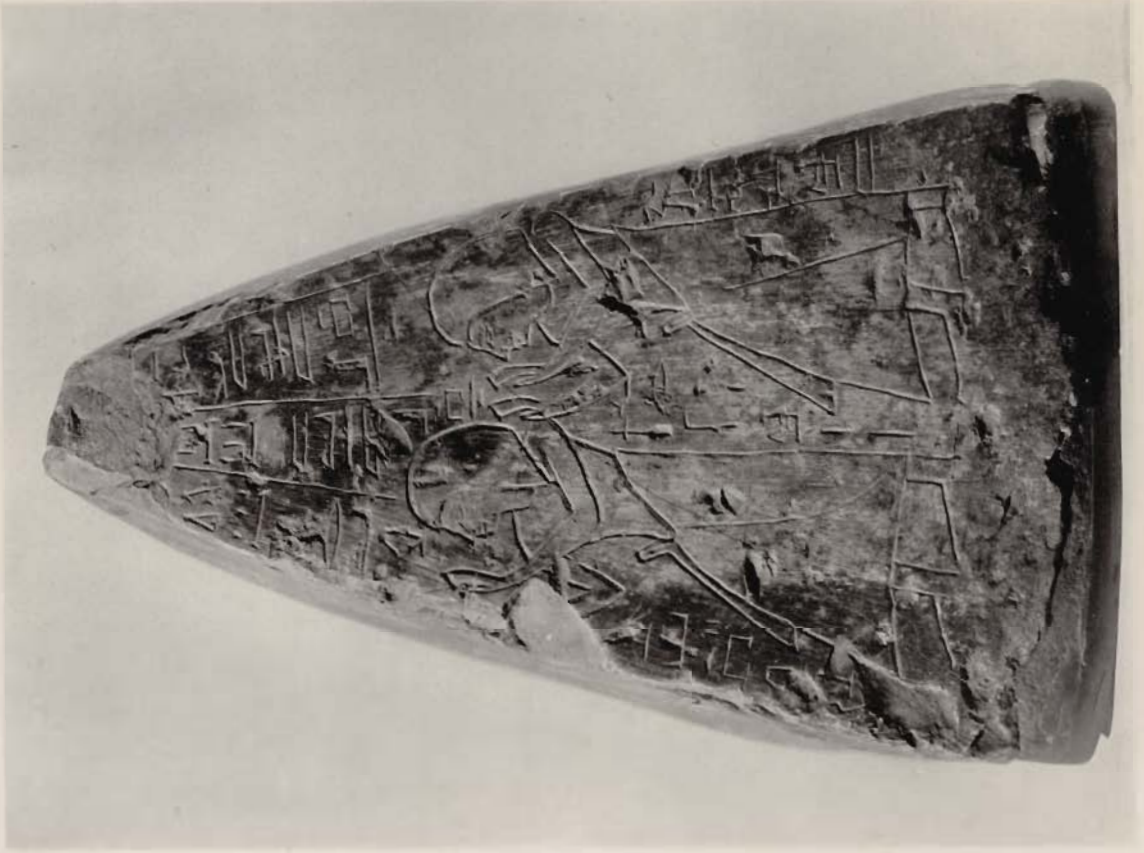


SECOND SIDE



FIRST SIDE

No. 468



FOURTH SIDE



THIRD SIDE

No. 468