

# 50,000 Volt DC Power Supply

**DANGER**  
HIGH VOLTAGE

# 378

#379

Copyright 2003 Creative Science



These plans use the old Diode and Capacitor Method, Turn 120 vac. into 25,000 to 50,000 volts DC of earth shaking power! Amperage depends on what size capacitors you use. The higher the micro farads of the cap, the higher the amperage rating. Use an AC amperage meter on the input wire, once you find out how much amperage the cap is rated at, use diodes 2 x's higher that rating, Example: 200 uf x 360 v photoflash capacitors will use about 3 to 4 amps max, so you will want to use diodes rated at 6 to 8 amps x 400 to 450 volts. If you exceed the rating you can cause a fire hazard or a cap or caps can blow up! Please be careful. NOTICE! Use rubber gloves when working with high voltage, we are not responsible for anything in these plans you build at your own risk!

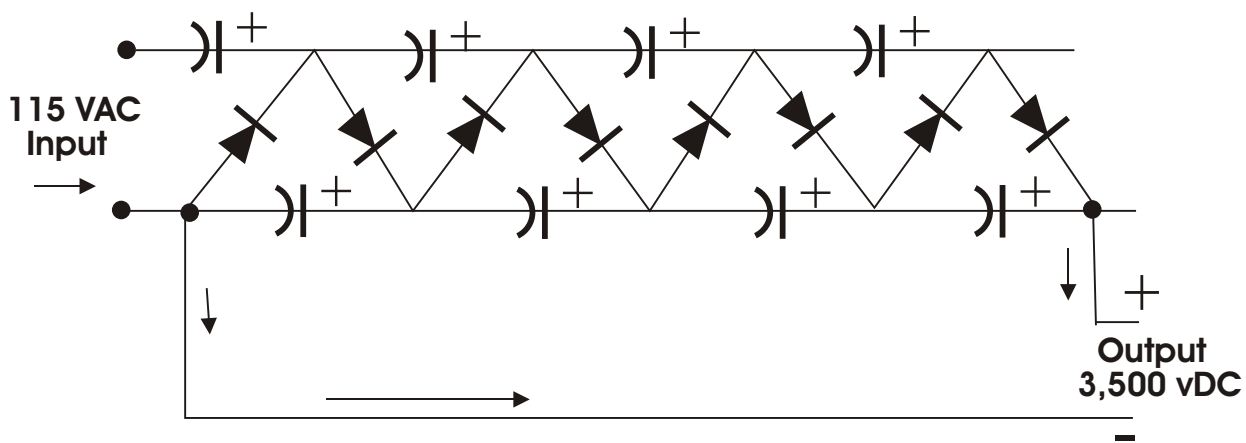

▲ = Diode

)|<sup>+</sup> = Electrolytic capacitor

Cover

# 50,000 Volt DC Power Supply

**DANGER**  
HIGH  
VOLTAGE

# 378

#379

Copyright 2003 Creative Science



Capacitor's rated at 360 V x 200 uf, Diodes rated at 400 v x 6 amps



Optional: For higher amperages you can use High power diodes or rectifiers. 40 amp x 600 v



AC Amp Meter



**WARNING:** We are not responsible for anything in these plans you build at your own risk..... Be carefull high voltage can kill..... Use rubber gloves and rubber shoes when working at anytime around high voltage, it only takes one mistake and it's over for you...

**WARNING:** Always Discharge capacitors before touching them.... use a stick with a high amperage wire attached to one end then attach the other wire end to capacitor + side, then touch the other end of the wire that's attached to the long dowel rod wood stick and touch the Negative side of the capacitor it will short it self out not harming the capacitor, do not look into spark it is an ark spark and can blind you. Again: **WARNING:** This article deals with and involves subject matter and the use of materials and substances that may be hazardous to health and life... do not attempt to implement or use the information contained herin, unless you are experienced and skilled with respect to such subject matter and substances... neither the publisher nor the author make any representation as for the completeness or accuracy of the information contained herein, and disclaim any liability for damages or injuries.....

## A Cascade Multiplier

Add more stages for more Multiplication... Use capacitors and Diodes rated for twice the input voltage. Output ripple can be reduced by using large values for the capacitors.....

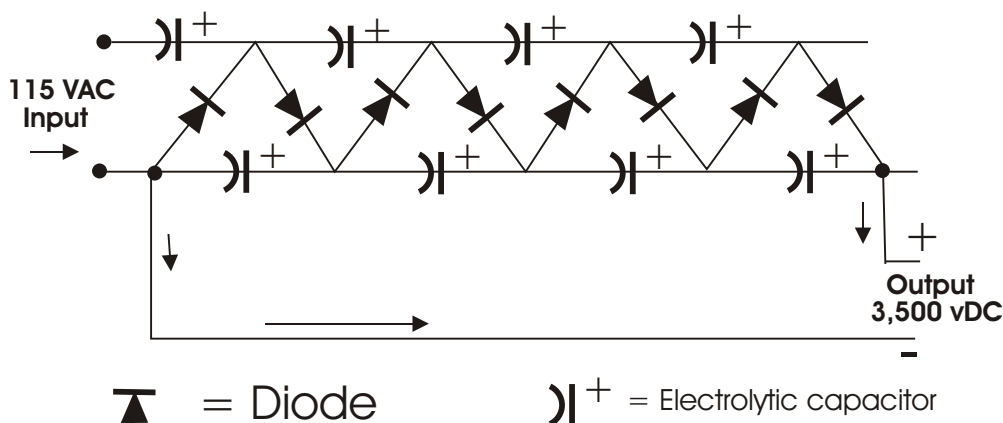

## Voltage Doublers

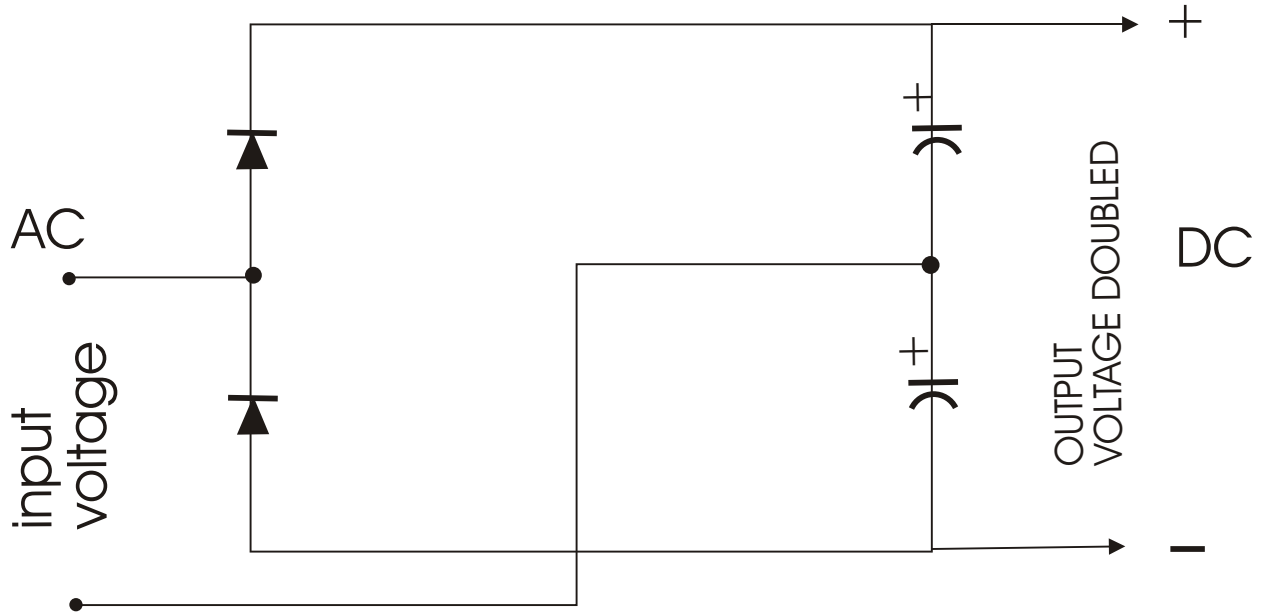

## Voltage Tripler

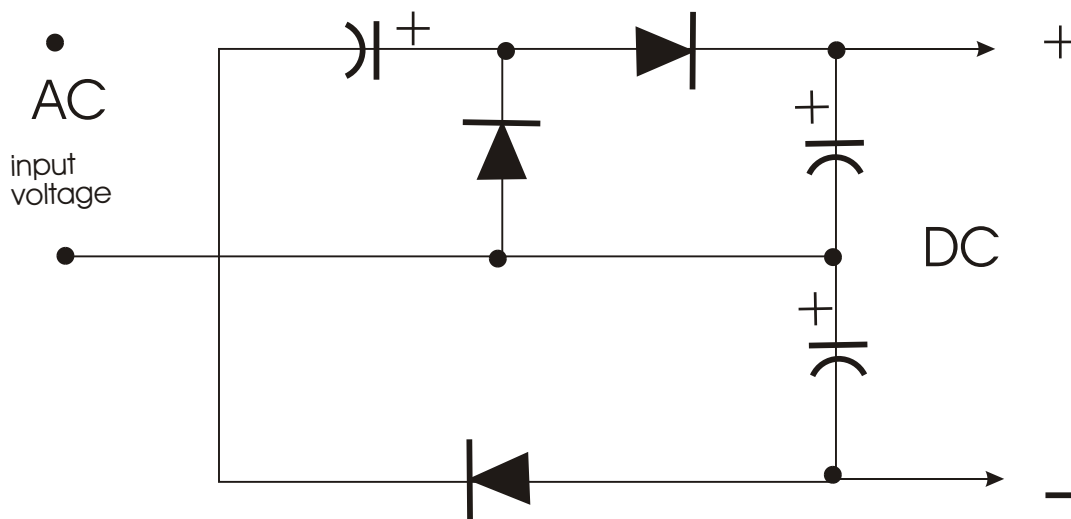

TRIPLES AND CONVERTS AC TO DC, Again use capacitors and diodes rated at 2 times the input voltage...

If you have been looking for a good way to generate high voltage then these plans are it! Great for many free energy experiments and free energy motors. Also great for small anti-gravity air craft experiments.

Stepping up voltage by using diodes and capacitor combinations have been around for a long time.

If you do not know anything about Capacitors or Diodes, then Radio Shack has a book you can Purchase for about \$15? called "Getting started in Electronics " it's written by *Forrest M. Mims*, and will teach you very Quickly what a Diode and Capacitor is and there many functions. It also teaches you about how to soldier which is very important in the construction of many of our free energy devices and circuits.

WE HERE AT CREATIVE SCIENCE WANT TO THANK YOU FOR BUYING THESE PLANS,... IT WILL HELP US HELP OTHERS, WE ARE DEDICATED IN HELPING THE POOR WHO CAN NOT AFFORD ELECTRICITY OR GAS FOR THERE HOME'S, AND TO EDUCATE THE WORLD ABOUT FREE ENERGY.....

### Construction Tip!

When constructing your capacitor multiplier diode circuit, it is good to use a PC plastic board with multiple holes. you may have to drill the holes bigger to fit your leads through. Component leads are inserted through the holes and thin copper foil or thin sheeting can then be cut and used to join one component to another. Each lead will then be soldered to the copper, I find this is much faster and neater to do than anything else I have ever tried before. Rick invented this method.

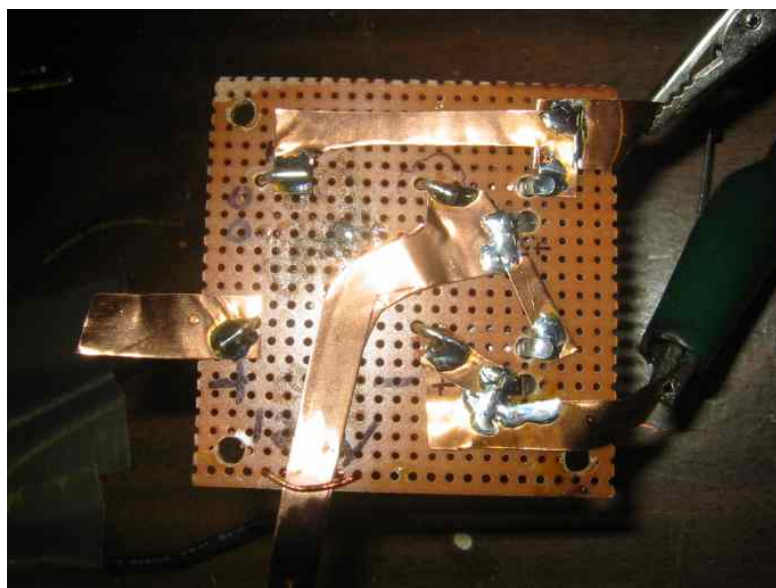



4 amp, 4 diode bridge rectifier under glass!  
We are using 120 vac input and raises voltage  
to 300 vdc to power our 3/4 hp free energy elec-  
tric motor.

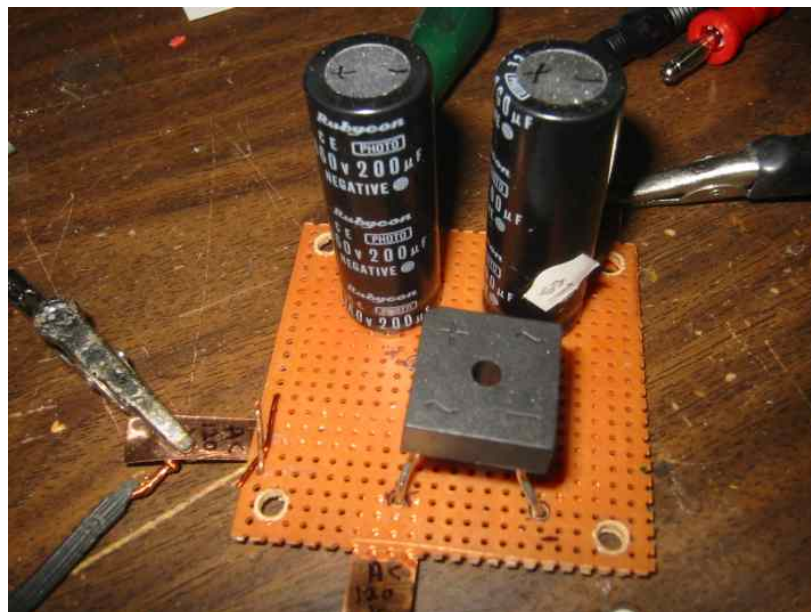

# 50,000 Volt DC Power Supply

**DANGER**  
HIGH  
VOLTAGE

# 378

#379

Copyright 2003 Creative Science

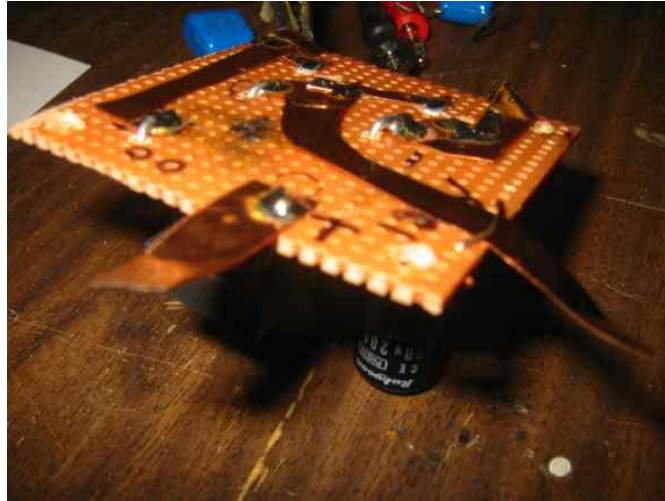

You can buy thin copper sheeting from an art supply store or your hardware store. Usually if a hardware store or art store does not have it they can order it for you.

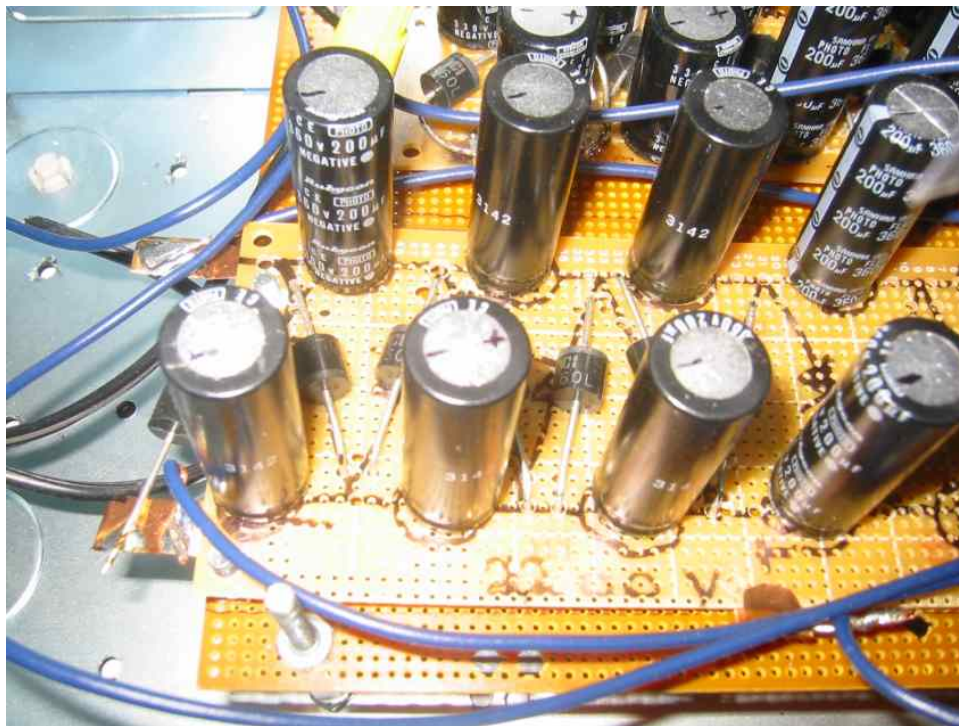

# 50,000 Volt DC Power Supply

**DANGER**  
HIGH  
VOLTAGE

# 378

#379

Copyright 2003 Creative Science

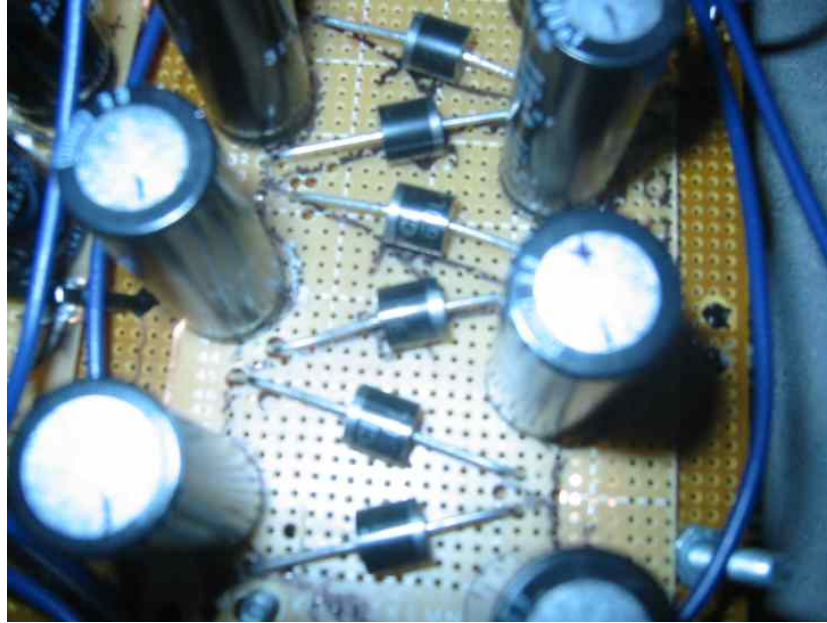



## Cascade Voltage Doublers

Figure 3

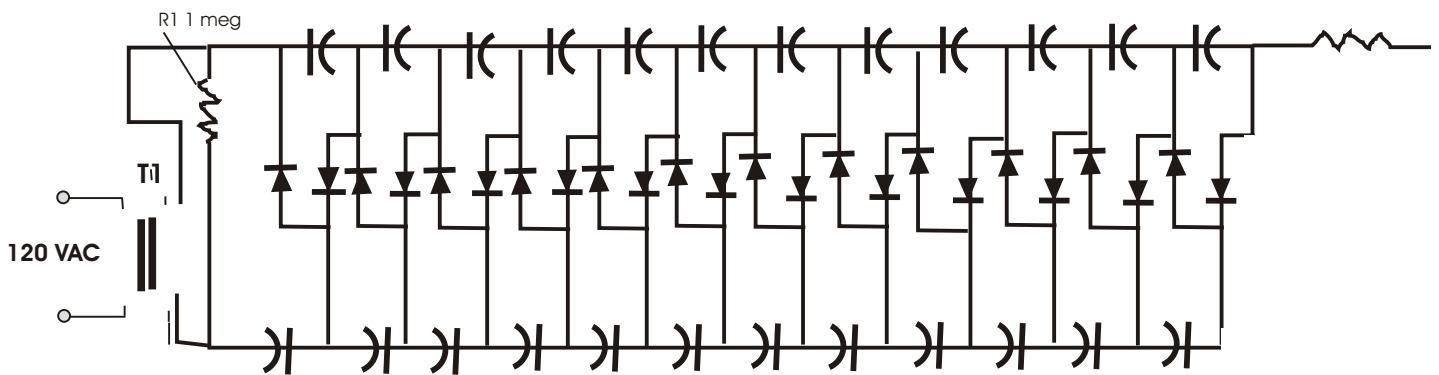

Uses 1n4007 diodes rated at 1,000 volts with 0.068 or 0.1 uF capacitors.

## MEASURING HIGH VOLTAGE DC

Voltage measurements will be possible only to about the second or third stage of a cascade voltage doubler with most voltage meters..... Beyond that you will need to use either a high voltage DC meter or an external voltage divider for use with standard high impedance voltmeter (10 megohms or more.)

A good divider that can be used for the purpose of high voltage measurements is the RCA sk3868/DIV-1, a high voltage DC divider; it's used in TV's to reduce the final anode voltage going to the CRT to the level required for the focus voltage. It consist of resistors R1 (200 megohms) and R2 40 megohms,

Connected in series, as shown in figure 4. There are three leads, one for the free ends of each resistor, and the other at their juncture. If you put both a 10-megohm meter and a 2.7-megohm resistor (r3) in parallel with the 40-megohm resistor you can achieve almost exactly 100:1 range multiplication. For a full scale deflexion of 20,000 volts DC..

to be measured on the 200 volt meter scale.....

### Figure 4

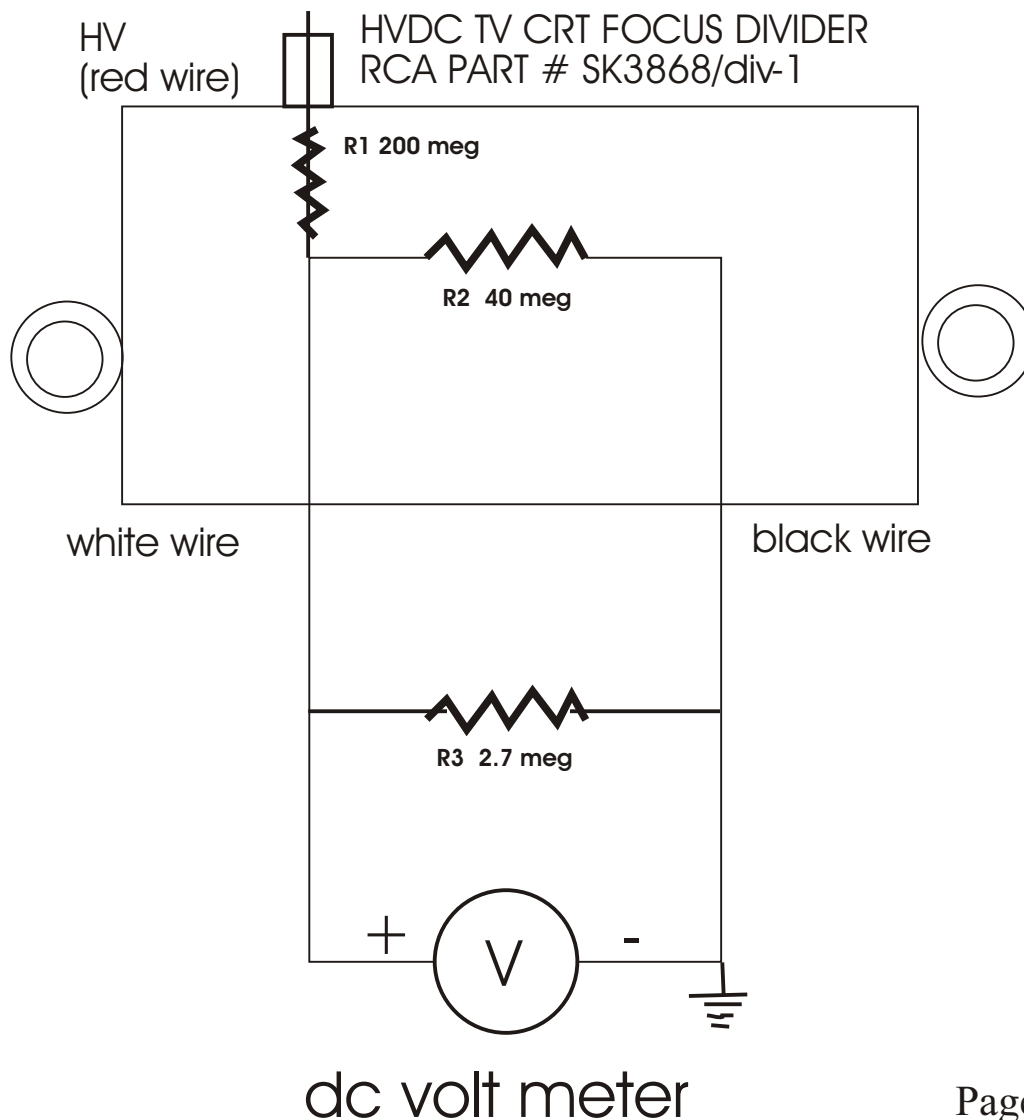

# 50,000 Volt DC Power Supply

**DANGER**  
HIGH  
VOLTAGE

# 378

#379

Copyright 2003 Creative Science



A computer casing makes a great project case



## Cascade Voltage Doublers

Figures 1-3 show four additional voltage doublers. the one shown in figure 1 is the most straight forward.. If you build it, use #1n4007 diodes with peak inverse voltages of 1,000 volts = 1kv and 0.068-0.1 uF capacitors with working voltages of 400 volts DC.

Figure 1

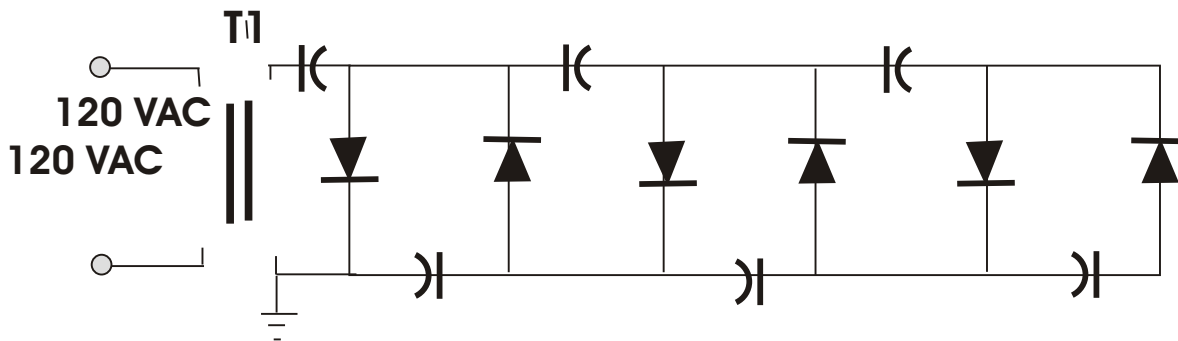

Uses 1n4007 diodes rated at 1,000 volts with 0.068 or 0.1 uF capacitors.

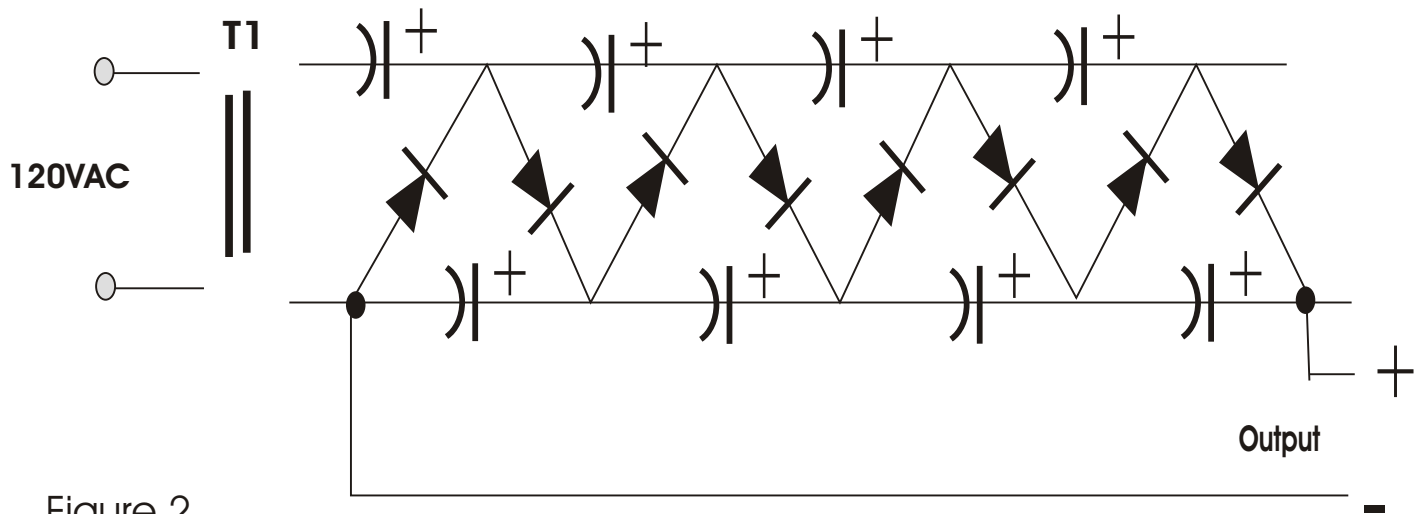

Figure 2