

+



**CREATIVE SCIENCE
& RESEARCH**
P.O. BOX 557 NEW ALBANY, IN. 47150

Time is running out

FREE ENERGY

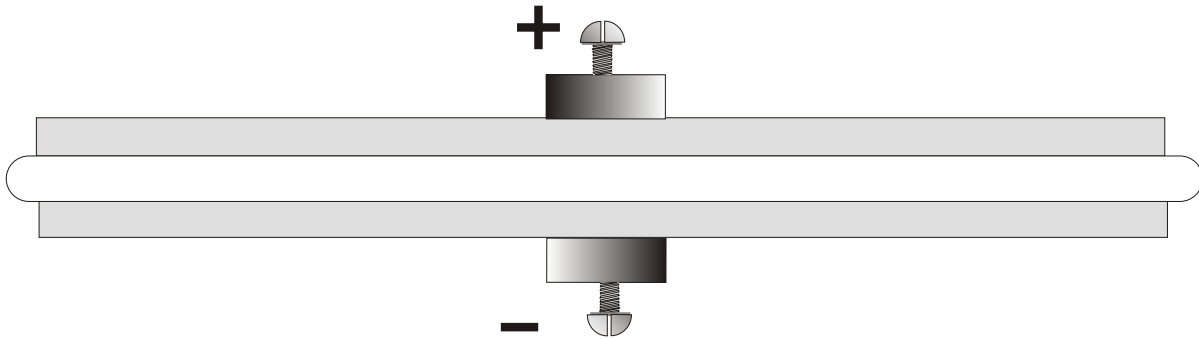

Build an Experimental Electret Cell

FREE NEWS REPORT AS REPORTED TO US!

We are not responsible for anything in these plans, It is reported to you as was given us, **YOU BUILD AT YOUR OWN RISK. WARNING! USE RUBBER GLOVES WHEN WORKING AROUND HIGH VOLTAGE.** Keep all high voltage devices away from children! Again you build at your own risk.

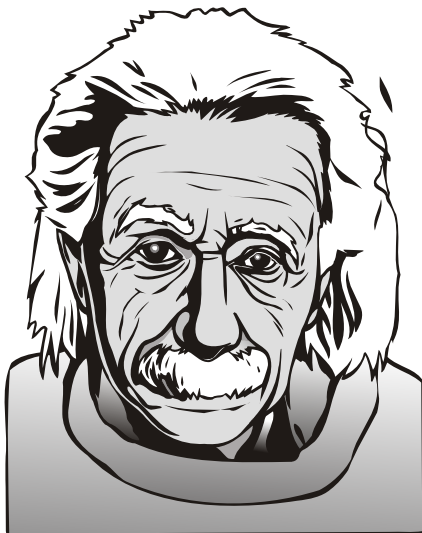

We have been told by other research companies that this does indeed work! But please note we have not yet had the time to build one for ourselves, so please let us know of your progress.

See us at: www.fuellesspower.com

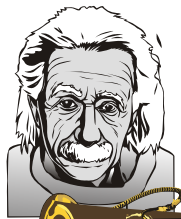

CE
IEN
VE
CREA
& RE
H
ARC
SE

Time is running out

2000

FREE ENERGY

+

#H757

CAPACITORS That recharge Themselves!

When you build this energy "Cell" it is in many respects like a magnet, in that it acts to have ENERGY even after you discharge or release its energy. So where does this energy come from? Does it come from the atmosphere or is it like a permanent magnet, You might say its basic operations appear to be exactly like those of making a magnet.

In making a magnet, you place a piece of steel or iron in a coil of wire and send a current through the coil, The atoms in the steel or iron then all align up in the same direction and this attracts other simplar metals to the magnet you have made. The electret Energy Cell is made much in the same way a magnet is made, in that we apply a high voltage to the material and it then turns into a self powering cell! You can then discharge it and then it will lose its power for one second and then regain it back again. WOW! IT RECHARGES ITSELF! This places this energy capacitor cell in the FREE ENERGY group! But where does the power come from????

The very first Electret made that was able to retain its charge, was made by Dr. Eguchi, The Japanese physicist. He under took this experiment, by taking some wax known as "Carnauba" and placing it between two metal plates. He heated the Carnauba until it became soft and pliable He then applied two wires, One to the upper plate and one to the lower metal plate and connected these with highly insulated wires, (Neon Transformer wire, Neon sign shops have them.) to a high voltage system that supplied DC or rectified DC Voltage. With The high voltage still remaining on the 2 plates, one + and one -, he then simply removed the heat from the plates. He then allowed the wax to cool and harden again with the high voltage still on the 2 plates! (Power supply can be a 9,000 volt AC transformer and using diodes to turn it into DC current. so you will get a positive and a negative on you volt meter.)

At this point he disconnect the power supply to the metal plates, He then discovered by placing a wire to one side of the plate to the other, as to short out the capacitor plates, a large amount of voltage was given off! WOW! He then.....cont.....page 2.

Plate #1

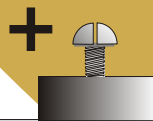
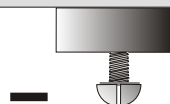

Plate #2





**CREATIVE SCIENCE
& RESEARCH**
P.O. BOX 557 NEW ALBANY, IN. 47151

CAPACITORS
That recharge
Themselves!

#H757

He then discovered that on placing a wire, touching one side of the electret capacitor to its other side, a large amount of voltage was given off, Allowing a few seconds to pass he again tried it and to his total amazement the same amount of voltage was again given off! **WITH NO LOSS OF POWER OR ENERGY! WOW!**

This discovery led to the use of this strange and mysterious **POWER CELL** which was used to power telephones by the Japanese during world war two! (Powered By Free Energy!) Many years have passed and the discovery of this amazing power cell was forgotten and placed away for future reference. But today interest has again taken over this remarkable discovery and today a new telephone microphone, Using an electret capacitor for power is being tested and researched at the Northern Electric Lab, at Ottawa, Canada. next they feel that as well as saving up to 95% in power to power modern telephones, they will also be able to produce a radio loud speaker using a similar powering system. We might call to your attention also that the modern transistor is not a new invention. the first transistor developed was discovered many years ago, it was called the Lilenfield transistor. This to was put away and shelved. So many discoveries have been lost due to the over assurance by Universities and others that fail to see nor to be able to project their minds into the discoveries that have been made by the average none scientific youth. this is true to even a greater extent today! we have lost thousands of important discoveries, simply because they were discovered and invented by a person who did not have any way to finance nor to develop his own invention and had to more or less depend on Universities or Government research departments.

Science is not for a few well educated men or women or youths, it is for everyone who wants it! The electret capacitor that can keep a charge up to 12 years is still in it's infant stage, I am sure that you the reader will find some outstanding discoveries concerning this capacitor. Please share it with us so we can share it to the world.

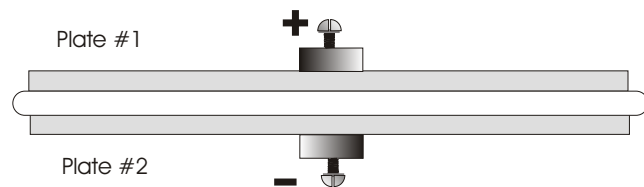
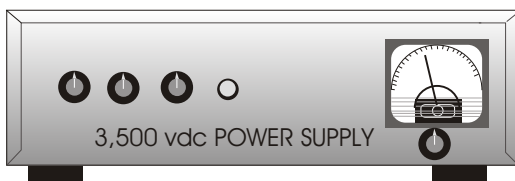

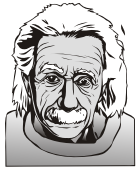

**CREATIVE SCIENCE
& RESEARCH**
P.O. BOX 557 NEW ALBANY, IN. 47151
www.fuellesspower.com



#H757

How The Electret is similar to a capacitor

A Capacitor acts to store electrical charges and unlike a battery, when you short it out , (that is when you use a wire to short the + and the - terminals together) the capacitor discharges very quickly, the will give off a loud explosive sound, this is the discharging of the power that was stored inside the capacitor.

The Electret acts very much like a capacitor, except it continues to RECHARGE ITSELF! and continues to be able to give off great amounts of electricity, voltage, and power on shorting its two sides together. WOW!

Here is the theory in part as to how it works: Some theories as to how it works were presented by, Dr. Gamant and Dr. Bernard Gross, Of The Northern Electric Labs, - Canada.

We are now going to give you two technical names, #1 The Hetero Charge, The name simply refers to the kind of charge placed on the material we will use to make an electret. They feel it means as follows: That when you charge your material, the charge of high voltage applied to the materials acts acts to align up to polarize (Again like a magnet) the straight lines of atoms that the material is made up of. Next, the #2 the homo charge, is caused by free positive and negative groups (charges) developing on the material. When we apply the high voltage to our soft heated materials and allow it to remain on our two plates until the material cools and becomes cold. They feel that the power applied to the materials act to attract the positive ions to the positive side of the material and the free electrons then travel around and attach themselves to the negative side of the electret, The polarization of the atoms in the material, then acts to align up the atoms, and the ions are also aligned up in a manner(ions are either highly charged negative or positive particles of energy!

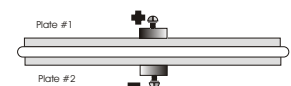
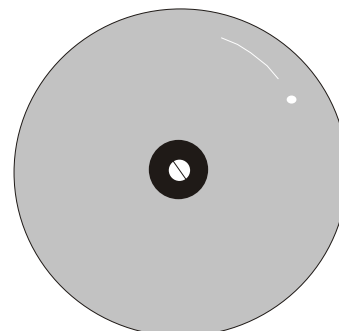
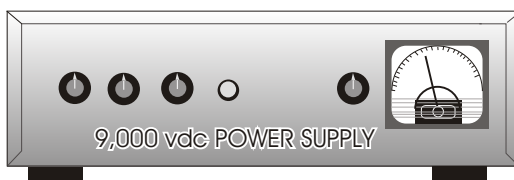

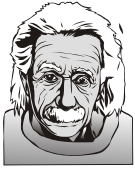
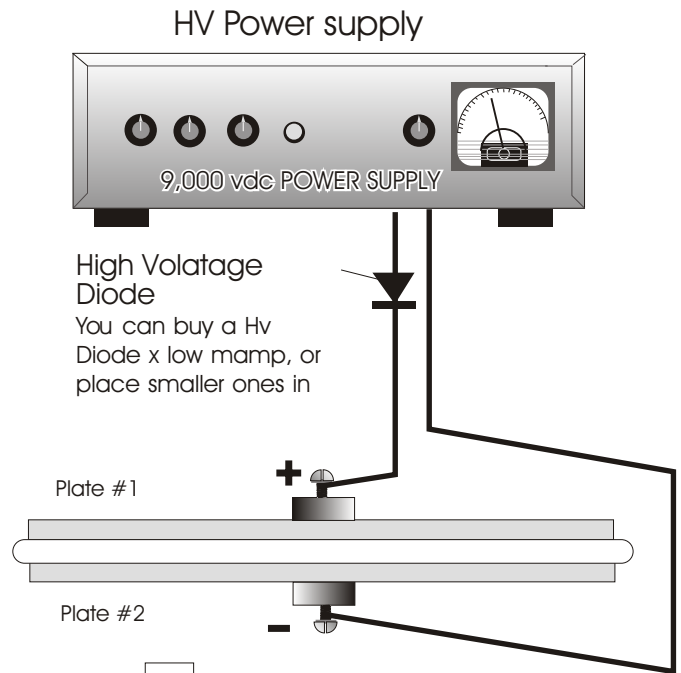

Fig 1. Prep and heating Electret

At this point you can use 3,000 to 20,000 volts DC power supply in the milliamps to charge the electret. A great power supply for this can be bought at any neon sign shop or sign supply house. The power supply will be AC, But you will need to turn it into DC by using a high voltage diode that will match you output of your power supply. Using a small conventional oven or out door grill, Place the electret on a microwave plate (Something that will take the heat) and use high temp wire to connect from power supply to electret or use standard wire with and place wire on glass so you will not short out power supply. The + & - must not touch! Then place wire onto electret that is in the oven and shut door, make sure wire does not move around, best to use high temperature tape or such to hold wire into place. Place rock or brick weights on electret so it will stay pressed together as a tight sandwich, if it is loose, you will loose your charge. 200 to 300 degrees should do nicely. heat until you see Carnauba or plastic get real soft. use a fork.



When it is soft then slowly shut door and turn on your power supply, Watch for sparks there should be none. (See further instructions for how long.)

After the correct amount of time you turn off the oven only! DO NOT TURN OFF POWER SUPPLY! keep power connected while it is cooling and getting hard again. See next pages.



OVEN



That , Since atomic alignment of the material itself happens, then acts to provide a recharging possibility to take place. The recharging of the power to the material then seems to be reforming of atoms, that make this power possible and when this is done we should consider that the power is also coming from the free charged particles that are found in our atmosphere, air, etc.....

The Electret is not to be considered a battery, nor as a capacitor. IT IS A SELF POWERING COLLECTOR and storage place for energy-Free Energy!

A very interesting thing about an electret is that it must be kept shorted out by either wrapping it in aluminum foil or having a wire connected to both of its two sides when not in use. or it will soon die and and loose it's energy (same as a perm. magnet must be shorted out.) (Very interesting indeed!) Much like a magnet it must always have a keep bar when not in use to keep it strong!

NOT ALL MATERIALS CAN BE USED TO MAKE AN ELECTRET!
The word dielectric simply means a material that acts as an insulator, Wax is a dielectric the same as glass, yet glass cannot be used to make an electret, It does not have atomic arrangement necessary for the charge to remain. It's atoms and molecules are not arangible or polarisable if I can use the word, to be realigned and used as a self charging chargeable material, as is Carnauba Wax. Carnauba wax seems to be the best!
Glass and many clear plastic or paraffin wax is not good to use, they just will not work. These have no electret properties that are at all suitable for making an electret.

FACTS YOU SHOULD KNOW ABOUT THE ELECTRET!

First, some dielectric materials such as resins, sulphur and certain other materials as well as other forms of plastics, develop only what we now know to be called, The HETERO CHARGE, this is a charge that simply forms on the surface of suitable dielectric material, this charge remains on the surface in this way. as soon as the electret is made it is wrapped up tightly in aluminum foil and placed away to age, After a week it is then opened up, and using a short piece of wire, place the wire across the electret to short it out to produce one short out flash after another. WOW! FREE ENERGY! Use a voltmeter then to check the amount of discharge in volts. Now this is very important: The charge remains the same, One side is always positive and the



Cont... This is explained as follows; When this material is charged and by heating between two metal plates THE HIGH VOLTAGE IS APPLIED UNTIL COOL AND COLD!, Then disconnected from the electret.

The Hetro Charged Electret was measured and found to give off a high charge of electrical energy only when a short was placed across it's two plates! (Creative Science: If this is true you may not be able to measure voltage with a meter only when a load is on electret????) They account this as being that the face of the material being charged with the positive high voltage, had acted to pick up a negative charge and the negative charged side had picked up the positive charge and this remained for several months only while wrapped tightly in aluminum foil. and this for some strange reason is necessary to start it working. It must be kept a week in the foil to allow the polarization to fully take effect.

Now this Hertro Charge lasts only for a few months. Only certain materials will form this single sided charge. (Creative Science: they must be talking about the Carnuaba Wax.)???

The Hertero Charge Electret was made with a high voltage a little higher than 10,000 Volts DC., Being applied to the plates. The voltage was then increased to about 15 to 20,000 volts DC and a new electret was born! One that the charged remained for up to 12 years. This type of new charging method was then known as THE " HEMO CHARGE" The increased voltage to the material plates then acted to alter the simple short lived Hetero charge that had such a short life. It acted to cause the simple, short lived Hetero Charge to die away to nothing after 2 weeks, but after 2 weeks it changed its polarity! The negative side became positive and the positive side became negative. and the charge acted to stay strong for up to 12 years. THIS IN IT SELF IS AN OUTSTANDING DISCOVERY!

HOW TO MAKE AN ELECTRET!

You can check with chemical or scientific supply stores to locate some of the early used - " Carnauba Wax" Though we will not be using it in our electret. Because LUCITE PLASTIC in sheet form can be obtained easier. Hobby shops, Plastic suppliers, Hardware stores, Sign Shops, Neon Sign shops etc.... Lucite we were told is also known as " Acrylic Plastic and also known as Plexi Glass, if it is a true Lucite material I do not know, Some companies use these words loosly to refer to something that has replaced another material. Check with plastic co's. or just go ahead and try what you can get. if it does not work then its not the right stuff!

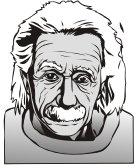

#H757

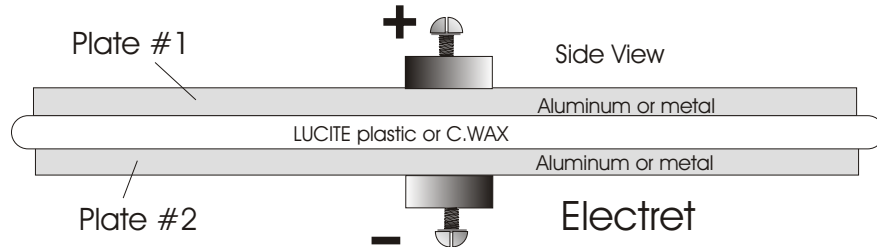

SEE FIG 1. page 4. The electret plates can be made of aluminum for example, a good starting size for your first experiment can be about 8" x 8" or 8" diameter. You will need one oven, 2 - 6 foot pieces of high voltage wire which you can get at any neon sign shop. This is much safer to use when using high voltage, 10,000 to 20,000 volts will jump across thin insulated wire and get you or short out. which is not good for your transformer. While you are at the Neon Sign shop ask them to sell you a 15 to 20,000 volt neon transformer which plugs into 120 vac house current. Or if you know some electronic genius who loves to take apart old TV sets ask them to make you a 20,000 volt power supply using a TV set. This is simple and no problem m to them. Tell them to make it safe! Now you will need some LUCITE Plastic about 1/8" thick x 9.25 inches square or in diameter.

BE SURE TO WEAR RUBBER GLOVES WHEN EXPERIMENTING WITH HIGH VOLTAGE, IT CAN KILL YOU. USE ONE HAND TO HANDLE IT WHEN YOU CAN. SO IT WILL NOT GO THROUGH THE HEART. YOU WILL THANK ME LATTER.

Do not preheat oven. Now See Fig 1. page 4. Connect power supply as seen and put in the oven as written. Now after plastic is very soft it may only take 30 min to bake., again after it is soft turn off the oven, only! **DO NOT TURN OFF THE 15,000 VOLTS OF POWER!** allow charge to form on plastic for at least ONE HOUR, Then turn off power supply of 15 • 20,000 volts. When plastic is then cool and hard and has a charge then do this next; Using rubber gloves take small metal clamps that have a spring inside them, (Hardware store) and before you remove the bricks, clamp plates top and bottom on both sides, try not to move plates at all. so you will not lose your charge. It is important to keep plate 1 and plate 2 pressed as tightly as you can together with the LUCITE plastic still in between. Now take aluminum foil and wrap it around the entire electret and let it sit for one week and then test it out by shorting the two plates, remember if plates move you can lose your charge, keep clamps on tight and or use strong rubber bands, you may need up to 4 clamps if you are making an 8" electret.

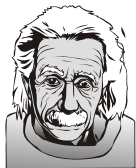

#H757

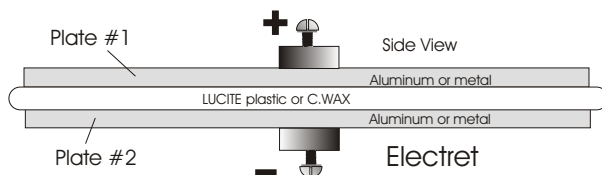

After the week has passed, when you remove the aluminum foil you tightly wrapped the entire electret in. **DO NOT GRASP BOTH SIDES OF THE ELECTRET WITH YOUR BARE FINGERS**, you will get a real shock if you do. use rubber gloves. Remember the electret (If you made it exactly as described, should be ready to produce energy as soon as you UNwrap it or a few minutes after that.

We have been told that this really works, so if it is true and you can get about 15,000 volts x 10 milliamp then **WOW!** you can make dozens of plates and place them in parallel to increase the amperage until you get 3 - 5 amps x 15,000 volts.?? or you should be able to rig up a small timer switch to discharge the one 15,000 volt x 10 milliamp electret and by using a 50 volt X 27,000 uF electrolytic store bought capacitor you can step down the voltage to gain more amperage! you should be able to get 50 volt DC x 3 amps. **WOW!**)

Please write to us with your results and comments concerning the electret, and we will pass it on to other customers and we can use your name if you like.

Making two metal plates to attach to each side of the electret:
Any clean metal should do. It would be best if your metal or aluminum were not too thin as your electret can bend too easily and lose the charge. Remember to always keep your electret capacitor shorted out when you are not using it. copper also works well.

So now the world of electret is open to you. So research and experiment and see what you can do with this **FREE ENERGY POWER** that will last up to 12 years.

Thank you

David Waggoner

Creative Science & Research P.O. Box 557 New Albany, IN. 47150
(812) 945-5839 see us at: www.fuellesspower.com

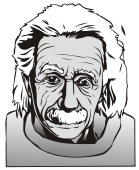

#H757

