

# Free ELECTRICITY From The Sky

© PATENT PENDING - COPY WRITE  
1996 - 2001

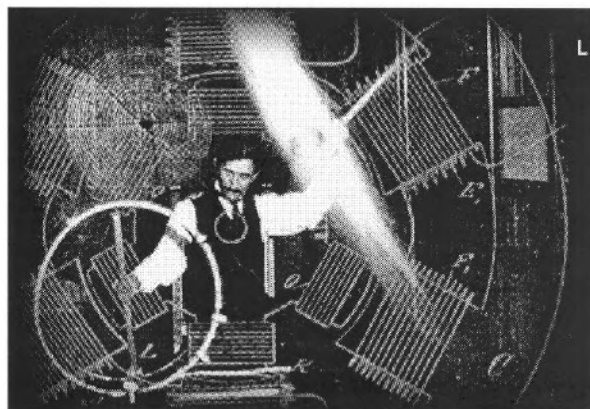

Nikola Tesla and his high voltage experiments 1909

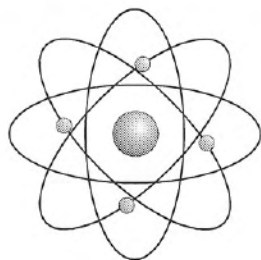
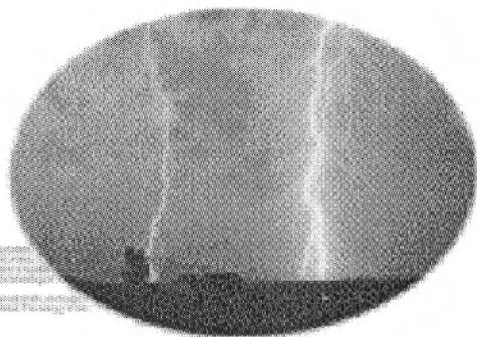
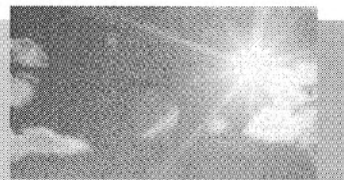
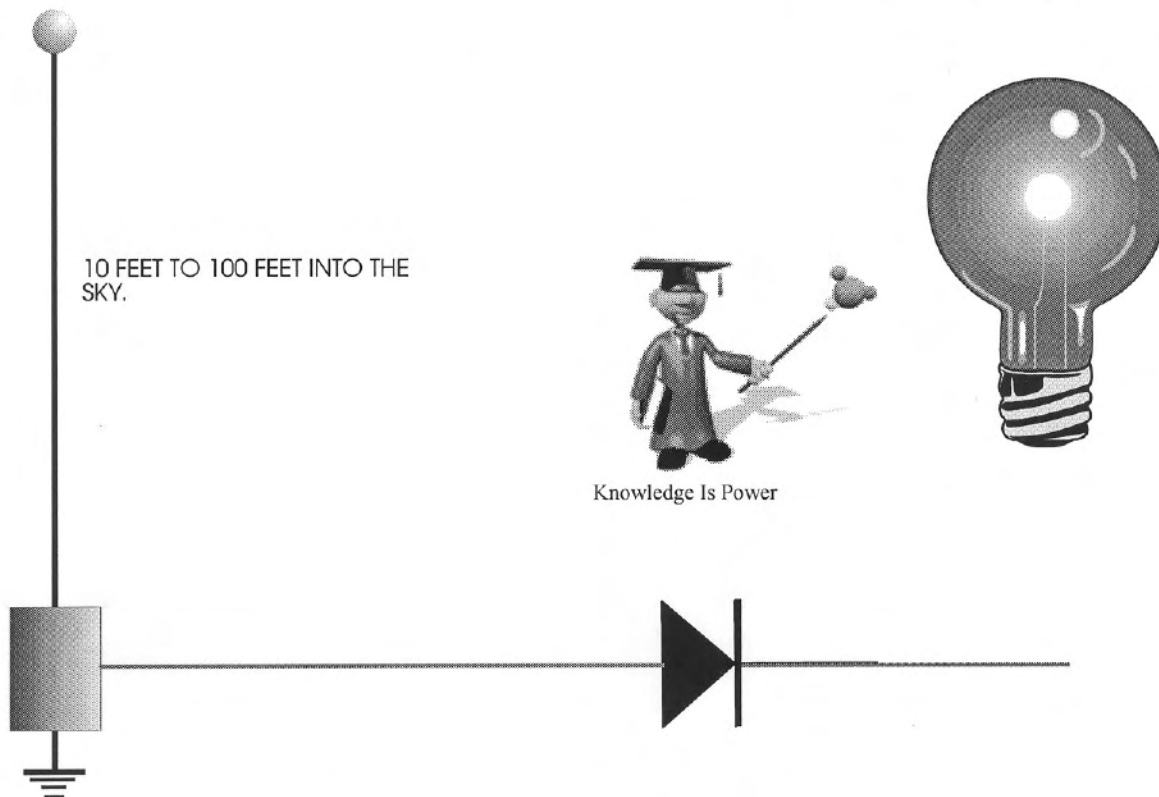

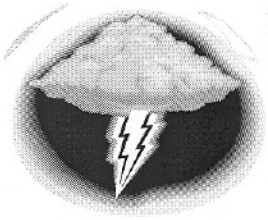
**FREE**

# *Electricity From The Sky*



Free Electricity From The Sky is a fact! You may have read in old hobby books from the 1950's how free-power radios which went on to fame in connection with electronic eavesdropping in "The Electronic Invasion" and later appeared in magazine articles and TV shows.

There are two ways to collect this free energy, one is from Radio and television waves and the 2nd is from the earth itself this is the way we prefer to get it because the earth can be pumped up to give free electricity all over the world to power homes cars airplanes etc..... In the early 1900's a man named NIKOLA TESLA invented a way to pump high energy electricity into the earth, Tesla said the earth is like a capacitor, the earth is as a spherical capacitor plate with the ionosphere as the other plate.

The frequencies that work best with this system are 12 Hz and it's harmonics and the storm frequency around 500 khz. from the earth to the outer or inner ionosphere is 60 miles. For example if you made a helium balloon and had a copper wire stretched from it to the earth you would get up to 400,000 volts, 200 ohms, .25 farads, and up to 1,800 amps of power. I heard of a man that lived up in a mountain area that powered his entire home using this method. He simply used a large metal screen and placed it at the highest point on the mountain top, he then ran a copper line from the screen to his cabin at the bottom of mountain and this provided enough electrical power to run his cabin lights etc...

**Be Careful:** If your not a professional in high voltage it will kill you. do not attempt this if you are not. You build at your own risk.

By sending up a model rocket with a copper wire attached to the bottom of the rocket and the other end grounded to a copper pipe connected to the earth you can create an actual lighting bolt. Do not do this experiment if you are not a professional. High Voltage can kill you. all it takes is one mistake.

Nov. 12, 1957

L. R. CRUMP  
POWERING ELECTRICAL DEVICES WITH ENERGY  
ABSTRACTED FROM THE ATMOSPHERE  
Filed March 12, 1954

2,813,242

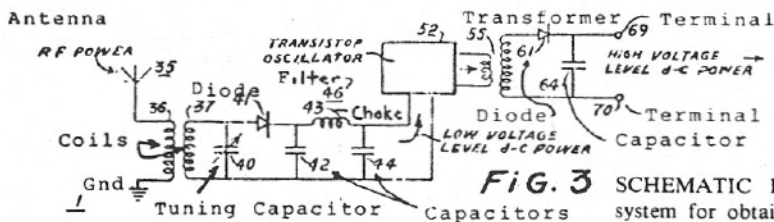

**FIG. 3** SCHEMATIC DIAGRAM showing system for obtaining high energy D. C. source at a high voltage, from the Atmosphere.

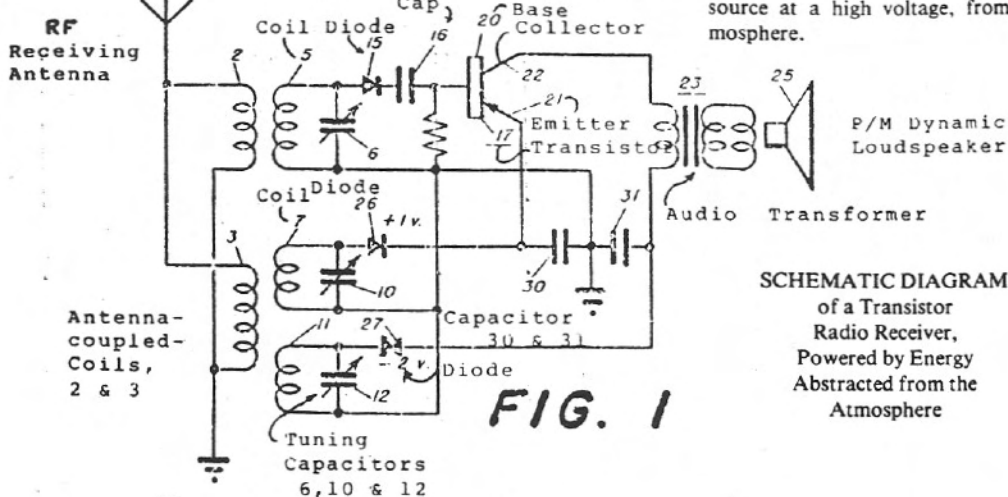

**FIG. 1** SCHEMATIC DIAGRAM of a Transistor Radio Receiver, Powered by Energy Abstracted from the Atmosphere

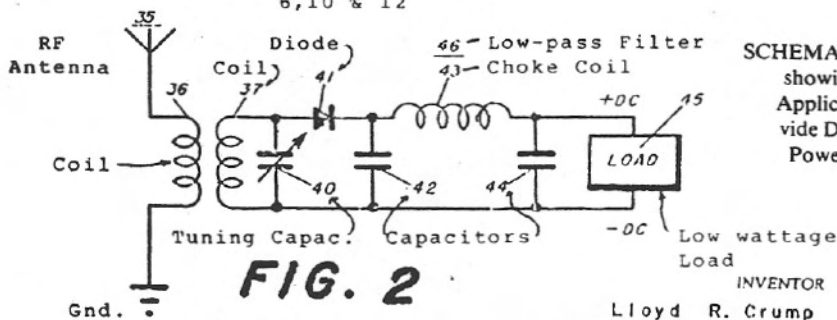

**FIG. 2** SCHEMATIC DIAGRAM showing a General Application, to provide Direct Current Power to a Load.

INVENTOR  
Lloyd R. Crump

BY *H. E. Philodreau & A. M. Dew*

ATTORNEYS

## *How to collect electricity from TV and Radio Signals*

There are many ways to collect the electricity, below is another example. Like I said anyone who's read earlier hobbyist electronic handbooks will remember the Famous Free-Power Radios which went on to fame in connection with electronic eavesdropping in the electronic invasion. Just imagine a 3 mile FM transmitter only 1"x 1" and placed in the area were you want to monitor and using this system your FM (BUG) will work forever until discovered, it's a little scary isn't it!

Any one can be listening to your conversations at any time and you would not even know it. This simple circuit shown will provide enough power to drive a small Transistorized amplifier, Receiver, or a small motor. make 10 of these and parallel them together or in series and you will have more awesome power than you can imagine.

The circuit is essentially a radio receiver (crystal detector) tuned to the loudest signal on the band. Can you get enough power to power your home? yes by using these plans combined with our #500 T-Henry moray plans for \$40 you can power your home.

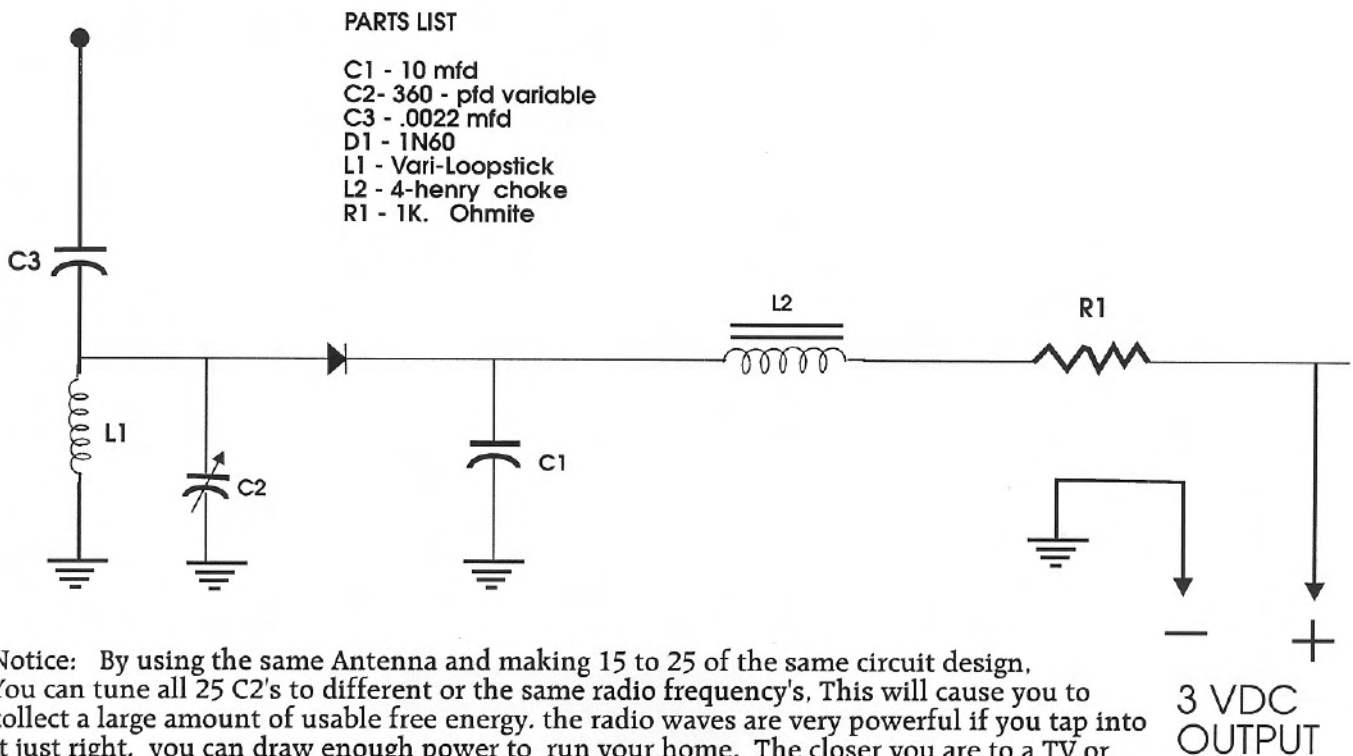

Notice: By using the same Antenna and making 15 to 25 of the same circuit design, You can tune all 25 C2's to different or the same radio frequency's. This will cause you to collect a large amount of usable free energy. the radio waves are very powerful if you tap into it just right. you can draw enough power to run your home. The closer you are to a TV or Radio antenna the more power you will get.!

If you live near a high voltage source such as 20,000 volt ac towers you can tap into that energy by not even touching the wire or the electric companies land and property. step it down with a home made transformer. ( use small gauge wire.) or you can try a store bought transformer. Remember any transformer can be used to step up or step down voltage. When you step down the voltage the amperage goes way up. This is needs to be discussed further in it's own set of plans. I know a guy who collects enough power to run his garage with.

# How to collect electricity from TV and Radio Signals

With this design we obtained over 300 volts at 1/2 watt and we were about 14 miles from radio towers. we used one antenna and also tried stacking multiples together and got far more better results, the more antennas the faster the charge and the more voltage and power you will be able to collect. Your antenna's can be located in your attic's as well as outside.

Our first prototype consisted of one CB antenna attached 20 feet on top of the lab and one 200 mile range TV antenna 30 feet up.

first we tried using the CB antenna and we got over 300 volts AC Then we attached the CB and The TV antenna together and we got 3 times the power and amps.

Capacitors we used are electrolytic rated at 400 volts x 47 uF put in series to equal 6,000 volts, the diodes we used were silicon 1000 volt 2 amp placed in series to equal 6,000 volts..... Ground was connected to laboratory wall out let ground.

If you decide to try Tesla's experiment by pumping DC into the ground be careful, I tried this and it does work but is very dangerous to you or your neighbors. If someone is taking a shower or using water they can get killed or shocked. do this experiment far away from humans and animals. you can get far more energy out than you put in. I will not tell you much more because it is such a dangerous experiment.

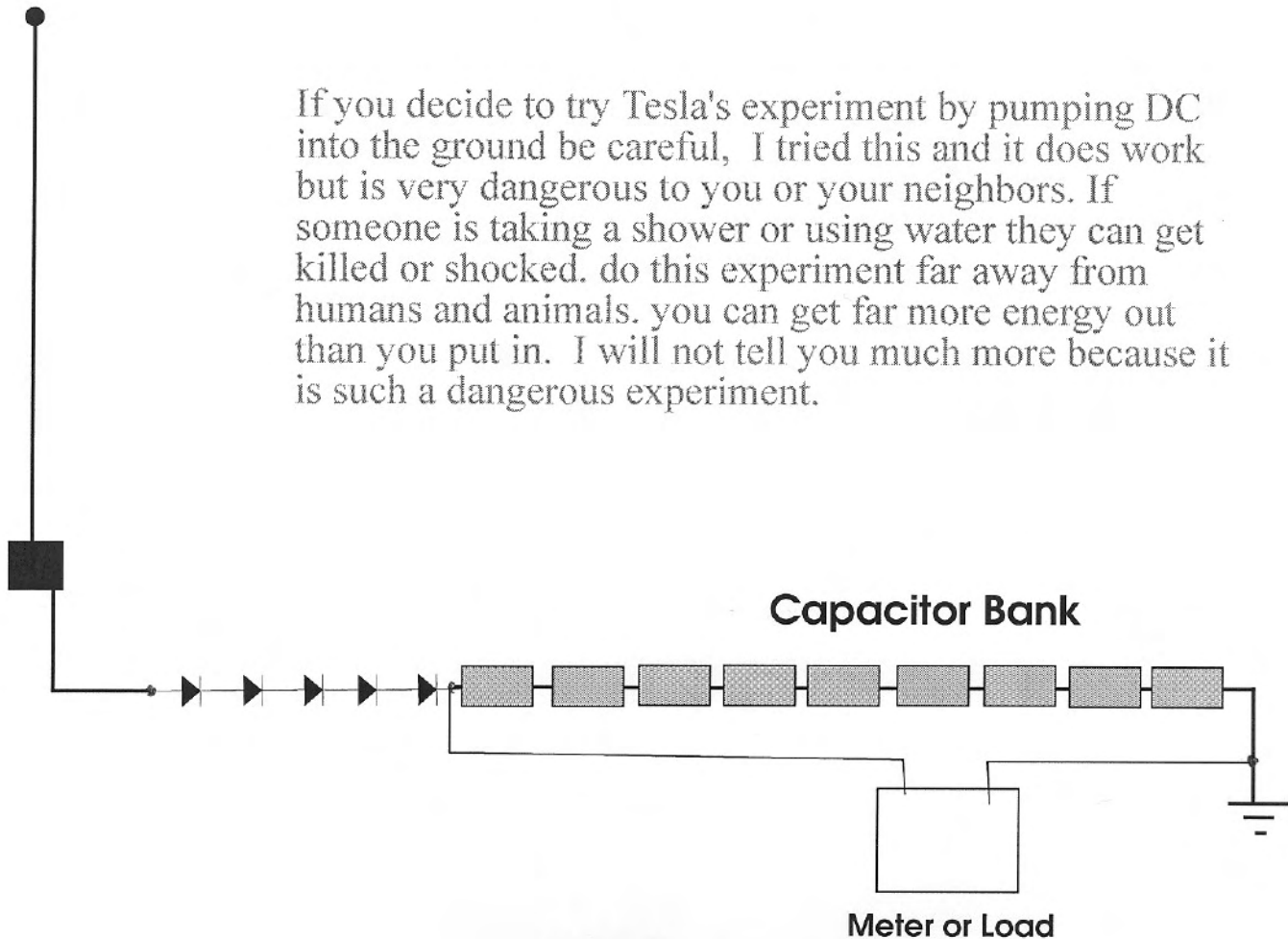

# Q.S. Fuelless Generators Inc.

Get a jump on your job with Quick Start Fuelless Generators.

Full line of Generators for Big to Little jobs. Conversion kits for Automobiles, Trucks, 4x4s, Boats, Buses, Planes, etc. If you need rotary power we have it. Pollution Free Systems Need NO Gas or Oil.

To order your kit call:  
or Fax:

**1-800-866-6618**

Fax: 607-758-4903

Phone: 607-758-3267

*"Where the past ends and the future begins" out of Business*

## CHARLES EQUIPMENT CO.

- Standby/Emergency
- Co-Gen/Prime Power
- Diesel, Natural Gas Gasoline, Propane
- 10 KW To 2200 KW
- Sales & Service
- Waukesha, DMT, Others

"FOR INFORMATION"

Charles Equipment  
Addison IL  
(US)

- Cummins Atlantic Inc Annapolis Junction MD (US)
- Cummins Onan Northern Illinois Justice IL (US)
- Cummins Onan Power Zionsville IN (US)
- Cummins Southern Plant Inc
- Cummins & Equip
- Diesel Systems Inc Benicia CA (US ex CA)
- Dunham Alternator & Equip Inc Harrisonburg VA (US ex VA)
- Dynamote Corp Seattle WA (US)
- Elan Enterprises Limited Carol Stream IL (US)
- Electrodyne Division Of Gauss Scarborough ME (US)
- Electronic Services Fairborn OH (US)
- Empire Power Systems Oakland PA (US)
- Energy Conversion Corp Greensboro NC (US)
- Fidelity Electric Inc
- Fidelity Powering Corp
- Forrest Services Greenville SC (US)
- Gen-Co Sunland CA (US)
- Generator Power Systems Memphis TN (US)
- Globalthermo Electric Kingwood TX (US)
- Guru Industries Inc Olathe KS (US)
- Hawthorne Power Systems San Diego CA (US)
- Hesco Mobile Power Equipment Centuria IL (US)
- IEC Baylor Sugar Land TX (US)
- Locke Well & Pump Orlando FL (AL, GA, LA, MS, NC, SC, TN)
- Master Service Center Grand Rapids MI (US)
- Maxi Power Lebanon PA (US)
- Mercantile Mtg Minden LA (US)
- Michigan Engine Power Novi MI (US)
- Moeller Sales Inc Bloomington IN (US)
- Moto Sports Of Ukiah Ukiah CA (US)
- Mountain Generator & Controls Johnson City TN (US)
- N E C Power Systems Inc Round Rock TX (US)
- Newman Sons Ft Pierce FL (US)
- Northeast Generator Sales & Serv Bridgeport CT (CT)
- O'Brien Rental Services El Cajon CA (US)
- O'Brien Rental Services Benicia CA (US)
- O'Brien Rental Services Benicia CA (US)
- Palco Latrobe PA (PA)
- Paynter's Generator Service Falmouth KY (US)
- Powerhouse Honda Rapid City SD (MT, ND, SD, WY)
- Pure Power Equip Inc Kent WA (US)

Proof →  
That men HAVE  
Tried to sell  
& manufacture  
free ENERGY  
Generators!  
They quickly  
SHUT DOWN!  
YOU CAN NOT  
manufacture  
free ENERGY  
Devices.

## HONDA'S PORTABLE POWER PLANT.

Honda offers a Complete Range of Heavy Duty Generators.

**HONDA**  
**Power**  
**Equipment**

Nothing's easier.

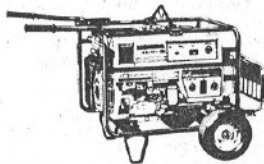

- Models From 350 to 12,000 Watts
- Honda 4-Stroke OHV Engines
- Heavy Duty Construction
- Smooth, Quiet Operation
- Oil Alert™ (Most Models)—Engine Stops If Oil Reaches Minimum Level

## SIGMA HONDA SALES

**1-800-43 SIGMA**  
**1-800-437-4462**

8433 So. 212th Street  
Kent, WA 98031 (206) 872-2141

### General Merchandise - Wholesale

- Ancon Distributing Huron SD (NE, SD) 800 854-1865
- Countryside Associates Commerce TX (US) 800 322-7149
- Crane Wholesale Crane MO (US) 800 942-7807
- Easy Supplies And Liquidators Hyattsville MD (US) 800 782-3279
- F M A International Wichita KS (US) 800 682-8777
- HR Pickering Enterprises Wheeling WV (US) 800 992-7516
- Intl Marketing Group Naples FL (US) 800 262-7171
- Midwest Drug Ft Madison IA (US) 800 222-1118
- Newton Wall Co Shawnee OK (US) 800 521-1582

### Generators

- A F Shane Pittsburgh PA (PA) 800 472-2792
- Aptech Sandpoint ID (US) 800 323-1185
- Babsco Elkhart IN (US) 800 874-1011
- Buckeye Power Sales Indianapolis IN (US) 800 632-0339
- Buckeye Power Sales Columbus OH (US) 800 523-3587

Can your customers and prospects find your firm's number in the AT&T Toll-Free 800 Directory? Call 1 800 562-2255.

# Making Water Droplets

~~Lord Kelvin's~~ little-known invention builds up 2,000-volt sparks from two falling streams of water

~~DAVID HENDERSON~~

Nothing moves in this unusual generator except two streams of water. Yet it builds up thousands of volts of static electricity.

A primitive device invented almost a century ago and never developed, it operates on the same principles as the famous Van deGraaff generator. The two principles are that:

- Like electrical charges repel one another.
- Two identical metal objects have slightly different electrical potentials.

**How it works.** In my water-drop generator—which you can duplicate for less than \$5—two coffee cans are the “identical metal objects.” Two streams of water supply the electrical charges. Each can is cross-connected to the stream falling into the other can. Where the two conductors almost touch, they form a gap. When the difference of potential between the two cans becomes great enough, a spark flashes across the gap, discharging the system.

What causes the difference of potential to build up is the initial difference in the charges on the two cans. One has a somewhat more negative potential than the other. This causes the collector ring attached to the more-negative can to repel negative charges in the water stream dropping through it. The negative charges travel back up the stream and into the reservoir again, where they eventually find their way down the other stream and into the less-negatively charged can. Gradually, through this selection process, more-negative charges are concentrated in one can and less-negative charges in the other.

There is no theoretical limit to the

amount of voltage that can accumulate on the containers and rings. The main practical limitation is the stray leakage of charges between the containers—a problem made even worse by the inevitable presence of splashed water.

**Experiments with the generator.** So little has been done to develop Lord Kelvin's obscure invention that there's still plenty to learn from it about electrical charges and moving liquids. Here are some theoretical questions you may be able to answer by experimenting with your water-drop generator:

- What determines the rate at which a difference of potential builds up? Is it the diameter of the copper rings, the distance the water falls, the rate of water flow, the size of the collector cans, or the humidity of surrounding air?
- Is there some way to measure the voltage in the system at any point in the build-up process, without discharging the system? You can estimate voltage at the moment of discharge by applying the rule of thumb that a spark jumps about one inch for every 10,000 volts.
- Is there some way to prove the theory, given earlier, of how a water-drop generator works?
- What can be done to make this generator more efficient and easier to control? And if it can be improved, how might one be used?

**Making it work.** When you've got your generator assembled, fill the reservoir with tap water. Open the clamps on the tubing and start a siphoning action, then adjust water flow to make the stream break into droplets just inside the copper rings. If the system is working properly, the streams will bend towards the sides of the rings as the charges build. Start with a 1/4-inch spark gap. If it's too wide, the water will splash all over the apparatus before there's a spark. If it's too small, sparks will be frequent and feeble. Sparks show up best if you make your experiments in a darkened room.

After experimenting, better short across the gap with an insulated screwdriver to prevent an accidental shock.

FREE NEWS

TURN WATER INTO 2000 VDC OF Electricity

# Generate Electricity

#371

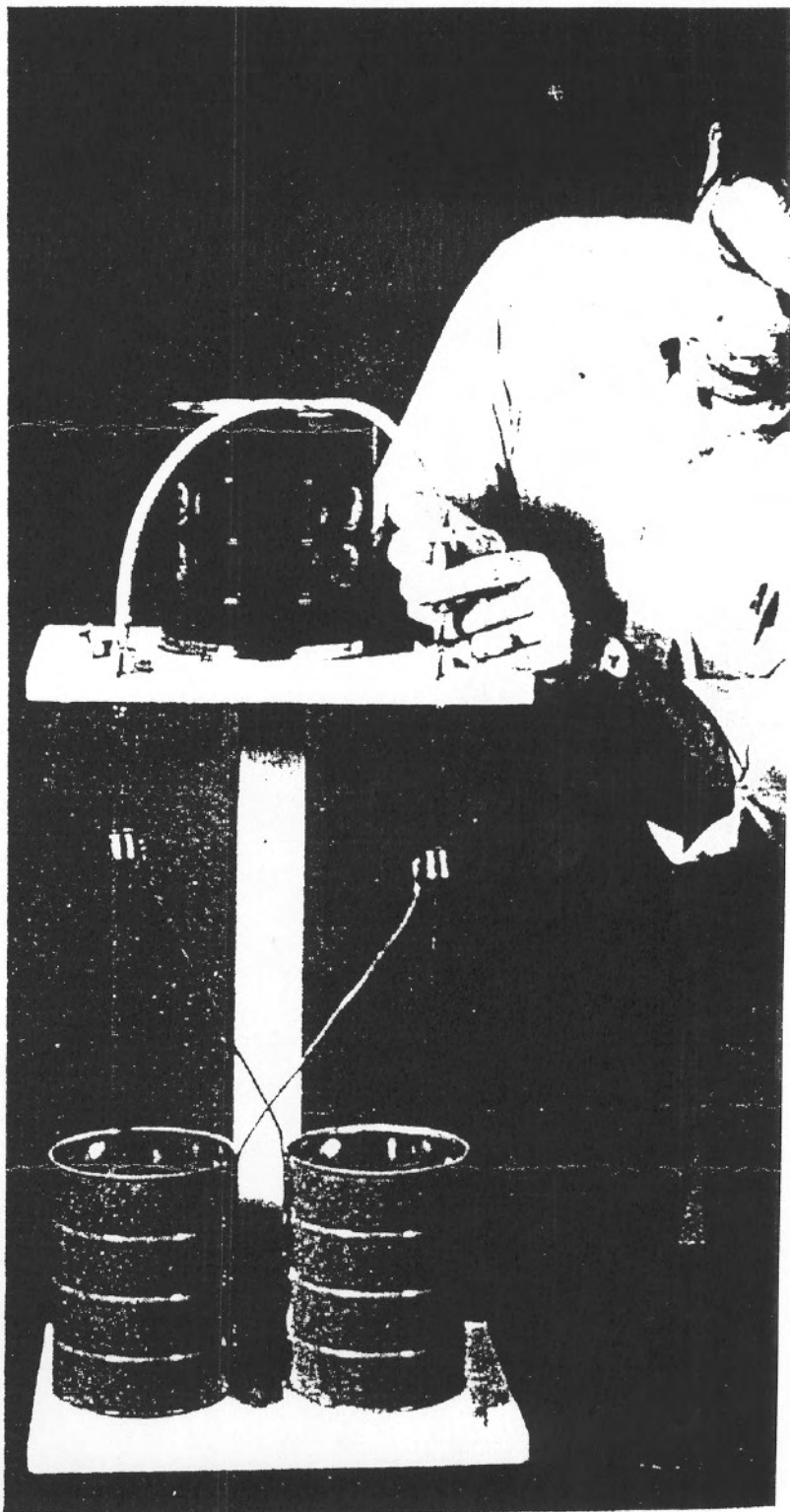
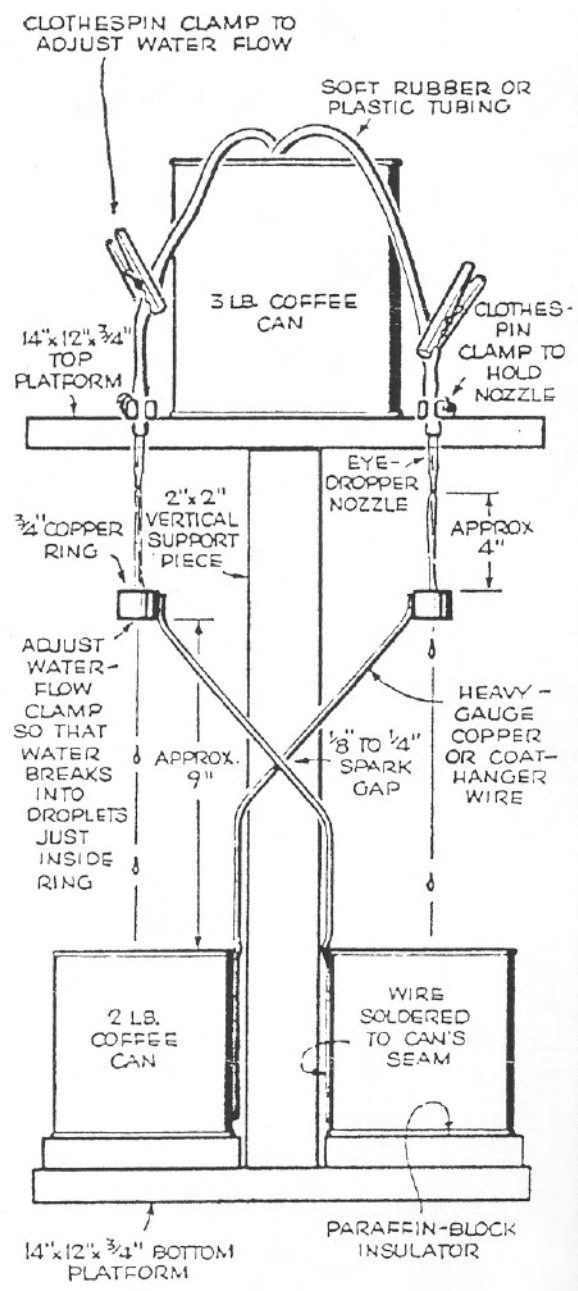

Building a water-drop generator is simple, as the drawing and photo show. What they don't indicate is that platforms and support are painted to water-proof the wood and make it less conductive. You should also remove the oily coating from inside the collector cans with grease solvent or by boiling in

a detergent solution. Steel-wool the vertical seams on the collector cans, the conducting wires, and the copper collecting rings. Then rosin-core-solder the wires to the can seams for a distance of 6", the rings to the wires a distance of 1/2". Wires can also be connected to cans by wrapping wire around them.



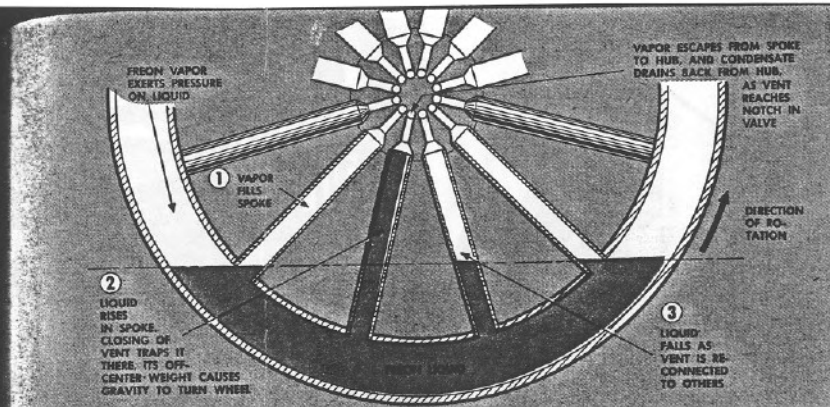
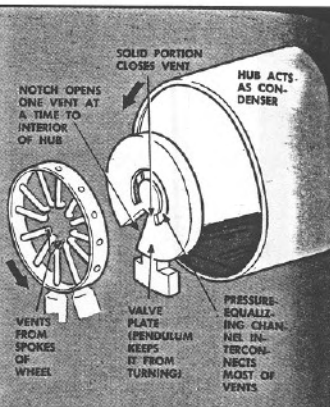
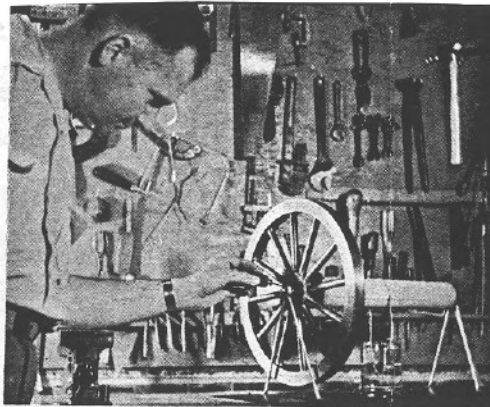

## Inventor's Mysterious Motor Runs on Power Drawn from Atmosphere

WHEN Cmdr. Ivan Monk, who designs big turbines for the Navy, is pestered by inventors of perpetual-motion machines, he points to a device on his desk that goes them one better—for it works. It is a wheel that spins with no apparent source of power. Commander Monk built it in his spare time, and patented it, since it may find use in clocks, toys and advertising displays.

Actually it is a rotary heat engine, run by temperature difference between its parts. The wheel is at room heat; the long cloth-covered hub, kept dampened with water, is cooled by evaporation. A low-boiling-point liquid, Freon, circulates between wheel and hub, vaporizing in the wheel and condensing in the hub. Valves maintain an unequal weight of liquid on opposite sides of the wheel—and gravity does the rest, to turn it.

SECRET of mystery motor (at far left with inventor) is revealed above. Spoke nearing bottom fills with Freon liquid, which valve mechanism (left above) briefly traps in it. Resulting excess weight of this spoke turns the wheel.

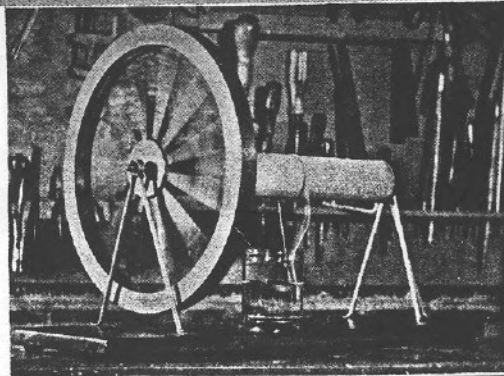

MOTOR SPINS with no visible power source. Actual source, heat from atmosphere, evaporates water to cool elongated hub acting as condenser. Endless loop of string, dipping in beaker of water, keeps cloth-covered hub moistened.

freon

## Prospecting Trucks Aid Hunt for Uranium Buried in the Earth



Four trucks like the one at left are speeding uranium prospecting in the western U. S. Backed up to a drill hole, a truck lowers down it a 2½-foot-long steel cylinder with winch, boom and cable. Wires connect a scintillation counter in the cylinder, which detects rays from uranium ores, to an automatic recorder that charts their levels. Built for the Atomic Energy Commission by Bogue Electric Mfg. Co., Paterson, N.J., the trucks save the time of taking and testing core samples.

## Tool for Blind Drives Brads

INSERT a brad at the tip of this tool (below), and a magnetized plunger holds it. Pressing the handle drives it by extending the plunger against a spring. Wellman Products, Cleveland, makes the tool for the American Foundation for the Blind.

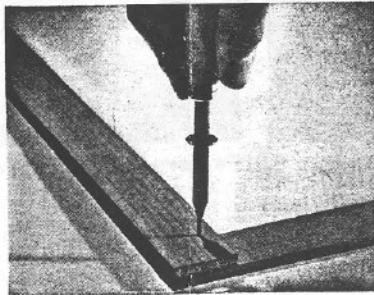

## Tune Tells When Wash Is Dry

LAUNDRY automats now play a tune to announce that the wash is dry. Commissioned to fit an electric clothes drier with a music box, a Westinghouse engineer devised one whose five tone bars render the air of "How Dry I Am."



673  
119.50  
2,282  
\$35 per  
HR.

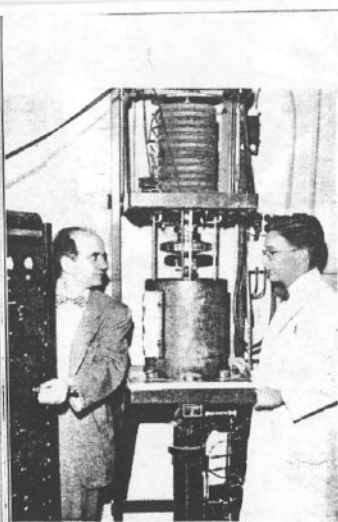

**Scientific Top  
Can Spin for  
Seven Months**

THERE'S no visible means of support for this scientific top, the world's largest ultracentrifuge. An electromagnet suspends it in mid-air (really in a vacuum), and a varying magnetic field spins it at 30,000 r.p.m.,

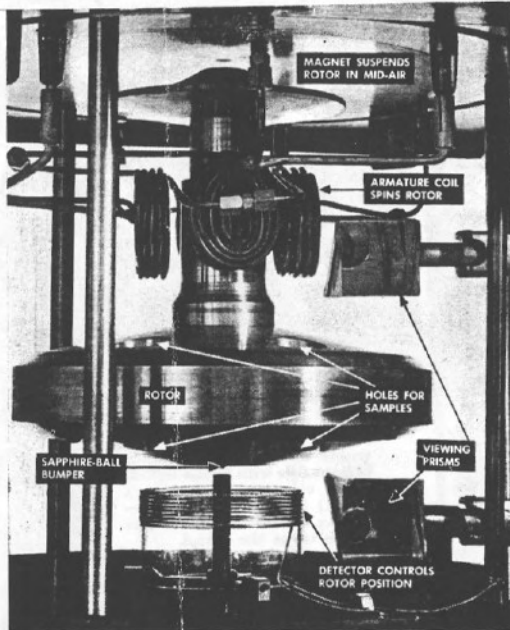

creating a centrifugal force 100,000 times gravity pull. Made at the University of Southern California for research on molecules, it would take 208 days to stop spinning if not braked.



**That Spare's for Kangaroos**

A KANGAROO catcher was added to this stock car for the 6,500-mile trip in an Australian road reliability test run. The car above has a spare tire taped at the front to gently bounce the animals from the road. Wire mesh guards protect the headlights.

150 POPULAR SCIENCE

HAPS  
Airport.

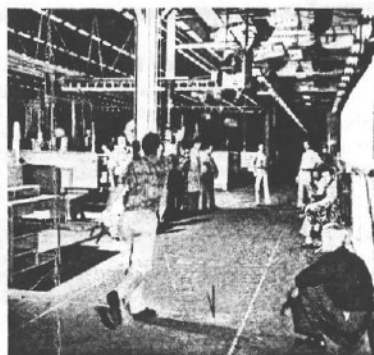

**Factory Becomes Playground**

AT THE noon lunch break, plane builders at North American break out the recreation equipment for a daily workout. Cleared blueprint desks become table tennis courts and assembly-line aisles turn into shuffleboard and horseshoe-pitching areas.

DADS - phone

Small set turbo prop.



**You Can't  
Blow Your Horn in Memphis**



*Not only cars are muffled, but even dogs and bullfrogs, in America's quietest city.*

**By Robert Lasch**

THE bullfrog is a respected creature of the South, but when one unleashed its mellow baritone within the city limits of Memphis, it tangled with the law. Bullfrogs are not allowed to croak in Memphis, dogs are forbidden to bark, and auto horns to beep, except in case of emergency. The law, which first laid down these bans 15 years ago, is the Tennessee metropolis' famed noise-abatement ordinance. Memphis has proved conclusively that at least some of the nerve-racking, ulcer-incubating sounds that result when thousands of people live and work together are unnecessary. For 11 straight years the mid-South capital on the banks

of the Mississippi has won the top award for municipal silence granted by the Noise Abatement Council as "the nation's quietest city." How quiet is Memphis? Your correspondent went there to find out—and it is really quiet. The yawp of an auto horn is so rare that you notice it. On a busy Monday, with Main Street crowded and the cotton merchants thronging Front Street, I heard an auto horn just three times in 12 hours; twice the offender was an out-of-state car or truck. Heavy traffic moved smoothly along



Jan 1954

Nov. 12, 1957

L. R. CRUMP  
 POWERING ELECTRICAL DEVICES WITH ENERGY  
 ABSTRACTED FROM THE ATMOSPHERE  
 Filed March 12, 1954

2,813,242

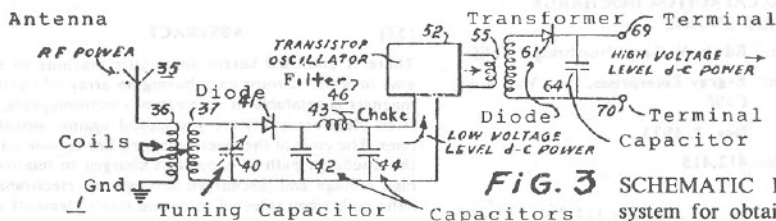

**FIG. 3** SCHEMATIC DIAGRAM showing a system for obtaining high energy D. C. source at a high voltage, from the Atmosphere.

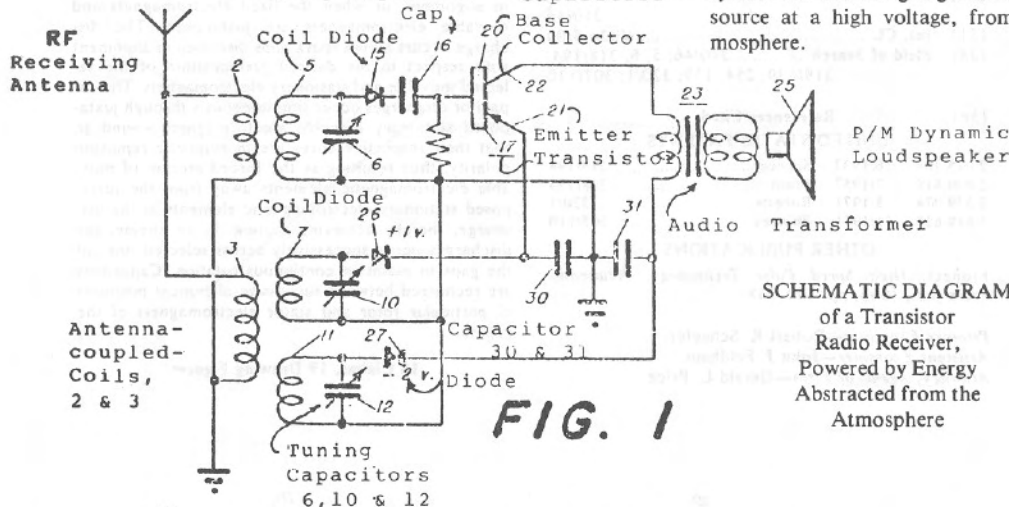

**FIG. 1** SCHEMATIC DIAGRAM of a Transistor Radio Receiver, Powered by Energy Abstracted from the Atmosphere

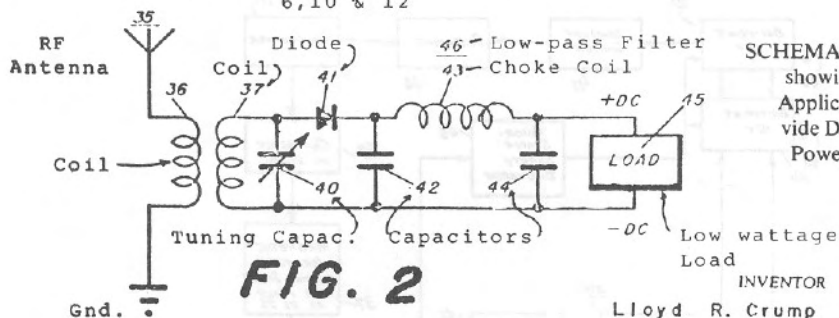
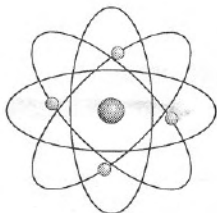

**FIG. 2** SCHEMATIC DIAGRAM showing a General Application, to provide Direct Current Power to a Load.

INVENTOR  
 Lloyd R. Crump

BY *W. E. Philodew & A. L. Dew*

ATTORNEYS



# CREATIVE SCIENCE & RESEARCH

P.O. BOX 557 NEW ALBANY, IN. 47151

Information Big Brother & the Oil Companies do not want you to know!

## KNOWLEDGE IS POWER!

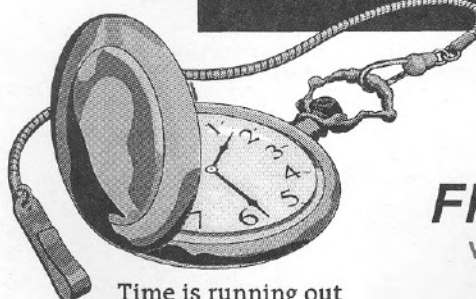
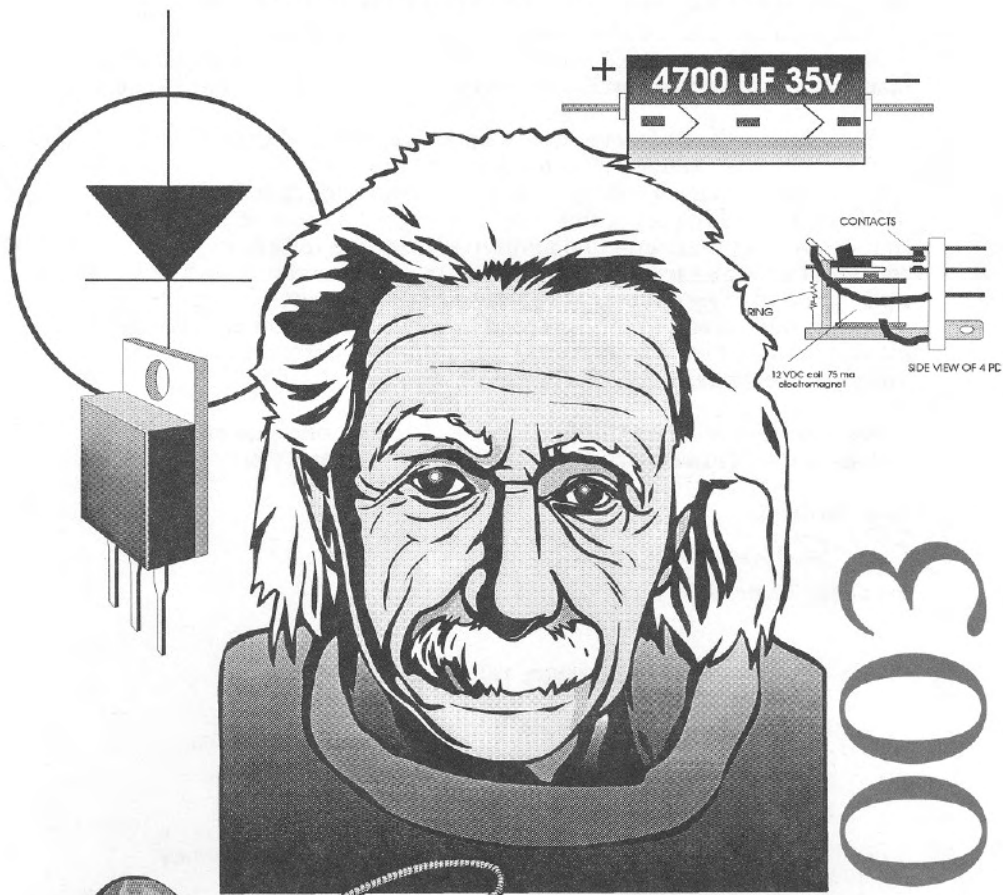

Time is running out

### FREE ENERGY

[www.fuellesspower.com](http://www.fuellesspower.com)