

Make Your Own

HVC1

Copyright 1996 - 2003

High Voltage CAPACITORS



DANGER
HIGH VOLTAGE



Creative Science & Research PO BOX 557 New Albany, IN. 47151 USA

www.fuelless.com

www.fuellesspower.com

tesla@fuellesspower.com

HIGH VOLTAGE CAPACITORS



10,000 to 25,000 volt capacitor



10,000 to 25,000 volt capacitor

In our above HV Capacitor design, we used a clear plastic make up container that we purchased from a local K-Mart Store in the women's dept. We then purchased 5" x 50 foot aluminum sheeting from a hardware store, you will need 2 rolls. We then cut the aluminum in small pieces of 5" x 6" sheets. Once you are done with cutting both rolls up. Then you will need to make your bolt holes on the ends of your positive and your negative plates. You will need a good 3-M spray adhesive, which must spray a fine spray, you can purchase this at any Hardware or Art Store. Now you will need to cut 6" x 6" plastic Mylar pieces for your die electric. You will need to bond them to the aluminum plates. Use a 3 mil or a 4 mill plastic, this should hold up under 10,000 vdc.

Cut a small piece of 1/2" plywood to 5" x 6" then drill your bolt holes using the + and negative plate as a template, Now you will need a small drill press, set up a wood jig with register marks so you can drill holes in all the other aluminum plates in the exact same spot. Holes should be a little bigger than the bolt. Even out 2 stacks of 5" x 6" aluminum plates, start off drilling the one stake first and mark each one as +. This will help you later and you will thank me for it. Then do the Neg plates the same way. Make sure you drill holes in the exact same place, so all bolt holes will line up correctly when you push the holding bolts through. When you are finished drilling holes, place 4 guide bolts through the bottom of your plywood base. Using these bolts as guides. Now spray the top of the plywood with adhesive. Now place your first 5" x 6" + plate on it, press down firmly. Now spray your mylar plastic on a sheet of cardboard away from your project, spraying only one side, you want to keep the spray away from your project or it will build up on your bolts. Now place the mylar to the right side of the holes, press firmly, now spray one side of your Neg. Plate and insert over the right side bolts. The left bolts are for your + plates and the Right side is for your Negative plates. Now repeat this over and over again. Be careful and not to forget to place Mylar plastic in-between each + and Negative plate. Or they will short out. It will take you about 16 hrs of work to finish, once you are done place 2 bolts on the top of your plastic lid. Connect the left one to the left bolts using 8 gauge wire or wire rated for the amount of voltage and amperage you are going to use capacitor for, do the same for the right.

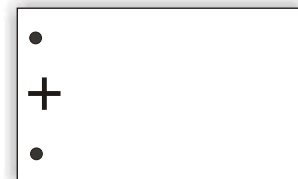

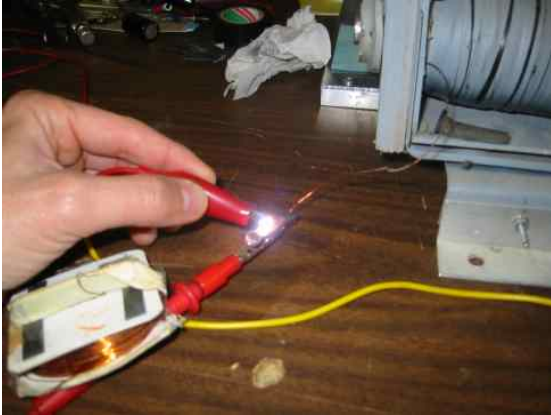

MAKE YOUR OWN HIGH - VOLTAGE CAPACITORS

As one who supplies parts to those who experiment with high voltage, I get a lot of letters from frustrated builders Who can not find a High Voltage Capacitor at a low price. an inexpensive XXX microfarad capacitor at a working voltage of YYY? My only source wants \$249 for one." Sometimes, a high price is justified; other times, a seller has the only capacitors of a special value available, and will soak you for the maximum dollar.

It is feasible to build your own ca-

pacitors of any voltage and energy storage size for either AC or DC use. The process involves a step-by-step logical approach that we'll present here. We'll explain how to plan and construct a capacitor, where to get materials, safety considerations, tips and hints, and include a few simple projects,

A Capacitor's Description. A capacitor consists of two or more plates of a conductive material separated by an insulating substance called a

dielectric. A dielectric may be solid, gel, liquid, or gas. A capacitor's ability to store energy is measured in either microfarads (uf), nanofarads (nF) or picofarads (pF). Micro means one millionth, nano stands for one billionth and pico for one trillionth (farads are also used, but in high voltage work they are impractically large units). Several factors affect capacitance. The formula for determining capacitance is;

$$C=(0.224KA/d)(n-1)$$

where C is the capacitance in picofarads. K is a constant that depends on the insulator (or dielectric) between the plates (called the dielectric constant), A is the area of one conductive plate in square inches, d is the separation between adjacent plates in inches, and n is the number of plates. As you may know, different insulators have different dielectric constants. Table 1 shows the values of K for some common materials and the peak voltage they can withstand per 1/1000th inch (called a mil) of thickness. This rating is called the puncture or breakdown voltage.

Dielectrics. The better the insulating property of the dielectric, the higher its resistance, and the less dielectric leakage loss present. In low current, high voltage power supplies, minimizing all sources of loss is important to prevent undue power-supply loading. For that reason, plastics are by far the best materials for large capacitors. A serious project should involve one of the plastics.

Lexan, Polystyrene, and Plexiglas in particular are easy to glue, and can be cut with a table saw using a plastics blade, or a carborundum impregnated all-purpose cutting blade like Zippity-Do (which is cheaper). A sabre saw with a really coarse wood blade will also work (other blade types clog or chip). Such plastics may be drilled

WARNING! This free article of news deals with subject matter that can be hazardous to your health and life! Do not try to build these devices unless you are skilled in the art of high voltage. You build at your own risk, we are not responsible for anything in these plans. Use rubber gloves and rubber shoes when working with high voltage. Discharge all capacitors before touching

with high quality steel drill bits or special plastic bits. They must be drilled at 300 RPM or slower to prevent chipping and melting, and be sure to leave the protective film or paper on the plastic when working with it.

Mylar, Polyethylene, Nylon, and especially Teflon are difficult to work with as they are very slippery. The best way to attach plates to any of those materials is to use a glue specifically designed for the material. Polyvinyl chloride (or just PVC) is moderately slippery. It can be glued with a PVC cement, or foil plates can be attached using silicone RTV

Glass is, in principle, an even better

dielectric. It also has the advantage of being easy to glue to with Silicone RTV or Crazy Glue, and it is readily available and cheap. However, it is fragile, and may contain impurities that allow conductive paths for destructive arcs. Contradictorily, for your first capacitor or two, we suggest that you try a type made with glass to gain experience, since they go together easily and are cheap.

Many industrial capacitors are oil filled. Oil has an extremely high resistance, so it does not measurably increase leakage. Silicone transformer oil is the best liquid insulator, but is rather hard to obtain. Mineral oil, on the other hand, is readily available from most pharmacies. Although it has a low dielectric constant, it can be used in a variety of simple ways to make very good high voltage capacitors.

For example, a dandy variable DC capacitor can be made by immersing a junked AM-radio tuning capacitor of the movable-plate type in mineral oil so its shaft and connection leads come out of the container's top. If you wish to try this idea, make absolutely certain the "cold" plates of the capacitor (the moving plates) are at ground potential. Use a good, large, non-metal knob for adjustment. A 100- to 365-pF variable capacitor with a 1-kVDC breakdown voltage (i.e., a plate spacing of 1 mm) becomes a 270- to 985-pF unit with 7500-VDC breakdown rating. Try pricing a 7500-volt variable capacitor sometime, and you'll see the advantage to this approach!

You can use mineral oil in designs of your own, too. Immersion of a home-made capacitor in mineral oil will greatly improve its voltage rating and lifetime.

Paper is an excellent dielectric when saturated with mineral oil. Try 20-lb. bond computer paper which has a 4 mil thickness. Prepare this inexpensive capacitor by interleaving layers of dry paper with aluminum foil, and then immerse the capacitor in oil until the paper gets saturated.

One disadvantage to using oil in home-made capacitors is that the tape or glue used to bond the assembly must be oil-resistant. Silicone RTV is the best glue for these purposes.

Design Considerations. There are

Insulator	Dielectric Constant	Puncture Voltage per 0.001 Inch	Notes
Air	1.0	30	
Window glass	7.8	200	
Polyethylene	2.3	450	
Paper(bond)	3.0	200	
Polycarbonate (Lexan)	2.96	400	
Teflon	2.1	1000	
Polystyrene	2.6	500	
Epoxy circuit board	5.2	700	2, 3
Pyrex	4.8	335	
Plexiglas	2.8	450	
PVC (rigid type)	2.95	725	
Silicone RTV	3.6	550	
Polyethylene terphthalate (Mylar)	3.0	7500	
Nylon	3.2	407	4
Mineral Oil. Squibb	2.7	200	2, 5
Shellac	3.3	200	
NOTES: All measurements at 1 MHz unless otherwise noted. 1 Tested with dry air,			
2 Tested at 300 HZ using a Heathkit IM-2320 Multimeter and homemade capacitor.			
3 Estimate, based no experiences.			
4 lowest value of 3 types.			
5 estimate. Probably higher. A 0.040" gap withstood over 10,000 volts DC before break Down in one test.			

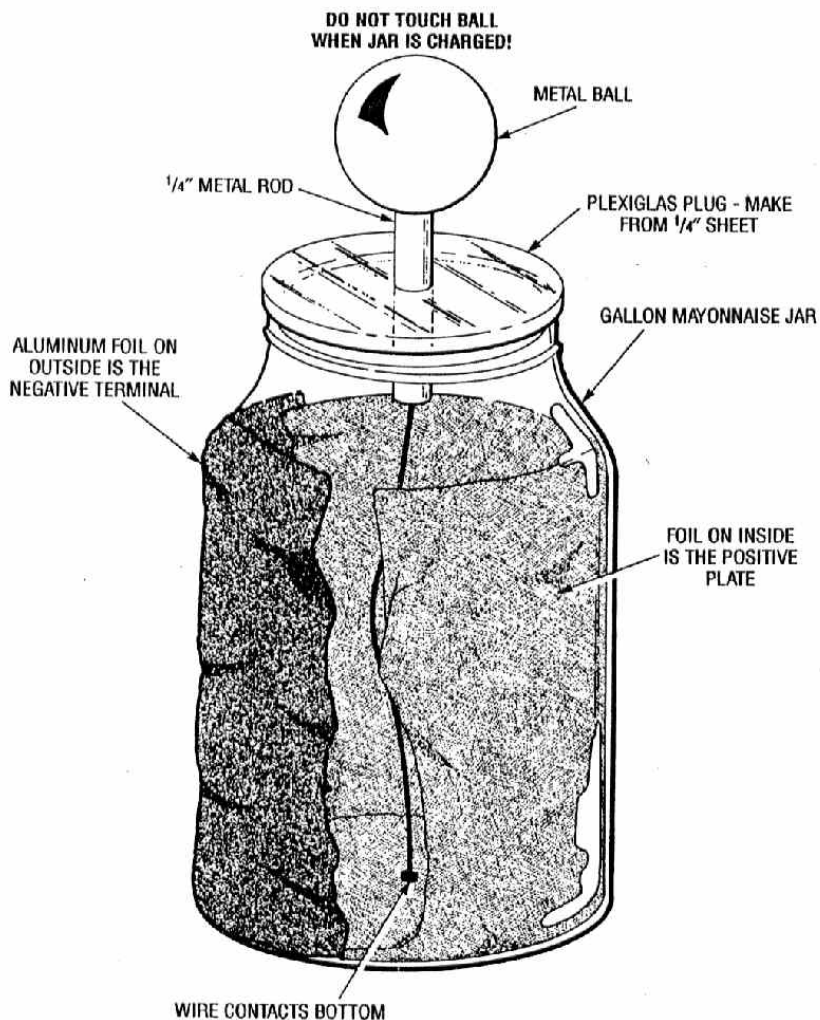

several things to consider when designing and constructing your own capacitor. Let's point out each one before moving to the construction details. The first and most important thing to concern yourself with is safety. Despite the romance of high voltage, it is foolish to needlessly risk your life. Since you will probably be working with lethal voltages, observance of all safety practices for high voltage (or HV) is absolutely essential. For some guidelines, see the boxed text entitled "High Voltage Safety"

The next aspect to consider is capacity. If you have a specific capacitance in mind, you can design a capacitor using the information provided elsewhere in this article. Try one of the designs described later. Or perhaps you prefer experimenting instead. Either way, when building for the first time, we suggest making small

designs first to get used to techniques and quirks before you invest lots of time and money

You must also take into consideration the voltage that will be applied to the capacitor. That will affect your choice of a dielectric and thus its required thickness. Should you use an inadequate dielectric or thickness, sparks or arcs can result. A spark is a temporary breakdown that a lot of capacitors will survive, but an arc is serious: it is a path burned into the dielectric or other component. Arcs carbonize materials, producing a highly conductive channel that often renders an apparatus useless and very likely dangerous. Except in special cases where the insulator is a "self-healing" type (like air, oil, and some plastics), a single arc will ruin the capacitor.

To compensate for the impurities

High Voltage Safety

High voltage is considered any value over 500 v AC or DC. When you attach a capacitor to high voltage, you are multiplying its hazard many fold! Therefore, experimenters must take extra precautions to avoid painful shocks and possible electrocution. Here are a few guidelines to follow when working with high voltage:

Label your project in several locations with: "Danger High Voltage" where appropriate. Such a warning label is provided here for you to copy. (See Fig w). Keep Children, pets and others away from your capacitor etc... Cover all bare leads, wires, wires, connection terminals, and possible points of contact with high voltage putty or a cover painted on with rubber paint or clear plastic.

Work in a dry location. Working in a damp basement may cause problems. Wear rubber soled boots or sneakers. Stand on a thick rubber mat.



Fig. W. Copy this WARNING label and tape it or past it on or around your projects.

Never put your body in a position to become a conductor, Locate your HV project away from appliances, metal doors window frames, heating ducts, vents, radiators, metal sinks or water pipes. All these items can become a deadly ground if your body comes between them and high voltage.

Always pull the plug when working on a high voltage circuit unless you when you must test it. Use caution. Keep one hand in your pocket. Use a high voltage prob whenever possible. Use NE-2 neon lamps to indicate live or stored high voltage. Bled off the charge on capacitors with a power resistor before performing adjustments etc...Use good ventilation, projects using Tesla coils and Jacob's ladders give off Ozone.

that often appear in materials that are not highly refined for capacitor use, we must add a safety margin to the thickness of the dielectric. In the

case of DC, a good rule of thumb is a 50 margin, For example, say you need a 500-volt DC capacitor using polystyrene, Consulting Table 1, note polystyrene's breakdown is 500 volts per mil, thus 1 mil is required. Adding 50 gives you 1.5 mils, which is adequate for pure DC, You can always use a thicker dielectric if it's expedient, providing that you adjust the number of plates or their size to accommodate the wider plate separation. It should be mentioned that when making a paper capacitor, you should use a healthy safety margin since paper is not always uniform in thickness.

In comparison to AC, DC puts relatively little stress on a capacitor. By contrast, AC reverses the dielectrics' polarity every cycle. So the dielectric in an AC capacitor must have twice the thickness required in an equivalent DC capacitor. Further, when considering dielectrics in AC applications, you must deal with the peak voltage—not rms (Root Mean Square) voltage—that they will be exposed to, If you wish to convert an rms voltage to its equivalent peak sinewave value, multiply it by 1,414,

So, to roughly calculate the proper voltage rating needed for an AC capacitor, you first double its required rms voltage rating then multiply by 1.414. To further simplify this calculation, all one needs to do is multiply the AC (rms) voltage in question by 2,828. Now divide the voltage by the puncture-voltage rating to get a preliminary thickness value. Finally, you must add a safety margin of 50 to 100. The actual percentage depends on the characteristics of the applied AC voltage. For a pure sinewave AC, we suggest a 50 safety margin whereas high frequency, non-sinusoidal applications such as Tesla coils require a full 100 extra thickness.

If one is available, equip an oscilloscope with a high voltage probe to visually observe exactly what the circuit is doing so you can determine the proper safety margin. An oscilloscope will also enable you to detect destructive voltage spikes and superimposed AC (also called AC ripple) so you can design a capacitor to handle those harmful excursions.

Of course physical size, weight, and fragility are also important characteristics of capacitor design. If you have size limitations, Mylar is the best

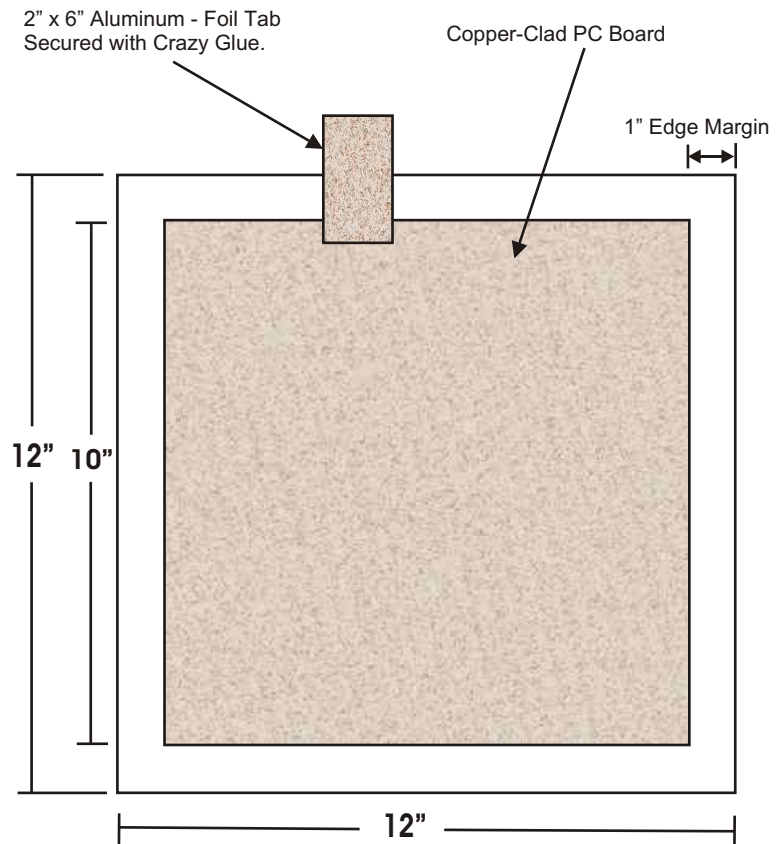

Fig. 2. For a single-section capacitor, use one double-sided PC board. For multiple sections, use several single-sided boards damped together or bolted together with nylon screws

dielectric material to use since it has a very high puncture voltage per mil, and thus makes a very compact capacitor. Plastics are light, so most capacitors will weigh less than ten pounds, The toughest plastic is Lexan, which is difficult to crack even with a hammer and is often used for vandal-proof windows, Glass is the worst material for a lightweight, durable capacitor, and can even crack under its own weight when lifted. Take all this into account when selecting your materials,

Of course, the overall cost in labor and materials should also be considered before constructing a capacitor. Calculate beforehand the cost of your materials. Paper and polyethylene are the cheapest. Glass is the next higher price. Labor time is about the same with Plexiglas, Lexan, and glass sheet capacitors, Exotic plastics such as Teflon are not needed unless your application demands extreme chemical and thermal deterioration resistance. Polyethelene has excellent chemical resistance, but

breaks down gradually upon exposure to ozone gas (always present around high voltage) becoming brittle and less resistant to arc puncture.

That brings us to another important consideration: the capacitor's useful life. To enhance a capacitor's life keep the working voltage at or below the rated specification in both DC and AC applications. We discovered that charging at no more than 70 of a capacitor's working voltage resulted in an amazing 10-fold increase in lifetime for one type of commercial capacitor. Also, for DC capacitors, watch out for voltage reversals, If your system has a lot of inductance, reverse voltage swings are always produced. Increase the safety margin if a lot of inductance is in the circuit. Furthermore, the temperature should be kept below 120°F As mentioned earlier, watch out for superimposed AC, voltage spikes, and ringing. These types of AC waves can drastically shorten lifetime, Tesla coils have notorious ringing. To repeat: if feasible, use an oscilloscope to visually analyze

your circuit. Often a power resistor inserted in the current path to the capacitor quenches ringing. With this criteria under our belts, let's look at some problems your design and construction methods should prevent.

Signs of Trouble. Your assembly techniques should seek to minimize the likelihood of a few possible problems. Luckily, all of them can be prevented at least in part by using ample amounts of insulating material such as No-arc or Corona Dope and/or high voltage putty on all exposed areas. A plastic case to enclose the apparatus is also recommended (more on that later),

Still and all, you should know what problems the insulation is preventing. The first problem insulation relieves is the possibility of electrical shock,

Insulation also minimizes the production of ozone—a gas created when high voltage causes three oxygen atoms to join together. Ozone has a tart, sweet "electrical" smell, and is 100 times as poisonous as carbon monoxide. Beware: it quickly causes headache, nausea, vomiting, and respiratory irritation. In addition to insulating all the exposed HV areas, you should also operate your equipment with good ventilation if it produces any ozone,

Closely linked to ozone generation is corona leakage. It is produced by a charge being leeched off a highly charged object by the air. That typically produces ozone. However, sometimes a device (such as a Van deGraff generator) is constructed specifically to display corona discharge, and insulating it would defeat that purpose. In such cases, good ventilation is the only practical means of hazard prevention.

Ozone can also be created by arcing, which can occur anywhere. However, ozone production is not the greatest hazard arcing presents. At 50 kV a spark can arc between an uninsulated contact and your body if you come within 2 inches of the contact. Arcing commonly takes two forms: directly through a capacitor's dielectric (as mentioned earlier), or across the edges of a capacitor's plates to an adjacent plate. A snapping sound indicates the presence of arcing, so keep your ears open,

Arcing from the edges of a capaci-

tor plate, or anywhere the shape of a conductor changes abruptly (such as the tip of a nail) is called point discharge. It can be readily observed in a dark room at very high voltages. Small, bright blue pinpoint(s) are seen leaking electrons into the air, accompanied by a hissing sound and copious ozone production,

Once again, insulation and proper ventilation are the proper solutions to all these problems, and there are some specialized techniques to insulate your capacitors and otherwise improve the safety of your high voltage projects. Let's get to those now.

Construction Requirements. A key ingredient in a good assembly is a proper case. Your capacitor's housing must protect it against moisture, dirt, and accidental discharge. Plastic cases for dry capacitors are easy to make with acrylic sheets glued at all corners with Silicone RTV Oil-proof cases can be made for immersed models, but you will need to rough-up the plastic at the sealing edges with sandpaper and use both a bonding and second fillet glue coating for a liquid-proof seal. Metal cases can be made from PC boards cut on a shear or large paper cutter and soldered at the edges. Copper roof flashing (available at hardware stores) works well too. However when using metal, always beware of contamination by solder rosin, solder bits, and other crud, which can short out plates or otherwise reduce efficiency

Whether a capacitor is enclosed or exposed, discharge paths must be wide enough to avoid arcs to the case, adjacent plates, terminals, connections, or components. That is especially important in situations where conductors must be left uninsulated. Note that the space from each plate to the edge of the dielectric must be wide enough to stop any spark from "crawling" over the edge of one plate to another.

Power leads must be capable of withstanding the full voltage of the charge plus at least a 50 safety margin. TV anode wire, which comes rated up to 40-kVDC, makes great leads. Vinyl tubing or aquarium air hose may be slipped over leads to increase their voltage rating,

Make sure the plates are securely mounted or they will tend to shift, or make a noisy rattle when used with AC. Glue or compress the assembly to hold it secure. With regard to mounting, keep in mind that glues that dry by evaporation of a volatile chemical might not set properly if "buried" inside an assembly away from air, and could thus become a fire hazard.

Rolled-up capacitors may be held securely by wrapping the interleaving layers of foil and insulator tight around an insulating mandrel and then taping with a clear PVC tape. Where necessary coat the ends with Silicone RTV. That will eliminate end-arcing flash-over and corona loss. Alternatively although it is somewhat brittle, paraffin (with a puncture voltage of 250 volts/

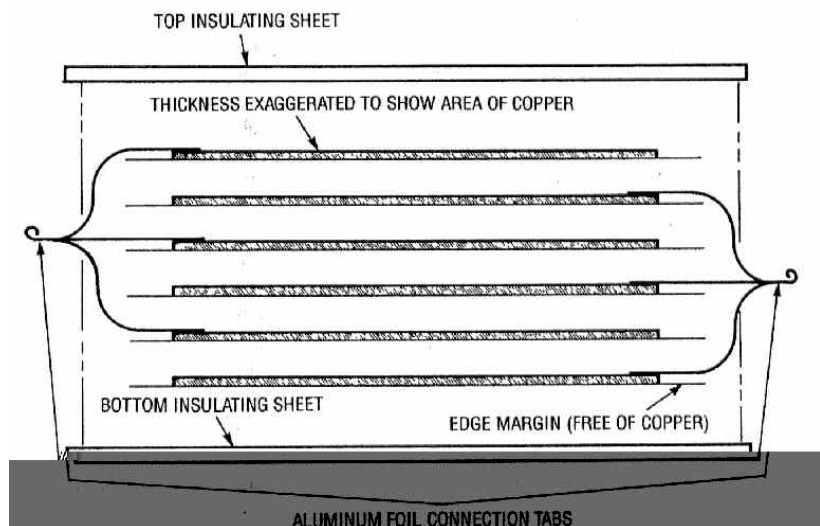

Fig. 3. With this design, you may stack as many plates as you wish, provided there are an equal number of plates attached to each lead.

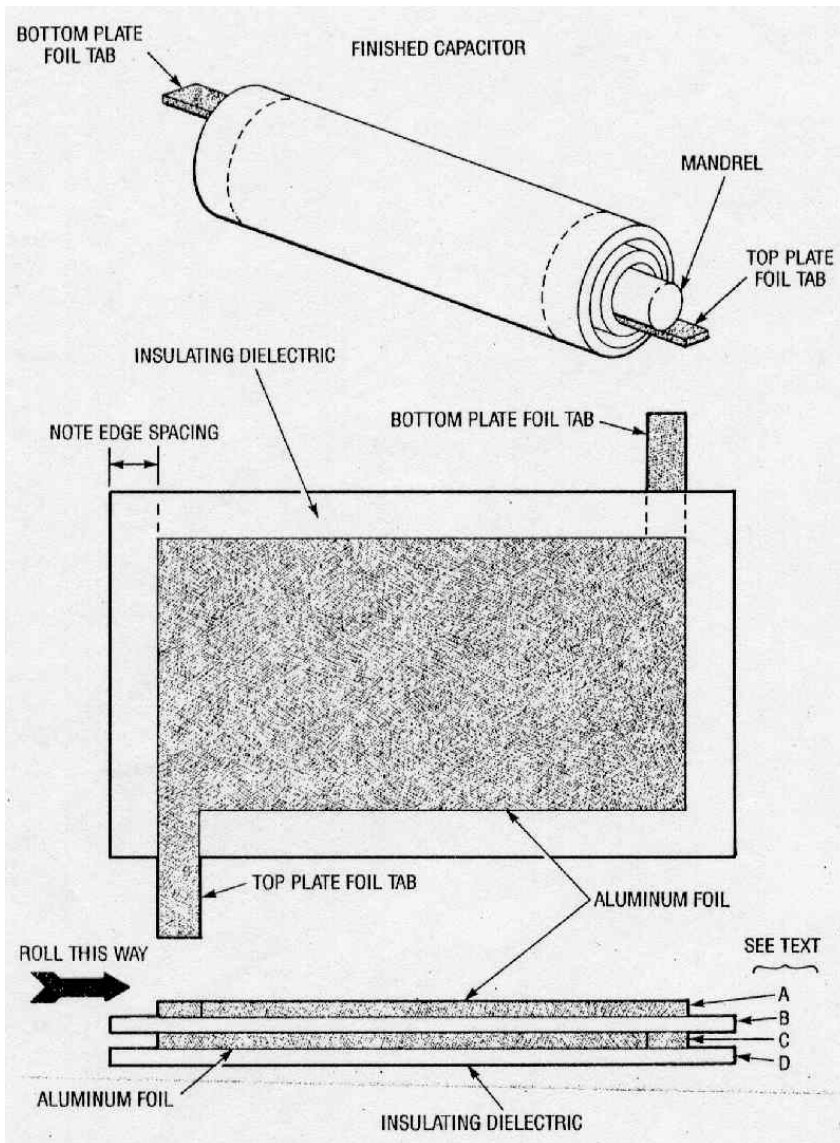

fig. 4. A rolled-up capacitor, like that shown here, can provide the greatest capacitance in the smallest space. Note that the dimensions in the side view have been greatly exaggerated for the sake of clarity

mil) is an excellent insulator for the ends of rolled-up capacitors and the edges of flat-plate type capacitors, if you want to use melted paraffin wax, heat the wax only in a double-boiler pan. since if it gets too hot it can catch fire. Be sure to apply several coats, allowing the wax to harden between each coat. Liquid electrical tape also makes a great end seal, however it is somewhat hard to find. Try mail-order distributors for that product,

High voltage terminals for your projects can be made from plastic rods drilled through to accept connection wires. You may add a nut and bolt on top for convenience. However, beyond about 3,000 VDC this method suffers from point discharge, Metal

balls make good terminals, Clean them up with a wire brush or steel wool to eliminate rough spots, The author uses fishing floats covered with either aluminum foil or nickel print paint for up to 10 kVDC, Split the bobbin first with a rator blade, remove the line holder and spring, and glue it together again with epoxy.

Furthermore, as you work, keep all materials as clean as possible. Not only will your work have a better appearance, but arcs and burn-throughs due to contaminants will be prevented. High voltage easily tracks along dust, surface contamination, and even finger oil (which contains salt), Also, we shall refer to a "section" as consisting of two conductive plates

with an insulating dielectric between them.

By now, we hope you have a good understanding of the principles and techniques involved in making your own capacitors. Without forgetting safety, let's talk about how to build some simple capacitors/any of which can be modified for your application.

A Leyden Jar Capacitor. Leyden Jars are one of the first types of capacitors made, having been invented nearly two and a half centuries ago. Their development was first recorded in 1745 by Ewald von Kliest, In 1746, Peter van Musschenbroeck of Leyden, Holland experimented further with the invention. We can build our own modernized units with a gallon-size wide-mouthed mayonnaise jar. The project only costs about \$2, and is good to at least 10 kVDC at 2,5 nR Units we've tested at 15 kVDC did not fail; at that voltage, the capacitors stored just under 1/2 joule each,

First select a jar without bubbles, cracks, or blemishes and that has a mouth large enough to comfortably slip your hand through. Next, carefully clean it out. You'll use aluminum foil inside and out as the conductive plates (see Fig. 1), Cut a foil disk 1-inch bigger than the bottom of the jar. Now coat the dull side of the foil and inside jar bottom with a thin, even layer of rubber cement, Let both dry for 10 minutes, and press together. Smooth with firm hand pressure, Avoid excess wrinkles. Do the rest of the inside except the top inch of the bottle using three or four pieces of foil, (It is easiest to do the plate in pieces instead of all at once. since rubber cement "grabs" and it is difficult to reposition the foil once contact has been made.) Now do the outside foil plate in pieces, leaving the top inch bare, Check the foils with a continuity tester to determine if the pieces are in good electrical contact. Areas of foil not in contact can be bridged with strips of foil or nickel-print paint.

For the top cover, cut two disks of clear plastic, one slightly smaller than the rim, the other 1/4-inch larger than the rim, Glue the two pieces together to form a plug, Drill a 1/4-inch hole through the plug's center. Cut and insert a length of 1/4-inch (outer diameter) metal rod or tubing through this hole, Attach a ball to its top, and sol-

der a wire or small-link chain to its bottom, The wire must make good electrical contact with the foil. Let the assembly dry for a day with the cover off, to allow vapors from the rubber cement to dissipate, then cement the cover on with silicone or Krazy Glue.

PC-Board Capacitor. Some nifty low inductance capacitors can be made from pieces of copper-clad epoxy circuit board (see Fig, 2), For a simple two-plate capacitor, you can use one double-sided sheet. For multiple sections, use single-sided board.

To prepare each board, start by etching away a 1-inch strip from around all its edges. That process can be simplified by first masking off the strip, spraying the bare copper with an etch-resistant paint, removing the masking tape, and then etching.

Clean the board after etching, and rinse with de-ionized or distilled water, Thoroughly air-dry the sections, or use a blow dryer. Attach strips of aluminum foil to each plate.

If you are building a multiple-section capacitor, connect the aluminum foil strips together as shown in Fig, 3 and secure them using glue or nylon bolts at each corner, Spray the finished assembly with several coats of an insulating product, or paraffin.

If you use the dimensions shown in Fig. 2 and a 0,060-inch gap between plates, you can achieve a capacitance of 1,94 nF (1940 pF) per section. When deciding on the gap width to use, keep in mind that the greater the space between successive plates the lower the chance of arcing, For example, a 1-inch spacing gives you a 30 larger gap than a 20-kV spark can jump. Insulation will further improve that margin,

The Stacked Sheet Design. This type is virtually identical to our PC board capacitor, but it can be designed to handle considerably more voltage. You simply substitute sheet plastic or glass dielectrics, and glue aluminum foil in place of the copper for each section (refer to the PC board capacitor drawing in Fig, 3 as needed). All in all, it's an easier design to build, as it does not involve the effort of etching copper, and you can continue to add sections to your original prototype to increase its capacity as future demands require.

Supply Sources

All types of plastics: United states Plastic Corp. 1390 Neubrecht Lane, Lima, OH. 45801; Tel 800-537-9724. Company charges for catalog and requires a minimum-amount order. Write or call them for details. Also the internet is loaded with company's that can supply everything you need. Search for copper, just by typing in copper metal or copper sheeting, same goes with mylar plastic. Many supply companies will pop up and you can then choose which one you prefer doing business with.

Small Parts Inc. 305-751-0856 USA

Allegro Electronics 203-672-0123

When building a large capacitor of this type, we suggest that you use nylon bolts at the corners to hold it all together, The bolt holes should be pre-drilled before assembly, and all chips cleared away Make sure the plate-to-edge spacing is adequate for the voltage you will subject the capacitor to. Add extra spacing if you intend to use bolts at the edges.

Glue foil carefully to the top of the first plate using a small amount of spray adhesive, Krazy Glue or RTV silicone. Press it smooth and let it dry A photographic finishing roller is handy for flattening foil. Repeat the procedure for the second sheet, orienting the foil connection tab in the opposite direction. Keep the plates and dielectrics aligned as assembly proceeds, Repeat this procedure for as many sections as you want. Always keep the final number of plus and minus plates equal.

Put an insulating sheet above and below the last plate and secure the assembly with nylon bolts. Do not over tighten or the center of the assembly will "bow." Finally, clean the ends with a very small amount of isopropyl (rubbing) alcohol and wipe dry Smear a coating of silicone RTV over all the edges.

Roll-Up Design. The kind of capacitor depicted in Fig, 4 can provide large capacitance in a small size, They are a little trickier to make than stacked-section type capacitors, so you might want to try a few small pro-

totypes first. The design uses a layered approach (as shown), and we suggest using only one section as it is difficult to align and wrap multiple sections. By contrast, a single section several feet long is not too unwieldy

Aluminum foil works great in these capacitors. You'll find the oven/broiler type, which is heavy-duty foil, far easier to work with than the plain variety Polyethylene and Mylar are the most common dielectrics, but you can experiment with other materials.

Looking at the figure, note the orientation and shape of the foil plates (A) and (C), They can be easily secured to the dielectric (B) using double-sided Scotch tape. Note also the edge spacing. An outer covering of dielectric (D) will prevent the finished capacitor from having a "hot" case, which might be a hazard. With those points in mind, lay the foil out on a smooth sheet of paper, which in turn should be laid out on a smooth, hard surface to prevent wrinkling. Carefully assemble the four layers as shown in the drawing. Strive to make them flat and smooth.

Wrap the capacitor "sandwich" around a non-conductive mandrel or spool—ideally made of plastic or glass rod (be careful not to break a glass rod). Try to make the roll straight and free of lumps and wrinkles. When its all rolled up, secure it with plenty of tape. The author uses clear package-sealing tape for this. Now secure the positive foil tab (assuming it's going to be for DC) to the mandrel using tape, Finally coat the exposed ends with an insulating product like silicone RTV

The remaining foil connection tab may be reinforced by rolling it around a small metal dowel, A nail, or a cut-off piece of 1/8-inch uncoated brazing rod is suggested, Apply glue to hold the assembly together,

Foil tabs can be strengthened by adding "ribs" of adhesive from a hot glue gun. Similarly the tabs can be made tear-resistant by applying hot glue where they enter the capacitor.

Note most problems with this design come from particle contaminants that stretch a dielectric thin in spots where they are trapped by the tightly rolled dielectric. Another trouble is inadequate edge spacing, causing arcing across the ends, Careful planning and assembly will eliminate both headaches,

HIGH VOLTAGE CAPACITORS



Copyright 1996 - 2003



This is a 4,000 volt to 5,000 volt Homemade High Voltage Capacitor, We made this capacitor for our free energy experiments and it worked very well. We used aluminum roof sheeting from a hardware store, we cut aluminum to 4 1/2" x 6" sheets and used about 200 pieces. In this design we only used one bolt hole per side, we found that was a mistake, it is far better to have 2 bolt holes per side. Each hole must be drilled on a jig so as to get all the holes drilled in the exact same spot on each piece. If holes are not drilled in the same spot, you will have a large problem when trying to push the + and Negative bolt conductors through the holes. You can not assemble and glue all the negative and positive stacks together and then drill one hole, it does not work we already tried that.

The more aluminum plates you stack and add to your capacitor the more amperage your Capacitor will be rated at and will hold. But as an example, if you cut 200 pieces then you will use 100 pieces for the positive side and 100 pieces for the negative side. Cut 10 mil Mylar clear sheeting larger than the aluminum, if you do not your capacitor will arc. But even if it does arc it will not destroy your capacitor you will just see a lot of cool looking sparks going off inside of the clear casing. Make a plywood base with 4 wood dowel rods coming up from the wood base, so you can place each sheet through the rods and down flat onto the wood base, for example: Left rods will be positive, and the 2 right rods will be negative. If you have all your aluminum pieces cut and drilled then begin placing them onto the wood base, first place a positive plate through the left wood dowels and onto the wood base, then spray one piece of precut mylar with spray adhesive, let dry 30 to 60 seconds and then place over top of the positive aluminum plate located on your wood base that you placed down earlier, now spray the top of mylar also and then place your negative plate onto the left dowel rods and down onto the mylar, you will repeat this step until you have one large capacitor stack. Before inserting your metal bolts, place metal washers in between the plates, start with the positive side first then the negative side, you can insert washer as you are placing the bolt through each plate at a time. Optional: You can use 2 bolts and 2 dowel rods, + gets one wood rod and one







Marking off your aluminum



Use a Mat Knife to cut and score your aluminum sheet, You do not need to cut all the way through, score it and then bend it back and forth and the aluminum will break.

Although not shown, use a metal or plastic straight edge to follow your cut.

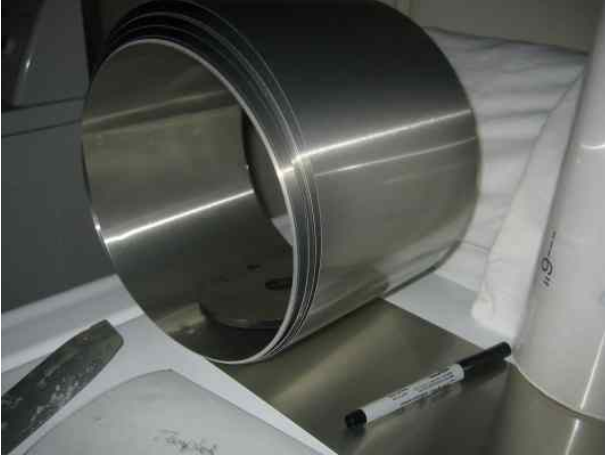

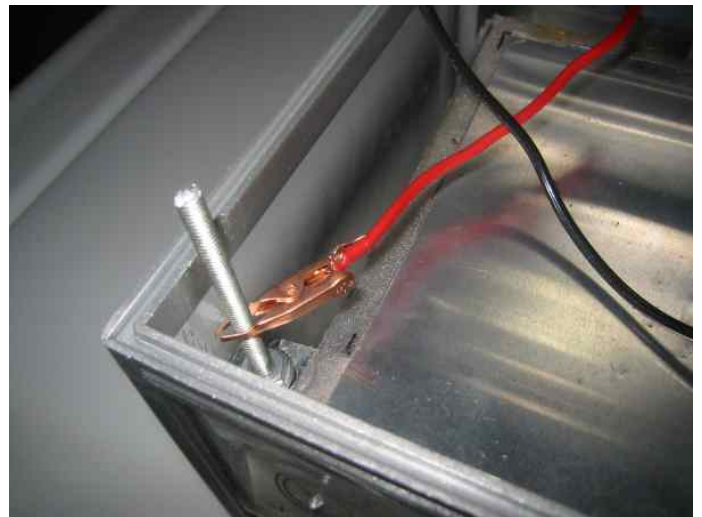



Top View
with lid open

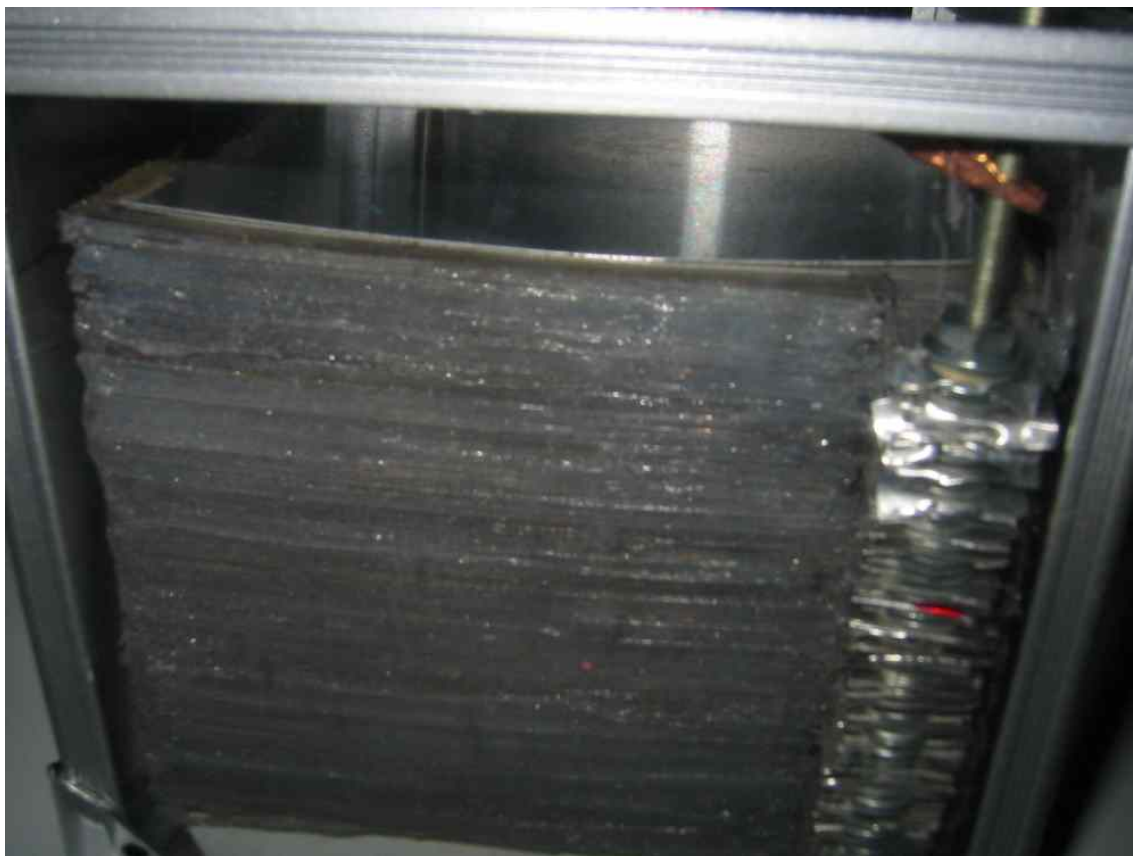

Side View





You will need a drill press for drilling holes.



Drill press jig for making precise holes for each plate, which must be in the same spot.





When finished, bolting your stacks together, use clear silicone caulking and a card board squeegee to spread and coat the outside of the capacitor on all 4 sides, Be sure to fill all cracks, let dry for 24 hrs. Doing this will help prevent HV Sparking. Which can be dangerous.

WARNING: Never apply High Voltage when capacitor is outside of it's protective casing. **Always wear rubber gloves.**

Good luck, and I hope you have just as much fun as we had!
Let us know how it goes.

Thank you
David Waggoner

Creative Science & Research
PO BOX 557
New Albany, IN. 47151

www.fuellesspower.com