

# Self-organizing Flow Technology

- in Viktor Schauberger's Footsteps



Lars Johansson  
Morten Ovesen  
Curt Hallberg

Institute of Ecological Technology  
Scientific and Technical Reports - 1

Malmö - Sweden - 2002

Lars Johansson  
Morten Ovesen  
Curt Hallberg

## Self-organizing Flow Technology - in Viktor Schauberger's Footsteps

This report tries to evolve a new perspective on the ideas of the Austrian naturalist Viktor Schauberger, with the aid of concepts from modern research into chaotic and self-organizing systems. The focus of the report is on modelling. With the aid of concepts like self-organization, free and forced vortex flow, chaotic pulsation, mathematical bifurcations and minimal surfaces, and with flow images like "handkerchief dynamics" and "toroidal vortex flow", we try to sketch a natural sciences perspective that comes close to Schauberger's.

We replicate the Stuttgart experiments with vortex generation and particle separation, and give an overview of existing research in the area.

The report also covers applications such as oxygenation of water, e.g. in fish ponds, bathing facilities, and sewage plants, and particle separation, e.g. in laundry plants, the food industry, and paper-mill industry. Some perspectives are also given on restoration of natural waterways and minor lakes or bays.

Institute of Ecological Technology  
Krokegatan 4  
S - 413 18 Goteborg  
Sweden

IET Malmö  
Lantmannagatan 64  
S - 214 48 Malmö  
Sweden

Email: [info@iet-community.org](mailto:info@iet-community.org)  
Web: [www.iet-community.org](http://www.iet-community.org)

# Preface

This report, originally published in 1997 in Swedish, is here available in English translation for the first time.

During the years since this report was first published we have met interest in and gained renewed understanding into processes and perspectives that could be characterized as Viktor Schauberger's.

As the report now exists in its second edition, we have kept the text much as it was originally written. Some passages that were unclear we have tried to clarify and elucidate, and some errors and typos have been corrected, but mainly the text stands as it was originally written.

We are happy that the renewed activity at the Institute of Ecological Technology has made it possible to publish the report at the institute.

A special thanks to Olof Alexandersson for his kind assistance and for having paved the way for the scientific study of the ideas and inventions of Viktor Schauberger.

We would also like to give a special thanks to the Department of Limnology at Lund University who furnished us with (some of their old) equipment for this project.

Thank you all of you who have supported us over the years, and who have made this project possible.

Malmö, May 2002

Lars Johansson  
Curt Hallberg  
Morten Ovesen

# Contents

Summary	v
1 Introduction	1
1.1 Viktor Schauburger .....	2
1.2 Knossos water supply.....	3
1.3 The Stuttgart experiments .....	4
1.4 A new perspective .....	5
2 The Stuttgart experiments	7
2.1 Experiments with a rectangular vessel.....	7
2.2 Experiments with a trumpet shaped vessel .....	9
3 Modelling Tools	11
3.1 The particle perspective .....	12
3.2 The vessel perspective — a self-organizing perspective .....	14
3.3 Free and forced vortices.....	15
3.3.1 The axial velocity, $V_z$ , and reverse flow.....	16
3.3.2 The tangential velocity, $V_\theta$ , and its importance.....	18
3.4 Flow image modelling .....	20
3.4.1 The handkerchief dynamics.....	20
3.4.2 Chaotic pulsation in the vortex.....	22
3.4.3 Bifurcations .....	22
4 Oxygenation and ion precipitation	25
4.1 The principle of the Plane pump.....	25
4.1.1 Experimental set-up.....	26
4.1.2 Subpressures and equilibria.....	27

CONTENTS

4.2 Oxygenation of water ..... 29

4.3 Ion-precipitation ..... 31

5 Separation ..... 33

5.1 Hydrocyclone technology ..... 33

5.1.1 Estimating separation properties ..... 33

5.2 The principle of self-organizing separation ..... 34

5.3 Separation with an egg-shaped inlet vessel ..... 36

5.3.1 Separation of pieces of thread ..... 38

5.4 Self-organizing separation in a barrel ..... 39

5.4.1 Separation of suspended materials ..... 39

5.4.2 Removal of oil from water surfaces ..... 39

6 Applications ..... 41

6.1 Treatment of drinking water ..... 41

6.2 Treatment of industrial process water ..... 41

6.3 Treatment of sewage water ..... 42

6.4 Restoration of ponds and water courses ..... 42

6.4.1 Oxygenation of ponds and minor lakes ..... 42

6.4.2 River regulation and restoration ..... 44

Bibliography ..... 47

## Summary

In this report we have tried to establish a language assisting the understanding of the ideas of the Austrian naturalist Viktor Schaubberger, with the aid of concepts from modern research into chaotic and self-organizing systems.

We have replicated some of the experiments Schaubberger and Popel performed in Stuttgart in 1952, relating to vortex generation and particle separation.

Prom this point of view we have tried to create an overview of existing research in the area. We have more specifically studied the principles governing particle separation and oxygenation, and made a sketch of how these views can be used for water engineering more aligned to nature.

The focus of the research has been on modelling. With the aid of concepts like self-organization, free and forced vortex flow, chaotic pulsation, mathematical bifurcations and minimal surfaces, and with flow images like "handkerchief dynamics" and "toroidal vortex flow" we have tried to sketch a natural sciences perspective that comes close to Schaubberger's.

Several technological applications based on this perspective exists, e.g. within water treatment and watercourse restoration.

An important application is oxygenation of water, in e.g. fish ponds, bathing facilities, and biological ponds at sewage plants. By letting a vortex funnel with air be pulled down to a specially designed suction pump, air will be injected in the form of very fine bubbles. This technology could be used at sewage plants in stead of the present flotation method - where air is pressed into the water at the bottom at high pressure, which normally consumes a lot of energy. With the same principle at a somewhat greater scale it could be possible to restore the level of oxygen in waterways, lakes or minor bays at sea.

The possibilities exists for treating industrial process water, e.g. by separating particles and oxygenate the water to create an aerobic bacterial fauna in the water, which can then be reused or recycled. This would have applications in laundry plants, in the food industry, and in paper-mill industry, where water consumption is high. Another possible application could be to "trap" oil belts floating on the sea into a vortex funnel where the oil then could be separated.

Further research could look at upscaled versions of watercourse restoration or at the effects on (and possible separation of) ions in water, e.g. for drinking water. Here applications interesting for the third world can be imagined.

# Chapter 1

## Introduction

This report is an attempt to understand and learn from the ideas and inventions of the Austrian forester Viktor Schauberg. Viktor Schauberg already in the 1920s warned about environmental crisis, at a time at which it was not, as today, something recognized. Throughout his lifetime he encountered resistance and ridicule, and his perspective may still today be labelled as unconventional and unorthodox, although much of what he wrote about our handling of waters and forests today is more relevant than ever. As he wasn't an academic, but was more of a natural philosopher, he had trouble to communicate his ideas with contemporary scientists. In this report, we'll try to show how modern research in chaos and self-organizing systems give us a possibility to shed some new light on Viktor Schauberg, and perhaps establish a deeper understanding of the phenomena he described.



Figure 1.1: Viktor Schauberg.

## 1.1 Viktor Schauberger

We will call our perspective self-organizing flow, so called since the technology described exploits the intrinsic order spontaneously created by a system during the right conditions.

Such a view was advanced in the 1920s by the Austrian naturalist Viktor Schauberger [1]. Schauberger was a forester and timber-floating expert. He was no academic, but he had a long tradition of studies of nature to rely on. He also had rich opportunities to study the processes of nature in untouched areas, when it came to the handling of watercourses and the quality of water. His approach was that man should study nature and learn from it, rather than trying to correct it — a view that was rather controversial at his time<sup>1</sup>. He noted that mankind had a developed technology for exploitation of water, but still knew very little of the processes of natural waters, and the laws for their behaviour in an untouched state.

Schauberger gave the following example: In a mountain stream he observed a trout which apparently stood still in the midst of rapidly streaming water. The trout merely manoeuvred slightly, looking rather free from effort. When it got alerted it fled against the stream - not with it, which at first sight would have seemed to be more natural.

On some occasions a cauldron of warm water was poured into the stream, quite a long distance upstream from the fish, for a moment making the river water slightly warmer. As this water reached the fish, it could no longer sustain its position in the stream, but was swept away with the flowing water, not returning until later. From this experiment Schauberger concluded that temperature differences are of great importance in natural river systems. He even tried to copy the effect of the natural movements of the trout in a kind of turbine which he called trout turbine.

By studying the gills of the fish [1], Schauberger found what looked like guide vanes. These, he theorized, would guide streaming water in a vortex motion backwards. By creating a rotating flow, a pressure increase would result behind the fish, and a corresponding pressure decrease in front of it, which would help it to keep its place in the stream<sup>2</sup>.

Schauberger constructed a series of extraordinary log flumes that went against the conventional wisdom of timber floating at his time. The flumes didn't take the straightest path between two points, but followed the meandering of valleys and streams, see Figure 1.2. In these flumes, guide vanes were mounted in the curves, making water twist in a spiral along its axis. This fact, together with a meticulous regulation of water temperature along the flumes and waterways used, made it possible to float timber under what was traditionally regarded as impossible conditions, i.e. with significantly less water needed than traditionally, over long distances and with a transport rate which significantly exceeded what was considered normal. It was even reported that timber more heavy than water could be floated<sup>3</sup> - timber that would sink to the bottom under normal conditions. Remnants of these flumes and floating arrangements still exist today, and can be observed at different locations in Austria.

<sup>1</sup> This was at a time when central European forests were cut down at large scale and, as a consequence, mountain streams were clad in concrete in order to limit the severe erosion by floods.

<sup>2</sup> E.g. a pulsating jet of toroidal vortexes could develop, aiding the fish in thrusting against the stream [19]. Schauberger also held the view that small amounts of trace materials, such as copper, were significant in these processes.

<sup>3</sup> Winter hewn beech and larch.



## 1.2. KNOSSOS WATER SUPPLY



Figure 1.2: One of Schauburger's log flumes. Note the egg-formed section, and how the flume meanders like a stream. The Krampen-Neuberg flume in Austria, 1930s.

## 1.2 Knossos water supply

It is interesting that a water supply technology that displays some similar characteristics can be found on Crete, at the remnants of the ancient Minoan culture.

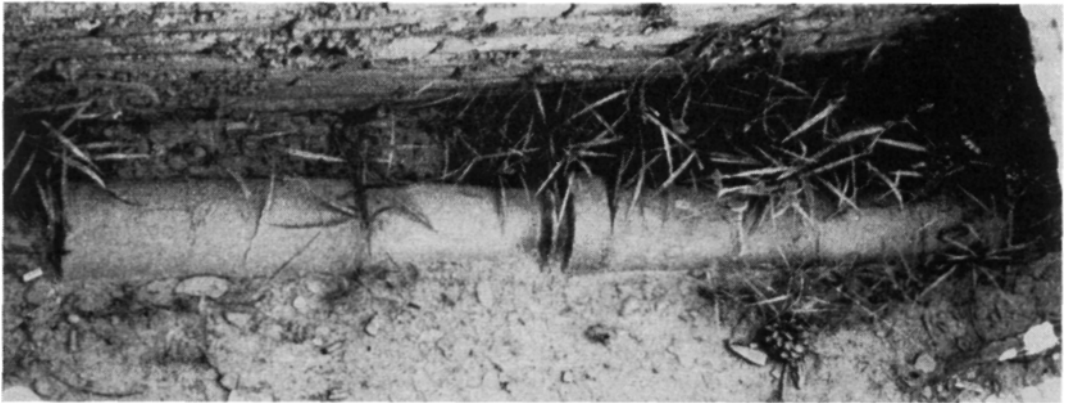

Figure 1.3: Some of the conical water pipes at Knossos. From the western part of the palace, close to the grain silos.

Early in the 20th century, Arthur Evans discovered and restored the palace of Knossos, situated at Kefala hill at the centre of Crete. The oldest parts stem from around 2100-2000 BC. On the walls vortexes and spiralling patterns abound — one wall drawing e.g. shows a Karman vortex street — displaying that swirling water inspired the inhabitants of the place [11]. Water certainly was central in Minoan mythology — and treated as something sacred.

The water supply system is especially interesting. Conical pipes made of terra-cotta, where the narrow opening of each pipe section sticks well into the wide opening of the

next section were used, see Figure 1.3. Apart from making it easy to lay out the pipes in a curved fashion, the tapered shape of each section would give the water a shooting motion<sup>4</sup>, which would have assisted in preventing the accumulation of sediments. As noted by Evans [11], this would make them more advanced than nearly all modern systems of earthenware pipes, which have parallel sides. One stretch of pipes even showed an upward slope, indicating that Minoan engineers were well aware of the fact that water finds its own level. In some channels for water, braking vanes, to brake the water at the outer curves can be seen [2].

### 1.3 The Stuttgart experiments

This report is based on the experiments made by Viktor Schauburger and Prof. Franz Popel at the Institute of Technology in Stuttgart in 1952 [31]. One of the objectives of these experiments was to investigate the possibility of using different kinds of pipes with rotating water, in order to separate the water phase from a suspension of hydrophobic material.

The underlying idea was to use a vessel connected to a straight pipe from below. Water was injected tangentially and was allowed to swirl down into the pipe. A vortex would appear, and particles in the swirling flow would accumulate at the centre of the vortex, where the pressure was the least. With suitably designed pipes it was then possible to separate the hydrophobic material.

The importance of the design of the inlet vessel was also studied. By using a rectangular and a round vessel, two rather different cases could be studied. Not only straight pipes were used, but also conical and spiralling pipes were used. Pipes made of different materials, such as glass and copper, were studied as well. The experiments were extended into investigating the frictional losses of different pipes and materials.

The results were rather astonishing. Schauburger and Popel observed that the frictional resistance decreased the more conical and spiralling the pipes were made. Pipes made of copper had a lower flow resistance than pipes made of glass. The spiralling copper pipe produced an undulating friction curve as the flow was increased. At some flows a negative friction was observed, as if water seemed to lose contact with the walls and fall freely through the pipe. How to interpret this remains to be seen.

An underlying principle of the Stuttgart experiments is the rotation of water around its own axis, while it is flowing along a spiralling path with decreasing radius. The rotational velocity increases towards the centre where a sub-pressure exists.

Let us study a "bath tub vortex" to illustrate this. With a slow enough flow, water flows more or less straight down into the pipe. But at a critical flow a transition takes place, a bifurcation, and water starts to swirl in a vortex.

In order to make water organize itself into this kind of flow, we only have to create the right conditions, which in turn will generate the spontaneous emergence of a subpressure axis. This could be arranged by using a suitable geometry of the vessels, or by introducing different kinds of guide vanes, pressure sinks etc. (More generally, we have to look at the system and its interaction with its surroundings as a whole.) The system then is in a state of dynamic equilibrium, where it is always changing but where its structure is yet stable.

<sup>4</sup> By giving the peripheral water a vaulting toroidal flow.

## 1.4. A NEW PERSPECTIVE

### 1.4 A new perspective

This is a perspective that is very similar to that of Viktor Schauberger's way of reasoning. He early observed that untouched watercourses had a kind of structural stability. From those observations he suggested methods for river regulation — based on the perspective of giving water impulses for self-organization to take place. By using suitable guide vanes and by taking into account the effect of the surrounding vegetation on water flow and temperature, he could make a watercourse self-organize into a stable river bed.

This way of regulating rivers and watercourses differs from the traditional ways, which tries to steer the flow and which disregards the 'eco-system' that the flowing water and its interaction with the river bed and vegetation makes up — with floods and bank erosion as the natural result. Schauberger e.g. noted that the sediment transport capacity of the flow affected sand and bank development, which affected vegetation, which in turn affected the flow image of the water, through among other things the vegetation's cooling effect. The system bites itself in the tail, as it were.

A problem has been to interpret the language of Schauberger, as it was more that of a naturalist than of a hydrologist. He more looked at the wholeness of the system, than to its detailed composition, and focused on its flow image, without knowing or modelling the underlying mechanisms.

Such a perspective does not look for as detailed a model as possible, but for the simplest model that has the same kind of fundamental properties as the system. It is a perspective that is close to that of modern chaos science. It has shown that disparate and seemingly complex behaviours often can be captured by (ridiculously) simple models<sup>5</sup>. This is due to the fact that dynamical behaviours at e.g. phase transitions are universal, and appears in a wide range of systems [14, 43].

This is the perspective we will bring with us, as we in this report reinterpret and re-examine parts of the Stuttgart experiments and some of the possible applications. We will replicate some of these experiments, and from this try to evolve useful models, which can help to bridge the perspective of Viktor Schauberger with that of the modern natural sciences. This leads naturally to some of the main applications — water treatment and restoration of watercourses. We will take a closer look at these in this report.

<sup>5</sup> Consider by contrast the complexity of a traditional approach at modelling a highly non-linear system such as free surface flow with an air funnel.

# Chapter 2

## The Stuttgart experiments

In this chapter we will study the experiments performed by Schauburger and Popel at the Institute of Technology in Stuttgart in 1952 [31]. The purpose of these experiments were to investigate vortex flow in pipes. A lot of the experiments were devised to study the development of friction, especially in twisted, spiralling pipes. These experiments have been replicated by Kullberg [17], with positive results. In order to get a more thorough understanding of the phenomena and flow images present, we replicated those of the experiments that were relevant for separation technology: the study of vortex generation and particle concentration.

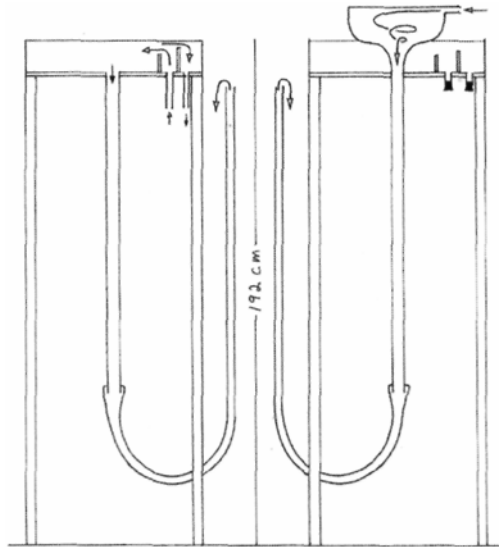

Figure 2.1: Schematic drawing of the experimental setups. Rectangular and trumpet shaped vessels respectively.

### 2.1 Experiments with a rectangular vessel

At the first experiment a rectangular vessel was used, where water slowly would well forth across an edge, see Figure 2.1 and 2.2, in order not to stimulate vortex formation. All

vortex generation thus was self-organizing (see the chapter on modelling).

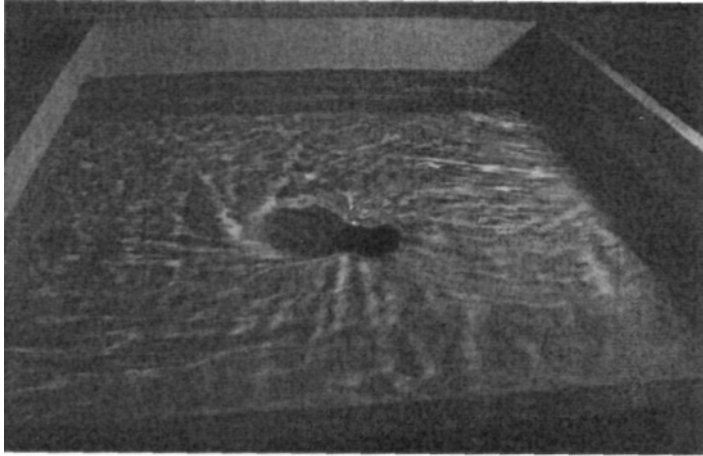

Figure 2.2: The rectangular vessel.

The flow was kept reasonably slow, 0.2-0.4 l/s. A weak vortex generation could be observed. The flow would organize as a spiralling space curve along the pipe. A thread that was hanging from the inlet was sucked into the pressure minimum, and formed a curve with increasing wavelength and decreasing amplitude along the tube, see Figure 2.3. The air bubbles that appeared in the tube would behave similarly. Kullberg observed in his experiments that the isobars for the static pressure across sections of the tube formed egg-shaped curves.

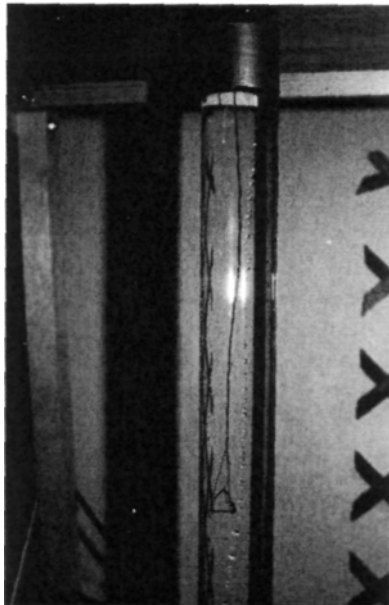

Figure 2.3: The spiralling space curve — here visualized with the aid of a thread and bubbles of air.

## 2.2 Experiments with a trumpet shaped vessel

The rectangular vessel was replaced by a trumpet shaped vessel with tangential inlets, see Figure 2.4. This of course stimulated vortex generation. The shape of the vessel and the arrangement of water injection were essential for this. The water flow was the same as in the previous experiment, 0.2-0.4 1/s.

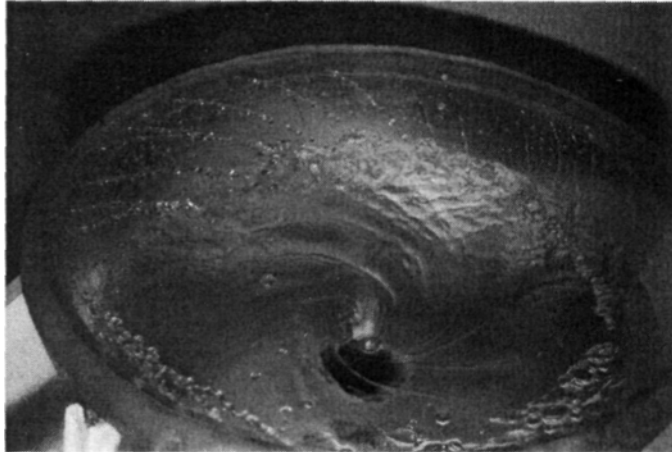

Figure 2.4: The trumpet shaped vessel. Here the strong vortex generation can be seen.

A stronger vortex generation could be observed. Particles (coffee), that were spread on the surface or injected in the form of a suspension, were sucked towards the centre just as the thread. This leads to the question if it would be possible to use the technology to separate or concentrate suspended materials.



Figure 2.5: The experimental set-up, as seen from the side. In the middle of the pipe a string of coffee-particles can be glimpsed.

We will in the following try to visualize what is going on in the experiments, and see how this can be related to Schauberger's view of water.

# Chapter 3

## Modelling Tools

In this chapter we will try to define some theoretical tools and models that can be useful for addressing problems with self-organizing flow, or more generally, for focusing on the dynamics of flowing systems rather than on their composition. In this respect, our point of view will be closer to that of chaos and complexity research than to traditional fluid dynamics. A common feature of both chaos and complexity research is to focus on the behaviour of a system and on patterns that appear, rather than the detailed composition of the system [14, 43]. This view is also very close to Schauberger's own, whose language was more that of a natural philosopher than of a fluid engineer.

We will begin rather close to traditional theory, by investigating the forces acting on a suspended particle. This is of course relevant for separation. Then we will study some general principles of self-organization, and especially vortex flow patterns, which will play an important role later on. In the section on flow modelling we will discuss how flow can be modelled without knowing much of the mechanisms involved, with bifurcations and chaotic dynamics being treated more superficially.

As examples of flowing systems we'll study two systems — a Stuttgart experiment resembling set-up, "the egg-tube", and a barrel with swirling water at the centre, "the barrel", see Figure 3.1.

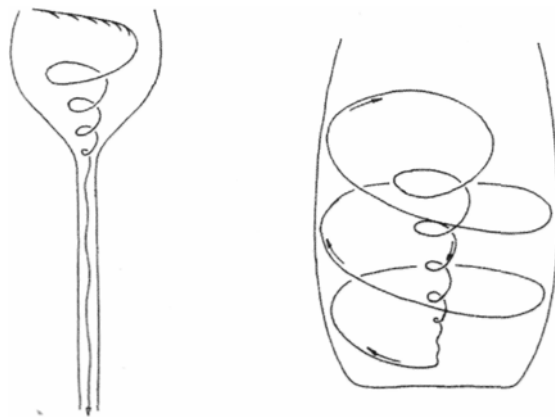

Figure 3.1: Two geometries, the egg-tube and the barrel.

In the egg-tube a strong vortex flow is induced by a series of tangential inlets. The swirling

water then continues down the pipe and gradually disappears out of the system — the principle behind the Stuttgart experiments.

In the barrel a swirling flow is created by sucking down water at the centre and diverting it towards the sides at the bottom of the vessel — the principle behind a vortex agitating apparatus like the Aquagyro, see Figure 4.2.

### 3.1 The particle perspective

Let us study a particle in a medium, e.g. a coffee particle in water. What forces are acting on the particle? We can discern 4 different kinds of forces.

- Inertia tries to keep the particles (and water) in a straight course. In order to move a fluid element along a circular curve, we thus have to apply a centripetal force on the element. (The same of course applies for a particle immersed in a fluid.) This force amounts to:

$$F_{centripetal} = \frac{mv_{\theta_p}^2}{r}$$

Here  $m$  is the mass of the particle,  $v_{\theta_p}$  its tangential velocity, and  $r$  the radius of its rotation. (If the co-ordinate system rotates with the particle, it is "at rest" with respect to the tangential direction, but instead it experiences a fictitious force, the centrifugal force, due to the curved rotating co-ordinate system.)

- "Lift force". Pressure differences on opposite sides of the particle create a resulting force in the direction of the pressure gradient (of the static pressure). In a rotating flow this is (locally):

$$F_{\frac{\partial p}{\partial r}} = \frac{\rho_v v_{\theta_v}^2}{r} V_p$$

Here  $\rho_v$  is the density of the fluid,  $v_{\theta_v}$  the tangential velocity of the fluid,  $r$  the radius of rotation, and  $V_p$  the volume of the particle.

- Viscous drag forces. If the water is moving with respect to the particle, the particle will be subjected to a viscous force, trying to cancel the velocity difference between the particle and the fluid. For small velocities the force is proportional to the velocity difference. (The fluid drags the particle along with itself, alternatively tries to reduce to relative motion of the particle, depending on which perspective is used.)
- The Magnus effect, which causes a ball to screw its way through the air, is acting on rotating particles and is often difficult to model. It is in general directed towards the centre when a particle is moving from regions with lower velocity towards regions with higher velocity, and thus is lagging behind the fluid, e.g. a particle that is caught in a free vortex. The influence on the particle is greater the greater the particle is.

A traditional approach is to study force equilibrium for the first three kinds of forces. After some calculation, one arrives with Stoke's law for the velocity of the particle (with respect to the fluid):



### 3.1. THE PARTICLE PERSPECTIVE

$$\Delta v_r = \frac{v_\theta^2 D^2 (\rho_p - \rho_v)}{18\mu r} \hat{\mathbf{r}}$$

Here  $\Delta v_r$  is the relative velocity of the particle (with respect to the fluid) in the radial direction,  $v_\theta$  the tangential velocity of the fluid,  $D$  the diameter of the particle,  $\rho_p$  and  $\rho_v$  the densities of the particle and the fluid respectively;  $r$  is the distance to the centre of the vortex,  $\hat{\mathbf{r}}$  the unit vector in the radial direction and  $\mu$  the kinematic viscosity of the fluid.

The above formula involves some approximations, e.g. that the pressure gradient is reasonably linear across distances such as a particle diameter, and that the particle doesn't affect the flow pattern to any great extent, i.e. small particles in dilute flows. Also, the Magnus effect is ignored. For large particles these approximations aren't necessarily valid close to the centre of the vortex, where e.g. the Magnus effect will make itself manifest.

Also, it is assumed that the particle moves with the same velocity as the flow, in the tangential direction. But what happens if the particle is being retarded with respect to the velocity of the water?

In order to keep a particle in circular motion at a constant radius, we have to apply a centripetal force,

$$F_{centripetal} = \frac{mv_{\theta_p}^2}{r} = \frac{\rho_p v_{\theta_p}^2}{r} V_p$$

where we have introduced  $\rho_p$  as the density of the particle, and  $V_p$  as its volume.

Since the fluid is rotating, a pressure gradient appears in the radial direction, giving rise to a lift force, which tries to push the particle towards the centre. It is, from above,

$$F_{\frac{\partial P}{\partial r}} = \frac{\rho_v v_{\theta_v}^2}{r} V_p$$

In order to get a particle to move towards the centre we thus have to have:

$$F_{\frac{\partial P}{\partial r}} - F_{centripetal} > 0$$

whence,

$$\frac{V_p}{r} (\rho_v v_{\theta_v}^2 - \rho_p v_{\theta_p}^2) > 0$$

hence,

$$(\rho_v v_{\theta_v}^2 - \rho_p v_{\theta_p}^2) > 0$$

If the particle has the same velocity as the fluid we get  $(\rho_v - \rho_p)v_{\theta_v}^2 > 0$ , i.e. only particles that are lighter than the fluid will move towards the centre. If, however, the particle in some way is retarded with respect to the fluid (in the tangential direction), the expression can be  $> 0$  despite the fact that  $\rho_v - \rho_p < 0$ , i.e. also particles that are heavier than the fluid can be made moving towards the centre.

An example of this is if beads (or tea leaves) rest on the bottom of a barrel (or cup) with a rotating flow. As long as they are retarded enough by the friction against the bottom, they will be pushed towards the centre (the axis of rotation) and accumulate there.

### 3.2 The vessel perspective — a self-organizing perspective

Let us contemplate the water that is swirling in the funnel-like vessel. It then becomes obvious that there are at least 2 distinct ways of generating a vortex flow:

- External forcing — i.e. the fluid is accelerated from the rim, through the tangential injection of water that strikes into the bulk of water.
- Inner self-organization — by the creation of a subpressure from below, the fluid will organize itself into a vortex, since conditions for such a self-organization then appears.

What is actually meant by self-organization? The key point is that we do not have to try to steer water into a specific course, e.g. through mechanical mixing, or through a specially arranged geometry that is diverting the flow.

What we have to do is to create the right conditions, then the water flow will organize itself. We can e.g. observe water flowing out of a bottle. At low flows the water behaves nicely and flows straight out, but at a critical flow the system undergoes a bifurcation (in the mathematical sense). The old behaviour becomes unstable and the system undergoes a spontaneous transition to a new behaviour that is stable. The water flow organizes itself into a vortex — a macroscopic structure has emerged spontaneously out of the flow, see Figure 3.2.

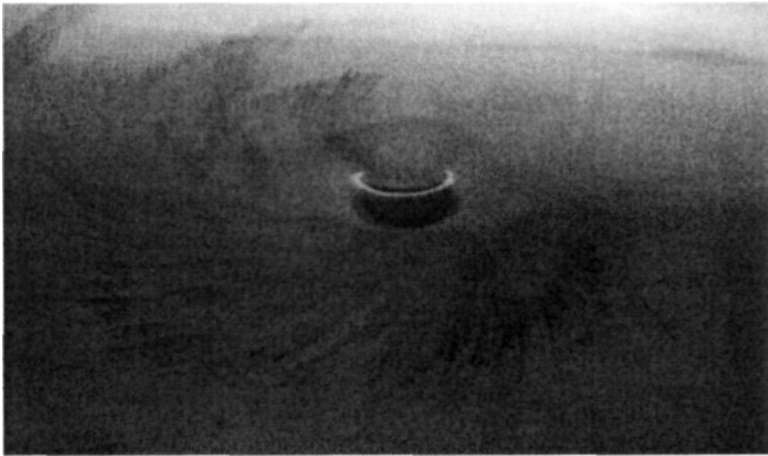

Figure 3.2: A self-organized vortex, here visualized with the aid of Potassium permanganate.

The vortex example is a classical dissipative system — a characteristic example of self-organization, which has been discussed by Prigogine [30]. Another self-organizing system is Benard convection [14, 25, 42], which appears when a fluid is heated from below. (At a crucial heat flux the fluid organizes into hexagonally ordered rolls, which transport the heat more effectively than plain conduction of the heat. This is actually what happens when water starts to simmer.)

Prigogine has formulated criteria for the appearance of self-organization in a system [24, 25]:

### 3.3. FREE AND FORCED VORTICES

- The system is dissipative — i.e. open and subjected to a flow which consumes energy at the macroscopic level.
- The system is far from thermodynamic equilibrium.
- Its parts co-operate in such a way that the system acts as a whole, self-catalytic — e.g. a non-linear system with some positive feedback.

In order to create self-organization in a dissipative system, such as one above, we only have to give the system an impulse, i.e. create the right conditions. Through the positive feedback, fluctuations will be amplified to the macroscopic level — the microscopic movements have suddenly organized themselves into macroscopic motion.

The system is in a state of dynamic stability, a continuously changing state, yet structurally stable. A typical example from atmosphere physics is the red spot of Jupiter, a vortex which has remained structurally stable for at least several hundreds of years [14].

In the 20s and 30s, Schauberger observed the structural stability of natural untouched water courses — although naturally he didn't use such terms [1, 34]. From his observations he suggested a way of regulating rivers, based on giving impulses to the water to self-organize into a stable river bed [35, 36, 37]. The principles of this kind of river regulation differs from that of classical ways of regulating rivers, which tries to steer the water into a certain course — with the associated risks of loosing the river bed stability at increased water discharges, with bank erosion and flooding and as the result.

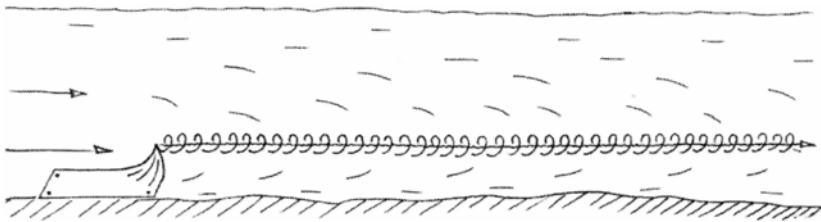

Figure 3.3: Indirectly acting guide elements, creating the right conditions, which make the water flow organize itself into a vortex along the course.

This kind of impulse generation has been studied by Kullberg [17] and Molin/Olsson [22]. By placing small guide elements in the main current a subpressure is created, which self-organizes a vortex along the river course, see Figure 3.3.

Note that we aren't trying to steer the water flow into a swirling motion. We merely create the necessary conditions, then the microscopic fluctuations will be amplified, the straight flow become unstable, and make a spontaneous transition into a swirling motion which is structurally stable.

### 3.3 Free and forced vortices

Flows that are circulating around a point can be grouped into two kinds of flow: quasi-forced and quasi-free vortices [10, 18]. An overview of some kinds of vortices is given in Table 3.1.

In a forced vortex the water mass is rotating rigidly, like in a centrifuge. With  $\omega = k$  we get  $v_\theta = kr$ , where  $v_\theta$  is the tangential velocity,  $\omega$  the angular velocity (constant) and  $r$  the radius. By definition  $r\omega(r) = v_\theta(r)$ . The inertial force (the centrifugal force in a rotating system) becomes:

$$F = \frac{mv^2}{r} = \frac{m\omega^2 r^2}{r} = m\omega^2 r$$

and thus increases with increasing radius.

$\omega =$	$v_\theta =$	Description	$F_{\text{centripetal}} -$
k	kr	Rigid rotation, forced vortex.	$mk^2r$ , increasing with increasing radius
$\frac{k}{r}$	k	An example of a quasi-free vortex.	$\frac{mk^2}{r}$ , decreasing (with increasing radius)
$\frac{k}{r^2}$	$\frac{k}{r}$	Free vortex Potential flow. Energy per unit of mass constant. Angular momentum $L = v_\theta r$ constant.	$\frac{mk^2}{r^3}$ , decreasing (with increasing radius)

Table 3.1: Properties of free and forced vortices.

A free vortex appears when water is allowed to organize itself, e.g. at an outlet of a vessel, or in a tornado. In a free vortex the angular velocity of the flow varies with the radius (and increases towards the centre). We get  $\omega = \frac{k}{r^2}$ . This is of course an idealization. A real vortex often consists of a superposition of a free and a forced vortex, where the outer part is free, whereas the vortex centre is rotating rigidly, see Figure 3.4.

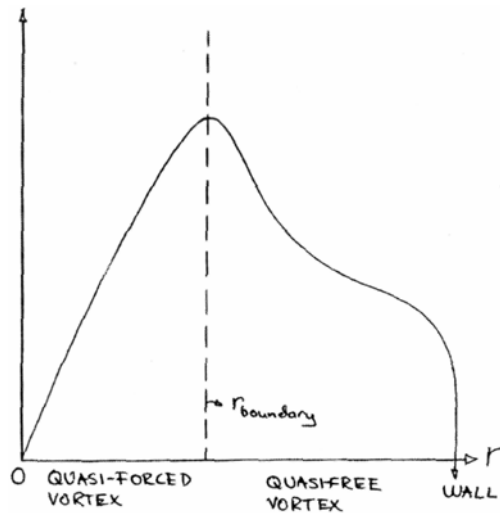

Figure 3.4: A typical vortex, compounded by a quasi-free and a quasi-forced part.

Let us define some directions of flow in cylindrical co-ordinates, and investigate closer some of the properties of the flow in the different directions, see Figure 3.5.

### 3.3.1 The axial velocity, $V_z$ , and reverse flow.

We can identify 3 kinds of flow in the axial direction, which appear in vortex-flows through a pipe [18], see Figure 3.6.

### 3.3. FREE AND FORCED VORTICES

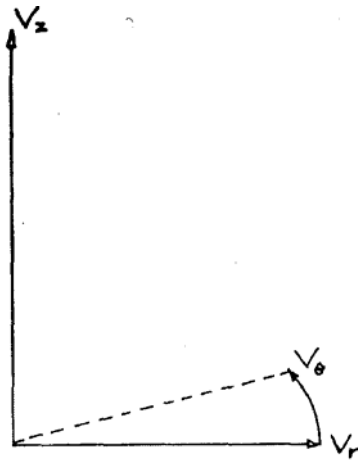

Figure 3.5: Flow directions: radially ( $V_r$ ), axially ( $V_z$ ), and tangentially ( $V_\theta$ ).

In case I all of the flow is in the main flow direction, though the axial velocity decreases, towards the centre. In case II the central flow flows backwards (reverse flow). Flow of type III, where the central and peripheral flow goes in the main flow direction whereas a region in between is flowing reversely, can appear in regions with strong vortex generation<sup>1</sup>, e.g. at an inlet [18].

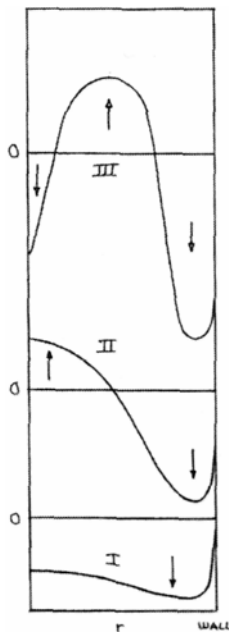

Figure 3.6: Different kinds of rotating flow, bifurcations (transitions) between different states: (I) All of the water goes in the same direction, (II) Return flow in the centre, (III) 3 directions of flow (Down/up/down).

The reverse flow that appears in case II and III can be important for mixing and separation applications, and has a stabilizing effect.

<sup>1</sup>Where the ration between Swirl and Reynolds number ( $\frac{Sw}{Re}$ ) is great.

### 3.3.2 The tangential velocity, $V_\theta$ , and its importance

The tangential velocity distribution,  $V_\theta(r)$ , naturally leads to the question of the forces acting in the radial direction. It is obvious that  $V_\theta(r)$  in some way reflects the forcing of the system. Let's have a look at the trumpet shaped vessel. We can imagine several ways of forcing or retarding the system:

- Centripetal forces from the outer form makes the water turn aside.
- Braking vanes at the rim retards the peripheral flow and thereby indirectly direct the watercourse towards the centre.
- Water is injected tangentially at the periphery and thereby strikes into the mass of water and accelerates it.
- A subpressure at the centre tows the water towards the centre.

Thus it is important to get a feeling for what is happening. Let us study these phenomena one by one.

A mass of water that rotates wants to continue straight ahead in the direction of the tangent. After some reflection one realizes that the water layer lying outside exerts a centripetal pressure which balances the inertia, whereby it keeps the mass of water in its course. Outer layers of water pushes onto each other, and at the outermost layer the vessel pushes onto the water. Consequently the vessel form has a significant influence on the appearance of the vortex, which hadn't been the case if the vessel had been larger in relation to the vortex, as is the case e.g. in a lake.

In a quasi-free vortex, the angular velocity increases towards the centre, and hence a larger force per mass of water is needed to sustain the centripetal acceleration that turns the water aside.

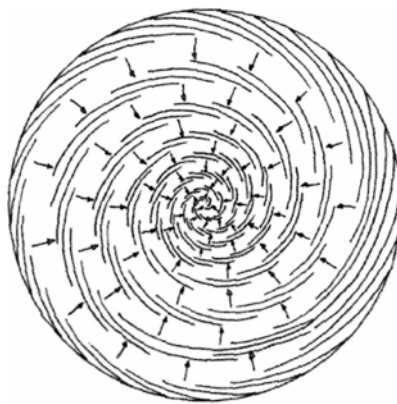

Figure 3.7: The centripetal pressure from the outer form. Outside-lying layers of water exerts a centripetal force on the inside-lying layers, and thus achieves a centripetal acceleration.

If instead there are braking elements at the rim, the peripheral vortex movement is dissolved. Water is retarded, and thereby isn't thrown outwards (in the direction of the

### 3.3. FREE AND FORCED VORTICES

tangent) to the same extent, since its momentum has been decreased — thus a smaller force from the outer form is needed in order to sustain the balance. Schauberger used this for river regulation [34], in order to stop the meandering from eroding the river banks more and more. Imagine how a transient wave towards the periphery thereby is dissolved, and partly reflected back towards the centre of the stream/river bed.

If water strikes tangentially into the water mass at its periphery, we get a tangential acceleration there. This will counteract the free vortex generation (where the acceleration is taking part at the centre). If the outflow at the centre is small, all of the water mass will tend to begin to rotate rigidly.

A central outlet stimulates the emergence of a free vortex, which need a combination of tangential and axial movement. (Of course the movement in some sense is also radial, water is moving towards the centre, but not straight, rather in a quite curved manner.) There we have the necessary subpressure which can self-organize the media.

Let us now study the effect of a subpressure in the middle. Does it pull the water (towing it as it were), or does it merely leave room for water that is pushed in from behind?

The point is that the water molecules not only push each other, they also pull each other due to the attractive van der Waals forces and hydrogen bonds between the molecules (which e.g. give rise to the viscosity and surface tension of water). If we model a medium without attractive forces as plastic or rubber beads, which are bouncing about, we can imagine water as being rubber beads with rubber bands to the closest neighbours, or simply rubber beads with small magnets inside. These then will not only leave room for beads behind as they advance, but will also tow them with themselves.<sup>2</sup>

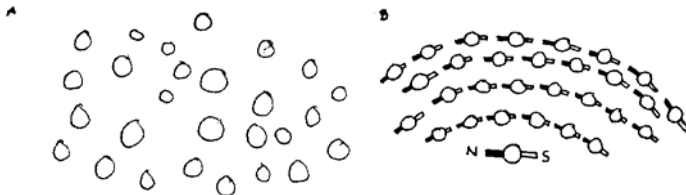

Figure 3.8: [A] Plastic beads — an ideal gas or fluidized particles. [B] Beads with small magnets inside — a fluid with attractive forces.

Outer layers thus will be pulled in by inner layers, resembling a structure like a paper or measuring tape that has been rolled up, see Figure 3.9. The outer layers also pushes inwards due to the fact that the outer form (the vessel) exerts a centripetal force. Since the circumference decreases towards the centre, the angular velocity has to increase in order to maintain the flow, and in order to conserve angular momentum in some sense — the same principle that makes a skating ballerina rotate faster, when she pulls the arms towards the body.

We can note the difference between pulling and pushing in a hydrodynamic system. It is especially clear at an air funnel, which behaves elastically. Whereas it is easy to pull a cable (or a rubber band) through a pipe, it is significantly more difficult to try to push it through.

<sup>2</sup>Also, the beads will try to align their fields with their neighbours', and thereby spin around, in a dynamical changing pattern, at the edge of order and chaos.

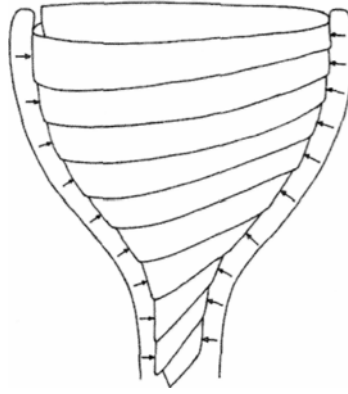

Figure 3.9: The measuring tape towing effect.

In a rotating flow, the air funnel at the centre consequently acts as a contracting force, and, just as the towing flow at the centre, plays a role for the centripetal acceleration and stability of the vortex. From this it is realized that a model of freely flowing water (water flowing with free surfaces) in some sense has to capture the attractive forces of the water molecules, and thus its surface tension.

### 3.4 Flow image modelling

In this section we are going to study ways to model the flow image, especially the toroidal vortex flow in the barrel. We will focus on describing the flow image of a system, without the need of knowing too much of the underlying mechanisms, which anyway are difficult to capture when we deal with active boundaries, as e.g. an air funnel. We will thus discuss approaches and ways to create models that capture the dynamics of the system, and hence can capture its typical behaviour, rather than focusing on the composition of (infinitesimal) fluid elements.

Thus we will not search for the most detailed model, but for the simplest possible model that has the same fundamental dynamic properties as the system. This view is very close to that of chaos science — which has shown that the essence of very different and seemingly complex behaviours often can be captured by almost ridiculously simple models [14, 23]. This is due to the fact that many dynamic properties and behaviours (e.g. at bifurcations) to a great extent are universal, and therefore appear in a wide range of very different mathematical systems. The behaviour of a simple system (intelligently chosen) therefore can tell us something about systems that wouldn't have been possible to analyse with partial differential equations, due to their complexity (caused e.g. by the hopeless boundary conditions that an air funnel generates).

#### 3.4.1 The handkerchief dynamics

Now, let us study the dynamics of the barrel with swirling water. The water surface is pulled down in a vortex at the centre, and then thrown out tangentially at the bottom, at the same time twisting together the surface.



### 3.4. FLOW IMAGE MODELLING

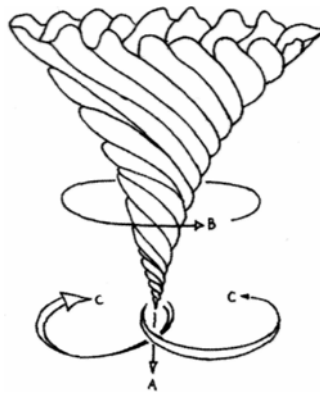

Figure 3.10: The handkerchief dynamics: To twist together and stretch.

The process can be likened to pulling a handkerchief through a hole, by seizing it at the centre, twisting it together, and pulling. The whole procedure can be summarized as: pull, twist and spread. It is obvious that a dynamics of this kind leads to mixing that in principle is close to that of the classic horseshoe of chaos science — stretch and fold. Points that originally are close to each other will be separated, and finally loose relation to each other. This of course is of importance for the mixing in the system<sup>3</sup>.

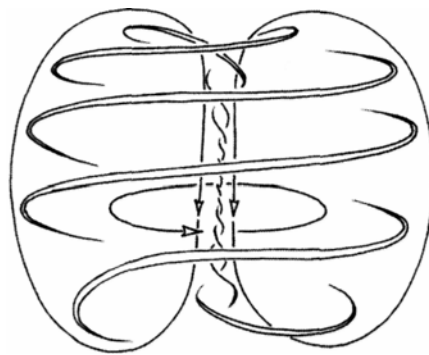

Figure 3.11: Toroidal vortex flow.

Once again regard the barrel with the swirling water. After the initiation of the process, the flow self-organizes into a structure that is stable and swirling. In the barrel a toroidal vortex flow appears. The flow is vaulting around a torus, at the same time as it is rotating faster towards the centre. This structure resembles so-called twisted scroll rings, which appear as solutions to a diverse fauna of dynamical systems [28, 44].

<sup>3</sup>If we could find a dynamical system that in its phase space exhibited a similar dynamics, and had a similar global flow, we could get some insight into the mixing of the hydrodynamical system by studying the mixing in the dynamical system [8, 27].

### 3.4.2 Chaotic pulsation in the vortex

The air funnel which has arisen at the centre can be likened to a twisted membrane, which tries to contract, but is stretched downwards by the subpressure, and of course also is affected by the complicated swirling flow. It can thus be regarded as a kind of non-linear spring, see Figure 3.12.

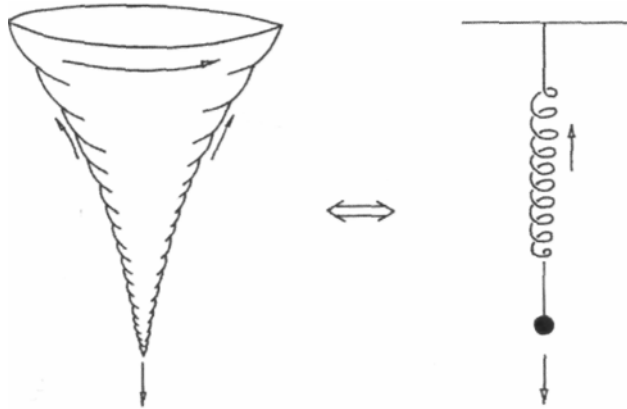

Figure 3.12: The non-linear membrane spring

At some flows the air funnel behave chaotically and start to pulsate aperiodically. The situation much resembles that of a dripping faucet [40], but with the difference that it is air and not water that drops! It would be interesting to investigate the presence of strange attractors in the system [23, 42].

### 3.4.3 Bifurcations

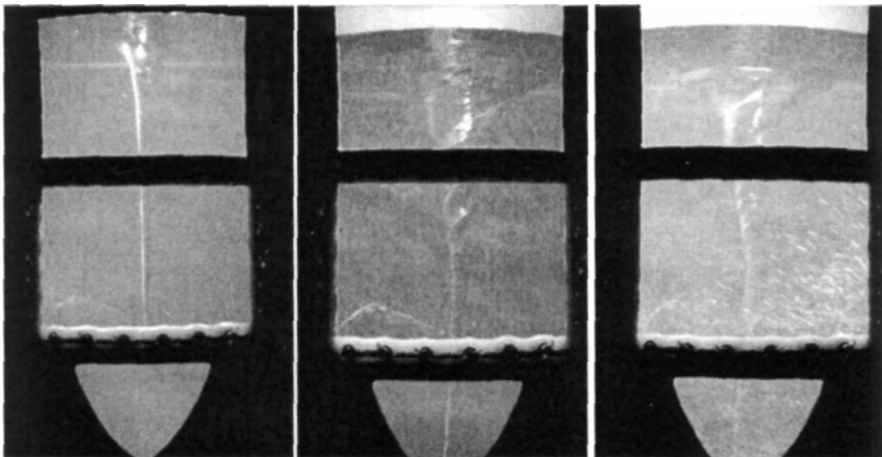

Figure 3.13: Bifurcations in the air funnel: [A] Hyperbolic air funnel [B] Superimposed twist after a bifurcation [C] More complicated funnel after successive bifurcations.

Another aspect of the vortex is the shape of the air funnel at the centre (or the pressure minimum, if no air can be sucked down). As the pump is started and the flow begins to rotate, the water surface dips slightly and smoothly at the centre. Then, at a critical

### 3.4. FLOW IMAGE MODELLING

flow, a spear-shaped air funnel suddenly appears at the centre, which quickly widens into a trumpet-shaped form. The air funnel generation can thus be seen as a sudden collapse of one equilibrium state, into another, qualitatively different, equilibrium state.

The air column that appears forms a minimum surface. Surface tension tries to contract the surface, while the rotating flow tries to pull it apart. The force balance can be likened to that in soap bubbles [29], with the difference that the inner over-pressure in the soap bubble has been exchanged by inertial forces in the water, which pulls from outside.

From the simple hyperbolic rotation form, the funnel at certain critical flows undergoes further bifurcations to more complicated surfaces — one can imagine that a Hopf-bifurcation adds another frequency to the system<sup>4</sup>. At such a bifurcation the flow axis/funnel can begin to twist around its own axis and also form a spiralling (helical) space curve through the surrounding medium.

You could think that the twisted shape only is due to the fact that we have a boundary surface between air and water. What does the flow at the centre look like, if air isn't sucked down into it? The flow, its turns out, still generate spiralling and complex layers of water. Evidently a high degree of macroscopic organization of the flow exist in this case too.

<sup>4</sup>There are several routes from a stable dynamics to a chaotic flow [13, 16, 42]. It would be interesting to investigate closer how the bifurcations in the vortex actually occurs.

# Chapter 4

## Oxygenation and ion precipitation

We will now study how the spontaneous generation of an organized vortex can be used for mixing-in and stirring applications. The active surface between water and air lends thought to applications like oxygenation of water and stimulation of chemical reactions.

### 4.1 The principle of the Plane pump

Schauberg made experiments with different kinds of stirring devices and vortex turbines. He developed an arrangement for pulling down oxygen to the bottom of lakes, see Figure 4.1. It was later patented in 1968 by his son Walter [39]. The disadvantage with this kind of direct stirring is the difficulty to sustain a vortex when the system is scaled up. In many cases a rotating water body is developed only in the vicinity of the rotor.

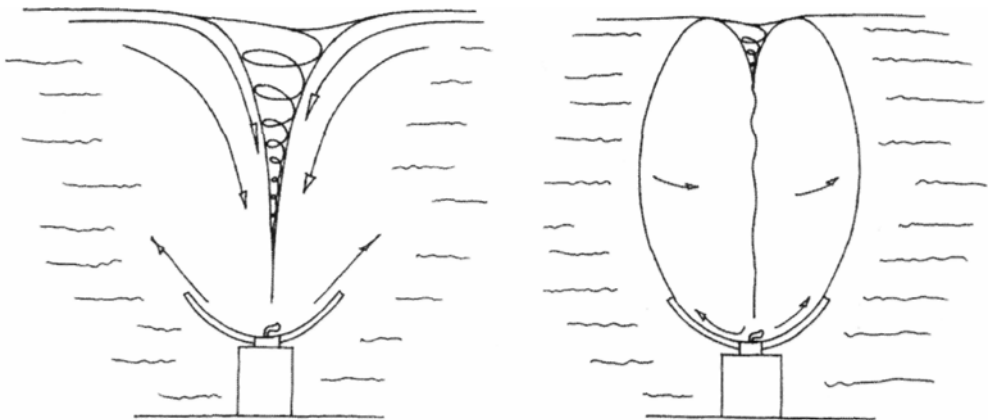

Figure 4.1: [A] Schauberg's oxygenator [B] Since the induced motion mainly is a rotating one, a water body is created, with little contact with the surrounding water.

What we actually would like to create is a flow from the surface down towards the bottom, i.e. a toroidal vortex flow. By the creation of a subpressure at the centre, the water may self-organize. By designing a suction pump in a suitable manner, this can be achieved without the problems that appear when water is only stirred in the middle. Aquagyro has used this principle in a stirring device [20] which sucks water down towards the bottom and then ejects it towards the periphery.

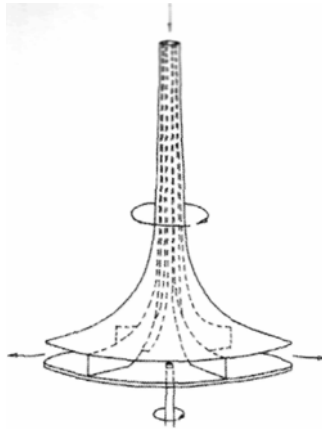

Figure 4.2: The principle of the Aquagyro.

It is thus in practice a question of creating a pump that uses the handkerchief dynamics, and then let the water organize itself. Then we get both an effective oxygenation and an effective mixing, with comparatively little expenditure of energy. This naturally leads the mind to the question of how this can be achieved in a simple and practical way. The plane pump, a centrifugal pump that uses the subpressure in the middle, turns out to be a simple construction capturing the dynamics.

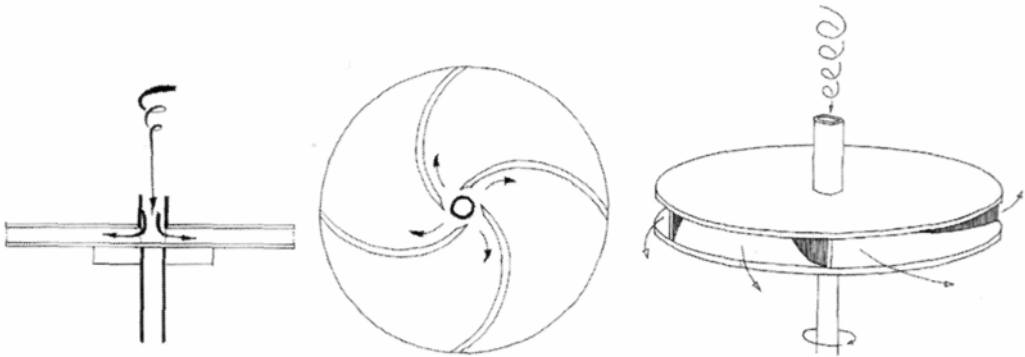

Figure 4.3: The principle of the plane pump. Water is sucked into the pipe in the middle and is thrown out radially towards the periphery.

Two circular plates, joined by radial guiding rims, are brought to rotate. Through a pipe in the middle of the upper plate, water is being sucked in and is then ejected towards the periphery due to the centrifugal force. Since the pipe can be made narrow, a substantial subpressure can be created. The swirling effect in the water is enhanced by the rotation of the plates. The surrounding medium quickly organizes itself to a toroidal vortex flow.

#### 4.1.1 Experimental set-up

An experiment with a plane pump at the bottom of a great barrel was set up, see Figure 4.4. The barrel, with a diameter of 50 cm, was filled with water to a height of 80 cm. At the bottom of the barrel the plane pump can be seen, driven by an axis through the bottom. Through the pipe, which makes up the axis, the pressure can be measured. (In separation applications, fluid can be extracted out of the central flow via the axis pipe.)

#### 4.1. THE PRINCIPLE OF THE PLANE PUMP

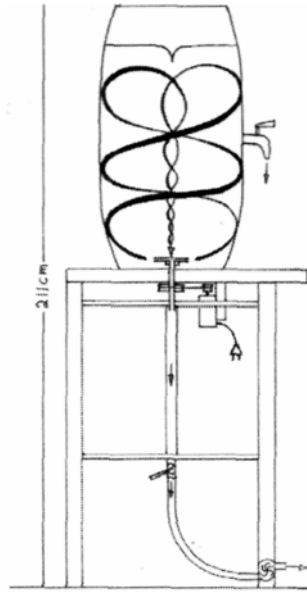

Figure 4.4: A drawing of the experimental set-up.

##### 4.1.2 Subpressures and equilibria

First the flow behaviour was studied at varying forcing. Already at a low effect, 30-40 W, the water organized itself into a toroidal vortex flow. Different kinds of guide vanes in the pump were tested<sup>1</sup>. Straight vanes turned out to be more efficient than vanes directed backwards. Vanes directed forwards<sup>2</sup> turned out to be the most effective for vortex generation.

First a beautifully trumpet formed hyperbolic surface was created. At a critical angular velocity (rotation speed) the funnel began to twist, and formed a complicated minimal surface in a rotating (curved) geometry. At higher rotation speeds the pump started to squeeze off air bubbles, with a strong injection of air as a result, see Figure 3.13.

Let us estimate the kinetic energy of the rotating flow. By analysing the expression for inertial moment, and noting that the rotation in a vortex normally doesn't occur rigidly (i.e.  $\omega$  isn't constant inside the water body) we arrive with the expression:

$$W_k = \frac{1}{2} \int \omega^2 r^2 dm = kmR^2 \omega_R^2$$

Here  $W_k$  is the kinetic energy,  $dm$  an element of mass,  $\omega$  the angular velocity and  $r$  the radius.  $R$  is the outer radius (in some sense) of the vortex, and  $\omega_R$  the angular velocity of the vortex at this radius. After integration we arrive with an expression similar to the one at the right hand side, with the constant  $k$  which depending on the type of flow.

At rigid rotation of a cylinder we have  $k = \frac{1}{4}$ . For a quasi-free vortex (which we coarsely approximate to be cylindrical, with  $\omega(r) = \frac{R\omega_R}{r}$ ), we get  $k = \frac{1}{2}$ . For an ideal free vortex,

<sup>1</sup>Note that the fact that a certain vane curvature makes the pump efficient to pump water not necessarily makes it efficient to create a swirling flow in the vessel, as the way the water leaves the pump is also relevant for this, not just the pumping efficiency.

<sup>2</sup>At the periphery.

$\omega(r) = \frac{R^2 \omega_R}{r^2}$  the integral diverges at the centre. If we note that there is an air column at the centre, and estimate its radius to approximately  $R/10$ , we get  $k = \ln(10) \approx 2.3$ . With  $R = 0.25$  m,  $\omega_R \approx \pi$  rad/s (half a revolution per second) and the amount of water to 100 litres, this corresponds to energies of approximately 15, 30, and 140 Ws, for rigid, quasi-free, and free vortices respectively.

The supplied mechanical effect (from the pump) is probably significantly less than the 70 Watts which are fed to the pump as electrical effect at full speed. The efficiency, through driving band, bearings and friction in the pump, probably is in the range 20-40%, which gives a net effect in the range of 15-30 W. If we take into account that it could take 10-20 seconds for the vortex to develop, we find that supplied energy in order to accelerate the vortex is of the same magnitude as for a free vortex. Of course the calculation is just a very coarse estimate.

Losses due to the inner friction of water should correspond to the net effect the pump supplies when the vortex has had time to develop fully. These reasonably should be quite small, since the rotation speed of the pump could be reduced significantly (from 10-15 revolutions per second to 3-4) with maintained vortex formation.

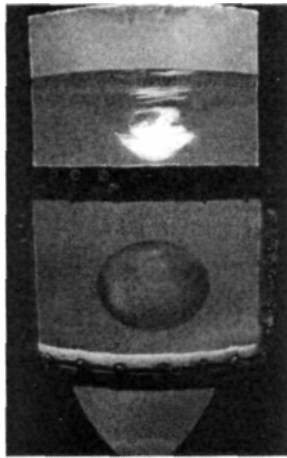

Figure 4.5: The experimental set-up with the barrel, as seen from the side.

The subpressure thus formed was measured with a manometer, a tall column of fluid, connected to the centre of the plane pump (from below). The measurement isn't entirely trivial. We noted that a pressure reduction corresponding to the height of the water level in the barrel wasn't required to pull the funnel all the way down to the inlet pipe of the pump. This could be of importance if the technology is used e.g. at oxygenation of lakes or ponds. Under normal conditions, a subpressure in the pump corresponding to 60-70% of the height of the water level in the barrel was enough to pull down air to the bottom. Hence the rotating water body assists in lowering the pressure at the centre — the pump gets help from the flow when the latter has had time to organize.

The inlet pipe had some importance for the stabilization of the vortex. Without this pipe the upper of the rotating plates tended to interfere with the lower part of the vortex.

If a ball was placed at the centre of the vortex, the sucking in of air was effectively prevented. A strong subpressure could then be created. The subpressure would fall below the measurement range, -200 mBar. Injection of a solution of potassium permanganate showed that the flow still was toroidal, and formed a complicated geometry at the centre, with superimposed spiralling flows. At high rotational velocities pulsation could be

## 4.2. OXYGENATION OF WATER

observed through the pump<sup>3</sup>.

Braking vanes placed at the wall could to some extent direct the upper flow towards the centre. It was, however, important not to make the vanes too large.

### 4.2 Oxygenation of water

Now, how could the above be used for oxygenation? We can discern three distinct cases:

- An air funnel is pulled down, and is twisted off in the pump, leading to a stream of air bubbles being ejected along its periphery as the result. This causes a forceful but efficient oxygenation, suitable for industrial applications.
- A stable air funnel is pulled down towards the pump, acting as an active surface, which facilitates mixing in of air in the water. The surface of the water is, as it were, moved closer towards the bottom, at the same time as the mixing in increases due to the increased circulation. The water is oxygenated in a more peaceful way (which doesn't disturb life at a lake bottom to the same extent).
- Oxygen rich water is pulled down without the development of an air funnel — e.g. with the aid of an inlet-suction vessel.

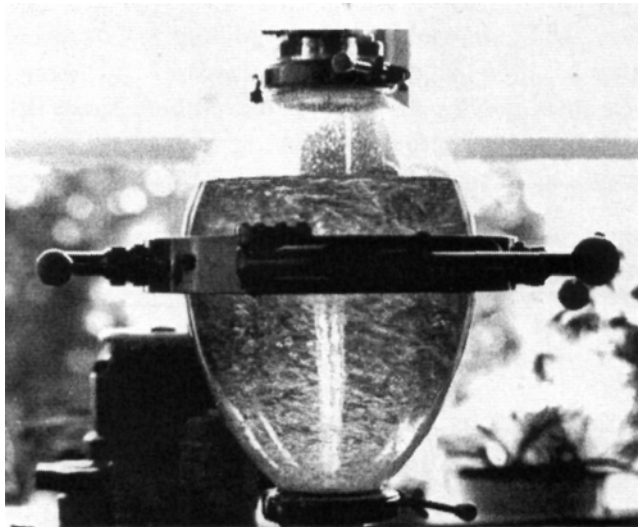

Figure 4.6: The Repulsator.

Oxygenation at a small scale was investigated in 1988 by Nordell and Nordmark [26]. A small Aquagyro stirring device was placed in an egg-shaped vessel (a repulsator) filled with water, after which it was started. A stable vortex funnel, which assisted oxygenation, developed. After one hour the water had reached a good level of oxygen saturation.

<sup>3</sup>One may ask what the flow image would look like in the pump if only one of the plates would rotate, or with a geometry like that of Schauberger's rill plates [1]. This would lead to a discussion of Taylor-Couette-like flow between the plates, with the possibility of mode locking of water rolls towards the rill plates in the latter case, but that would fall outside the objective of this report.



Description	Before	After	Note
Temperature[°C]	22.5	23.2	
Concentration of O <sub>2</sub> [mg/l]	2.39	8.51	Full oxygen saturation

Table 4.1: Oxygenation in an egg-shaped vessel, "Repulsator", by Nordell and Nordmark.

At another experiment, made by Aquagyro at Paltrask water supply in 1990, an increase from 0.4 to 10.5 mg/l was observed [6]. It was also noted that the smell of hydrogen sulphide (H<sub>2</sub>S) had been eliminated.

In order to investigate oxygenation at a larger scale, we performed an experiment with the barrel — diameter 50 cm, height 80 cm. At the bottom a plane pump was placed, powered by a 70W sewing machine motor with rotation speed regulation. The oxygen concentration was measured with a Macherey-Nagel titration rest, Visicolor Oxygen SA10 (0.2-10 mg/l).

A few seconds after the start of the pump a slurping sound was heard and a spear-shaped vortex funnel was created, which soon widened into a trumped-like shape. The water was quickly filled with small air bubbles. Even with energy input as low as 40 W, a good oxygenation could be achieved. With a correctly shaped plane pump water was oxygenated in 15-30 min, see Figure 4.7. Both cold water and water with room temperature was oxygenated well, in both cases to about 90% of full oxygen saturation at the actual temperature.

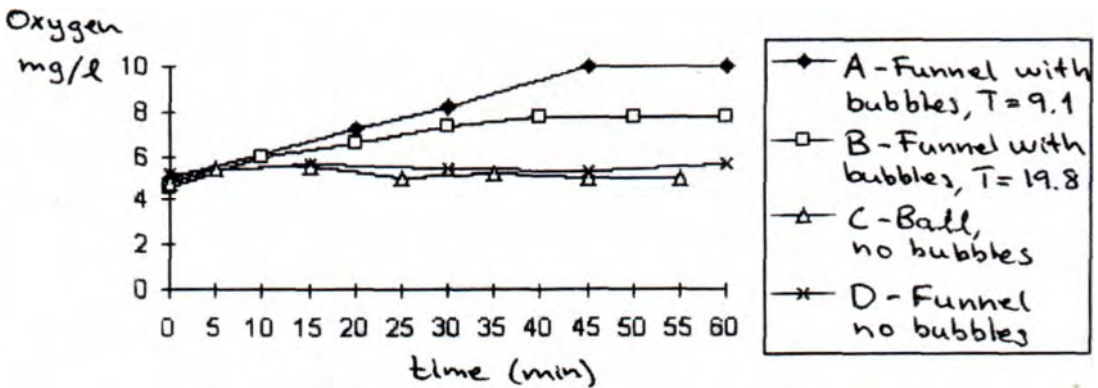

Figure 4.7: Oxygen concentration as a function of time. [A] and [B] with the generation of air bubbles, [C] with a ball, which prevented the pulling down of air, [D] with a stable air funnel, but without any air bubbles.

If no air funnel was developed (e.g. by placing a ball at the centre), no oxygenation took place. This was also the case if a trumpet-shaped funnel was developed, but without any twisting off of air bubbles taking place. It thus seems as if it is only the small air bubbles that play an important part for the oxygenation to take place.

### 4.3 Ion-precipitation

At an experiment at Paltrask water supply in 1990, Aquagyro discovered that their agitator seemed to facilitate precipitation of iron and manganese ions [7]. An hyperbolic vessel of the height of about 1m, with an Aquagyro stirring device inside, had been placed in a tank with the volume of 3m<sup>3</sup>. During the treatment precipitated iron could be observed in the tank. At the following filtration of the water in a gravel filter, manganese ions precipitated to a large extent, which the traditional treatment (with compressed air) didn't achieve. The iron concentration of the treated water at analysis was found to be the same as that of untreated water, but iron in the sample didn't precipitate when subjected to pressure airing, which was considered remarkable. The humus concentration of the water was high, and it was speculated that iron could have become organically bound. Another explanation advanced, was that iron had formed some kind of complex, and therefore didn't precipitate by the pressure airing.

State	Mn	Fe	Note
Before treatment	0.26	0.23	
During treatment	0.29	0.24	Water temperature 7 ° .
After gravel filtration	<0.05	0.21	Iron does not precipitate when subjected to pressure airing in the lab.

Table 4.2: Precipitation of manganese and iron ions, Paltrask water supply.

At an earlier experiment at Nordmaling in 1987, a decrease of Mn and NO<sub>2</sub> ions had been observed. An experiment at Vistbacken water supply, with its extremely high concentration of iron in the water, had shown an efficient precipitation of iron by the process (more efficient than the traditional pressure airing, as opposed to the results from the experiments at Paltrask) and also a decrease of the manganese concentration [7].

It would be interesting to replicate these experiments more systematically, with e.g. a plane pump in the barrel, and with water with different ion concentrations.

# Chapter 5

## Separation

In this chapter we will study how a swirling flow may be used in order to remove particles and separate fluids of different densities. We'll start by studying existing hydrocyclone technology and its function, and then go on to see how the self-organizing flow that we have previously discussed may be used for separation applications.

### 5.1 Hydrocyclone technology

A hydrocyclone is basically made of a conical pipe, see Figure 5.1. Water is injected tangentially at high pressure (1-3 Bar) in the upper part, which creates a strongly rotating fluid column. The outer layers of the fluid will form a (quasi-) free vortex, whereas the more central parts will rotate rigidly. At the very centre an air column is often created. Due to the variation of the flow with respect to the radius, light and long particles will move towards the centre more than the heavier and rounder ones. By letting water at a certain radius being separated at the lower part of the hydrocyclone, the "reject" flow, and by letting the central flow leave at the upper part, the "accept" flow, a separation of particles (especially heavy ones) is obtained.

Hydrocyclone technology has proven useful for pulp industry (separation of sand and sticks) [15, 12], for separation at mining industry [41], and for treatment of runoff water at car washes [33]. Usually the separation is done by several steps.

Small hydrocyclones tend to have a better separation performance than larger ones. Small threads, however, tend to create problems by clogging the reject opening, e.g. in textile industry applications. Power consumption tend to be some kilowatts for a hydrocyclone on the length 1 m.

#### 5.1.1 Estimating separation properties

In the hydrocyclone, the separation performance depend on which particles move towards the centre, or central flow. How could separation properties be estimated numerically? One way is to simulate different particle trajectories and make statistical estimates. In practice, however, this may be very difficult to carry out.

When it comes to real applications, what is of interest is to estimate size and other properties of particles which take the accept or reject path. Often a boundary layer

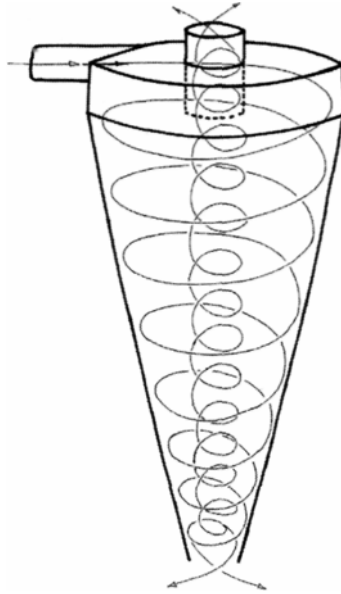

Figure 5.1: The principle of a hydrocyclone.

exists in the flow, where particles of the right size stand still in the flow — in the sense that they neither move towards the accept or reject exits. This becomes more obvious by considering a rotating flow — it is possible to imagine a particle keeping a constant radius, neither moving towards the periphery nor the centre. Many simulation approaches therefore focus on determining equilibrium sizes of the particles, i.e. particles that will get stuck in a boundary layer [9].

To focus on a particle tends to miss the global flow, but is of course a good way of obtaining separation characteristics when the flow image is rather simple, as in the hydrocyclone. At the applications with self-organizing flow that we have discussed, the flow has more freedom, and is therefore more difficult to estimate numerically. We will therefore choose a more empirical approach.

## 5.2 The principle of self-organizing separation

Now let us for a moment reflect upon the flow image in the Stuttgart experiment. Could it be developed into a separation technology that qualitatively differs from hydrocyclone technology? At the Stuttgart experiment suspended materials accumulated at the centre. Two questions naturally arise:

- Where in the pipe does the concentration of materials towards the centre occur, and what factors affect the tendency to accumulate them?
- How could the central string of particles be separated without disturbing the flow?

It can be shown that the free vortex region is important for the centring effect on particles [9]. In such a region an effect similar to that which occurs when a particle lags the water flow takes place — a pressure gradient pushes the particle towards the centre. Even

## 5.2. THE PRINCIPLE OF SELF-ORGANIZING SEPARATION

heavy particles can be pushed towards the centre, at least transiently, until they have achieved enough tangential velocity to be thrown outwards again.

Consequently we need an acceleration of the rotation speed towards the centre, together with a discharge of the flow (e.g. in the axial direction) in order to get an effective separation. If the inlet vessel is made too large, the whole water mass will tend to rotate almost rigidly in the peripheral region. This leads to a reduced centralization of particles, and thus a less effective separation.

There are several ways of solving this issue:

- The inlet vessel is made narrower, which better directs the formation of the vortex.
- The injection is adjusted, so that it improves the conditions for the emergence of a free vortex region.
- Braking vanes are introduced, which dissolve the stiff rotation at the periphery, and thus force water to organize towards the centre. In practice this adjusts the injection and makes the vessel look smaller to the flow.
- The form and proportions of the vessel are adapted to stimulate the right kind of vortex generation along a longer part of the vessel.

Separation based on the first two principles has been investigated by Rapp [32]:

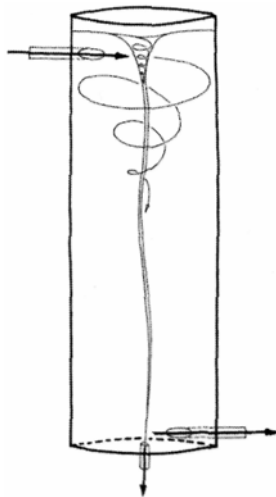

Figure 5.2: The principle of the centripete. In the narrow vessel a pronounced spiralling vortex emerges, which supports the separation of particles well.

In a cylindrical vessel called centripete, of 40 cm height and 9 cm diameter, see Figure 5.2, water enters tangentially at the top, through 3 inlets making an angle of about  $30^\circ$  with the radius. Dirty water is sucked out through a central outlet at the bottom, while treated water leaves the vessel by a tangential outlet at the periphery at the lower part. The inflow is 6.6 l/min. The outflow is 3.3 l/min both in the central and peripheral outlets. Particles (a suspension of coarsely ground coffee) is injected into the inlet hose about 1 m before the inlet to the centripete.

Rapp found that 93-96% of the particles could be collected through the central outlet. It was furthermore observed that heavy particles (used coffee particles, that had been boiled with water) in principle wasn't separated at all — they even tended to go in the peripheral outlet (42-50% of those particles went in the central outlet). It thus seems essential that the density of the particles is about that of water.

If a radial outlet was used, somewhat less (91%) of the particle phase was separated. This could be due to the fact that a radial outlet disturbs the vortex, see below. A tangential vortex more easily supports the swirling motion at the lower part of the vessel.

### 5.3 Separation with an egg-shaped inlet vessel

In order to investigate self-organizing separation we performed the following experiment:

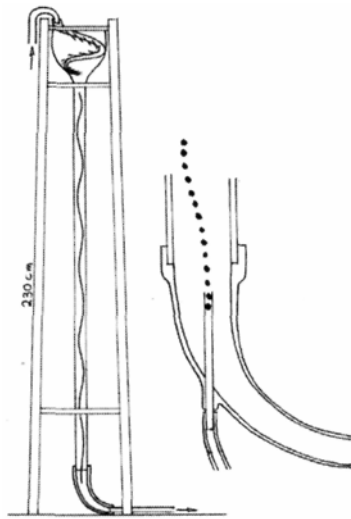

Figure 5.3: Stuttgart experiment set-up with an egg-shaped inlet vessel.

The inlet of the Stuttgart experiment set-up was replaced by a more narrow and egg-shaped one, with the water injection arranged in such a way as to support vortex generation, see Figure 5.3. Suspended material, which was injected, tended to be accumulated at the centre of the tube. In the upper part of the tube a rotating flow with  $V_z$  directed upwards was observed, i.e. a flow of type II. This meant that materials which were caught at the centre weren't flushed downwards with the flow, but stayed in the upper part of the tube — a toroidal vortex flow, stretched in the vertical direction. About 1.5 m below the inlet vessel the flow changed from type II to type I, i.e. the rotation had decreased in relation to the axial motion, to such an extent that  $V_z$  was directed downwards across the whole section of the tube in that region.

The quasi-free vortex flow means that surfaces swirl around each other, faster and faster towards the centre. Since also the axial velocity  $V_z$  varies with the radius, the particles in the vessel follow complicated screw-shaped trajectories, see Figure 5.4.

In order to separate the particles which accumulate at the centre (as a central string), a narrow pipe,  $\varnothing_i = 4$  mm, was introduced, and connected to a vessel with a subpressure. A tap opened and closed the connection to the subpressure vessel.

### 5.3. SEPARATION WITH AN EGG-SHAPED INLET VESSEL

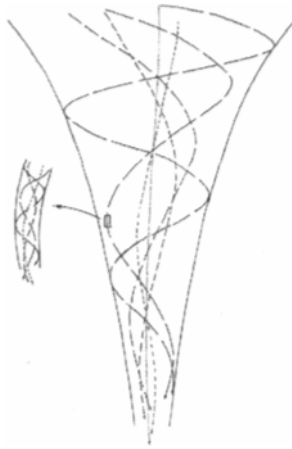

Figure 5.4: Flows within flows. Here surfaces of water swirl around each other. The particles describe a screw-shaped dance.

A sharply bent outlet for the peripheral flow turned out to disturb the flow too much. By arranging a smoother transition, a more stable vortex flow was achieved also in the lower part of the tube. The flow through the thick peripheral tube was about 0.6 l/s. (When the tap was opened a small fraction of this would go through the central outlet instead.)

A suspension of water and coarse-ground coffee was poured into the overflow vessel, which surrounded the egg-shaped inlet vessel, and mixed quickly with the inflowing water. As it was flowing down into the tube, the material would concentrate along the vortex centre.

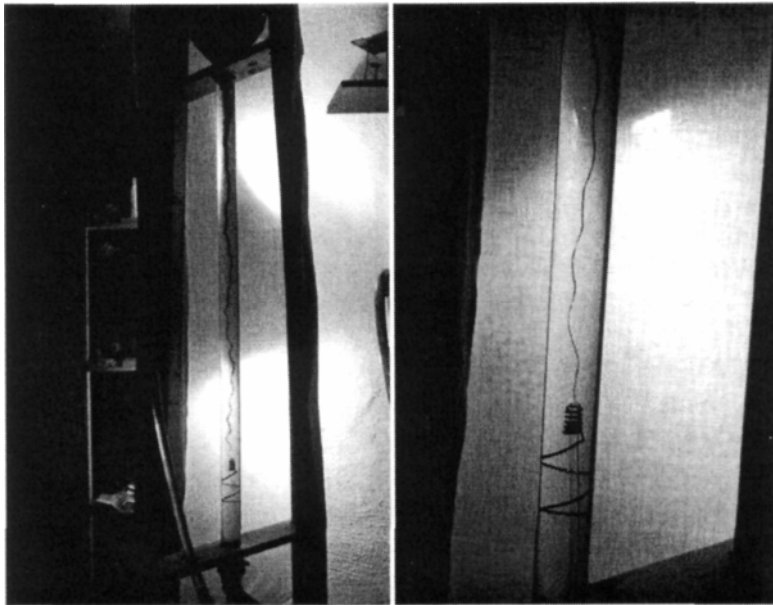

Figure 5.5: The undulating and spiralling central flow has locked together with the central outlet — coffee particles which have accumulated at the centre are removed from the rest of the flow.

When the subpressure was connected to the narrow pipe, the central string of coffee locked onto the central outlet, and hence it could be separated effectively, see Figure 5.5. When coarse-ground coffee ("boiling coffee") was used,  $\varnothing \approx 0.5-1.5$  mm, most of it somewhat

lighter than water, more than 90% of the coffee phase was separated together with an amount of water which was a fraction (a few per cent) of the flow through the large tube. Fine-ground coffee ("percolation coffee"), which is made of smaller,  $\phi \approx 0.2-0.5$  mm, and heavier particles (60-70% of the phase heavier than water), were separated significantly less well.

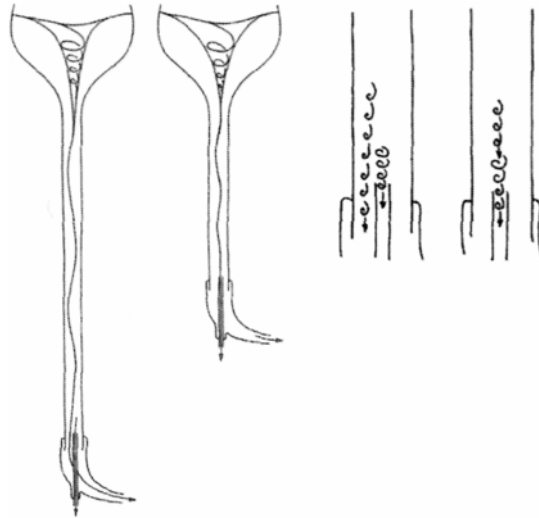

Figure 5.6: The upper and lower pressure minima are locked together.

Two things turned out to be important in order to achieve a successful separation:

- To make the tapering of the tube for the peripheral flow smooth, to avoid disturbing the rotating flow.
- That the pressure minimum generated by the inlet vortex is relatively well defined at the outlet, making possible for the pressure minimum at the central separation outlet to lock together with it.

The latter in particular means that the tube mustn't be too long. The ratio between tangential and axial flow (swirl) is also important. At times when the upper pressure minimum was ill defined at the lower part, a temporary lock-on could be observed. The lower part of the vortex funnel — which is more like a thread — then behaved like a rubber string that is stretched (but along a curved line!) and then suddenly released. This rubber band dynamics is due to the fact that the vortex centre (the pressure minimum) behaves as an elastic and twisted membrane — a non-linear membrane spring.

### 5.3.1 Separation of pieces of thread

Experiments with separation of pieces of thread were successful. Pieces of sewing thread, 7-14 cm long, mixed up with water was very effectively separated — more or less all of the pieces made it to the central outlet. Even tangled pieces were separated well. Long particles (e.g. rootlets or small twigs) should not be present, since the pieces of thread would wind themselves around them, and clog the outlet. Pure thread suspensions however, showed no signs of choking up.



## 5.4 Self-organizing separation in a barrel

The separation method of the preceding experiment required a flow through a pipe, or a lot of pumping. Could it be possible to use the separation principle for a smarter separation in large vessels, or for quickening of sedimentation in basins? In order to investigate the separation possibilities in a large and wide vessel, e.g. a basin, some experiments were performed in the barrel, with a somewhat modified plane pump. A narrow pipe (a central outlet) was mounted at the centre, and the larger pipe there was shortened or removed.

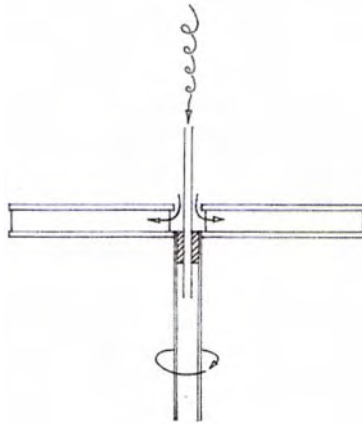

Figure 5.7: The modified plane pump. A narrow tube for the extraction of central axis flow was mounted at the centre of the axis.

### 5.4.1 Separation of suspended materials

The barrel was filled with water mixed with coarse-ground coffee. When the plane pump started, water organized into a toroidal vortex flow in the barrel. Water and particles that weren't caught at the centre, were thrown out at the periphery, where they recirculated towards the surface, there being pulled towards the centre again. Particles significantly heavier than water weren't caught by the central flow, but tended to accumulate at the bottom of the vessel, below the rotating plane pump — just as tea leaves are accumulated at the centre of a tea cup — especially if the pump was run intermittently.

The toroidal vortex flow gathered the lighter particles in a funnel-like structure at the centre. By applying a subpressure at the central outlet during short periods, the concentrate at the central string could be separated. By making the pulses brief, dilution of the separated fraction was avoided. Fine-ground coffee ("percolation coffee") was separated significantly less well — as in the egg-tube experiments. Most of it didn't accumulate in the central vortex, but sank slowly towards the bottom of the barrel, where it sedimentated close to the axis.

### 5.4.2 Removal of oil from water surfaces

The ability to suck up a concentrated central string of flow raised the question as to whether it would be possible to separate oil floating on the surface of water. This

would lead to applications such as oil sanification, something that had been advanced by Aquagyro [20].

In order to investigate this more closely, 200 ml of oil (rapeseed oil) was poured out onto the water surface in the barrel, after which the plane pump carefully was started. About 30% of the oil accumulated at the centre, and formed a quite aesthetic yellow funnel, which could be separated. If the flow was made more violent, the fluid became opaque due to suspension of oil in the water. This happened if the flow was made forceful enough to throw out air bubbles. Only oil floating on the surface could be separated. Hence a very careful flow is needed in order to collect oil, which can be extracted by a small pump that sucks up the oil funnel from above.

# Chapter 6

## Applications

We will now try to outline some applications of self organizing flow technology. We will also discuss possibilities of scaling up the technology in different ways.

### 6.1 Treatment of drinking water

The experiments with oxygenation shows that the technology can be used for oxygenation of water and consequently for "airing" of bad smell, e.g. from hydrogen sulphide. Ions of iron and manganese are likely to precipitate effectively. This means that the technology has potential applications at drinking water treatment, and implies possibilities to reduce dependence on chemicals at metal ion separation. Oxygenation of aquaria is another application — this brings the additional advantage of effective water circulation to the aquarium.

### 6.2 Treatment of industrial process water

Due to the demand for increasing environmental concerns in industry, the need of closed process systems has increased. Closed systems leads to the problem of getting rid of anaerobic bacteria from the system. Here the effective airing previously discussed could have important applications. With an effective circulation and mixing in of oxygen, aerobic bacteria (responsible for breakdown of organic tensides) are favoured. This leads to a state of the water system more resembling that in a natural stream than that of a stagnant non-circulating pond.

Another application is at flotation, effective mixing in of air bubbles in a fluid, which normally is quite energy consuming, since the air bubbles has to overcome the pressure of the standing water column during the process. With the plane pump this is solved since air is sucked into the pump where it is dispersed. Since the water is flowing toroidally, air bubbles will not rise upwards immediately, but instead drift in the radial direction — thereby being spread effectively.

When it comes to separation, the technology have applications especially for the removal of fibres in textile industry.

### 6.3 Treatment of sewage water

An interesting application is treatment of sewage water. Here the interesting areas are separation of sediments, and effective dispersion of oxygen to aid the decay processes.

An example would be the following: A plane pump ejects air bubbles and brings the water to rotate. Since the air is finely dispersed inside the pump, and then is effectively distributed when the mixture is ejected in the radial direction, the mixing in of air (and thus oxygen) is both effective and economic. Instead of pressing air into the water at the bottom, we pull the surface of the water down to the bottom, as it were.

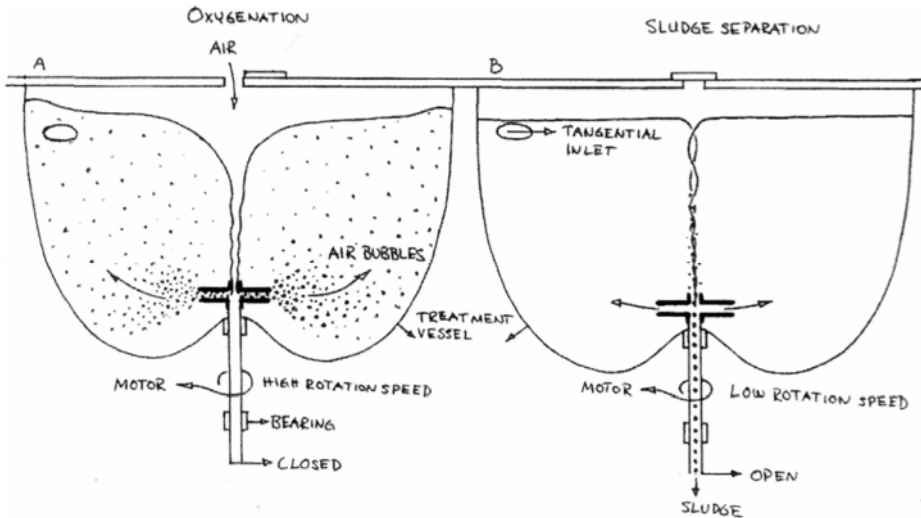

Figure 6.1: Oxygenation and separation at treatment of sewage.

It is also possible to combine parts of the sedimentation process with the above. While heavy fractions of the sediment sink to the bottom, and are concentrated below the pump, as leaves are gathered at the centre of a tea cup, lighter fractions, with a density closer to that of water, could at least partially be separated by a central outflow in the pump. In that case the plane pump should rotate more slowly.

The separated concentrate could be treated as sewage sludge, while the combined rotation and injection of air by the plane pump would assist sedimentation and decay of remaining pollutants in the basin.

### 6.4 Restoration of ponds and water courses

Let us conclude the discussion by studying how a self-organizing perspective could be used in nature, e.g. for oxygenation or regulation of natural water courses.

#### 6.4.1 Oxygenation of ponds and minor lakes

If the oxygenation technology is scaled up, it should be possible to use it for the airing of fish ponds and minor lakes with oxygen deficit or insufficient natural circulation, see Figure 6.2. At these applications it is suitable to use a stable vortex funnel, or to only

#### 6.4. RESTORATION OF PONDS AND WATER COURSES

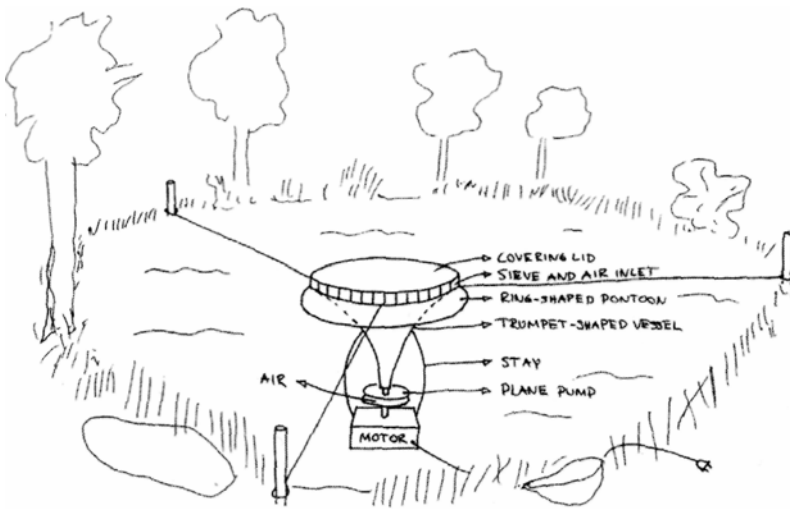

Figure 6.2: Restoration of water courses with the aid of the principles.

carefully pull down oxygen rich surface water towards the bottom, in order to avoid that bottom sediments are stirred up.

In 1988, Aquagyro demonstrated a scaled up version in a swimming basin [4]. To protect the vortex against outside perturbations, such as underwater currents, Aquagyro [5, 21] developed a hyperbolic "reaction vessel" to be placed above the inlet to the suction pump, see Figure 6.3. The form of the vessel is probably not critical, and in calm waters, e.g. a canal, perhaps not even necessary. In shallow waters one might imagine the use of specially designed inlet nozzles, which direct the surface water to the inlet.

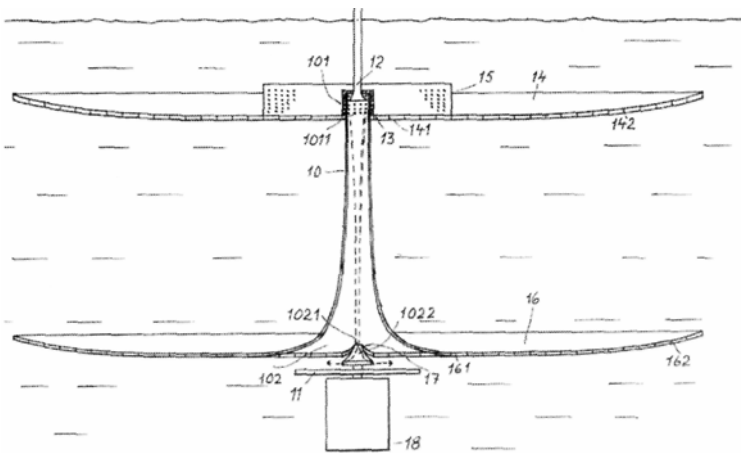

Figure 6.3: Aquagyro's principle of oxygenation at a large scale.

Walter Schaubberger refers to an experiment in the lake Pfaffikersee by Zurich [38]. The lake was in very bad condition. Previously an experiment with traditional pressure airing to get oxygen down to the bottom had been tried, but it had stirred up oxygen deficient bottom sediment to the surface with rather devastating results, and had had to be abandoned. Instead two vortex oxygenators were placed in the lake. The vortex experiment worked reasonably, and indicated that the technology could be used at a rather large scale.

6.4.2 River regulation and restoration

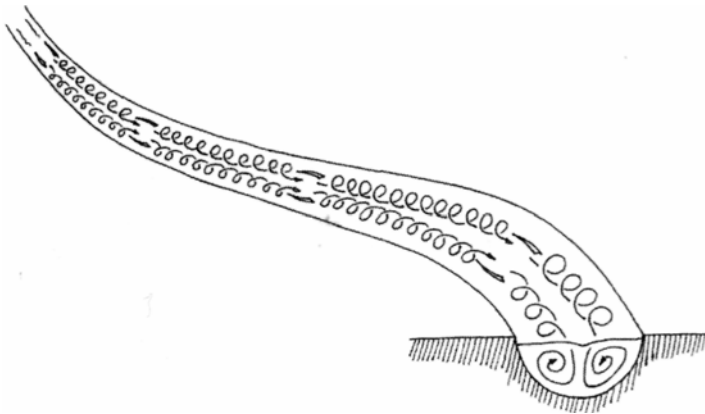

Figure 6.4: Stabilization of water courses by the use of vortex inducing bodies

The self-organizing perspective represented by Schauberger implies another perspective on the regulation of rivers. Instead of trying to lead water into certain trajectories, the focus is on letting the watercourse self-organize. Figure 6.4 shows an example of this — how an indirect generation of a self-organized vortex in the longitudinal direction can stabilize the river-bed, with decreased flooding and erosion of the shores as a result.

By immersing vortex inducing bodies in the water [36], structurally stable vortices in the axial direction of the flow is created, which behave elastically (like the pressure minimum in the egg-tube) and which stabilize the watercourse.

This kind of river regulation and shore maintenance has been studied by Kullberg [17] and Molin/Olsson [22] with promising results.

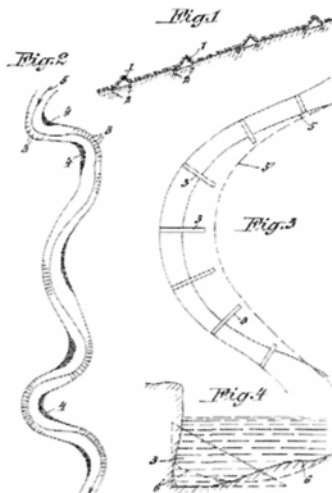

Figure 6.5: Excerpts from one of Schauberger's patents [35] for the regulation of water-courses

Another example is to station obliquely positioned logs across the river to slow down the water flow at the periphery, see Figure 6.5 and Figure 6.6, and thus indirectly direct the

#### 6.4. RESTORATION OF PONDS AND WATER COURSES

water towards the inner curve — a principle used by Schauberger for river regulation in Austria [35].

In that way the river-bed is stabilized and shore erosion is decreased, in the way indicated in Figure 6.5. A rather calm "marshy" region is thereby created at the outer curve. The following picture, with an example of natural river regulation in the Freinbach stream in Austria, ends the chapter.



Figure 6.6: Displacement of the axis of flow towards the inner curve, by the use of obliquely positioned logs, which slows down the flow at the outer curve. Freinbach in Steiermark district, Austria.

# Bibliography

- [1] Alexandersson, Olof Living water Gateway Books, 1990
- [2] Alexandersson, Olof Private communication
- [3] Antipov, S.V.; Nezhlin, M.V. & Trubnikov, A.S. Rossby Autosoliton JETP Lett, Vol. 41, 1985, p. 30-33
- [4] Aquagyro AB Ny oppenhet for ekologiskt inriktad teknik Gyroskopet, No. 2, 1989, p. 2-6, (Information magazine from Aquagyro AB, Umea)
- [5] Aquagyro AB Storskalig virvelteknik for miljovard inom synhall Gyroskopet, No. 1, 1990, p. 4-5, (Information magazine from Aquagyro AB, Umea)
- [6] Aquagyro AB Demonstrationsanlaggning i Alvsbyn — preliminar utvardering Gyroskopet, No. 1, 1990, p. 9-13, (Information magazine from Aquagyro AB, Umea)
- [7] Aquagyro AB Pilotanldggning i Alvsbyn Information brochure from Aquagyro AB, Umea, 1991
- [8] Aref, Hassan & Tryggvason, Gretar Vortex Dynamics of passive and active interfaces Physica D, Vol. 12, 1984, p. 59-70
- [9] Bouchillon, Charles W. & Franko, Andrew Computer Modeling Improves the Design of Hydrocyclones for Pulp Cleaning Paper Trade Journal, Vol. 168, 1984, p. 54-56
- [10] Coulson, John M. & Richardson, J.F. Chemical engineering 4:th ed., Pergamon Press, Oxford, 1990
- [11] Evans, Arthur The Palace of Minos — a comparative account of the successive stages of the early Cretan civilization as illustrated by the discoveries at Knossos Vol. 1, London, 1921, p. 141-43, 225-230, 371-75 and Vol. 3, London, 1930, p. 233-61
- [12] Frykhult, Rune Hydrocyclones — function and development views Report, AB Cel-leco, Stockholm
- [13] Gaponov-Grekhov, A.V.; Rabinovich, M.I. & Starobinets, I.M. The Onset and the Development of Chaotic Structures in Dissipative Media in Self-Organization: Autowaves and structures far from equilibrium, ed. V.I. Krinsky, Springer Verlag, Heidelberg, 1984, p. 130-38
- [14] Gleick, James Chaos — Making a new science Viking Penguin, N.Y., 1987
- [15] Gavelin, Gunnar Virvelrenare for fibersuspensioner Kemisk tidskrift, No. 11, 1981



## BIBLIOGRAPHY

- [16] Kats, V.A. & Trubetskov, D.I. Stochastization of Nonstationary Structures in a Distributed Oscillator with Delay in Self-Organization: Autowaves and structures far from equilibrium, ed. V.I. Krinsky, Springer Verlag, Heidelberg, 1984, p. 81-86
- [17] Kullberg, Sten Vattenströmning i spiralformade och koniska rör — stömningsforsök med anknytning till Viktor Schaubergers teorier Trita-Kut 3013, Masters Thesis, Department of Land Improvement and Drainage, Royal Institute of Technology, Sweden, 1982
- [18] Kuroda, Chiaki & Ogawa, Kohei Turbulent swirling pipe flows in Encyclopedia of Fluid Mechanics, Vol. 1 — Flow Phenomena and Measurement, Chapter 20, Gulf Publishing Co, Houston, 1986
- [19] Lugt, Hans J. Vortex Flow in Nature and Technology John Wiley & Sons, N.Y., 1983
- [20] Lofgren, Stefan Omrörningsorgan Swedish Patent No. B 460 706, (8705205-6)
- [21] Lofgren, Stefan Anordning för bearbetning av ett rörlikt medium Swedish Patent No. C2 500 416, (8903548-9)
- [22] Molin, Lena & Olsson, Susanne Sedimenttransport i rinnande vatten — laboratorieforsök Bachelor Thesis 1989:5, Department of Natural Sciences and Technology, Institute of Technology in Kalmar, Sweden, 1989
- [23] Moon, Francis C. Chaotic and Fractal Dynamics — an introduction for Applied Scientists and Engineers John Wiley & Sons, NY, 1992
- [24] Nicolis, Gregoire & Prigogine, Ilya Self-Organization in Nonequilibrium Systems — From Dissipative Structures to Order through Fluctuations John Wiley & Sons, NY, 1977
- [25] Nicolis, Gregoire & Prigogine, Ilya Exploring Complexity W.H. Freeman & Co, NY, 1989
- [26] Nordell, Bo & Nordmark, Desiree Laboratorieforsök med vatten i virvelrorelse — Matning av fysikaliska egenskaper Internal Report 1988:05, Department of Environmental Engineering, Division of Water Resources Engineering, Lulea Institute of Technology, Sweden, 1988
- [27] Ottino, Julio M. The kinematics of mixing — stretching, chaos and transport Cambridge University Press, Cambridge, 1989
- [28] Panfilov, A.V. & Winfree, A.T. Dynamical simulations of twisted scroll rings in three-dimensional excitable media Physica D, Vol. 17, 1985, p. 323-330
- [29] Plateau, J.A.F. Statique Experimental et Theorique des Liquides Soumis aux Seules Forces Moleculaires Gauthier-Villars, Paris, 1873
- [30] Prigogine, I. & GlansdorfT, P. Thermodynamic theory of structures, stabilities and fluctuations Wiley & Sons, London, 1971
- [31] Popel, Franz Rapport över preliminära undersökningar av spiralrör med olika form Institute of Ecological Technology, Sweden, 1986. (Originally published as Bericht über die Voruntersuchungen mit Wendelröhren mit verschniedener Wandform Internal Report, Institut für Gesundheitstechnik, Institute of Technology in Stuttgart, 1952. Published in English in The Energy Evolution Viktor Schauburger & Callum Coats (ed.), p. 222-47, Gateway Books, Bath, 2000)

## BIBLIOGRAPHY

- [32] Rapp, Gudmund Separation av kaffekorn fran vatten med cylindercentripet Report 2/94 + Appendix, Rapp Kommunikation HB, Saltsjobaden
- [33] Ribea Engineering AB, Information brochure from Ribea Engineering AB, Edsbruk
- [34] Schauburger, Viktor Temperatur och vattenrorelse - - nya upptackter om vattenrorelsens lagbundenhet och anvisningar for en ny teknik inom vattenbyggnad och skogsvdrd Institute of Ecological Technology, Sweden, 1983. (Originally published as a series of articles in Die Wasserwirtschaft, Wien, 1930-31. Published in English in The Water Wizard Viktor Schauburger & Callum Coats (ed.), p. 94-159, Gateway Books, Bath, 1998)
- [35] Schauburger, Viktor Einbau zur Wildbachverbauung und Flussregulierung Austrian Patent No. 113487, 1929
- [36] Schauburger, Viktor Wasserfuhung in Rohren und Gerinnen Austrian Patent No. 134543, 1933
- [37] Schauburger, Viktor Wasserfuhung Austrian Patent No. 138296, 1934
- [38] Schauburger, Walter Vattenrening in Vi maste ga en annan vag, p. 88-91, Alexandersson, Olof & Gustavsson Bertil eds., Institute of Ecological Technology, Sweden, 1986.
- [39] Schauburger, Walter Verfahren und Vorrichtung zur Herstellung von Gemischen, Losungen, Emulsionen, Suspensionen u. dgl. sowie zur biologischen Reinigung von freien Gewassern Austrian Patent No. 265991, 1968
- [40] Shaw, Robert The Dripping Faucet as a Model Chaotic System The Science Frontier Express Series, Aerial Press, Santa Cruz, CA, 1984
- [41] Tarr, D.T. Practical application of liquid cyclones in mineral dressing problems Report, 1965, Krebs Engineers, Palo Alto, CA, USA
- [42] Tsonis, Anastasios A. Chaos — From Theory to Applications Plenum Press, NY, 1992
- [43] Waldrop, M. Mitchell Complexity: The Emerging Science at the Edge of order & Chaos Penguin, 1992
- [44] Winfree, A.T. Wavefront geometry in excitable media Physica D, Vol. 12, 1984, p. 321-32