

FACTS ON FILE SCIENCE LIBRARY

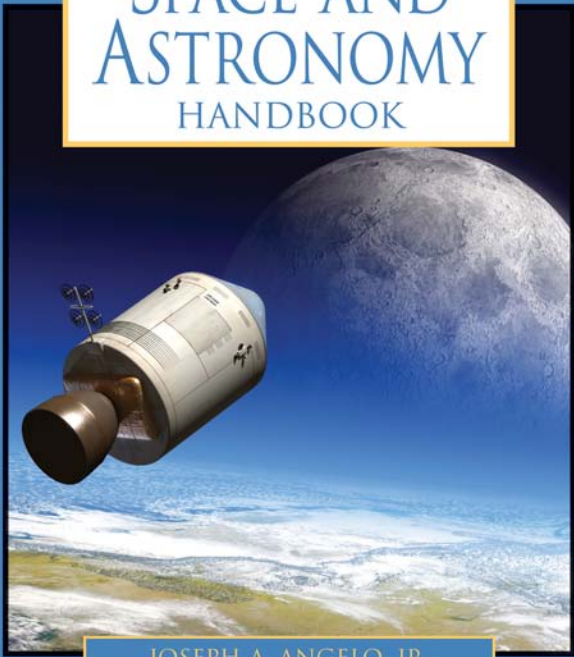

THE FACTS ON FILE

# SPACE AND ASTRONOMY HANDBOOK



JOSEPH A. ANGELO, JR.

REVISED EDITION

THE FACTS ON FILE  
**SPACE  
AND  
ASTRONOMY**  
HANDBOOK

Revised Edition

JOSEPH A. ANGELO, JR.

Adjunct Professor, Science Department, Valencia Community College

**The Facts On File Space and Astronomy Handbook, Revised Edition**

Copyright © 2009, 2002 by Joseph A. Angelo, Jr.

Illustrations © 2009 by Infobase Publishing

All rights reserved. No part of this book may be reproduced or utilized in any form or by any means, electronic or mechanical, including photocopying, recording, or by any information storage or retrieval systems, without permission in writing from the publisher. For information contact:

Facts On File, Inc.  
An imprint of Infobase Publishing  
132 West 31st Street  
New York NY 10001

**Library of Congress Cataloging-in-Publication Data**

Angelo, Joseph A.

The Facts on File space and astronomy handbook / Joseph A. Angelo, Jr.—Rev. ed.  
p. cm.

Includes bibliographical references and index.

ISBN 978-0-8160-7388-7

1. Astronomy—Handbooks, manuals, etc. 2. Space sciences—Handbooks, manuals, etc. I. Facts on File, Inc. II. Title. III. Title: Space and astronomy.

QB43.3.A44 2009

520—dc22 2008051761

Facts On File books are available at special discounts when purchased in bulk quantities for businesses, associations, institutions, or sales promotions. Please call our Special Sales Department in New York at (212) 967-8800 or (800) 322-8755.

You can find Facts On File on the World Wide Web at  
<http://www.factsonfile.com>

Text design adapted by James Scotto-Lavino  
Illustrations by Sholto Ainslie

Printed in the United States of America

Bang FOF 10 9 8 7 6 5 4 3 2 1

This book is printed on acid-free paper.

*To my sons, Joseph and James,  
who grew up in the red glare of the rockets from Cape Canaveral  
as the United States reached for the stars.*



---

# CONTENTS

Acknowledgments	vii
Introduction	ix
SECTION ONE <b>Glossary</b>	1
SECTION TWO <b>Biographies</b>	149
SECTION THREE <b>Chronology</b>	225
SECTION FOUR <b>Charts &amp; Tables</b>	279
APPENDIXES	
APPENDIX A <b>Recommended Reading</b>	317
APPENDIX B <b>Cyberspace Destinations</b>	319
INDEX	325

---





# ACKNOWLEDGMENTS

I wish to publicly acknowledge the generous support of the National Aeronautics and Space Administration (NASA) and its field centers and laboratories, the National Oceanic and Atmospheric Administration (NOAA), the National Reconnaissance Office (NRO), the U.S. Air Force (USAF), the U.S. Department of Defense (DOD), the U.S. Department of Energy (DOE), the U.S. Geological Survey (USGS), and the European Space Agency (ESA) during the original preparation and recent revision of this book. Special thanks are also extended to the editorial staff at Facts On File, particularly my editor, Frank K. Darmstadt. Finally, the support of two other key individuals merits public recognition here. The first is my physician Charles S. Stewart III, M.D., whose medical skills allowed me to complete the revision of this book. The second individual is my wife and soul mate, Joan, who is the *raison d'être* for this literary project and many other interesting adventures—great and small—over the past four decades.







# INTRODUCTION

An understanding of astronomy and space exploration is the basis for discovering the universe and how it works. Our daily lives, exciting new materials, and the information-rich, space-age civilization we now enjoy have been developed only through scientific research into the principles that underpin the physical world. However, obtaining a full view of any branch of science may be difficult without resorting to a range of books. Dictionaries of terms, encyclopedias of facts, biographical dictionaries, chronologies of scientific events—all of these collections of facts usually encompass a range of scientific subjects. **THE FACTS ON FILE SCIENCE HANDBOOK LIBRARY** covers the following major scientific areas—**CHEMISTRY, PHYSICS, EARTH SCIENCE, BIOLOGY, MARINE SCIENCE, WEATHER AND CLIMATE, ALGEBRA, CALCULUS, GEOMETRY**, and, of course, **SPACE AND ASTRONOMY**.



**THE FACTS ON FILE SPACE AND ASTRONOMY HANDBOOK** contains four sections—a glossary of terms, biographies of notable personalities, a chronology of events up to the present, and essential charts and tables. The volume also contains an extensive index.

## **GLOSSARY**

The specialized words used in any science subject mean that students need a glossary in order to understand the phenomena and processes involved. **THE FACTS ON FILE SPACE AND ASTRONOMY HANDBOOK** glossary contains more than 1,250 entries, often accompanied by labeled illustrations and photographs to help clarify the meanings.

## **BIOGRAPHIES**

The giants of astronomy and space—Copernicus, Galileo, Newton, and Goddard—are widely known, but hundreds of other dedicated scientists contributed to scientific knowledge. **THE FACTS ON FILE SPACE AND ASTRONOMY HANDBOOK** contains biographies of more than 400 people. Many of their achievements may have gone unnoticed. However, their discoveries have pushed forward the world's understanding of space and astronomy.





## Introduction

### **CHRONOLOGY**

Scientific discoveries often have no immediate impact. Nevertheless, their effects can influence lives more than wars, political changes, and world rulers. **THE FACTS ON FILE SPACE AND ASTRONOMY HANDBOOK** covers more than 5,000 years of events in the history of discoveries in astronomy and space exploration.

### **CHARTS & TABLES**

Basic information on any subject can be hard to find, and books tend to be descriptive. **THE FACTS ON FILE SPACE AND ASTRONOMY HANDBOOK** puts together key charts and tables for easy reference. Scientific discoveries mean that any compilation of facts can never be comprehensive. Nevertheless, this assembly of current information about space and astronomy offers an important resource for today's students. In past centuries, scientists were curious about a wide range of sciences. Today, with disciplines so specialized and independent, students of one subject rarely learn much about others or how the subjects relate. **THE FACTS ON FILE HANDBOOKS** enable students to compare knowledge in biology, chemistry, earth science, and physics; to put each subject into context; and to understand the close connections between all the sciences.



## Introduction

---

SECTION ONE

# GLOSSARY

## GLOSSARY

### Abell cluster – absolute zero

**Abell cluster** A rich (high-DENSITY) CLUSTER OF GALAXIES as characterized by the American astronomer GEORGE ABELL. In 1958, Abell produced a catalog describing over 2,700 of these high-density galactic clusters using PALOMAR OBSERVATORY photographic data.

**aberration of starlight** The tiny APPARENT displacement of the position of a STAR from its true position due to a combination of the finite VELOCITY OF LIGHT (symbol  $c$ ), about 300,000 km/s, and the motion of an observer across the path of the incident starlight. For example, an astronomer on EARTH'S surface has a velocity of about 30 km/s—the average speed of Earth in its ORBIT around the SUN. This motion causes an annual aberration of starlight.

**ablation** The removal of surface material from a body by vaporization, melting, sublimation, or other erosive processes. Ablation is a special form of heat transfer called *mass transfer cooling*. AEROSPACE engineers use this sacrificial phenomenon to provide thermal protection to the underlying structure of a REENTRY VEHICLE, PLANETARY PROBE, or AEROSPACE VEHICLE during high-speed movement through a planetary ATMOSPHERE.

**ablative cooling** Temperature reduction achieved by vaporization or melting of special, sacrificial surface materials.

**abort** To cut short or cancel an operation with a ROCKET, SPACECRAFT, or AEROSPACE VEHICLE, especially because of equipment failure. NASA'S SPACE SHUTTLE system has two types of abort modes during the ascent phase of a flight: the intact abort and the contingency abort. An intact abort is designed to achieve a safe return of the ASTRONAUT crew and ORBITER vehicle to a planned landing site. A contingency abort involves a ditching operation in which the crew is saved, but the orbiter vehicle is damaged or destroyed.

**absolute magnitude (M)** The measure of the brightness (or APPARENT MAGNITUDE) that a STAR would have if it were hypothetically located at a reference distance of 10 PARSECS (10 pc), about 32.6 LIGHT-YEARS, from the SUN.

**absolute temperature** A temperature value relative to ABSOLUTE ZERO, which corresponds to 0 K. In almost all modern scientific activities, absolute temperature values are expressed KELVINS (K)—a unit within the international system honoring the Scottish physicist, BARON WILLIAM THOMSON KELVIN. *See also* SI UNITS.

**absolute zero** The temperature at which molecular motion vanishes and an object has no thermal ENERGY (or heat). Absolute zero is the lowest possible temperature.



Catastrophic abort of the Vanguard launch vehicle at Cape Canaveral on December 6, 1957 (U.S. Navy)

## GLOSSARY

### Abell cluster – absolute zero

**absorption line** The gap, dip, or dark-line feature in a stellar SPECTRUM occurring at a specific WAVELENGTH. It is caused by the absorption of the RADIATION emitted from a STAR's hotter interior regions by an absorbing substance in its relatively cooler outer regions. Analysis of absorption lines lets astronomers determine the chemical composition of stars.

**absorption spectrum** The collection of dark lines superimposed upon a continuous SPECTRUM that occurs when RADIATION from a hot source passes through a cooler medium, allowing some of that radiant ENERGY to get absorbed at selected WAVELENGTHS.

**abundance of elements** (*in the universe*) Stellar spectra provide an estimate of the cosmic abundance of ELEMENTS as a percentage of the total MASS of the UNIVERSE. The 10 most common elements are HYDROGEN (H) at 73.5 percent of the total mass, HELIUM (He) at 24.9 percent, oxygen (O) at 0.7 percent, carbon (C) at 0.3 percent, iron (Fe) at 0.15 percent, neon (Ne) at 0.12 percent, nitrogen (N) at 0.10 percent, silicon (Si) at 0.07 percent, magnesium (Mg) at 0.05 percent, and sulfur (S) at 0.04 percent.

**accelerated life tests** The series of test procedures for a SPACECRAFT or AEROSPACE system that approximate in a relatively short period of time the deteriorating effects and possible failures that might be encountered under normal, long-term space mission conditions.

**acceleration** (*a*) The rate at which the VELOCITY of an object changes with time. Acceleration is a VECTOR quantity and has the physical dimensions of length per unit time to the second power (for example, meters per second per second, or  $m/s^2$ ).

**acceleration of gravity** The local ACCELERATION due to GRAVITY on or near the surface of a PLANET. On EARTH, the acceleration due to gravity (*g*) of a FREE-FALLING object has the standard value of  $9.80665 m/s^2$  by international agreement. According to legend, GALILEO GALILEI simultaneously dropped a large and small cannonball from the top of the Tower of Pisa to investigate the acceleration of gravity. As he anticipated, each object fell to the ground in exactly the same amount of time (neglecting AIR resistance)—despite the difference in their MASSES. Galileo's pioneering work helped SIR ISAAC NEWTON unlock the secrets of motion of the mechanical UNIVERSE.

**accelerometer** An instrument that measures ACCELERATION or gravitational FORCES capable of imparting acceleration. It is frequently used on SPACE VEHICLES to assist in guidance and navigation and on PLANETARY PROBES to support scientific data collection.

## GLOSSARY

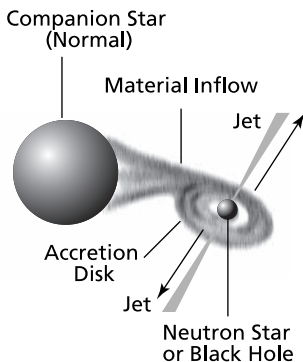

Accretion disk

## accretion – active remote sensing

**accretion** The gradual accumulation of small PARTICLES of gas and dust into larger material bodies, mostly due to the influence of GRAVITY. For example, in the early stages of stellar formation, matter begins to collect or accrete into a NEBULA (a giant interstellar cloud of gas and dust). Eventually, STARS are born in this nebula. When a particular star forms, small quantities of residual matter may collect into one or more PLANETS that orbit the new star.

**accretion disk** The whirling DISK of inflowing (or infalling) material from a normal stellar companion that develops around a massive COMPACT BODY, such as a NEUTRON STAR or a BLACK HOLE. The conservation of ANGULAR MOMENTUM shapes this disk, which is often accompanied by a pair of very high-speed material jets that depart in opposite directions perpendicular to the plane of the disk.

**Achilles** The first ASTEROID of the TROJAN GROUP discovered. This 115 km diameter MINOR PLANET was found by MAXIMILIAN WOLF in 1906 and is also called Asteroid-588.

**acquisition** The process of locating the ORBIT of a SATELLITE or the TRAJECTORY of a SPACE PROBE so that mission control personnel can track the object and collect its TELEMETRY data.

**acronym** A word formed from the first letters of a name, such as *HST*—which means the *HUBBLE SPACE TELESCOPE*. It is also a word formed by combining the initial parts of a series of words, such as lidar—which means light detection and ranging. Acronyms are frequently used in space technology and ASTRONOMY.

**active galactic nucleus (AGN)** The central region of a distant (active) GALAXY that appears to be a pointlike source of intense X-RAY or GAMMA RAY emissions. Astrophysicists speculate that the AGN is caused by the presence of a centrally located, super-heavy BLACK HOLE accreting nearby matter.

**active galaxies** Collectively, those unusual celestial objects, including QUASARS, BL LAC OBJECTS, and SEYFERT GALAXIES, that have extremely energetic central regions, called ACTIVE GALACTIC NUCLEI (AGN). These emit enormous amounts of ELECTROMAGNETIC RADIATION, ranging from RADIO WAVES to X-RAYS and GAMMA RAYS.

**active remote sensing** A REMOTE-SENSING technique in which the SENSOR supplies its own source of ELECTROMAGNETIC RADIATION to illuminate a target. A SYNTHETIC APERTURE RADAR (SAR) system is an example.

## GLOSSARY

## accretion – active remote sensing

**active satellite** A SATELLITE that transmits a signal, in contrast to a passive (dormant) satellite.

**active Sun** The name scientists give to the collection of dynamic SOLAR phenomena, including SUNSPOTS, SOLAR FLARES, and PROMINENCES, associated with intense variations in the SUN's magnetic activity.  
*Compare with* QUIET SUN.

**acute radiation syndrome (ARS)** The acute organic disorder that follows exposure to relatively severe doses of IONIZING RADIATION. A person will initially experience nausea, diarrhea, or blood cell changes. In the later stages loss of hair, hemorrhaging, and possibly death can take place. Radiation dose equivalent values of about 450 to 500 rem (4.5 to 5 sievert) will prove fatal to 50 percent of the exposed individuals in a large general population. Also called RADIATION SICKNESS.

**adapter skirt** A flange or extension on a LAUNCH VEHICLE stage or SPACECRAFT section that provides a means of fitting on another stage or section.

**adaptive optics** Optical systems, such as TELESCOPES, that are modified to compensate for distortions, usually through the use of a component mirror whose shape can be easily changed and controlled. In ground-based observational ASTRONOMY, adaptive optics helps eliminate the twinkling of STARS caused by variations and distortions in EARTH's intervening ATMOSPHERE.

**adiabatic** A process or phenomenon that takes place without gain or loss of thermal ENERGY (heat).

**aero-** A prefix that means of or pertaining to the AIR, the ATMOSPHERE, aircraft, or flight through a PLANET's atmosphere.

**aeroassist** The use of the thin, upper regions of a planet's ATMOSPHERE to provide the lift or DRAG needed to maneuver a SPACECRAFT. Near a PLANET with a SENSIBLE ATMOSPHERE, aeroassist allows a spacecraft to change direction or to slow down without expending PROPELLANT from the CONTROL ROCKET.

**aerobraking** The use of a specially designed SPACECRAFT structure to deflect rarefied (very low-DENSITY) airflow around a spacecraft, thereby supporting AEROASSIST maneuvers in the vicinity of a PLANET. Such maneuvers reduce the spacecraft's need to perform the large propulsive burns when making orbital changes near a planet. In 1993, NASA's *MAGELLAN* MISSION became the first planetary exploration system to use aerobraking as a means of changing its ORBIT around the target planet (VENUS).



**aerodynamic force** The lift (*L*) or DRAG (*D*) exerted by a moving gas upon a body completely immersed in it. Lift acts in a direction normal to the flight path, while drag acts in a direction parallel and opposite to the flight path. *See also* AIRFOIL.

**aerodynamic heating** Frictional surface heating experienced by an AEROSPACE VEHICLE or space system as it enters the upper regions of a planetary ATMOSPHERE at very high velocities. Special thermal protection is needed to prevent structural damage or destruction. NASA'S SPACE SHUTTLE ORBITER vehicle, for example, uses thermal protection tiles to survive the intense aerodynamic heating environment that occurs during REENTRY and landing. *See also* ABLATIVE COOLING.

**aerodynamic skip** An atmospheric entry ABORT caused by entering a PLANET'S ATMOSPHERE at too shallow an angle. Much like a stone skipping across the surface of a pond, this condition results in a TRAJECTORY back out into space rather than downward toward the planet's surface.

**aerodynamic vehicle** A craft that has lifting and control surfaces to provide stability, control, and maneuverability while flying through a PLANET'S ATMOSPHERE.

**aeropause** A region of indeterminate limits in a PLANET'S upper ATMOSPHERE, considered as a boundary between the denser (sensible) portion of the atmosphere and OUTER SPACE.

**aerosol** A very small dust particle or droplet of liquid (other than water or ice) in a PLANET'S ATMOSPHERE, ranging in size from about 0.001 MICROMETER ( $\mu\text{m}$ ) to larger than 100 micrometers ( $\mu\text{m}$ ) in radius. Terrestrial aerosols include smoke, dust, haze, and fumes.

**aerospace** A term, derived from *aeronautics* and *space*, meaning of or pertaining to EARTH'S atmospheric envelope and OUTER SPACE beyond it. NASA'S SPACE SHUTTLE ORBITER vehicle is called an AEROSPACE VEHICLE because it operates both in the ATMOSPHERE and in outer space.

**aerospace ground equipment (AGE)** All the support and test equipment needed on EARTH'S surface to make an AEROSPACE system or SPACECRAFT function properly during its intended space mission.

**aerospace medicine** The branch of medical science that deals with the effects of flight upon the human body. The treatment of SPACE SICKNESS (space adaptation syndrome) falls within this field.

## aerospace vehicle – airfoil

## GLOSSARY

**aerospace vehicle** A vehicle capable of operating both within EARTH'S SENSIBLE (measurable) ATMOSPHERE and in OUTER SPACE. The SPACE SHUTTLE ORBITER vehicle is an example.

**aerospoke nozzle** A rocket NOZZLE design that allows combustion to occur around the periphery of a spike (or center plug). The THRUST-producing, hot-exhaust flow is then shaped and adjusted by the ambient (atmospheric) pressure.

**aerozine** A liquid ROCKET fuel consisting of a mixture of HYDRAZINE ( $N_2H_4$ ) and unsymmetrical dimethylhydrazine (UDMH), which has the chemical formula  $(CH_3)_2NNH_2$ .

**afterbody** Any COMPANION BODY (usually JETTISONED, expended hardware) that trails a SPACECRAFT following LAUNCH and contributes to the SPACE (ORBITAL) DEBRIS problem. It is also any expended portion of a LAUNCH VEHICLE or ROCKET that enters EARTH'S ATMOSPHERE unprotected behind a returning NOSE CONE or SPACE CAPSULE that is protected against the AERODYNAMIC HEATING. Finally, it is any unprotected, discarded portion of a SPACE PROBE or SPACECRAFT that trails behind the protected probe or LANDER SPACECRAFT as either enters a PLANET'S atmosphere to accomplish the mission.

**Agena** A versatile, UPPER-STAGE ROCKET that supported numerous American military and civilian space missions in the 1960s and 1970s. One special feature of this LIQUID PROPELLANT system was its in-space engine restart capability.

**age of the Moon** The elapsed time, usually expressed in days, since the last new MOON. *See also* PHASES OF THE MOON.

**agglutinate** A common type of particle found on the MOON, consisting of small rock, mineral, and glass fragments impact-bonded together with glass.

**air** The overall mixture of gases that make up EARTH'S ATMOSPHERE, primarily nitrogen ( $N_2$ ) at 78 percent (by volume), oxygen ( $O_2$ ) at 21 percent, argon (Ar) at 0.9 percent, and CARBON DIOXIDE ( $CO_2$ ) at 0.03 percent. Sometimes AEROSPACE engineers use this word for the breathable gaseous mixture found inside the crew compartment of a SPACE VEHICLE or in the PRESSURIZED HABITABLE ENVIRONMENT of a SPACE STATION.

**airfoil** A wing designed to provide AERODYNAMIC FORCE when it moves through the AIR (on EARTH) or through the SENSIBLE ATMOSPHERE of a PLANET (such as MARS or VENUS) or of TITAN, the largest MOON of SATURN.

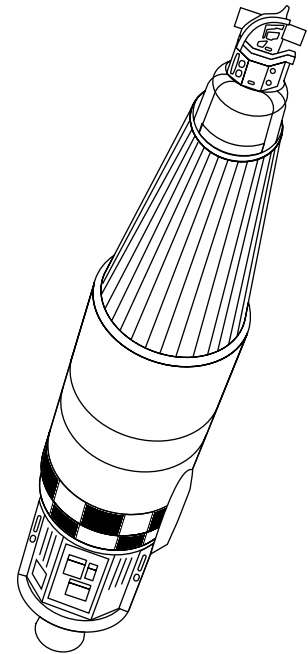

Agena

## aerospace vehicle – airfoil

## GLOSSARY

- air launch** The process of launching a GUIDED MISSILE or ROCKET from an aircraft while it is in flight.
- airlock** A small chamber with airtight doors that can be pressurized and depressurized. The airlock serves as a passageway for crew members and equipment between places at different pressure levels—for example, between a SPACECRAFT’s pressurized crew cabin and OUTER SPACE.
- albedo** The ratio of the amount of ELECTROMAGNETIC RADIATION (such as visible LIGHT) reflected by a surface to the total amount of electromagnetic radiation incident upon the surface. The albedo is usually expressed as a percentage. For example, the planetary albedo of EARTH is about 30 percent. This means that approximately 30 percent of the total SOLAR RADIATION falling upon Earth is reflected back to OUTER SPACE.
- algorithm** A special mathematical procedure or rule for solving a particular type of problem.
- alien life-form (ALF)** A general, though at present hypothetical, expression for EXTRATERRESTRIAL life, especially life that exhibits some degree of intelligence.
- Almagest** The Arabic name (meaning “the greatest”) for the collection of ancient Greek astronomical and mathematical knowledge written by PTOLEMY in about 150 C.E. and translated by Arab astronomers about 820 C.E. This compendium included the 48 ancient Greek CONSTELLATIONS upon which today’s astronomers base the modern system of constellations.
- Almaz (diamond)** A series of Russian military SPACE STATIONS embedded within the first-generation SALYUT space station program flown by the Soviet Union in the 1970s. In the 1980s, the Almaz station was converted for use as an uncrewed SPACE PLATFORM in support of radar imagery REMOTE SENSING PAYLOADS flown in ORBIT around EARTH.
- Alpha Centauri** The closest STAR system, about 4.3 LIGHT-YEARS away. It is actually a triple-star system, with two stars orbiting around each other and a third star, called PROXIMA CENTAURI, revolving around the pair at some distance.
- alphanumeric** (*alphabet plus numeric*) Including letters and numerical digits, for example, the term *JEN75WX11*.
- alpha particle** (*α particle*) A positively charged atomic PARTICLE emitted by certain radioactive NUCLIDES. It consists of two NEUTRONS and two PROTONS bound together and is identical to the NUCLEUS of a HELIUM

## altazimuth mounting – amorphotoi

$4\text{ }(^4_2\text{He})$  ATOM. Alpha particles are the least penetrating of the three common types of nuclear IONIZING RADIATION (alpha particle, BETA PARTICLE, and GAMMA RAY).

**altazimuth mounting** A TELESCOPE mounting that has one AXIS pointing to the ZENITH.

**altimeter** An instrument for measuring the height (ALTITUDE) above a PLANET'S surface; generally reported relative to a common planetary reference point, such as sea level on EARTH.

**altitude** (1) (*astronomy*) The ANGLE between an observer's horizon and a target CELESTIAL BODY. The ALTITUDE is  $0^\circ$  if the object is on the horizon and  $90^\circ$  if the object is at ZENITH (directly overhead). (2) (*spacecraft*) In SPACE VEHICLE navigation, the height above the mean surface of the reference CELESTIAL BODY. Note that the *distance* of a space vehicle or SPACECRAFT from the reference celestial body is taken as the distance from the center of the object.

**Amalthea** The small (270 km  $\times$  150 km diameter), irregularly shaped, inner MOON of JUPITER, discovered as the fifth Jovian moon in 1892 by EDWARD EMERSON BARNARD.

**ambient conditions** (*planetary*) The environmental conditions, such as atmospheric pressure or temperature, that surround an AEROSPACE VEHICLE or PLANETARY PROBE. For example, a planetary probe on the surface of VENUS must function in an inferno-like environment where the ambient temperature is about  $480^\circ\text{C}$  (753 K).

**amino acid** An acid containing the amino ( $\text{NH}_2$ ) group, a group of MOLECULES necessary for life. More than 80 amino acids are presently known, but only some 20 occur naturally in living organisms, where they serve as the building blocks of proteins. On EARTH, many microorganisms and plants can synthesize amino acids from simple inorganic compounds.

**Amor group** A collection of NEAR-EARTH ASTEROIDS that cross the ORBIT of MARS but do not cross the orbit of EARTH. This ASTEROID group acquired its name from the 1 km diameter Amor asteroid, discovered by EUGÈNE-JOSEPH DELPORTE in 1932.

**amorphotoi** Term used by the early Greek astronomers to describe the spaces in the night sky populated by dim STARS between the prominent groups of stars making up the ANCIENT CONSTELLATIONS. It is Greek for "unformed."

## altazimuth mounting – amorphotoi

## GLOSSARY

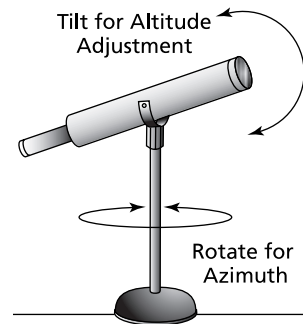

Mount does not counteract Earth's rotation.

Altazimuth mounting



Galileo spacecraft encountering Amalthea (NASA)

## GLOSSARY

## GLOSSARY

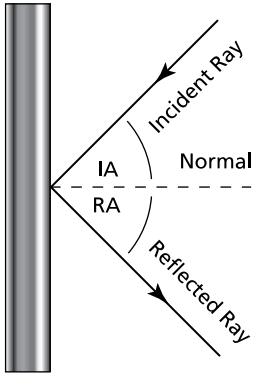

Angle of Incidence (IA) =  
Angle of Reflection (RA)

Angle of incidence

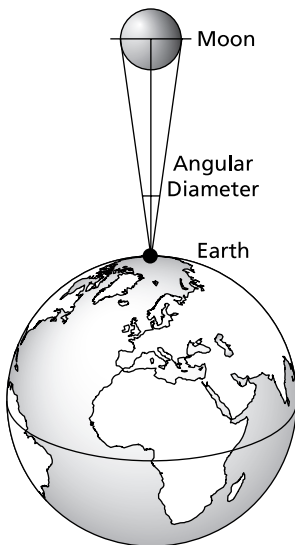

Angular diameter

## GLOSSARY

### amplitude – angular diameter

**amplitude** Generally, the maximum value of the displacement of a wave or other periodic phenomenon from a reference (average) position. Specifically, it is the overall range of brightness (from maximum MAGNITUDE to minimum magnitude) of a VARIABLE STAR.

**ancient astronaut theory** The (unproven) hypothesis that EARTH was visited in the past by a race of intelligent EXTRATERRESTRIAL beings who were exploring this portion of the MILKY WAY GALAXY.

**ancient constellations** The collection of approximately 50 CONSTELLATIONS drawn up by ancient astronomers and recorded by PTOLEMY, including such familiar constellations as the signs of the ZODIAC, Ursa Major (the Great Bear), Boötes (the Herdsman), and Orion (the Hunter). *See also* SECTION IV CHARTS & TABLES.

**Andromeda galaxy** The Great Spiral Galaxy (or M31) in the CONSTELLATION of Andromeda, about 2.5 million LIGHT-YEARS away. It is the most distant object visible to the NAKED EYE and is the closest SPIRAL GALAXY to the MILKY WAY GALAXY.

**angle** The inclination of two intersecting lines to each other, measured by the arc of a circle intercepted between the two lines forming the angle. An acute angle is less than 90°; a right angle is precisely 90°; an obtuse angle is greater than 90° but less than 180°; and a straight angle is 180°.

**angle of incidence** The ANGLE at which a ray of LIGHT (or other type of ELECTROMAGNETIC RADIATION) impinges on a surface. This angle is usually measured between the direction of propagation and a perpendicular to the surface at the point of incidence.

**angle of reflection** The ANGLE at which a reflected ray of LIGHT (or other type of ELECTROMAGNETIC RADIATION) leaves a reflecting surface. This angle is usually measured between the direction of the outgoing ray and a perpendicular to the surface at the point of reflection. For a plane mirror, the angle of reflection equals the ANGLE OF INCIDENCE.

**angstrom** (Å) A unit of length used to indicate the WAVELENGTH of ELECTROMAGNETIC RADIATION in the visible, near-infrared, and near-ultraviolet portions of the SPECTRUM. Named after ANDERS JONAS ÅNGSTRÖM, 1 angstrom equals 0.1 nanometer ( $10^{-10}$  m).

**angular acceleration** ( $\alpha$ ) The time rate of change of ANGULAR VELOCITY ( $\omega$ ).

**angular diameter** The ANGLE formed by the lines projected from a common point to the opposite sides of a body.

### amplitude – angular diameter

## angular measure – antenna

**angular measure** Units of ANGLE generally expressed in terms of degrees ( $^{\circ}$ ), arc minutes ( $'$ ), and arc seconds ( $''$ ), where 1 degree of angle equals 60 arc minutes, and 1 arc minute equals 60 arc seconds.

**angular momentum** ( $L$ ) A measure of an object's tendency to continue rotating at a particular rate around a certain AXIS. It is defined as the product of the ANGULAR VELOCITY ( $\omega$ ) of the object and its moment of INERTIA ( $I$ ) about the axis of rotation.

**angular velocity** ( $\omega$ ) The change of ANGLE per unit time; usually expressed in RADIANS per second.

**annihilation radiation** Upon collision, the conversion of a PARTICLE and its corresponding antiparticle into pure electromagnetic ENERGY (called *annihilation radiation*). For example, when an ELECTRON ( $e^{-}$ ) and POSITRON ( $e^{+}$ ) collide, the minimum annihilation radiation released consists of a pair of GAMMA RAYS, each of approximately 0.511 million ELECTRON VOLTS (MeV) energy.

**annual parallax** ( $\pi$ ) The PARALLAX of a STAR that results from the change in the position of a reference observing point during EARTH's annual REVOLUTION around the SUN. It is the maximum angular displacement of the star that occurs when the star-Sun-Earth ANGLE is  $90^{\circ}$  (as illustrated). Also called the HELIOCENTRIC parallax.

**annular nozzle** A NOZZLE with a ring-shaped (annular) throat formed by an outer wall and a center body wall.

**anomalistic period** The time interval between two successive PERIGEE passages of a SATELLITE in ORBIT about its PRIMARY BODY. For example, the term *anomalistic month* defines the mean time interval between successive passages of the MOON through its closest point to EARTH (perigee), about 27.555 days.

**anomaly** (1) (*astronomy*) The ANGLE used to define the position (at a particular time) of a celestial object, such as a PLANET or ARTIFICIAL SATELLITE in an elliptical ORBIT about its PRIMARY BODY. The *true anomaly* of a planet is the angle (in the direction of the planet's motion) between the point of closest approach (the PERIHELION), the focus (the SUN), and the planet's current orbital position. (2) (*space operations*) A deviation from the normal or anticipated result.

**antenna** A device used to detect, collect, or transmit RADIO WAVES. A RADIO TELESCOPE is a large receiving antenna. Many SPACECRAFT have both a DIRECTIONAL ANTENNA and an OMNIDIRECTIONAL ANTENNA to transmit (DOWNLINK) TELEMETRY and to receive (UPLINK) instructions.

## angular measure – antenna

## GLOSSARY

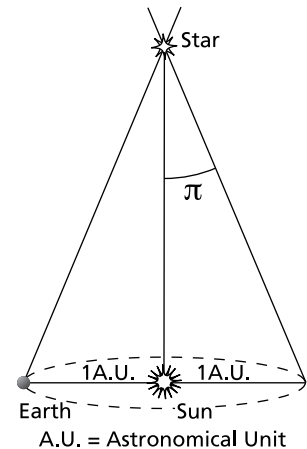

Annual parallax

## GLOSSARY

## GLOSSARY



Russian antisatellite (ASAT) spacecraft (DOD/DIA)

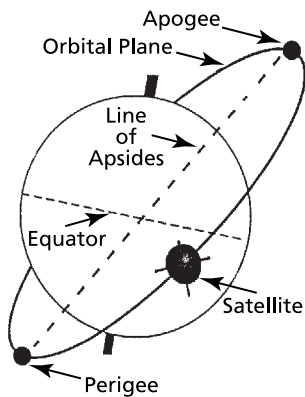

Apogee (Courtesy of NASA)

## GLOSSARY

### antenna array – apogee

**antenna array** A group of ANTENNAS coupled together into a system to obtain directional effects or to increase sensitivity. *See also* VERY LARGE ARRAY.

**anthropic principle** The controversial hypothesis in modern COSMOLOGY suggesting that the UNIVERSE evolved in just the right way after the BIG BANG event to allow for the emergence of human life.

**antimatter** Matter in which the ordinary nuclear PARTICLES (such as ELECTRONS, PROTONS, and NEUTRONS) are replaced by their corresponding antiparticles—POSITRONS, antiprotons, antineutrons, and so on. It is sometimes called *mirror matter*. Normal matter and antimatter mutually annihilate each other upon contact and are converted into pure ENERGY, called ANNIHILATION RADIATION.

**antisatellite (ASAT) spacecraft** A SPACECRAFT designed to destroy other SATELLITES in space. An ASAT spacecraft could be deployed in space disguised as a peaceful satellite that quietly lurks as a secret hunter/killer satellite, awaiting instructions to track and attack its prey.

**antislosh baffle** A device installed in the PROPELLANT tank of a liquid-fuel ROCKET to dampen unwanted liquid motion, or sloshing, during flight.

**apastron** The point in a body's ORBIT around a STAR at which it is at a maximum distance from the star. *Compare with* PERIASTRON.

**aperture** The opening in front of a TELESCOPE, camera, or other optical instrument through which LIGHT passes.

**aperture synthesis** A resolution-improving technique in RADIO ASTRONOMY that uses a variable-aperture radio INTERFEROMETER to mimic the full-dish size of a huge RADIO TELESCOPE.

**apex** The direction in the sky toward which the SUN and its system of PLANETS appear to be moving relative to the local STARS. Also called the *solar apex*, it is located in the CONSTELLATION of Hercules.

**aphelion** The point in an object's ORBIT around the SUN that is most distant from the Sun. *Compare with* PERIHELION.

**Aphrodite Terra** A large, fractured highland region near the EQUATOR of VENUS.

**apogee** The point in the ORBIT of a SATELLITE that is farthest from EARTH. The term applies both to the orbit of the MOON as well as to the orbits of ARTIFICIAL SATELLITES around Earth. At apogee, the orbital VELOCITY of a satellite is at a minimum. *Compare with* PERIGEE.

### antenna array – apogee

**apogee motor** A SOLID-PROPELLANT ROCKET motor that is attached to a SPACECRAFT and fired when the deployed spacecraft is at the APOGEE of an initial (relatively low-ALTITUDE) PARKING ORBIT around EARTH. This firing establishes a new ORBIT farther from Earth or permits the spacecraft to achieve ESCAPE VELOCITY.

**Apollo 1 tragedy** On 27 January 1967, disaster struck NASA's APOLLO PROJECT when a fire erupted inside the *Apollo 1* SPACECRAFT during ground testing at Complex 34, CAPE CANAVERAL Air Force Station, Florida. The flash fire resulted in the deaths of ASTRONAUTS VIRGIL (GUS) I. GRISSOM, EDWARD H. WHITE II, and ROGER B. CHAFFEE. As a result of this fatal accident, NASA made major modifications to the Apollo spacecraft prior to its first crewed mission in space.

**Apollo group** A collection of NEAR-EARTH ASTEROIDS that have PERIHELION distances of 1.017 ASTRONOMICAL UNITS (AU) or less, taking them across the ORBIT of EARTH around the SUN. This group acquired its name from the first ASTEROID to be discovered, Apollo, in 1932 by KARL REINMUTH.

**Apollo Lunar Surface Experiments Package (ALSEP)** Scientific devices and equipment placed on the MOON by the APOLLO PROJECT ASTRONAUTS and left there to transmit data back to EARTH. Experiments included the study of METEORITE IMPACTS, LUNAR surface characteristics, seismic activity on the Moon, SOLAR WIND interaction, and analysis of the very tenuous lunar ATMOSPHERE.

**Apollo Project** The American effort in the 1960s and early 1970s to place ASTRONAUTS successfully onto the surface of the MOON and return them safely to EARTH. The project was launched in May 1961 by President JOHN F. KENNEDY in response to a growing space technology challenge from the former Soviet Union. Managed by NASA, the *Apollo 8* mission sent the first three humans to the vicinity of the Moon in December 1968. The *Apollo 11* mission involved the first human landing on another world (20 July 1969). *Apollo 17*, the last lunar landing mission under this project, took place in December 1972. The project is often considered one of the greatest technical accomplishments in all human history. *See also* SECTION IV CHARTS & TABLES.

**Apollo-Soyuz Test Project (ASTP)** The joint United States–former Soviet Union space mission (July 1975), centering on the RENDEZVOUS and DOCKING of the *APOLLO 18* spacecraft (three-ASTRONAUT crew) and the *SOYUZ 19* SPACECRAFT (two-COSMONAUT crew).



## GLOSSARY

Apollo Project (Courtesy of NASA)

### apolune – apparent magnitude

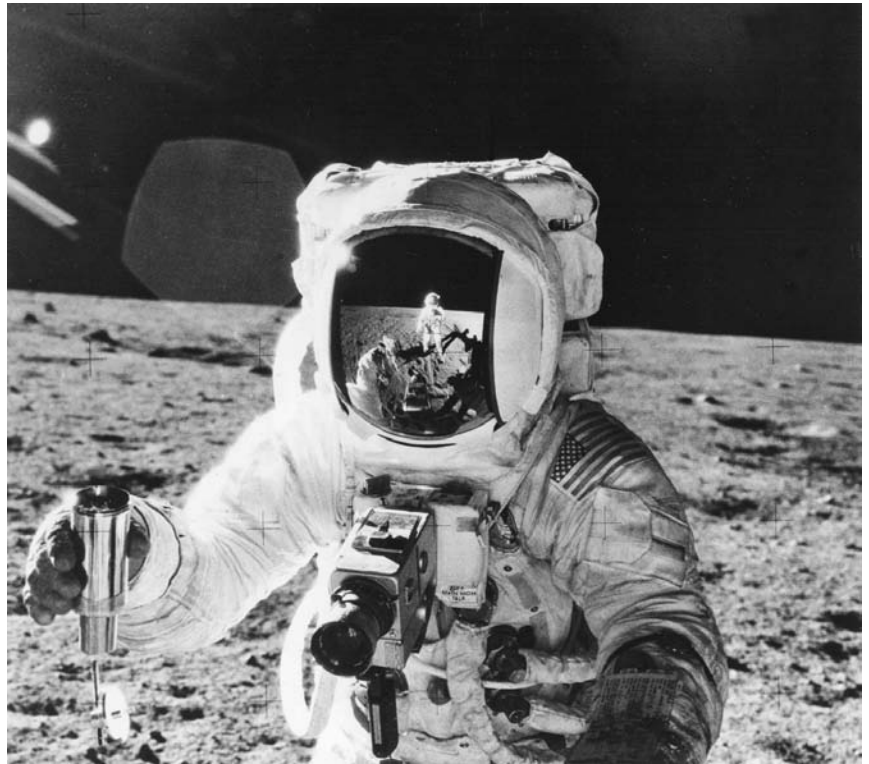

**apolune** That point in an ORBIT around the MOON of a SPACECRAFT launched from the LUNAR surface that is farthest from the Moon. *Compare with* PERILUNE.

**apparent** In ASTRONOMY, observed. True values are reduced from apparent (observed) values by eliminating those factors, such as refraction and flight time, that can affect the observation.

**apparent diameter** The observed diameter (but not necessarily the actual diameter) of a CELESTIAL BODY. It is usually expressed in degrees, minutes, and seconds of arc. *See also* ANGULAR DIAMETER.

**apparent magnitude** (*m*) The brightness of a STAR (or other CELESTIAL BODY) as measured by an observer on EARTH. Its value depends on the star's intrinsic brightness (LUMINOSITY), how far away it is, and how much of its light has been absorbed by the intervening INTERSTELLAR MEDIUM. *See also* ABSOLUTE MAGNITUDE; MAGNITUDE.

## GLOSSARY

### apolune – apparent magnitude

## apparent motion – Ares V

**apparent motion** The observed motion of a heavenly body across the CELESTIAL SPHERE, assuming that EARTH is at the center of the celestial sphere and is standing still (stationary).

**approach** The maneuvers of a SPACECRAFT or AEROSPACE VEHICLE from its normal orbital position (STATION-KEEPING position) toward another orbiting spacecraft for the purpose of conducting RENDEZVOUS and DOCKING operations.

**Aqua** A NASA-sponsored, advanced EARTH-OBSERVING SPACECRAFT placed into POLAR ORBIT by a DELTA II ROCKET from VANDENBERG AIR FORCE BASE on 4 May 2002. The primary role of *Aqua* is to gather information about changes in ocean circulation and how clouds and surface water processes impact EARTH's climate. Equipped with six state-of-the-art REMOTE SENSING instruments, the satellite is collecting data on global precipitation, evaporation, and the cycling of water on a planetary basis. *See also AURA; TERRA.*

**archaeological astronomy** Scientific investigation concerning the astronomical significance of ancient structures and sites, such as STONEHENGE in the United Kingdom.

**arc-jet engine** An electric ROCKET engine that heats a PROPELLANT gas by passing through it an electric arc.

**Arecibo Interstellar Message** To help inaugurate the powerful radio/radar TELESCOPE of the ARECIBO OBSERVATORY, an INTERSTELLAR radio wave message of friendship was beamed to the fringes of the MILKY WAY GALAXY on 16 November 1974. Scientists sent a special RADIO FREQUENCY (RF) signal toward the Great Cluster in Hercules—a GLOBULAR CLUSTER that lies about 25,000 LIGHT-YEARS away from EARTH and contains about 300,000 STARS within a radius of approximately 18 light-years.

**Arecibo Observatory** The world's largest radio/radar TELESCOPE with a 305 m diameter dish. It is located in a large, bowl-shaped natural depression in the tropical jungles of Puerto Rico. When it operates as a RADIO WAVE receiver, the giant RADIO TELESCOPE can listen for signals from celestial objects at the farthest reaches of the UNIVERSE.

**Ares I** The name given by NASA to the new crew-carrying LAUNCH VEHICLE, which will start transporting ASTRONAUTS to the *INTERNATIONAL SPACE STATION (ISS)* in about 2015 and back to the MOON in about 2020. *See also SECTION IV CHARTS & TABLES.*

**Ares V** The name given by NASA to the new heavy lift LAUNCH VEHICLE, which will serve as the agency's primary launch vehicle for the safe,

## GLOSSARY



Arecibo Observatory (NASA)



Ares I crew-carrying launch vehicle (NASA)

## apparent motion – Ares V

## GLOSSARY

## GLOSSARY

Ares V cargo-carrying launch vehicle (NASA)



Ariane 5 launch vehicle  
(ESA/CNES/Arianespace-Service  
Optique CSG; © ESA)

## GLOSSARY

## Ariane – artificial gravity

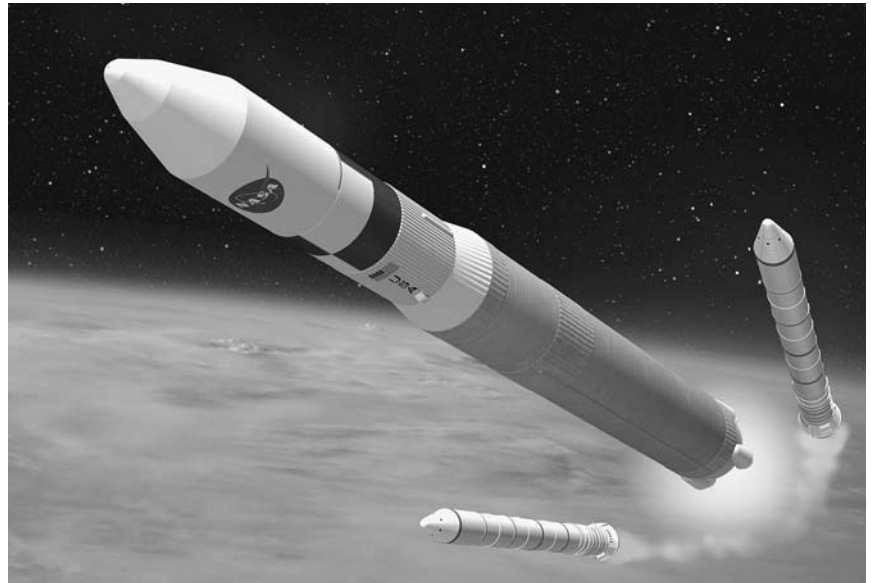

reliable delivery of resources to OUTER SPACE, including the hardware and materials needed to establish a permanent base on the MOON in about 2020. *See also* SECTION IV CHARTS & TABLES.

**Ariane** Family of modern LAUNCH VEHICLES developed by the French Space Agency (CENTRE NATIONAL D'ETUDES SPATIALES or CNES) and the EUROPEAN SPACE AGENCY (ESA). The Ariane 4 ROCKET, Europe's "space workhorse," and the newer, more powerful Ariane 5 rocket have carried many scientific and commercial payloads into orbit from the GUIANA SPACE CENTER in Kourou, French Guiana. The Ariane 5 consists of a powerful LIQUID HYDROGEN/LIQUID OXYGEN-fueled main engine (called the Vulcain) and two strap-on SOLID-PROPELLANT ROCKETS. It is capable of placing a PAYLOAD of approximately 20,000 kg into LOW-EARTH ORBIT (LEO). *See also* SECTION IV CHARTS & TABLES.

**artificial gravity** Simulated GRAVITY conditions established within a SPACECRAFT, SPACE STATION, or SPACE SETTLEMENT. Rotating the space system about an AXIS creates this condition since the CENTRIFUGAL FORCE generated by the rotation produces effects similar to the FORCE of gravity within the vehicle. This technique was first suggested by KONSTANTIN EDUARDOVICH TSIOLKOVSKY at the start of the 20th century.

## Ariane – artificial gravity

- artificial intelligence (AI)** Information-processing functions (including thinking and perceiving) performed by machines that imitate (to some extent) the mental activities performed by the human brain. Advances in AI will allow “very smart” ROBOT SPACECRAFT to explore distant alien worlds with minimal human supervision.
- artificial satellite** A human-made object, such as a SPACECRAFT, placed into ORBIT around EARTH or another CELESTIAL BODY. *SPUTNIK 1* was the first artificial satellite to be placed into orbit around Earth.
- ascending node** That point in the ORBIT of a CELESTIAL BODY when it travels from south to north across a reference plane, such as the equatorial plane of the CELESTIAL SPHERE or the plane of the ECLIPTIC. Also called the *northbound node*. *Compare with* DESCENDING NODE.
- asteroid** A small, solid, rocky object that orbits the SUN but is independent of any major PLANET. Most asteroids (or minor planets) are found in the main ASTEROID BELT. The largest asteroid (now called a DWARF PLANET) is CERES, about 940 km in diameter and discovered in 1801 by GIUSEPPE PIAZZI. EARTH-CROSSING ASTEROIDS or NEAR-EARTH ASTEROIDS (NEAs) have ORBITS that take them near or across EARTH’S orbit around the Sun and are divided into the ATEN, APOLLO, and AMOR GROUPS. *See also* TROJAN GROUP.
- asteroid belt** The region of OUTER SPACE between the ORBITS of MARS and JUPITER that contains the great majority of the ASTEROIDS. These minor planets or planetoids have ORBITAL PERIODS of between three and six years and travel around the SUN at distances of between 2.2 to 3.3 ASTRONOMICAL UNITS (AUs).
- astro-** A prefix that means STAR or (by extension) OUTER SPACE or CELESTIAL; for example, ASTRONAUT, ASTRONAUTICS, or ASTROPHYSICS.
- astrobiology** (*exobiology*) The search for and study of living organisms found on CELESTIAL BODIES beyond EARTH.
- astrobleme** A geologic structure (often eroded) produced by the hypervelocity impact of a METEOROID, COMET, or ASTEROID.
- astrochimp(s)** Nickname given to the primates used in the early U.S. space program to test SPACE CAPSULE and LAUNCH VEHICLE hardware prior to the commitment of this equipment to human missions. *See also* ENOS; HAM.
- astrodynamics** The application of CELESTIAL MECHANICS, PROPULSION SYSTEM theory, and related fields of science and engineering to the problem of carefully planning and directing the TRAJECTORY of a SPACE VEHICLE.



Astrochimp Ham (31 January 1961) (Courtesy of USAF)

**astrolabe** Instrument used by ancient astronomers to measure the ALTITUDE of a STAR.

**astrology** The attempt by many early astronomers to forecast future events on EARTH by observing and interpreting the relative positions of the FIXED STARS, the SUN, the PLANETS, and the MOON. Such mystical stargazing was a common activity in most ancient societies, was enthusiastically practiced in western Europe up through the 17th century, and still lingers today as daily horoscopes. At the dawn of the scientific revolution, GALILEO GALILEI taught a required university course on medical astrology. JOHANNES KEPLER earned a living as a court astrologer. The popular “pseudoscience” of astrology is based on the unscientific hypothesis that the motion of CELESTIAL BODIES controls and influences human lives and terrestrial events. *See also* ZODIAC.

**astrometric binary** A BINARY (DOUBLE) STAR SYSTEM in which irregularities in the PROPER MOTION (wobbling) of a visible STAR imply the presence of an undetected companion.

**astrometry** Branch of ASTRONOMY that involves the very precise measurement of the motion and position of CELESTIAL BODIES.

**astronaut** Within the American space program, a person who travels in OUTER SPACE; a person who flies in an AEROSPACE VEHICLE to an ALTITUDE of more than 80 km (50 mi.). The word comes from a combination of two ancient Greek words that literally mean “STAR” (*astro*) and “sailor or traveler” (*naut*). *Compare with* COSMONAUT.

**astronautics** The branch of engineering science dealing with spaceflight and the design and operation of SPACE VEHICLES.

**Astronomer Royal** The honorary title created in 1675 by King Charles II and given to a prominent British astronomer. Up until 1971, the Astronomer Royal also served as the director of the ROYAL GREENWICH OBSERVATORY. JOHN FLAMSTEED was the first to hold this position, from 1675 to 1719.

**astronomical unit (AU)** A convenient unit of distance defined as the SEMIMAJOR AXIS of EARTH’S ORBIT around the SUN. One AU, the average distance between Earth and the Sun, equals approximately  $149.6 \times 10^6$  km or 499.01 LIGHT-seconds.

**astronomy** The branch of science that deals with CELESTIAL BODIES and studies their size, composition, position, origin, and dynamic behavior. *See also* ASTROPHYSICS; COSMOLOGY.

**astrophotography** The use of photographic techniques to create IMAGES of CELESTIAL BODIES. Astronomers are now replacing LIGHT-sensitive

## astrophysics – atmospheric pressure

photographic emulsions with CHARGE-COUPLED DEVICES (CCDs) to create digital images in the visible, infrared, and ultraviolet portions of the ELECTROMAGNETIC SPECTRUM.

**astrophysics** The branch of physics that investigates the nature of STARS and star systems. It provides the theoretical principles enabling scientists to understand astronomical observations. By using space technology, astrophysicists now place sensitive REMOTE SENSING instruments above EARTH'S ATMOSPHERE and view the UNIVERSE in all portions of the ELECTROMAGNETIC SPECTRUM. High-ENERGY astrophysics includes GAMMA RAY ASTRONOMY, COSMIC RAY ASTRONOMY, and X-RAY ASTRONOMY. *See also* COSMOLOGY.

**Aten group** A collection of NEAR-EARTH ASTEROIDS that cross the ORBIT of EARTH but whose average distances from the SUN lie inside Earth's orbit. This ASTEROID group acquired its name from the 0.9 km diameter asteroid Aten, discovered in 1976 by the American astronomer Eleanor Kay Helin (née Francis).

**Atlas** Family of versatile liquid-fuel ROCKET vehicles originally developed by General BERNARD SCHRIEVER of the United States Air Force in the late 1950s as the first operational American INTERCONTINENTAL BALLISTIC MISSILE (ICBM). Evolved and improved Atlas LAUNCH VEHICLES now serve many government and commercial space transportation needs. *See also* SECTION IV CHARTS & TABLES.

**atmosphere** (1) The gravitationally bound gaseous envelope that forms an outer region around a PLANET or other CELESTIAL BODY.  
(2) (*cabin*) The breathable environment inside a SPACE CAPSULE, AEROSPACE VEHICLE, SPACECRAFT, or SPACE STATION.  
(3) (*Earth's*) The life-sustaining gaseous envelope surrounding EARTH. Near sea level it contains the following composition of gases (by volume): nitrogen 78 percent, oxygen 21 percent, argon 0.9 percent, and CARBON DIOXIDE 0.03 percent. There are also lesser amounts of many other gases, including water vapor and human-generated chemical pollutants. Earth's electrically neutral atmosphere is composed of four primary layers: troposphere, stratosphere, mesosphere, and thermosphere. Life occurs in the troposphere, the lowest region that extends up to about 16 km ALTITUDE. It is also the place within which most of Earth's weather occurs. *See also* SECTION IV CHARTS & TABLES.

**atmospheric pressure** The pressure (FORCE per unit area) at any point in a PLANET'S ATMOSPHERE due solely to the WEIGHT of the atmospheric gases above that point.

## astrophysics – atmospheric pressure

## GLOSSARY



Atlas III rocket (USAF and Lockheed Martin)

## GLOSSARY

## GLOSSARY

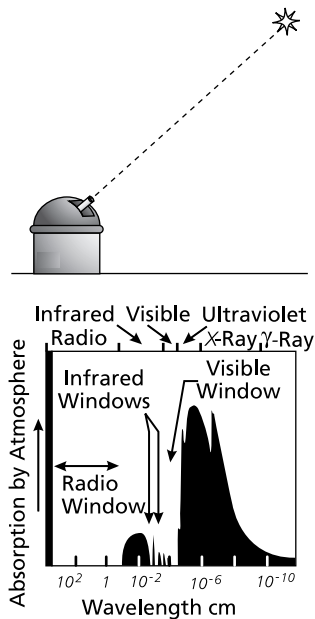

Atmospheric window

## atmospheric probe – atomic weight

**atmospheric probe** The special collection of scientific instruments (usually released by a MOTHER SPACECRAFT) for determining the pressure, composition, and temperature of a PLANET'S ATMOSPHERE at different ALTITUDES. An example is the probe released by NASA'S GALILEO PROJECT SPACECRAFT in December 1995. As it plunged into the Jovian atmosphere, the probe successfully transmitted its scientific data to the *Galileo* spacecraft (the mother spacecraft) for about 58 minutes.

**atmospheric window** A WAVELENGTH interval within which a PLANET'S ATMOSPHERE is transparent to (that is, easily transmits) ELECTROMAGNETIC RADIATION.

**atom** A tiny PARTICLE of matter (the smallest part of an ELEMENT) indivisible by chemical means. It is the fundamental building block of the chemical ELEMENTS. The elements, such as HYDROGEN (H), HELIUM (He), carbon (C), iron (Fe), lead (Pb), and uranium (U), differ from each other because they consist of different types of atoms. According to (much simplified) modern atomic theory, an atom consists of a dense inner core (the NUCLEUS) that contains PROTONS and NEUTRONS, and a cloud of orbiting ELECTRONS. Atoms are electrically neutral, with the number of (positively charged) protons equal to the number of (negatively charged) electrons.

**atomic clock** A precise device for measuring or standardizing time that is based on periodic vibrations of certain ATOMS (cesium) or MOLECULES (ammonia). It is widely used in military and civilian SPACECRAFT, such as, for example, the GLOBAL POSITIONING SYSTEM (GPS).

**atomic mass** The mass of a neutral ATOM of a particular NUCLIDE usually expressed in ATOMIC MASS UNITS (AMU). *See also* MASS NUMBER.

**atomic mass unit** (amu) One-twelfth ( $1/12$ ) the MASS of a neutral ATOM of the most abundant ISOTOPE of carbon, carbon 12.

**atomic number** ( $Z$ ) The number of PROTONS in the NUCLEUS of an ATOM and also its positive charge.

**atomic weight** The MASS of an ATOM relative to other atoms. At present, the most abundant ISOTOPE of the ELEMENT carbon, namely carbon 12, is assigned an atomic weight of exactly 12. As a result,  $1/12$  the mass of a carbon 12 atom is called one ATOMIC MASS UNIT, which is approximately the mass of one PROTON or one NEUTRON. Also called relative atomic mass.

## GLOSSARY

## atmospheric probe – atomic weight

- attenuation** The decrease in intensity (strength) of an electromagnetic wave as it passes through a transmitting medium. This loss is due to absorption of the incident ELECTROMAGNETIC RADIATION (EMR) by the transmitting medium or to scattering of the EMR out of the path of the detector. Attenuation does not include the reduction in EMR wave strength due to geometric spreading as a consequence of the INVERSE SQUARE LAW.
- attitude** The position of an object as defined by the inclination of its AXES with respect to a frame of reference. It is the orientation of a SPACE VEHICLE (for example, a SPACECRAFT or AEROSPACE VEHICLE) that is either in motion or at rest, as established by the relationship between the vehicle's axes and a reference line or plane. Attitude is often expressed in terms of PITCH, ROLL, and YAW.
- attitude control system** The onboard system of computers, low-THRUST ROCKETS (thrusters), and mechanical devices (such as a MOMENTUM wheel) used to keep a SPACECRAFT stabilized during flight and to point its instruments precisely in some desired direction. Stabilization is achieved by spinning the spacecraft or by using a three-axis active approach that maintains the spacecraft in a fixed, reference ATTITUDE by firing a selected combination of thrusters when necessary.
- Aura** A NASA-sponsored EARTH-OBSERVING SPACECRAFT designed to conduct research on the composition, chemistry, and dynamics of EARTH's upper and lower ATMOSPHERE using multiple instruments on a single spacecraft. A DELTA II ROCKET lifted off from VANDENBERG AIR FORCE BASE on 15 July 2004 and successfully placed the spacecraft into a POLAR ORBIT around Earth. *See also AQUA; TERRA.*
- aurora** The visible glow in a PLANET's upper ATMOSPHERE (IONOSPHERE) caused by the interaction of the planet's MAGNETOSPHERE and PARTICLES from the SUN (SOLAR WIND). On EARTH, the aurora borealis (or northern lights) and the aurora australis (or southern lights) are visible manifestations of the magnetosphere's dynamic behavior. At high latitudes, disturbances in Earth's geomagnetic field accelerate trapped particles into the upper ATMOSPHERE, where they excite nitrogen MOLECULES (red emissions) and oxygen ATOMS (red and green emissions). Auroras also occur on JUPITER, SATURN, URANUS, and NEPTUNE.
- auxiliary power unit (APU)** A POWER unit carried on a SPACECRAFT or AEROSPACE VEHICLE that supplements the main source of electric power on the craft.



## GLOSSARY

### axis – ballistic missile defense

- axis** (*plural: axes*) Straight line about which a body rotates (axis of rotation) or along which its CENTER OF GRAVITY moves (axis of translation). Also, one of a set of reference lines for a coordinate system, such as the *x*-axis, *y*-axis, and *z*-axis in the CARTESIAN COORDINATE system.
- azimuth** The horizontal direction or bearing to a CELESTIAL BODY measured in degrees clockwise from north around a terrestrial observer's horizon. On EARTH, azimuth is 0° for an object that is due north, 90° for an object due east, 180° for an object due south, and 270° for an object due west. *See also* ALTITUDE (ASTRONOMY).
- backout** The process of undoing tasks that have already been completed during the COUNTDOWN of a LAUNCH VEHICLE, usually in reverse order.
- Baikonur Cosmodrome** The major LAUNCH SITE for the space program of the former Soviet Union and later the Russian Federation. The complex is located just east of the Aral Sea in Kazakhstan (now an independent republic). Also known as the Tyuratam Launch Site during the COLD WAR, the Soviets launched *SPUTNIK 1* (1957), the first ARTIFICIAL SATELLITE, and COSMONAUT YURI A. GAGARIN, the first human to fly in OUTER SPACE (1961), from this location.
- Baily's beads** An optical phenomenon that appears just before or immediately after totality in a SOLAR ECLIPSE, when sunlight bursts through gaps in the mountains on the MOON and a string of LIGHT beads appears along the LUNAR DISK. FRANCIS BAILY first described this phenomenon in 1836.
- ballistic missile** A MISSILE that is propelled by ROCKET engines and guided only during the initial (THRUST-producing) phase of its flight. In the nonpowered and nonguided phase of its flight, it assumes a BALLISTIC TRAJECTORY similar to that of an artillery shell. After thrust termination, REENTRY VEHICLES (RVs) can be released. These RVs also follow free-falling (ballistic) TRAJECTORIES toward their targets. *Compare with* GUIDED MISSILE.
- ballistic missile defense (BMD)** A proposed defense system designed to protect a territory from incoming BALLISTIC MISSILES and their WARHEAD-carrying REENTRY VEHICLES. A variety of BMD technologies have been suggested, including high-energy laser (HEL) weapons, high-performance interceptor missiles, and KINETIC ENERGY weapon (KEW) systems. However, the BMD problem is technically challenging and can be likened to stopping an incoming high-VELOCITY rifle bullet with another rifle bullet.



Trident ballistic missile  
(U.S. Navy)

## GLOSSARY

### axis – ballistic missile defense

## ballistic trajectory – barred spiral galaxy

## GLOSSARY

**ballistic trajectory** The path an object (that does not have lifting surfaces) follows while being acted upon by only the FORCE of GRAVITY and any resistive AERODYNAMIC FORCES of the medium through which it passes. A stone tossed into the AIR follows a ballistic trajectory. Similarly, after its propulsive unit stops operating, a ROCKET vehicle describes a ballistic trajectory.

**band** A range of (RADIO WAVE) FREQUENCIES. Alternatively, a closely spaced set of SPECTRAL LINES that are associated with the ELECTROMAGNETIC RADIATION (EMR) characteristic of some particular atomic or molecular ENERGY levels.

**bandwidth** The number of HERTZ (cycles per second) between the upper and lower limits of a FREQUENCY band.

**barbecue mode** The slow ROLL of an orbiting AEROSPACE VEHICLE or SPACECRAFT to help equalize its external temperature and to promote a more favorable heat (thermal ENERGY) balance. This maneuver is performed during certain missions. In OUTER SPACE, SOLAR RADIATION is intense on one side of a SPACE VEHICLE while the side opposite the SUN can become extremely cold.

**Barnard's star** A RED DWARF STAR approximately six LIGHT-YEARS from the SUN, making it the fourth-nearest star to the SOLAR SYSTEM. Discovered in 1916 by EDWARD EMERSON BARNARD, it has the largest PROPER MOTION (some 10.3 seconds of arc per year) of any known star.

**barred spiral galaxy** A type of SPIRAL GALAXY that has a bright bar of STARS across the central regions of the GALACTIC NUCLEUS.



Barred spiral galaxy (NGC 1672) (NASA, ESA, and Hubble Heritage Team)

## ballistic trajectory – barred spiral galaxy

## GLOSSARY

## GLOSSARY

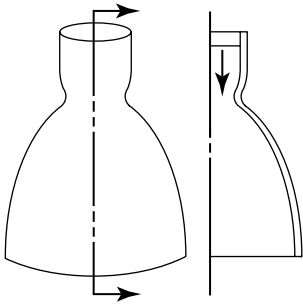

Bell nozzle (courtesy of NASA)

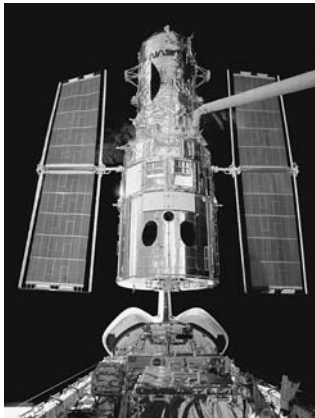

Berthing (NASA)

## GLOSSARY

### barycenter – beta decay

**barycenter** The CENTER OF MASS of a system of masses at which point the total MASS of the system is assumed to be concentrated. In a system of two PARTICLES or two CELESTIAL BODIES (that is, a binary system), the barycenter is located somewhere on a straight line connecting the geometric center of each object but closer to the more massive object. For example, the barycenter for the EARTH-MOON system is located about 4,700 km from the center of Earth—a point actually inside Earth, which has a radius of about 6,400 km.

**basin** (*impact*) A large, shallow, lowland area in the crust of a TERRESTRIAL PLANET formed by the IMPACT of an ASTEROID or COMET.

**baud** (*rate*) A unit of signaling speed. The baud rate is the number of electronic signal changes or data symbols that can be transmitted by a communications channel per second. It is named after J. M. Baudot (1845–1903), a French telegraph engineer.

**beam** A narrow, well-collimated stream of PARTICLES (such as ELECTRONS or PROTONS) or ELECTROMAGNETIC RADIATION (such as GAMMA RAY PHOTONS) that are traveling in a single direction.

**beam rider** A MISSILE guided to its target by a BEAM of ELECTROMAGNETIC RADIATION, such as a radar beam or a laser beam.

**bell nozzle** A NOZZLE with a circular opening for a throat and an axisymmetric contoured wall downstream of the throat that gives this type of nozzle a characteristic bell shape.

**Belt of Orion** The line of three bright STARS (Alnilam, Alnitak, and Mintaka) that form the Belt of Orion, a very conspicuous CONSTELLATION on the EQUATOR of the CELESTIAL SPHERE. It honors the great hunter in Greek mythology.

**Bernal sphere** A large, spherical SPACE SETTLEMENT first proposed by JOHN DESMOND BERNAL in 1929.

**berthing** The joining of two orbiting SPACECRAFT, using a MANIPULATOR or other mechanical device, to move one into contact (or very close proximity) with the other at a selected interface. For example, NASA ASTRONAUTS use the SPACE SHUTTLE'S REMOTE MANIPULATOR SYSTEM to berth a large FREE-FLYING SPACECRAFT (like the *HUBBLE SPACE TELESCOPE*) carefully onto a special support fixture located in the ORBITER'S PAYLOAD BAY during an on-orbit servicing and repair mission. *See also* DOCKING; RENDEZVOUS.

**beta decay** RADIOACTIVITY in which an atomic NUCLEUS spontaneously decays and emits two subatomic PARTICLES: a BETA PARTICLE ( $\beta$ ) and a NEUTRINO ( $\nu$ ). In beta-minus ( $\beta^-$ ) decay, a NEUTRON in

### barycenter – beta decay

the transforming (parent) nucleus becomes a PROTON, and a negative beta particle and an antineutrino are emitted. The resultant (daughter) nucleus has its ATOMIC NUMBER ( $Z$ ) increased by one (thereby changing its chemical properties), while its total ATOMIC MASS ( $A$ ) remains the same as that of the parent nucleus. In beta-plus ( $\beta^+$ ) decay, a proton is converted into a neutron, and a positive beta particle (POSITRON) is emitted along with a neutrino. Here, the atomic number ( $Z$ ) of the resultant (daughter) nucleus is decreased by one—a process that also changes its chemical properties.

**beta particle** ( $\beta$ ) The negatively charged subatomic PARTICLE emitted from the atomic NUCLEUS during the process of BETA DECAY. It is identical to the ELECTRON. *See also* POSITRON.

**big bang** (*theory*) A contemporary theory in COSMOLOGY concerning the origin of the UNIVERSE: It suggests that about 14 billion years ago the initial SINGULARITY experienced a very large explosion. This ancient explosion started space and time of the present universe, which has been expanding ever since. Astrophysical observations, especially the discovery of the COSMIC MICROWAVE BACKGROUND in the early 1960s by ARNO ALLEN PENZIAS and ROBERT WOODROW WILSON, tend to support big bang cosmology.

**big crunch** Within the CLOSED UNIVERSE model of COSMOLOGY, the postulated end state that occurs after the present UNIVERSE expands to its maximum physical dimensions and then collapses in on itself under the influence of GRAVITATION, eventually reaching an infinitely dense end point, or SINGULARITY.

**binary digit** (*bit*) Only two possible values (or digits) are in the binary number system, namely 0 and 1. Binary notation is a common TELEMETRY (information)-encoding scheme that uses binary digits to represent numbers and symbols. For example, digital computers use a sequence of bits, such as an eight-bit-long byte (*binary digit eight*) to create a more complex unit of information.

**binary (double) star system** A pair of STARS that orbit around a common CENTER OF MASS and are bound together by their mutual GRAVITATION.

**biogenic elements** Those ELEMENTS generally considered by scientists (astrobiologists) as essential for all living systems, including HYDROGEN (H), carbon (C), nitrogen (N), oxygen (O), sulfur (S), and phosphorous (P). The availability of the chemical compound water

## GLOSSARY

### biosphere – black hole

(H<sub>2</sub>O) is also considered necessary for life both here on EARTH and possibly elsewhere in the UNIVERSE. *See also* ASTROBIOLOGY.

**biosphere** The life zone of a planetary body; for example, that part of the EARTH SYSTEM inhabited by living organisms. On this PLANET, the biosphere includes portions of the ATMOSPHERE, the HYDROSPHERE, the CRYOSPHERE, and surface regions of the SOLID EARTH. *See also* ECOSPHERE; GLOBAL CHANGE.

**biotelemetry** The remote measurement of life functions. Data from biosensors attached to an ASTRONAUT or COSMONAUT are sent back to EARTH (as TELEMETRY) for the purposes of space-crew health monitoring and evaluation by medical experts and mission managers. For example, biotelemetry allows NASA medical specialists on Earth to monitor an astronaut's heartbeat and respiration rate during strenuous tasks, like performing an EXTRAVEHICULAR ACTIVITY (EVA).

**bipropellant rocket** A ROCKET that uses two unmixed (uncombined) liquid chemicals as its fuel and OXIDIZER, respectively. The two chemical PROPELLANTS flow separately into the rocket's COMBUSTION CHAMBER, where they are combined and combusted to produce high-temperature, THRUST-generating gases. The combustion gases then exit the rocket system through a suitably designed NOZZLE.

**bird** A popular AEROSPACE industry expression (jargon) for a ROCKET, MISSILE, SATELLITE, or SPACECRAFT.

**blackbody** A perfect emitter and perfect absorber of ELECTROMAGNETIC RADIATION. According to PLANCK'S RADIATION LAW, the radiant ENERGY emitted by a BLACKBODY is a function only of the ABSOLUTE TEMPERATURE of the emitting object.

**black box** A unit or subsystem (often involving an electronic device) of a SPACECRAFT or AEROSPACE VEHICLE that is considered only with respect to its input and output characteristics without any specification of its internal elements.

**black dwarf** The cold remains of a WHITE DWARF STAR that no longer emits VISIBLE RADIATION or a nonradiating ball of INTERSTELLAR gas that has contracted under GRAVITATION but contains too little MASS to initiate nuclear FUSION.

**black hole** An incredibly compact, gravitationally collapsed MASS from which nothing (LIGHT, matter, or any other kind of information) can escape. Astrophysicists believe that a black hole is the natural end product when a massive STAR dies and collapses beyond a certain critical

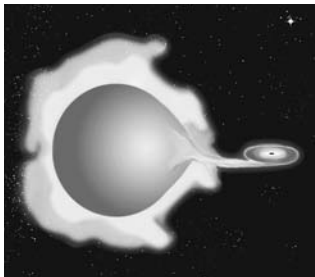

Black hole (right) pulling matter in from its stellar companion (NASA)

## GLOSSARY

### biosphere – black hole

dimension, called the SCHWARZSCHILD RADIUS. Once the massive star shrinks to this critical radius, its gravitational ESCAPE VELOCITY equals the SPEED OF LIGHT, and nothing can escape from it. Inside this radius, called the *event horizon*, lies an extremely dense point mass (SINGULARITY).

- blastoff** The moment a ROCKET or AEROSPACE VEHICLE rises from its LAUNCH PAD under full THRUST. *See also* LIFTOFF.
- blazar** A variable EXTRAGALACTIC object (possibly a high-speed jet from an ACTIVE GALACTIC NUCLEUS) that exhibits very dynamic, sometimes violent behavior. *See also* BL LAC (BL LACERTAE) OBJECT.
- bl lac (bl lacertae) object** A class of EXTRAGALACTIC objects thought to be the active centers of faint ELLIPTICAL GALAXIES that vary considerably in brightness over very short periods of time (typically hours, days, or weeks). Scientists further speculate that a very high-speed (relativistic) jet is emerging from such an object straight at an observer on EARTH.
- blockhouse** (*block house*) A reinforced-concrete structure, often built partially underground, that provides protection against blast, heat, and possibly an ABORT explosion during ROCKET launchings.
- blue giant** A massive, very high LUMINOSITY STAR of SPECTRAL CLASSIFICATION O or B. HYDROGEN-burning blue giants have surface temperatures ranging between 20,000 K and 30,000 K and are located in the upper left-hand portion of the HERTZSPRUNG-RUSSELL (H-R) DIAGRAM. Regulus, a bluish-white star in the CONSTELLATION Leo, is an example. The largest and most luminous blue giants are called *blue supergiants*. Rigel, the brightest star in the constellation Orion, is an example. Astronomers also use the term blue giant to describe a very hot and luminous massive star that has exhausted all its hydrogen thermonuclear fuel and departed the main sequence. *See also* GIANT STAR; MAIN-SEQUENCE STAR; SUPERGIANT STAR.
- blueshift** When a celestial object (like a distant GALAXY) approaches an observer at high VELOCITY, the ELECTROMAGNETIC RADIATION it emits in the visible portion of the SPECTRUM appears shifted toward the blue (higher FREQUENCY, shorter WAVELENGTH) region. *Compare with* REDSHIFT. *See also* DOPPLER SHIFT.
- boiloff** The loss of a CRYOGENIC PROPELLANT, such as LIQUID OXYGEN or LIQUID HYDROGEN, due to vaporization. This happens when the temperature of the cryogenic propellant rises slightly in the PROPELLANT tank of a ROCKET being prepared for LAUNCH. The

**bolide – Byurakan Astrophysical Observatory**

longer a fully fueled rocket vehicle sits on its LAUNCH PAD, the more significant the problem of boiloff becomes.

**bolide** A brilliant METEOR, especially one that explodes into fragments near the end of its TRAJECTORY in EARTH'S ATMOSPHERE.

**Boltzmann constant** (*k*) The physical constant describing the relationship between ABSOLUTE TEMPERATURE and the KINETIC ENERGY of the ATOMS or MOLECULES in a perfect gas. It equals  $1.380653 \times 10^{-23}$  JOULES per KELVIN (J/K) and is named after LUDWIG BOLTZMANN.

**Bond albedo** The fraction of the total ELECTROMAGNETIC RADIATION (such as the total amount of LIGHT) falling upon a nonluminous spherical body that is reflected in all directions by that body. The Bond albedo is measured or calculated over all WAVELENGTHS and is named after GEORGE PHILLIPS BOND.

**booster rocket** A ROCKET motor, with either SOLID or LIQUID PROPELLANT, that assists the main propulsive system (called the sustainer engine) of a LAUNCH VEHICLE during some part of its flight.

**brown dwarf** A very low-LUMINOSITY, substellar (almost a star) CELESTIAL BODY that contains starlike material (that is, HYDROGEN and HELIUM) but has too low a MASS (typically 1 to 10 percent of a SOLAR MASS) to allow its core to initiate thermonuclear FUSION (hydrogen burning).

**bulge of the Earth** The extra extension of EARTH'S EQUATOR, caused by the CENTRIFUGAL FORCE of Earth's ROTATION, which slightly flattens the spherical shape of Earth. This bulge causes the planes of SATELLITE ORBITS inclined to the equator (but not POLAR ORBITS) to rotate slowly around Earth's AXIS.

**burnout** The moment in time or the point in a ROCKET'S TRAJECTORY when combustion of fuels in the engine is terminated. This usually occurs when all the PROPELLANTS are consumed.

**bus** The ROCKET-propelled final stage of an INTERCONTINENTAL BALLISTIC MISSILE (ICBM) that, after booster BURNOUT, places WARHEADS and (possibly) decoys onto BALLISTIC TRAJECTORIES toward their targets. This is also called the postboost vehicle (PBV).

**Byurakan Astrophysical Observatory** The OBSERVATORY located at an ALTITUDE of 1.4 km on Mount Aragatz, near Yerevan, the capital of the Republic of Armenia. The facility was founded in 1946 by VIKTOR AMBARTSUMIAN. It played a major role in the ASTRONOMY activities of the former Soviet Union.

- caldera** A large volcanic depression, more or less circular in form and much larger than the included volcanic vents. A caldera may be formed by three basic geologic processes: explosion, collapse, or erosion. *See also* OLYMPUS MONS.
- calendar** A system of marking days of the YEAR, usually devised in a way to give each date a fixed place in the cycle of seasons. *See also* GREGORIAN CALENDAR; JULIAN CALENDAR.
- calibration** The process of translating the signals collected by a measuring instrument (such as a TELESCOPE) into something that is scientifically useful. The calibration procedure generally removes most of the errors caused by instabilities in the instrument or in the environment through which the signal has traveled.
- Callisto** The second largest MOON of JUPITER and the outermost of the four GALILEAN SATELLITES.
- calorie** (cal) A unit of thermal ENERGY (heat) originally defined as the amount of energy required to raise 1 g of water through 1°C. This energy unit (often called a *small calorie*) is related to the JOULE as follows: 1 cal = 4.186 J. Scientists use the term *kilocalorie* (1,000 small calories) as one *big calorie* when describing the energy content of food.
- Caloris basin** A very large, ringed-impact BASIN (about 1,300 km across) on MERCURY.
- canali** The Italian word for *channels* used by GIOVANNI VIRGINIO SCHIAPARELLI in 1877 to describe natural surface features he observed on MARS. Subsequent pre-space age investigators, including PERCIVAL LOWELL, took the Italian word quite literally as meaning *canals* and sought additional evidence of an intelligent civilization on Mars. Since the 1960s, many SPACECRAFT have visited Mars, dispelling such popular speculations and revealing no evidence of any Martian canals constructed by intelligent beings.
- canard** A horizontal trim and control surface on an AERODYNAMIC VEHICLE.
- cannibalize** The process of taking functioning parts from a nonoperating SPACECRAFT or LAUNCH VEHICLE and installing these salvaged parts into another spacecraft or launch vehicle in order to make the latter operational.
- Cape Canaveral** The region on Florida's east-central coast from which the United States Air Force and NASA have launched more than 3,000 ROCKETS since 1950. Cape Canaveral Air Force Station (CCAFS) is the major East Coast LAUNCH SITE for the Department of Defense,



## GLOSSARY

Cape Canaveral (USAF and NASA)

### capital satellite – carbon cycle



while the adjacent NASA KENNEDY SPACE CENTER is the SPACEPORT for the fleet of SPACE SHUTTLE vehicles.

**capital satellite** A very important or very expensive SATELLITE, distinct from a decoy satellite or a scientific satellite of minimal national security significance. *See also* ANTISATELLITE (ASAT) SPACECRAFT.

**captive firing** The firing of a ROCKET PROPULSION SYSTEM at full or partial THRUST while the rocket is restrained in a test stand facility. Usually, engineers instrument the propulsion system to obtain test data that verify rocket design and demonstrate performance levels. Sometimes called a *holddown test*.

**carbon cycle** (1) (*astrophysics*) The chain of thermonuclear FUSION reactions thought to be the main ENERGY-liberating mechanisms in STARS with interior temperatures much hotter (> 16 million K) than the SUN. In this cycle, HYDROGEN is converted to HELIUM. Large quantities of energy are released, and the ISOTOPE carbon 12 serves as a nuclear reaction catalyst. It is also called the carbon-nitrogen (CN) cycle, the carbon-nitrogen-oxygen (CNO) cycle, or the Bethe-Weizsäcker cycle (named after HANS ALBRECHT BETHE and BARON CARL FRIEDRICH WEIZSÄCKER). *See also* ASTROPHYSICS.

(2) (*Earth system*) The planetary BIOSPHERE cycle that consists of

## GLOSSARY

### capital satellite – carbon cycle

**carbon dioxide (CO<sub>2</sub>) – Cassini-Huygens mission**

**GLOSSARY**

four central biochemical processes: photosynthesis, autotrophic respiration (carbon intake by green plants), aerobic oxidation, and anaerobic oxidation. Scientists believe excessive human activities involving the combustion of fossil fuels, the destruction of forests, and the conversion of wild lands to agriculture may now be causing undesirable perturbations in the planet's overall carbon cycle, thereby endangering important balances within EARTH's highly interconnected biosphere. *See also* EARTH SYSTEM; GLOBAL CHANGE; GREENHOUSE EFFECT.

**carbon dioxide (CO<sub>2</sub>)** A colorless, odorless, noncombustible gas present in EARTH's ATMOSPHERE. Carbon dioxide is formed by the combustion of carbon and carbon compounds, by respiration, and by the gradual oxidation of organic matter in the soil. Carbon dioxide is removed from Earth's atmosphere by green plants (during photosynthesis) and by absorption in the oceans. Unlike Earth, the atmospheres of MARS and VENUS are mostly carbon dioxide.

**cargo bay** The unpressurized middle portion of NASA's SPACE SHUTTLE ORBITER vehicle. *See* PAYLOAD BAY.

**Cartesian coordinates** A coordinate system, developed by the French mathematician René Descartes (1596–1650), in which locations of points in space are expressed by reference to three mutually perpendicular planes, called *coordinate planes*. The three planes intersect in straight lines called the *coordinate axes*. The distances and the AXES are usually marked (*x*, *y*, *z*) and the origin is the (zero) point at which the three axes intersect.

**case** (*rocket*) The structural envelope for the PROPELLANT in a SOLID-PROPELLANT ROCKET motor.

**Cassegrain telescope** A compound REFLECTING TELESCOPE in which a small, convex, secondary mirror reflects the convergent BEAM from the parabolic primary mirror through a hole in the primary mirror to an EYEPIECE in the back of the primary mirror. It was designed by the Frenchman GUILLAUME CASSEGRAIN in 1672.

**Cassini-Huygens mission** The joint NASA-EUROPEAN SPACE AGENCY planetary exploration mission to SATURN launched from CAPE CANAVERAL on 15 October 1997. Since July 2004, the *Cassini* SPACECRAFT has performed detailed studies of Saturn, its RINGS, and MOONS. The *Cassini* MOTHER SPACECRAFT also delivered the *HUYGENS* PROBE, which successfully plunged into the nitrogen-rich ATMOSPHERE of TITAN (Saturn's largest moon) on 14 January 2005. The mother spacecraft is named after the Italian-French astronomer

**carbon dioxide (CO<sub>2</sub>) – Cassini-Huygens mission**

**GLOSSARY**

## GLOSSARY

*Cassini* spacecraft (Rendering courtesy of NASA)

## cavitation – celestial mechanics

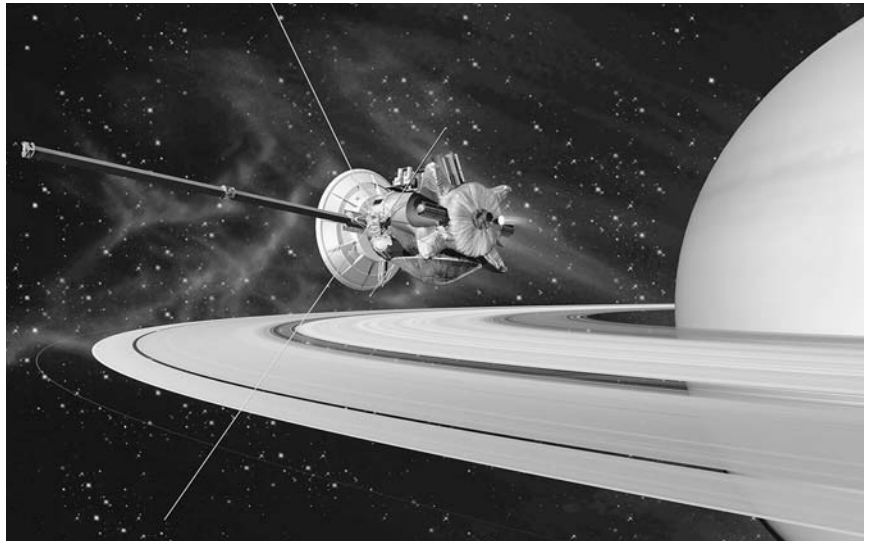

GIOVANNI DOMENICO CASSINI; the Titan probe after the Dutch astronomer CHRISTIAAN HUYGENS.

**cavitation** The formation of bubbles (vapor-filled cavities) in a flowing liquid. The formation of these cavities can adversely impact the performance of high-speed hydraulic machinery, such as the TURBOPUMP SYSTEM of a LIQUID-PROPELLANT ROCKET ENGINE.

**celestial** Of or pertaining to the heavens.

**celestial body** A heavenly body. It is any aggregation of matter in OUTER SPACE constituting a unit for study in ASTRONOMY, such as PLANETS, MOONS, COMETS, ASTEROIDS, STARS, NEBULAS, and GALAXIES.

**celestial latitude** ( $\beta$ ) With respect to the CELESTIAL SPHERE, the angular distance of a CELESTIAL BODY from  $0^\circ$  to  $90^\circ$  north (considered positive) or south (considered negative) of the ECLIPTIC.

**celestial longitude** ( $\lambda$ ) With respect to the CELESTIAL SPHERE, the angular distance of a CELESTIAL BODY from  $0^\circ$  to  $360^\circ$  measured eastward along the ECLIPTIC to the intersection of the body's circle of CELESTIAL LONGITUDE. The VERNAL EQUINOX is taken as  $0^\circ$ .

**celestial mechanics** The scientific study of the dynamic relationships among the CELESTIAL BODIES of the SOLAR SYSTEM. It analyzes the relative motions of objects under the influence of gravitational fields, such as the motion of a MOON or ARTIFICIAL SATELLITE in ORBIT around a PLANET.

## GLOSSARY

## cavitation – celestial mechanics

**celestial sphere** To create a consistent coordinate system for the heavens, early astronomers developed the concept of a celestial sphere. It is an imaginary sphere of very large radius with EARTH as its center and on which all observable CELESTIAL BODIES are assumed projected. The rotational AXIS of Earth intersects the north and south POLES of the celestial sphere. An extension of Earth's equatorial plane cuts the celestial sphere and forms a great circle, called the *celestial equator*. The direction to any STAR or other celestial body can then be plotted in two dimensions on the inside of this imaginary sphere by using the CELESTIAL LATITUDE and the CELESTIAL LONGITUDE.

**Celsius temperature scale** The widely used relative temperature scale, originally developed by ANDERS CELSIUS, in which the range between two reference points (ice at 0° and boiling water at 100°) is now divided into 100 equal units or degrees.

**Centaur** (*rocket*) A powerful and versatile UPPER-STAGE ROCKET originally developed by the United States in the 1950s for use with the ATLAS LAUNCH VEHICLE. Engineered by KRAFFT A. EHRIKKE, it was the first American rocket to use LIQUID HYDROGEN as its PROPELLANT. Centaur has supported many important military and scientific missions, including the CASSINI-HUYGENS MISSION (launched on 15 October 1997) to SATURN.

**Centaur** A group of unusual CELESTIAL OBJECTS residing in the outer SOLAR SYSTEM, such as CHIRON, that exhibit a dual ASTEROID/COMET nature. They are named after the centaurs in Greek mythology, who were half-human and half-horse beings.

**center of gravity** That point in a rigid body at which all the external FORCES appear to act.

**center of mass** The point at which the entire MASS of a body (or system of bodies) appears to be concentrated. For a body (or system of bodies) in a uniform gravitational field, the center of mass coincides with the CENTER OF GRAVITY. *See also* BARYCENTER.

**central force** A FORCE that, for the purposes of computation, can be assumed to be concentrated at one central point with its intensity at any other point being a function of the distance from the central point. For example, GRAVITATION is considered as a central force in CELESTIAL MECHANICS.

**Centre National d'Etudes Spatiales** (CNES) The public body responsible for all aspects of French space activity including LAUNCH VEHICLES and SPACECRAFT. CNES has four main centers: Headquarters (Paris), the Launch Division at Evry, the Toulouse Space Center, and the

GUIANA SPACE CENTER (LAUNCH SITE) in Kourou, French Guiana (South America). *See also* ARIANE; EUROPEAN SPACE AGENCY.

**centrifugal force** A reaction FORCE that is directed opposite to a CENTRIPETAL FORCE such that it points out along the radius of curvature away from the center of curvature.

**centripetal force** The central (inward-acting) FORCE on a body that causes it to move in a curved (circular) path. Consider a person carefully whirling a stone secured by a strong (but lightweight) string in a circular path at a constant speed. The string exerts a radial tug on the stone, which is called the centripetal force. Now as the stone keeps moving in a circle at constant speed, the stone also exerts a reaction force on the string, which is called the CENTRIFUGAL FORCE. It is equal in magnitude but opposite in direction to the centripetal force exerted by the string on the stone.

**Cepheid variable** A type of very bright, SUPERGIANT STAR that exhibits a regular pattern of changing its brightness as a function of time. The period of this pulsation pattern is directly related to the star's intrinsic brightness, so modern astronomers can use Cepheid variables to determine astronomical distances.

**Ceres** The first and largest (940 km diameter) ASTEROID to be found. Ceres was discovered on 1 January 1801 by the Italian astronomer GIUSEPPE PIAZZI. As a result of a decision by the INTERNATIONAL ASTRONOMICAL UNION (IAU), Ceres is now called a DWARF PLANET. *See also* SECTION IV CHARTS & TABLES.

**Cerro Tololo Inter-American Observatory (CTIO)** An astronomical OBSERVATORY at an ALTITUDE of about 2.2 km on Cerro Tololo Mountain in the Chilean Andes near La Serena. The main instrument is a 4 m REFLECTING TELESCOPE. The observatory is operated by the Association of Universities for Research in Astronomy (AURA).

**Challenger accident** NASA'S SPACE SHUTTLE *Challenger* was launched from Complex 39-B at the KENNEDY SPACE CENTER on 28 January 1986 as part of the STS 51-L mission. At approximately 74 seconds into the flight, an explosion occurred that caused the loss of the AEROSPACE VEHICLE and its entire crew, including ASTRONAUTS FRANCIS R. SCOBEE, MICHAEL J. SMITH, ELLISON S. ONIZUKA, JUDITH A. RESNIK, RONALD E. MCNAIR, S. CHRISTA CORRIGAN MCAULIFFE, and GREGORY B. JARVIS.

**Chandrasekhar limit** In the 1920s, SUBRAHMANYAN CHANDRASEKHAR used RELATIVITY theory and QUANTUM MECHANICS to show that if the

## Chandra X-ray Observatory – charge-coupled device

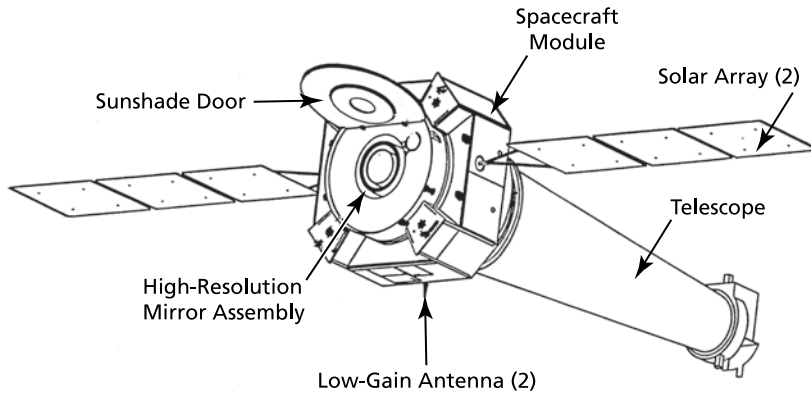

## GLOSSARY

Chandra X-Ray Observatory  
(Courtesy of NASA)

MASS of a DEGENERATE STAR is more than about 1.4 SOLAR MASSES (a maximum mass called the *Chandrasekhar limit*), it will not evolve into a WHITE DWARF star but, rather, it will continue to collapse under the influence of GRAVITY and become a NEUTRON STAR or a BLACK HOLE, or blow itself apart in a SUPERNOVA explosion.

**Chandra X-ray Observatory (CXO)** One of NASA's major orbiting astronomical observatories launched in July 1999 and named after SUBRAHMANYAN CHANDRASEKHAR. NASA previously called this SPACECRAFT the *Advanced X-ray Astrophysics Facility (AXAF)*. The EARTH-orbiting facility studies some of the most interesting and puzzling X-RAY sources in the UNIVERSE, including emissions from ACTIVE GALACTIC NUCLEI, exploding STARS, NEUTRON STARS, and matter falling into BLACK HOLES. *See also* GREAT OBSERVATORIES PROGRAM.

**chaos** The branch of physics (mechanics) that studies unstable systems.

**chaotic orbit** The ORBIT of a CELESTIAL BODY that changes in a highly unpredictable manner, usually when a small object, such as an ASTEROID or COMET, passes close to a massive PLANET (like SATURN or JUPITER) or the SUN. For example, the chaotic orbit of CHIRON is influenced by both URANUS and Saturn.

**chaotic terrain** A planetary surface feature (first observed on MARS in 1969) characterized by a jumbled, irregular assembly of fractures and blocks of rock.

**charge-coupled device (CCD)** An electronic (solid-state) device containing a regular array of SENSOR elements that are sensitive to various types of

## Chandra X-ray Observatory – charge-coupled device

## GLOSSARY

ELECTROMAGNETIC RADIATION (for example, LIGHT) and emit ELECTRONS when exposed to such radiation. The emitted electrons are collected and the resulting charge analyzed. CCDs are used as the light-detecting component in modern television cameras and TELESCOPES.

**charged particle** An ION; an elementary PARTICLE that carries a positive or negative electric charge, such as an ELECTRON, a PROTON, or an ALPHA PARTICLE.

**Charon** The major MOON of the DWARF PLANET PLUTO. Charon was discovered in 1978 by the American astronomer James Walter Christy. The icy moon has a diameter of about 1,300 km and travels in a tidally locked ORBIT around Pluto with a PERIOD of 6.4 days at a mean distance of approximately 20,000 km. *HUBBLE SPACE TELESCOPE* images taken in 2005 revealed that two other tiny moons (named Nix and Hydra) also orbit Pluto. Scientists anticipate gathering much more data about Pluto and Charon, when NASA's *New Horizons* SPACECRAFT flies past them in 2015. *See also* NEW HORIZONS PLUTO–KUIPER BELT FLYBY MISSION.

**chaser spacecraft** The SPACECRAFT or AEROSPACE VEHICLE that actively performs the key maneuvers during orbital RENDEZVOUS and DOCKING/BERTHING operations. The other SPACE VEHICLE serves as the target and remains essentially passive during the ENCOUNTER.

**chasma** (plural: chasmata) A canyon or deep linear feature on a PLANET'S surface.

**checkout** The sequence of actions (such as functional, operational, and calibration tests) performed to determine the readiness of a SPACECRAFT or LAUNCH VEHICLE to carry out its intended mission.

**chemical rocket** A ROCKET that uses the combustion of a chemical fuel in either solid or liquid form to generate THRUST. The chemical fuel requires an OXIDIZER to support combustion.

**chilldown** Cooling all or part of a cryogenic (very cold) ROCKET engine system from ambient (room) temperature down to cryogenic temperature by circulating CRYOGENIC PROPELLANT (fluid) through the system prior to engine start.

**Chiron** An unusual CELESTIAL BODY in the outer SOLAR SYSTEM with a CHAOTIC ORBIT that lies almost entirely between the ORBITS of SATURN and URANUS. This massive ASTEROID-sized object has a diameter of about 200 km and is the first object placed into the CENTAURS group because it also has a detectable COMA, a feature characteristic of COMETS.

- choked flow** A flow condition in a duct or pipe such that the flow upstream of a certain critical section (like a NOZZLE or valve) cannot be increased by further reducing downstream pressure.
- chromatic aberration** A phenomenon that occurs in a refracting optical system because LIGHT of different WAVELENGTHS (COLORS) is refracted (bent) by a different amount. As a result, a simple LENS will give red light a longer FOCAL LENGTH than blue light.
- chromosphere** The reddish layer in the SUN'S ATMOSPHERE located between the PHOTOSPHERE (the apparent SOLAR surface) and the base of the CORONA. It is the source of solar PROMINENCES.
- Chryse Planitia** (Plains of Gold) A large plain on MARS characterized by many ancient channels that could have once contained flowing surface water. This region was the landing site for NASA'S VIKING I LANDER SPACECRAFT in July 1976.
- chugging** A form of combustion instability that occurs in a LIQUID-PROPELLANT ROCKET ENGINE. It is characterized by a pulsing operation at a fairly low FREQUENCY.
- circadian rhythms** A biological organism's day/night cycle of living; a regular change in physiological function occurring in approximately 24-hour cycles.
- circumsolar space** Around the SUN or HELIOCENTRIC (Sun-centered) space.
- circumstellar** Around a STAR, as opposed to *interstellar*, which means between the stars.
- cislunar** Of or pertaining to phenomena, projects, or activities happening in the region of OUTER SPACE between EARTH and the MOON. It comes from the Latin word *cis*, meaning "on this side" and *lunar*, which means "of or pertaining to the Moon." Therefore, it means "on this side of the Moon."
- Clarke orbit** A GEOSTATIONARY ORBIT, named after SIR ARTHUR C. CLARKE, who first proposed in 1945 the use of this special ORBIT around EARTH for COMMUNICATIONS SATELLITES.
- clean room** A controlled work environment for SPACECRAFT and AEROSPACE systems in which dust, temperature, and humidity are carefully controlled during the fabrication, assembly, and/or testing of critical components.
- closed universe** The model in COSMOLOGY that assumes the total MASS of the UNIVERSE is sufficiently large that one day the GALAXIES will slow down and stop expanding because of their mutual gravitational



attraction. At that time, the universe will have reached its maximum size. Then GRAVITATION will make it slowly contract, ultimately collapsing to a single point of infinite DENSITY (sometimes called the BIG CRUNCH). Also called *bounded-universe model*. Compare with OPEN UNIVERSE.

**cluster of galaxies** An accumulation of GALAXIES that lie within a few million LIGHT-YEARS of each other and are bound by GRAVITATION. Galactic clusters can occur with just a few member galaxies (say 10 to 100), such as the LOCAL GROUP, or they can occur in great groupings involving thousands of galaxies.

**cold-flow test** The thorough testing of a LIQUID-PROPELLANT ROCKET ENGINE without actually firing (igniting) it. This type of test helps AEROSPACE engineers verify the performance and efficiency of a PROPULSION SYSTEM since all aspects of PROPELLANT flow and conditioning, except combustion, are examined. Tank pressurization, propellant loading, and propellant flow into the COMBUSTION CHAMBER (without ignition) are usually included in a cold-flow test. Compare with HOT-FIRE TEST.

**cold war** The ideological conflict between the United States and the former Soviet Union from approximately 1946–89, involving rivalry, mistrust, and hostility just short of overt military action. The tearing down of the Berlin Wall in November 1989 is generally considered as the symbolic end of the cold war period.

**collimator** A device for focusing or confining a BEAM OF PARTICLES OR ELECTROMAGNETIC RADIATION, such as X-RAY PHOTONS.

**color** A quality of LIGHT that depends on its WAVELENGTH. The *spectral color* of emitted light corresponds to its place in the SPECTRUM of the rainbow. *Visual light* or *perceived color* is the quality of light emission as recognized by the human eye. Simply stated, the human eye contains three basic types of light-sensitive cells that respond in various combinations to incoming spectral colors. For example, the color brown occurs when the eye responds to a particular combination of blue, yellow, and red light. Violet light has the shortest wavelength, while red light has the longest wavelength. All the other colors have wavelengths that lie in between.

***Columbia* accident** While gliding back to EARTH on 1 February 2003, after a successful 16-day scientific research mission in LOW EARTH ORBIT, NASA'S SPACE SHUTTLE *Columbia* experienced a catastrophic REENTRY accident and broke apart at an ALTITUDE of about 63 km

over Texas. The STS 107 mission disaster claimed the lives of six American ASTRONAUTS (Rick D. Husband, William C. McCool, Michael P. Anderson, Kalpana Chawla, Laurel Blair Salton Clark, and David M. Brown) and the first Israeli astronaut (Ilan Ramon). Post-accident investigations indicate that a severe heating problem occurred in *Columbia*'s left wing, as a result of structural damage from debris impact during LAUNCH.

**coma** The gaseous envelope that surrounds the NUCLEUS of a COMET.

**combustion chamber** The part of a ROCKET engine in which the combustion of chemical PROPELLANTS takes place at high pressure. The combustion chamber and the diverging section of the NOZZLE make up a rocket's THRUST chamber. It is sometimes called the firing chamber or simply the chamber.

**comet** A dirty ice "rock" consisting of dust, frozen water, and gases that orbits the SUN. As a comet approaches the inner SOLAR SYSTEM from deep space, solar radiation causes its frozen materials to vaporize (sublime), creating a COMA and two long TAILS of dust and IONS, called Type I (PLASMA) and Type II (dust). Scientists think these icy PLANETESIMALS are the remainders of the primordial material from which the OUTER PLANETS were formed billions of years ago. *See also* KUIPER BELT; OORT CLOUD.

**Comet Halley** (*1P/Halley*) The most famous PERIODIC COMET. Named after EDMOND HALLEY, who successfully predicted its 1758 return. Reported since 240 B.C.E., this COMET reaches PERIHELION approximately every 76 years. During its most recent inner SOLAR SYSTEM appearance, an international fleet of five different SPACECRAFT, including the *GIOTTO* SPACECRAFT, performed scientific investigations that supported the dirty ice rock model of a comet's NUCLEUS.

**command destruct** An intentional action leading to the destruction of a ROCKET or MISSILE in flight. Whenever a malfunctioning vehicle's performance creates a safety hazard on or off the rocket test range, the range safety officer sends the command destruct signal to destroy it.

**communications satellite** A SATELLITE that relays or reflects electromagnetic signals between two (or more) communications stations. An *active communications satellite* receives, regulates, and retransmits electromagnetic signals between stations, while a *passive communications satellite* simply reflects signals between stations. In 1945, SIR ARTHUR C. CLARKE proposed placing

## GLOSSARY

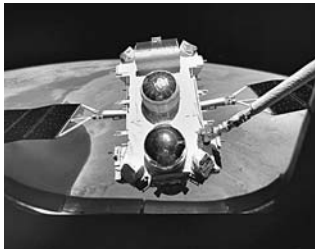

Compton Gamma Ray Observatory (NASA)

### compact body – conic section

communications satellites into GEOSTATIONARY ORBIT around EARTH. Numerous active communications satellites now maintain a global TELECOMMUNICATIONS infrastructure.

**compact body** A small, very dense CELESTIAL BODY that represents the end product of STELLAR EVOLUTION: a WHITE DWARF, a NEUTRON STAR, or a BLACK HOLE.

**companion body** A NOSE CONE, protective shroud, last-stage ROCKET, or PAYLOAD separation hardware that ORBITS EARTH along with an operational SATELLITE or SPACECRAFT. Companion bodies contribute significantly to a growing SPACE (ORBITAL) DEBRIS population in LOW EARTH ORBIT.

**compressible flow** Flow conditions in which DENSITY changes in the fluid cannot be neglected.

**Compton Gamma Ray Observatory (CGRO)** A major NASA orbiting astrophysical OBSERVATORY dedicated to GAMMA RAY ASTRONOMY. The *CGRO* was placed into ORBIT around EARTH in April 1991. At the end of its useful scientific mission, flight controllers intentionally commanded the massive (16,300 kg) SPACECRAFT to perform a DE-ORBIT BURN. This caused it to reenter and safely crash in June 2000 in a remote region of the Pacific Ocean. The spacecraft was named in honor of ARTHUR HOLLY COMPTON.

**Compton scattering (Compton effect)** The scattering of energetic PHOTONS (either X-RAY or GAMMA RAY) by ELECTRONS. In this process, the electron gains ENERGY and recoils. The scattered photon changes direction while losing some of its energy and increasing in WAVELENGTH. First observed in 1923 by ARTHUR HOLLY COMPTON, this phenomenon demonstrated that photons have MOMENTUM. It has proven very useful in gamma ray detection.

**concave lens (or mirror)** A LENS or mirror with an inward curvature.

**conduction (thermal)** The transport of heat (thermal ENERGY) through an object by means of a temperature difference from a region of higher temperature to a region of lower temperature. For solids and liquid metals, thermal conduction is accomplished by the migration of fast-moving ELECTRONS, while atomic and molecular collisions support thermal conduction in gases and other liquids. *Compare with* CONVECTION.

**conic section** A curve formed by the intersection of a plane and a right circular cone. Also called *conic*. The conic sections are the ELLIPSE,

### compact body – conic section

## GLOSSARY

## conjunction – console

the *parabola*, and the *hyperbola*—all curves that describe the paths of bodies moving in space. The *circle* is simply an ellipse with an ECCENTRICITY of zero.

**conjunction** The alignment of two bodies in the SOLAR SYSTEM so that they have the same CELESTIAL LONGITUDE as seen from EARTH (that is, when they appear closest together in the sky). For example, a SUPERIOR PLANET forms a *superior conjunction* when the SUN lies between it and Earth. An INFERIOR PLANET (either VENUS or MERCURY) forms an *inferior conjunction* when it lies directly between the Sun and Earth and a *superior conjunction* when it lies directly behind the Sun.

**conservation of angular momentum** The principle of physics that states that absolute ANGULAR MOMENTUM is a property that cannot be created or destroyed but can only be transferred from one physical system to another through the action of a net torque on the system. As a consequence, the total angular momentum of an isolated system remains constant.

**conservation of energy** The principle of physics that states that the total ENERGY of an isolated system remains constant if no interconversion of MASS and energy takes place within the system. It is also called the first law of thermodynamics.

**conservation of mass and energy** From special RELATIVITY and ALBERT EINSTEIN's famous MASS-ENERGY equivalence formula ( $E = \Delta mc^2$ ), this conservation principle states that for an isolated system, the sum of the mass and energy remains constant, although interconversion of mass and energy can occur within the system.

**conservation of momentum** The principle of physics that states that in the absence of external FORCES, absolute MOMENTUM is a property that cannot be created or destroyed. Consequently, the total momentum of an isolated system remains constant. *See also* NEWTON'S LAWS OF MOTION.

**console** A desklike array of controls, indicators, and video display devices for monitoring and controlling AEROSPACE operations, such as the CHECKOUT, COUNTDOWN, and LAUNCH of a ROCKET. During the critical phases of a space mission, the console becomes the central place from which to issue commands to or at which to display information concerning an AEROSPACE VEHICLE, a deployed PAYLOAD, an EARTH-orbiting SPACECRAFT, or a PLANETARY PROBE. The mission control center generally contains clusters of consoles (each assigned to specific monitoring and control tasks). Depending on the nature and

## conjunction – console

## GLOSSARY

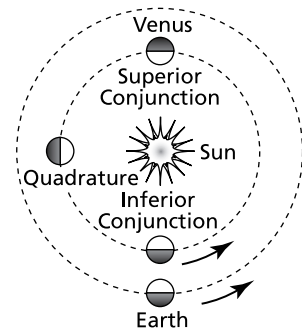

Conjunction

## GLOSSARY

## GLOSSARY



Republic of San Marino stamp depicting the constellation Taurus (the author)

## constellation – convection

duration of a particular space mission, operators will remain at their consoles continuously or work there only intermittently.

**constellation** (1) (*aerospace*) A term used to describe collectively the number and orbital disposition of a set of SATELLITES, such as the constellation of GLOBAL POSITIONING SYSTEM satellites.  
(2) (*astronomy*) An easily identifiable configuration of the brightest STARS in a moderately small region of the night sky. Originally, constellations, such as Orion the Hunter and Ursa Major (the Great Bear), were named by early astronomers after heroes and creatures from various ancient cultures and mythologies.

**Constellation Program** The NASA program to develop the next generation of space transportation infrastructure in support of human spaceflight by the United States. The program includes the ARES I crew LAUNCH VEHICLE, the ARES V cargo launch vehicle, and the *ORION* crew exploration vehicle. As currently envisioned by NASA, these advanced transportation systems will safely and reliably carry human explorers back to the MOON (in about 2020) and then onward to MARS (in about 2030) and other destinations in the SOLAR SYSTEM. *See also* SECTION IV CHARTS & TABLES.

**continuously crewed spacecraft** A SPACECRAFT that has accommodations for continuous habitation (human occupancy) during its mission. The *INTERNATIONAL SPACE STATION (ISS)* is an example. It is sometimes (though not preferably) called a *continuously manned spacecraft*.

**continuously habitable zone (CHZ)** The region around a STAR in which one or several PLANETS (or possibly their MOONS) can maintain conditions appropriate for the emergence and sustained existence of life. One important characteristic of a planet in the CHZ is that its environmental conditions support the retention of significant amounts of liquid water on the planetary surface. Sometimes called the *Goldilocks Zone*.

**control rocket** A low-THRUST ROCKET, such as a RETROROCKET or a VERNIER ENGINE, used to guide, to change the ATTITUDE of, or to make small corrections in the velocity of an AEROSPACE VEHICLE, SPACECRAFT, or EXPENDABLE LAUNCH VEHICLE.

**convection** (*thermal*) The transfer of heat (thermal ENERGY) brought about by the mass motion and mixing of a fluid. Because the DENSITY of a MASS (glob) of heated fluid is lower than the surrounding cooler fluid, it rises (*natural convection*). When cooled, the glob will sink as its density increases slightly. Pumps and fans promote *forced convection* when a mass of warmer fluid is driven through or across

## GLOSSARY

## constellation – convection

cooler surfaces or a mass of cooler fluid is driven across warmer surfaces.

**converging-diverging (CD) nozzle** A THRUST-producing flow device for expanding and accelerating hot exhaust gases from a ROCKET engine. A properly designed NOZZLE efficiently converts the thermal ENERGY of combustion into KINETIC ENERGY of the combustion product gases. In a supersonic CONVERGING-DIVERGING NOZZLE, the hot gas upstream of the nozzle throat is at subsonic VELOCITY (that is, the MACH NUMBER ( $M$ )  $< 1$ ), reaches sonic velocity (the speed of sound, for which  $M = 1$ ) at the throat of the nozzle, and then expands to supersonic velocity ( $M > 1$ ) downstream of the nozzle throat region while flowing through the diverging section of the nozzle. *See also* DE LAVAL NOZZLE.

**converging lens (or mirror)** A LENS (or mirror) that refracts (or reflects) a parallel beam of light, making it converge at a point (called the principal focus). A converging mirror is a concave mirror, while a converging lens is generally a CONVEX LENS that is thicker in the middle than at its edges. *Compare with* DIVERGING LENS. *See also* CONCAVE LENS.

**convex lens (or mirror)** A LENS or mirror with an outward curvature. Compare with CONCAVE LENS.

**cooperative target** A three-axis, stabilized, orbiting object that has signaling devices to support RENDEZVOUS and DOCKING/capture operations by a CHASER SPACECRAFT.

**co-orbital** Sharing the same or very similar ORBIT. For example, during a RENDEZVOUS operation, the CHASER SPACECRAFT and its COOPERATIVE TARGET are said to be co-orbital.

**coordinated universal time** *See* UNIVERSAL TIME COORDINATED.

**Copernican system** The theory of planetary motions, proposed by NICHOLAS COPERNICUS, in which all PLANETS (including EARTH) move in *circular* ORBITS around the SUN, with the planets closer to the Sun moving faster. In this system, the hypothesis of which helped trigger the scientific revolution of the 16th and 17th centuries, Earth was viewed not as an immovable object at the center of the UNIVERSE (as in the GEOCENTRIC PTOLEMAIC SYSTEM) but rather as a planet orbiting the Sun between VENUS and MARS. Early in the 17th century, JOHANNES KEPLER showed that while Copernicus's HELIOCENTRIC hypothesis was correct, the PLANETS actually moved in (slightly) ELLIPTICAL ORBITS around the Sun.

- Copernicus Observatory** A scientific SPACECRAFT launched into ORBIT around EARTH by NASA on 21 August 1972. Also called the *Orbiting Astronomical Observatory-3 (OAO-3)* and named in honor of NICHOLAS COPERNICUS, this space-based observatory examined the UNIVERSE in the ULTRAVIOLET RADIATION portion of the ELECTROMAGNETIC (EM) SPECTRUM from 1972 to 1981. *See also* ULTRAVIOLET ASTRONOMY.
- core** (1) (*planetary*) The high-DENSITY, central region of a PLANET. (2) (*stellar*) The very high-temperature, central region of a STAR. FOR MAIN SEQUENCE STARS, FUSION processes within the core burn HYDROGEN. For stars that have left the main sequence, nuclear fusion processes in the core involve HELIUM and oxygen.
- corona** The outermost region of a STAR. The SUN's corona consists of low-DENSITY clouds of very hot gases (> 1 million K) and ionized materials.
- coronal mass ejection (CME)** A high-speed (10 to 1,000 km/s) ejection of matter from the SUN's CORONA. A CME travels through space disturbing the SOLAR WIND and giving rise to GEOMAGNETIC STORMS when the disturbance reaches EARTH.
- cosmic** Of or pertaining to the UNIVERSE, especially that part outside EARTH's ATMOSPHERE. This term frequently appears in the Russian (former Soviet Union) space program as the equivalent to *space* or ASTRO-, such as cosmic station (versus SPACE STATION) or COSMONAUT (versus ASTRONAUT).
- Cosmic Background Explorer (COBE)** A NASA SPACECRAFT placed into ORBIT around EARTH in November 1989. It successfully measured the SPECTRUM and intensity distribution of the COSMIC MICROWAVE BACKGROUND (CMB). *See also* WILKINSON MICROWAVE ANISOTROPY PROBE.
- cosmic microwave background (CMB)** The background of MICROWAVE RADIATION that permeates the UNIVERSE and has a BLACKBODY temperature of about 2.7 K. Sometimes called the *primal glow*, scientists believe it represents the remains of the ancient fireball in which the universe was created. *See also* BIG BANG.
- cosmic ray astronomy** The branch of high-ENERGY ASTROPHYSICS that uses COSMIC RAYS to provide information on the origin of the chemical ELEMENTS through NUCLEOSYNTHESIS during stellar explosions.
- cosmic rays** Extremely energetic PARTICLES (usually bare atomic NUCLEI) that move through OUTER SPACE at speeds just below the SPEED OF

LIGHT and bombard EARTH from all directions. Their existence was discovered in 1912 by VICTOR FRANCIS HESS. HYDROGEN nuclei (PROTONS) make up the highest proportion of the cosmic ray population (approximately 85 percent), but these particles range over the entire periodic table of ELEMENTS. *Galactic cosmic rays* are samples of material from outside the SOLAR SYSTEM and provide direct evidence of phenomena that occur as a result of explosive processes in STARS throughout the MILKY WAY GALAXY. *Solar cosmic rays* (mostly protons and ALPHA PARTICLES) are ejected from the SUN during SOLAR FLARE events.

**cosmological principle** The hypothesis that the expanding UNIVERSE is ISOTROPIC and homogeneous. In other words, there is no special location for observing the universe, and all observers anywhere in the universe would see the same recession of distant GALAXIES.

**cosmology** The study of the origin, evolution, and structure of the UNIVERSE. Contemporary cosmology centers around the BIG BANG hypothesis—a theory stating that about 14 billion ( $10^9$ ) years ago the universe began in a great explosion and has been expanding ever since. In the OPEN UNIVERSE model, scientists postulate that the universe is infinite and will continue to expand forever. In the CLOSED UNIVERSE model, the total MASS of the universe is assumed sufficiently large to eventually stop its expansion and then start its contraction under the influence of GRAVITATION, leading ultimately to a BIG CRUNCH. In the *flat universe model*, the expansion gradually comes to a halt. Instead of collapsing, however, the universe achieves an equilibrium condition with expansion FORCES precisely balancing the contraction forces of gravitation. Starting in 1998, astronomical observations of very distant SUPERNOVAS yielded data indicating that the expansion of the universe is actually accelerating. Astrophysicists have called this mysterious gravitationally repulsive phenomenon, which is responsible for the apparent increase in the rate of expansion of empty space, DARK ENERGY.

**cosmonaut** The title given by Russia (formerly the Soviet Union) to its space travelers. Equivalent to ASTRONAUT.

**Cosmos spacecraft** The general name given to a large number of Soviet and later Russian SPACECRAFT, ranging from MILITARY SATELLITES to scientific platforms investigating near-EARTH space. *Cosmos 1* was launched in March 1962. Since then, well over 2,000 Cosmos satellites have been sent into OUTER SPACE. Also called *Kosmos*.



- countdown** The step-by-step process that leads to the LAUNCH of a ROCKET or AEROSPACE VEHICLE. A countdown takes place in accordance with a specific schedule—with zero being the go or activate time.
- Crab Nebula** The SUPERNOVA remnant of an exploding STAR observed in 1054 C.E. by Chinese astronomers. Called M1 in the MESSIER CATALOGUE, it is about 6,500 LIGHT-YEARS away in the CONSTELLATION Taurus and contains a PULSAR that flashes optically.
- crater** A bowl-shaped topographic depression with steep slopes on the surface of a PLANET or MOON. There are two general types: *impact crater* (formed by an ASTEROID, COMET, or METEOROID strike) and *eruptive* (formed when a VOLCANO erupts).
- crew-tended spacecraft** A SPACECRAFT that is visited and/or serviced by ASTRONAUTS but can provide only temporary accommodations for human habitation during its overall mission. It is sometimes referred to as a *man-tended spacecraft*. Compare with CONTINUOUSLY CREWED SPACECRAFT.
- critical mass density** *See* DENSITY PARAMETER.
- critical point** The highest temperature at which the liquid and vapor phases of a fluid can coexist. The temperature and pressure corresponding to this point (thermodynamic state) are called the fluid's *critical temperature* and *critical pressure*, respectively.
- cruise phase** For a scientific SPACECRAFT on an INTERPLANETARY mission, the part of the mission (usually months or even years in duration) following LAUNCH and prior to planetary ENCOUNTER.
- crust** The outermost solid layer of a PLANET or MOON.
- cryogenic propellant** A ROCKET fuel, oxidizer, or propulsion fluid that is liquid only at very low (cryogenic) temperatures. LIQUID HYDROGEN (LH<sub>2</sub>) and LIQUID OXYGEN (LO<sub>2</sub> or LOX) are examples.
- cryosphere** The portion of EARTH's climate system consisting of the world's ice masses and snow deposits. *See also* EARTH SYSTEM.
- cutoff** The act of shutting off the PROPELLANT flow in a ROCKET or of stopping the combustion of the propellant. *Compare with* BURNOUT.
- Cygnus X-1** The strong X-RAY source in the CONSTELLATION Cygnus that scientists believe comes from a BINARY (DOUBLE) STAR SYSTEM, consisting of a SUPERGIANT star orbiting and a BLACK HOLE companion. Gas drawn off the supergiant star emits X-rays as it is intensely heated while falling into the black hole.

- Dactyl** A natural SATELLITE of the ASTEROID Ida, discovered in February 1994 when NASA scientists were reviewing GALILEO PROJECT SPACECRAFT data from a FLYBY encounter with the asteroid on 28 August 1993. This tiny MOON (about 1.2 km × 1.4 km × 1.6 km) is the first to be discovered.
- dark energy** The generic name given by scientists to the unknown cosmic FORCE that appears to be responsible for the observed acceleration of the expansion of the UNIVERSE. In their effort to reconcile recent astrophysical data, scientists speculate that dark energy is neither matter nor ENERGY (as currently understood in physics), but somehow exerts an overall repulsive effect on the universe, causing empty space to expand. The mysterious phenomenon is one of the leading puzzles in contemporary ASTRONOMY and ASTROPHYSICS. *See also* COSMOLOGY.
- dark matter** Matter in the UNIVERSE that cannot be observed directly because it emits very little or no ELECTROMAGNETIC RADIATION. Scientists infer its existence through secondary phenomena such as gravitational effects and suggest that it may make up about 90 percent of the total MASS of the universe. Also called *missing mass*. *See* COSMOLOGY.
- dark nebula** A cloud of INTERSTELLAR dust and gas sufficiently dense and thick that the LIGHT from more distant STARS and CELESTIAL BODIES (behind it) is obscured. The HORSEHEAD NEBULA in the CONSTELLATION Orion is an example of a dark nebula.
- Dawn mission** The goal of NASA's Dawn mission, LAUNCHED on 27 September 2007 from CAPE CANAVERAL, is to understand the conditions and processes during the earliest history of our SOLAR SYSTEM. Using ION ENGINES for propulsion, the *Dawn* SPACECRAFT will RENDEZVOUS with and ORBIT two interesting PROTOPLANET objects in the ASTEROID BELT: the large ASTEROID VESTA (during 2011-12) and the DWARF PLANET CERES (in 2015). Instruments on the ROBOT SPACECRAFT will investigate the structure and composition of these two CELESTIAL BODIES, which have many contrasting characteristics and appear to have remained intact since their formation more than 4.6 billion years ago.
- de-boost** A retrograde (opposite-direction) burn of one or more low-THRUST ROCKETS or an AEROBRAKING maneuver that lowers the ALTITUDE of an orbiting SPACECRAFT.
- debris** JETTISONED human-made materials, discarded LAUNCH VEHICLE components, and derelict or nonfunctioning SPACECRAFT in ORBIT around EARTH. *See also* SPACE (ORBITAL) DEBRIS.

## GLOSSARY



Deep Space Network (Digital image courtesy of NASA/JPL)

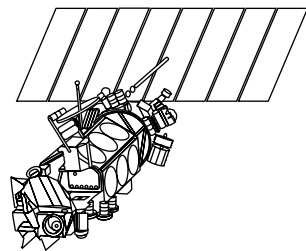

Defense Meteorological Satellite Program

## GLOSSARY

### decay – Defense Support Program

- decay** (1) (*orbital*) The gradual lessening of both the APOGEE and PERIGEE of an orbiting object from its PRIMARY BODY. For example, the orbital decay process for ARTIFICIAL SATELLITES and DEBRIS often results in their ultimate fiery plunge back into the denser regions of EARTH'S ATMOSPHERE.
- (2) (*radioactive*) The spontaneous transformation of one radionuclide into a different NUCLIDE or into a different ENERGY state of the same nuclide. This natural process results in a decrease (with time) of the number of original radioactive ATOMS in a sample and involves the emission from the NUCLEUS of ALPHA PARTICLES, BETA PARTICLES, or GAMMA RAYS. *See also* RADIOACTIVITY; RADIOISOTOPE.

**declination** ( $\delta$ ) For a CELESTIAL BODY viewed on the CELESTIAL SPHERE, the angular distance north ( $0^\circ$  to  $90^\circ$  positive) or south ( $0^\circ$  to  $90^\circ$  negative) of the celestial equator.

**Deep Impact mission** The objectives of NASA's Deep Impact mission were to rendezvous with Comet P/Tempel 1 and launch a massive projectile into the COMET'S NUCLEUS. On 4 July 2005, the *Deep Impact* SPACECRAFT successfully encountered the target comet and instruments on the MOTHER SPACECRAFT observed the ejecta caused by the impacting projectile.

**Deep Space Network (DSN)** NASA's global network of ANTENNAS that serve as the RADIO WAVE communications link to distant INTERPLANETARY SPACECRAFT and PROBES, transmitting instructions to them and receiving data from them. Large radio antennas of the DSN's three Deep Space Communications Complexes (DSCCs) are located in Goldstone, California; near Madrid, Spain; and near Canberra, Australia—providing almost continuous contact with a spacecraft in deep space as EARTH rotates on its AXIS.

**deep-space probe** A SPACECRAFT designed for exploring deep space, especially to the vicinity of the MOON and beyond. This includes LUNAR PROBES, MARS probes, OUTER PLANET probes, SOLAR probes, and so on.

**Defense Meteorological Satellite Program (DMSP)** A highly successful family of WEATHER SATELLITES operating in POLAR ORBIT around EARTH that have provided important environmental data to serve American defense and civilian needs.

**Defense Support Program (DSP)** The family of MISSILE surveillance SATELLITES operated by the U.S. Air Force since the early 1970s. When placed into GEOSYNCHRONOUS ORBIT around EARTH, these

### decay – Defense Support Program

## degenerate star – density parameter

military surveillance satellites can detect missile launches, space launches, and nuclear detonations occurring around the world.

**degenerate star** A STAR that has collapsed to a high-DENSITY condition, such as a WHITE DWARF or a NEUTRON STAR.

**degrees of freedom (DOF)** A mode of motion, either angular or linear, with respect to a coordinate system, independent of any other mode. A body in motion has six possible degrees of freedom, three linear (sometimes called  $x$ -,  $y$ -, and  $z$ -motion with reference to linear [axial] movements in the CARTESIAN COORDINATE system) and three angular (sometimes called PITCH, YAW, and ROLL with reference to angular movements).

**Deimos** The tiny, irregularly shaped (about 12 km average diameter) outer MOON of MARS, discovered by ASAPH HALL in 1877.

**De Laval nozzle** A flow device that efficiently converts the ENERGY content of a hot, high-pressure pressure gas into KINETIC ENERGY. Although originally developed by CARL GUSTAF PATRIK DE LAVAL for use in certain steam turbines, the versatile CONVERGING-DIVERGING (CD) NOZZLE is now used in practically all modern ROCKETS. The device constricts the outflow of the high-pressure (combustion) gas until it reaches the VELOCITY of sound (at the NOZZLE's throat) and then expands the exiting gas to very high velocities.

**Delta** (*launch vehicle*) A versatile family of American two- and three-stage LIQUID-PROPELLANT, EXPENDABLE LAUNCH VEHICLES (ELVs) that uses multiple strap-on BOOSTER ROCKETS in several configurations. The Delta ROCKET vehicle family has successfully launched more than 250 U.S. and foreign SATELLITES, earning it the nickname *space workhorse vehicle*.

**delta-V** ( $\Delta V$ ) VELOCITY change; a numerical index of the maneuverability of a SPACECRAFT or ROCKET. This term often represents the maximum change in velocity that a space vehicle's PROPULSION SYSTEM can provide. It is typically described in terms of kilometers per second (km/s) or meters per second (m/s).

**density** ( $\rho$ ) The MASS of a substance per unit volume at a specified temperature.

**density parameter** (symbol:  $\Omega$ ) A dimensionless parameter used in COSMOLOGY to express the ratio of the actual mean DENSITY of UNIVERSE to the critical mass density—that is, the mean density of matter within the universe (considered as a whole) that cosmologists consider necessary, if GRAVITATION can eventually halt its expansion.

## GLOSSARY



Delta II rocket (NASA)

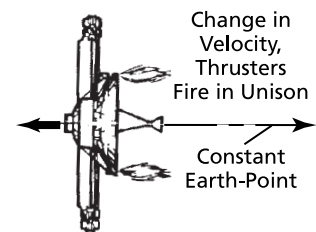

Delta-V

## degenerate star – density parameter

## GLOSSARY

If the universe does not contain sufficient MASS (that is, if the  $\Omega < 1$ ), then the universe will continue to expand forever. If  $\Omega > 1$ , then the universe has enough mass to eventually stop its expansion and to start an inward collapse under the influence of gravitation. If the critical mass density is just right (that is, if  $\Omega = 1$ ), then the universe is considered flat and a state of equilibrium could eventually exist in which the outward FORCE of expansion becomes precisely balanced by the inward force of gravitation. Cosmologists are now investigating DARK ENERGY and its potential influence on cosmological models suggested by the density parameter.

**de-orbit burn** A retrograde (opposite-direction) ROCKET engine firing by which a SPACE VEHICLE's VELOCITY is reduced to less than that required to remain in ORBIT around a CELESTIAL BODY.

**descending node** That point in the ORBIT of a CELESTIAL BODY when it travels from north to south across a reference plane, such as the equatorial plane of the CELESTIAL SPHERE or the plane of the ECLIPTIC. Also called the southbound node. *Compare with* ASCENDING NODE.

**Destiny** The American-built laboratory module delivered to the *INTERNATIONAL SPACE STATION* (ISS) by the SPACE SHUTTLE *Atlantis* during the STS-98 mission (February 2001). Destiny is the primary research laboratory for U.S. PAYLOADS on the SPACE STATION.

**destruct** (*missile*) The deliberate action of destroying a MISSILE or ROCKET vehicle after it has been launched but before it has completed its course. Destruct commands are executed by the range safety officer when the missile or rocket veers off its intended (plotted) course or functions in a way so as to become a hazard. *See also* COMMAND DESTRUCT.

**deuterium** (D or  ${}^2_1\text{H}$ ) A nonradioactive ISOTOPE of HYDROGEN whose NUCLEUS contains one NEUTRON and one PROTON. It is sometimes called *heavy hydrogen* because the deuterium nucleus is twice as heavy as that of ordinary hydrogen. *See also* TRITIUM.

**Dewar flask** A double-walled container with the interspace evacuated of gas (AIR) to prevent the contents from gaining or losing thermal ENERGY (heat). It is named for SIR JAMES DEWAR, and large, modern versions of this device are used to store CRYOGENIC PROPELLANTS.

**diamonds** The patterns of shock waves (pressure discontinuities) often visible in a ROCKET engine's exhaust. These patterns resemble a series of diamond shapes placed end to end.

**diffraction** The spreading out of ELECTROMAGNETIC RADIATION (such as LIGHT waves) as they pass by the edge of a body or through closely spaced parallel scratches in the surface of a diffraction grating. For example, when a ray of white light passes over a sharp, opaque edge (like that of a razor blade), it is broken up into its rainbow SPECTRUM of colors.

**diffuse nebula** *See* H II REGION.

**Dirac cosmology** An application of the large-numbers hypothesis within modern COSMOLOGY that tries to relate the fundamental physical constants found in subatomic physics to the age of the UNIVERSE and other large-scale COSMIC characteristics. It was suggested by PAUL ADRIAN MAURICE DIRAC. It is now not generally accepted but does influence the ANTHROPIC PRINCIPLE.

**direct broadcast satellite (DBS)** A class of COMMUNICATIONS SATELLITE, usually placed into GEOSTATIONARY ORBIT, that receives broadcast signals (such as television programs) from points of origin on EARTH and then amplifies, encodes, and retransmits these signals to individual end users scattered throughout some wide area or specific region. Many American households now receive hundreds of television channels directly from space by means of small (less than 0.5 m diameter), roof-top satellite dishes that are equipped to decode DBS transmissions.

**direct conversion** The conversion of thermal ENERGY (heat) or other forms of energy (such as sunlight) directly into electrical energy without intermediate conversion into mechanical work—that is, without the use of the moving components as found in a conventional electric generator system. The main approaches for converting heat directly into electricity include thermoelectric conversion, thermionic conversion, and MAGNETOHYDRODYNAMIC conversion. SOLAR ENERGY is directly converted into electrical energy by means of SOLAR CELLS (photovoltaic conversion). Batteries and FUEL CELLS directly convert chemical energy into electrical energy. *See also* RADIOISOTOPE THERMOELECTRIC GENERATOR.

**directional antenna** An ANTENNA that radiates or receives RADIO FREQUENCY (RF) signals more efficiently in some directions than in others. A collection of antennas arranged and selectively pointed for this purpose is called a directional antenna array.

**direct readout** The information technology capability that allows ground stations on EARTH to collect and interpret the data messages (TELEMETRY) being transmitted from SATELLITES.

## GLOSSARY

### disk – Doppler shift

- disk** (1) (*astronomy*) The visible surface of the SUN (or any other CELESTIAL BODY) seen in the sky or through a TELESCOPE.  
(2) (*of a galaxy*) The flattened, wheel-shaped region of STARS, gas, and dust that lies outside the central region (NUCLEUS) of a GALAXY.
- diurnal** Having a period of, occurring in, or related to a day; daily.
- diverging lens** (*or mirror*) A LENS (or mirror) that refracts (or reflects) a parallel BEAM of LIGHT into a diverging beam. A diverging lens is generally a CONCAVE LENS, while a diverging mirror is a convex mirror. *Compare with* CONVERGING LENS; CONVEX LENS.
- docking** The act of physically joining two orbiting SPACECRAFT. This is usually accomplished by independently maneuvering one spacecraft (the CHASER SPACECRAFT) into contact with the other (the target SPACECRAFT) at a chosen physical interface. For spacecraft with human crews, a docking module assists in the process and often serves as a special passageway (AIRLOCK) that permits HATCHES to be opened and crew members to move from one spacecraft to the other without the use of a SPACESUIT and without losing cabin pressure.
- docking module** A structural element that provides a support and attachment interface between a docking mechanism and a SPACECRAFT. For example, the special component added to the U.S. APOLLO PROJECT spacecraft so that it could be joined with the Russian SOYUZ SPACECRAFT in the APOLLO-SOYUZ TEST PROJECT; or the component carried in the CARGO BAY of the U.S. SPACE SHUTTLE so that it could be joined with the Russian *MIR* SPACE STATION.
- doffing** The act of removing wearing apparel or other apparatus, such as a SPACESUIT.
- dogleg** A directional turn made in a LAUNCH VEHICLE'S ascent TRAJECTORY to produce a more favorable ORBIT INCLINATION or to avoid passing over a populated (no-fly) region.
- donning** The act of putting on wearing apparel or other apparatus, such as a SPACESUIT.
- Doppler shift** The apparent change in the observed FREQUENCY and WAVELENGTH of a source due to the relative motion of the source and an observer. If the source is approaching the observer, the observed frequency is higher and the observed wavelength is shorter. This change to shorter wavelengths is often called the BLUESHIFT. If the source is moving away from the observer, the observed frequency will be lower and the wavelength will be longer. This change to longer wavelengths is called the REDSHIFT. It is named after

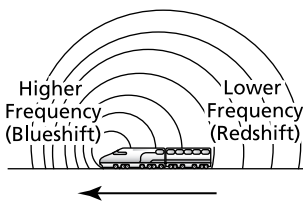

Doppler shift

## GLOSSARY

### disk – Doppler shift

## double-base propellant – dwarf planet

CHRISTIAN JOHANN DOPPLER, who discovered this phenomenon in 1842 by observing sounds.

## GLOSSARY

**double-base propellant** A solid ROCKET PROPELLANT using two unstable compounds, such as nitrocellulose and nitroglycerin. These unstable compounds contain enough chemically bonded OXIDIZER to sustain combustion.

**downlink** The TELEMETRY signal received at a ground station from a SPACECRAFT or SPACE PROBE.

**downrange** A location away from the LAUNCH SITE but along the intended flight path (TRAJECTORY) of a MISSILE or ROCKET flown from a rocket range. For example, the rocket vehicle tracking station on Ascension Island in the South Atlantic Ocean is far downrange from the launch sites at CAPE CANAVERAL Air Force Station in Florida.

**drag** (*D*) A retarding FORCE acting on a body in motion through a fluid parallel to (but opposite) the direction of motion of the body.

**Drake equation** A probabilistic expression, proposed by FRANK DONALD DRAKE in 1961, that is an interesting, though highly speculative, attempt to determine the number of advanced intelligent civilizations that might now exist in the MILKY WAY GALAXY and be communicating (via RADIO WAVES) ACROSS INTERSTELLAR distances. A basic assumption in Drake's formulation is the principle of mediocrity—namely that conditions in the SOLAR SYSTEM and even on EARTH are nothing particularly special but, rather, represent common conditions found elsewhere in the galaxy. *See also* SEARCH FOR EXTRATERRESTRIAL INTELLIGENCE.

**drogue parachute** A small parachute specifically used to pull a larger parachute out of stowage; a small parachute used to slow down a descending SPACE CAPSULE, AEROSPACE VEHICLE, or high-performance airplane.

**dry emplacement** A LAUNCH SITE that has no provision for water cooling of the pad during the LAUNCH of a ROCKET. *Compare with* WET EMPLACEMENT.

**dwarf galaxy** A small, often ELLIPTICAL GALAXY containing 1 million ( $10^6$ ) to perhaps 1 billion ( $10^9$ ) STARS. The MAGELLANIC CLOUDS, humans' nearest galactic neighbors, are examples.

**dwarf planet** As defined by the INTERNATIONAL ASTRONOMICAL UNION (IAU) in August 2006, a CELESTIAL BODY that is (a) in ORBIT around the SUN, (b) has sufficient MASS for its self-GRAVITY to overcome rigid body FORCES so that it assumes a nearly round shape, (c) has

## double-base propellant – dwarf planet

## GLOSSARY



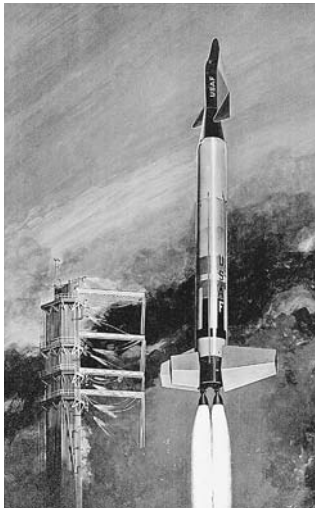

Dyna-Soar space project  
(USAF)

### dwarf star – Earth-crossing asteroid

not cleared the COSMIC neighborhood around its ORBIT, and (d) is not a SATELLITE of another (larger) body. Included in this definition are: PLUTO, CERES (the largest MAIN-BELT ASTEROID), and ERIS (a large, distant KUIPER BELT object, formerly called 2003 UB313).

**dwarf star** Any STAR that is a MAIN-SEQUENCE STAR, according to the HERTZSPRUNG-RUSSELL (H-R) DIAGRAM and has STELLAR LUMINOSITY CLASS V. Most stars found in the GALAXY, including the SUN, are of this type and are from 0.1 to about 100 SOLAR MASSES in size. When astronomers use the basic term *dwarf star*, they are often referring to stars with radii less than the radius of the Sun. However, they are not referring to WHITE DWARFS, BROWN DWARFS, or BLACK DWARFS, which are CELESTIAL BODIES that are not in the collection of main-sequence stars.

**Dyna-Soar** (*Dynamic Soaring*) An early U.S. Air Force space project from 1958–63, involving a crewed boost-glide orbital vehicle that was to be sent into ORBIT by an EXPENDABLE LAUNCH VEHICLE, perform its military mission, and return to EARTH using wings to glide through the ATMOSPHERE during REENTRY (in a manner similar to NASA'S SPACE SHUTTLE). The project was canceled in favor of the civilian (NASA) human spaceflight program, involving the MERCURY PROJECT, GEMINI PROJECT, and APOLLO PROJECT. Also called the *X-20 Project*.

**early-warning satellite** A military SPACECRAFT whose primary mission is the detection and notification of the LAUNCH of an enemy BALLISTIC MISSILE attack. This type of surveillance satellite uses sensitive INFRARED RADIATION sensors to detect the heat released when a MISSILE is launched. *See also* DEFENSE SUPPORT PROGRAM.

**Earth** The third PLANET from the SUN and the fifth largest in the SOLAR SYSTEM. When viewed from space, Earth is a beautiful world characterized by its distinctive blue waters, white clouds, and green vegetation. It circles the Sun in one YEAR (approximately 365.25 days) at an average distance of 149.6 million km and is the only planetary body currently known to possess life. *See also* SECTION IV CHARTS & TABLES.

**Earth-based telescope** A TELESCOPE that operates from the surface of EARTH, as opposed to a telescope placed onto an Earth-orbiting spacecraft, such as NASA'S *HUBBLE SPACE TELESCOPE*.

**Earth-crossing asteroid** (ECA) An inner SOLAR SYSTEM ASTEROID whose orbital path takes it across EARTH'S ORBIT around the SUN.

**Earthlike planet** A PLANET around another STAR (that is, an EXTRASOLAR PLANET) that orbits in a CONTINUOUSLY HABITABLE ZONE (CHZ) and maintains environmental conditions resembling EARTH. These conditions include a suitable ATMOSPHERE, a temperature range permitting the retention of liquid water on the planet's surface, and a sufficient quantity of radiant ENERGY striking the planet's surface from the parent star. Scientists in ASTROBIOLOGY hypothesize that under such conditions, the chemical evolution and the development of carbon-based life (as known on Earth) could also occur there.

**Earth-observing spacecraft** A SATELLITE in orbit around EARTH that has a specialized collection of SENSORS capable of monitoring important environmental variables. This is also called an environmental satellite or a green satellite. Data from such satellites help support EARTH SYSTEM science. *See also* LANDSAT; METEOROLOGICAL SATELLITE; *TERRA*; SPACECRAFT.

**Earth radiation budget (ERB)** The fundamental environmental phenomenon that influences EARTH's climate. Components include the incoming SOLAR RADIATION; the amount of solar radiation reflected back to space by clouds, other components in the ATMOSPHERE, and Earth's surface; and the long-WAVELENGTH (thermal) INFRARED RADIATION emitted by Earth's surface and atmosphere. The variation of Earth's radiation budget with LATITUDE represents the ultimate driving FORCE for atmospheric and oceanic circulations and the resulting planetary climate.

**Earth satellite** An artificial (human-made) object placed into ORBIT around PLANET EARTH.

**earthshine** A SPACECRAFT in ORBIT around EARTH is illuminated by both sunlight and "earthshine." Earthshine consists of sunlight (0.4- to 0.7-MICROMETER WAVELENGTH visible RADIATION, or LIGHT) reflected by Earth and thermal radiation (typically 10.6-micrometer wavelength INFRARED RADIATION) emitted by Earth's surface and ATMOSPHERE.

**Earth's trapped radiation belts** Two major belts (or zones) of very energetic atomic PARTICLES (mainly ELECTRONS and PROTONS) that are trapped by EARTH's magnetic field hundreds of kilometers above the ATMOSPHERE. These are also called the Van Allen belts after JAMES ALFRED VAN ALLEN, who discovered them in 1958. *See also* MAGNETOSPHERE.

**Earth system** (*science*) The modern study of EARTH, facilitated by space-based observations, that treats the PLANET as an interactive, complex

system. The four major components of the Earth system are the ATMOSPHERE, the HYDROSPHERE (which includes liquid water and ice), the BIOSPHERE (which includes all living things), and the SOLID EARTH (especially the planet's surface and soil).

**eccentricity** (*e*) A measure of the ovalness of an ORBIT. For example, when  $e = 0$ , the orbit is a circle; when  $e = 0.9$ , the orbit is a long, thin ELLIPSE.

**eccentric orbit** An ORBIT that deviates from a circle, thus forming an ELLIPSE.

**eclipse** (1) The reduction in visibility or the disappearance of a nonluminous CELESTIAL BODY when it passes into the shadow cast by another nonluminous body. The LUNAR eclipse is an example. It occurs when the MOON passes through the shadow cast by EARTH or when a NATURAL SATELLITE (moon) passes through the shadow cast by its PLANET.

(2) The apparent cutting off, totally or partially, of the LIGHT from a luminous body when a dark (nonluminous) body comes between it and an observer. The SOLAR eclipse is an example. It takes place when the Moon passes between the SUN and the Earth.

**ecliptic** (*plane*) The apparent annual path of the SUN among the STARS; the intersection of the plane of EARTH'S ORBIT around the Sun with the CELESTIAL SPHERE. Because of the tilt in Earth's AXIS, the ecliptic is a great circle of the celestial sphere inclined at an ANGLE of about  $23.5^\circ$  to the celestial EQUATOR.

**ecosphere** The CONTINUOUSLY HABITABLE ZONE (CHZ) around a MAIN-SEQUENCE STAR of a particular LUMINOSITY in which a PLANET could support environmental conditions favorable to the evolution and continued existence of life. For the chemical evolution of Earthlike, carbon-based, living organisms, global temperatures and atmospheric pressure conditions must allow the retention of liquid water on the planet's surface. A viable ECOSPHERE might lie between about 0.7 and 1.3 ASTRONOMICAL UNITS from a STAR like the SUN. However, if all the surface water has evaporated (the RUNAWAY GREENHOUSE effect) or has completely frozen (the ICE CATASTROPHE), then any Earthlike planet within this ecosphere cannot sustain life.

**ejecta** Any of a variety of rock fragments thrown out by an IMPACT CRATER during its formation and subsequently deposited via BALLISTIC TRAJECTORIES onto the surrounding terrain. The deposits themselves are called ejecta blankets. It is also material thrown out of a VOLCANO during an explosive eruption.

**ejection capsule** In an crewed SPACECRAFT or human-rated LAUNCH VEHICLE, a detachable compartment that may be ejected as a unit and parachuted to the ground during an emergency.

**electric propulsion** A ROCKET engine that converts electric POWER into reactive THRUST by accelerating an ionized PROPELLANT (such as mercury, cesium, argon, or xenon) to a very high exhaust VELOCITY. There are three general types of electric rocket engine: electrothermal, electromagnetic, and electrostatic.

**electromagnetic radiation (EMR)** Radiation composed of oscillating electric and magnetic fields and propagated with the SPEED OF LIGHT. EMR includes (in order of decreasing ENERGY and increasing WAVELENGTH) GAMMA RAYS, X-RAYS, ULTRAVIOLET RADIATION, VISIBLE RADIATION (LIGHT), INFRARED RADIATION, radar waves, and RADIO WAVES.

**electromagnetic spectrum** Comprises the entire range of WAVELENGTHS of ELECTROMAGNETIC RADIATION, from the most energetic, shortest-wavelength GAMMA RAYS to the longest-wavelength RADIO WAVES, and everything in between. Also called the EM spectrum.

**electron** (e) A stable elementary PARTICLE with a unit negative electrical charge ( $1.602 \times 10^{-19}$  C) and a rest MASS ( $m_0$ )<sub>e</sub> of approximately 1/1,837 that of a PROTON (namely,  $9.109 \times 10^{-31}$  kg). Electrons surround the positively charged NUCLEUS and determine the chemical properties of the ATOM. Electrons detached from an atom are called free electrons. Positively charged electrons, or POSITRONS, also exist.

**electron volt (eV)** A unit of ENERGY equivalent to the energy gained by an ELECTRON when it moves through a potential difference of one volt. Larger multiple units of the electron volt are often encountered, such as keV for thousand (or kilo) electron volts ( $10^3$  eV); MeV for million (or mega) electron volts ( $10^6$  eV); and GeV for billion (or giga) electron volts ( $10^9$  eV). One electron volt is also equivalent to  $1.602 \times 10^{-19}$  J.

**element** A chemical substance that cannot be divided or decomposed into simpler substances by chemical means. A substance whose ATOMS all have the same number of PROTONS (ATOMIC NUMBERS,  $Z$ ) and ELECTRONS. There are 92 naturally occurring elements and over 15 human-made or transuranium elements, such as plutonium (atomic number 94).

**ellipse** A smooth, oval curve accurately fitted by the ORBIT of a SATELLITE around a much larger MASS. Specifically, a plane curve constituting the locus of all points the sum of whose distances from two fixed

points (called focuses or foci) is constant; an elongated circle. The orbits of PLANETS, satellites, ASTEROIDS, and COMETS are ellipses; the center of attraction (that is, the PRIMARY BODY) is one focus.

**elliptical galaxy** A GALAXY with a smooth, elliptical shape without spiral arms and having little or no INTERSTELLAR gas and dust.

**elliptical orbit** A noncircular, Keplerian ORBIT. *See also* KEPLER'S LAWS.

**emissivity** ( $e$  or  $\varepsilon$ ) The ratio of the RADIANT FLUX per unit area (sometimes called emittance,  $E$ ) emitted by a body's surface at a specified WAVELENGTH ( $\lambda$ ) and temperature ( $T$ ) to the radiant flux per unit area emitted by a BLACKBODY radiator at the same temperature and under the same conditions. The greatest value for an emissivity is unity (1)—the emissivity value for a blackbody radiator—while the least value for an emissivity is zero (0).

**empirical** Derived from observation or experiment.

**encounter** The close FLYBY or RENDEZVOUS of a SPACECRAFT with a target body. The target of an encounter can be a natural CELESTIAL BODY (such as a PLANET, ASTEROID, or COMET) or a human-made object (such as another spacecraft).

**endoatmospheric** Within EARTH'S ATMOSPHERE, generally considered to be at ALTITUDES below 100 km.

**endothermic reaction** A reaction to which thermal ENERGY (heat) must be provided. *Compare with* EXOTHERMIC REACTION.

**energy** ( $E$ ) The capacity to do WORK. Energy appears in many different forms, such as mechanical, thermal, electrical, chemical, and nuclear. According to the first law of thermodynamics, energy can neither be created nor destroyed but simply changes form (including mass-energy transformations).

**energy satellite** *See* SATELLITE POWER SYSTEM.

**engine cutoff** The specific time when a ROCKET engine is shut down during a flight.

**Enos** The primate (ASTROCHIMP) used by NASA to test the MERCURY PROJECT SPACE CAPSULE during a successful orbital flight test on 29 November 1961. Enos's test flight qualified the space capsule for use by human beings during subsequent orbital missions.

**entropy** ( $S$ ) A measure of the extent to which the ENERGY of a system is unavailable. As entropy increases, energy becomes less available to perform useful WORK. *See also* HEAT DEATH OF THE UNIVERSE.

**environmental satellite** *See* EARTH-OBSERVING SPACECRAFT.

- ephemeris** A collection of data about the predicted positions (or apparent positions) of CELESTIAL BODIES, including ARTIFICIAL SATELLITES, at various times in the future. *See also* KEPLERIAN ELEMENTS.
- epicycle** A small circle whose center moves along the circumference of a larger circle, called the deferent. Ancient astronomers, like PTOLEMY, used the epicycle in an attempt to explain the motions of CELESTIAL BODIES in their GEOCENTRIC (nonheliocentric) models of the SOLAR SYSTEM.
- equator** An imaginary circle around a CELESTIAL BODY that is everywhere equidistant (90°) from the POLES of ROTATION. It defines the boundary between the Northern and Southern Hemisphere.
- equatorial bulge** The excess of a PLANET'S equatorial diameter over its polar diameter. The increased size of the equatorial diameter is caused by CENTRIFUGAL FORCE associated with ROTATION about the polar AXIS.
- equatorial orbit** An ORBIT with an INCLINATION of zero degrees. The ORBITAL PLANE for a SATELLITE in an equatorial orbit around EARTH contains the EQUATOR. *Compare with* POLAR ORBIT.
- equatorial satellite** A SATELLITE whose ORBITAL PLANE coincides, or nearly coincides, with the equatorial plane of EARTH (or that of another planetary body).
- equinox** One of two points of intersection of the ECLIPTIC and the celestial equator that the SUN occupies when it appears to cross the celestial equator (that is, has a DECLINATION of 0°). In the Northern Hemisphere, the Sun appears to go from south to north at the VERNAL EQUINOX, which occurs on or about 21 March. Similarly, the Sun appears to travel from north to south at the autumnal equinox, which occurs on or about 23 September each year. The dates are reversed in the Southern Hemisphere.
- ergometer** A bicycle-like instrument used by ASTRONAUTS and COSMONAUTS for measuring muscular WORK and for exercising in place on extended orbital flights in MICROGRAVITY.
- Eris** A DWARF PLANET residing at the extreme outer fringes of the SOLAR SYSTEM. Discovered in 2003, this TRANS-NEPTUNIAN OBJECT (TNO) was originally designated as 2003 UB313 and treated by some astronomers as the so-called Tenth Planet because of its size, which is slightly larger than PLUTO. Eris has a diameter of approximately 2,400 km and takes about 560 years to travel around the SUN in a highly ECCENTRIC ORBIT that ranges from some 38 ASTRONOMICAL

## GLOSSARY

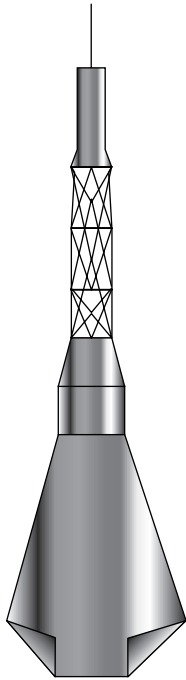

Escape rocket

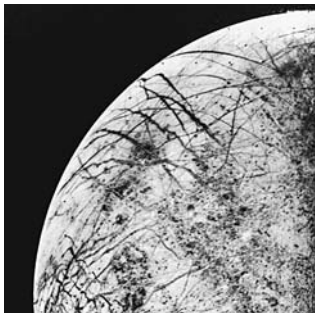

Europa (Courtesy of NASA)

## GLOSSARY

### erosive burning – event horizon

UNITS (AU) at PERIHELION to 98 AU at APHELION. Named after the Greek goddess of warfare and strife.

**erosive burning** An increased rate of burning (combustion) that occurs in certain SOLID-PROPELLANT ROCKETS as a result of the scouring influence of combustion gases moving at high speed across the burning surface.

**escape rocket** A small ROCKET engine, attached to the leading end of an ESCAPE TOWER, that can provide additional THRUST to the crew's SPACE CAPSULE so it can quickly separate from a malfunctioning or exploding EXPENDABLE LAUNCH VEHICLE during LIFTOFF.

**escape tower** A trestle tower placed on top of a crew-carrying SPACE CAPSULE. During LIFTOFF the tower connects the crew capsule to the ESCAPE ROCKET. After a successful liftoff and ascent, the escape tower and escape rocket are separated from the capsule.

**escape velocity** ( $V_e$ ) The minimum VELOCITY that an object must acquire to overcome the gravitational attraction of a CELESTIAL BODY. The escape velocity for an object launched from the surface of EARTH is approximately 11.2 km/s, while the escape velocity from the surface of MARS is 5.0 km/s. *See also* SECTION IV CHARTS & TABLES.

**Europa** The smooth, ice-covered MOON of JUPITER, discovered by GALILEO GALILEI in 1610, and currently thought to have a liquid-water ocean beneath its frozen surface.

**European Organisation for Astronomical Research in the Southern Hemisphere** (ESO) An intergovernmental organization for ASTRONOMY that is headquartered in Germany and operates the La Silla Paranal Observatory at two sites in the very dry Atacama desert region of Chile. Supporting ground-based optical and INFRARED ASTRONOMY, ESO's flagship facility is the Very Large Telescope (VLT) located atop the Paranal mountain.

**European Southern Observatory** (ESO) *See* EUROPEAN ORGANISATION FOR ASTRONOMICAL RESEARCH IN THE SOUTHERN HEMISPHERE.

**European Space Agency** (ESA) An international organization that promotes the peaceful use of OUTER SPACE and cooperation among the European member states in space research and applications.

**evening star** Common name for the PLANET VENUS when it appears as a bright CELESTIAL BODY in the twilight sky just after sunset.

**event horizon** The point of no return for a BLACK HOLE; the distance from a black hole within which nothing can escape. Also called the SCHWARZSCHILD RADIUS.

### erosive burning – event horizon

**evolved star** A STAR near the end of its lifetime when most of its HYDROGEN fuel has been exhausted; a star that has left the main sequence. *See* MAIN-SEQUENCE STAR.

**exhaust plume** Hot gas ejected from the THRUST chamber of a ROCKET engine.

**exoatmospheric** Occurring outside EARTH'S ATMOSPHERE; events and actions that take place at ALTITUDES above 100 km.

**exobiology** *See* ASTROBIOLOGY.

**exosphere** The outermost region of EARTH'S ATMOSPHERE.

**exothermic reaction** A chemical or physical reaction in which thermal ENERGY (heat) is released into the surroundings.

**expanding universe** Any model of the UNIVERSE in modern COSMOLOGY that has the distance between widely separated celestial objects (for example, distant GALAXIES) continuing to grow or expand with time.

**expendable launch vehicle (ELV)** A ground-launched ROCKET vehicle capable of placing a PAYLOAD into ORBIT around EARTH or on an Earth-escape TRAJECTORY whose various stages and supporting hardware are not designed or intended for recovery or reuse. A throwaway LAUNCH VEHICLE. *See also* SECTION IV CHARTS & TABLES.

**experimental vehicle (X)** A MISSILE, ROCKET, or AEROSPACE VEHICLE in the research, development, and testing portion of its technical life cycle; a vehicle not yet approved for operational use.

**exploding galaxies** Violent, very energetic explosions centered in certain GALACTIC NUCLEI where the total MASS of ejected material is comparable to the mass of some 5 million average-size, SUNLIKE STARS. Jets of gas 1,000 LIGHT-YEARS long are also typical.

**Explorer 1** The first American SATELLITE to ORBIT EARTH. The SPACECRAFT was launched successfully from CAPE CANAVERAL on 31 January 1958 (local time) by a Juno I four-stage configuration of the JUPITER C LAUNCH VEHICLE. The satellite involved the collaborative efforts of a quickly assembled team from the U.S. Army (under the direction of WERNHER VON BRAUN) and Caltech's Jet Propulsion Laboratory (JPL). Professor JAMES ALFRED VAN ALLEN (State University of Iowa) provided the satellite's instruments—instruments that discovered the lower portion of EARTH'S TRAPPED RADIATION BELTS, which were subsequently named after him.

**Explorer spacecraft** NASA has used the name "Explorer" to designate members of a large family of scientific SPACECRAFT and SATELLITES



## GLOSSARY

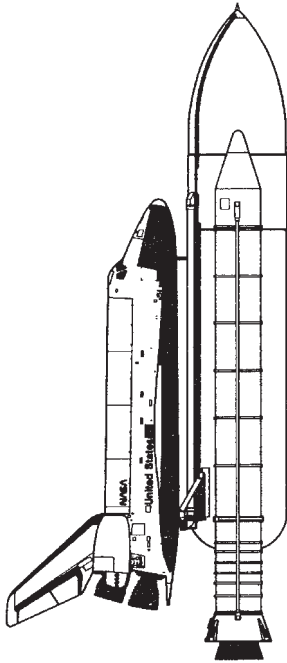

External tank

## external tank – extrasolar planet

intended to “explore the unknown.” Since 1958, Explorer spacecraft have studied EARTH’S ATMOSPHERE and IONOSPHERE; the planet’s precise shape and geophysical features; the planet’s MAGNETOSPHERE and INTERPLANETARY space; and various astronomical and astrophysical phenomena.

**external tank** The large tank that contains the cryogenic PROPELLANTS for the three SPACE SHUTTLE main engines (SSMEs). This tank forms the structural backbone of NASA’S SPACE TRANSPORTATION SYSTEM flight vehicle.

**extragalactic** Occurring, located, or originating beyond the MILKY WAY GALAXY—that is, more than 100,000 LIGHT-YEARS distant.

**extragalactic astronomy** A branch of ASTRONOMY that started about 1930 and deals with everything in the UNIVERSE outside of the MILKY WAY GALAXY.

**extrasolar** Occurring, located, or originating outside of the SOLAR SYSTEM.

**extrasolar planet** A PLANET that belongs to a STAR other than the SUN. There are two general methods scientists are using to detect extrasolar planets: direct—involving a search for telltale signs of a planet’s INFRARED RADIATION emissions—and indirect—involving precise observation of any perturbed motion of the parent star or any periodic variation in the intensity or spectral properties of its LIGHT.



Extrasolar planet (NASA)

## GLOSSARY

## external tank – extrasolar planet

**extraterrestrial – *Extreme Ultraviolet Explorer***

**extraterrestrial (ET)** Occurring, located, or originating beyond PLANET EARTH and its ATMOSPHERE.

**extraterrestrial catastrophe theory** The hypothesis that a large ASTEROID or COMET struck EARTH some 65 million years ago, causing global environmental consequences that annihilated over 90 percent of all animal species then living—including the dinosaurs.

**extraterrestrial contamination** The contamination of one world by life-forms, especially microorganisms, from another world. When using EARTH'S BIOSPHERE as the reference, planetary contamination is called forward contamination when an alien world is contaminated by contact with TERRESTRIAL organisms and back contamination when alien organisms are released into Earth's biosphere.

**extraterrestrial life** Life-forms that may have evolved independent of and now exist beyond the TERRESTRIAL BIOSPHERE.

**extravehicular activity (EVA)** Activities conducted by an ASTRONAUT or COSMONAUT in OUTER SPACE or on the surface of another PLANET (or MOON) outside of the protective environment of his/her AEROSPACE VEHICLE, SPACECRAFT, or LANDER. Astronauts and cosmonauts must put on SPACESUITS (which contain portable LIFE-SUPPORT SYSTEMS) to perform EVA tasks.

***Extreme Ultraviolet Explorer (EUVE)*** The 70th NASA EXPLORER SPACECRAFT. After being successfully launched from CAPE

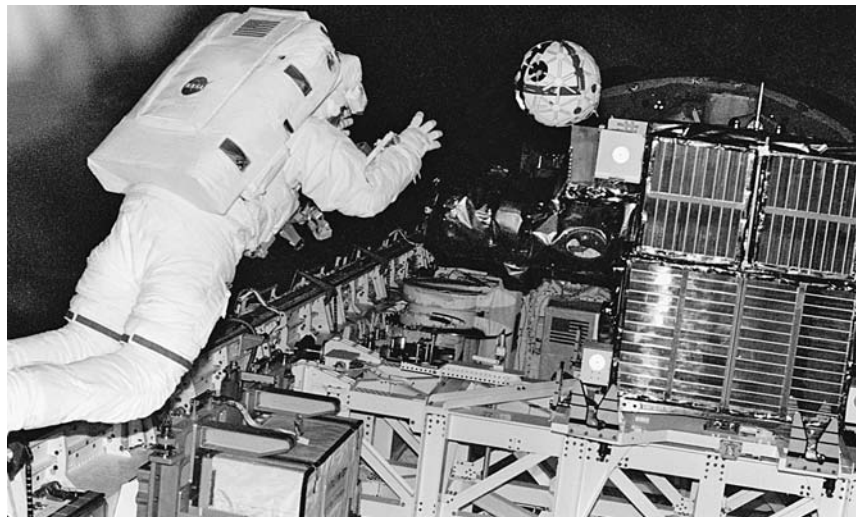

Extravehicular activity (EVA) (NASA)

**extraterrestrial – *Extreme Ultraviolet Explorer***

**GLOSSARY**



Extraterrestrial catastrophe theory (NASA)

**GLOSSARY**

## GLOSSARY

### extreme ultraviolet radiation – *Fermi Gamma-ray Space Telescope*

CANAVERAL in June 1992, this spacecraft went into orbit around Earth and provided astronomers with a survey of the (until then) relatively unexplored EXTREME ULTRAVIOLET (EUV) RADIATION portion of the ELECTROMAGNETIC SPECTRUM.

**extreme ultraviolet (EUV) radiation** The region of the ELECTROMAGNETIC SPECTRUM that lies between the ULTRAVIOLET RADIATION and X-RAY regions. EUV PHOTONS have wavelengths between about 10 and 100 nm (or 100 and 1,000 ANGSTROMS).

**extremophile** A hardy (TERRESTRIAL) microorganism that can exist under extreme environmental conditions, such as in frigid polar regions or boiling hot springs. Astrobiologists speculate that similar (EXTRATERRESTRIAL) microorganisms might exist elsewhere in this SOLAR SYSTEM, perhaps within subsurface biological niches on MARS or in a suspected liquid-water ocean beneath the frozen surface of EUROPA.

**eyeballs in, eyeballs out** Early American space program expression used to describing the acceleration-related sensations experienced by an ASTRONAUT at LIFTOFF or when RETROROCKETS fired. The experience at liftoff is eyeballs in (due to positive *G* FORCES on the human body when the LAUNCH VEHICLE accelerates). The experience when the retrorockets fire is eyeballs out (due to negative *g* forces on the human body as a SPACECRAFT decelerates).

**eyepiece** A magnifying LENS that helps an observer view the IMAGE produced by a TELESCOPE.

**facula** A bright region of the SUN'S PHOTOSPHERE.

**fallaway section** A section of a ROCKET vehicle that is cast off and separates from the vehicle during flight, especially a section that falls back to EARTH.

**farside** The side of the MOON that never faces EARTH.

***Fermi Gamma-ray Space Telescope (FGST)*** When launched by NASA on 11 June 2008, this SPACECRAFT was originally called the *Gamma-ray Large Area Space Telescope (GLAST)*. On 26 August, NASA renamed the orbiting OBSERVATORY the *Fermi Gamma-ray Space Telescope* in honor of the Italian-American physicist ENRICO FERMI. The spacecraft's planned five year mission is to scan the UNIVERSE for GAMMA RAYS, ranging in ENERGY from about 10 thousand ELECTRON VOLTS to over 300 billion electron volts. *FGST* is the successor to the *COMPTON GAMMA RAY OBSERVATORY*, and scientists anticipate its instruments discover thousands of new gamma ray sources in support of high-energy ASTROPHYSICS.



Farside (courtesy of NASA)

## GLOSSARY

### extreme ultraviolet radiation – *Fermi Gamma-ray Space Telescope*

- Fermi paradox—“Where are they?”** The Italian-American physicist ENRICO FERMI helped create the nuclear age. The Nobel laureate is also credited with the popular speculative inquiry now commonly called the Fermi paradox. His hypothetical inquiry involves migration through the GALAXY by an advanced alien civilization as it pursues an expanding wave of INTERSTELLAR exploration. In 1943, Fermi suggested that if just one intelligent STAR-faring civilization developed within the 10- to 12-billion-year-old MILKY WAY GALAXY, then, in about 100 million years, that advanced civilization could have diffused throughout the entire galaxy—making its presence known essentially everywhere. So where are they?
- ferret satellite** A military SPACECRAFT designed for the detection, location, recording, and analyzing of ELECTROMAGNETIC RADIATION (for example, enemy RADIO FREQUENCY [RF] transmissions).
- ferry flight** An in-the-ATMOSPHERE flight of NASA’S SPACE SHUTTLE ORBITER vehicle while mated on top of a specially configured Boeing 747 shuttle carrier aircraft.
- field of view (FOV)** The area or solid ANGLE than can be viewed through or scanned by a REMOTE-SENSING (optical) instrument.
- film cooling** The cooling of body or surface, such as the inner surface of a ROCKET’S COMBUSTION CHAMBER, by maintaining a thin fluid layer over the affected area.
- fire arrow** An early gunpowder ROCKET attached to a large bamboo stick; developed by the Chinese about 1,000 years ago to confuse and startle enemy troops.
- fireball** (*meteor*) See BOLIDE.
- fission** (*nuclear*) The process during which the NUCLEUS of certain heavy RADIOISOTOPES, such as uranium 235, captures a NEUTRON, becomes an unstable compound nucleus, and soon breaks apart. As the compound nucleus splits, or fissions, it forms two lighter nuclei (called *fission products*) and also releases a large amount of ENERGY (about 200 million ELECTRON VOLTS per reaction) plus additional neutrons and GAMMA RAYS.
- fixed satellite** A SATELLITE that orbits EARTH from west to east at such speed as to remain constantly over a given place on the EQUATOR. *See also* GEOSTATIONARY ORBIT.
- fixed stars** A term used by early astronomers to distinguish between the apparently motionless background STARS and the wandering stars (PLANETS). Modern astronomers now use this term to describe stars that have no detectable PROPER MOTION.

- flame bucket** A deep, cavelike metal construction built beneath a LAUNCH PAD. It is open at the top to receive the hot engine exhaust gases from the ROCKET positioned above it and has one to three sides open below. During THRUST buildup and the beginning of LAUNCH, water can be sprayed onto the flame bucket to keep it from melting.
- flare** (*solar*) A bright eruption from the SUN'S CORONA. An intense flare represents a major IONIZING RADIATION hazard to ASTRONAUTS traveling beyond EARTH'S MAGNETOSPHERE through INTERPLANETARY space or while exploring the surface of the MOON or MARS.
- flight crew** Personnel assigned to an AEROSPACE VEHICLE (like NASA'S SPACE SHUTTLE), a SPACE STATION, or an INTERPLANETARY SPACECRAFT for a specific flight or mission. The space shuttle flight crew usually consists of ASTRONAUTS serving as the commander, the pilot, and one or several mission specialists.
- flight test vehicle** A ROCKET, MISSILE, or AEROSPACE VEHICLE used for performing flight tests that demonstrate the capabilities of the vehicle itself or of specific equipment carried onboard.
- flux** ( $\Phi$ ) The rate of transport or flow of some quantity per unit area; often used in reference to the flow of some form of ENERGY. A particle flux is defined as the number of PARTICLES passing through one square centimeter of a given target in one second, while a radiant flux represents the total POWER per unit area of some form of ELECTROMAGNETIC RADIATION—that is, WATTS per square centimeter.
- flyby** An INTERPLANETARY or deep-space mission in which the FLYBY SPACECRAFT passes close to its target CELESTIAL BODY (for example, a distant PLANET, MOON, ASTEROID, or COMET) but does not IMPACT the target or go into ORBIT around it.
- focal length** ( $f$ ) The distance between the center of a LENS or mirror to the focus or focal point.
- folded optics** Any optical system containing reflecting components for the purpose of reducing the physical length of the system or for changing the path of the optical AXIS.
- force** ( $F$ ) The cause of the ACCELERATION of material objects as measured by the rate of change of MOMENTUM produced on a free body. Force is a VECTOR quantity, mathematically expressed by the second of NEWTON'S LAWS OF MOTION: force = mass  $\times$  acceleration.
- fossa** A long, narrow, shallow (ditchlike) depression found on the surface of a PLANET or a MOON.

## free fall – galactic cannibalism

**free fall** The unimpeded fall of an object in a gravitational field. For example, all the **ASTRONAUTS** and objects inside an **EARTH-orbiting SPACECRAFT** experience a continuous state of free fall and appear weightless as the **FORCE of INERTIA** counterbalances the force of Earth's **GRAVITY**.

*See also* **WEIGHTLESSNESS**.

**free-flying spacecraft** (*free-flyer*) Any **SPACECRAFT** or **PAYLOAD** that can be detached from **NASA'S SPACE SHUTTLE** or the *INTERNATIONAL SPACE STATION* and then operate independently in **ORBIT**.

**free rocket** A **ROCKET** not subject to guidance or control in flight.

**frequency** ( $f$  or  $\nu$ ) The rate of repetition of a recurring or regular event; the number of cycles of a wave per second. For **ELECTROMAGNETIC RADIATION**, the frequency ( $\nu$ ) equals the **SPEED OF LIGHT** ( $c$ ) divided by the **WAVELENGTH** ( $\lambda$ ). *See also* **HERTZ**.

**fuel cell** A **DIRECT-CONVERSION** device that transforms **CHEMICAL ENERGY** directly into electrical energy by reacting continuously supplied chemicals. In a modern fuel cell, an electrochemical catalyst (like platinum) promotes a noncombustible reaction between a fuel (such as **HYDROGEN**) and an oxidant (such as oxygen).

**fuselage** The central part of an **AEROSPACE VEHICLE** or aircraft that accommodates crew, passengers, **PAYLOAD**, or cargo.

**fusion** (*nuclear*) The nuclear process by which lighter atomic **NUCLEI** join (or fuse) to create a heavier nucleus. For example, the fusion of **DEUTERIUM (D)** with **TRITIUM (T)** results in the formation of a **HELIUM (He)** nucleus and a **NEUTRON (n)**. This **D-T** reaction also involves the release of 17.6 million **ELECTRON VOLTS (MeV)** of **ENERGY**. Thermonuclear reactions are fusion reactions caused by very high temperature conditions (millions of **KELVINS**). The energy of the **SUN** and other **STARS** comes from thermonuclear fusion reactions.

**g** The symbol used for the **ACCELERATION** due to **GRAVITY**. At sea level on **EARTH**,  $g$  is approximately 9.8 meters per second squared ( $m/s^2$ )—that is, one  $g$ . This term is used as a unit of stress for bodies experiencing acceleration. When a **ROCKET** accelerates during **LAUNCH**, everything inside it experiences a **FORCE** that can be as high as several  $g$ s.

**galactic cannibalism** A postulated model of **GALAXY** interaction in which a more massive galaxy uses **GRAVITATION** and tidal **FORCES** to pull away matter from a less massive, neighboring galaxy.

## free fall – galactic cannibalism

## GLOSSARY



Galilean satellites: Io, Europa, Ganymede, and Callisto (from top to bottom; Jupiter on the left) (NASA)

## galactic cluster – gamma ray astronomy

**galactic cluster** A diffuse collection of from 10 to perhaps several hundred STARS loosely held together by the FORCE OF GRAVITATION. The term OPEN CLUSTER is now preferred by astronomers.

**galactic cosmic rays** (GCRs) Very energetic atomic PARTICLES that originate outside the SOLAR SYSTEM. *See also* COSMIC RAYS.

**galactic nucleus** The central region of a GALAXY.

**galaxy** A very large accumulation of STARS with from 1 million ( $10^6$ ) to 1 million million ( $10^{12}$ ) members. These ISLAND UNIVERSES come in a variety of sizes and shapes, from DWARF GALAXIES (like the MAGELLANIC CLOUDS) to majestic SPIRAL GALAXIES (like the ANDROMEDA GALAXY). Astronomers classify them as elliptical, spiral (or barred spiral), or irregular.

**Galaxy** When capitalized, humans' home GALAXY, the MILKY WAY GALAXY.

**Galilean satellites** The four largest and brightest MOONS of JUPITER, discovered by GALILEO GALILEI in 1610. They are IO, EUROPA, GANYMEDE, and CALLISTO.

**Galilean telescope** The early REFRACTING TELESCOPE assembled by GALILEO GALILEI in about 1610. It had a CONVERGING LENS as the OBJECTIVE and a DIVERGING LENS as the EYEPIECE.

**Galileo Project** NASA's highly successful scientific mission to JUPITER launched in October 1989. With electricity supplied by two RADIOISOTOPE-THERMOELECTRIC GENERATOR (RTG) units, the *Galileo* SPACECRAFT extensively studied the Jovian system from December 1995 until February 2003. Upon arrival, it also released a probe into the upper portions of Jupiter's ATMOSPHERE. On 28 February 2003, the NASA flight team terminated its operation of *Galileo* and commanded the ROBOT SPACECRAFT to plunge into Jupiter's atmosphere. This mission-ending plunge took place in late September 2003.

**gamma ray** ( $\gamma$ ) Very short WAVELENGTH, high-FREQUENCY packets (or QUANTA) of ELECTROMAGNETIC RADIATION. Gamma ray PHOTONS are similar to X-RAYS, except that they originate within the atomic NUCLEUS and have energies between 10,000 ELECTRON VOLTS (10 keV) and 10 million electron volts (10 MeV).

**gamma ray astronomy** Branch of ASTRONOMY based on the detection of the energetic GAMMA RAYS associated with SUPERNOVAS, EXPLODING GALAXIES, QUASARS, PULSARS, and phenomena near suspected BLACK HOLES.

## GLOSSARY

## galactic cluster – gamma ray astronomy

## Ganymede – geosynchronous orbit

## GLOSSARY

**Ganymede** With a diameter of 5,262 km, the largest MOON of JUPITER and in the SOLAR SYSTEM. Discovered by GALILEO GALILEI in 1610.

**Gemini Project** The second U.S. crewed space project (1964–66) and the start of more sophisticated missions by pairs of American ASTRONAUTS in each Gemini SPACE CAPSULE. Through this project, NASA expanded the results of the MERCURY PROJECT and prepared the way for the ambitious LUNAR landing missions of the APOLLO PROJECT.

**general relativity** ALBERT EINSTEIN's theory, introduced in 1915, that GRAVITATION arises from the curvature of space and time—the more massive an object, the greater the curvature. *See also* SPACE-TIME.

**geocentric** Relative to EARTH as the center; measured from the center of Earth.

**geographic information system (GIS)** A computer-assisted system that acquires, stores, manipulates, compares, and displays geographic data, often including MULTISPECTRAL SENSING data sets from EARTH-OBSERVING SPACECRAFT.

**geomagnetic storm** Sudden, often global fluctuations in EARTH's magnetic field, associated with the shock waves from SOLAR FLARES that arrive at Earth within about 24 to 36 hours after violent activity on the SUN.

**geosphere** The solid (lithosphere) and liquid (HYDROSPHERE) portions of EARTH. Above the geosphere lies the ATMOSPHERE. At the interface between these two regions is found almost all of the BIOSPHERE, or zone of life.

**geostationary orbit (GEO)** A SATELLITE in a circular ORBIT around EARTH at an ALTITUDE of 35,900 km above the EQUATOR that goes around the PLANET at the same rate as Earth spins on its AXIS. COMMUNICATIONS SATELLITES, ENVIRONMENTAL SATELLITES, and SURVEILLANCE SATELLITES use this important orbit. If the SPACECRAFT's orbit is circular and lies in the equatorial plane (to an observer on Earth), the spacecraft appears stationary over a given point on Earth's surface. If the satellite's orbit is inclined to the equatorial plane (when observed from Earth), the spacecraft traces out a figure eight path every 24 hours. *See also* GEOSYNCHRONOUS ORBIT; SYNCHRONOUS SATELLITE.

**geosynchronous orbit (GEO)** An ORBIT in which a SATELLITE completes one REVOLUTION at the same rate as EARTH spins, namely 23 hours, 56 minutes, and 4.1 seconds. A satellite placed into such an orbit (at approximately 35,900 km ALTITUDE above the EQUATOR)

## Ganymede – geosynchronous orbit

## GLOSSARY



## GLOSSARY

### giant-impact model – grain

revolves around Earth once per day. *See also* GEOSTATIONARY ORBIT; SYNCHRONOUS SATELLITE.

**giant-impact model** The hypothesis that the MOON originated when a MARS-sized object struck a young EARTH with a glancing blow. The giant (oblique) impact released material that formed an ACCRETION DISK around Earth out of which the Moon formed.

**giant molecular cloud (GMC)** Massive clouds of gas in INTERSTELLAR space composed primarily of MOLECULES of HYDROGEN ( $H_2$ ) and dust. GMCs can contain enough MASS to make several million STARS like the SUN and are often the sites of star formation.

**giant planets** In this SOLAR SYSTEM, the large, gaseous, OUTER PLANETS: JUPITER, SATURN, URANUS, and NEPTUNE. Any detected or suspected EXTRASOLAR PLANETS as large or larger than Jupiter.

**giant star** A STAR near the end of its life that has swollen in size and is much larger and far more luminous than a MAIN-SEQUENCE STAR of comparable MASS. Giant stars have stopped burning HYDROGEN in their CORES and lie above main-sequence stars on the HERTZSPRUNG-RUSSELL (H-R) DIAGRAM. Astronomers use STELLAR LUMINOSITY CLASSES II and III to help characterize giant stars. *See also* BLUE GIANT; RED GIANT.

**Giotto spacecraft** Scientific SPACECRAFT launched by the EUROPEAN SPACE AGENCY (ESA) in July 1985 that successfully encountered the NUCLEUS of COMET HALLEY in mid-March 1986 at a distance of about 600 km.

**global change** EARTH'S environment is continuously changing. Many natural changes occur quite slowly, requiring thousands of years to achieve their full impact. Human-induced change can happen rapidly, in times as short as a few decades. Global change studies the interactive linkages among this PLANET'S major natural and human-made systems that influence the planetary environment. *See also* EARTH SYSTEM.

**Global Positioning System (GPS)** The CONSTELLATION of over 20 U.S. Air Force SATELLITES in circular 20,350 km ALTITUDE ORBITS around EARTH that provide accurate navigation data to military and civilian users globally.

**globular cluster** Compact cluster of up to 1 million, generally older, STARS.

**grain** The integral piece of molded or extruded solid material that encompasses both fuel and OXIDIZER in a SOLID-PROPELLANT ROCKET

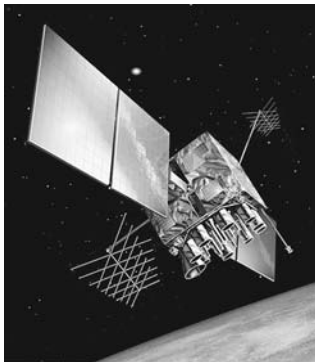

Global Positioning System (GPS) Block IIR satellite (USAF and Lockheed Martin)

## GLOSSARY

### giant-impact model – grain

motor. When ignited, the design and shape of the grain produce a specified THRUST over time.

**gravitation** The FORCE of attraction between two MASSES. From NEWTON'S LAW OF GRAVITATION, this attractive force operates along a line joining the CENTERS OF MASS, and its magnitude is inversely proportional to the square of the distance between the two masses. From ALBERT EINSTEIN'S GENERAL RELATIVITY theory, gravitation is viewed as a distortion of the SPACE-TIME continuum.

**gravitational collapse** The unimpeded contraction of any MASS caused by its own GRAVITY.

**graviton** The hypothetical QUANTUM (or PARTICLE) of gravitational ENERGY predicted by ALBERT EINSTEIN in his GENERAL RELATIVITY theory.

**gravity** The attraction of a CELESTIAL BODY for any nearby MASS. Specifically, the downward FORCE imparted by EARTH on a mass near Earth or on its surface.

**gravity anomaly** A region on a CELESTIAL BODY where the local FORCE of GRAVITY is lower or higher than expected, assuming uniform DENSITY conditions. *See also* MASCON.

**gravity assist** The change in a SPACECRAFT'S direction and speed achieved by a carefully calculated FLYBY through a PLANET'S gravitational field. This change in spacecraft VELOCITY occurs without the use of supplementary propulsive ENERGY.

**gravity well** An analogy in which the gravitational field of a planetary body is considered as a deep well or pit out of which a SPACE VEHICLE has to climb to escape from this CELESTIAL BODY.

**gray body** A conceptual body in radiation heat transfer that absorbs some constant fraction, between zero and one, of all ELECTROMAGNETIC RADIATION incident upon it. *Compare with* BLACKBODY.

**Great Dark Spot (GDS)** A large, dark, oval-shaped feature in the clouds of NEPTUNE, discovered in 1989 by NASA'S VOYAGER 2 SPACECRAFT.

**Great Observatories Program (NASA)** The series of four highly-sophisticated astronomical observatories developed and launched by NASA to examine the UNIVERSE and objects within it at different ELECTROMAGNETIC RADIATION (EMR) WAVELENGTHS. In order of deployment and operation NASA'S four great observatories are the HUBBLE SPACE TELESCOPE (HST) (launched in 1990), the COMPTON GAMMA RAY OBSERVATORY (CGRO) (1991), the CHANDRA X-RAY OBSERVATORY (CXO) (1999), and the SPITZER SPACE TELESCOPE (SST) (2003).

**Great Red Spot (GRS)** A distinctive, oval-shaped feature in the Southern Hemisphere clouds of JUPITER, first noted by SAMUEL HEINRICH SCHWABE in 1831.

**greenhouse effect** The general warming of the lower layers of a PLANET'S ATMOSPHERE caused by the presence of greenhouse gases, such as water vapor (H<sub>2</sub>O), CARBON DIOXIDE (CO<sub>2</sub>), and methane (CH<sub>4</sub>), which prevent the escape of thermal radiation from the planet's surface to OUTER SPACE.

**green satellite** A SATELLITE in ORBIT around EARTH that collects a variety of environmental data. *See also* EARTH-OBSERVING SPACECRAFT.

**Greenwich mean time (GMT)** MEAN SOLAR TIME at the meridian of Greenwich, England, used as the basis for standard time throughout the world. It is normally expressed in four numerals, 0001 to 2400. Sometimes called ZULU TIME (*Z-time*). *See also* UNIVERSAL TIME COORDINATED.

**Gregorian calendar** A more precise version of the JULIAN CALENDAR that was devised by CHRISTOPHER CLAVIUS and introduced by Pope Gregory XIII in 1582. The changes restored 21 March as the VERNAL EQUINOX. It is now the civil CALENDAR used in most of the world.

**ground-elapsed time (GET)** The time expired since LAUNCH.

**ground support equipment (GSE)** Any nonflight equipment used for LAUNCH, CHECKOUT, or in-flight support of an expendable ROCKET, REUSABLE LAUNCH VEHICLE, SPACECRAFT, or other type of PAYLOAD.

**ground track** The path followed by a SPACECRAFT over EARTH'S surface.

**ground truth** In REMOTE SENSING, measurements made on the ground to support, confirm, or help calibrate observations made from SPACE PLATFORMS. Typical ground truth data include weather, soil conditions and types, vegetation types and conditions, and surface temperatures. Best results are obtained when these ground truth measurements are performed simultaneously with space-based SENSOR measurements.

**Guiana Space Center (Centre Spatial Guyanais [CGS])** In 1964 the French government selected Kourou, French Guiana (a remote site located on the Atlantic Ocean about 500 km above the EQUATOR) to LAUNCH its SATELLITES. Following its formation in 1975, the EUROPEAN SPACE AGENCY (ESA) has also participated in funding and operating this LAUNCH SITE—primarily to accommodate an evolving family of SPACE LAUNCH VEHICLES, the ARIANE ROCKETS. Today, CGS serves as Europe's SPACEPORT and also provides launch services to AEROSPACE

industry clients from the United States, Japan, Canada, Brazil, and India.

**guidance system** A system that evaluates flight information; correlates it with target or destination data; determines the desired flight path of the MISSILE, SPACECRAFT, or AEROSPACE VEHICLE; and communicates the necessary commands to the vehicle's flight control system.

**guided missile (GM)** A self-propelled vehicle without a crew that moves above the surface of EARTH whose TRAJECTORY or course is capable of being controlled while in flight.

**gun-launch to space (GLTS)** An advanced LAUNCH concept involving the use of a long and powerful electromagnetic launcher to hurl small SATELLITES and PAYLOADS into ORBIT.

**gyro** A device that uses the ANGULAR MOMENTUM of a spinning MASS (rotor) to sense angular motion of its base about one or two axes orthogonal (mutually perpendicular) to the spin AXIS. Also called a gyroscope.

**H I region** A diffuse region of neutral, predominantly atomic HYDROGEN in INTERSTELLAR space.

**H II region** A region in INTERSTELLAR space consisting mainly of ionized HYDROGEN and existing mostly in discrete clouds.

**habitable payload** A PAYLOAD with a pressurized compartment suitable for supporting an ASTRONAUT or COSMONAUT in a SHIRTSLEEVE ENVIRONMENT.

**Hadley Rille** A long, ancient lava channel on the MOON that was the landing site for NASA's APOLLO 15 mission. *See* APOLLO PROJECT.

**half-life** (*radioactive*) The time required for one-half of the ATOMS of a particular radioactive ISOTOPE population to disintegrate to another nuclear form. Values range from millionths of a second to billions of years.

**Halley's Comet** *See* COMET HALLEY.

**halo orbit** A circular or ELLIPTICAL ORBIT in which a SPACECRAFT remains in the vicinity of a LAGRANGIAN LIBRATION POINT.

**halophile** An extremely hardy (terrestrial) microorganism that thrives in salty water and can tolerate high doses of IONIZING RADIATION. *See also* EXTREMOPHILE.

**Ham** The primate (ASTROCHIMP) used by NASA on 31 January 1961 to test the MERCURY PROJECT SPACE CAPSULE in a suborbital flight. Ham's

**hang fire – heavy-lift launch vehicle**

successful test flight qualified the space capsule for use of by human beings during subsequent suborbital flights.

**hang fire** A faulty condition in the ignition system of a ROCKET engine.

**hard landing** A relatively high-VELOCITY impact of a LANDER SPACECRAFT or PROBE onto a solid planetary surface. The impact usually destroys all equipment, except perhaps a very rugged instrument package or PAYLOAD container.

**Harvard classification system** A method of classifying STARS by their spectral characteristics (such as O, B, A, F, G, K, and M, in order of decreasing surface temperature). WILLIAMINA PATON FLEMING and other female astronomers developed this system in the 1880s, while they were working for EDWARD CHARLES PICKERING at the HARVARD COLLEGE OBSERVATORY. *See also* MORGAN-KEENAN CLASSIFICATION SYSTEM.

**Harvard College Observatory (HCO)** The astronomical OBSERVATORY founded in 1839 at Harvard University.

**hatch** A tightly sealed access door in the pressure hull of an AEROSPACE VEHICLE, SPACECRAFT, or SPACE STATION.

**Hawking radiation** A theory proposed in 1974 by STEPHEN WILLIAM HAWKING that suggests that due to a combination of properties of QUANTUM MECHANICS and GRAVITY, under certain conditions BLACK HOLES can seem to emit radiation.

**heat death of the universe** A possible ultimate fate of the UNIVERSE suggested by RUDOLF JULIUS EMMANUEL CLAUSIUS in the 19th century. As he evaluated the consequences of the second law of thermodynamics on a grand scale, he concluded that the universe would end (die) in a condition of maximum ENTROPY in which no ENERGY was available for useful WORK.

**heat soak** The increase in the temperature of ROCKET engine components after firing has ceased. This occurs because of HEAT TRANSFER through adjoining parts of the engine when no active cooling is present.

**heat transfer** The exchange of thermal ENERGY by CONDUCTION, CONVECTION, or RADIATION within an object and between an object and its surroundings. Heat is also transferred when a working fluid undergoes phase change, such as evaporation or condensation.

**heavy-lift launch vehicle (HLLV)** A conceptual, large-capacity, space-lift vehicle capable of carrying tons of cargo into LOW EARTH ORBIT

## heliocentric – High Energy Astronomy Observatory

(LEO) at substantially less cost than today's EXPENDABLE LAUNCH VEHICLES (ELVs).

## GLOSSARY

**heliocentric** With the SUN as a center.

**heliometer** A former instrument used by astronomers to measure the diameter of the SUN or the angular separation of two STARS that appear close to each other.

**heliopause** The boundary of the HELIOSPHERE. It is thought to occur about 100 ASTRONOMICAL UNITS from the SUN and marks the edge of the Sun's influence and the beginning of INTERSTELLAR space.

**heliosphere** The region of OUTER SPACE within the boundary of the HELIOPAUSE in which the SOLAR WIND flows. Contains the SUN and the SOLAR SYSTEM.

**heliostat** A mirrorlike device designed to follow the SUN as it moves through the sky and to reflect the Sun's rays on a stationary collector.

**helium** (He) A noble gas, the second most abundant ELEMENT in the UNIVERSE. Natural helium is mostly the ISOTOPE helium 4, which contains two PROTONS and two NEUTRONS in the NUCLEUS. Helium 3 is a rare isotope of helium, containing two protons and one neutron in the nucleus. Helium was initially discovered in the SUN's SPECTRUM in 1868 by SIR JOSEPH NORMAN LOCKYER before it was found on EARTH.

**helium burning** The release of ENERGY in STARS by the thermonuclear FUSION of HELIUM to form carbon.

**hertz** (Hz) The SI UNIT of FREQUENCY. One hertz equals one cycle per second. It is named in honor of HEINRICH RUDOLF HERTZ.

**Hertzsprung-Russell (H-R) diagram** A useful graphic depiction of the different types of STARS arranged according to their SPECTRAL CLASSIFICATION and LUMINOSITY. Named in honor of the Danish astronomer EJNAR HERTZSPRUNG and the American astronomer HENRY NORRIS RUSSELL, who developed the diagram independently of each other in the early part of the 20th century. *See also* SECTION IV CHARTS & TABLES.

**high Earth orbit (HEO)** An ORBIT around EARTH at an ALTITUDE greater than 5,600 km.

**High Energy Astronomy Observatory (HEAO)** A series of three NASA ROBOT SPACECRAFT placed in ORBIT around EARTH (*HEAO-1* launched in August 1977; *HEAO-2* in November 1978; and *HEAO-3* in September 1979) to support X-RAY ASTRONOMY and GAMMA RAY

## heliocentric – High Energy Astronomy Observatory

## GLOSSARY

## GLOSSARY

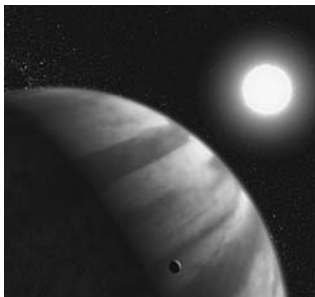

Hot Jupiter (Rendering from NASA and STScI)

## highlands – Hubble’s Law

ASTRONOMY. After LAUNCH, NASA named *HEAO-2* the *Einstein X-ray Observatory* to honor the famous German-Swiss-American physicist ALBERT EINSTEIN.

**highlands** The oldest exposed areas on the surface of the MOON; extensively cratered and chemically distinct from the MARIA.

**Hohmann transfer orbit** The most efficient orbit transfer path between two coplanar circular ORBITS. The maneuver consists of two impulsive high-THRUST burns (or firings) of a SPACECRAFT’S PROPULSION SYSTEM. The technique was suggested by WALTER HOHMANN in 1925.

**hold** To stop the sequence of events during a COUNTDOWN until an impediment has been removed so that the countdown to LAUNCH can be resumed.

**holddown test** The test of a ROCKET while it is firing but restrained in a test stand.

**Horsehead Nebula** A DARK NEBULA in the CONSTELLATION of Orion that has the shape of a horse’s head.

**hot-fire test** A liquid-fuel PROPULSION SYSTEM test conducted by actually firing the ROCKET engine(s) (usually for a short period of time) with the rocket vehicle secured to the LAUNCH PAD by holddown bolts. *Compare with* COLD-FLOW TEST.

**hot Jupiter** A JUPITER-sized PLANET in another SOLAR SYSTEM that orbits close enough to its parent STAR to have a high surface temperature.

**housekeeping** (*spacecraft*) The collection of routine tasks that must be performed to keep a SPACECRAFT functioning properly during an orbital flight or INTERPLANETARY mission.

**Hubble classification** EDWIN POWELL HUBBLE’S widely used system for classifying GALAXIES based on their visual appearance, such as round ELLIPTICAL GALAXIES, SPIRAL GALAXIES, and IRREGULAR GALAXIES.

**Hubble constant** ( $H_0$ ) The constant within HUBBLE’S LAW proposed by EDWIN POWELL HUBBLE in 1929 that establishes an EMPIRICAL relationship between the distance to a GALAXY and its VELOCITY of recession due to the expansion of the UNIVERSE. A value of 70 kilometers per second per MEGAPARSEC (km/s/Mpc)  $\pm$  7 km/s/Mpc is currently favored by astronomers.

**Hubble’s law** The hypothesis that the REDSHIFTS of distant GALAXIES are directly proportional to their distances from EARTH. EDWIN POWELL HUBBLE first proposed this relationship in 1929. It can be expressed as

## GLOSSARY

## highlands – Hubble’s Law

## Hubble Space Telescope – hydrogen

$V = H_0 \times D$ , where  $V$  is the recessional VELOCITY of a distant galaxy,  $H_0$  is the HUBBLE CONSTANT, and  $D$  is its distance from Earth.

**Hubble Space Telescope (HST)** A cooperative NASA and EUROPEAN SPACE AGENCY (ESA) program to operate a long-lived optical OBSERVATORY in ORBIT around EARTH. LAUNCHED on 25 April 1990 by NASA's SPACE SHUTTLE *Discovery* (STS-31 mission), subsequent on-orbit repair and refurbishment missions have allowed this powerful orbiting astronomical observatory to revolutionize knowledge of the size, structure, and makeup of the UNIVERSE. The TELESCOPE is named in honor of the American astronomer EDWIN POWELL HUBBLE. In October 2006, the NASA Administrator made a decision to fly a fifth space shuttle servicing mission to the orbiting telescope. This ASTRONAUT-performed servicing mission will include the incorporation of two new science instruments and will extend the telescope's operational life through 2013.

**human factors engineering** The branch of engineering involved in the design, development, testing, and construction of devices, equipment, and artificial living environments to the anthropometric, physiological, and/or psychological requirements of the human beings who will use them. One AEROSPACE example is the design of a functional MICROGRAVITY toilet that is suitable for use by both male and female ASTRONAUTS.

**Huygens probe** A scientific PROBE sponsored by the EUROPEAN SPACE AGENCY (ESA) and named after the Dutch astronomer CHRISTIAAN HUYGENS. The *Cassini* MOTHER SPACECRAFT delivered *Huygens* to SATURN and the probe successfully plunged into the nitrogen-rich ATMOSPHERE of TITAN (Saturn's largest MOON) on 14 January 2005. *See also* CASSINI-HUYGENS MISSION.

**hydrazine** ( $N_2H_4$ ) A toxic, colorless liquid that is often used as a ROCKET PROPELLANT because it reacts violently with many OXIDIZERS. It is spontaneously ignitable with concentrated hydrogen peroxide ( $H_2O_2$ ) and nitric acid.

**hydrogen** (H) A colorless, odorless gas that is the most abundant chemical ELEMENT in the universe. Hydrogen occurs as molecular hydrogen ( $H_2$ ), atomic hydrogen (H), and ionized hydrogen ( $H^+$ ) (that is, broken down into a PROTON and its companion ELECTRON). Hydrogen has three isotopic forms: PROTIUM (ordinary hydrogen), DEUTERIUM (heavy hydrogen), and TRITIUM (radioactive hydrogen). LIQUID HYDROGEN ( $LH_2$ ) is an excellent, high-performance cryogenic

## GLOSSARY

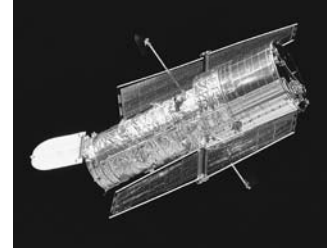

Hubble Space Telescope (HST)  
(NASA)

## Hubble Space Telescope – hydrogen

## GLOSSARY



## hydrosphere – impact

chemical PROPELLANT for ROCKET engines, especially those using LIQUID OXYGEN (LO<sub>2</sub> or LOX) as the OXIDIZER.

**hydrosphere** The water on EARTH's surface (including oceans, seas, rivers, lakes, ice caps, and glaciers) considered as an interactive system. *See also* EARTH SYSTEM.

**hyperbolic orbit** An ORBIT in the shape of a hyperbola. All INTERPLANETARY FLYBY SPACECRAFT follow hyperbolic orbits, both for EARTH departure and again upon arrival at the target PLANET. *See also* CONIC SECTION.

**hypergolic fuel** A ROCKET fuel that spontaneously ignites when brought into contact with an OXIDIZER. Also called hypergol.

**hypergolic ignition** An ignition that involves no external ENERGY source but results entirely from the spontaneous reaction of two materials (both liquid or a liquid-solid combination) when they are brought into contact.

**hypersonic** Pertaining to speeds much greater than the speed of sound, typically speeds of MACH NUMBER five ( $M = 5$ ) and greater.

**hypervelocity impact** A collision between two objects that takes place at a very high relative VELOCITY—typically at a relative speed in excess of 5 km/s. A SPACECRAFT colliding with a piece of SPACE (ORBITAL) DEBRIS or an ASTEROID striking a PLANET are examples.

**HZE particles** Very damaging COSMIC RAYS, with high ATOMIC NUMBER ( $Z$ ) and high KINETIC ENERGY ( $KE$ ).

**ice catastrophe** An extreme climate crisis in which all the liquid water on the surface of a life-bearing (or potentially life-bearing) PLANET has become frozen. *Compare with* RUNAWAY GREENHOUSE.

**Ida** A heavily cratered, irregularly shaped ASTEROID about  $56 \times 24 \times 21$  km in size that has its own tiny natural SATELLITE, DACTYL.

**igniter** A device used to start the combustion of a ROCKET engine.

**image** The representation of a physical object or scene formed by a mirror, LENS, or electro-optical recording device.

**imaging instrument** *See* CHARGE-COUPLED DEVICE.

**Imbrium basin** Large (about 1,300 km across), ancient IMPACT CRATER on the MOON.

**impact** The event or moment when a high-speed object (such as an ASTEROID, COMET, METEOROID, ROCKET, SPACECRAFT, or PROBE) strikes the surface of a planetary body

## impact crater – infrared radiation

**impact crater** The CRATER or basin formed on the surface of a planetary body as a result of the high-speed IMPACT of a METEROID, ASTEROID, or COMET.

**inclination** (*i*) One of the SIX KEPLERIAN ELEMENTS; inclination describes the ANGLE of an object's orbital plane with respect to the central body's EQUATOR. For EARTH-orbiting objects, the orbital plane always goes through the center of Earth, but it can tilt at any angle relative to the equator. By general agreement, inclination is the angle between Earth's equatorial plane and the object's orbital plane measured counterclockwise at the ascending node.

**incompressible fluid** A fluid for which the DENSITY is assumed constant.

**inertia** The resistance of a body to a change in its state of motion. MASS is an inherent property of a body that helps to quantify inertia. *See also* NEWTON'S LAWS OF MOTION.

**inertial upper stage** (IUS) A versatile orbital transfer vehicle (OTV) developed by the U.S. Air Force that uses SOLID-PROPELLANT ROCKET motors to boost a PAYLOAD from LOW EARTH ORBIT (LEO) into higher-ALTITUDE destinations. *See also* UPPER STAGE.

**"infective theory of life"** The (as yet scientifically unproven) hypothesis that some primitive form of life—perhaps selected, hardy bacteria or bioengineered microorganisms—was placed on an ancient EARTH by members of a technically advanced EXTRATERRESTRIAL civilization. *See also* PANSPERMIA.

**inferior conjunction** *See* CONJUNCTION.

**inferior planet** MERCURY or VENUS—the two MAJOR PLANETS that have ORBITS that lie inside EARTH's orbit around the SUN. *Compare with* SUPERIOR PLANET.

**infinity** ( $\infty$ ) A quantity beyond measurable limits.

**in-flight phase** The flight of a MISSILE or ROCKET from LAUNCH to detonation or IMPACT; the flight of a SPACECRAFT from launch to the time of planetary FLYBY, ENCOUNTER and ORBIT, or impact.

**infrared astronomy** The branch of ASTRONOMY dealing with INFRARED RADIATION from relatively cool celestial objects, such as INTERSTELLAR clouds of dust and gas (typically 100 K) and STARS with surface temperatures below about 6,000 K.

**infrared radiation** (IR) That portion of the ELECTROMAGNETIC (EM) SPECTRUM between the optical (visible) and radio WAVELENGTHS. The infrared region extends from about one MICROMETER ( $\mu\text{m}$ ) to 1,000  $\mu\text{m}$  wavelength.

## impact crater – infrared radiation

## GLOSSARY

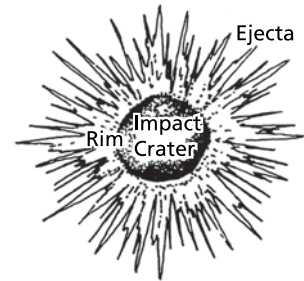

Impact crater (Courtesy of NASA)

## GLOSSARY

## GLOSSARY

### injector – interplanetary

**injector** A device that propels (injects) fuel and/or OXIDIZER into the COMBUSTION CHAMBER of a LIQUID-PROPELLANT ROCKET ENGINE. It atomizes and mixes the PROPELLANTS so they can burn more completely.

**inner planets** The TERRESTRIAL PLANETS: MERCURY, VENUS, EARTH, and MARS—all of which have ORBITS around the SUN that lie inside the main ASTEROID BELT. *Compare with* OUTER PLANETS.

**insertion** The process of putting an ARTIFICIAL SATELLITE, AEROSPACE VEHICLE, or SPACECRAFT into ORBIT.

**integration** The collection of activities leading to the compatible assembly of PAYLOAD and LAUNCH VEHICLE into the desired final (flight) configuration.

**intercontinental ballistic missile (ICBM)** A BALLISTIC MISSILE with a range in excess of 5,500 km.

**interferometer** An instrument that achieves high angular resolution by combining signals from at least two widely separated TELESCOPES (optical interferometer) or a widely a separated ANTENNA ARRAY (radio interferometer). Radio interferometers are one of the basic instruments of RADIO ASTRONOMY. *See also* VERY LARGE ARRAY.

**intergalactic** Between or among the GALAXIES.

**intermediate-range ballistic missile (IRBM)** A BALLISTIC MISSILE with a range capability from about 1,000 to 5,500 km.

**International Astronomical Union (IAU)** Founded in 1919 in Brussels, Belgium, and now headquartered in Paris, France, the IAU is the governing body for the science and professional practice of ASTRONOMY around the world. The IAU's mission is to promote and safeguard the science of astronomy in all its aspects through international cooperation.

**International Space Station (ISS)** A major human spaceflight project headed by NASA. Russia, Canada, Europe, Japan, and Brazil are also contributing key elements to this large, modular SPACE STATION in LOW EARTH ORBIT that represents a permanent human outpost in OUTER SPACE for MICROGRAVITY research and advanced space technology demonstrations. On-ORBIT assembly began in December 1998, with completion now anticipated by 2010. *See also* SECTION IV CHARTS & TABLES.

**international system of units** *See* SI UNITS.

**interplanetary** Between the PLANETS; within the SOLAR SYSTEM.



*International Space Station (ISS) (NASA)*

## GLOSSARY

### injector – interplanetary

## interplanetary dust – ion

**interplanetary dust** (IPD) Tiny PARTICLES of matter (generally less than 100 MICROMETERS [ $\mu\text{m}$ ] in diameter) that exist in OUTER SPACE within the confines of this SOLAR SYSTEM. *See also* ZODIACAL LIGHT.

**interstage section** A section of a MISSILE or ROCKET that lies between stages. *See also* STAGING.

**interstellar** Between or among the STARS.

**interstellar communication and contact** Several methods of achieving contact with (postulated) intelligent EXTRATERRESTRIAL beings have been suggested. These include: (1) INTERSTELLAR travel by means of STARSHIPS, leading to physical contact between different civilizations; (2) indirect contact through the use of robot INTERSTELLAR PROBES; (3) serendipitous contact, such as finding a derelict alien starship or probe drifting in the outer regions of humans' SOLAR SYSTEM; (4) interstellar communication involving the transmission and reception of ELECTROMAGNETIC RADIATION (EMR) signals; and (5) very "exotic" techniques involving information transfer through the MODULATION of GRAVITONS, NEUTRINOS, or possibly distortions in the SPACE-TIME continuum. *See also* SEARCH FOR EXTRATERRESTIAL INTELLIGENCE.

**interstellar medium** (ISM) The gas and tiny dust PARTICLES found between the STARS in this GALAXY. Over 100 different MOLECULES have been discovered in INTERSTELLAR space, including many organic molecules.

**interstellar probe** A conceptual, highly automated ROBOT SPACECRAFT launched by human beings from this SOLAR SYSTEM (or perhaps by intelligent alien beings from some other solar system) to explore nearby STAR systems.

**intravehicular activity** (IVA) ASTRONAUT or COSMONAUT activities performed inside an orbiting SPACECRAFT or AEROSPACE VEHICLE. *Compare with* EXTRAVEHICULAR ACTIVITY.

**inverse square law** A relationship between physical quantities of the form  $x$  proportional to  $1/y^2$ , where  $y$  is usually a distance and  $x$  terms are of two kinds—FORCES and FLUXES.

**inviscid fluid** A hypothesized perfect fluid that has zero coefficient of viscosity (internal resistance to flow).

**Io** The pizza-colored, volcanic GALILEAN SATELLITE of JUPITER with a diameter of 3,630 km.

**ion** An ATOM or MOLECULE that has lost or (more rarely) gained one or more ELECTRONS. By this ionization process, it becomes electrically charged.

## interplanetary dust – ion

## GLOSSARY

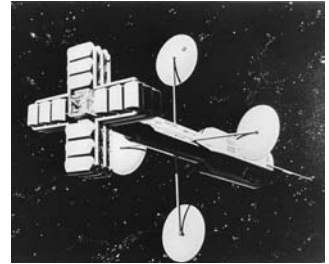

Interstellar probe (NASA)

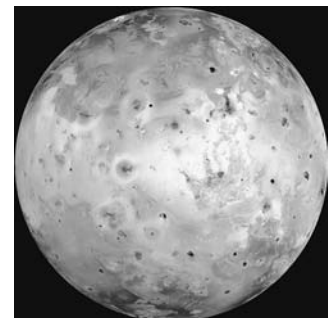

Io (NASA)

## GLOSSARY

## GLOSSARY

Ion engine (NASA)

## ion engine – island universe

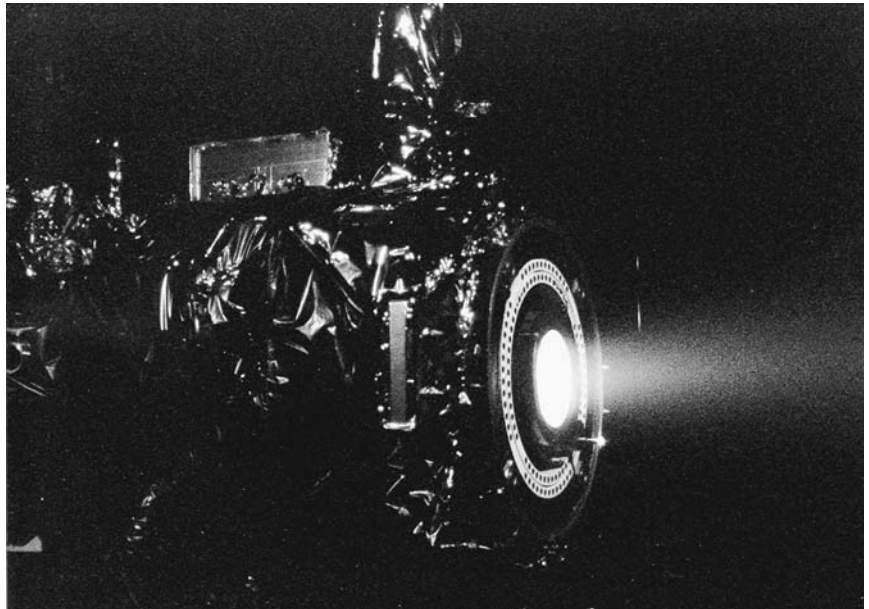

**ion engine** An electrostatic ROCKET engine in which a PROPELLANT (for example, cesium, mercury, argon, or xenon) is ionized and the propellant IONS are accelerated by an imposed electric field to very high exhaust VELOCITY. *See also* ELECTRIC PROPULSION.

**ionizing radiation** Any type of nuclear radiation that displaces ELECTRONS from ATOMS or MOLECULES, thereby producing IONS within the irradiated material. Examples include alpha ( $\alpha$ ) radiation, beta ( $\beta$ ) radiation, gamma ( $\gamma$ ) radiation, PROTONS, NEUTRONS, and X-RAYS. *See also* ALPHA PARTICLE; BETA PARTICLE; GAMMA RAY.

**ionosphere** That portion of EARTH's upper ATMOSPHERE, extending from about 50 to 1,000 km, in which IONS and free ELECTRONS exist in sufficient quantity to reflect RADIO WAVES.

**irregular galaxy** A GALAXY with a poorly defined structure or shape. *See also* HUBBLE CLASSIFICATION.

**Ishtar Terra** A very large highland plateau in the northern hemisphere of VENUS, about 5,000 km long and 600 km wide.

**island universe** Term coined in the 18th century by the German philosopher IMMANUEL KANT to describe distant collections of STARS—now called GALAXIES.

## GLOSSARY

## ion engine – island universe

**isotope** One of two or more ATOMS with the same ATOMIC NUMBER (*Z*) (that is, the same chemical ELEMENT) but with different ATOMIC WEIGHTS.

**isotropic** Having uniform properties in all directions.

**James Webb Space Telescope (JWST)** Planned for LAUNCH by NASA in 2013 from the GUIANA SPACE CENTER, using a EUROPEAN SPACE AGENCY (ESA)–supplied ARIANE 5 ROCKET, the *James Webb Space Telescope* will contain the largest mirror ever placed in space. The TELESCOPE's large folding and segmented primary mirror will provide about seven times the LIGHT-collecting area of the mirror on the *HUBBLE SPACE TELESCOPE*. The *JWST* will have four instruments sensitive to INFRARED RADIATION WAVELENGTHS from 0.6 to 27 MICROMETERS, and data from these instruments will greatly extend the astronomical discoveries achieved by the *Hubble Space Telescope*, the *SPITZER SPACE TELESCOPE*, and giant ground-based observatories, like the KECK OBSERVATORY. Following launch, the *JWST* will operate in a HELIOCENTRIC ORBIT about 1.6 million km from EARTH at the LAGRANGIAN LIBRATION POINT,  $L_2$ . Previously called the *Next Generation Space Telescope*, NASA named the giant space telescope in honor of JAMES E. WEBB, the APOLLO PROJECT–era administrator of the civilian space agency. *JWST* is the result of international collaboration among NASA, ESA, and the Canadian Space Agency.

**jansky** (Jy) A unit used to describe the strength of an incoming signal of ELECTROMAGNETIC RADIATION. It is named in honor of KARL GUTHE JANSKY and is commonly used in RADIO ASTRONOMY and INFRARED ASTRONOMY. One jansky (Jy) of signal strength equals  $10^{-26}$  WATTS per meter squared per HERTZ ( $W/[m^2\text{-Hz}]$ ).

**Japanese Space Exploration Agency (JAXA)** In October 2003, Japanese officials formed JAXA by merging three agencies that had previously promoted aeronautical and space activities within that nation. JAXA is exclusively engaged in the peaceful applications of space technology and exploration. Activities include the development of SATELLITES and LAUNCH VEHICLES and participation in the *INTERNATIONAL SPACE STATION*.

**jettison** To discard or toss away.

**joule** (J) The SI UNIT of ENERGY or WORK. One joule is the work done by a FORCE of one NEWTON moving through a distance of one meter. Named after James Prescott Joule.

**Jovian planet** A large (JUPITER-like) PLANET characterized by a great total MASS, low average DENSITY, mostly liquid interior, and an abundance

## GLOSSARY



Jupiter (Courtesy of NASA/JPL)

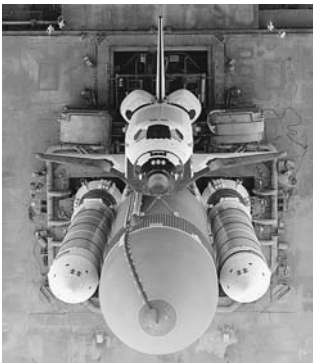

Shuttle launch preparations at Kennedy Space Center (KSC) (NASA)

## GLOSSARY

### Julian calendar – Kennedy Space Center

of the lighter ELEMENTS (especially HYDROGEN and HELIUM). In this SOLAR SYSTEM, the Jovian planets are Jupiter, SATURN, URANUS, and NEPTUNE.

**Julian calendar** The 12-month (approximately 365-day) CALENDAR introduced by the Roman Emperor Julius Caesar in 46 B.C.E. *See also* GREGORIAN CALENDAR.

**Jupiter** The fifth PLANET from the SUN and the largest in the SOLAR SYSTEM, with more than twice the MASS of all the other planets and their MOONS combined. Its thick, cold ATMOSPHERE consists primarily of HYDROGEN and HELIUM in approximately stellar composition—that is, about 89 percent HYDROGEN and 11 percent HELIUM. *See also* SECTION IV CHARTS & TABLES.

**Jupiter C** A modified version of the REDSTONE BALLISTIC MISSILE developed by the U.S. Army and a direct technical descendant of the Germany's World War II VENGEANCE WEAPON 2 (V-2) ROCKET. The Juno I, a four-stage configuration of the Jupiter C ROCKET, launched the first American SATELLITE (*EXPLORER 1*) into orbit around EARTH from CAPE CANAVERAL late in the evening on 31 January 1958 (local time).

**Kapustin Yar** A minor, early Russian LAUNCH SITE that is located on the banks of the Volga River near Volgograd at approximately 48.4° north latitude and 45.8° east longitude.

**Keck Observatory** Located near the 4,200-m high summit of Mauna Kea, Hawaii, the W. M. Keck Observatory possesses two of the world's largest optical/infrared REFLECTOR TELESCOPES, each with a 10-m diameter primary mirror. Keck I started astronomical observations in May 1993, and its twin, Keck II, in October 1996. The pair of TELESCOPES can operate as an optical INTERFEROMETER. *See also* INFRARED ASTRONOMY.

**kelvin** (K) The SI UNIT of absolute thermodynamic temperature, honoring WILLIAM THOMSON, LORD KELVIN. By international agreement, 1 K represents the fraction 1/273.16 of the thermodynamic temperature of the triple point of water.

**Kennedy Space Center (KSC)** Spawling NASA SPACEPORT on the east central coast of Florida adjacent to CAPE CANAVERAL Air Force Station. LAUNCH SITE (Complex 39) and primary landing/recovery site for the SPACE SHUTTLE until the system's retirement in 2010. Starting in about 2015, NASA will use KSC to conduct operational missions involving the ARES I and ARES V LAUNCH VEHICLES.

### Julian calendar – Kennedy Space Center

## Keplerian elements – “laboratory hypothesis”

## GLOSSARY

**Keplerian elements** The six parameters that uniquely specify the position and path of a SATELLITE (natural or human made) in its ORBIT as a function of time. The elements and their characteristics are described in SECTION IV CHARTS & TABLES.

**Kepler Mission** Scheduled for LAUNCH in 2009, NASA’s *Kepler* SPACECRAFT carries a unique space-based TELESCOPE specifically designed to search for EARTHLIKE PLANETS around other suitable STARS. Named after the German astronomer and mathematician JOHANNES KEPLER.

**Kepler’s laws** The three EMPIRICAL laws describing the motion of the PLANETS in their ORBITS around the SUN, formulated by JOHANNES KEPLER in the early 17th century. The laws are (1) the orbits of the planets are ELLIPSES, with the Sun at a common focus, (2) as a planet moves in its orbit, the line joining the planet and the Sun sweeps over equal areas in equal intervals of time, and (3) the square of the (orbital) PERIOD of any planet is proportional to the cube of its mean distance from the Sun (that is, the semimajor axis for the ELLIPTICAL ORBIT).

**Kerr black hole** As first proposed by ROY PATRICK KERR in 1963, a BLACK HOLE that is rotating, in contrast to a SCHWARZSCHILD BLACK HOLE, which does not rotate.

**kinetic energy** ( $KE$  or  $E_{KE}$ ) The ENERGY an object possesses as a result of its motion. In Newtonian (nonrelativistic) mechanics, kinetic energy is one-half the product of MASS ( $m$ ) and the square of its VELOCITY ( $v$ ), that is  $E_{KE} = 1/2mv^2$ .

**Kirkwood gaps** Regions in the main ASTEROID BELT devoid of ASTEROIDS. This condition was explained by DANIEL KIRKWOOD in 1857 as being the result of complex orbital resonances with JUPITER (that is, periodic gravitational tugs in certain ORBITS). *See also* MAIN-BELT ASTEROID.

**Kuiper belt** A region in the outer SOLAR SYSTEM beyond NEPTUNE out to perhaps 1,000 ASTRONOMICAL UNITS that contains millions of icy PLANETESIMALS. These icy objects range in size from tiny particles to PLUTO-sized planetary bodies. GERARD PETER KUIPER first suggested the existence of a disk-shaped reservoir of icy objects in 1951. *See also* OORT CLOUD.

**“laboratory hypothesis”** A variation of the ZOO HYPOTHESIS response to the FERMI PARADOX. This particular hypothesis suggests that the reason scientists cannot detect or interact with technically advanced EXTRATERRESTRIAL civilizations in the MILKY WAY GALAXY is because they are treating humans’ SOLAR SYSTEM as a “perfect

## Keplerian elements – “laboratory hypothesis”

## GLOSSARY



## GLOSSARY

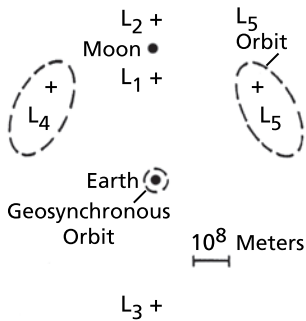

Lagrangian libration points  
(Courtesy of author)

## Langrangian libration points – launch window

laboratory”—a laboratory in which scientific observations do not interfere with or influence the objects under study. *See also* FERMI PARADOX; ZOO HYPOTHESIS.

**Lagrangian libration points** The five points in OUTER SPACE (called  $L_1$ ,  $L_2$ ,  $L_3$ ,  $L_4$ , and  $L_5$ ) where a small object can experience a stable ORBIT in spite of the FORCE of GRAVITY exerted by two much more massive CELESTIAL BODIES when they orbit about a common CENTER OF MASS. JOSEPH-LOUIS LAGRANGE calculated the existence and location of these points in 1772.

**lander** (*spacecraft*) A SPACECRAFT designed to reach the surface of a PLANET or MOON safely and to survive long enough on the planetary body to collect useful scientific data that it sends back to EARTH by TELEMETRY.

**LANDSAT** The family of versatile, NASA-developed, EARTH-OBSERVING SPACECRAFT that have demonstrated numerous applications of space-based MULTISPECTRAL SENSING since 1972. *See also* REMOTE SENSING.

**Large Magellanic Cloud (LMC)** An IRREGULAR GALAXY about 20,000 LIGHT-YEARS in diameter and approximately 160,000 light-years from EARTH. *See also* MAGELLANIC CLOUDS.

**launch** (1) (*noun*) The action that occurs when a ROCKET or AEROSPACE VEHICLE propels itself from a planetary surface.  
(2) (*verb*) To send off a rocket or MISSILE under its own propulsive power.

**launch azimuth** The initial compass heading of a ROCKET vehicle at LAUNCH.

**launchpad** The load-bearing base or platform from which a ROCKET, MISSILE, or AEROSPACE VEHICLE is launched.

**launch site** The extensive, well-defined area used to launch ROCKET vehicles for operational or for test purposes. Also called the launch complex.

**launch vehicle (LV)** An expendable (ELV) or reusable (RLV) ROCKET-propelled vehicle that provides sufficient THRUST to place a SPACECRAFT into ORBIT around EARTH or to send a PAYLOAD on an INTERPLANETARY TRAJECTORY to another CELESTIAL BODY. Sometimes called booster or space lift vehicle. *See also* SECTION IV CHARTS & TABLES.

**launch window** An interval of time during which a LAUNCH may be made to satisfy some mission objective. Sometimes it is just a short period each day for a certain number of days.

## GLOSSARY

## Langrangian libration points – launch window

## lens – line of apsides

**lens** A curved piece of glass polished and carefully shaped to focus LIGHT from a distant object so as to form an IMAGE of that object (CONVERGING LENS) or to spread light out as if it came from a main focus (DIVERGING LENS).

**Lick Observatory** An astronomical observatory located at an ALTITUDE of 1,280 m on Mount Hamilton near San Jose, California. When endowed in 1888 by the philanthropist James Lick (1796–1876) to the University of California, the observatory's major instrument was a powerful 0.91-m diameter REFRACTING TELESCOPE. Today, the observatory's principal instrument is a 3-m REFLECTING TELESCOPE.

**life support system (LSS)** The system that maintains life throughout the entire AEROSPACE flight environment, including (as appropriate) travel in OUTER SPACE, activities on the surface of another world (for example, the LUNAR surface), and ascent and descent through EARTH'S ATMOSPHERE. The LSS must reliably satisfy a human crew's daily needs for clean AIR, potable water, food, and effective waste removal.

**liftoff** The action of a ROCKET or AEROSPACE VEHICLE as it separates from its LAUNCH PAD in a vertical ascent.

**light** The portion of the ELECTROMAGNETIC (EM) SPECTRUM that can be seen by the human eye. Visible light (radiation) ranges from approximately 750 NANOMETERS (nm) (long WAVELENGTH, red) to about 370 (nm) (short wavelength, violet).

**light-gathering power (LGP)** The ability of a TELESCOPE or other optical instrument to collect LIGHT.

**light pollution** Human-generated, artificial LIGHT sources (such as city lights) that interfere with EARTH-based optical ASTRONOMY.

**light time** The amount of time needed for LIGHT or RADIO WAVE signals to travel a certain distance at optical VELOCITY (that is,  $c = 299,792.5$  km/s). For example, one light-second corresponds to a distance of approximately 300,000 km.

**light-year (ly)** The distance LIGHT (or other forms of ELECTROMAGNETIC RADIATION) can travel in one year. One light-year equals a distance of approximately  $9.46 \times 10^{12}$  km or 63,240 ASTRONOMICAL UNITS (AU).

**limb** The visible outer edge or observable rim of the DISK of a CELESTIAL BODY.

**line of apsides** The line connecting the two points of an ORBIT that are nearest and farthest from the center of attraction, such as the PERIGEE and APOGEE of a SATELLITE in orbit around EARTH.

## lens – line of apsides

## GLOSSARY



Liftoff (NASA)

## GLOSSARY

## GLOSSARY

### line of sight – long-period comet

**line of sight (LOS)** The straight line between a SENSOR or the eye of an observer and the object or point being observed. Sometimes called the optical path.

**liquid hydrogen (LH<sub>2</sub>)** A cryogenic liquid PROPELLANT used as the fuel, with LIQUID OXYGEN serving as the OXIDIZER, in high-performance ROCKET engines. HYDROGEN remains a liquid only at very low (cryogenic) temperatures, typically about 20 K (–253°C) or less, imposing special storage and handling requirements.

**liquid oxygen (LOX or LO<sub>2</sub>)** A cryogenic liquid PROPELLANT often used as an OXIDIZER with RP-1 fuel in many EXPENDABLE LAUNCH VEHICLES or with LIQUID HYDROGEN fuel in high-performance LIQUID-PROPELLANT ROCKET ENGINES, like NASA'S SPACE SHUTTLE main engines. LOX requires storage at temperatures below 90°K (–183°C).

**liquid propellant** Any combustible liquid fed into the COMBUSTION CHAMBER of a liquid-fueled ROCKET engine.

**liquid-propellant rocket engine** A ROCKET engine that uses chemical propellants in liquid form for both the fuel and OXIDIZER.

**lithium hydroxide (LiOH)** A white crystalline compound used for removing CARBON DIOXIDE from a closed ATMOSPHERE, such as found on a crewed SPACECRAFT, AEROSPACE VEHICLE, or SPACE STATION. SPACESUIT LIFE SUPPORT SYSTEMS also use lithium hydroxide canisters to purge the suit's closed atmosphere of the carbon dioxide exhaled by the ASTRONAUT occupant.

**little green men (LGM)** A science fiction expression for EXTRATERRESTRIAL beings, presumably intelligent.

**Local Group** A small cluster of about 30 GALAXIES, of which the MILKY WAY GALAXY (humans' home galaxy) and the ANDROMEDA GALAXY are dominant members.

**Long March (LM)** The family of EXPENDABLE LAUNCH VEHICLES developed by the People's Republic of China. The Long March 2 (LM-2), or Changzheng-2C (CZ-2C), was first launched in 1975. The first two stages of this ROCKET vehicle use HYPERGOLIC FUEL, and there is an optional UPPER STAGE, that uses a SOLID-PROPELLANT ROCKET. The LM-2 can place a PAYLOAD of approximately 3,175 kg into LOW EARTH ORBIT (LEO). *See also* SECTION IV CHARTS & TABLES.

**long-period comet** A COMET with an orbital PERIOD around the SUN greater than 200 years. *Compare with* SHORT-PERIOD COMET.

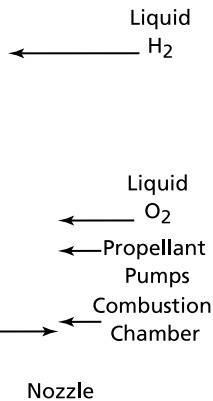

Liquid-propellant rocket engine (Courtesy of NASA)

## GLOSSARY

### line of sight – long-period comet

**low Earth orbit – Lunar Reconnaissance Orbiter**

**GLOSSARY**

**low Earth orbit (LEO)** A circular ORBIT just above EARTH'S SENSIBLE ATMOSPHERE at an ALTITUDE of between 300 to 400 km.

**luminosity (*L*)** The rate at which a STAR or other luminous object emits ENERGY, usually in the form of ELECTROMAGNETIC RADIATION. The luminosity of the SUN is about  $4 \times 10^{26}$  WATTS. *See also* STEFAN-BOLTZMANN LAW.

**luminosity class** *See* STELLAR LUMINOSITY CLASS.

**Luna** A series of Russian SPACECRAFT sent to explore the MOON in the 1960s and 1970s.

**lunar** Of or pertaining to EARTH'S natural SATELLITE, the MOON.

**lunar base** A permanently inhabited complex on the surface of the MOON. It is the next logical step after brief human exploration expeditions, like NASA'S APOLLO PROJECT.

**lunar crater** A depression, usually circular, on the surface of the MOON. *See also* IMPACT CRATER.

**lunar day** The period of time the MOON takes to make one complete ORBIT OF EARTH, about 27.3 Earth days. One lunar day is a SIDEREAL month.

**lunar excursion module (LEM)** *See* LUNAR MODULE.

**lunar highlands** The light-colored, heavily cratered mountainous part of the MOON'S surface.

**lunar module (LM)** The LANDER SPACECRAFT used by NASA to deliver ASTRONAUTS to surface of MOON during the APOLLO PROJECT.

**lunar orbiter** A SPACECRAFT placed into ORBIT around the MOON. Specifically, the series of five *Lunar Orbiter* spacecraft NASA used from 1966–67 to photograph the Moon's surface precisely in support of the APOLLO PROJECT.

**lunar probe** A PLANETARY PROBE for exploring and reporting conditions on or about the MOON. *See also* LUNA; RANGER PROJECT.

**Lunar Prospector** A NASA ORBITER SPACECRAFT that circled the MOON from 1998–99, searching for mineral resources. Data suggest the possible presence of LUNAR (water) ice deposits in permanently shadowed polar regions.

**Lunar Reconnaissance Orbiter (LRO)** The first mission in NASA'S planned return to the MOON program. *LRO* is scheduled for LAUNCH in late April 2009. This ROBOT SPACECRAFT will create a comprehensive atlas of the Moon's resources and features necessary to design and build a LUNAR outpost. Specific

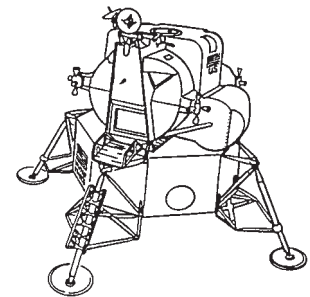

Lunar module

**low Earth orbit – Lunar Reconnaissance Orbiter**

**GLOSSARY**

## GLOSSARY

### lunar rover – *Lunokhod*

objectives for the mission include finding safe landing sites, locating potential resources, and characterizing the SPACE RADIATION ENVIRONMENT in preparation for the return of human beings to the lunar surface in about 2020. *See also* CONSTELLATION PROGRAM.

**lunar rover** Crewed or automated (robot) rover vehicles used to explore the MOON's surface. NASA's lunar rover vehicle (LRV) served as a Moon car for APOLLO PROJECT ASTRONAUTS during the *Apollo 15, 16, and 17* human expeditions to the LUNAR surface. Russian *LUNOKHOD 1* and 2 robot rovers were operated on the Moon from EARTH between 1970 and 1973.

***Lunokhod*** A Russian eight-wheeled robot vehicle, controlled by RADIO WAVE signals from EARTH, and used to perform LUNAR surface exploration during the *LUNA 17* (1970) and *Luna 21* (1973) missions to the MOON.

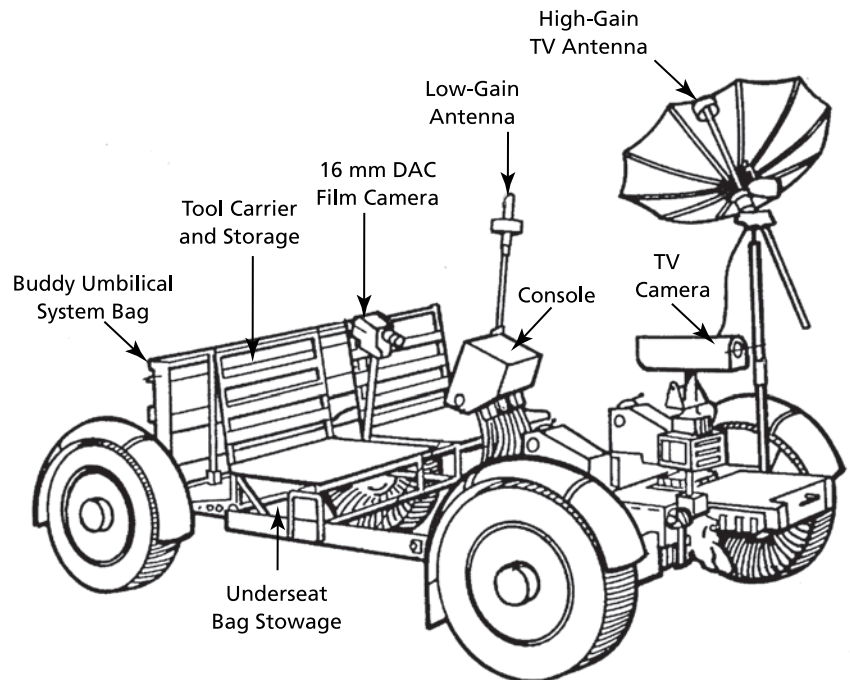

Lunar rover (Courtesy of NASA)

## GLOSSARY

### lunar rover – *Lunokhod*

## Mach number – magnetohydrodynamics



## GLOSSARY

*Lunokhod 1* on stamp from former German Democratic Republic (the author)

**Mach number ( $M$ )** The ratio of the speed of an object (with respect to the surrounding AIR) to the speed of sound in air. If  $M < 1$ , ERNST MACH called the flow subsonic. If  $M > 1$ , the flow is supersonic and disturbances cannot propagate ahead of the flow, so shock waves form. When  $M = 1$ , the flow is sonic.

**MACHO** The *massive compact halo object* hypothesized to populate the outer regions (or halo) of GALAXIES, accounting for most of the DARK MATTER. Current theories suggest that MACHOs might be low-luminosity STARS, JOVIAN PLANETS, or possibly BLACK HOLES. *See also* WIMP.

**Magellanic Clouds** The two dwarf, irregularly shaped neighboring GALAXIES that are closest to humans' MILKY WAY GALAXY. The LARGE MAGELLANIC CLOUD (LMC) is about 160,000 light-years away, and the SMALL MAGELLANIC CLOUD (SMC) is approximately 180,000 light-years away. Both can be seen with the NAKED EYE in the Southern Hemisphere. Their presence was first recorded in 1519 by the Portuguese explorer FERDINAND MAGELLAN, after whom they are named.

**Magellan mission** The NASA planetary ORBITER SPACECRAFT that used its radar-imaging system to make detailed surface maps of cloud-covered VENUS from 1990–94. It is named after the Portuguese explorer FERDINAND MAGELLAN. *See also* RADAR ASTRONOMY.

**magma** Molten rock beneath the surface of a PLANET or MOON. It may be ejected to the surface by volcanic activity.

**magnetohydrodynamics (MHD)** The branch of physics that studies the interactions between a magnetic field and a conducting fluid (such as a PLASMA).



Magellan spacecraft (NASA)

## Mach number – magnetohydrodynamics

## GLOSSARY

## GLOSSARY

Magnitude (Courtesy of NASA)

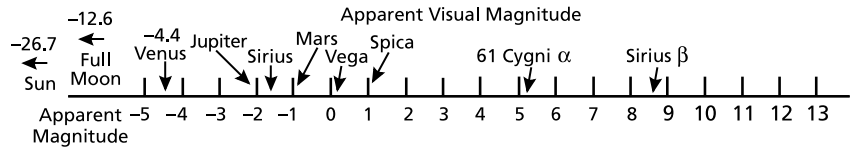

**magnetometer** An instrument for measuring the strength and sometimes the direction of a magnetic field.

**magnetosphere** The region around a PLANET in which charged atomic PARTICLES are influenced (and often trapped) by the planet's own magnetic field rather than the magnetic field of the SUN as projected by the SOLAR WIND.

**magnitude** A number, measured on a logarithmic scale, that indicates the relative brightness of a celestial object. The smaller the magnitude number, the greater the brightness. Ancient astronomers called the brightest STARS of the night sky stars of the first magnitude, because they were the first visible after sunset. Other stars were called second-, third-, fourth-, fifth-, and sixth-magnitude stars according to their relative brightness. Sixth-magnitude stars are the faintest stars visible to the NAKED EYE. In 1856, NORMAN ROBERT POGSON proposed a more precise logarithmic magnitude in which a difference of five magnitudes represents a relative brightness ratio of 100 to 1, while a difference of one magnitude is 2.512. This scale is now widely used in modern ASTRONOMY.

**main-belt asteroid** An asteroid located in the ASTEROID BELT between MARS and JUPITER.

**main-sequence star** A STAR in the prime of its life that shines with a constant LUMINOSITY achieved by steadily converting HYDROGEN into HELIUM through thermonuclear FUSION in its core.

**main stage** For a MULTISTAGE ROCKET vehicle, the stage that develops the greatest amount of THRUST.

**major planet** In humans' SOLAR SYSTEM the major planets are: MERCURY, VENUS, EARTH, MARS, JUPITER, SATURN, URANUS, and NEPTUNE. By international agreement within the astronomical community, PLUTO is now regarded as a DWARF PLANET. *See also* PLANET.

**manipulator** The part of a robot capable of grasping or handling. It is a mechanical device designed to handle objects, such as the REMOTE MANIPULATOR SYSTEM (RMS) on NASA'S SPACE SHUTTLE.

## GLOSSARY

### magnetometer – manipulator

## manned – *Mars Express*

**manned** An AEROSPACE VEHICLE or system that is occupied by one or more persons, male or female. The terms *crewed*, *human*, or *personed* are preferred to *manned* today in the aerospace literature. For example, a “manned mission to MARS” should be called a “human mission to Mars.”

**maria** (*singular: mare*) Latin word for “seas.” Originally used by the Italian astronomer GALILEO GALILEI to describe the large, dark ancient lava flows on the LUNAR surface, since he and other seventeenth century astronomers thought these features were bodies of water on the MOON’s surface. Following tradition, this term is still used by modern astronomers.

**Mariner** A series of NASA planetary exploration SPACECRAFT that performed FLYBY and orbital missions to MERCURY, MARS, and VENUS in the 1960s and 1970s.

**Mars** The red-colored fourth PLANET in the SOLAR SYSTEM that intrigued ancient astronomers and now serves as the focus of extensive investigation by a variety of FLYBY, ORBITER, and LANDER spacecraft seeking to answer the key question, Does (or did) Mars have life?

**Mars base** The surface base needed to support human explorers during a MARS EXPEDITION.

**Mars expedition** The first crewed mission to visit MARS in this century. Current concepts suggest a 600- to 1,000-day duration mission (starting from EARTH ORBIT), a total crew size of up to 15 ASTRONAUTS, and about 30 days for surface excursion activities on Mars.

**Mars Exploration Rover (MER) 2003 mission** In 2003, NASA launched identical twin MARS ROVERS designed to operate on the surface of the RED PLANET. *Spirit* (MER-A) was launched from CAPE CANAVERAL on 10 June 2003 and successfully landed on MARS on 4 January 2004. *Opportunity* (MER-B) was launched from Cape Canaveral on 7 July 2003 and successfully landed on Mars on 25 January 2004. Both SOFT LANDINGS used the airbag bounce and roll arrival demonstrated during the MARS PATHFINDER mission. *Spirit* landed in Gusev Crater and *Opportunity* landed at Terra Meridiania. As of December 2008, *Spirit* and *Opportunity* continued to function on the surface of Mars, but *Spirit* in low-power mode.

**Mars Express** A mission to MARS developed by the EUROPEAN SPACE AGENCY and the Italian Space Agency and LAUNCHED in June 2003. After the SPACECRAFT arrived at the RED PLANET in December 2003, its instruments began studying the PLANET’S ATMOSPHERE and surface

## manned – *Mars Express*

## GLOSSARY



Mariner 2 spacecraft (NASA)

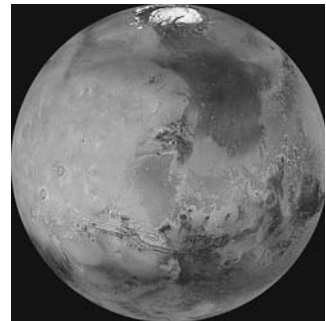

Mars (NASA)



Mars expedition (Courtesy of NASA)

## GLOSSARY



from a POLAR ORBIT. The main science objective involved the search for suspected subsurface water locations. The mission's MOTHER SPACECRAFT also delivered a small LANDER (named *Beagle 2*). However, on 25 December 2003, all contact was lost with *Beagle 2* after it entered the MARTIAN atmosphere and tried to land. Despite this problem, *Mars Express* accomplished its main goal of global high-resolution photogeology and mineralogical mapping of the Martian surface.

***Mars Global Surveyor*** (MGS) A NASA ORBITER SPACECRAFT launched from CAPE CANAVERAL in November 1996 that began performing detailed scientific studies of the MARTIAN surface and ATMOSPHERE in March 1999. The Mars Global Surveyor stopped communicating with NASA mission controllers on EARTH on 2 November 2006.

***Mars Odyssey*** Launched from CAPE CANAVERAL by NASA in April 2001, the 2001 *Mars Odyssey* is an ORBITER SPACECRAFT designed to conduct a detailed exploration of MARS with emphasis being given to the search for geological features that would indicate the presence of water, either flowing on the surface in the past or currently frozen in subsurface reservoirs. The spacecraft's primary science mission continued through August 2004, after which *Odyssey* functioned on an extended mission that included service as a communications relay for the MARS EXPLORATION ROVERS (*Spirit* and *Opportunity*).

***Mars Pathfinder*** An innovative NASA mission that successfully landed a MARS SURFACE ROVER—a small robot called *Sojourner*—in the Ares Vallis region of the RED PLANET in July 1997. For over 80 days, personnel on EARTH used TELEOPERATION and TELEPRESENCE to drive the six-wheeled minirover cautiously to interesting locations on the MARTIAN surface.

***Mars Reconnaissance Orbiter*** (*MRO*) On 12 August 2005, NASA launched the *Mars Reconnaissance Orbiter* from CAPE CANAVERAL. The SPACECRAFT reached MARS on 10 March 2006. After a six-month long process of adjusting and trimming the shape of its ORBIT around the RED PLANET, *MRO* started performing its high-resolution mapping mission of the surface.

**Mars surface rovers** Automated robot rovers and human-crewed mobility systems used to satisfy a number of surface exploration objectives on MARS in this century.

**Martian** Of or relating to the planet MARS.

**Martian meteorites** The collection of a dozen or so unusual METEORITES considered to represent pieces of MARS that were blasted off the RED

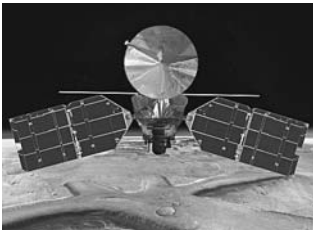

*Mars Reconnaissance Orbiter*  
(NASA)

## mascon – Mercury Project

PLANET by ancient impact collisions, wandered through space for millions of years, and eventually landed on EARTH. In 1996, NASA scientists suggested that one particular specimen, called ALH84001, might contain fossilized evidence showing primitive life may have existed on Mars more than 3.6 billion years ago.

**mascon** An area of abnormal MASS concentration (mascon) or high DENSITY on the MOON beneath the LUNAR MARIA.

**mass** (*m*) Mass describes how much material makes up an object and gives rise to its INERTIA. The SI UNIT for mass is the kilogram (kg). An object that has 1 kg mass on EARTH will also have 1 kg mass on the surface of MARS or anywhere else in the UNIVERSE.

**mass fraction** The fraction of a ROCKET's (or rocket stage's) MASS that is taken up by PROPELLANT. The remaining mass is structure and PAYLOAD.

**mass number** (*A*) The number of NUCLEONS (that is, PROTONS and NEUTRONS) in an atomic NUCLEUS. It is the nearest whole number to an ATOM's ATOMIC WEIGHT. For example, the mass number of the ISOTOPE uranium 235 is 235.

**mating** The act of fitting together two major components of an AEROSPACE system, such as the mating of a LAUNCH VEHICLE and its PAYLOAD—a scientific SPACECRAFT. It is also the physical joining of two orbiting spacecraft either through a DOCKING or a BERTHING process.

**Maxwell Montes** A mountain range on VENUS located in ISHTAR TERRA, containing the highest peak (11 km ALTITUDE) on the PLANET. It is named after JAMES CLERK MAXWELL.

**mean solar time** The time shown on the clock that is based on EARTH's ROTATION, which was originally assumed constant. *See also* GREENWICH MEAN TIME.

**megaparsec** (Mpc) 1 million PARSECS; a distance of approximately 3,260,000 LIGHT-YEARS.

**Mercury** The innermost PLANET in the SOLAR SYSTEM, orbiting the SUN at approximately 0.4 ASTRONOMICAL UNITS.

**Mercury Project** The initial United States ASTRONAUT program (1958–63) in which NASA selected seven military test pilots with the “right stuff” to become the first Americans to fly into OUTER SPACE. They flew in cramped, one-person SPACE CAPSULES, such as JOHN HERSCHEL GLENN, JR.'s *Friendship 7* Mercury capsule.

## mascon – Mercury Project

## GLOSSARY

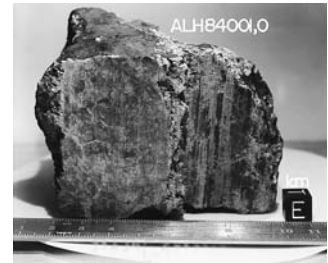

Martian meteorite (ALH84001) (NASA)

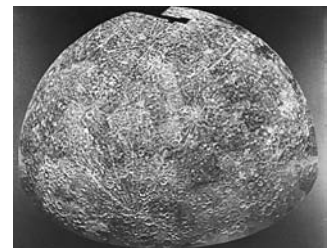

Mercury (Courtesy of NASA/JPL)

## GLOSSARY

**Messenger spacecraft** NASA LAUNCHED the *Messenger* SPACECRAFT to the PLANET MERCURY from CAPE CANAVERAL on 3 August 2004. This mission is also called the *Mercury Surface, Space Environment, Geochemistry, and Ranging* mission. Following FLYBYS of three planets (EARTH once, VENUS twice, and Mercury three times), *Messenger* will finally be able to ease into a stable working ORBIT around Mercury in March 2011. Once in this working orbit, the spacecraft will begin its primary science mission.

**Messier catalogue** A compilation of bright celestial objects, such as NEBULAS and GALAXIES, developed by CHARLES MESSIER in the late 18th century. Astronomers still use MESSIER object nomenclature—for example, the ORION NEBULA is M42.

**meteor** The luminous phenomenon that occurs when a METEOROID enters EARTH'S ATMOSPHERE. It is sometimes called a shooting star.

**meteorite** Metallic or stony EXTRATERRESTRIAL material that has passed through the ATMOSPHERE and reached EARTH'S surface. *See also* METEOROID.

**meteoroid** An all-encompassing term that refers to solid objects found in OUTER SPACE, ranging in diameter from MICROMETERS to kilometers and in MASS from less than  $10^{-12}$  g to more than  $10^{+16}$  g. If the object has a mass of less than 1 g, it is called a micrometeoroid. When objects with a mass of more than  $10^{-6}$  g reach EARTH'S ATMOSPHERE, they glow with heat and produce the visible effect popularly called a METEOR. If some of an original meteoroid survives its incandescent plunge through Earth's atmosphere, the remaining unvaporized chunk of EXTRATERRESTRIAL matter is called a METEORITE.

**meteorological rocket** A SOUNDING ROCKET designed for routine observation of EARTH'S upper ATMOSPHERE (as opposed to scientific research).

**meteorological satellite** AN EARTH-OBSERVING SPACECRAFT that senses some or most of the atmospheric phenomena (such as wind and clouds) related to weather conditions on a local, regional, or hemispheric scale. These SATELLITES operate either close to EARTH in POLAR ORBITS or else observe an entire hemisphere from GEOSTATIONARY ORBIT. Also called a weather satellite.

**methanogen** An extremely hardy (terrestrial) microorganism that is capable of growing on simple compounds like HYDROGEN ( $H_2$ ) and CARBON DIOXIDE ( $CO_2$ ). The methanogen also turns its waste into methane ( $CH_4$ ). *See also* EXTREMOPHILE.

## Metonic calendar – microwave radiation

## GLOSSARY

**Metonic calendar** Named for the ancient Greek astronomer METON (OF ATHENS), it is based on the MOON and counts each cycle of the PHASES OF THE MOON as one month (or one lunation). After a period of 19 years, the lunations will occur on the same days of the year.

**metric system** *See* SI UNITS.

**microgravity** ( $\mu g$ ) Because its inertial TRAJECTORY compensates for the FORCE of GRAVITY, a SPACECRAFT in ORBIT around EARTH travels in a state of continual FREE FALL. All objects inside appear weightless—as if they were in a zero-gravity environment. However, the venting of gases, the minuscule DRAG exerted by Earth’s residual ATMOSPHERE (at low orbital ALTITUDES), and crew motions tend to create nearly imperceptible forces on objects inside the orbiting vehicle. These tiny forces are collectively called microgravity. *See also* WEIGHTLESSNESS.

**micrometer** ( $\mu m$ ) An SI UNIT of length equal to one-millionth ( $10^{-6}$ ) of a meter. Also called a micron.

**microwave background radiation** (MBR) *See* COSMIC MICROWAVE BACKGROUND.

**microwave radiation** Comparatively short-wavelength ELECTROMAGNETIC RADIATION in the RADIO FREQUENCY (RF) portion of the SPECTRUM—from about 30 cm to 1 mm WAVELENGTH.



Microgravity (NASA)

## Metonic calendar – microwave radiation

## GLOSSARY

## GLOSSARY

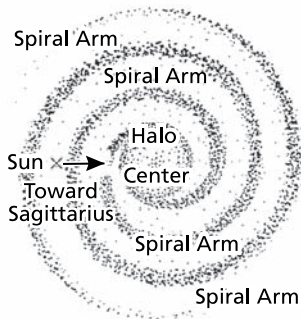

Milky Way Galaxy (Courtesy of NASA)

## military satellite – momentum

**military satellite** (MILSAT) A SATELLITE used primarily for military or defense purposes, such as intelligence gathering, MISSILE surveillance, or secure communications.

**Milky Way Galaxy** Humans' home GALAXY—a large SPIRAL GALAXY that contains between 200 and 600 billion SOLAR MASSES. The SUN lies some 30,000 LIGHT-YEARS from the galactic center.

**minor planet** *See* ASTEROID.

**Mir** (*Peace*) A third-generation Russian SPACE STATION of modular design that was assembled in ORBIT around a core module launched in February 1986. Although used extensively by many COSMONAUTS and guest researchers (including American ASTRONAUTS), the massive station was eventually abandoned because of economics and safely de-orbited into a remote area of the Pacific Ocean in March 2001.

**missile** Any object thrown, dropped, fired, launched, or otherwise projected with the purpose of striking a target. It is short for BALLISTIC MISSILE or GUIDED MISSILE. *Missile* should *not* be used loosely as an equivalent term for ROCKET or LAUNCH VEHICLE.

**missing mass** *See* DARK MATTER.

**MK system** *See* MORGAN-KEENAN (MK) CLASSIFICATION SYSTEM.

**modulation** The process of modifying a RADIO FREQUENCY (RF) signal by shifting its phase, FREQUENCY, or AMPLITUDE to carry information. The respective processes are called phase modulation (PM), frequency modulation (FM), and amplitude modulation (AM).

**molecule** A collection of ATOMS held together by chemical (bonding) FORCES. The atoms in a particular molecule may be identical, as in HYDROGEN ( $H_2$ ), or different, as in carbon monoxide (CO) and CARBON DIOXIDE ( $CO_2$ ). A molecule is the smallest unit of matter that can exist by itself and still retain all its chemical properties.

**Molniya orbit** A highly elliptical, 12-hour ORBIT developed within the Russian space program for special COMMUNICATIONS SATELLITES. With an APOGEE of about 40,000 km and a PERIGEE of only 500 km, a SPACECRAFT in this orbit spends the bulk of its time above the horizon in view of high northern latitudes.

**momentum** (*linear*) The linear momentum ( $p$ ) of a PARTICLE is the product of the particle's MASS ( $m$ ) and its VELOCITY ( $v$ ). NEWTON'S SECOND LAW OF MOTION states that the rate of change of momentum of a particle equals the resultant FORCE ( $F$ ) on the particle. *See also* NEWTON'S LAWS OF MOTION.

## GLOSSARY

## military satellite – momentum

- monopropellant** A LIQUID PROPELLANT for a ROCKET. It consists of a single chemical substance (such as HYDRAZINE) that decomposes in an EXOTHERMIC REACTION, producing a THRUST-generating heated exhaust jet without the use of a second chemical substance.
- moon** A small natural CELESTIAL BODY that orbits a larger one; a natural SATELLITE.
- Moon** EARTH's only natural SATELLITE and closest celestial neighbor. It has an equatorial diameter of 3,476 km, keeps the same side (NEARSIDE) toward Earth, and orbits at an average distance (center to center) of 384,400 km.
- Morgan-Keenan (MK) classification system** A more precise stellar classification system introduced in 1943 by American astronomers WILLIAM WILSON MORGAN and PHILIP CHILDS KEENAN. Based on work they performed at the YERKES OBSERVATORY, Morgan and Keenan kept the basic HARVARD CLASSIFICATION SYSTEM but then provided a more precise numerical division (0 to 9) of each spectral type. They also included a range of STELLAR LUMINOSITY CLASSES (I through V) to distinguish SUPERGIANT STARS from GIANT STARS, from MAIN-SEQUENCE STARS, and so on. The MK classification system is the one now widely used in modern ASTRONOMY. In the MK classification system, the SUN is called a STAR of G2V type.
- mother spacecraft** Exploration SPACECRAFT that carries and deploys one or several ATMOSPHERIC PROBES and ROVER or LANDER spacecraft when arriving at a target PLANET. The mother spacecraft then relays its data back to EARTH and may ORBIT the planet to perform its own scientific mission. NASA's GALILEO PROJECT spacecraft to JUPITER and CASSINI MISSION spacecraft to SATURN are examples.
- multispectral sensing** The REMOTE-SENSING method of simultaneously collecting several different BANDS (WAVELENGTH regions) of ELECTROMAGNETIC RADIATION (such as the visible, the near-infrared, and the thermal infrared bands) when observing a target.
- multistage rocket** A vehicle that has two or more ROCKET units, each firing after the one behind it has exhausted its PROPELLANT. This type of rocket vehicle then discards (or jettisons) each exhausted stage in sequence. It is sometimes called a multiple-stage rocket or a step rocket.
- nadir** (1) The direction from a SPACECRAFT directly down toward the center of a PLANET. It is the opposite of the ZENITH.  
(2) That point on the CELESTIAL SPHERE directly beneath an observer and directly opposite the zenith.

**naked eye – near-Earth asteroid**

**naked eye** The normal human eye unaided by any optical instrument, such as a TELESCOPE. The use of corrective lenses (glasses) or contact lenses that restore an individual's normal vision are included in the concept of naked eye observing.

**nanometer (nm)** A very small distance, namely  $1 \times 10^{-9}$  m.

**NASA** The National Aeronautics and Space Administration, the civilian space agency of the United States. It was created in 1958 by an act of Congress. NASA's overall mission is to plan, direct, and conduct civilian (including scientific) aeronautical and space activities for peaceful purposes.

**National Aeronautics and Space Administration (NASA)** *See* NASA.

**National Oceanic and Atmospheric Administration (NOAA)** NOAA was established within the U.S. Department of Commerce in 1970 to ensure the safety of the general public from atmospheric phenomena and to provide the public with an understanding of EARTH's environment. NOAA conducts research and gathers data about the global oceans, the ATMOSPHERE, OUTER SPACE, and the SUN. Within NOAA, the National Environmental Satellite, Data, and Information Service (NESDIS) is responsible for the daily operation of American ENVIRONMENTAL SATELLITES, such as the WEATHER SATELLITES found in POLAR ORBITS or in GEOSYNCHRONOUS ORBITS.

**National Radio Astronomy Observatory (NRAO)** A collection of government-owned RADIO ASTRONOMY facilities throughout the United States, including the RADIO TELESCOPE facility in Green Bank, West Virginia.

**National Reconnaissance Office (NRO)** The agency within the U.S. Department of Defense responsible for meeting the RECONNAISSANCE SATELLITE needs of various government organizations.

**National Space Development Agency of Japan (NASDA)** *See* JAPANESE AEROSPACE EXPLORATION AGENCY (JAXA).

**natural satellite** *See* MOON.

**navigation satellite** A SPACECRAFT placed into a well-known, stable ORBIT around EARTH that transmits precisely timed RADIO WAVE signals useful in determining locations on land, at sea, or in the air. Such SATELLITES are deployed as part of an interactive CONSTELLATION. *See also* GLOBAL POSITIONING SYSTEM.

**near-Earth asteroid (NEA)** An inner SOLAR SYSTEM ASTEROID whose ORBIT around the SUN brings it close to EARTH, perhaps even posing a collision threat in the future. *See also* EARTH-CROSSING ASTEROID.

## nearside – newton

**nearside** The side of the MOON that always faces EARTH.

**nebula** (*plural: nebulas or nebulae*) A cloud of INTERSTELLAR gas or dust. It can be seen as either a dark hole against a brighter background (called a DARK NEBULA) or as a luminous patch of LIGHT (called a bright nebula).

**Neptune** The eighth PLANET from the SUN and the outermost of the JOVIAN PLANETS. In 1846, it became the first to be discovered using theoretical predictions—a major triumph for 19th-century ASTRONOMY.

**neutrino** ( $\nu$ ) An uncharged fundamental PARTICLE with no (or very little) MASS that interacts only weakly with matter.

**neutron** ( $n$ ) An uncharged elementary PARTICLE with a MASS slightly greater than that of the PROTON. Neutrons occur in the NUCLEUS of every ATOM heavier than simple HYDROGEN ( ${}^1_1\text{H}$ ). Once outside the atomic nucleus, a free neutron becomes unstable and decays into an ELECTRON, a proton, and a NEUTRINO.

**neutron star** A very small (typically 20–30 km in diameter), superdense stellar object—the gravitationally collapsed core of a massive STAR that has undergone a SUPERNOVA explosion. Astrophysicists hypothesize that PULSARS are rapidly spinning neutron stars that possess intense magnetic fields.

***New General Catalog of Nebulae and Clusters of Stars (NGC)*** The extensive catalog of NEBULAS and STAR CLUSTERS prepared by JOHAN LUDVIG EMIL DREYER and first published in 1888. *NGC* numbers are used extensively in modern ASTRONOMY. For example, the ORION NEBULA is called NGC 1976 and corresponds the M42 in the MESSIER CATALOGUE.

**New Horizons Pluto–Kuiper Belt Flyby mission** A reconnaissance-type exploration mission that will help scientists understand the icy worlds at the outer edge of the SOLAR SYSTEM. NASA launched *New Horizons* from CAPE CANAVERAL on 19 January 2006, and sent the ROBOT SPACECRAFT on its long one-way mission to conduct a scientific ENCOUNTER (in 2015) with the DWARF PLANET PLUTO and its major MOON CHARON. *New Horizons* will then explore portions of the KUIPER BELT. Data from the SPACECRAFT will help resolve many basic questions about the surface features and properties of these distant icy bodies.

**newton** (N) The SI UNIT OF FORCE, named after SIR ISAAC NEWTON. 1 N is the amount of force that gives a 1 kg MASS an ACCELERATION of  $1 \text{ m/s}^2$ .

## nearside – newton

## GLOSSARY

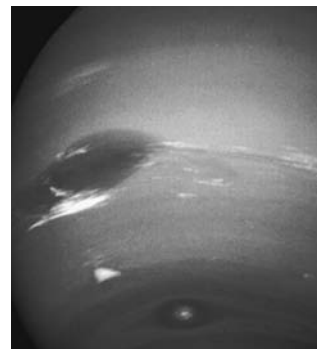

Neptune (Courtesy of NASA)



*New Horizons* spacecraft (NASA)

## GLOSSARY



## GLOSSARY

### Newtonian telescope – nuclear fission

**Newtonian telescope** A REFLECTING TELESCOPE in which a small plane mirror reflects the convergence BEAM from the OBJECTIVE (primary mirror) to an EYEPIECE at the side of the TELESCOPE. SIR ISAAC NEWTON designed the first reflecting telescope in about 1668.

**Newton's law of gravitation** The physical law proposed by SIR ISAAC NEWTON in 1687. It states that every PARTICLE of matter in the UNIVERSE attracts every other particle. The FORCE of gravitational attraction ( $F_G$ ) acts along the line joining the two particles and is proportional to the product of the particle MASSES ( $m_1$  and  $m_2$ ) and inversely proportional to the square of the distance ( $r$ ) between the particles. This law, expressed as an equation, is  $F_G = Gm_1 m_2/r^2$ , where  $G$  is the universal gravitational constant (approximately  $6.6732 \times 10^{-11} \text{ Nm}^2/\text{kg}^2$  in SI UNITS).

**Newton's laws of motion** The three postulates of motion formulated by SIR ISAAC NEWTON in about 1685. (1) His first law (the conservation of MOMENTUM) states that a body continues in a state of uniform motion (or rest) unless acted upon by an external FORCE. (2) The second law states that the rate of change of momentum of a body is proportional to the force acting upon the body and occurs in the direction of the applied force. (3) The third law (the action-reaction principle) states that for every force acting upon a body, there is a corresponding force of the same magnitude exerted by the body in the opposite direction. The third law is the basic principle by which every ROCKET operates.

**nose cone** The cone-shaped leading edge of a ROCKET vehicle, which contains and protects the PAYLOAD or WARHEAD.

**nova** (*plural: novas or novae*) From the Latin for “new,” an EVOLVED STAR that exhibits a sudden and exceptional brightness, usually temporary, and then returns to its former LUMINOSITY. A nova is now thought to be the outburst of a DEGENERATE STAR in a BINARY STAR SYSTEM.

**nozzle** A flow device that promotes the efficient expansion of the hot gases from the COMBUSTION CHAMBER of a ROCKET. As these gases leave at high VELOCITY, a propulsive (forward) THRUST also occurs in accordance with the third of NEWTON'S LAWS OF MOTION (action-reaction principle).

**nuclear-electric propulsion** (NEP) A space-deployed PROPULSION SYSTEM that uses a space-qualified, compact NUCLEAR REACTOR to produce the electricity needed to operate a space vehicle's ELECTRIC PROPULSION engine(s).

**nuclear fission** See FISSION.



Rocket engine nozzle (NASA)

## GLOSSARY

### Newtonian telescope – nuclear fission

## nuclear fusion – objective

**nuclear fusion** See FUSION.

**nuclear radiation** IONIZING RADIATION consisting of PARTICLES (such as ALPHA PARTICLES, BETA PARTICLES, and NEUTRONS) and very energetic ELECTROMAGNETIC RADIATION (that is, GAMMA RAYS). Atomic NUCLEI emit this type of radiation during a variety of energetic nuclear reaction processes, including radioactive decay, FISSION, and FUSION. *See also* RADIOISOTOPE.

**nuclear reactor** An ENERGY-generating device in which a nuclear FISSION chain reaction is initiated, maintained, and controlled—thereby releasing large amounts of heat in a predictable way.

**nuclear rocket** A ROCKET vehicle that derives its propulsive THRUST from nuclear ENERGY. *See also* NUCLEAR ELECTRIC PROPULSION; NUCLEAR THERMAL ROCKET.

**nuclear thermal rocket (NTR)** A ROCKET vehicle that derives its propulsive THRUST from nuclear ENERGY. It uses a NUCLEAR REACTOR to heat HYDROGEN to extremely high temperatures before expelling it through a THRUST-producing NOZZLE. *See also* NUCLEAR ELECTRIC PROPULSION.

**nucleon** A NEUTRON or PROTON viewed as a fundamental constituent PARTICLE within the atomic NUCLEUS.

**nucleosynthesis** The production of heavier chemical ELEMENTS from the FUSION (joining together) of lighter chemical elements (such as HYDROGEN and HELIUM) in thermonuclear reactions in the interior of STARS.

**nucleus** (1) (*atomic*) The central portion of an ATOM, consisting of PROTONS and NEUTRONS bound together by the strong nuclear FORCE.  
(2) (*cometary*) The small (few kilometer diameter), permanent, solid ice-rock central body of a COMET.  
(3) (*galactic*) The central region of a GALAXY, a few LIGHT-YEARS in diameter, where matter is concentrated. It is a complex region characterized by a dense cluster of STARS or possibly even the hidden presence of a massive BLACK HOLE. *See also* ACTIVE GALACTIC NUCLEUS.

**nuclide** A general term used to describe the NUCLEUS of an ATOM as characterized by its ATOMIC NUMBER ( $Z$ ) and number of NEUTRONS, which is the (atomic) MASS NUMBER ( $A$ ) minus the atomic number ( $Z$ ).

**objective** The main LIGHT-gathering LENS or mirror of a TELESCOPE. It is sometimes called the primary lens or primary mirror of a telescope.

## nuclear fusion – objective

## GLOSSARY

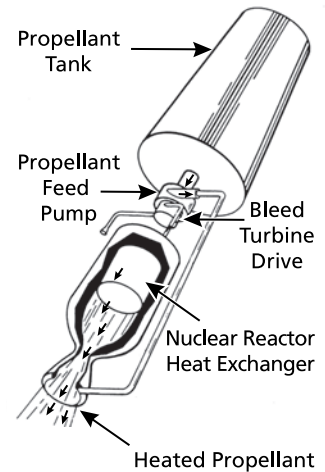

Nuclear thermal rocket  
(Courtesy of NASA and the U.S.  
Department of Energy)

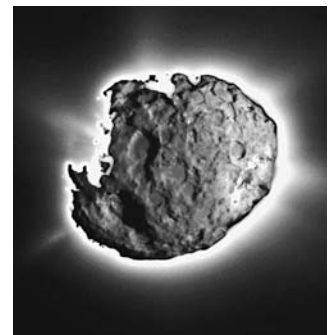

Nucleus of a comet (NASA)

## GLOSSARY

## GLOSSARY



Olympus Mons (Courtesy of NASA)

## oblateness – orbital mechanics

- oblateness** The degree of flattening of an oblate spheroid—a sphere flattened such that its polar diameter is smaller than its equatorial diameter.
- observable universe** The portions of the UNIVERSE that can be detected and studied by the LIGHT they emit.
- observatory** The place (or facility) from which astronomical observations are made. For example, the KECK OBSERVATORY is a ground-based observatory, while the *HUBBLE SPACE TELESCOPE* is a space-based (or EARTH-orbiting) observatory.
- occult** (*occultation*) The disappearance of one celestial object behind another. *See also* ECLIPSE.
- ogive** The tapered or curved front of a MISSILE or ROCKET.
- Olympus Mons** A huge mountain on MARS about 650 km wide and rising 26 km above the surrounding plains—the largest known SHIELD VOLCANO in the SOLAR SYSTEM.
- omnidirectional antenna** An ANTENNA that radiates or receives RADIO FREQUENCY (RF) signals with about the same efficiency in or from all directions. *Compare with* DIRECTIONAL ANTENNA.
- one-g** The downward ACCELERATION of GRAVITY at EARTH's surface (approximately  $9.8 \text{ m/s}^2$ ). *See also* *g*.
- Oort cloud** The large number (about  $10^{12}$ ) or cloud of COMETS postulated by JAN HENDRIK OORT in 1950 to ORBIT the SUN at a distance of between 50,000 and 80,000 ASTRONOMICAL UNITS.
- open cluster** *See* GALACTIC CLUSTER.
- open universe** A UNIVERSE that will continue to expand forever. *See* COSMOLOGY.
- opposition** The alignment of a SUPERIOR PLANET with the SUN so that the planet appears to an observer on EARTH to be in opposite parts of the sky. *See also* CONJUNCTION.
- optical radiation** *See* ELECTROMAGNETIC RADIATION; LIGHT.
- orbit** The path followed by a body in space, generally under the influence of GRAVITY—as, for example, a SATELLITE around a PLANET.
- orbital elements** *See* KEPLERIAN ELEMENTS.
- orbital injection** The process of providing a SPACE VEHICLE or a SATELLITE with sufficient VELOCITY to establish an ORBIT.
- orbital mechanics** *See* CELESTIAL MECHANICS.

## GLOSSARY

## oblateness – orbital mechanics

**orbital period** The interval between successive passages of a SATELLITE or SPACECRAFT through the same point in its ORBIT. Often called *period*.

**orbital plane** The imaginary plane that contains the ORBIT of a SATELLITE and passes through the center of its PRIMARY BODY. The angle of inclination (symbol  $\theta$ ) is defined as the angle between EARTH's equatorial plane and the orbital plane of the satellite

**orbital transfer vehicle (OTV)** A PROPULSION SYSTEM used to transfer a PAYLOAD from one orbital location to another. An expendable (one-shot) orbital transfer vehicle is often called an upper-stage unit, while a reusable OTV is called a space tug.

**orbiter** (*spacecraft*) A SPACECRAFT especially designed to travel through INTERPLANETARY space, achieve a stable ORBIT around the target PLANET (or other CELESTIAL BODY), and conduct a program of detailed scientific investigation.

**Orbiter** (*space shuttle*) The winged AEROSPACE VEHICLE portion of NASA's SPACE SHUTTLE. It carries ASTRONAUTS and PAYLOAD into ORBIT and returns from OUTER SPACE by gliding and landing like an airplane. The operational orbiter vehicle (OV) fleet includes *Discovery (OV-103)*, *Atlantis (OV-104)*, and *Endeavour (OV-105)*. NASA plans to retire all three operational orbiter vehicles by 2010. The *Challenger (OV-99)* and its crew were lost in a LAUNCH ascent accident on 28 January 1986; the *Columbia (OV-102)* and its crew were lost in a REENTRY accident on 1 February 2003. *See also* SECTION IV CHARTS & TABLES.

**orbit inclination** The ANGLE between EARTH's equatorial plane and a SATELLITE'S ORBITAL PLANE.

**Orbiting Astronomical Observatory (OAO)** A series of large, EARTH-orbiting, astronomical observatories developed by NASA in the 1960s to broaden humans' understanding of the UNIVERSE, especially as related to ULTRAVIOLET ASTRONOMY.

**Orbiting Quarantine Facility (OQF)** A proposed EARTH-orbiting laboratory in which soil and rock samples from MARS and other worlds could first be tested for potentially harmful alien microorganisms before such EXTRATERRESTRIAL materials were allowed to enter Earth's BIOSPHERE.

**order of magnitude** A factor of 10; a value expressed to the nearest power of 10—for example, a cluster containing 9,450 STARS has approximately 10,000 stars in an order of magnitude estimate.

## GLOSSARY

NASA's *Orion* spacecraft  
(NASA)

### *Orion* – pad

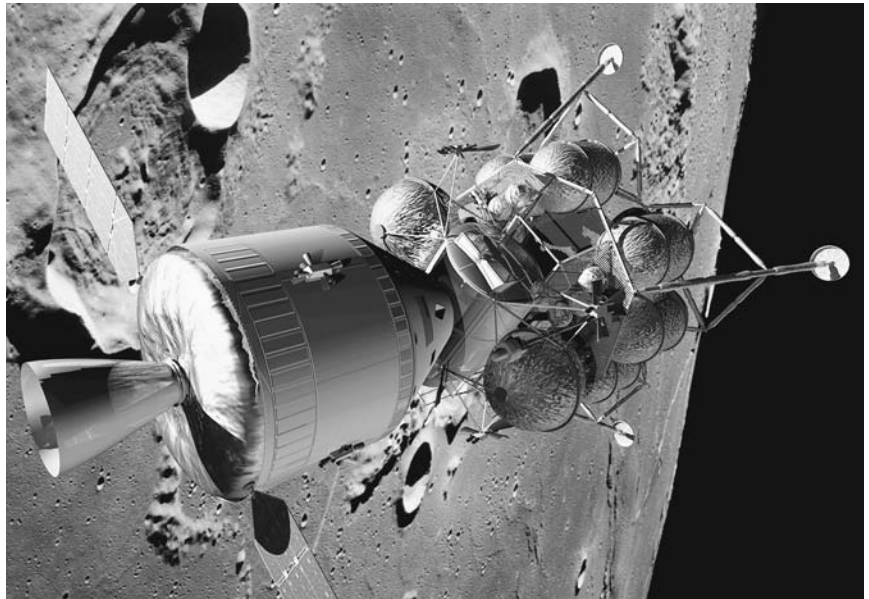

***Orion*** The name given by NASA to the agency's new crew exploration vehicle (CEV), which is being designed to carry ASTRONAUTS back to the MOON (in about 2020) and later to MARS (in the period 2030–35). By 2015, the *Orion* SPACECRAFT—launched by the ARES I ROCKET—will succeed the SPACE SHUTTLE as NASA's primary vehicle for human spaceflight. *See also* SECTION IV CHARTS & TABLES.

**Orion Nebula** A bright NEBULA about 1,500 LIGHT-YEARS away in the CONSTELLATION of Orion.

**oscillating universe** A CLOSED UNIVERSE in which gravitational collapse is followed by a new wave of expansion.

**outer planets** The MAJOR PLANETS in this SOLAR SYSTEM with ORBITS greater than the orbit of MARS, including JUPITER, SATURN, URANUS, and NEPTUNE. PLUTO is now considered a DWARF PLANET.

**outer space** Any region beyond EARTH's atmospheric envelope—usually considered to begin at between 100 and 200 km ALTITUDE.

**oxidizer** A substance whose main function is to supply oxygen for the burning of a ROCKET engine's fuel.

**pad** The platform from which a ROCKET vehicle is launched. *See also* LAUNCHPAD.

## GLOSSARY

### *Orion* – pad

## pair production – pascal

**pair production** The GAMMA RAY interaction process in which a high-ENERGY PHOTON disappears in the vicinity of an atomic NUCLEUS with the simultaneous appearance (formation) of a negative ELECTRON and a POSITRON (positive electron).

**Pallas** The large (about 540 km in diameter), MAIN-BELT ASTEROID discovered by HEINRICH WILHELM OLBERS in 1802—the second minor planet found.

**Palomar Observatory** An astronomical OBSERVATORY on Mount Palomar (1.7 km altitude) in southern California. Founded by GEORGE ELLERY HALE and opened in 1948, the facility's main instrument is a 5 m (200 in.) REFLECTING TELESCOPE.

**panspermia** The general hypothesis, introduced in 1908 by SVANTE AUGUST ARRHENIUS, that microorganisms, spores or bacteria attached to tiny PARTICLES of matter, have diffused through OUTER SPACE, eventually encountering a suitable PLANET and initiating the rise of life there. The word *panspermia* means “all-seeding.”

**parallax** The angular displacement in the apparent position of a CELESTIAL BODY when observed from two widely separated points. Astronomers define the trigonometric parallax (symbol:  $\pi$ ) of a STAR at a distance ( $d$ ) from the SUN as the ANGLE it subtends when observed at two locations separated by a baseline of one ASTRONOMICAL UNIT. The use of the trigonometric parallax provided astronomers their first way of measuring stellar distances. *See also* PARSEC.

**Paris Observatory** Founded in 1667 as the national OBSERVATORY of France, this facility represented the first such national observatory. GIOVANNI DOMENICO CASSINI served as its first director.

**parking orbit** The temporary (but stable) ORBIT of a SPACECRAFT around a CELESTIAL BODY. It is used for the assembly and/or transfer of equipment or to wait for conditions favorable for departure from that orbit.

**parsec** (*symbol: pc*) A unit of astronomical distance corresponding to a trigonometric PARALLAX ( $\pi$ ) of one second of arc. The term is a shortened form of *parallax second*. One parsec represents a distance of 3.26 LIGHT-YEARS (or 206,265 ASTRONOMICAL UNITS).

**particle** A minute constituent of matter, generally one with a measurable MASS; an elementary atomic particle such as a PROTON, NEUTRON, ELECTRON, or ALPHA PARTICLE.

**pascal** (Pa) The SI UNIT of pressure, honoring the French mathematician and philosopher Blaise Pascal, and defined as the pressure that

## pair production – pascal

## GLOSSARY



American stamp honoring Palomar Observatory (the author)

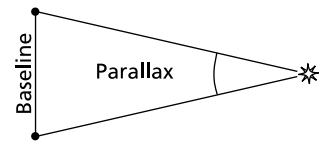

Parallax (Courtesy of NASA—modified by author)

## GLOSSARY

results from a FORCE of one NEWTON (1 N) acting uniformly over an area of 1 m<sup>2</sup>.

- payload** That which a ROCKET, AEROSPACE VEHICLE, or SPACECRAFT carries over and above what is necessary for the operation of the vehicle during flight.
- payload assist module (PAM)** A family of commercially developed UPPER-STAGE vehicles for use with NASA'S SPACE SHUTTLE or with EXPENDABLE LAUNCH VEHICLES, such as the DELTA.
- payload bay** The large and long enclosed volume within NASA'S SPACE SHUTTLE ORBITER vehicle designed to carry a wide variety of PAYLOADS, including UPPER-STAGE vehicles, deployable SPACECRAFT, and attached equipment. Also called cargo bay.
- Pegasus** (*space launch vehicle*) An aircraft-launched space BOOSTER ROCKET capable of placing small PAYLOADS and SPACECRAFT into LOW EARTH ORBIT.
- perfect cosmological principle** The postulation that at all times, the UNIVERSE appears the same to all observers. *See also* COSMOLOGY.
- peri-** A prefix meaning *near*.
- periastron** The point of closest approach of two STARS in a BINARY (DOUBLE) STAR SYSTEM. *Compare with* APASTRON.
- perigee** The point at which a SATELLITE'S ORBIT is the closest to its PRIMARY BODY; the minimum ALTITUDE attained by an EARTH-orbiting object. *Compare with* APOGEE.
- perihelion** The point in an ELLIPTICAL ORBIT around the SUN that is nearest to the center of the Sun. *Compare with* APHELION.
- perilune** The point in an ELLIPTICAL ORBIT around the MOON that is nearest to the LUNAR surface. *Compare with* APOLUNE.
- period** (*orbital*) The time taken by a SATELLITE to travel once around its ORBIT.
- periodic comet** A COMET with a period of less than 200 years. Also called a short-period comet.
- permanently crewed capability (PCC)** A SPACE STATION or planetary surface base that can be continuously occupied and operated by a human crew.
- perturbation** A disturbance in the ORBIT of a CELESTIAL BODY, most often caused by the FORCE of gravitational attraction of another body. Atmospheric DRAG can cause a perturbation in the orbit of a

## phases of the Moon – *Pioneer 10, 11* spacecraft

SPACECRAFT if it has a sufficiently low-ALTITUDE orbit around a CELESTIAL BODY with an ATMOSPHERE.

**phases of the Moon** The changing illuminated appearance of the NEAR SIDE surface of the MOON to an observer on EARTH. Major phases include the new Moon (not illuminated), first quarter, full Moon (totally illuminated), and last (third) quarter.

**Phobos** The larger, innermost of the two small MOONS of MARS—discovered in 1877 by ASAPH HALL. *See also* DEIMOS.

**Phoenix Mars mission** NASA'S ROBOT SPACECRAFT that successfully made a SOFT LANDING on MARS on 25 May 2008 in the PLANET'S northern polar region. Several days after landing, the spacecraft used its mechanical arm to dig a shallow trench and then collect soil samples for onboard analysis. Initial results indicate that the LANDER is resting on top of a large quantity of subsurface water ice. On November 10, 2008, the *Phoenix Mars Lander* ceased communications with Earth after operating for more than five months. As anticipated, seasonal decline in sunshine at the landing site was not sufficient for the SOLAR arrays to collect the POWER necessary to charge the batteries that operate the lander's instruments. Nevertheless, the spacecraft greatly advanced the goal of studying the MARTIAN arctic environment.

**photoheliograph** A TELESCOPE that produces a white-LIGHT photographic IMAGE of the SUN; developed by WARREN DE LA RUE in 1857.

**photoionization** The ionization of an ATOM or MOLECULE caused by collision with an energetic PHOTON.

**photometer** An instrument that measures LIGHT intensity and the brightness of celestial objects, such as STARS.

**photon** An elementary bundle (or packet) of ELECTROMAGNETIC RADIATION, such as a photon of LIGHT. Photons have no MASS and travel at the SPEED OF LIGHT. From QUANTUM THEORY, the ENERGY ( $E$ ) of a photon equals the product of its FREQUENCY ( $\nu$ ) and Planck's constant ( $h$ ), such that  $E = h\nu$ . Here  $h$  has the value of  $6.626 \times 10^{-34}$  joule-second, and the frequency is expressed in HERTZ. *See also* PLANCK'S RADIATION LAW.

**photosphere** The intensely bright (white-LIGHT), visible surface of the SUN or other STAR.

***Pioneer 10, 11* spacecraft** NASA'S twin exploration SPACECRAFT that were the first to navigate the main ASTEROID BELT, the first to visit JUPITER (1973 and 1974), the first to visit SATURN (*Pioneer 11*—1979), and

## GLOSSARY

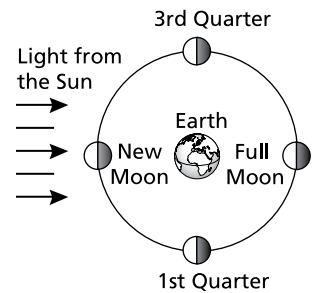

Phases of the Moon

## phases of the Moon – *Pioneer 10, 11* spacecraft

## GLOSSARY



## GLOSSARY

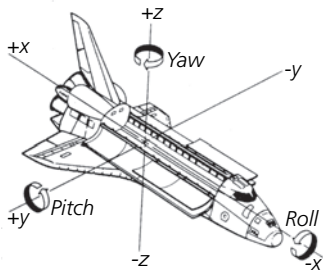

Pitch (Courtesy of NASA)

## Pioneer Venus mission – planet

the first human-made objects to leave the SOLAR SYSTEM (*Pioneer 10*—1983). Each spacecraft is now on a different TRAJECTORY to the STARS, carrying a special message (the Pioneer plaque) for any intelligent alien civilization that might find it millions of years from now.

**Pioneer Venus mission** Two SPACECRAFT launched by NASA to VENUS in 1978. *Pioneer 12* was an ORBITER spacecraft that gathered data from 1978–92. The *Pioneer Venus Multiprobe* served as a MOTHER SPACECRAFT, launching one large and three identical small PLANETARY PROBES into the VENUSIAN ATMOSPHERE (December 1978).

**pitch** The ROTATION of an AEROSPACE VEHICLE or SPACECRAFT about its lateral AXIS.

**pitchover** The programmed turn from the vertical that a LAUNCH VEHICLE (under power) takes as it describes an arc and points in a direction other than vertical.

**pixel** Contraction for *picture element*; the smallest unit of information on a screen or in an IMAGE.

**plage** A bright patch in the SUN'S CHROMOSPHERE.

**Planck's radiation law** The physical principle, developed by MAX KARL PLANCK in 1900, that describes the distribution of ENERGY radiated by a BLACKBODY. With this law, Planck introduced his concept of the QUANTUM (or PHOTON) as a small unit of ENERGY responsible for the transfer of ELECTROMAGNETIC RADIATION.

**planet** A nonluminous CELESTIAL BODY that ORBITS around the SUN or some other STAR. The name “planet” comes from the ancient Greek *planetes* (“wanderers”) because early astronomers identified the planets as the wandering points of LIGHT relative to the FIXED STARS. There are eight MAJOR PLANETS, three DWARF PLANETS, and numerous minor planets (or ASTEROIDS) in humans' SOLAR SYSTEM. In August 2006, the INTERNATIONAL ASTRONOMICAL UNION (IAU) clarified the difference between a planet and a dwarf planet. A planet is defined as a celestial body that (a) is in ORBIT around the Sun, (b) has sufficient MASS for its self-GRAVITY to overcome rigid body FORCES so as to assume a nearly round shape, and (c) has cleared the COSMIC neighborhood around its orbit. Within this definition there are eight major planets in the solar system: MERCURY, VENUS, EARTH, MARS, JUPITER, SATURN, URANUS, and NEPTUNE. PLUTO is now regarded as a dwarf planet. *Compare with* DWARF PLANET.

## GLOSSARY

## Pioneer Venus mission – planet

## planetary albedo – polarization

## GLOSSARY

- planetary albedo** The fraction of incident SOLAR RADIATION reflected by a PLANET (and its ATMOSPHERE) and returned to OUTER SPACE.
- planetary nebula** The shell of gas ejected from the outer layers of an extremely hot STAR (like a RED GIANT) at the end of its life cycle.
- planetary probe** An instrument-containing SPACECRAFT deployed in the ATMOSPHERE or on the surface of a planetary body in order to obtain environmental information.
- planetesimals** Small rock and rock/ice celestial objects found in the SOLAR SYSTEM, ranging from 0.1 km to about 100 km diameter. *See also* CENTAURS.
- planet fall** The act of a SPACECRAFT or SPACE VEHICLE landing on a PLANET or MOON.
- planetoid** *See* ASTEROID.
- plasma** An electrically neutral gaseous mixture of positive and negative IONS. It is sometimes called the fourth state of matter, because it behaves quite differently from solids, liquids, or gases.
- Plesetsk** The northern Russian LAUNCH SITE about 300 km south of Archangel that supports a wide variety of military space launches, BALLISTIC MISSILE testing, and scientific SPACECRAFT requiring a POLAR ORBIT.
- plume** The hot, bright exhaust gases from a ROCKET.
- plutino** (*little Pluto*) Any of the numerous, small (~100 km diameter), icy CELESTIAL BODIES that occupy the inner portions of the KUIPER BELT and whose orbital motion resonance with NEPTUNE resembles that of PLUTO—namely that each object completes two ORBITS around the SUN in the time Neptune takes to complete three orbits. *See also* TRANS-NEPTUNIAN OBJECT.
- Pluto** A DWARF PLANET that lies in the KUIPER BELT beyond the ORBIT of NEPTUNE, about 39.5 ASTRONOMICAL UNITS from the SUN. Discovered in 1930 by CLYDE WILLIAM TOMBAUGH, professional astronomers treated this icy body as the ninth MAJOR PLANET until August 2006. Pluto has three MOONS: CHARON, Nix, and Hydra. *See also* SECTION IV CHARTS & TABLES.
- Pluto-Kuiper Express Mission** *See* NEW HORIZONS PLUTO-KUIPER BELT FLYBY MISSION.
- Pogson scale** *See* MAGNITUDE.
- polarization** A distinct orientation of the wave motion and direction of travel of ELECTROMAGNETIC RADIATION, including LIGHT. Along with brightness and color, polarization is a special property of light. It

## planetary albedo – polarization

## GLOSSARY

## GLOSSARY

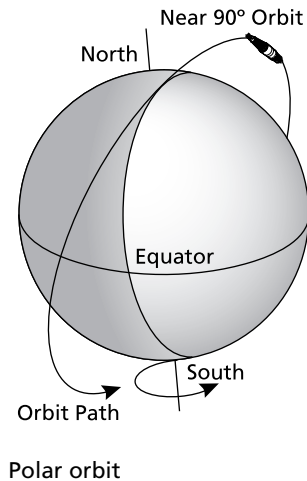

## polar orbit – pressurized habitable environment

represents a condition in which the planes of vibration of the various rays in a BEAM of light are at least partially (if not completely) aligned.

**polar orbit** An ORBIT around a PLANET (OR PRIMARY BODY) that passes over or near its poles; an orbit with an INCLINATION of about 90°.

**poles** The poles for a rotating CELESTIAL BODY are located at the ends (usually called north and south) of the body's AXIS OF ROTATION.

**Population I stars** Hot, luminous, young STARS, including those like the SUN, that reside in the DISK of a SPIRAL GALAXY and are higher in heavy ELEMENT content (about 2 percent abundance) than POPULATION II STARS.

**Population II stars** Older STARS that are lower in heavy ELEMENT content than POPULATION I STARS and reside in GLOBULAR CLUSTERS as well as in the halo of a galaxy—that is, the distant spherical region that surrounds a GALAXY.

**posigrade rocket** An auxiliary ROCKET that fires in the direction in which the vehicle is pointed. It is often used in separating two stages of a LAUNCH VEHICLE or a PAYLOAD from the UPPER-STAGE propulsion stage. The firing of a posigrade rocket adds to a SPACECRAFT's speed, while the firing of a retrograde rocket (RETROCKET) slows it down.

**positron** (*positive electron*) An elementary PARTICLE with the MASS of an ELECTRON but charged positively. Also called the antielectron.

**potential energy** (*PE*) The ENERGY or ability to do WORK possessed by an object by virtue of its position in a GRAVITY field above some reference position or datum.

**power** (*P*) The rate at which WORK is done or at which ENERGY is transformed per unit time. The WATT (W) is the fundamental SI UNIT of power.

**precession** The gradual, periodic change in the direction of the AXIS of ROTATION of a spinning body due to the application of an external FORCE; the wobbling of a spinning top is an example.

**precession of equinoxes** The slow westward motion of the EQUINOX points along the ECLIPTIC relative to the STARS of the ZODIAC caused by the slight wobbling of EARTH about its AXIS of ROTATION.

**pressurized habitable environment** Any module or enclosure in OUTER SPACE in which an ASTRONAUT may perform activities in a SHIRTSLEEVE ENVIRONMENT.

## GLOSSARY

## polar orbit – pressurized habitable environment

**primary body** The CELESTIAL BODY around which a SATELLITE, MOON, or other object ORBITS or from which it is escaping or toward which it is falling.

**prism** A block (often triangular) of transparent material that disperses an incoming beam of white LIGHT into the visible SPECTRUM of rainbow colors—that is, red, orange, yellow, green, blue, indigo, and violet in order of decreasing WAVELENGTH.

**probe** *See* PLANETARY PROBE.

**prograde orbit** An ORBIT having an INCLINATION of between 0° and 90°.

**Progress** An uncrewed Russian supply SPACECRAFT configured to perform automated RENDEZVOUS and DOCKING operations with SPACE STATIONS and other orbiting spacecraft.

**progressive burning** A design condition for a SOLID-PROPELLANT ROCKET in which the surface area of burning PROPELLANT increases with time, thereby increasing THRUST for some specific period of operation.

**Project Cyclops** A proposed very large array of dish ANTENNAS for use in a detailed search of the RADIO-FREQUENCY (RF) portion of the ELECTROMAGNETIC SPECTRUM (especially the 18- to 21-centimeter WAVELENGTH—the so-called WATER HOLE region of the RF spectrum) for INTERSTELLAR signals from intelligent alien civilizations (should such exist). The engineering details of this SEARCH FOR EXTRATERRESTRIAL INTELLIGENCE (SETI) configuration were derived in a special summer institute design study sponsored by NASA at Stanford University in 1971.

**Project Daedalus** The name given to an extensive study of INTERSTELLAR space exploration conducted from 1973 to 1978 by a team of scientists and engineers under the auspices of the British Interplanetary Society. The Daedalus ROBOT SPACECRAFT, communications systems, and much of the PAYLOAD were designed within the parameters of extrapolated 20th and 21st century technologies. The intended target of this proposed INTERSTELLAR PROBE was BARNARD'S STAR, a RED DWARF about six LIGHT-YEARS away.

**Project Ozma** The pioneering attempt to detect INTERSTELLAR RADIO WAVE signals from an intelligent EXTRATERRESTRIAL civilization. It was conducted in 1960 by FRANK DONALD DRAKE at the NATIONAL RADIO ASTRONOMY OBSERVATORY in Green Bank, West Virginia. No strong evidence was found after 150 hours of listening for intelligent signals from the vicinity of two SUNLIKE STARS about 11 LIGHT-YEARS away. *See also* SEARCH FOR EXTRATERRESTRIAL INTELLIGENCE.

## GLOSSARY



Proton rocket (NASA)

## prominence – protostar

**prominence** A cloud of cooler PLASMA extending high above the SUN's visible surface, rising above the PHOTOSPHERE into the CORONA.

**propellant** The material, such as a chemical fuel and OXIDIZER combination, carried in a ROCKET vehicle, energized, and then ejected at high VELOCITY as THRUST-producing reaction MASS. Chemical propellants are in either liquid or solid form. Modern LAUNCH VEHICLES use one of three general types of LIQUID PROPELLANTS: petroleum based, cryogenic (very cold), or hypergolic (self-igniting upon contact).

**proper motion ( $\mu$ )** The apparent angular displacement of a STAR with respect to the CELESTIAL SPHERE. BARNARD'S STAR has the largest known proper motion.

**propulsion system** The LAUNCH VEHICLE (or SPACE VEHICLE) system that includes ROCKET engines, PROPELLANT tanks, fluid lines, and all associated equipment necessary to provide the propulsive FORCE (THRUST) as specified for the vehicle.

**protium** Ordinary HYDROGEN—one PROTON in the NUCLEUS surrounded by one ELECTRON.

**protogalaxy** A GALAXY in the early stages of evolution.

**proton** (p) A stable elementary PARTICLE with a single positive charge and a MASS of about  $1.672 \times 10^{-27}$  kg. A single proton makes up the NUCLEUS of an ordinary HYDROGEN atom (PROTIUM).

**Proton** A Russian LIQUID-PROPELLANT EXPENDABLE LAUNCH VEHICLE capable of placing 21,000 kg MASS PAYLOADS into LOW EARTH ORBIT (LEO) and sending SPACECRAFT on INTERPLANETARY TRAJECTORIES.

**proton-proton reaction** The series of thermonuclear FUSION reactions in stellar interiors by which four HYDROGEN NUCLEI are fused into a HELIUM nucleus. This is the main ENERGY liberation mechanism in STARS like the SUN.

**proton storm** The burst of PROTONS sent into interplanetary space by a SOLAR FLARE.

**protoplanet** Any of a star's PLANETS as such planets emerge during the process of ACCRETION in which PLANETESIMALS collide and coalesce into large objects.

**protostar** A STAR in the making. Specifically, the stage in a young star's evolution after it has separated from a gas cloud but prior to it collapsing sufficiently (due to GRAVITY) to support thermonuclear FUSION reactions.

## GLOSSARY

## prominence – protostar

- Proxima Centauri** The closest STAR to the SUN—the third member of the ALPHA CENTAURI triple-star system. It is some 4.2 LIGHT-YEARS away.
- Ptolemaic system** The ancient Greek model of an EARTH-centered (GEOCENTRIC) UNIVERSE as described by PTOLEMY in *ALMAGEST*. *Compare with* COPERNICAN SYSTEM.
- pulsar** A rapidly spinning NEUTRON STAR that generates regular pulses of ELECTROMAGNETIC RADIATION. Although originally discovered by RADIO WAVE observations, they have since been observed at optical, X-RAY, and GAMMA RAY energies.
- purge** The process of removing residual fuel or OXIDIZER from the tanks or lines of a LIQUID-PROPELLANT ROCKET after a test firing.
- quantum** (*plural: quanta*) A discrete bundle of ENERGY possessed by a PHOTON. *See also* QUANTUM THEORY.
- quantum mechanics** The physical theory that emerged from MAX KARL PLANCK'S original QUANTUM THEORY and developed into wave mechanics, matrix mechanics, and relativistic quantum mechanics in the 1920s and 1930s.
- quantum theory** A foundational theory of modern physics. MAX KARL PLANCK proposed in 1900 that all ELECTROMAGNETIC RADIATION was emitted and absorbed in QUANTA, or discrete ENERGY packets (called PHOTONS), instead of continuously.
- Quaoar** Large, icy world with a diameter of about 1,250 km, located in the KUIPER BELT about 6.5 billion ( $10^9$ ) km from the SUN. First observed in June 2002, this TRANS-NEPTUNIAN OBJECT takes about 285 years to travel around the Sun. The CELESTIAL BODY is named after the creation deity of the Tongva, a Native American people who inhabited the area around Los Angeles, California, before the arrival of European settlers.
- quasar** A mysterious, very distant object with a high REDSHIFT—that is, traveling away from EARTH at great speed. These objects appear almost like STARS but are far more distant than any individual star now observed. They might be the very luminous centers of active distant GALAXIES. When first identified in 1963, they were called *quasi-stellar* radio sources—or quasars. Also called quasi-stellar object (QSO).
- quiet Sun** The collection of SOLAR phenomena and features, including the PHOTOSPHERE, the solar SPECTRUM, and the CHROMOSPHERE, that are always present. *Compare with* ACTIVE SUN.

**radar astronomy** The use of radar (RADIO WAVE reflections) to study objects in this SOLAR SYSTEM, such as the MOON, the PLANETS (especially VENUS), ASTEROIDS, and planetary RING systems.

**Radarsat** Canadian EARTH-OBSERVING SPACECRAFT launched in 1995 that uses an advanced SYNTHETIC APERTURE RADAR (SAR) to produce high-resolution IMAGES of EARTH'S surface despite clouds and darkness.

**radial burning** A SOLID-PROPELLANT ROCKET GRAIN that burns in the radial direction, either outwardly (called an internally burning grain) or inwardly.

**radian** A unit of ANGLE. One radian is the angle subtended at the center of a circle by an arc equal in length to the radius of the circle, approximately 57.3°.

**radiant flux** *See* FLUX.

**radiation** (*heat transfer*) The transfer of thermal ENERGY (heat) by ELECTROMAGNETIC RADIATION (EMR) due to the temperature of a body. The STEFAN-BOLTZMANN LAW determines the amount of radiant energy exchanged by a given surface area. This amount is also proportional to the fourth power of the ABSOLUTE TEMPERATURE of the radiating surface. It is called thermal radiation to distinguish it from other forms of EMR, such as RADIO WAVES, LIGHT, and X-RAYS.

**radiation belt** The region(s) in a PLANET'S MAGNETOSPHERE where there is a high DENSITY of trapped atomic PARTICLES from the SOLAR WIND. *See* EARTH'S TRAPPED RADIATION BELTS.

**radiation sickness** A potentially fatal illness resulting from excessive exposure to IONIZING RADIATION. Also called acute radiation syndrome.

**radioactivity** The spontaneous decay or disintegration of an unstable (atomic) NUCLEUS accompanied by the emission of IONIZING RADIATION, such as ALPHA PARTICLES, BETA PARTICLES, and GAMMA RAYS.

**radio astronomy** The branch of ASTRONOMY that collects and evaluates RADIO WAVE signals from a wide variety of celestial objects. It started in the 1930s when KARL GUTHE JANSKY detected the first EXTRATERRESTRIAL radio wave signals.

**radio frequency (RF)** The portion of the ELECTROMAGNETIC (EM) SPECTRUM useful for TELECOMMUNICATIONS with a FREQUENCY range between 10,000 and  $3 \times 10^{11}$  HERTZ.

## radio galaxy – red dwarf

**radio galaxy** A GALAXY (often dumbbell shaped) that produces very strong RADIO WAVE signals. Cygnus A is an example of an intense source, about 650 million LIGHT-YEARS away.

**radioisotope** An unstable (radioactive) ISOTOPE of an ELEMENT that spontaneously decays at a predictable rate governed by its HALF-LIFE. *See also* RADIOACTIVITY.

**radioisotope thermoelectric generator (RTG)** Compact-space nuclear power system that uses DIRECT CONVERSION (based on the thermoelectric principle) to transform the thermal ENERGY from a RADIOISOTOPE source (generally plutonium 238) into electricity. All NASA SPACECRAFT that have explored the outer regions of the SOLAR SYSTEM have used RTGs for their electric power.

**radio telescope** A large, metallic device, generally parabolic (dish shaped), that collects RADIO WAVE signals from EXTRATERRESTRIAL objects (such as PULSARS and ACTIVE GALAXIES) or from distant SPACECRAFT and focuses these radio signals onto a sensitive RADIO-FREQUENCY (RF) receiver.

**radio waves** ELECTROMAGNETIC RADIATION (EMR) with a WAVELENGTH between about 1 mm (0.001 m) and several thousand kilometers.

**Ranger Project** The first NASA SPACECRAFT sent to the MOON in the 1960s. These IMPACT PLANETARY PROBES were designed to take a series of television IMAGES of the LUNAR surface before crash-landing.

**rays** (*lunar*) Bright streaks extending across the surface from young IMPACT CRATERS on the MOON; also observed on MERCURY and on several large moons of the OUTER PLANETS.

**reaction engine** An engine that develops THRUST by its physical reaction to the ejection of a substance from it. Normally, a reaction engine ejects a stream of hot gases created by internally combusting a PROPELLANT—but more advanced reaction engine concepts involve the ejection of PHOTONS or nuclear PARTICLES. Both ROCKET and jet PROPULSION SYSTEMS involve reaction engines that obey the third of NEWTON'S LAWS OF MOTION (the action-reaction principle).

**reconnaissance satellite** A military SATELLITE that ORBITS EARTH and performs intelligence gathering against enemy nations and potential adversaries. Also called a SPY SATELLITE.

**red dwarf** (*star*) Reddish MAIN-SEQUENCE STARS (spectral type K and M) that are relatively cool (~ 4000 K surface temperature) and have low MASS (about 0.5 SOLAR MASS or less). These faint, low-LUMINOSITY stars are inconspicuous, yet they represent the most

## radio galaxy – red dwarf

## GLOSSARY

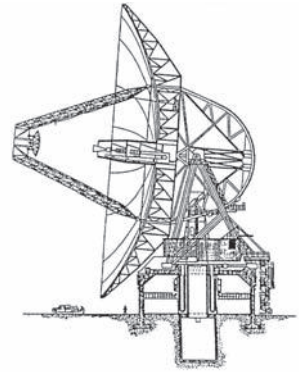

Radio telescope (Courtesy of NASA)



Ranger spacecraft (NASA)

## GLOSSARY



## red giant – reflection

common type of star in the UNIVERSE and the longest lived. BARNARD'S STAR is an example.

**red giant** (*star*) A large, cool STAR with a surface temperature of about 2,500 K and a diameter 10 to 100 times that of the SUN. This type of highly luminous star is at the end of its evolutionary life, departing the main sequence after exhausting the HYDROGEN in its core. It is often a VARIABLE STAR. Some 5 billion years from now, the Sun will evolve into a massive red giant. *See also* MAIN-SEQUENCE STAR.

**Red Planet** The planet MARS—so named because of its distinctive reddish soil.

**redshift** The apparent increase in the WAVELENGTH of a source of LIGHT (toward longer-wavelength red light) caused by the DOPPLER SHIFT effect in a receding object. *Compare with* BLUESHIFT.

**Redstone** An early, LIQUID-PROPELLANT, medium-range BALLISTIC MISSILE used by the U.S. Army.

**reentry** The return of objects, originally launched from EARTH, back into the SENSIBLE ATMOSPHERE; the action involved in this event. The major types of reentry are ballistic, gliding, and skip. When a piece of SPACE (ORBITAL) DEBRIS undergoes an uncontrolled ballistic reentry, it usually burns up in the ATMOSPHERE due to excessive AERODYNAMIC HEATING. An AEROSPACE VEHICLE, like NASA'S SPACE SHUTTLE, makes a safe, controlled atmospheric reentry by using a gliding TRAJECTORY designed to dissipate its KINETIC ENERGY and POTENTIAL ENERGY carefully prior to landing.

**reentry vehicle** (RV) The part of a ROCKET or SPACE VEHICLE designed to reenter EARTH'S ATMOSPHERE in the terminal portion of its TRAJECTORY. For example, the NOSE CONE portion of an INTERCONTINENTAL BALLISTIC MISSILE is designed to survive the AERODYNAMIC HEATING of REENTRY and to protect its PAYLOAD (a nuclear WARHEAD) while it descends on a BALLISTIC TRAJECTORY to its target.

**reflecting telescope** An optical TELESCOPE that collects and focuses LIGHT from distant objects by means of a mirror (called the OBJECTIVE or primary mirror). SIR ISAAC NEWTON developed the first reflecting telescope in about 1668—using a design now called the NEWTONIAN TELESCOPE or the Newtonian reflector.

**reflection** The return of all or part of a beam of LIGHT when it encounters the interface (boundary) between two different media, like AIR and water. A mirrorlike surface reflects most of the light falling onto it.

## refracting telescope – remote manipulator system

## GLOSSARY

**refracting telescope** An optical TELESCOPE that collects and focuses LIGHT from distant objects by means of a LENS (called the OBJECTIVE or primary lens) or system of lenses. In 1609, GALILEO GALILEI began improving the first refracting telescope invented by HANS LIPPERSHEY and then applied his own instrument to astronomical observations. It was this refracting Galilean telescope that helped launch the scientific revolution of the 17th century.

**refraction** The change in direction (bending) of a BEAM of LIGHT at the interface (boundary) between two different transparent media, such as air and water or a pair of LENSES that possess different optical properties.

**regenerative life support system (RLSS)** A controlled ecological LIFE SUPPORT SYSTEM in which biological and physiochemical subsystems produce plants for food and process solid, liquid, and gaseous wastes for reuse in the system.

**regolith** (*lunar*) The unconsolidated MASS of surface debris that overlies the MOON's bedrock. This blanket of pulverized LUNAR dust and soil was created by millions of years of meteoric and cometary IMPACTS.

**regressive burning** For a SOLID-PROPELLANT ROCKET, the condition in which the burning surface of the PROPELLANT decreases with time—thereby decreasing the pressure and THRUST.

**relativity** The theory of space and time developed by ALBERT EINSTEIN early in the 20th century and one of the foundations of modern physics. Special relativity, introduced in 1905, involves Einstein's fundamental postulate that the SPEED OF LIGHT ( $c$ ) has the same value for all observers. One major consequence of special relativity is the famous MASS-ENERGY equivalence formula:  $E = \Delta mc^2$  in which  $E$  is the energy equivalent of an amount of matter ( $\Delta m$ ) that is annihilated or converted into pure energy and  $c$  is the speed of light. In 1915, Einstein introduced his general theory of relativity, postulating that GRAVITATION is not really a FORCE between two masses (as SIR ISAAC NEWTON proposed) but, rather, arises as a consequence of the curvature of space and time. For Einstein, in a four-dimensional UNIVERSE (that is  $x$ -,  $y$ -,  $z$ -space and time) SPACE-TIME becomes curved in the presence of matter—the more massive the object, the more curvature and therefore the more gravitation.

**remote manipulator system (RMS)** The dexterous, Canadian-built, 15.2 m long articulated arm that is remotely controlled by ASTRONAUTS from the aft flight deck of NASA'S SPACE SHUTTLE.



Shuttle's remote manipulator system (RMS) at work (NASA)

## refracting telescope – remote manipulator system

## GLOSSARY

- remote sensing** The sensing of an object or phenomenon, using different portions of the ELECTROMAGNETIC (EM) SPECTRUM, without having the SENSOR in direct contact with the object being studied. In ASTRONOMY, characteristic ELECTROMAGNETIC RADIATION signatures often carry distinctive information about an interesting celestial object that is LIGHT-YEARS away from the sensor.
- rendezvous** The close approach of two or more SPACECRAFT in the same ORBIT so that DOCKING can take place. Orbiting objects meet at a preplanned location and time. They slowly come together with essentially zero relative VELOCITY.
- resolution** The smallest detail (measurement) that can be distinguished by a SENSOR system under specific conditions, such as its spatial resolution or spectral resolution.
- retrograde motion** Motion in a reverse or backward direction.
- retrorocket** (*retrograde rocket*) An auxiliary ROCKET that fires in the direction opposite to which a SPACE VEHICLE is traveling (pointed). Low-THRUST retrograde rockets produce a retarding FORCE that opposes the vehicle's forward motion and reduces its VELOCITY. *Compare with* POSIGRADE ROCKET.
- reusable launch vehicle (RLV)** A conceptual space LAUNCH VEHICLE that includes simple, fully reusable designs that support flexible airline-type operations and greatly reduced costs per kilogram of PAYLOAD delivered into LOW EARTH ORBIT (LEO). These design goals would be achieved primarily through the use of advanced space technology and innovative operational techniques. In 2001, NASA canceled the X-33 prototype RLV program, citing technical difficulties and cost overruns for its decision.
- revolution** One complete cycle of movement of a SATELLITE or a CELESTIAL BODY around its PRIMARY BODY; the orbital motion of a celestial body or SPACECRAFT about a center of gravitational attraction such as the SUN or a PLANET as distinct from ROTATION about an internal AXIS.
- rift valley** A depression in a PLANET's surface due to crustal MASS separation.
- right ascension (RA)** For a CELESTIAL BODY viewed on the CELESTIAL SPHERE, the angular east-west distance between the VERNAL EQUINOX and the object's location on the celestial sphere.
- rille** A deep, narrow depression on the LUNAR surface that cuts across all other types of topographical features on the MOON.
- ring** (*planetary*) A DISK of matter that encircles a PLANET. Such rings usually contain ice and dust PARTICLES, ranging in size from

## ringed world – Royal Greenwich Observatory

microscopic fragments up to chunks that are tens of meters in diameter.

**ringed world** A PLANET with a RING or set of rings encircling it. In the SOLAR SYSTEM, JUPITER, SATURN, URANUS, and NEPTUNE all have ring systems of varying degrees of composition and complexity. Ring systems may be a common feature of EXTRASOLAR JOVIAN PLANETS.

**robot spacecraft** A semiautomated or fully automated SPACECRAFT capable of executing its primary exploration mission with minimal or no human supervision.

**Roche limit** As postulated by EDOUARD ALBERT ROCHE in the 19th century, the smallest distance from a PLANET at which gravitational FORCES can hold together a SATELLITE or MOON that has the same average DENSITY as the PRIMARY BODY. If the moon's ORBIT falls within the Roche limit, it will be torn apart by tidal forces.

**rocket** A completely self-contained projectile or flying vehicle propelled by a REACTION ENGINE. Since a rocket carries all of its required PROPELLANT, it can function in the vacuum of OUTER SPACE and represents the key to space travel. This fact was independently recognized early in the 20th century by the founders of ASTRONAUTICS: KONSTANTIN EDUARDOVICH TSIOLKOVSKY, ROBERT HUTCHINGS GODDARD, and HERMANN J. OBERTH. Rockets obey the third of NEWTON'S LAWS OF MOTION (the action-reaction principle). There are CHEMICAL ROCKETS, NUCLEAR ROCKETS, and ELECTRIC-PROPULSION rockets. Chemical rockets are further divided into SOLID-PROPELLANT ROCKETS and LIQUID-PROPELLANT ROCKETS.

**rogue star** A wandering STAR that passes close to a SOLAR SYSTEM, disrupting the CELESTIAL BODIES in the system, which would trigger cosmic catastrophes on life-bearing PLANETS.

**roll** The rotational or oscillatory movement of an AEROSPACE VEHICLE or ROCKET about its longitudinal (lengthwise) AXIS. *See also* PITCH; YAW.

**rotation** The turning of an object (especially a CELESTIAL BODY) about an internal AXIS.

**rover** A crewed or robot SPACE VEHICLE used to explore a planetary surface.

**Rover Program** The overall U.S. NUCLEAR ROCKET development program from 1959–73.

**Royal Greenwich Observatory (RGO)** The British OBSERVATORY founded by King Charles II in 1675 at Greenwich in London. The original structure is now a museum, while the RGO is presently located at

## GLOSSARY

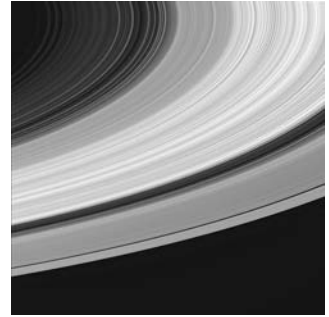

Rings of Saturn (NASA)

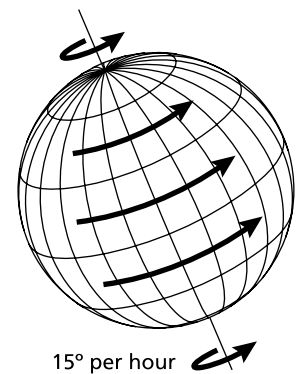

Rotation (of Earth)

## ringed world – Royal Greenwich Observatory

## GLOSSARY

## GLOSSARY

### RP-1 – Schwarzschild radius

Cambridge. Until 1971, the ASTRONOMER ROYAL served as the RGO director, but these positions are now separate appointments.

**RP-1** Rocket propellant number *one*—a commonly used hydrocarbon-based, LIQUID-PROPELLANT ROCKET ENGINE fuel that is refined kerosene.

**rumble** A form of combustion instability in a LIQUID-PROPELLANT ROCKET ENGINE, characterized by a low-pitched, low-FREQUENCY rumbling noise.

**runaway greenhouse** An environmental catastrophe during which the GREENHOUSE EFFECT produces excessively high global temperatures that cause all the liquid (surface) water on a life-bearing PLANET to evaporate permanently. *Compare with* ICE CATASTROPHE.

**Salyut** (*salute*) An evolutionary series of Russian SPACE STATIONS placed into ORBIT around EARTH in the 1970s and early 1980s to support a variety of military and civilian missions.

**satellite** A secondary (smaller) CELESTIAL BODY in ORBIT around a larger PRIMARY BODY. For example, EARTH is a natural satellite of the SUN, while the MOON is a natural satellite of Earth. A human-made SPACECRAFT placed into orbit around Earth is called an artificial satellite—or more commonly just a satellite.

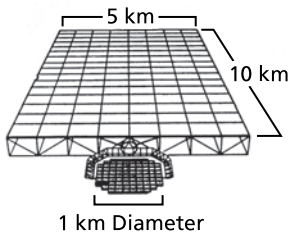

Satellite power system  
(Courtesy of NASA)

**satellite power system (SPS)** A conceptual CONSTELLATION of very large (kilometers on a side) GEOSTATIONARY ORBIT space structures, constructed in space, that continuously harvest SOLAR ENERGY and transmit it as MICROWAVE RADIATION to special receiving/converter stations on EARTH's surface.

**Saturn** (1) (*launch vehicle*) Family of powerful, EXPENDABLE LAUNCH VEHICLES developed for NASA by WERNHER VON BRAUN to carry ASTRONAUTS to the MOON in the APOLLO PROJECT.  
(2) (*planet*) The sixth PLANET from the SUN and the JOVIAN PLANET with the most extensive and beautiful RINGS. Its major SATELLITE, TITAN, is the only known moon with a dense ATMOSPHERE.

**Saturnian** Of or pertaining to the PLANET SATURN.

**scarp** A cliff produced by erosion or faulting.

**scattering** The collision (or deflection) process that changes the TRAJECTORY of a PARTICLE or a PHOTON.

**Schwarzschild black hole** An uncharged BLACK HOLE that does not rotate; KARL SCHWARZSCHILD predicted this basic model of a black hole in 1916.

**Schwarzschild radius** The radius of the EVENT HORIZON of a BLACK HOLE.

## GLOSSARY

### RP-1 – Schwarzschild radius

## science payload – sensible atmosphere

## GLOSSARY

**science payload** The collection of scientific instruments on a SPACECRAFT.

**scientific airlock** A special opening in a crewed SPACECRAFT or SPACE STATION through which experiments and research equipment can be extended outside (into OUTER SPACE) without violating the atmospheric integrity of the pressurized interior of the space vehicle.

**Scout** A four-stage, SOLID-PROPELLANT ROCKET developed by NASA and used as an EXPENDABLE LAUNCH VEHICLE to place small-MASS (~ 200 kg or less) PAYLOADS into LOW EARTH ORBIT or on suborbital TRAJECTORIES.

**screaming** For a LIQUID-PROPELLANT ROCKET ENGINE, a relatively high-FREQUENCY form of combustion instability, characterized by a high-pitched noise.

**scrub** To cancel or postpone a ROCKET firing, either before or during the COUNTDOWN.

**search for extraterrestrial intelligence (SETI)** An attempt to answer the important philosophical question, Are we alone in the universe? The goal of contemporary SETI programs (now being conducted by private foundations) is to detect coherent RADIO FREQUENCY (microwave) signals generated by intelligent EXTRATERRESTRIAL civilizations—should they exist.

**secondary crater** The CRATER formed when a large chunk of material from a primary-IMPACT CRATER strikes the surrounding planetary surface.

**Sedna** An intriguing TRANS-NEPTUNIAN OBJECT (TNO) discovered in 2003 and named after the goddess of the sea in Inuit mythology. With a diameter of about 1,350–1,750 km, Sedna travels around the SUN in a highly ELLIPTICAL ORBIT characterized by an APHELION of about 1,000 ASTRONOMICAL UNITS (AU), a PERIHELION of about 75 AU, and an orbital PERIOD on the order of 10,500 years.

**self-replicating system (SRS)** An advanced space robot system, first postulated by JOHN VON NEUMANN, that would be capable of gathering materials, maintaining itself, manufacturing desired products, and even making copies of itself (self-replication).

**semimajor axis** One-half the major AXIS of an ELLIPSE. For a PLANET, this corresponds to its average orbital distance from the SUN.

**sensible atmosphere** That portion of a PLANET'S ATMOSPHERE that offers resistance to a body passing through it.

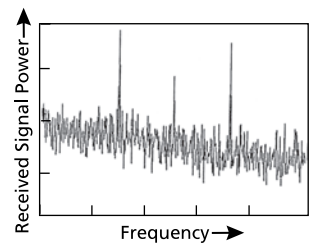

Search for extraterrestrial intelligence (simulated signal) (Courtesy of NASA)

## science payload – sensible atmosphere

## GLOSSARY

**sensor** The portion of a scientific instrument that detects and/or measures some physical phenomenon.

**Seyfert galaxy** A type of SPIRAL GALAXY with a very bright GALACTIC NUCLEUS—first observed by Carl Seyfert in 1943.

**Shenzhou 5 spacecraft** On 15 October 2003, the People’s Republic of China became the third nation—following Russia (former Soviet Union) and the United States—to place a human being in ORBIT around EARTH using a national SPACE LAUNCH VEHICLE. On that date, a Chinese LONG MARCH 2F ROCKET lifted off from the Jiuquan Satellite Launch Center and placed the *Shenzhou 5* SPACECRAFT with TAIKONAUT YANG LIWEI onboard into orbit around Earth. After 14 orbits of Earth, the spacecraft reentered the ATMOSPHERE on 16 October and Yang Liwei was safely recovered in the Chinese portion of Inner Mongolia.

**Shenzhou 6 spacecraft** The second human-crewed mission launched by the People’s Republic of China started on 12 October 2005, with a successful LAUNCH from the Jiuquan Satellite Launch Center. A LONG MARCH 2F rocket carried TAIKONAUTS Fei Junlong and Nie Haisheng into ORBIT around EARTH. The *Shenzhou 6* has a design similar to the Russian SOYUZ SPACECRAFT but also contains significant modifications. This Chinese SPACECRAFT had a REENTRY capsule, an orbital module, and a propulsion module. After spending nearly five days in space and making 76 orbits of Earth, the two taikonauts returned safely to Earth in the *Shenzhou 6*’s reentry capsule, making a parachute-assisted SOFT LANDING in northern Inner Mongolia.

**shepherd moon** A small inner MOON (or pair of moons) that shapes and forms a particular RING around a (ringed) PLANET. For example, the shepherds, Ophelia and Cordelia, tend the Epsilon Ring of URANUS.

**shield volcano** A wide, gently sloping VOLCANO formed by the gradual outflow of molten rock; many occur on VENUS.

**shirtsleeve environment** A SPACE STATION module or SPACECRAFT cabin in which the ATMOSPHERE is similar to that found on the surface of EARTH—that is, it does not require a pressure suit.

**short-period comet** A COMET with an orbital PERIOD of less than 200 years.

**sidereal** Of or pertaining to the STARS.

**sidereal month** The average amount of time the MOON takes to complete one orbital REVOLUTION around EARTH when using the FIXED STARS as a reference; approximately 27.32 days.

## sidereal period – solar cell

## GLOSSARY

**sidereal period** The period of time required by a CELESTIAL BODY to complete one REVOLUTION around another celestial body with respect to the FIXED STARS.

**sidereal year** The period of one REVOLUTION of EARTH around the SUN with respect to the fixed STARS; some 365.25636 days.

**singularity** The hypothetical central point in a BLACK HOLE at which the curvature of space and time becomes infinite; a theoretical point that has infinite DENSITY and zero volume.

**SI units** The international system of units (the metric system) that uses the meter (m), kilogram (kg), and second (s) as its basic units of length, MASS, and time, respectively. *See also* SECTION IV CHARTS & TABLES.

**Skylab** The first U.S. SPACE STATION that NASA placed into ORBIT in 1973 and was visited by three ASTRONAUT crews between 1973–74. It reentered the ATMOSPHERE on 11 July 1979 as a large, abandoned derelict—with surviving SPACE (ORBITAL) DEBRIS pieces impacting in the Indian Ocean and remote portions of Australia.

**sloshing** The back-and-forth movement of a LIQUID PROPELLANT in its tank(s), creating stability and control problems for the ROCKET vehicle. Engineers often use ANTISLOSH BAFFLES in the PROPELLANT tanks to avoid this problem.

**Small Magellanic Cloud (SMC)** An IRREGULAR GALAXY about 9,000 LIGHT-YEARS in diameter and 180,000 light-years from EARTH. *See also* MAGELLANIC CLOUDS.

**soft landing** The act of landing onto the surface of a PLANET without damaging any portion of a SPACECRAFT or its PAYLOAD, except possibly an expendable landing gear structure. *Compare with* HARD LANDING.

**sol** A MARTIAN day (about 24 hours, 37 minutes, and 23 seconds in duration). Seven sols equal about 7.2 EARTH days.

**Sol** The SUN.

**solar** Of or pertaining to the SUN; caused by the Sun.

**solar activity** Any variation in the appearance or ENERGY output of the SUN.

**solar cell** A DIRECT-CONVERSION device that transforms incoming sunlight (SOLAR ENERGY) directly into electricity. It is used extensively (in combination with rechargeable storage batteries) as the prime source of electric POWER for SPACECRAFT orbiting EARTH or on missions within the inner SOLAR SYSTEM. Also called a photovoltaic cell.

## sidereal period – solar cell

## GLOSSARY



## GLOSSARY

### solar constant – solar nebula

**solar constant** The total average amount of the SOLAR ENERGY (in all WAVELENGTHS) crossing perpendicular to a unit area at the top of EARTH'S ATMOSPHERE. It is measured by SPACECRAFT at about 1,370 WATTS per square meter at one ASTRONOMICAL UNIT from the SUN.

**solar cycle** The approximately 11-YEAR period in the variation of the number of SUNSPOTS and the levels of SOLAR activity. *See* ACTIVE SUN; QUIET SUN; SUNSPOT CYCLE.

**solar eclipse** *See* ECLIPSE.

**solar-electric propulsion (SEP)** A low-THRUST PROPULSION SYSTEM that uses SOLAR CELLS to provide the electricity for a SPACECRAFT'S ELECTRIC PROPULSION ROCKET engines.

**solar energy** ENERGY from the SUN; radiant energy in the form of sunlight. *See also* SOLAR CONSTANT; SOLAR RADIATION.

**solar flare** A highly concentrated, explosive release of ELECTROMAGNETIC RADIATION and nuclear PARTICLES within the SUN'S ATMOSPHERE near an active SUNSPOT.

**solar mass** The MASS of the SUN, about  $1.99 \times 10^{30}$  kg. It is commonly used as a reference mass in stellar ASTRONOMY.

**solar nebula** The cloud of dust and gas from which the SUN, the PLANETS, and other minor bodies of this SOLAR SYSTEM are thought to have formed about 5 billion YEARS ago.

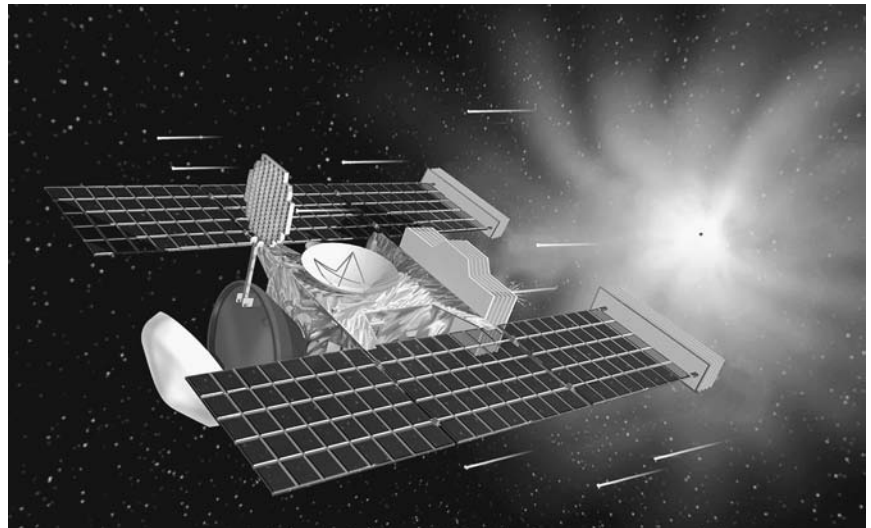

Solar-electric propulsion  
(NASA)

## GLOSSARY

### solar constant – solar nebula

## solar panel – solar system

## GLOSSARY

**solar panel** The winglike assembly of SOLAR CELLS used by a SPACECRAFT to convert sunlight (SOLAR ENERGY) directly into electrical ENERGY. Also called a solar array.

**solar particle event (SPE)** A SOLAR STORM capable of accelerating CHARGED PARTICLES (IONS) to energies that can penetrate an ASTRONAUT'S SPACESUIT and possibly his or her SPACECRAFT.

**solar photovoltaic conversion** The DIRECT CONVERSION of sunlight (SOLAR ENERGY) into electrical ENERGY by means of the photovoltaic effect in SOLAR CELLS. Engineers combine a number of solar cells to form a SOLAR PANEL that increases a SPACECRAFT'S electric power supply.

**solar radiation** The ELECTROMAGNETIC RADIATION emitted by the SUN, often approximated as a BLACKBODY RADIATION source at approximately 5,770 K. Therefore, 99.9 percent of the radiated SOLAR ENERGY lies within the WAVELENGTH interval 0.15 to 4.0 MICROMETERS ( $\mu\text{m}$ ). About 50 percent of that is in the visible portion of the ELECTROMAGNETIC (EM) SPECTRUM and the remainder in the near-infrared portion. *See also* INFRARED RADIATION; SOLAR CONSTANT.

**solar storm** A major disturbance in the space environment triggered by an intense SOLAR FLARE (or flares) that produces bursts of ELECTROMAGNETIC RADIATION and charged PARTICLES, threatening unprotected SPACECRAFT and ASTRONAUTS alike.

**solar system** In general, any STAR and its gravitationally-bound collection of nonluminous objects, such as PLANETS, ASTEROIDS, and COMETS; specifically, humans' home solar system, consisting of the SUN and all the objects bound to it by GRAVITATION—including eight MAJOR PLANETS, three DWARF PLANETS (CERES, PLUTO, and ERIS), more than 100 known MOONS, over 2,000 asteroids (minor planets), and a very large number of comets. Except for the comets, all the celestial objects travel around the Sun in the same direction. *See also* SECTION IV CHARTS & TABLES.

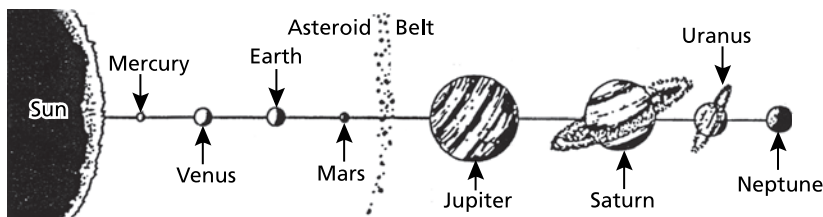

Solar system (Courtesy of NASA)

## solar panel – solar system

## GLOSSARY

## GLOSSARY



Solid rocket booster (SRB)  
(NASA)



A Soyuz-Fregat launch  
vehicle lifts off the  
Baikonur cosmodrome on  
July 15, 2000. (European  
Space Agency/Starsem)

## GLOSSARY

### solar wind – Soyuz (union) spacecraft

**solar wind** The variable stream of PLASMA (that is, ELECTRONS, PROTONS, ALPHA PARTICLES, and other atomic NUCLEI) that flows continuously outward from the SUN into INTERPLANETARY space.

**solid Earth** The lithosphere portion of the EARTH SYSTEM, including this PLANET'S CORE, mantle, crust, and all the surface rocks and unconsolidated rock fragments.

**solid-propellant rocket** A ROCKET propelled by a chemical mixture of fuel and OXIDIZER in solid form and intimately mixed into a monolithic (but not powdered) GRAIN. Sometimes called a solid rocket.

**solid-rocket booster (SRB)** The two very large SOLID-PROPELLANT ROCKETS that operate in parallel to augment the THRUST of the SPACE SHUTTLE'S three main engines for the first two minutes after LAUNCH. Each SRB develops about 11,800-kilonewtons (kN) of thrust at LIFTOFF. After burning for about 120 seconds, the depleted SRBs are JETTISONED from the space shuttle and recovered in the Atlantic Ocean DOWNRANGE of CAPE CANAVERAL for refurbishment and PROPELLANT reloading.

**solstice** The two times of the YEAR when the SUN'S position in the sky is the most distant from the celestial EQUATOR. For the Northern Hemisphere, the summer solstice (longest day) occurs about 21 June and the winter solstice (shortest day) about 21 December.

**sounding rocket** A SOLID-PROPELLANT ROCKET used to carry scientific instruments on parabolic TRAJECTORIES into the upper regions of EARTH'S SENSIBLE ATMOSPHERE and into near-Earth space.

**Soyuz launch vehicle** The "workhorse" Soviet (and later Russian) LAUNCH VEHICLE that was first used in 1963. With its two CRYOGENIC-PROPELLANT stages and four cryogenic strap-on engines, this vehicle is capable of placing PAYLOADS of up to 6,900 kg into LOW EARTH ORBIT (LEO). At present, it is the most frequently flown launch vehicle in the world. Since 1964, the Soyuz ROCKET has also been used to launch every Russian human crew space mission. *See also* SECTION IV CHARTS & TABLES.

**Soyuz (union) spacecraft** The evolutionary family of crewed Russian SPACECRAFT used by COSMONAUTS on a wide variety of EARTH-orbiting missions since 1967. Unfortunately, malfunctions with this spacecraft caused the two major Russian space tragedies: *Soyuz 1* and the death of cosmonaut Vladimir Komarov (1967), and *Soyuz 11* and the deaths of cosmonauts Georgi Dobrovolsky, Victor Patseyev, and Vladislav Volkov (1971). The *Soyuz 19* was successfully used by

### solar wind – Soyuz (union) spacecraft

## space – *Spacelab*

cosmonauts Leonov and Kubasov during the international APOLLO-SOYUZ TEST PROJECT (1975).

**space** OUTER SPACE; all the regions of the UNIVERSE that lie beyond the limits of EARTH'S SENSIBLE ATMOSPHERE.

**space base** A large, permanently inhabited space facility located in ORBIT around a CELESTIAL BODY or on its surface that would serve as the center of future human operations in some particular region of the SOLAR SYSTEM. *See also* LUNAR BASE; MARS BASE.

**space-based astronomy** The use of astronomical instruments on SPACECRAFT in ORBIT around EARTH and in other locations throughout the SOLAR SYSTEM to view the UNIVERSE from above Earth's ATMOSPHERE. Major breakthroughs in astronomy, ASTROPHYSICS, and COSMOLOGY have occurred because of the unhampered viewing advantages provided by space platforms.

**space capsule** The family of small, container-like, tear-shaped SPACECRAFT used to carry American ASTRONAUTS into OUTER SPACE and return them to EARTH as part of NASA'S MERCURY PROJECT, GEMINI PROJECT, and APOLLO PROJECT.

**spacecraft** A platform that can function, move, and operate in OUTER SPACE or on a planetary surface. Spacecraft can be human occupied or uncrewed (robot) platforms. They can operate in ORBIT around EARTH or while on an INTERPLANETARY TRAJECTORY to another CELESTIAL BODY. Some spacecraft travel through space and orbit another PLANET. Others descend to a planet's surface, making a HARD LANDING (collision IMPACT) or a (survivable) SOFT LANDING. Exploration spacecraft are often categorized as either FLYBY, ORBITER, ATMOSPHERIC PROBE, LANDER, or ROVER spacecraft.

**spacecraft clock** The time-keeping component within a SPACECRAFT'S command and data-handling system. It meters the passing time during a mission and regulates nearly all activity within the spacecraft.

**Spacelab (SL)** An orbiting laboratory facility delivered into OUTER SPACE and sustained while in ORBIT within the huge CARGO BAY of NASA'S SPACE SHUTTLE ORBITER. Developed by the EUROPEAN SPACE AGENCY (ESA) in cooperation with NASA, *Spacelab* featured several interchangeable elements that were arranged in various configurations to meet the particular needs of a given flight. The major elements were a habitable module (short or long configuration) and pallets for instruments and experiments requiring direct exposure to the space environment.

## space – *Spacelab*

## GLOSSARY



Soyuz TMA-1 spacecraft  
(NASA)

## GLOSSARY

## GLOSSARY



Space (orbital) debris  
(Courtesy of USAF and NASA)

## space launch vehicle – space resources

**space launch vehicle (SLV)** The expendable or reusable ROCKET-propelled vehicle(s) used to lift a PAYLOAD or SPACECRAFT from the surface of EARTH and place it into ORBIT around the PLANET or on an INTERPLANETARY TRAJECTORY.

**spaceman** A person, male or female, who travels in OUTER SPACE. The term *ASTRONAUT* is preferred.

**space medicine** The branch of AEROSPACE MEDICINE concerned specifically with the health of persons who make, or expect to make, flights beyond EARTH'S SENSIBLE ATMOSPHERE into OUTER SPACE.

**space (orbital) debris** Space junk; abandoned or discarded human-made objects in ORBIT around EARTH. It includes operational debris (items discarded during SPACECRAFT deployment), used or failed ROCKETS, inactive or broken SATELLITES, and fragments from collisions and space object breakup. When a spacecraft collides with an object or a discarded rocket spontaneously explodes, thousands of debris fragments become part of the orbital debris population.

**space physics** The branch of physics that studies the magnetic and electric phenomena that occur in OUTER SPACE, in the upper ATMOSPHERE of various PLANETS, and on the SUN.

**space platform** An uncrewed, free-flying platform in orbit around EARTH that is dedicated to a specific mission, such as the long-duration exposure of test materials to the space environment.

**spaceport** A facility that serves as both a doorway to OUTER SPACE from the surface of a PLANET and as a port of entry for AEROSPACE VEHICLES returning from space to the planet's surface. NASA'S KENNEDY SPACE CENTER with its SPACE SHUTTLE LAUNCH SITE and landing complex is an example.

**space probe** See PLANETARY PROBE.

**space radiation environment** One of the major concerns associated with the development of a permanent human presence in OUTER SPACE is the IONIZING RADIATION environment, both natural and human-made. The natural portion of the space radiation environment consists primarily of EARTH'S TRAPPED RADIATION BELTS (also called the VAN ALLEN RADIATION BELTS), SOLAR PARTICLE EVENTS (SPEs), and GALACTIC COSMIC RAYS (GCRs).

**space resources** The resources available in OUTER SPACE that could be used to support an extended human presence and eventually become the physical basis for a thriving SOLAR SYSTEM-level civilization. These EXTRATERRESTRIAL resources include unlimited SOLAR ENERGY,

## GLOSSARY

## space launch vehicle – space resources

## space settlement – space walk

mineral resources (from the MOON, ASTEROIDS, MARS, and numerous OUTER PLANET MOONS), LUNAR (water) ice, and special environmental conditions like access to a high vacuum and physical isolation from the TERRESTRIAL BIOSPHERE.

**space settlement** A proposed very large, human-made habitat in OUTER SPACE within which from 1,000 to 10,000 people would live, work, and play while supporting various research and commercial activities, such as the construction of SATELLITE POWER SYSTEMS.

**spaceship** An INTERPLANETARY SPACECRAFT that carries a human crew.

**space shuttle** The major spaceflight component of NASA's Space Transportation System (STS). It consists of a winged orbiter vehicle, three space shuttle main engines (SSMEs), the giant EXTERNAL TANK (ET)—which feeds LIQUID HYDROGEN and LIQUID OXYGEN to the shuttle's three main LIQUID-PROPELLANT ROCKET ENGINES—and the two SOLID-ROCKET BOOSTERS (SRBs). *See also* SECTION IV CHARTS & TABLES.

**space sickness** The space-age form of motion sickness whose symptoms include nausea, vomiting, and general malaise. This temporary condition lasts no more than a day or so. However, it affects 50 percent of the ASTRONAUTS or COSMONAUTS when they encounter the MICROGRAVITY environment (WEIGHTLESSNESS) of an orbiting SPACECRAFT after a launch. Also called space adaptation syndrome.

**space station** An EARTH-orbiting facility designed to support long-term human habitation in OUTER SPACE. *See also* INTERNATIONAL SPACE STATION.

**spacesuit** The flexible, outer garmentlike structure (including visored helmet) that protects an ASTRONAUT in the hostile environment of OUTER SPACE. It provides portable life support functions, supports communications, and accommodates some level of movement and flexibility so the astronaut can perform useful tasks during an EXTRA-VEHICULAR ACTIVITY or while exploring the surface of another world.

**space-time** (or spacetime) Synthesis of the three spatial dimensions and a fourth dimension, time. ALBERT EINSTEIN used the concept of space-time in both his special and general RELATIVITY theories.

**space transportation system (STS)** The official name for NASA's SPACE SHUTTLE.

**space vehicle** The general term describing a crewed or robot vehicle capable of traveling through OUTER SPACE. An AEROSPACE VEHICLE can operate both in outer space and in EARTH's ATMOSPHERE.

**space walk** The popular term for an EXTRAVEHICULAR ACTIVITY (EVA).

## space settlement – space walk

## GLOSSARY

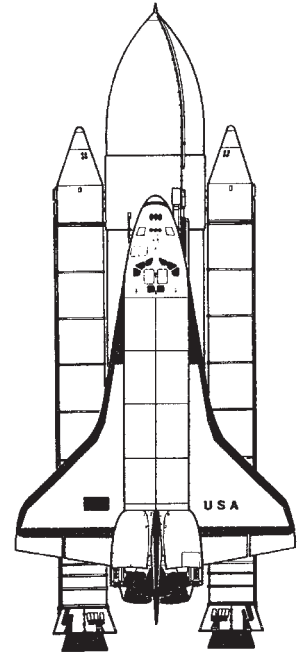

Space shuttle



Spacesuit (NASA)

## GLOSSARY

## GLOSSARY

### special relativity – spin stabilization

**special relativity** Theory introduced by ALBERT EINSTEIN in 1905. *See* RELATIVITY.

**specific impulse** ( $I_{sp}$ ) An index of performance for ROCKET engines and their various PROPELLANT combinations. It is defined as the THRUST produced by propellant combustion divided by the propellant mass flow rate.

**spectral classification** The system in which STARS are given a designation. It consists of a letter and a number according to their SPECTRAL LINES, which correspond roughly to surface temperature. Astronomers classify stars as O (hottest), B, A, F, G, K, and M (coolest). The numbers represent subdivisions within each major class. The SUN is a G2 star. M stars are numerous but very dim, while O and B stars are very bright but rare. *See also* HARVARD CLASSIFICATION SYSTEM.

**spectral line** A narrow range of spectral color, emitted (or absorbed) by a specific ATOM or MOLECULE. Characteristic emission line PHOTONS are produced when ELECTRONS of the atom or molecule transition (fall) from a higher (excited) ENERGY state to a lower energy state. *See also* ABSORPTION LINE.

**spectrogram** The photographic IMAGE of a SPECTRUM.

**spectrometer** An optical instrument that splits incoming visible LIGHT (or other ELECTROMAGNETIC RADIATION) from a celestial object into a SPECTRUM by DIFFRACTION and then measures the relative amplitudes of the different WAVELENGTHS. INFRARED RADIATION and ULTRAVIOLET RADIATION spectrometers are often carried on scientific SPACECRAFT.

**spectroscopy** The study of SPECTRAL LINES from different ATOMS and MOLECULES. Astronomers use emission spectroscopy to infer the material composition of the objects that emitted the LIGHT and absorption spectroscopy to infer the composition of the intervening medium.

**spectrum** (*plural: spectra*) A plot of the intensity of incident ELECTROMAGNETIC RADIATION as a function of WAVELENGTH (or FREQUENCY). Originally, it was the dispersion of white LIGHT into the spread of pure colors visible to the eye as seen in a rainbow. *See also* ELECTROMAGNETIC (EM) SPECTRUM.

**speed of light** ( $c$ ) The speed at which ELECTROMAGNETIC RADIATION (including LIGHT) moves through a vacuum; a universal constant equal to approximately 300,000 km/s.

**spin stabilization** Directional stability of a MISSILE or SPACECRAFT obtained as a result of spinning the moving body about its AXIS of symmetry.

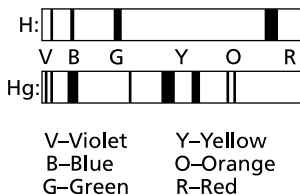

Spectrum

## GLOSSARY

### special relativity – spin stabilization

spiral galaxy – *Sputnik 1*



GLOSSARY

Spiral galaxy (NGC 4414)  
(NASA and STScI)

**spiral galaxy** A GALAXY with spiral arms, similar to the MILKY WAY GALAXY or the ANDROMEDA GALAXY.

**Spitzer Space Telescope (SST)** NASA successfully launched the *Spitzer Space Telescope* (previously called the *Space Infrared Telescope Facility*, or *SIRTF*) from CAPE CANAVERAL on 25 August 2003. The 0.85-m diameter TELESCOPE and its three cryogenically cooled science instruments were placed in an EARTH-trailing HELIOCENTRIC ORBIT and has obtained IMAGES and SPECTRA of celestial objects at INFRARED RADIATION WAVELENGTHS between 3 and 180 MICROMETERS ( $\mu\text{m}$ ). The fourth and final mission in NASA's GREAT OBSERVATORIES PROGRAM, this orbiting infrared telescope was named in honor of LYMAN SPITZER, JR.

**SPOT** A family of EARTH-OBSERVING SPACECRAFT built by the French Space Agency (CNES). The ACRONYM SPOT stands for satellite pour l'observation de la terre.

**Sputnik 1** Launched by the former Soviet Union on 4 October 1957, it was the first artificial SATELLITE to ORBIT EARTH. *Sputnik* means “fellow

spiral galaxy – *Sputnik 1*

GLOSSARY



## GLOSSARY

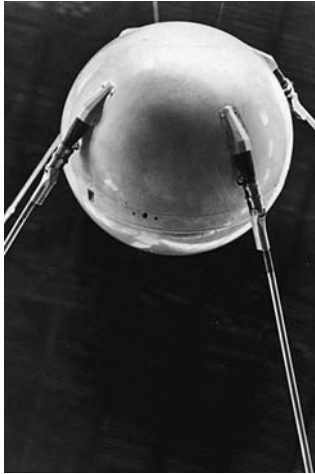

Sputnik 1 (NASA)



Star cluster (Courtesy of NASA and USNO)

## GLOSSARY

### spy satellite – star probe

traveler.” This simple, spherically shaped, 84 kg Russian SPACECRAFT inaugurated the space age.

**spy satellite** Popular term for a military reconnaissance satellite. *See also* RECONNAISSANCE SATELLITE.

**staging** The practice of placing smaller ROCKETS on top of larger ones, thereby increasing the ability of the combination to lift larger PAYLOADS or to give a particular payload a higher final VELOCITY. In MULTISTAGE ROCKETS, the stages are numbered chronologically in the order of burning (that is, first stage, second stage, third stage, and so on). When the first stage stops burning, it separates from the rest of the vehicle and falls away. Then the second-stage rocket ignites, fires until burnout, and also separates. The staging process continues up to the last stage, which contains the PAYLOAD. In this way, the MASS of empty PROPELLANT tanks is discarded during the ascent.

**star** A self-luminous ball of very hot gas (PLASMA) that liberates ENERGY through thermonuclear FUSION reactions within its CORE. Stars are classified as either normal or abnormal. Normal stars, like the SUN, shine steadily—exhibiting one of a variety of distinctive colors such as red, orange, yellow, white, and blue (in order of increasing surface temperature). There are also several types of abnormal stars including GIANT STARS, WHITE DWARFS, BLACK DWARFS, BROWN DWARFS, and VARIABLE STARS. Stars experience an evolutionary life cycle from birth in an INTERSTELLAR cloud of gas to death as a compact white dwarf, NEUTRON STAR, or BLACK HOLE. *See also* DWARF STAR.

**star cluster** A group of STARS (numbering from a few to perhaps thousands) that were formed from a common gas cloud and are now bound together by their mutual gravitational attraction.

**Stardust mission** The primary objective of this mission by NASA was to fly by the Comet Wild 2 and collect samples of dust and volatiles present in the COMA of the COMET. The *Stardust* ROBOT SPACECRAFT was launched from CAPE CANAVERAL on 7 February 1999 using an expendable DELTA II ROCKET. The spacecraft flew by the NUCLEUS of the target comet on 2 January 2004. Material samples were collected and stowed in a special REENTRY capsule carried onboard the spacecraft. As *Stardust* flew past EARTH in mid-January 2006, the material collection package was successfully ejected and returned to scientists on EARTH.

**star probe** A conceptual NASA robot scientific SPACECRAFT, capable of approaching within 1 million km of the SUN’s surface (PHOTOSPHERE)

### spy satellite – star probe

## starship – storable propellant

and providing the first in situ measurements of its CORONA (outer ATMOSPHERE).

**starship** A conceptual, very advanced SPACE VEHICLE capable of traveling the great distances between STAR systems within decades or less. The term *starship* is generally reserved for vehicles that could carry intelligent beings, while INTERSTELLAR PROBE applies to an advanced ROBOT SPACECRAFT capable of interstellar travel at 10 percent or more of the SPEED OF LIGHT.

**station keeping** The sequence of maneuvers that maintains a SPACE VEHICLE or SPACECRAFT in a predetermined ORBIT or on a desired TRAJECTORY.

**steady state** The condition of a physical system in which parameters of importance do not vary significantly with time.

**steady-state universe** A COSMOLOGY model (based on the PERFECT COSMOLOGICAL PRINCIPLE) suggesting that the UNIVERSE looks the same to all observers at all times.

**Stefan-Boltzmann law** The RADIATION HEAT TRANSFER relationship developed by LUDWIG BOLTZMANN and JOSEF STEFAN. It states that the ELECTROMAGNETIC RADIATION emitted by an ideal BLACKBODY radiator per unit time per unit area is proportional to the fourth power of its ABSOLUTE TEMPERATURE.

**stellar evolution** The different phases in the lifetime of a STAR from its formation out of INTERSTELLAR gas and dust to the time after its nuclear FUSION fuel is exhausted.

**stellar luminosity class** Using the width of a STAR'S SPECTRAL LINES, astronomers use luminosity class to distinguish GIANT STARS from MAIN SEQUENCE STARS, SUPERGIANTS from giants, and so forth. *See also* SECTION IV CHARTS AND TABLES.

**steradian** (sr) The SI UNIT of solid ANGLE, defined as the solid angle subtended at the center of a sphere by an area of surface equal to the square of the radius. The total surface of a sphere subtends a solid angle of  $4\pi$  Sr about its center.

**Stonehenge** A circular ring of large vertical stones topped by capstones located in southern England. It is believed to have been built between 3000 B.C.E. and 1000 B.C.E. as an ancient astronomical CALENDAR. *See also* ARCHAEOLOGICAL ASTRONOMY.

**storable propellant** ROCKET PROPELLANT (usually liquid) that can be stored for prolonged periods without special temperature or pressure environments.

## GLOSSARY



Starship (NASA)

## starship – storable propellant

## GLOSSARY

## GLOSSARY

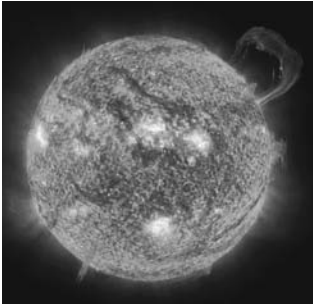

Sun (NASA and ESA)

## Sun – supernova

**Sun** Humans' parent STAR (SOL), the central CELESTIAL BODY in the SOLAR SYSTEM. It is a MAIN-SEQUENCE STAR of SPECTRAL CLASSIFICATION G2V that derives most of its ENERGY from the FUSION of HYDROGEN into HELIUM. *See also* SOLAR CONSTANT; SOLAR ENERGY; SOLAR RADIATION.

**sunlike star** A yellow, G SPECTRAL CLASSIFICATION, MAIN-SEQUENCE STAR with a surface temperature between 5,000 K and 6,000 K.

**sunspot** A relatively dark, sharply defined region on the SUN's visible surface that represents a magnetic area. The sunspot's umbra (darkest region) is about 2,000 K cooler than the effective temperature of the PHOTOSPHERE (some 5,800 K). It is surrounded by a less dark region called the penumbra. Sunspots generally occur in groups of two or more and have diameters ranging from 4,000 km to over 200,000 km.

**sunspot cycle** The approximately 11-year cycle in the variation of the number of SUNSPOTS. A reversal in the SUN's magnetic polarity also occurs with each successive sunspot cycle, creating a 22-year solar magnetic cycle.

**Sun-synchronous orbit** A very useful POLAR ORBIT that allows a SATELLITE'S SENSOR to maintain a fixed relation to the SUN during each local data collection—an important feature for EARTH-OBSERVING SPACECRAFT.

**supergiant** (*star*) The largest and brightest type of STAR with a LUMINOSITY of 10,000 to 100,000 times that of the SUN and a radius between 100 and 1,000 times the radius of the Sun. Because of their intense brightness, astronomers assign supergiants a STELLAR LUMINOSITY class of I. Rigel is an example of a *blue supergiant* and Betelgeuse a *red supergiant*.

**superior conjunction** *See* CONJUNCTION.

**superior planet** A MAJOR PLANET that has an ORBIT around the SUN outside EARTH'S orbit. The major planets are MARS, JUPITER, SATURN, URANUS, and NEPTUNE. *Compare with* INFERIOR PLANET.

**superluminal** With a (hypothetical) speed greater than the SPEED OF LIGHT.

**supernova** (*plural: supernovas or supernovae*) The catastrophic explosion of a massive STAR at the end of its life cycle. As the star collapses and explodes, it experiences a variety of energetic nuclear reactions that lead to the creation of heavier ELEMENTS, which are then scattered into SPACE. Its brightness increases several million times in a matter of days and the supernova outshines all other CELESTIAL objects in its GALAXY. Astrophysicists generally divide supernovas

## GLOSSARY

## Sun – supernova

## surveillance satellite – tail

into two basic physical types: the *Type Ia supernova* (a carbon-detonation supernova) and the *Type II supernova* (a core-collapse supernova).

**surveillance satellite** An EARTH-orbiting military SATELLITE that watches regions of the PLANET for hostile military activities, such as BALLISTIC MISSILE LAUNCHES and nuclear weapons detonations. *See also* DEFENSE SUPPORT PROGRAM.

**Surveyor Project** The NASA MOON exploration effort in which five LANDER SPACECRAFT softly touched down onto the LUNAR surface between 1966–68—the robot precursor to the APOLLO PROJECT human expeditions.

**synchronous orbit** An ORBIT around a PLANET (or PRIMARY BODY) in which a SATELLITE (secondary body) moves around the planet in the same amount of time the planet takes to rotate on its AXIS. *See also* GEOSYNCHRONOUS ORBIT.

**synchronous rotation** The ROTATION of a MOON around its PRIMARY BODY (PLANET) in which the orbital PERIOD equals the period of rotation of the NATURAL SATELLITE about its own AXIS. As a result, the moon always presents the same side (face) to the parent planet. The EARTH-MOON orbital relationship is an example.

**synchronous satellite** An equatorial west-to-east satellite orbiting EARTH at an ALTITUDE of approximately 35,900 km. At this altitude, the satellite makes one REVOLUTION in 24 hours and remains synchronous with Earth's ROTATION. *See also* GEOSYNCHRONOUS ORBIT.

**synchrotron radiation** ELECTROMAGNETIC RADIATION given off when very high-energy ELECTRONS traveling at nearly the SPEED OF LIGHT encounter magnetic fields.

**synthetic aperture radar** A space-based radar system that computer correlates the echoes of signals emitted at different points along a SATELLITE'S ORBIT—thereby mimicking the performance of a radar antenna system many times larger than the one actually being used. *See also* RADARSAT.

**taikonaut** The suggested Chinese equivalent to ASTRONAUT and COSMONAUT. *Taikong* is Chinese word for SPACE or cosmos; so the prefix “taiko-” assumes the same concept and significance as the use of “ASTRO-” or “cosmo-” to form the words astronaut and cosmonaut.

**tail** (*cometary*) The long, wispy portion of some COMETS, containing the gas (plasma tail) and dust (dust tail) streaming out of the comet's

## GLOSSARY



Surveillance satellite (USAF)



Apollo astronaut visiting Surveyor 3 spacecraft (NASA)

## surveillance satellite – tail

## GLOSSARY

## GLOSSARY



Telepresence on Moon using a mobile robot (NASA)

## telecommunications – terrestrial planets

head (COMA) as it approaches the SUN. The plasma tail interacts with the SOLAR WIND and points straight back from the Sun, while the dust tail can be curved and fan shaped.

**telecommunications** The transmission of information over great distances using RADIO WAVES or other portions of the ELECTROMAGNETIC (EM) SPECTRUM. *See also* COMMUNICATIONS SATELLITE.

**telemetry** The process of taking measurements at one point and transmitting the information via RADIO WAVES over some distance to another location for evaluation and use. Telemetered data on a SPACECRAFT's communications DOWNLINK often includes scientific data as well as spacecraft state-of-health data.

**teleoperation** The technique by which a human controller operates a versatile robot system that is at a distant, often hazardous, location. High-resolution visual and tactile sensors on the robot, reliable TELECOMMUNICATIONS links, and computer-generated virtual reality displays enable the human worker to experience TELEPRESENCE.

**telepresence** The process, supported by an information-rich control station environment, that enables a human controller to manipulate a distant robot through TELEOPERATION and almost feel physically present in the robot's remote location.

**telescope** An instrument that collects ELECTROMAGNETIC RADIATION from a distant object so as to form an IMAGE of the object or to permit the radiation signal to be analyzed. Optical (astronomical) TELESCOPES are divided into two general classes: REFRACTING TELESCOPES and REFLECTING TELESCOPES. EARTH-based astronomers also use large RADIO TELESCOPES. Orbiting observatories use optical, INFRARED RADIATION, ULTRAVIOLET RADIATION, X-RAY, and GAMMA RAY telescopes to study the UNIVERSE.

**terminator** The distinctive boundary line separating the illuminated (that is, sunlit) and dark portions of a nonluminous CELESTIAL BODY like the MOON.

**Terra** The first in a new family of sophisticated NASA EARTH-OBSERVING SPACECRAFT, successfully placed into POLAR ORBIT on 18 December 1999 from VANDENBERG AIR FORCE BASE, California.

**terrestrial** Of or relating to EARTH.

**terrestrial planets** In addition to EARTH, the PLANETS MERCURY, VENUS, and MARS—all of which are relatively small, high-DENSITY CELESTIAL BODIES, composed of metals and silicates, and with shallow or no ATMOSPHERES in comparison with the JOVIAN PLANETS.

## GLOSSARY

## telecommunications – terrestrial planets

## thermonuclear – Triton

**thermonuclear** *See* FUSION.

**Thor** An INTERMEDIATE-RANGE BALLISTIC MISSILE (IRBM) developed by the U.S. Air Force in the late 1950s; also used by NASA and the military as a SPACE LAUNCH VEHICLE.

**throttling** The variation of the THRUST of a ROCKET engine during powered flight.

**thrust** (*T*) The forward FORCE provided by a REACTION ENGINE, such as a ROCKET.

**tidal force** A FORCE that arises in a system of one or more CELESTIAL BODIES because of a difference in GRAVITATION. On EARTH, the tides in the ocean are the result of the combined tidal forces of the MOON and the SUN.

**Titan** (1) (*launch vehicle*) The family of powerful U.S. Air Force BALLISTIC MISSILES and EXPENDABLE LAUNCH VEHICLES that began in 1955 with the Titan I—the first American two-stage INTERCONTINENTAL BALLISTIC MISSILE (ICBM). The Titan IV is the newest and most powerful member.

(2) (*moon*) The largest MOON of SATURN, discovered in 1655 by CHRISTIAAN HUYGENS. It is the only SATELLITE in the SOLAR SYSTEM with a significant ATMOSPHERE.

**tracking** Following the movement of a SATELLITE, ROCKET, or AEROSPACE VEHICLE. It is usually performed with optical, INFRARED RADIATION, RADAR ASTRONOMY, or RADIO WAVE systems.

**trajectory** The three-dimensional path traced by any object moving because of an externally applied FORCE; the flight path of a SPACE VEHICLE.

**transfer orbit** An elliptical INTERPLANETARY TRAJECTORY tangent to the ORBITS of both the departure PLANET and target planet (or MOON). *See also* HOHMANN TRANSFER ORBIT.

**transit** (*planetary*) The passage of one CELESTIAL BODY in front of another (larger-diameter) celestial body, such as VENUS across the face of the SUN.

**trans-Neptunian object** (TNO) Any of the numerous small, icy CELESTIAL BODIES that lie in the outer fringes of the SOLAR SYSTEM beyond NEPTUNE. TNOs include PLUTINOS and KUIPER BELT objects.

**tritium** (T or  $^3_1\text{H}$ ) The RADIOISOTOPE of HYDROGEN with two NEUTRONS and one PROTON in the NUCLEUS. It has a HALF-LIFE of 12.3 years.

**Triton** The largest MOON of NEPTUNE.

## thermonuclear – Triton

## GLOSSARY



Titan IV launch vehicle (NASA and USAF)



Lakes of liquid methane on Saturn's moon Titan (NASA)

## GLOSSARY

## GLOSSARY

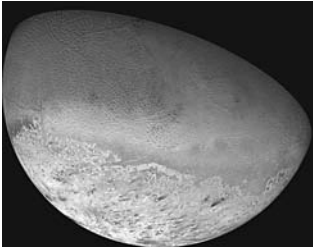

Triton (NASA)



Universe (NASA, ESA, and STScI)

## GLOSSARY

### Trojan Group – uplink

**Trojan group** The collection of ASTEROIDS found near the two LAGRANGIAN LIBRATION POINTS in JUPITER'S ORBIT around the SUN. Many of these MINOR PLANETS were named after the mythical heroes of the Trojan War.

**Tunguska event** A violent explosion that occurred in a remote area of Siberia in late June 1908 that some scientists now attribute to the IMPACT of an extinct cometary NUCLEUS or a large, stony METEORITE.

**turbopump system** The high-speed pumping equipment in a LIQUID-PROPELLANT ROCKET ENGINE, designed to raise the pressure of the PROPELLANTS (fuel and OXIDIZER) so they can go from the tanks into the COMBUSTION CHAMBER at specified flow rates.

**ullage** The amount that a container, such as a PROPELLANT tank, lacks of being full.

**ultraviolet astronomy** The branch of ASTRONOMY, conducted primarily from space-based observatories, that uses the ultraviolet portion of the ELECTROMAGNETIC (EM) SPECTRUM to study unusual INTERSTELLAR and intergalactic phenomena.

**ultraviolet radiation (UV)** The region of the ELECTROMAGNETIC (EM) SPECTRUM between visible (violet) LIGHT and X-RAYS, with wavelengths from 400 NANOMETERS (nm) (just past violet light) down to about 10 nm (the extreme ultraviolet cutoff).

**umbilical** An electrical or fluid-servicing line between the ground or tower and an upright ROCKET vehicle before LAUNCH.

**Unity** The first U.S.-built component of the *INTERNATIONAL SPACE STATION*. A six-sided connecting module and passageway (node), Unity was the primary cargo of the SPACE SHUTTLE *Endeavour* during the STS-88 mission in early December 1998. Once delivered into ORBIT, ASTRONAUTS mated Unity to the Russian-built ZARYA module—delivered earlier into orbit by a Russian PROTON ROCKET that lifted off from the BAIKONUR COSMODROME.

**universal time coordinated (UTC)** The worldwide scientific standard of timekeeping, based on carefully maintained ATOMIC CLOCKS. Its reference point is Greenwich, England.

**universe** Everything that came into being at the moment of the BIG BANG and everything that has evolved since then. It includes all ENERGY, all matter, and the space-time continuum that contains them.

**uplink** The TELEMETRY signal sent from a ground station to a SPACECRAFT or PLANETARY PROBE.

### Trojan Group – uplink

## upper stage – vengeance weapon 2

**upper stage** The second, third, or later ROCKET stage of a MULTISTAGE ROCKET vehicle. Once lifted into LOW EARTH ORBIT, a spacecraft often uses an attached upper stage to reach its final destination—a higher ALTITUDE ORBIT around EARTH or an INTERPLANETARY TRAJECTORY. *See also* INERTIAL UPPER STAGE; PAYLOAD ASSIST MODULE; STAGING.

**Uranus** The seventh PLANET from the SUN, unknown until discovered with a TELESCOPE in 1781 by SIR (FREDERICK) WILLIAM HERSCHEL. Its AXIS of ROTATION lies in the plane of its orbit around the Sun rather than vertical to the orbital plane, as occurs with the other planets.

**U.S. Naval Observatory (USNO)** The astronomical OBSERVATORY founded by the U.S. government in Washington, D.C., in 1844.

**Utopia Planitia** (Plains of Utopia) The smooth MARTIAN plain on which NASA's *Viking 2* LANDER successfully touched down on 3 September 1976. *See also* VIKING PROJECT.

**Valles Marineris** An extensive canyon system on MARS near the PLANET'S EQUATOR, discovered in 1971 by NASA'S *MARINER 9* SPACECRAFT.

**Van Allen radiation belts** *See* EARTH'S TRAPPED RADIATION BELTS; *EXPLORER 1*.

**Vandenberg Air Force Base (VAFB)** Located on the central California coast north of Santa Barbara, this U.S. Air Force facility is the LAUNCH SITE of all military, NASA, and commercial space launches that require high INCLINATION, especially POLAR ORBITS.

**variable star** A STAR that does not shine steadily but whose brightness (LUMINOSITY) changes over a short period of time.

**vector** A physical quantity, such as FORCE, VELOCITY, or ACCELERATION, that has both magnitude and direction at each point in space. It is contrasted with a scalar quantity, which has just magnitude.

**velocity** A VECTOR quantity that describes the rate of change of position. Velocity has both magnitude (speed) and direction. It is expressed in units of length per unit of time (for example, kilometers per second).

**Venera** The family of Russian SPACECRAFT (FLYBYS, ORBITERS, PROBES, and LANDERS) that successfully explored VENUS, including its inferno-like surface, between 1961–84.

**vengeance weapon 2 (V-2)** The V-2 or *Vergeltungswaffe 2* was the first modern military BALLISTIC MISSILE. This LIQUID-PROPELLANT ROCKET was designed and flown by the German Army during World War II

## GLOSSARY



Vandenberg Air Force Base  
(Courtesy of USAF)

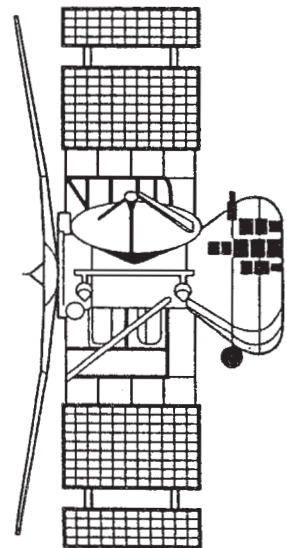

Venera 15

## upper stage – vengeance weapon 2

## GLOSSARY



## GLOSSARY

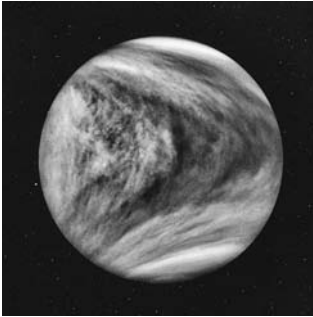

Venus (Courtesy of NASA)

## Venus – Voskhod

and then became the technical ancestor for many large American and Russian rockets constructed during the COLD WAR.

**Venus** The cloud-enshrouded second PLANET from the SUN whose ATMOSPHERE portrays an inferno-like RUNAWAY GREENHOUSE effect.

**Venus Express mission** The EUROPEAN SPACE AGENCY (ESA) assembled the *Venus Express* SPACECRAFT using upgraded versions of many of the instruments developed for the *MARS EXPRESS*. On 9 November 2005, a Russian SOYUZ-Fregat LAUNCH VEHICLE sent the spacecraft on its way to VENUS from the BAIKONUR COSMODROME. *Venus Express* entered ORBIT around the PLANET on 11 April 2006 and began its science mission, which will extend until at least May 2009.

**Venusian** Of or pertaining to the PLANET VENUS.

**vernal equinox** The spring EQUINOX, which occurs on or about 21 March.

**vernier engine** A ROCKET engine of small THRUST used primarily to obtain a fine adjustment in the VELOCITY and TRAJECTORY or in the ATTITUDE of a rocket or AEROSPACE VEHICLE.

**Very Large Array (VLA)** A spatially extended RADIO TELESCOPE facility at Socorro, New Mexico. It consists of 27 ANTENNAS, each 25 m in diameter, that are configured in a giant “Y” arrangement on railroad tracks over a 20 km distance. The VLA is operated by the NATIONAL RADIO ASTRONOMY OBSERVATORY and sponsored by the National Science Foundation.

**Vesta** The brightest of all the minor planets in the ASTEROID BELT. The large ASTEROID is about 540 km in diameter and was discovered in 1807 by HEINRICH WILHELM OLBERS.

**Viking Project** NASA’s highly successful MARS exploration effort in the 1970s in which two ORBITER and two LANDER SPACECRAFT conducted the first detailed study of the Martian environment and the first (albeit inconclusive) scientific search for life on the RED PLANET.

**visible radiation** *See* LIGHT.

**volcano** A vent in the crust of a PLANET or MOON from which molten lava, gases, and other pyroclastic materials flow.

**Voskhod** (“Sunrise”) An early Russian three-person SPACECRAFT that evolved from the VOSTOK spacecraft. *Voskhod 1* was launched on 12 October 1964 and carried the first three-person crew into SPACE. *Voskhod 2* was launched on 18 March 1965 and carried a crew of two COSMONAUTS, including ALEXEI ARKHIPOVICH LEONOV, who

## GLOSSARY

## Venus – Voskhod

Viking Project (lander)  
(Courtesy of NASA)

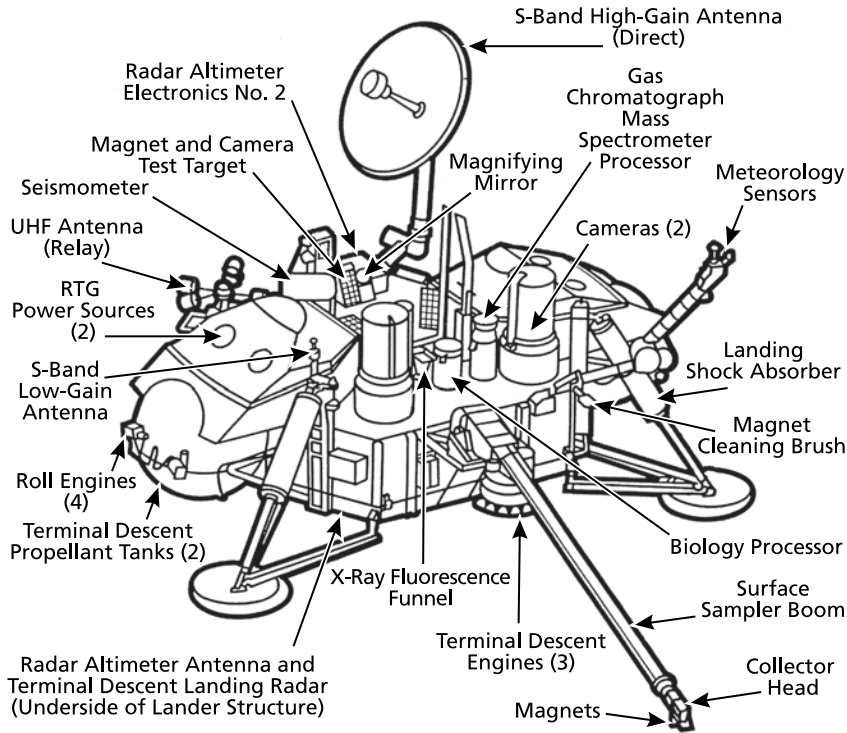

performed the world's first EXTRAVEHICULAR ACTIVITY or space walk (about 10 minutes in duration) during the orbital mission.

**Vostok** (“East”) The first Russian crewed SPACECRAFT, with room for just a single COSMONAUT. *Vostok 1* was launched on 12 April 1961, carrying cosmonaut YURI A. GAGARIN—the first human to fly in OUTER SPACE. Gagarin’s flight made one ORBIT of EARTH and lasted about 108 minutes.

**Voyager** NASA’s twin SPACECRAFT that explored the outer regions of the SOLAR SYSTEM, visiting all the JOVIAN PLANETS. *Voyager 1* encountered JUPITER (1979) and SATURN (1980) before departing on an INTERSTELLAR TRAJECTORY. *Voyager 2* performed the historic grand tour by visiting Jupiter (1979), Saturn (1981), URANUS (1986), and NEPTUNE (1989). Both RTG-powered spacecraft are now involved in the Voyager Interstellar Mission (VIM). Each carries a special recording (“Sounds of Earth”)—a digital message for any intelligent

## GLOSSARY

Voyager (Courtesy of NASA)

## Vulcan – watt

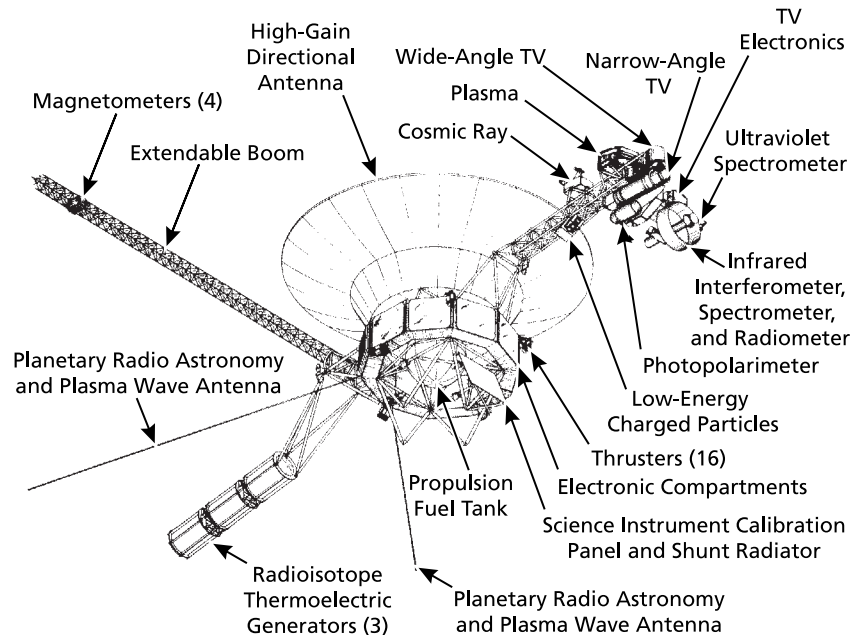

species that finds them drifting between the STARS millennia from now.

**Vulcan** The hypothetical (but nonexistent) planet that some 19th-century astronomers believed existed in an extremely hot orbit between MERCURY and the SUN.

**warhead** The PAYLOAD of a BALLISTIC MISSILE or military ROCKET, usually a nuclear weapon or high explosive.

**water hole** A term used in the SEARCH FOR EXTRATERRESTRIAL INTELLIGENCE (SETI) to describe a narrow portion of the ELECTROMAGNETIC (EM) SPECTRUM that appears especially appropriate for INTERSTELLAR COMMUNICATION AND CONTACT between emerging and advanced civilizations. This BAND lies in the RADIO FREQUENCY (RF) part of the EM spectrum between 1,420 megahertz (MHz) FREQUENCY (21.1 cm WAVELENGTH) and 1,660 megahertz (MHz) frequency (18 cm wavelength).

**watt** (W) The SI UNIT of POWER (that is, WORK per unit time); 1 W represents one JOULE of ENERGY per second.

## GLOSSARY

## Vulcan – watt

## wavelength – weightlessness

**wavelength** ( $\lambda$ ) The mean distance between maxima (or minima) of a periodic pattern; the distance between two crests of a propagating wave of a single FREQUENCY ( $\nu$ ). The wavelength is related to frequency and phase speed ( $c$ ) by the formula  $\lambda = c/\nu$ . (Note, here  $c$  is the speed of propagation of the wave disturbance.)

**wave number** The reciprocal of the WAVELENGTH,  $1/\lambda$ .

**weather satellite** An EARTH-OBSERVING SPACECRAFT that carries a variety of special environmental SENSORS to observe and measure atmospheric properties and processes. Operational weather satellites are in GEOSTATIONARY ORBIT and in POLAR ORBIT—each with a different capability and purpose. Also called METEOROLOGICAL SATELLITE or ENVIRONMENTAL SATELLITE.

**weight** ( $w$ ) The FORCE of attraction with which an object is pulled toward EARTH (or another planetary body) by its GRAVITY. It is the product of the object's MASS ( $m$ ) and the local ACCELERATION OF GRAVITY ( $g$ ).

**weightlessness** The condition of FREE FALL (or ZERO  $G$  in which objects inside an EARTH-orbiting, unaccelerated SPACECRAFT appear weightless even though the objects and the spacecraft are still under the influence of Earth's GRAVITY. It is the condition in which NO ACCELERATION, whether of GRAVITY or other FORCE, can be

## GLOSSARY

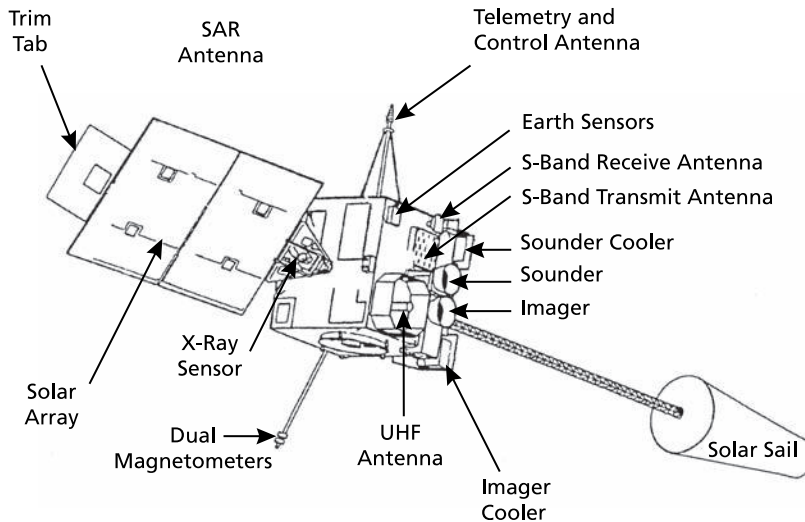
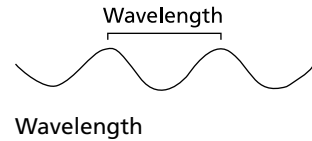

Weather satellite (Courtesy of NASA and NOAA)

## wavelength – weightlessness

## GLOSSARY

detected by an observer within the system in question. *See also* MICROGRAVITY.

**wet emplacement** A LAUNCH PAD that provides a deluge of water for cooling the FLAME BUCKET and other equipment during a ROCKET firing.

**white dwarf** (*star*) A compact STAR at the end of its life cycle. Once a star of one SOLAR MASS or less exhausts its nuclear fuel, it collapses under GRAVITY into a very dense object about the size of EARTH.

**Wilkinson Microwave Anisotropy Probe** (*WMAP*) NASA LAUNCHED this scientific SPACECRAFT on 30 June 2001 from CAPE CANAVERAL. Once in ORBIT, *WMAP* began making sky maps of temperature fluctuations of the COSMIC MICROWAVE BACKGROUND (CMB) with much higher RESOLUTION, sensitivity, and accuracy than its famous predecessor, NASA'S *COSMIC BACKGROUND EXPLORER (COBE)*. *WMAP*'s superior CMB data are playing an important role in contemporary COSMOLOGY.

**WIMP** A hypothetical PARTICLE, called the *weakly interacting massive particle*, thought by some scientists to pervade the UNIVERSE as it is hard to observe DARK MATTER. *See also* MACHO.

**W. M. Keck Observatory** *See* KECK OBSERVATORY.

**work** (*w*) The ENERGY associated with a FORCE acting through a specific distance. The SI UNIT of work is the JOULE.

**X-15** The North American *X-15* ROCKET-powered experimental aircraft helped bridge the gap between human flight within the ATMOSPHERE and human flight in OUTER SPACE. It was developed and flown in the 1960s to provide in-flight information and data on aerodynamics, structures, flight controls, and the physiological aspects of high-speed, high-ALTITUDE flight.

**X-ray** A penetrating form of ELECTROMAGNETIC RADIATION of very short WAVELENGTH (approximately 0.01 to 10 NANOMETERS) and high PHOTON ENERGY (approximately 100 ELECTRON VOLTS to some 100 kiloelectron volts.)

**X-ray astronomy** The branch of ASTRONOMY, primarily space based, that uses characteristic X-RAY emissions to study very energetic and violent processes throughout the UNIVERSE. X-ray emissions carry information about the temperature, DENSITY, age, and other physical conditions of celestial objects that produced them—including SUPERNOVA remnants, PULSARS, ACTIVE GALAXIES, and energetic SOLAR FLARES. *See also* CHANDRA X-RAY OBSERVATORY.

## yaw – zenith

- yaw** The rotation or oscillation of a MISSILE or AEROSPACE VEHICLE about its vertical axis so as to cause the longitudinal axis of the vehicle to deviate from the flight line or heading in its horizontal plane. *See also* PITCH; ROLL.
- year** The period of one REVOLUTION of EARTH around the SUN; but the choice of the celestial reference point determines the precise length of the year. The civil calendar year (based on the GREGORIAN CALENDAR) is 365.2425 days.
- Yerkes Observatory** An astronomical observatory of the University of Chicago located about 330 m above sea level at Williams Bay, Wisconsin. Established in the late 19th century by GEORGE ELLERY HALE, the facility houses the world's largest REFRACTING TELESCOPE (a 102-cm diameter optical device).
- Yohkoh** A Japanese SOLAR X-RAY observation SATELLITE launched in 1991.
- young stellar object (YSO)** Any celestial object in an early stage of STAR formation, from a PROTOSTAR to a MAIN-SEQUENCE STAR.
- Zarya** (Dawn) The Russian-built and American-financed module that was the first-launched of numerous modules that make up the *INTERNATIONAL SPACE STATION (ISS)*—a large, habitable SPACECRAFT being assembled in LOW EARTH ORBIT (LEO). The first assembly step of the *ISS* occurred in late November and early December 1998. During a NASA SPACE SHUTTLE-supported orbital assembly operation, ASTRONAUTS linked Zarya, the initial control module, together with UNITY, the American six-port habitable connection module. Zarya is also known as the *Functional Cargo Block*, or FGM when the Russian equivalent acronym is transliterated.
- Zenit (Zenith)** A LIQUID-PROPELLANT Russian LAUNCH VEHICLE developed within Ukraine in the late 1970s and flight-tested at the BAIKONUR COSMODROME in the 1980s. The two-stage version, called the Zenit 2, can place a PAYLOAD of about 14,000 kg into LOW EARTH ORBIT. Following the COLD WAR, a three-stage commercial version, called the Zenit 3SL, was developed to accommodate payload launches from special platforms at sea. The ZENIT 3SL can place a payload of about 6,000 kg into an optimized geosynchronous TRANSFER ORBIT (GTO). *See also* SECTION IV CHARTS AND TABLES.
- zenith** The point on the CELESTIAL SPHERE vertically overhead. *Compare with* NADIR.

## yaw – zenith

- zero-g** A common (but imprecise) term for the condition of continuous FREE FALL and apparent WEIGHTLESSNESS experienced by ASTRONAUTS and objects in an EARTH-ORBITING SPACECRAFT. *See also* MICROGRAVITY.
- zodiac** From the Greek word meaning “circle of figures.” Early astronomers described the band in the sky about 9° on each side of the ECLIPTIC, which they divided into 30° intervals—each representing a sign of the zodiac. Within their GEOCENTRIC COSMOLOGY, the SUN appeared to enter a different CONSTELLATION of the zodiac each month. So the signs of the zodiac helped them mark the annual REVOLUTION of EARTH around the Sun. *See also* SECTION IV CHARTS & TABLES.
- zodiacal light** A faint cone of LIGHT extending upward from the horizon in the direction of the ECLIPTIC caused by the REFLECTION of sunlight from tiny pieces of INTERPLANETARY DUST in ORBIT around the SUN.
- Zond** A family of Russian SPACECRAFT that explored the MOON, MARS, VENUS, and INTERPLANETARY SPACE in the 1960s.
- “zoo hypothesis”** One response to the FERMI PARADOX. It postulates that intelligent, very technically advanced species do exist in the MILKY WAY GALAXY, but that humans cannot detect or interact with them because they have set this SOLAR SYSTEM aside as a perfect zoo or wildlife preserve.
- zulu time** The U.S. military expression for 24-hour clock time based on GREENWICH MEAN TIME (GMT).
- Zvezda** (“Star”) The Russian service module for the *INTERNATIONAL SPACE STATION (ISS)*. The 20-ton module has three DOCKING HATCHES and 14 windows. Launched by a PROTON ROCKET from the BAIKONUR COSMODROME on 12 July 2000, the module automatically docked with the ZARYA module of the orbiting *ISS* complex on 26 July 2000.

---

SECTION TWO

# BIOGRAPHIES



**Abell, George Ogden** (1927–83) American astronomer who is best known for his investigation and classification of GALACTIC CLUSTERS. Using photographic plates collected at the PALOMAR OBSERVATORY, he characterized more than 2,700 ABELL CLUSTERS of GALAXIES. In 1958, he summarized this work in the book *Abell Catalogue of Clusters of Galaxies*.

**Adams, John Couch** (1819–92) British astronomer who is cocredited with the mathematical discovery of NEPTUNE. From 1843 to 1845, he investigated irregularities in the orbit of URANUS and predicted the existence of a PLANET beyond. However, his work was ignored until the French astronomer URBAIN-JEAN-JOSEPH LEVERRIER made similar calculations that enabled the German astronomer JOHANN GOTTFRIED GALLE to discover Neptune on 23 September 1846. He was a professor of astronomy and also the director of the Cambridge Observatory.

**Adams, Walter Sydney** (1876–1956) American astronomer who specialized in stellar spectroscopic studies and who developed a technique for determining a STAR's real MAGNITUDE from its SPECTRUM. In 1932, his spectroscopic studies of the Venusian ATMOSPHERE showed that it was rich in CARBON DIOXIDE (CO<sub>2</sub>). From 1923 to 1946, he was the director of the Mount Wilson Observatory in California.

**Airy, Sir George Biddell** (1801–92) British astronomer who modernized the ROYAL GREENWICH OBSERVATORY and served as the seventh ASTRONOMER ROYAL (1835–81). Despite many professional accomplishments, he is often remembered for his failure to recognize the value of the theoretical work of JOHN COUCH ADAMS, thereby delaying the discovery of NEPTUNE until 1846.

**Aitken, Robert Grant** (1864–1951) American astronomer who worked at the LICK OBSERVATORY in California and specialized in BINARY (DOUBLE) STAR SYSTEMS. In 1932, he published *New General Catalog of Double Stars*, a seminal work that contains measurements of over 17,000 double stars and is often called the *Aitken Double Star Catalog (ADSC)*.

**Al-Battani (a.k.a. Albategnius)** (858–929) Arab astronomer and mathematician who improved SOLAR, LUNAR, and planetary (five) motion data found in PTOLEMY'S *ALMAGEST* with

more accurate measurements. He also introduced the use of trigonometry in observational ASTRONOMY. In 880, he produced a major STAR catalog and refined the length of the YEAR to approximately 365.24 days. His precise observations influenced the medieval astronomers of western Europe. His full Arab name is Abu-'Abdullah Muhammad Ibn Jabir Ibn Sinan Al-Battani.

**Aldrin, Edwin E. "Buzz," Jr.** (1930– ) American ASTRONAUT and United States Air Force officer (colonel) who served as the lunar module pilot for NASA's *APOLLO 11* mission, which took place 16–24 July 1969. This mission was the first human-landing mission on the MOON. He followed Astronaut NEIL ARMSTRONG onto the LUNAR surface on 20 July 1969, becoming the second person in history to walk on another world.

**Alfonso X of Castile** (1221–84) Scholarly Spanish monarch who ordered the compilation of revised planetary tables based on Arab ASTRONOMY (the *ALMAGEST* of PTOLEMY) but updated with observations made at Toledo, Spain. The *Alfonsine Tables* were completed in 1272 and served medieval astronomers for over three centuries.

**Alfvén, Hannes Olof Gösta** (1908–95) Swedish physicist who developed the theory of magnetohydrodynamics that helped explain SUNSPOT formation and magnetic field-PLASMA interactions (Alfvén waves) taking place in the outer regions of the SUN and other STARS. He shared the 1970 Nobel Prize in physics for this work.

**Alpher, Ralph Asher** (1921–2007) American theoretical physicist who collaborated with GEORGE GAMOW (and other scientists) in 1948 to develop the BIG BANG theory of the origin of the UNIVERSE. He also extended the nuclear transmutation theory (NUCLEOSYNTHESIS) within a very hot, early fireball to predict the existence of a now-cooled, residual, COSMIC MICROWAVE BACKGROUND RADIATION.

**Al-Sufi, Abd al-Rahman** (903–86) Arab astronomer who produced a STAR catalog in about 964 based on PTOLEMY's *ALMAGEST* but that included some of his own observations—including the first reference to the ANDROMEDA GALAXY (reported as a fuzzy NEBULA).



Edwin E. "Buzz" Aldrin, Jr.  
(Courtesy of NASA)

**Alvarez, Luis Walter** (1911–88) American physicist and Nobel laureate who collaborated with his son Walter (1940– ), a geologist, to develop the EXTRATERRESTRIAL CATASTROPHE THEORY (or Alvarez hypothesis) in which a large ASTEROID or COMET struck EARTH some 65 million years ago, causing a mass extinction of life, including the dinosaurs. In 1980, he discovered a worldwide enrichment of iridium in the thin sediment layer between the Cretaceous-Tertiary periods—an unusual elemental abundance attributed to the IMPACT of an EXTRATERRESTRIAL mineral source.

**Al-Wefa, Abu'l** (940–98) Arab mathematician and astronomer who developed spherical trigonometry and worked in the Baghdad Observatory, constructed by Muslim Prince Sharaf al-Dawla. He introduced the use of tangent and cotangent functions in his astronomical activities, which included careful observations of SOLSTICES and EQUINOXES.

**Ambartsumian, Viktor Amazaspovich** (1908–96) Armenian astrophysicist who founded BYURAKAN ASTROPHYSICAL OBSERVATORY in 1946 on Mount Aragatz near Yerevan, Armenia. This facility served as one of the major astronomical observatories in the former Soviet Union. His major contributions involved theories concerning the origin and evolution of STARS.

**Amici, Giovanni Battista** (1786–1863) Italian astronomer and optician who developed better mirrors for REFLECTING TELESCOPES. While serving as astronomer to the grand duke of Tuscany, he used his improved telescopes to make more refined observations of the Jovian MOONS and of selected BINARY (DOUBLE) STAR SYSTEMS.

**Anaxagoras** (ca. 500 B.C.E.–ca. 428 B.C.E.) Greek philosopher and early cosmologist who speculated that the SUN was really a huge, incandescent rock; the planets and stars flaming rocks; and the MOON had materials similar to EARTH, possibly including inhabitants. For these bold hypotheses, he was charged with religious impiety by Athenian authorities and banished from the city. His COSMOLOGY included the concept that “mind” (Greek word *nous*, νοῦς) formed the material objects of the UNIVERSE.

**Anaximander** (ca. 610 B.C.E.–ca. 546 B.C.E.) Greek philosopher and astronomer who was the earliest Hellenistic thinker to propose a systematic worldview. Within his COSMOLOGY, a stationary, cylindrically shaped EARTH floated freely in space at the center of the UNIVERSE. By recognizing that the heavens appeared to revolve around the North Star (Polaris), he used a complete sphere to locate CELESTIAL BODIES (that is, STARS and PLANETS) in the night sky. He also proposed *apeiron* (the Greek word for unlimited or infinite) as the source element for all material objects—a formless, imperceptible substance from which all things originate and back into which all things return.

**Anders, William A.** (1933– ) American ASTRONAUT and United States Air Force officer who was a member of NASA's APOLLO 8 mission (21–27 December 1968), history's first crewed flight to the vicinity of the MOON. Along with FRANK BORMAN and JAMES ARTHUR LOVELL, JR., he flew to the Moon in the Apollo SPACECRAFT, completed 10 orbital REVOLUTIONS of the Moon, and then returned safely to EARTH.

**Ångström, Anders Jonas** (1814–74) Swedish physicist and astronomer who performed pioneering spectral studies of the SUN. In 1862, he discovered that HYDROGEN was present in the Sun's ATMOSPHERE and went on to publish a detailed map of the solar SPECTRUM, covering other elements as well. A special unit of WAVELENGTH, the ANGSTROM (Å), now honors his accomplishments in SPECTROSCOPY.

**Antoniadi, Eugene Michael** (1870–1944) French astronomer who made detailed studies of the PLANETS, especially MARS, in the post-GIOVANNI VIRGINIO SCHIAPARELLI period. He developed a popular viewing index (the Antoniadi scale) that qualitatively describes the suitability of terrestrial atmospheric motion conditions for observing the planets.

**Apollonius of Perga** (ca. 262 B.C.E.–ca. 190 B.C.E.) Greek mathematician who developed the theory of CONIC SECTIONS (including the circle, ELLIPSE, parabola, and hyperbola) that allowed JOHANNES KEPLER and SIR ISAAC NEWTON to describe the motion of CELESTIAL BODIES in the SOLAR SYSTEM accurately. He also created the key mathematical treatment

that enabled HIPPARCHUS OF NICAEA and (later) PTOLEMY to promote a geocentric EPICYCLE theory of planetary motion.

**Arago, Dominique François** (1786–1853) French scientist and statesman who developed instruments to study the POLARIZATION OF LIGHT. He had a special interest in polarized light from COMETS and determined through careful observation that COMET HALLEY (1835 passage) and other comets were not self-luminous. His compendium, *Popular Astronomy*, extended scientific education to a large portion of the European middle class.

**Argelander, Friedrich Wilhelm August** (1799–1875) German astronomer who investigated VARIABLE STARS and compiled a major telescopic (but prephotography) survey of all the STARS in the Northern Hemisphere brighter than the ninth MAGNITUDE. From 1859 to 1862, he published the four-volume *Bonn Survey* (*Bonner Durchmusterung*), containing over 324,000 stars.

**Aristarchus of Samos** (ca. 320 B.C.E.–ca. 250 B.C.E.) Greek mathematician and astronomer who was the first to suggest that EARTH not only revolved on its AXIS but also traveled around the SUN along with the other known PLANETS. Unfortunately, he was severely criticized for his bold hypothesis of a moving Earth. At the time, Greek society favored the teachings of ARISTOTLE and others who advocated a geocentric COSMOLOGY with an immovable Earth at the center of the UNIVERSE. Almost 18 centuries would pass before NICHOLAS COPERNICUS revived HELIOCENTRIC (Sun-centered) cosmology.

**Aristotle** (384 B.C.E.–322 B.C.E.) Greek philosopher who was one of the most influential thinkers in the development of Western civilization. He endorsed and embellished the geocentric (Earth-centered) COSMOLOGY of EUDOXUS OF CNIDUS. In Aristotelian cosmology, a nonmoving EARTH was surrounded by a system of 49 concentric, transparent (crystal) spheres, each helping to account for the motion of all visible CELESTIAL BODIES. The outermost sphere contained the FIXED STARS. PTOLEMY later replaced Aristotle's spheres with a system of EPICYCLES. Modified, but unchallenged, Aristotelian cosmology dominated Western thinking for almost two millennia—until finally surrendering to the HELIOCENTRIC (Sun-centered)

## Armstrong – Baade

cosmology of NICHOLAS COPERNICUS, JOHANNES KEPLER, and GALILEO GALILEI.

**Armstrong, Neil A.** (1930– ) American ASTRONAUT who served as the commander for NASA's *APOLLO II* lunar-landing mission in July 1969. As he became the first human being to set foot on the MOON (20 July 1969), he uttered these historic words, "That's one small step for [a] man, one giant leap for mankind."

**Arp, Halton Christian** (1927– ) American astronomer who published the *Atlas of Peculiar Galaxies* in 1966 and also proposed a controversial theory concerning REDSHIFT phenomena associated with distant QUASARS.

**Arrest, Heinrich Louis d'** (1822–75) German astronomer who worked at the Berlin Observatory in Germany and at the Copenhagen Observatory in Denmark. While working at the Copenhagen Observatory, Arrest discovered numerous celestial objects, including ASTEROIDS, COMETS, and NEBULAS. At the Berlin Observatory, he participated with JOHANN GALLE in the 1846 telescopic search that led to the discovery of NEPTUNE.

**Arrhenius, Svante August** (1859–1927) Swedish physical chemist and Nobel laureate (Chemistry 1903) with multidisciplinary interests who suggested that life could be abundant in the UNIVERSE. In his book *Worlds in the Making* (1908), he introduced the PANSPERMIA hypothesis. This was a bold speculation that life could be spread through outer space from PLANET to planet or even from STAR system to star system by the diffusion of spores, bacteria, or other microorganisms. He was also one of the first scientists (ca. 1895) to associate the presence of heat-trapping gases, such as CARBON DIOXIDE, in a planet's ATMOSPHERE with the GREENHOUSE EFFECT.

**Baade, (Wilhelm Heinrich) Walter** (1893–1960) German-American astronomer who carefully studied CEPHEID VARIABLES, enabling him to double the estimated distance, age, and scale of the UNIVERSE. In 1942, he showed that the ANDROMEDA GALAXY was over 2 million LIGHT-YEARS away—more than twice the previously accepted distance. He also discovered that STARS occupy two basic populations or groups. POPULATION I STARS are younger, bluish stars found in the outer regions

## BIOGRAPHIES



Neil A. Armstrong (Courtesy of NASA)

## Armstrong – Baade

## BIOGRAPHIES

of a GALAXY. POPULATION II STARS are older, reddish stars found in the central regions of a galaxy. This categorization significantly advanced stellar evolution theory.

**Babcock, Harold Delos** (1882–1968) American astronomer and physicist who, along with his son Horace (1912–2003), invented the SOLAR magnetograph in 1951. This instrument allowed them and other solar physicists to make detailed (pre-space age) investigations of the SUN’s magnetic field.

**Baily, Francis** (1774–1844) British astronomer and stockbroker who discovered the beads of LIGHT phenomenon (now called BAILY’S BEADS) that occurs around the LUNAR DISK during a total ECLIPSE of the SUN. He made this discovery on 15 May 1836, and his work stimulated a great deal of interest in eclipses.

**Barnard, Edward Emerson** (1857–1923) American astronomer who discovered JUPITER’S fifth MOON, AMALTHEA, in 1892 and pioneered the use of photography in ASTRONOMY. He was the first to find a COMET by photographic means. He also discovered BARNARD’S STAR, a faint RED DWARF with a large PROPER MOTION, situated about six LIGHT-YEARS from the SUN.

**Bayer, Johann** (1572–1625) German astronomer who published *Uranometria* in 1603—the first major STAR catalog for the entire CELESTIAL SPHERE. He charted over 2,000 stars visible to the NAKED EYE and introduced the practice of assigning Greek letters (such as alpha  $\alpha$ , beta  $\beta$ , and gamma  $\gamma$ ) to the main stars in each CONSTELLATION, usually in an approximate (descending) order of their brightness.

**Bean, Alan L.** (1932– ) American ASTRONAUT and U.S. Navy officer who commanded the LUNAR MODULE, during NASA’S *APOLLO 12* mission. Along with PETE CONRAD, he walked on the LUNAR surface and deployed instruments in November 1969 as part of the second MOON landing mission. He also served as SPACECRAFT commander for the *SKYLAB II* SPACE STATION mission in 1973. These spaceflight experiences inspired his work as a space artist.

**Bell Burnell, (Susan) Jocelyn** (1943– ) British astronomer who, in August 1967, while still a doctoral student at Cambridge University under the supervision of ANTONY HEWISH,

discovered an unusual, repetitive radio signal that proved to be the first PULSAR. She received her Ph.D. for her pioneering work on pulsars, while Hewish and a Cambridge colleague (SIR MARTIN RYLE) eventually shared the 1974 Nobel Prize in physics for their work on pulsars. Possibly because she was a student at the time of her discovery, the Nobel committee rather unjustly ignored her contribution.

**Bernal, John Desmond** (1910–71) Irish physicist and writer who speculated about the colonization of SPACE and the construction of very large, spherical SPACE SETTLEMENTS (now called BERNAL SPHERES) in his futuristic 1929 work *The World, the Flesh and the Devil*.

**Bessel, Friedrich Wilhelm** (1784–1846) German astronomer and mathematician who pioneered precision ASTRONOMY and was the first to measure accurately the distance to a STAR (other than the SUN). In 1818, he published *Fundamenta Astronomiae*, a catalog of over 3,000 stars. By 1833, he completed a detailed study from the Königsberg Observatory of 50,000 stars. His greatest accomplishment occurred in 1838, when he carefully observed the BINARY (DOUBLE) STAR SYSTEM 61 Cygni and used its PARALLAX (annual angular displacement) to estimate its distance at about 10.3 LIGHT-YEARS from the Sun (the current value is 11.3 light-years). His mathematical innovations and rigorous observations greatly expanded the scale of the UNIVERSE and helped shift astronomical interest beyond the SOLAR SYSTEM.

**Bethe, Hans Albrecht** (1906–2005) German-American physicist and Nobel laureate who proposed the mechanisms by which STARS generate their vast quantities of ENERGY through the NUCLEAR FUSION of HYDROGEN into HELIUM. In 1938, he worked out the sequence of nuclear fusion reactions, called the CARBON CYCLE, that dominate energy liberation in stars more massive than the SUN. Then, while working with a Cornell University colleague (Charles Critchfield), he proposed the PROTON-PROTON REACTION as the nuclear fusion process for stars up to the size of the Sun. For this astrophysical work, he received the 1967 Nobel Prize in physics.



**Biela, Wilhelm von** (1782–1856) Austrian military officer and amateur astronomer who rediscovered a SHORT-PERIOD COMET in 1826 and then calculated its orbital PERIOD (about 6.6 years). During the predicted 1846 PERIHELION passage of Biela's comet, its NUCLEUS split into two. Following the 1852 return of Biela's double comet, the object disappeared, apparently disintegrating into an intense METEOR shower. The dynamics and disappearance of Biela's comet demonstrated to astronomers that comets were transitory, finite objects.

**Biermann, Ludwig** (1907–86) German astronomer who theoretically predicted in 1951 the existence of the SOLAR WIND and its influence on the dynamics of ionized COMET tails.

**Biot, Jean-Baptiste** (1774–1862) French physicist who examined specimens of the METEORITE that fell onto L'Aigle, France, in 1803 and concluded that meteorites are of EXTRATERRESTRIAL origin. During a balloon flight in 1804, he investigated how EARTH's magnetic field varied with ALTITUDE.

**Birkeland, Kristian Olaf Bernhard** (1867–1917) Norwegian physicist who, early in the 20th century, deployed instruments during polar region expeditions and then suggested that AURORAS were electromagnetic in nature, created by an interaction of EARTH's MAGNETOSPHERE with a flow of CHARGED PARTICLES from the SUN. In the 1960s, instruments onboard early Earth-orbiting SATELLITES confirmed his hypothesis.

**Bliss, Nathaniel** (1700–64) British astronomer who worked with JAMES BRADLEY at the ROYAL GREENWICH OBSERVATORY and briefly served as the fourth ASTRONOMER ROYAL from 1762 to 1764.

**Bluford, Guion S., Jr.** (1942– ) American ASTRONAUT and U.S. Air Force officer who served as a NASA mission specialist on three SPACE SHUTTLE missions. During the space shuttle STS-8 mission launched from the KENNEDY SPACE CENTER (KSC) on 30 August 1983, he became the first African American to fly in space.

**Bode, Johann Elert** (1747–1826) German astronomer who publicized an empirical formula that approximated the average distance to the SUN of each of the six PLANETS known in 1772. This

formula, often called Bode's law, is only a convenient mathematical relationship and does not describe a physical principle or natural phenomenon. Furthermore, Bode's empirical formula was actually discovered in 1766 by JOHANN DANIEL TITIUS. In 1801, Bode published *Uranographia*, a comprehensive listing of more than 17,000 STARS and NEBULAS.

**Bok, Bartholomeus "Bart" Jan** (1906–83) Dutch-American astronomer who investigated the STAR-forming regions of the MILKY WAY GALAXY in the 1930s and discovered the small, dense, cool (~10 K) DARK NEBULAS, now called Bok globules.

**Boltzmann, Ludwig** (1844–1906) Austrian physicist who developed statistical mechanics and key thermophysical principles that enabled astronomers to interpret a STAR'S SPECTRUM and its LUMINOSITY better. In the 1870s and 1880s, he collaborated with JOSEF STEFAN in discovering an important physical law (now called the STEFAN-BOLTZMANN LAW) that relates the total radiant ENERGY output (luminosity) of a star to the fourth power of its ABSOLUTE TEMPERATURE.

**Bond, George Phillips** (1825–65) American astronomer who succeeded his father (WILLIAM CRANCH BOND) as the director of the HARVARD COLLEGE OBSERVATORY. He specialized in SOLAR SYSTEM observations, including the 1848 codiscovery (with his father) of Hyperion, a MOON of SATURN. In the 1850s, he pursued developments in ASTROPHOTOGRAPHY, demonstrating that STAR photographs could be used to estimate stellar MAGNITUDES.

**Bond, William Cranch** (1789–1859) American astronomer who was the founder and first director of the HARVARD COLLEGE OBSERVATORY. While collaborating with his son (GEORGE PHILLIPS BOND), he codiscovered Hyperion, a MOON of SATURN, in 1848 and pioneered ASTROPHOTOGRAPHY by taking images of JUPITER and the STAR Vega in 1850 and the BINARY (DOUBLE) STAR SYSTEM Mizar in 1857.

**Bondi, Sir Hermann** (1919–2005) Austrian-born British astronomer and mathematician who collaborated with THOMAS GOLD and SIR FRED HOYLE in 1948 to propose a STEADY-STATE model of the UNIVERSE. Although scientists now have generally abandoned this STEADY-STATE UNIVERSE hypothesis in favor

of the BIG BANG theory, his work stimulated a great deal of beneficial technical discussion within the astrophysical community.

**Borman, Frank** (1928– ) American ASTRONAUT and U.S. Air Force officer who commanded NASA's *APOLLO 8* mission (December 1968)—the first mission to take human beings to the vicinity of the MOON. He also served as the commander of NASA's *GEMINI 7* mission in 1965.

**Boscovich, Ruggero Giuseppe** (1711–87) Croatian Jesuit mathematician and astronomer who developed new methods for determining the ORBITS of PLANETS and their AXES of ROTATION. As a creative, multitalented scientist, he was also an influential science adviser to Pope Benedict XIV, a strong advocate for NEWTON'S LAW OF GRAVITATION, and a pioneer of geodesy and modern atomic theory.

**Boss, Benjamin** (1880–1970) American astronomer who, in 1937, published the popular, five-volume *Boss General Catalogue*, a modern listing of over 33,000 STARS. His publication culminated the precise star position work initiated in 1912 by his father, LEWIS BOSS, when the elder Boss published the *Preliminary (Boss) General Catalogue*, containing about 6,200 stars.

**Boss, Lewis** (1846–1912) American astronomer who published the popular *Preliminary (Boss) General Catalogue* in 1912. This work was the initial version of an accurate, modern STAR catalog and contained about 6,200 stars. His son (BENJAMIN BOSS) completed the task by preparing a more extensive edition of the catalog in 1937.

**Bouguer, Pierre** (1698–1758) French physicist who established the field of experimental photometry, the scientific measurement of light. In 1748, he developed the HELIOMETER, an instrument used by astronomers to measure the diameter of the SUN, the PARALLAX of STARS, and the ANGULAR DIAMETER of PLANETS.

**Bowen, Ira Sprague** (1898–1973) American physicist who performed detailed investigations of the LIGHT spectra from NEBULAS, including certain strong green SPECTRAL LINES that were originally attributed by other astronomers to a hypothesized

new ELEMENT they called nebulium. In 1927, his detailed studies revealed that the mysterious green lines were actually special (forbidden) transitions of the ionized gases oxygen and nitrogen. His work supported important advances in the spectroscopic study of the SUN, other STARS, and nebulas.

**Bradley, James** (1693–1762) British astronomer who discovered the ABERRATION OF STARLIGHT in 1728 while attempting to detect stellar PARALLAX. Upon the death of EDMOND HALLEY in 1742, he was appointed as the third ASTRONOMER ROYAL. As a skilled observer, in 1748 he announced his discovery of the nutation (small variation in tilt) of EARTH’S AXIS.

**Brahe, Tycho** (1546–1601) Quarrelsome Danish astronomer who is considered the greatest pretelescope astronomical observer. His precise, NAKED EYE records of planetary motions enabled JOHANNES KEPLER to prove that all the PLANETS move in elliptical ORBITS around the SUN. Brahe discovered a SUPERNOVA in 1572 and reported his detailed observations in *De Nova Stella* (1573). In 1576, Danish King Frederick II provided support for him to build a world-class OBSERVATORY on an island in the Baltic Sea. For two decades, Brahe’s Uraniborg (Castle of the Sky) was the great center for observational ASTRONOMY. In 1599, German Emperor Rudolf II invited him to move to Prague, where he was joined by Kepler. Brahe, a non-Copernican, advocated his own Tychonic system—a GEOCENTRIC model in which all the planets (except EARTH) revolved around the Sun, and the Sun and its entire assemblage revolved around a stationary Earth.

**Brahmagupta** (ca. 598–ca. 660) Indian mathematician and astronomer who wrote the *Brahmaisiddhanta Siddhanta* around 628, introducing algebraic and trigonometric methods for solving astronomical problems. His work, and that of other Indian scientists of the period, greatly influenced later Arab astronomers and mathematicians.

**Braun, Wernher von** (1912–77) German-American ROCKET engineer and SPACE travel advocate who developed the V-2 rocket during World War II for the German Army and then assisted the COLD WAR era U.S. space program in the development of both military rockets and civilian LAUNCH VEHICLES. Inspired by



Wernher Von Braun  
(Courtesy of NASA/Marshall  
Space Flight Center)

HERMANN J. OBERTH'S vision of rockets for INTERPLANETARY travel, von Braun devoted his professional life to the development of ever more powerful LIQUID-PROPELLANT ROCKET ENGINES. In the mid-1950s, a professional friendship with WALT DISNEY allowed von Braun to communicate his dream of space travel to millions of Americans. He fulfilled a significant portion of these dreams by developing the mighty *SATURN V* launch vehicle that successfully sent the first human beings to the MOON during NASA'S APOLLO PROJECT.

**Bredichin, Fyodor (a.k.a. Fedor) Aleksandrovich** (1831–1904)

Russian astronomer who performed pioneering studies concerning the length, composition, and shape (curvature) of the TAILS of COMETS. He also investigated the structure and behavior of METEORS.

**Brezhnev, Leonid I.** (1906–82) Russian political leader who was the First Secretary of the Communist Party of the (former) Soviet Union between 1964 and 1982 and Soviet leader during the country'S COLD WAR era LUNAR exploration program. He was also responsible for the development of the initial Soviet SPACE STATIONS that were constructed and launched in the 1970s.

**Brown, Ernest Williams** (1866–1938) British mathematician and CELESTIAL MECHANICS expert who specialized in LUNAR orbital theory. In 1919, he published improved tables of the MOON'S motion. These superior lunar tables built upon the work of GEORGE WILLIAM HILL and PHILIP HERBERT COWELL and included over 150 years of precision observations made at the ROYAL GREENWICH OBSERVATORY.

**Bruno, Giordano** (1548–1600) Italian philosopher, writer, and former Dominican monk who managed to antagonize authorities throughout western Europe by adamantly supporting such politically unpopular concepts as the HELIOCENTRIC theory of NICHOLAS COPERNICUS, the infinite size of the UNIVERSE, and the existence of intelligent life on other worlds. His self-destructive, belligerent manner eventually brought him before the Roman Inquisition. After an eight-year-long trial, an uncompromising Bruno was convicted of heresy and burned to death at the stake on 17 February 1600.

**Bunsen, Robert Wilhelm** (1811–99) German chemist who collaborated with GUSTAV ROBERT KIRCHHOFF in 1859 to develop SPECTROSCOPY, the process of identifying individual chemical ELEMENTS from the LIGHT each emits or absorbs when heated to incandescence. SPECTRUM analysis, based on Bunsen's work with Kirchhoff, revolutionized ASTRONOMY by allowing scientists to determine the chemical composition of distant CELESTIAL BODIES. He also made other contributions in chemistry, including the development of the popular gas burner that bears his name.

**Burbidge, (Eleanor) Margaret (née Peachey)** (1919– ) British astrophysicist who collaborated in 1957 with her husband (GEOFFREY RONALD BURBIDGE), SIR FRED HOYLE, and WILLIAM ALFRED FOWLER to publish an important scientific paper describing how NUCLEOSYNTHESIS creates the ELEMENTS of higher MASS in the interior of EVOLVED STARS. In 1967, she coauthored a fundamental book on QUASARS with her astrophysicist husband. From 1972 to 1973, she was the first woman to serve as the director of the ROYAL GREENWICH OBSERVATORY.

**Burbidge, Geoffrey Ronald** (1925– ) British astrophysicist who collaborated in 1957 with his astrophysicist wife ([ELEANOR] MARGARET BURBIDGE), SIR FRED HOYLE, and WILLIAM ALFRED FOWLER as they developed the detailed theory explaining how NUCLEOSYNTHESIS creates heavier ELEMENTS in the interior of STARS. In 1967, he coauthored an important book on QUASARS with his wife. From 1978 to 1984, he served as the director of the Kitt Peak National Observatory in Arizona.

**Callippus of Cyzicus** (ca. 370 B.C.E.–ca. 300 B.C.E.) Greek astronomer and mathematician who modified the GEOCENTRIC system of COSMIC spheres developed by his teacher, EUDOXUS OF CNIDUS. Callippus was a skilled observer and proposed that a stationary EARTH was surrounded by 34 rotating spheres upon which all CELESTIAL BODIES moved. ARISTOTLE liked this geocentric COSMOLOGY but proposed a system of 49 solid crystalline (transparent) spheres, whereas the heavenly spheres of Callippus and Eudoxus were assumed geometric but not material in nature.

**Campbell, William Wallace** (1862–1938) American astronomer who made pioneering measurements of the radial (LINE-OF-SIGHT) VELOCITIES of STARS by measuring the DOPPLER SHIFT of their SPECTRAL LINES. In other words, a star's SPECTRUM is BLUESHIFTED when it is approaching EARTH and REDSHIFTED when it is receding. In 1913, he published *Stellar Motions* and also prepared a major catalog that listed the radial velocities of over 900 stars (later expanded to 3,000). He measured the subtle deflection of a LIGHT beam from a star as it just grazed the SUN's surface during a 1922 SOLAR ECLIPSE. His work confirmed ALBERT EINSTEIN's theory of GENERAL RELATIVITY and the previous measurements made by SIR ARTHUR STANLEY EDDINGTON.

**Cannon, Annie Jump** (1863–1941) American astronomer who worked at the HARVARD COLLEGE OBSERVATORY under EDWARD CHARLES PICKERING and was instrumental in developing a widely used system for classifying stellar spectra. She designed the HARVARD CLASSIFICATION SYSTEM by arranging STARS into categories according to their temperatures (for example, type O stars are the hottest). Her efforts culminated in the publication of the *Henry Draper Catalogue*, a nine-volume work (completed in 1924) that contained the SPECTRAL CLASSIFICATION of 225,300 stars.

**Carpenter, Scott** (1925– ) American ASTRONAUT and U.S. Navy officer who flew the second American crewed orbital spaceflight on 24 May 1962. His *Aurora 7* SPACE CAPSULE made three REVOLUTIONS of EARTH as part of NASA's MERCURY PROJECT.

**Carrington, Richard Christopher** (1826–75) British astronomer who made important studies of the ROTATION of the SUN by carefully observing the number and positions of SUNSPOTS. Between 1853 and 1861, he discovered that sunspots at the SOLAR EQUATOR rotated in about 25 days, while those at 45° solar latitude rotated in about 27.5 days. In 1859 (without special viewing equipment), he reported the first visual observation of a SOLAR FLARE—although he thought the phenomenon he had just witnessed was the result of a large METEOR falling into the Sun.

**Cassegrain, Guillaume** (ca. 1629–93) The Frenchman who, in 1672, invented a special REFLECTING TELESCOPE configuration, now called the CASSEGRAIN TELESCOPE, that has become the most widely used reflecting telescope in ASTRONOMY. Unfortunately, except for this important fact, very little else is known about this man who is rumored to have been possibly a priest, a teacher, an instrument maker, or a physician.

**Cassini, César-François (a.k.a. Cesare Francesco Cassini)** (1714–84) French astronomer who was grandson of GIOVANNI DOMENICO CASSINI and who succeeded his father, JACQUES CASSINI, as director of the PARIS OBSERVATORY. He started the development of the first topographical map of France—a task completed by his son, JACQUES DOMINIQUE CASSINI. In 1761, he traveled to Vienna, Austria, to observe a TRANSIT of VENUS across the SUN's disk.

**Cassini, Giovanni Domenico (a.k.a. Jean-Dominique Cassini)** (1625–1712) Italian-French astronomer who was invited in 1669 by King Louis XIV of France to establish and direct the PARIS OBSERVATORY. As an accomplished astronomical observer, he studied MARS, JUPITER, and SATURN. In 1672, he determined the PARALLAX of Mars by using observations he made in Paris and those made by JEAN RICHER in Cayenne, French Guiana. The simultaneous measurements of Mars allowed Cassini to make the first credible determination of distances in the SOLAR SYSTEM, including the EARTH-SUN distance, which he estimated as 140 million km (87 million mi.). In 1675, he discovered a distinctive division or gap in the rings of Saturn, a feature now called the Cassini Division. By using improved telescopes, between 1671 and 1684 he discovered four new MOONS of Saturn: Iapetus (1671), Rhea (1672), Dione (1684), and Tethys (1684).

**Cassini, Jacques (a.k.a. Giacomo Cassini)** (1677–1756) French astronomer who was the son of GIOVANNI DOMENICO CASSINI and continued his father's work as director of the PARIS OBSERVATORY. By carefully observing Arcturus in 1738, he became one of the first astronomers to determine the PROPER MOTION of a STAR accurately.

**Cassini, Jacques-Dominique** (1748–1845) French astronomer who was the great-grandson of GIOVANNI DOMENICO CASSINI



and who succeeded his father, CÉSAR-FRANÇOIS CASSINI, as director of the PARIS OBSERVATORY. He published *Voyage to California*, a discussion of an expedition to observe the 1769 TRANSIT of VENUS across the SUN's disk. He also completed the topographical map of France started by his father.

**Celsius, Anders** (1701–44) Swedish astronomer who published a detailed account of the aurora borealis (northern lights) in 1733 and was the first scientist to associate the AURORA with the EARTH's magnetic field. In 1742, he introduced a temperature scale (the CELSIUS TEMPERATURE SCALE) that is still widely used today. He initially selected 100° on this scale as the freezing point of water and 0° as the boiling point of water. However, after his death, other scientists soon reversed the order of these reference point temperatures.

**Cernan, Eugene A.** (1934– ) American ASTRONAUT and U.S. Navy officer who was the LUNAR MODULE pilot on NASA's APOLLO 10 mission (16–26 May 1969) that circumnavigated the MOON and then the SPACECRAFT commander for the *Apollo 17* lunar landing mission (6–19 December 1972). He was the last human being to walk on the lunar surface in the 20th century.

**Chaffee, Roger B.** (1935–67) American ASTRONAUT and U.S. Navy officer who was assigned to the crew of the first NASA APOLLO PROJECT flight (called *Apollo 1*). Unfortunately, he and his crewmates (VIRGIL “GUS” I. GRISSOM and EDWARD H. WHITE II), died on 27 January 1967 in a tragic LAUNCH PAD accident in CAPE CANAVERAL when an oxygen-fed flash fire swept through the interior of their Apollo SPACE CAPSULE as they were performing a full-scale launch simulation test.

**Chandler, Seth Carlo** (1846–1913) American astronomer who discovered irregular movements of EARTH's geographical poles (called the Chandler wobble) and the 14-month oscillation of Earth's polar AXIS (called the Chandler period).

**Chandrasekhar, Subrahmanyan (a.k.a. Chandra)** (1910–95) Indian-American astrophysicist who made important contributions to the theory of stellar evolution—especially the role of WHITE DWARF stars as the last stage of evolution of many stars that are about the MASS of the SUN. He shared the 1983 Nobel Prize in physics with WILLIAM ALFRED FOWLER for his

theoretical studies of the physical processes important to the structure and evolution of stars. In July 1999, NASA successfully launched the *Advanced X-ray Astrophysics Facility* that was renamed the *CHANDRA X-RAY OBSERVATORY (CXO)* in his honor.

**Chladni, Ernst Florens Friedrich** (1756–1827) German physicist who suggested in 1794 that METEORITES were of EXTRATERRESTRIAL origin, possibly the debris from a PLANET that exploded in ancient times. In 1819, he also postulated that a physical relationship might exist between METEORS and COMETS.

**Christie, William Henry Mahoney** (1845–1922) British astronomer who served as the eighth ASTRONOMER ROYAL from 1881 to 1910. Under his leadership as Astronomer Royal, the role of the ROYAL GREENWICH OBSERVATORY grew in both precision astronomical measurements and as a leading institution for research. He acquired improved, new TELESCOPES for the facility and expanded its activities to include SPECTROSCOPY and ASTROPHOTOGRAPHY.

**Clairaut, Alexis-Claude (a.k.a. Alexis-Claude de Clairaut)** (1713–65) French mathematician and astronomer who accurately calculated the PERIHELION date for the 1759 return of COMET HALLEY. In a brilliant application of SIR ISAAC NEWTON's physical principles, Clairaut compensated for the gravitational influence of both SATURN and JUPITER on the COMET's TRAJECTORY. His detailed calculations predicted a perihelion date of 13 April 1759, while the observed perihelion date for this famous comet was 14 March 1759. Prior to this activity, he participated in an expedition to Lapland (northern Scandinavia) to collect geophysical evidence of the OBLATENESS (flattened poles) of a rotating EARTH.

**Clark, Alvan** (1804–87) American optician and TELESCOPE maker who founded the famous 19th-century telescope-manufacturing company Alvan Clark & Sons in Cambridge, Massachusetts. While testing an 18 in (0.46 m) diameter OBJECTIVE (lens) REFRACTING TELESCOPE in 1862, his son (ALVAN GRAHAM CLARK) pointed the new instrument at the bright STAR Sirius and detected its faint companion Sirius B, a WHITE DWARF. In 1877, ASAPH HALL used the 26 in (0.66 m) Clark-built refracting telescope at the U.S. NAVAL OBSERVATORY to discover the two tiny MOONS of MARS, PHOBOS and DEIMOS.

**Clark, Alvan Graham** (1832–97) American optician and TELESCOPE maker who, while testing a new 18 in (0.46 m) OBJECTIVE (lens) REFRACTING TELESCOPE in 1862 for his father (ALVAN CLARK), pointed the instrument at the bright STAR Sirius and discovered its WHITE DWARF companion, Sirius B. In 1844, FRIEDRICH WILHELM BESSEL had examined the irregular motion of Sirius and hypothesized that the star must have a dark (unseen) companion. The younger Clark's discovery earned him an award from the French Academy of Science and represented the first example of the important small dense object that is the end product of stellar evolution for all but the most massive stars.

**Clarke, Sir Arthur C.** (1917–2008) British science writer and science-fiction author who was widely known for his enthusiastic support of space exploration. In 1945, he published the technical article “Extra Terrestrial Relays” in which he predicted the development of COMMUNICATIONS SATELLITES that operated in GEOSYNCHRONOUS ORBIT. In 1968, he worked with film director Stanley Kubrick in developing the movie version of his book *2001: A Space Odyssey*. This motion picture is still one of the most popular and realistic depictions of human spaceflight across vast interplanetary distances. He was knighted by Queen Elizabeth II of Great Britain in 1998.

**Clausius, Rudolf Julius Emmanuel** (1822–88) German theoretical physicist who developed the first comprehensive understanding of the second law of thermodynamics in 1865 by introducing the concept of ENTROPY. His work had a major impact on 19th-century COSMOLOGY. He assumed that the total ENERGY of the UNIVERSE (considered a closed system) was constant, so the entropy of the universe must then strive to achieve a maximum value in accordance with the laws of thermodynamics. The end state of the universe in this model is one of complete temperature equilibrium, with no energy available to perform any useful work. This condition is called the HEAT DEATH OF THE UNIVERSE.

**Clavius, Christopher** (1537–1612) The German Jesuit mathematician and astronomer who reformed the JULIAN CALENDAR and enabled Pope Gregory XIII to introduce the GREGORIAN

CALENDAR in 1582. This calendar is widely used throughout the world as the international civil calendar.

**Collins, Eileen Marie** (1956– ) The American ASTRONAUT and U.S. Air Force officer who was the first woman to serve in the position of commander of a NASA SPACE SHUTTLE mission. In July 1999, she commanded the STS-93 mission, which successfully deployed the *CHANDRA X-RAY OBSERVATORY*. Prior to that highly successful flight, she served (in February 1995) as the first woman pilot during a space shuttle mission. This milestone in human spaceflight occurred during the STS-63 mission, the initial RENDEZVOUS mission of the American space shuttle with the Russian *MIR* SPACE STATION. In July 2005, she commanded the *Discovery* on the crucial STS-114 Return to Flight mission.



Eileen Marie Collins (Courtesy of NASA)

**Collins, Michael** (1930– ) American ASTRONAUT and U.S. Air Force officer who served as the command module pilot on NASA's historic *Apollo 11* mission to the MOON in July 1969. He remained in lunar ORBIT while APOLLO PROJECT astronauts NEIL A. ARMSTRONG and EDWIN E. "BUZZ" ALDRIN, JR., became the first human beings to walk on the Moon's surface. In April 1971, he joined the Smithsonian Institution as director of the National Air and Space Museum, where he remained for seven years.

**Common, Andrew Ainslie** (1841–1903) British TELESCOPE maker who pursued improvements in ASTROPHOTOGRAPHY in the 1880s and 1890s and is credited with recording the first detailed photographic image of the ORION NEBULA.

**Compton, Arthur Holly** (1892–1962) American physicist who shared the 1927 Nobel Prize in physics for his pioneering work on the scattering of high-energy PHOTONS by ELECTRONS. This phenomenon, called COMPTON SCATTERING or the Compton effect, is the foundation of many GAMMA RAY detection techniques used in high-energy ASTROPHYSICS. In his honor, NASA named the large astrophysics OBSERVATORY launched in April 1991 the *COMPTON GAMMA RAY OBSERVATORY* (*CGRO*).

**Condon, Edward Uhler** (1902–74) American theoretical physicist who served as the director of an investigation sponsored by

the U.S. Air Force (USAF) concerning unidentified flying object (UFO) sighting reports. These reports were accumulated between 1948 and 1966 under USAF Project Blue Book (and its predecessors). Condon's team at the University of Colorado investigated various cases and then wrote the report *Scientific Study of Unidentified Flying Objects*. This document, sometimes called the *Condon Report*, helped the secretary of the Air Force decide to terminate Project Blue Book in 1969, citing that there was no evidence to indicate that any of the sightings categorized as unidentified were EXTRATERRESTRIAL in origin or posed a threat to national security.

**Congreve, Sir William (1772–1828)** British colonel of artillery who examined black-powder (gunpowder) ROCKETS captured during battles in India and then supervised the development of a series of improved British military rockets. In 1804, he wrote *A Concise Account of the Origin and Progress of the Rocket System*. British forces used Congreve's rockets quite effectively in large-scale bombardments during the Napoleonic Wars and the War of 1812. His pioneering work on these early SOLID-PROPELLANT ROCKETS represents an important technical step in the overall evolution of the modern military rocket.

**Conrad, Charles "Pete," Jr. (1930–99)** American ASTRONAUT and U.S. Navy officer who served as the SPACECRAFT commander during NASA's APOLLO 12 LUNAR-landing mission (14–24 November 1969). He was the third human being to walk on the surface of the MOON. As a prelude to his Moon walk, he flew into space during the GEMINI PROJECT in 1965 (*Gemini-Titan V* mission) and in 1966 (*Gemini-Titan XI*). He served as the commander of NASA's SKYLAB SL-2 mission (25 May to 22 June 1973), making mission-saving repairs on the first American SPACE STATION.

**Cooper, Leroy Gordon, Jr. (1927–2004)** American ASTRONAUT and U.S. Air Force officer who was selected as one of the seven original Mercury astronauts and who flew NASA's last MERCURY PROJECT mission, *Faith-7 (Mercury-Atlas 9)* on 15–16 May 1963. During that mission, he became the first human to perform a pilot-controlled REENTRY of a SPACE CAPSULE. In 1965, he also flew into space as part of NASA's GEMINI PROJECT in 1965 (*Gemini-Titan V* mission).

## Copernicus – Cunningham

## BIOGRAPHIES

**Copernicus, Nicholas (a.k.a. Nicolaus)** (1473–1543) Polish astronomer and church official who triggered the scientific revolution of the 17th century with his book *On the Revolution of Celestial Spheres*. When published in 1543 while he lay on his deathbed, this book overthrew the PTOLEMAIC SYSTEM by boldly suggesting a HELIOCENTRIC model for the SOLAR SYSTEM in which EARTH and all the other PLANETS moved around the SUN. His heliocentric model (possibly derived from the long-forgotten ideas of ARISTARCHUS OF SAMOS) caused much technical, political, and social upheaval before finally displacing two millennia of Greek GEOCENTRIC COSMOLOGY.



Nicholas Copernicus commemorated by a Vatican City stamp (the author)

**Cowell, Philip Herbert** (1870–1949) British scientist who specialized in CELESTIAL MECHANICS and who cooperated with ANDREW CLAUDE CROMMELIN in calculating the precise time of the 1910 appearance of COMET HALLEY.

**Crippen, Robert L.** (1937– ) American ASTRONAUT and U.S. Navy officer who served as pilot and accompanied astronaut JOHN W. YOUNG (the SPACECRAFT commander) on the inaugural flight of NASA'S SPACE SHUTTLE. This first (called STS-1) took place from 12–14 April 1981 and used orbiter vehicle (OV) 102, the *Columbia*. He also served as spacecraft commander on three other space shuttle missions: STS-7 (18–24 June 1983), STS 41-C (6–13 April 1984), and STS 41-G (5–13 October 1984).

**Crommelin, Andrew Claude** (1865–1939) French-Irish astronomer who specialized in calculating the ORBITS of COMETS. He collaborated with PHILIP HERBERT COWELL in computing and predicting the precise date of the 1910 return of COMET HALLEY. Based on this success, he then calculated the dates of previous appearances of this famous comet down through history back to the third century B.C.E.

**Cunningham, R. Walter** (1932– ) American ASTRONAUT and U.S. Marine Corps officer who served as the LUNAR MODULE pilot during NASA'S *Apollo 7* mission (11–22 October 1968). Although confined to ORBIT around EARTH, this important mission was the first human-crewed flight of APOLLO PROJECT SPACECRAFT hardware. Its success paved the way for the first lunar landing on 20 July 1969 by the *Apollo 11* astronauts.

## Copernicus – Cunningham

## BIOGRAPHIES

**Curtis, Heber Doust** (1872–1942) American astronomer who proposed in 1920 that spiral NEBULAS were actually ISLAND UNIVERSES—that is, other SPIRAL GALAXIES that existed beyond humans' home galaxy, the MILKY WAY GALAXY. In 1924, EDWIN POWELL HUBBLE confirmed Curtis's hypothesis by showing that the ANDROMEDA GALAXY (a spiral nebula) was another large galaxy well beyond the Milky Way.

**Danjon, André** (1890–1967) French astronomer who was noted for the development of precise astronomical instruments (such as the Danjon prismatic ASTROLABE); the calculation of accurate ALBEDOS of the MOON, VENUS, and MERCURY; and studies of EARTH'S ROTATION.

**Darwin, Sir George Howard** (1845–1912) British mathematical astronomer (second son of the famous naturalist) who investigated the influence of tidal phenomena on the dynamics of the EARTH-MOON system. In 1879, he proposed that the Moon was formed from material thrown from Earth's CRUST when Earth was a newly formed, fast rotating, young PLANET. His tidal theory of LUNAR formation remained plausible until the 1960s, when general scientific support shifted to the GIANT-IMPACT MODEL of lunar formation.

**Dawes, William Rutter** (1799–1868) British amateur astronomer and physician who made precision measurements of BINARY (DOUBLE) STAR SYSTEMS and who independently discovered the major inner C or crêpe RING of SATURN in 1850. This ring is often called the crêpe ring because of its light and delicate appearance.

**De La Rue, Warren** (1815–89) British astronomer and physicist who developed the PHOTOHELIOGRAPH in 1858, enabling routine photography of the SUN's outer surface.

**De Laval, Carl Gustaf Patrik** (1845–1913) Swedish engineer and inventor who developed the CONVERGING-DIVERGING (CD) NOZZLE that he applied to steam turbines. The DE LAVAL NOZZLE has also become an integral part of most modern ROCKET engines.

**Delporte, Eugène-Joseph** (1882–1955) Belgian astronomer who, in 1932, discovered the 1 km diameter Amor ASTEROID

that now gives its name to an entire group of NEAR-EARTH ASTEROIDS that cross the ORBIT of MARS but not EARTH's orbit around the SUN.

**Denning, William Frederick** (1848–1931) British amateur astronomer who focused his efforts on the study of METEORS.

**DeSitter, Willem** (1872–1934) Dutch astronomer, cosmologist, and mathematician who explored the consequences of ALBERT EINSTEIN'S GENERAL RELATIVITY theory and then proposed in 1917 an expanding-UNIVERSE model. While the specific physical details of his model proved unrealistic, his basic hypothesis served as an important stimulus to other scientists. For example, EDWIN POWELL HUBBLE'S observations in the early 1920s proved the universe was indeed expanding.

**DeVaucouleurs, Gérard Henri** (1918–95) French-American astronomer who performed detailed studies of distant GALAXIES and the MAGELLANIC CLOUDS.

**Dewar, Sir James** (1842–1923) Scottish physicist and chemist who specialized in the study of low-temperature phenomena and invented a special double-walled vacuum flask that now carries his name. In 1892, he started using the DEWAR FLASK to store liquified gases at very low (cryogenic) temperatures. In 1898, he successfully produced liquified HYDROGEN.

**Dicke, Robert Henry** (1916–97) American physicist who, in 1964, revived the hypothesis that the BIG BANG event that began the UNIVERSE should have a detectable MICROWAVE RADIATION remnant. However, before he could make his own experimental observations, two other scientists (ARNO ALLEN PENZIAS and ROBERT WOODROW WILSON) detected this COSMIC MICROWAVE BACKGROUND and provided direct experimental evidence of Dicke's hypothesis.

**Dirac, Paul Adrien Maurice** (1902–84) British theoretical physicist who made major contributions to QUANTUM MECHANICS and shared the 1933 Nobel Prize in physics. With his theory of PAIR PRODUCTION, he postulated the existence of the POSITRON. In 1938, he proposed a link between the HUBBLE CONSTANT (a physical measure that describes the size and age of the UNIVERSE) and the fundamental physical constants of



## BIOGRAPHIES



Walt Disney (left) and Wernher von Braun (right) (NASA)

## Disney – Douglass

subatomic PARTICLES. This hypothesis formed the basis of DIRAC COSMOLOGY.

**Disney, Walter Elias “Walt”** (1901–66) American entertainment visionary who popularized the concept of spaceflight in the early 1950s, especially through a widely acclaimed, three-part television series. Because of Disney’s commitment to excellence, space visionaries like WERNHER VON BRAUN inspired millions of Americans with credible images of space exploration in *Man in Space* (1955), *Man and the MOON* (1955), and finally *MARS and Beyond* (1957). The last episode premiered on 8 December 1957—barely two months after the former Soviet Union launched *SPUTNIK 1*.

**Dolland, John** (1706–61) British optician who invented a practical HELIOMETER in the early 1750s and then developed a composite LENS from two types of glass for an achromatic TELESCOPE in 1758. An achromatic telescope (or lens) is one that corrects for CHROMATIC ABERRATION.

**Donati, Giovanni Battista** (1826–73) Italian astronomer who specialized in discovering COMETS (for example, Comet Donati in 1858) and then became the first scientist to observe the SPECTRUM of a comet (Comet Tempel in 1864).

**Doppler, Christian Johann** (1803–53) Austrian physicist who published a paper in 1842 that mathematically described the interesting phenomenon of how sound from a moving source changes pitch as the source approaches (FREQUENCY increases) and then goes away from (frequency decreases) an observer. This phenomenon, now called the DOPPLER SHIFT, or the Doppler effect, is widely used by astronomers to tell whether a distant celestial object is coming toward EARTH (BLUESHIFT) or going away (receding) from Earth (REDSHIFT).

**Douglass, Andrew Ellicott** (1867–1962) American astronomer and environmental scientist who proposed a relationship between SUNSPOT activity and EARTH’S climate. He supported this hypothesis by examining tree ring patterns and then developed the field of dendrochronology (tree dating), which relates the rate of tree ring development with weather effects and, ultimately, SOLAR ACTIVITY. He was director of the Steward Observatory at the University of Arizona from 1918 to 1938.

## BIOGRAPHIES

## Disney – Douglass

**Drake, Frank Donald** (1930– ) American astronomer who, while working at the NATIONAL RADIO ASTRONOMY OBSERVATORY (NRAO) in Green Bank, West Virginia, conducted the first organized attempt to detect RADIO WAVE signals from an alien intelligent civilization across INTERSTELLAR distances. This initial SEARCH FOR EXTRATERRESTRIAL INTELLIGENCE (SETI) was performed under PROJECT OZMA. It led to the formulation of a speculative, semiEMPIRICAL mathematical expression (the DRAKE EQUATION) that tries to estimate the number of intelligent alien civilizations that might now be capable of communicating with each other in this GALAXY.

**Draper, Charles Stark** (1901–87) American physicist and instrumentation expert who used the principle of the GYRO to develop inertial GUIDANCE SYSTEMS for BALLISTIC MISSILES, SATELLITES, and the SPACECRAFT used in NASA'S APOLLO PROJECT.

**Draper, Henry** (1837–82) American physician and amateur astronomer who pioneered key areas of ASTROPHOTOGRAPHY. He was the first astronomer to photograph the SPECTRUM of a STAR (Vega) in 1872 and then the first to photograph successfully a NEBULA (the ORION NEBULA) in 1880. His widow financed publication of the famous *Henry Draper Catalogue*.

**Draper, John William** (1811–82) American scientist who, like his son HENRY DRAPER, made pioneering contributions to the field of ASTROPHOTOGRAPHY. He was the first person to photograph the MOON (1840) and then became the first to make a spectral photograph of the SUN (1844).

**Dreyer, Johan Ludvig Emil (a.k.a. John Lewis Emil Dreyer)** (1852–1926) Danish astronomer who compiled an extensive catalog of NEBULAS and STAR CLUSTERS, which was first published in 1888.

**Duke, Charles Moss, Jr.** (1935– ) American ASTRONAUT and U.S. Air Force officer who served as the LUNAR MODULE pilot on NASA'S APOLLO 16 mission in April 1972. Along with fellow astronaut JOHN W. YOUNG, he explored the rugged LUNAR HIGHLANDS in the Descartes region during the fifth MOON-landing mission.

**Dyson, Sir Frank Watson** (1868–1939) British astronomer who participated with SIR ARTHUR STANLEY EDDINGTON on the 1919 ECLIPSE expedition that observed the bending of a STAR'S LIGHT by the SUN'S GRAVITATION—providing the first experimental evidence to support ALBERT EINSTEIN'S theory of GENERAL RELATIVITY. He also served as England's ASTRONOMER ROYAL from 1910–33.

**Dyson, Freeman John** (1923– ) British-American theoretical physicist who participated in Project Orion, a nuclear FISSION, pulsed-ROCKET concept studied by the U.S. government in the early 1960s as a means of achieving rapid INTERPLANETARY space travel.

**Eddington, Sir Arthur Stanley** (1882–1944) British astronomer, mathematician, and physicist who helped create modern ASTROPHYSICS. In May 1919, he led a solar ECLIPSE expedition to Principe Island (West Africa) to measure the gravitational deflection of a beam of starlight as it passed close to the SUN—thereby providing support for ALBERT EINSTEIN'S GENERAL RELATIVITY theory. In his 1933 publication *The Expanding Universe*, he popularized the notion that the outer GALAXIES (spiral nebulas) were receding from one another as the UNIVERSE expanded.

**Ehricke, Krafft A.** (1917–84) The German-American ROCKET engineer who designed advanced propulsion systems for the American space program, including the CENTAUR UPPER-STAGE vehicle. As a technical visionary, he also expounded upon the positive consequences of space technology for the human race.

**Einstein, Albert** (1879–1955) German-Swiss-American physicist whose revolutionary theory of RELATIVITY (special relativity in 1905 and then GENERAL RELATIVITY in 1915) shaped modern physics. Like GALILEO GALILEI and SIR ISAAC NEWTON before him, Einstein changed forever people's view of the UNIVERSE and how it functions. He was awarded the 1921 Nobel Prize in physics and escaped to the United States when Hitler rose to power in Germany in 1933. While fearing nuclear weapon developments by Nazis in Germany, in 1939 he encouraged President Franklin D. Roosevelt to start the American nuclear weapons program later known as the Manhattan Project.

**Eisele, Donn F.** (1930–87) American ASTRONAUT and U.S. Air Force officer who flew onboard the *Apollo 7* mission in October 1968—the pioneering voyage in ORBIT around EARTH of NASA’s APOLLO PROJECT that ultimately landed human beings on the MOON between 1969 and 1972.

**Eisenhower, Dwight D.** (1890–1969) American army general and 34th president of the United States who was deeply interested in the use of space technology for national security and directed that INTERCONTINENTAL BALLISTIC MISSILES (ICBMs) and RECONNAISSANCE SATELLITES be developed on the highest national priority basis.

**Encke, Johann Franz** (1791–1865) German astronomer and mathematician who, in 1819, established the common identity of the COMET (now called Comet Encke) with the shortest known PERIOD (3.3 years). Its discovery by JEAN PONS in 1818 prompted Encke to perform calculations that proved that the comet was previously observed by other astronomers, including CAROLINE HERSCHEL.

**Eratosthenes of Cyrene** (ca. 276 B.C.E.–ca. 194 B.C.E.) Greek astronomer, mathematician, and geographer who made a remarkable attempt at measuring the circumference of EARTH in about 250 B.C.E. After recognizing that Earth curved, he used the difference in latitude between Alexandria and Aswan, Egypt (about 800 km apart), and the corresponding angle of the SUN at ZENITH at both locations during the summer SOLSTICE. Some historic interpretations of the *stadia* (an ancient unit) suggest his results were about 47,000 km or less versus the true value of 40,000 km.

**Eudoxus of Cnidus** (ca. 400 B.C.E.–ca. 347 B.C.E.) Early Greek astronomer and mathematician who first suggested a GEOCENTRIC COSMOLOGY in which the SUN, MOON, PLANETS, and FIXED STARS moved around EARTH on a series of 27 giant, geocentric spheres. CALLIPPUS OF CYZICUS, ARISTOTLE, and then PTOLEMY embraced geocentric cosmology though each offered modifications to Eudoxus’s model.

**Euler, Leonhard** (1707–83) Swiss mathematician and physicist who developed advanced mathematical methods for observational

## BIOGRAPHIES

### Evans – Flamsteed

ASTRONOMY that supported precise predictions of the motions of the MOON and the PLANETS.

**Evans, Ronald E.** (1933–90) American ASTRONAUT and U.S. Navy officer who served as the command module pilot during NASA's *APOLLO 17* mission (December 1972). He maintained a solo vigil in ORBIT around the MOON, while fellow astronauts EUGENE A. CERNAN and HARRISON H. SCHMITT completed their explorations of the Taurus-Littrow landing area on the lunar surface.

**Fabricius, David** (1564–1617) German astronomer and clergyman who was a skilled NAKED EYE observer, corresponded with JOHANNES KEPLER, and discovered the first VARIABLE STAR (Mira) in 1596. His son JOHANNES FABRICIUS was a student in the Netherlands and, in 1611, introduced his father to the recently invented TELESCOPE. Soon father and son followed GALILEO GALILEI by making their own telescopic observations of the heavens. Unfortunately, the son's death at age 29 and the father's murder brought their early contributions to the era of telescope-based ASTRONOMY to a sudden halt. *See also* HANS LIPPERSHEY.

**Fabricius, Johannes** (1587–1616) German astronomer and son of DAVID FABRICIUS whose early telescopic observations of the heavens with his father discovered SUNSPOTS in 1611. He investigated the number and dynamic behavior of sunspots, writing an early paper on the subject. However, his work is generally overshadowed by GALILEO GALILEI and CHRISTOPH SCHEINER, who independently performed sunspot studies at about the same time.

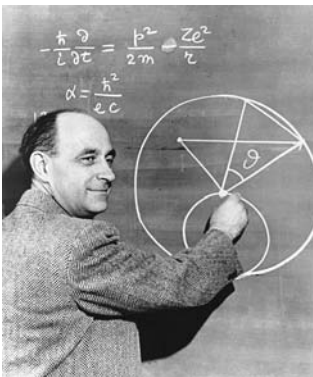

Enrico Fermi (DOE/ANL)

**Fermi, Enrico** (1901–54) Italian-American physicist who helped create the nuclear age and won the 1938 Nobel Prize in physics. In addition to making numerous contributions to nuclear physics, he is also credited with the famous FERMİ PARADOX: WHERE ARE THEY?—a popular speculative inquiry concerning the diffusion of an advanced alien civilization through the GALAXY on a wave of exploration.

**Flamsteed, John** (1646–1719) British astronomer who used both the TELESCOPE and the clock to assemble a precise STAR catalog. In 1675, the English king, Charles II, established the ROYAL

## BIOGRAPHIES

### Evans – Flamsteed

GREENWICH OBSERVATORY and appointed Flamsteed as its director and the first ASTRONOMER ROYAL. However, he had to run this important OBSERVATORY without any significant financial assistance from the Crown. Nevertheless, he constructed instruments and collected precise astronomical data. In 1712, an impatient SIR ISAAC NEWTON secured a royal command to force publication of the first volume of this data collection without the author's consent. This infuriated Flamsteed, who purchased and burned about 300 copies of the unauthorized book. An extensive three-volume set of Flamsteed's star data was published in 1725 after his death.

**Fleming, Williamina Paton (née Stevens)** (1857–1911) Scottish-American astronomer who in 1881 joined EDWARD CHARLES PICKERING at the HARVARD COLLEGE OBSERVATORY and devised a classification system for stellar spectra that greatly improved the system used by PIETRO ANGELO SECCHI. Her alphabetic system became known as the HARVARD CLASSIFICATION SYSTEM and appeared in the 1890 edition of *The Henry Draper Catalogue*.

**Foucault, Jean-Bernard Léon** (1819–68) French physicist who investigated the SPEED OF LIGHT in air and water and was the first to demonstrate experimentally that EARTH rotates on its AXIS. He performed this experiment with a Foucault pendulum—a relatively large MASS (about 30 kg) suspended on a very long (about 70 m) wire.

**Fowler, William Alfred** (1911–95) American astrophysicist who developed the widely accepted theory that nuclear processes in STARS are responsible for all the heavier ELEMENTS in the UNIVERSE beyond HYDROGEN and HELIUM, including those in the human body. He shared the 1983 Nobel Prize in physics for his work on STELLAR EVOLUTION and NUCLEOSYNTHESIS.

**Fraunhofer, Joseph von** (1787–1826) German optician and physicist who developed the PRISM SPECTROMETER in about 1814 and then used this instrument to discover the dark lines in the SUN's SPECTRUM that now carry his name. In 1823, he observed similar (but different) lines in the spectra of other STARS.

**Friedman, Herbert** (1916–2000) American astrophysicist who, in 1949, began using SOUNDING ROCKETS in ASTRONOMY—

## BIOGRAPHIES



Yuri A. Gagarin (NASA)



Italian stamp honoring Galileo Galilei (the author)

## BIOGRAPHIES

### Gagarin – Gamow

especially for the initial study of the SUN'S X-RAY activity. In 1964 as a scientist with the U.S. Naval Research Laboratory (Washington, D.C.), his ROCKET-borne SENSORS detected X-rays from the CRAB NEBULA.

**Gagarin, Yuri A.** (1934–68) The Russian COSMONAUT who became the first human being to travel in OUTER SPACE. He accomplished this feat with his historic one ORBIT OF EARTH mission in the *VOSTOK 1* SPACECRAFT on 12 April 1961. A popular hero of the former Soviet Union, he died in an aircraft training flight near Moscow on 27 March 1968.

**Galileo Galilei** (1564–1642) Italian astronomer, physicist, and mathematician whose innovative use of the TELESCOPE to make astronomical observations ignited the scientific revolution of the 17th century. In 1610, he announced some of his early telescopic findings in the publication *Starry Messenger*—including the discovery of the four major MOONS of JUPITER (now called the GALILEAN SATELLITES). Their behavior like a miniature SOLAR SYSTEM stimulated his enthusiastic support for the HELIOCENTRIC COSMOLOGY of NICHOLAS COPERNICUS. Unfortunately, this scientific work led to a direct clash with church authorities who insisted on retaining the PTOLEMAIC SYSTEM for a number of political and social reasons. By 1632, this conflict earned the fiery Galileo an Inquisition trial at which he was found guilty of heresy (for advocating the COPERNICAN SYSTEM) and confined to house arrest for the remainder of his life.

**Galle, Johann Gottfried** (1812–1910) German astronomer who was the first person to observe NEPTUNE. Acting upon a request from URBAIN-JEAN-JOSEPH LEVERRIER, he immediately began a telescopic search at the Berlin Observatory on 23 September 1846. This search soon yielded the new PLANET precisely in the region of the night sky predicted by Leverrier's calculations, which were based on PERTURBATIONS in the ORBIT OF URANUS.

**Gamow, George** (1904–68) Ukranian-American physicist who, in collaboration in the late 1940s with RALPH ALPHER, promoted the BIG BANG theory—a theory that boldly speculated that the UNIVERSE began by means of a huge, ancient explosion. He described this concept in the 1948 paper entitled “The Origin

### Gagarin – Gamow

of the Chemical Elements.” Gamow based some of this work on the COSMOLOGY concepts previously suggested by GEORGES-ÉDOUARD LEMAÎTRE.

**Gauss, Carl Friedrich** (1777–1855) Brilliant German mathematician whose contributions to CELESTIAL MECHANICS helped many other astronomers efficiently calculate the ORBITS of PLANETS, ASTEROIDS, and COMETS. For example, Gauss’s mathematical innovations, like the method of least squares, enabled URBAIN-JEAN-JOSEPH LEVERRIER to predict theoretically the position of NEPTUNE in 1846 based on the subtle orbital PERTURBATIONS observed for URANUS.

**Giacconi, Riccardo** (1931– ) Italian-American astrophysicist who made pioneering contributions to X-RAY ASTRONOMY. In June 1962, he placed specially-designed instruments in the PAYLOAD compartment of a SOUNDING ROCKET and detected the first EXTRASOLAR X-RAY source, Scorpius X-1. He supervised the development of NASA’s *Uhuru X-ray Satellite* (launched in 1970) and NASA’s *High Energy Astronomy Observatory 2 (HEAO-2)*, also called the *Einstein X-ray Observatory*, which was successfully launched in 1978. In October 2002, the Nobel Committee awarded Giacconi one half of the that year’s Nobel Prize in physics for his pioneering contributions to astrophysics—an effort that led to the discovery of cosmic X-ray sources.

**Gibson, Edward G.** (1936– ) American ASTRONAUT and SOLAR physicist who served as the science pilot on NASA’s *SKYLAB 4* mission from 16 November 1973 to 8 February 1974. This was the third and final mission to *Skylab*—the first American SPACE STATION placed into LOW EARTH ORBIT.

**Gill, Sir David** (1843–1914) Scottish astronomer who improved the measured value of the ASTRONOMICAL UNIT (EARTH-SUN distance) by collecting data during his 1877 expedition to Ascension Island in the South Atlantic and who made precise observations of the SOLAR PARALLAX by observing the motion of several ASTEROIDS in 1889.

**Giotto di Bondone** (1266–1337) Italian artist of the Florentine school who apparently witnessed the 1301 passage of COMET HALLEY and then included the first “scientific” representation



Carl Friedrich Gauss on German stamp (the author)



## BIOGRAPHIES



John Herschel Glenn, Jr.  
(Courtesy of NASA)

## Glenn – Goddard

of the COMET in his fresco *Adoration of the Magi* found in the Scroveni Chapel in Padua, Italy. The EUROPEAN SPACE AGENCY named the *GIOTTO* SPACECRAFT in his honor.

**Glenn, John Herschel, Jr.** (1921– ) The American ASTRONAUT, U.S. Marine Corps officer, and U.S. senator who was the first American to ORBIT EARTH—a feat that he accomplished on 20 February 1962 as part of NASA's MERCURY PROJECT. Glenn's historic mission, aboard the *Friendship 7* Mercury SPACE CAPSULE, made three orbits of Earth and lasted about five hours. Over three and one-half decades later, he became the oldest human being to travel in OUTER SPACE when he joined the SPACE SHUTTLE *Discovery* crew on its nine-day duration STS-95 orbital mission (from 29 October to 7 November 1998).

**Goddard, Robert Hutchings** (1882–1945) American physicist and ROCKET scientist who cofounded ASTRONAUTICS early in the 20th century along with (but independent of) KONSTANTIN EDUARDOVICH TSIOLKOVSKY and HERMANN J. OBERTH. Regarded as the Father of Modern Rocketry, he successfully launched the world's first LIQUID-PROPELLANT ROCKET on 16 March 1926 in a snow-covered field in Auburn, Massachusetts.



Robert Goddard testing  
rocket in New Mexico (NASA)

## BIOGRAPHIES

## Glenn – Goddard

As a brilliant, but reclusive, inventor, he continued his pioneering rocket experiments at a remote desert site near Roswell, New Mexico. In 1960, after recognizing that most modern rockets are really Goddard rockets, the United States government paid his estate 1 million dollars for the use of his numerous patents.

**Gold, Thomas** (1920–2004) Austrian-American astronomer who, in 1948, while collaborating with SIR FRED HOYLE and SIR HERMANN BONDI, proposed a STEADY-STATE UNIVERSE model in COSMOLOGY. This model, based on the PERFECT COSMOLOGICAL PRINCIPLE, has now been largely abandoned in favor of the BIG BANG theory. In the late 1960s, he suggested that the periodic signals from PULSARS represented emissions from rapidly spinning NEUTRON STARS—a theoretical hypothesis that appears consistent with subsequent observational data.

**Goodricke, John** (1764–86) British astronomer who, though a deaf-mute, made a significant contribution to 18th-century ASTRONOMY by observing that certain VARIABLE STARS, like Algol, were periodic in nature. Prior to his death from pneumonia at age 21, he further suggested that this periodic behavior might be due to a dark, not visible companion regularly passing in front of (eclipsing) its visible companion—a phenomenon modern astronomers call an eclipsing BINARY (DOUBLE) STAR SYSTEM.

**Gordon, Richard F., Jr.** (1929– ) American ASTRONAUT and U.S. Navy officer who occupied the command module pilot seat during NASA's *Apollo 12* mission (14–24 November 1969)—the second LUNAR-landing mission in which APOLLO PROJECT astronauts ALAN L. BEAN and CHARLES (PETE) CONRAD, JR., walked on the MOON's surface while Gordon remained in lunar ORBIT.

**Gould, Benjamin Apthorp** (1824–96) American astronomer who founded the *Astronomical Journal* in 1849 and produced an extensive 19th-century STAR catalog for the Southern Hemisphere sky. In 1868, he was invited by the government of Argentina to establish and direct a national OBSERVATORY at Córdoba. This gave him the opportunity to make detailed observations, resulting in a star catalog comparable to

FRIEDRICH WILHELM AUGUST ARGELANDER's work for the northern sky.

**Gregory, James** (1638–75) Scottish mathematician and astronomer who conceptually described the components and operation of a two-mirror REFLECTING TELESCOPE (a design later called the Gregorian telescope) in his 1663 publication *The Advance of Optics*.

**Grissom, Virgil "Gus" I.** (1926–67) American ASTRONAUT and U.S. Air Force officer who was the second American to travel in OUTER SPACE—a feat accomplished during NASA's suborbital MERCURY PROJECT/*Liberty Bell 7* flight on 21 July 1961. In March 1965, he served as the command pilot during the first crewed GEMINI PROJECT orbital mission. Gus Grissom, along with his fellow APOLLO PROJECT astronauts EDWARD H. WHITE II and ROGER B. CHAFFEE, died on 27 January 1967 at CAPE CANAVERAL when a flash fire consumed their Apollo SPACECRAFT during a mission simulation and training test at the LAUNCH PAD.

**Haise, Fred Wallace, Jr.** (1933– ) American ASTRONAUT who served as the LUNAR MODULE (LM) pilot for NASA's ill-fated *Apollo 13* mission to the MOON from 11–17 April 1970. Instead of landing as planned in the Fra Mauro region, he helped fellow astronauts JAMES ARTHUR LOVELL, JR., and JOHN LEONARD "JACK" SWIGERT, JR., maneuver an explosion-crippled APOLLO PROJECT SPACECRAFT on a life-saving emergency TRAJECTORY around the Moon and back to safety on EARTH. As the LM pilot, he was instrumental in converting that two-person lunar LANDER spacecraft into a three-person lifeboat. In 1977, he participated as a pilot-astronaut during the SPACE SHUTTLE approach and landing tests conducted at Edwards Air Force Base in California. These nonpowered, gliding tests served as an important preparation for the shuttle spaceflight program of the 1980s.

**Haldane, J(ohn) B(urdon) S(Anderson)** (1882–1964) British geneticist and science writer who pioneered several research pathways in the evolution of life and population genetics. In the 1920s Haldane and ALEKSANDR I. OPARIN suggested that a reducing ATMOSPHERE (one without oxygen) and high doses

of ULTRAVIOLET RADIATION might produce organic MOLECULES. The Oparin-Haldane hypothesis implied that life on EARTH slowly emerged from an ancient biochemical soup. An avowed Marxist, he left the United Kingdom in 1957 and went to India, where he became the director of that country's Genetics and Biometry Laboratory in Orissa.

**Hale, George Ellery** (1868–1938) American astronomer who pioneered the field of modern ASTROPHYSICS. In the late 1880s, he invented the spectroheliograph—an instrument that allowed astronomers to photograph the SUN at a particular WAVELENGTH or SPECTRAL LINE. He was also responsible for establishing several major observatories in the United States, including the YERKES OBSERVATORY (Wisconsin), the Mount Wilson Observatory (California), and the PALOMAR OBSERVATORY (California).

**Hall, Asaph** (1829–1907) American astronomer who discovered the two small MOONS of MARS, PHOBOS and DEIMOS, in 1877 while a staff member at the U.S. NAVAL OBSERVATORY.

**Halley, Edmond (a.k.a. Edmund)** (1656–1742) British mathematician and astronomer who encouraged SIR ISAAC NEWTON to write the *Principia*—one of the most important scientific books ever written. In his own book, *A Synopsis of the Astronomy of Comets*, which appeared in 1705, Halley suggested that the COMET he observed in 1682 was actually the same comet that appeared in 1531. He then boldly used NEWTON'S LAWS OF MOTION (as contained in the *Principia*, whose publication he personally financed) to predict that this comet would return again in about 1758. It did (after his death), and COMET HALLEY carries his name because of the accuracy of his prediction and discovery. He succeeded JOHN FLAMSTEED as the second ASTRONOMER ROYAL (1720–42).

**Hawking, Stephen William** (1942– ) British astrophysicist and cosmologist who, despite a disabling neurological disorder, has made major theoretical contributions to the study of GENERAL RELATIVITY and QUANTUM MECHANICS—especially by providing an insight into the unusual physics of BLACK HOLES and mathematical support for the BIG BANG theory. In 1988, he published *A Brief History of Time*, a popular book

that introduced millions of readers to modern COSMOLOGY. His concept of HAWKING RADIATION suggests an intimate relationship between GRAVITY, quantum mechanics, and thermodynamics.

**Henderson, Thomas** (1798–1844) Scottish astronomer who, in the 1830s, made careful PARALLAX measurements of ALPHA CENTAURI from the Cape of Good Hope Observatory (South Africa). As a result of these observations, he reported in 1839 that this STAR (actually a triple star system) was a distance of less than four LIGHT-YEARS away—making it the closest known star (excluding the SUN).

**Heraclides of Pontus** (ca. 388 B.C.E.–315 B.C.E.) Greek astronomer and philosopher who was the first person to suggest that this PLANET had a daily ROTATION on its AXIS from west to east. While believing EARTH was the center of the UNIVERSE, he boldly speculated that MERCURY and VENUS might travel in ORBITS around the SUN since neither planet was ever observed far from it. Unfortunately, his revolutionary idea about planets traveling around the Sun clashed with GEOCENTRIC Greek COSMOLOGY—so it remained essentially unnoticed until being rediscovered by NICHOLAS COPERNICUS in the 16th century.

**Hero of Alexandria (a.k.a. Heron)** (1st century C.E.: ca. 20–ca. 80) Greek mathematician and engineer who invented many clever mechanical devices including the aeolipile—a spinning, steam-powered spherical apparatus that demonstrated the action-reaction principle by which all ROCKET engines work.

**Herschel, Caroline** (1750–1848) German-born British astronomer who was the sister and assistant of SIR (FREDERICK) WILLIAM HERSCHEL and the first notable woman astronomer. As a skilled observer, she personally discovered eight COMETS between 1786 and 1797. She also observed the ANDROMEDA GALAXY. Consistent with practices of 18th-century ASTRONOMY, she referred to this object in 1783 as a NEBULA.

**Herschel, Sir John (Frederick William)** (1792–1871) British astronomer and the son of SIR (FREDERICK) WILLIAM HERSCHEL, who continued his father's investigations of BINARY (DOUBLE) STAR SYSTEMS and NEBULAS. Between about 1833 and 1838 he performed an extensive survey of the night sky in

the Southern Hemisphere from an observatory at the Cape of Good Hope (South Africa).

**Herschel, Sir (Frederick) William** (1738–1822) German-born British astronomer who discovered URANUS in 1781—the first new PLANET since the start of ancient ASTRONOMY and the first found through the use of the TELESCOPE. As a skilled observer, he located more than 2,500 NEBULAS and STAR CLUSTERS as well as over 800 BINARY (DOUBLE) STAR SYSTEMS. His study of the distribution of the observed STARS established a basic understanding of the form of the MILKY WAY GALAXY. In 1800, while investigating the ENERGY content of sunlight (SOLAR RADIATION) with the help of a PRISM and a thermometer, he discovered the existence of (thermal) INFRARED RADIATION—which lies just beyond red LIGHT in a longer WAVELENGTH portion of the ELECTROMAGNETIC (EM) SPECTRUM.

**Hertz, Heinrich Rudolf** (1857–94) German physicist who, in 1888, produced and detected RADIO WAVES for the first time. He also demonstrated that ELECTROMAGNETIC RADIATION propagates at the SPEED OF LIGHT. The HERTZ (Hz) is the SI UNIT of FREQUENCY named in his honor.

**Hertzsprung, Ejnar** (1873–1967) Danish astronomer who, in 1905, showed how the LUMINOSITY of a STAR is related to its COLOR (or SPECTRUM). He contributed to the creation of the famous HERTZSPRUNG-RUSSELL (H-R) DIAGRAM that is essential for understanding the theory of STELLAR EVOLUTION.

**Hess, Victor Francis** (1883–1964) Austrian-American physicist who, between 1911 to 1913, conducted radiation detection measurements while riding in high-ALTITUDE balloons that provided him with the initial scientific evidence for the existence of COSMIC RAYS. He shared the 1936 Nobel Prize in physics for this discovery.

**Hevelius, Johannes** (1611–87) Polish-German astronomer who, in 1647, published a LUNAR atlas called *Selenographica*—the first detailed description of the NEARSIDE of the MOON. As a skilled observer, he used his large, personally constructed OBSERVATORY named Stellaburgum located in Danzig (now Gdansk, Poland) to develop a comprehensive catalog of over 1,500 STARS and to discover four COMETS.

**Hewish, Antony** (1924– ) British astronomer who collaborated with SIR MARTIN RYLE in the development of RADIO WAVE-based ASTROPHYSICS. His efforts included the discovery of the PULSAR—for which he shared the 1974 Nobel Prize in physics with Ryle. During a survey of galactic radio waves in August 1967, his graduate student (SUSAN) JOCELYN BELL BURNELL was actually the first person to notice the repetitive signals from this pulsar, but her contributions were inexplicably overlooked by the Nobel awards committee.

**Hill, George William** (1838–1914) American astronomer and mathematician who made fundamental contributions to CELESTIAL MECHANICS—including pioneering mathematical methods to calculate precisely the MOON'S ORBIT with PERTURBATIONS from JUPITER and SATURN.

**Hipparchus of Nicaea** (ca. 190 B.C.E.–120 B.C.E.) Greek astronomer and mathematician who is generally regarded by science historians as the greatest ancient astronomer. Although he embraced GEOCENTRIC COSMOLOGY, he carefully studied the SUN'S annual motion to determine the length of a YEAR to an accuracy of about six minutes. His observational legacy includes a STAR catalog completed in about 129 B.C.E. that contained 850 FIXED STARS. He also divided NAKED EYE observations into six MAGNITUDES, ranging from the faintest (or least visible to the naked eye) to the brightest observable CELESTIAL BODIES in the night sky.

**Hohmann, Walter** (1880–1945) German engineer who wrote the 1925 book *The Attainability of Celestial Bodies*. In this work, he described the mathematical principles that govern SPACE VEHICLE motion—including the most efficient (that is, minimum-ENERGY) orbit transfer path between two ORBITS in the same geometric plane. This widely used (but time-consuming) orbit transfer technique is now called the HOHMANN TRANSFER ORBIT in his honor.

**Horrocks, Jeremiah** (1619–41) British astronomer who was the first person to predict and then record a TRANSIT of VENUS across the SUN that occurred on 24 November 1639.

**Hoyle, Sir Fred** (1915–2001) British astrophysicist and writer who joined with SIR HERMANN BONDI and THOMAS GOLD in 1948

to develop and promote the STEADY-STATE UNIVERSE model. Hoyle first coined the expression BIG BANG theory—essentially as a derogatory remark about this competitive theory in COSMOLOGY. The term stuck and the big bang theory has all but displaced the steady-state universe model in contemporary ASTROPHYSICS. He also collaborated with GEOFFREY RONALD BURBIDGE, (ELEANOR) MARGARET BURBIDGE, and WILLIAM ALFRED FOWLER in the development of the theory of NUCLEOSYNTHESIS. Though often controversial, he popularized ASTRONOMY with several well-known books and was also an accomplished science fiction writer.

**Hubble, Edwin Powell** (1889–1953) American astronomer who made important observational discoveries in the 1920s and 1930s that completely changed humans' view of the UNIVERSE. In 1923 by using a CEPHEID VARIABLE STAR, he was able to estimate the distance to the ANDROMEDA GALAXY. His results immediately suggested that such spiral NEBULAS were actually large, distant independent stellar systems or ISLAND UNIVERSES. He introduced a classification scheme in 1925 for such nebulas (GALAXIES), calling them either elliptical, spiral, or irregular. This scheme is still used. In 1929, he announced that in an expanding universe, the other galaxies are receding from this one with speeds proportional to their distance—a postulate now known as HUBBLE'S LAW. Hubble's concept of an expanding universe filled with numerous galaxies forms the basis of modern observational COSMOLOGY.

**Huggins, Margaret Lindsay (née Murray)** (1848–1915) British astronomer who worked with her husband (SIR WILLIAM HUGGINS) to collect pioneering SPECTRA of celestial objects, including the ORION NEBULA.

**Huggins, Sir William** (1824–1910) British astronomer and spectroscopist who helped revolutionize the observation of CELESTIAL BODIES by performing early SPECTROSCOPY measurements and then comparing the observed stellar SPECTRA with laboratory spectra. In 1868, he collaboratively made the first measurement of a STAR'S DOPPLER SHIFT. In 1881 (independent of HENRY DRAPER), he also made a pioneering photograph of the spectrum of a COMET.



**Hulse, Russell Alan** (1950– ) American radio astronomer who codiscovered the first binary pulsar—a PULSAR in ORBIT around another NEUTRON STAR. For this work, he shared the 1993 Nobel Prize in physics with his research professor (JOSEPH H. TAYLOR).

**Humason, Milton Lassell** (1891–1972) American astronomer who assisted EDWIN POWELL HUBBLE in the late 1920s during Hubble’s discovery of the recession of the distant GALAXIES and the expansion of the UNIVERSE.

**Huygens, Christiaan** (1629–95) Dutch astronomer, physicist, and mathematician who discovered TITAN, the largest MOON of SATURN, in 1655. By using a personally constructed TELESCOPE, he was able to discern (~1659) the true (thin disklike) shape of SATURN’S RINGS. As a creative and productive individual, he also constructed and patented the first pendulum clock (about 1656) and founded the wave theory of LIGHT.

**Innes, Robert Thorburn Ayton** (1861–1933) Scottish astronomer who discovered PROXIMA CENTAURI in 1915. Except for the SUN, this STAR is the closest one to EARTH (about 4.2 LIGHT-YEARS away) and is the faintest member of the ALPHA CENTAURI triple-star system.

**Irwin, James Benson** (1930–91) American ASTRONAUT and U.S. Air Force officer who served as the LUNAR MODULE (LM) pilot during NASA’s *Apollo 15* mission to the HADLEY RILLE region of the MOON. As part of this APOLLO PROJECT mission (26 July to 7 August 1971), he became the eighth person to walk on the LUNAR surface.

**Jansky, Karl Guthe** (1905–50) American radio engineer who started the field of RADIO ASTRONOMY in 1932 by initially detecting and then identifying INTERSTELLAR RADIO WAVES from the direction of the CONSTELLATION Sagittarius—a direction corresponding to the central region of the MILKY WAY GALAXY. In his honor, the unit describing the strength of an EXTRATERRESTRIAL radio wave signal is called the JANSKY.

**Janssen, Pierre-Jules-César** (1824–1907) French astronomer who pioneered the field of SOLAR physics. His precise measurements of the SUN’S SPECTRAL LINES in 1868 enabled SIR JOSEPH

NORMAN LOCKYER to conclude the presence of a previously unknown ELEMENT (which Lockyer called HELIUM). At the end of the 19th century, Janssen focused his efforts on the new field of ASTROPHOTOGRAPHY and created an extensive collection of over 6,000 photographic IMAGES of the Sun, which he published as a solar atlas in 1904.

**Jarvis, Gregory B.** (1944–86) American ASTRONAUT who died in the explosion of the SPACE SHUTTLE *Challenger* on 28 January 1986 while serving as a civilian payload specialist on the ill fated STS 51-L mission. He was an electrical engineer for the Hughes Aircraft Company.

**Jeans, Sir James Hopwood** (1877–1946) British astronomer, physicist, and writer who proposed various theories of STELLAR EVOLUTION and suggested in 1928 that matter was being continuously created in the UNIVERSE. This hypothesis led other scientists to establish a STEADY-STATE UNIVERSE model in COSMOLOGY. From 1928 on, he focused his activities on writing popular books on ASTRONOMY.

**Jones, Sir Harold Spencer** (1890–1960) British astronomer who made precise measurements of the ASTRONOMICAL UNIT (AU)—that is, the average distance from EARTH to the SUN. He served as the 10th ASTRONOMER ROYAL (1933–55) and wrote a number of popular books on ASTRONOMY, including *Life on Other Worlds* (1940).

**Kant, Immanuel** (1724–1804) German philosopher who was the first to propose the NEBULA hypothesis in the 1755 book *General History of Nature and Theory of the Heavens*. In the nebula hypothesis, he suggested that the SOLAR SYSTEM formed out of a primordial cloud of INTERSTELLAR matter. Kant also introduced the term ISLAND UNIVERSES to describe distant collections of STARS—now called GALAXIES. As a truly brilliant thinker, his works in metaphysics and philosophy had a great influence on Western thinking in the 18th century and beyond.

**Kapteyn, Jacobus Cornelius** (1851–1922) Dutch astronomer who made significant contributions to ASTROPHOTOGRAPHY and the use of statistical methods to evaluate stellar distributions and motions of STARS. By using photographic IMAGES collected by SIR DAVID GILL, Kapteyn finished publishing in 1900 an

## BIOGRAPHIES



John F. Kennedy addressing Congress in 1961 (NASA)



Johannes Kepler (NASA and Caltech Archives)

## BIOGRAPHIES

### Kármán – Kepler

extensive (three-volume) catalog that contained over 450,000 Southern Hemisphere stars.

**Kármán, Theodore von** *See* VON KÁRMÁN, THEODORE.

**Keeler, John Edward** (1857–1900) American astronomer who assisted SAMUEL PIERPONT LANGLEY in making measurements of SOLAR RADIATION from Mount Whitney, California, in 1881. By studying the spectral composition of the RINGS of SATURN, he showed that the rings were composed of collections of discrete PARTICLES as earlier suggested by JAMES CLERK MAXWELL.

**Keenan, Philip Childs** (1908–2000) The American astronomer who specialized in stellar ASTROPHYSICS and collaborated with WILLIAM WILSON MORGAN in the development of the widely used modern stellar classification system known as MORGAN-KEENAN (MK) CLASSIFICATION SYSTEM. Their joint endeavors culminated in publication of *An Atlas of Stellar Spectra* in 1943.

**Kelvin, William Thomson, Lord (a.k.a. Baron Kelvin)** (1824–1907) Scottish physicist, engineer, and mathematician who made major contributions to the electromagnetic theory of LIGHT and to thermodynamics, including an ABSOLUTE TEMPERATURE scale that now bears his name. The SI UNIT of absolute temperature is called the KELVIN.

**Kennedy, John F.** (1917–63) The 35th president of the United States who boldly proposed in May 1961 that NASA send ASTRONAUTS to the MOON to demonstrate American space technology superiority over the former Soviet Union during the COLD WAR. He was assassinated on 22 November 1963 and did not live to see the triumphant APOLLO PROJECT LUNAR landings (1969–72)—a magnificent technical accomplishment that his vision and leadership set in motion almost a decade earlier.

**Kepler, Johannes (a.k.a. Johann)** (1571–1630) German astronomer and mathematician who developed three laws of planetary motion that described the ELLIPTICAL ORBITS of the PLANETS around the SUN and provided the empirical basis for the acceptance of NICHOLAS COPERNICUS'S HELIOCENTRIC hypothesis. KEPLER'S LAWS gave ASTRONOMY its modern, mathematical foundation. His publication *The New Star (De*

### Kármán – Kepler

*Stella Nova*) described the SUPERNOVA in the constellation Ophiuchus that he first observed (with the NAKED EYE) on 9 October 1604.

**Kerr, Roy Patrick** (1934– ) New Zealander mathematician who made a major contribution to ASTROPHYSICS in 1963 by applying GENERAL RELATIVITY to describe the properties of a rotating BLACK HOLE—a phenomenon now referred to as a KERR BLACK HOLE.

**Khrushchev, Nikita S.** (1894–1971) The provocative premier of the former Soviet Union who used early Russian OUTER SPACE achievements to imply Soviet superiority over the United States (and capitalism) during the COLD WAR. With his permission and encouragement, Russian ROCKET engineers, like SERGEI KOROLEV, used powerful military INTERCONTINENTAL BALLISTIC MISSILES as SPACE LAUNCH VEHICLES to place the first ARTIFICIAL SATELLITE successfully into ORBIT around EARTH (*SPUTNIK 1* on 4 October 1957) and to allow the first human to orbit Earth (COSMONAUT YURI A. GAGARIN on 12 April 1961). Despite these Soviet space accomplishments, failing domestic economic programs and a major loss of political prestige during the Cuban missile crisis (October 1962) eventually forced him from office in October 1964. Khrushchev's aggressive use of space exploration as a tool of international politics encouraged JOHN F. KENNEDY to initiate the APOLLO PROJECT—ultimately giving all of humanity one of its greatest technical triumphs.

**Kirchhoff, Gustav Robert** (1824–87) German physicist who cooperated with ROBERT WILHELM BUNSEN in developing the fundamental principles of SPECTROSCOPY. While investigating the phenomenon of BLACKBODY RADIATION, he applied spectroscopy to study the chemical composition of the SUN—especially the production of the Fraunhofer lines (see FRAUNHOFER, JOSEPH VON) in the SOLAR SPECTRUM. His pioneering work contributed to the development of astronomical spectroscopy, one of the major tools in modern ASTRONOMY.

**Kirkwood, Daniel** (1814–95) American astronomer and mathematician who, in 1866, explained the uneven distribution

and gaps in the MAIN-BELT ASTEROID population as being the result of orbital resonances with the PLANET JUPITER. Today, these gaps are called the KIRKWOOD GAPS in his honor.

**Komarov, Vladimir M.** (1927–67) Russian COSMONAUT and Air Force officer who was the first person to make two trips into OUTER SPACE and also the first person to die while engaged in space travel. On 23 April 1967, he ascended into EARTH ORBIT onboard the new Soviet SPACECRAFT, called *SOYUZ 1*. The flight encountered many difficulties. He finally had to execute an emergency REENTRY maneuver on the 18th orbit (24 April). During the final stage reentry over the Kazakh Republic, the recovery parachute became entangled, causing his spacecraft to impact the ground at high speed. He died instantly and was given a hero's state funeral.

**Korolev, Sergei** (1907–66) The Ukraine-born Russian ROCKET engineer who was the driving technical force behind the initial INTERCONTINENTAL BALLISTIC MISSILE (ICBM) program and the early OUTER SPACE exploration projects of the former Soviet Union. In 1954, he started work on the first Soviet ICBM, the *R-7*. This powerful rocket system was capable of carrying a massive PAYLOAD across continental distances. As part of COLD WAR politics, Soviet premier NIKITA S. KHRUSHCHEV allowed Korolev to use this military rocket to place the first ARTIFICIAL SATELLITE (*SPUTNIK 1*) into ORBIT around EARTH on 4 October 1957—an event now generally regarded as the beginning of the Space Age.



Russian stamp commemorates contributions of Sergei Korolev (the author)

**Krikalev, Sergei** (1958– ) Russian COSMONAUT who flew on the first joint U.S./Russian SPACE SHUTTLE *Discovery* mission (STS-60) in February 1994. A little over four years later, he flew as member of the crew aboard the space shuttle *Endeavour* (STS-88) and participated in the inaugural INTERNATIONAL SPACE STATION (*ISS*) assembly mission (December 1998). This veteran Russian space traveler then served as a member of the *ISS* Expedition 1 crew, which launched from the BAIKONUR COSMODROME (Kazakhstan) on a Russian SOYUZ LAUNCH VEHICLE on 31 October 2000. The SPACE STATION's first crew docked with the orbiting international facility (still under assembly) on 2 November. Krikalev and his Expedition 1 crewmates then departed the *ISS* on 18 March 2001, riding as

EARTH-bound passengers on the space shuttle *Discovery* (STS-102 mission), which landed at the KENNEDY SPACE CENTER on 21 March 2001. Krikalev also served as commander of *ISS Expedition 11*. When he completed this 179-day duration mission on 10 October 2005, Krikalev had accumulated a total of over 800 days in OUTER SPACE, including eight EXTRAVEHICULAR ACTIVITIES (EVAs).

**Kuiper, Gerard Peter** (1905–73) Dutch-American astronomer who postulated in 1951 the presence of thousands of icy PLANETESIMALS in an extended region at the edge of the SOLAR SYSTEM beyond the ORBIT of NEPTUNE—a region now called the KUIPER BELT in his honor. As a skilled SOLAR SYSTEM observer, in 1944 he discovered that SATURN’s largest MOON (TITAN) had an ATMOSPHERE; in 1948 Miranda, the fifth-largest moon of URANUS; and in 1949 Nereid, the outermost moon of Neptune. He also served as an adviser to NASA for the early LUNAR missions of the 1960s.

**Lacaille, Nicolas-Louis de** (1713–62) French astronomer who mapped the positions of nearly 10,000 STARS in the Southern Hemisphere from the Cape of Good Hope (South Africa) between 1751–53. This effort was summarized in the book *Star Catalog of the Southern Sky*—published in 1763, the year after he died.

**Lagrange, Joseph-Louis (a.k.a. Giuseppe Luigi Lagrangia)** (1736–1813) Italian-French astronomer and mathematician who made significant contributions to CELESTIAL MECHANICS in the 18th century. His book *Analytical Mechanics*, which was published in 1788, is regarded as an excellent compendium on the subject. He is noted for identifying the LAGRANGIAN LIBRATION POINTS. He described them in about 1772 as the five equilibrium points for a small CELESTIAL BODY under the gravitational influence of two larger bodies.

**Lalande, Joseph-Jérôme Le Français de** (1732–1807) French astronomer who collaborated in 1751 with NICOLAS LOUIS DE LACAILLE in measuring the distance to the MOON. He also published an extensive catalog in 1801, containing about 47,000 STARS—including a “star” that actually was the PLANET NEPTUNE later discovered by JOHANN GOTTFRIED GALLE in 1846.

## BIOGRAPHIES



Samuel Pierpont Langley  
(NASA)

## Landau – Leavitt

**Landau, Lev Davidovich** (1908–68) Russian physicist who, in the early 1930s, speculated about the existence of the NEUTRON STAR. He was awarded the Nobel Prize in physics in 1962 for his pioneering work in condensed matter, especially involving the properties of HELIUM.

**Langley, Samuel Pierpont** (1834–1906) American astronomer and aeronautics pioneer who believed that all life and activity on EARTH was made possible by SOLAR RADIATION. In 1878 he invented the bolometer—an instrument sensitive to incident ELECTROMAGNETIC RADIATION and especially suitable for measuring the amount of INFRARED RADIATION (IR). Modern versions of Langley’s instrument are placed onto EARTH-OBSERVING SPACECRAFT to provide regional and global measurements of this PLANET’s radiant ENERGY budget. He also led an expedition to the top of Mount Whitney (California) in 1881 to analyze the infrared component of the SUN’s SPECTRUM.

**Laplace, Pierre-Simon, marquis de** (1749–1827) French mathematician and astronomer who established the mathematical foundations of CELESTIAL MECHANICS. His work provided a complete mechanical interpretation of the SOLAR SYSTEM, including PERTURBATIONS of planetary motions. In 1796 (apparently independent of IMMANUEL KANT), he introduced his own version of the NEBULA hypothesis when he suggested that the SUN and the PLANETS condensed from a primeval INTERSTELLAR cloud of gas.

**Lassell, William** (1799–1880) British (amateur) astronomer and wealthy brewer who discovered TRITON, the largest MOON of NEPTUNE, on 10 October 1846—just 17 days after JOHANN GOTTFRIED GALLE discovered the PLANET. During other observations of the SOLAR SYSTEM in the 19th century, he codiscovered the eighth SATURNIAN moon, Hyperion (1848), and then discovered two moons of URANUS in 1851, Ariel and Umbriel.

**Leavitt, Henrietta Swan** (1868–1921) American astronomer who joined the staff at HARVARD COLLEGE OBSERVATORY in 1902 and discovered (about 1912) the PERIOD-LUMINOSITY relationship for CEPHEID VARIABLE STARS. Her discovery allowed other astronomers, like HARLOW SHAPLEY, to make

## BIOGRAPHIES

## Landau – Leavitt

more accurate estimates of distances in the MILKY WAY GALAXY and beyond. During her career, she found over 2,400 VARIABLE STARS. Her efforts helped change people's knowledge of the size of the UNIVERSE.

**Lemaître, Georges-Édouard** (1894–1966) Belgian astrophysicist, cosmologist, and priest who suggested, in 1927, that a violent explosion might have started an expanding UNIVERSE. He based this hypothesis on his interpretation of the GENERAL RELATIVITY theory and upon EDWIN POWELL HUBBLE's contemporary observation of galactic REDSHIFTS—that the universe was indeed expanding. Other physicists, such as GEORGE GAMOW, built upon Lemaître's work and developed it into the widely accepted BIG BANG theory of modern COSMOLOGY. Central to Lemaître's model is the idea of an initial cosmic egg or superdense primeval ATOM that started the universe in a colossal ancient explosion.

**Leonov, Alexei Arkhipovich** (1934– ) Russian COSMONAUT who was the first person to perform a SPACE WALK—a tethered EXTRAVEHICULAR ACTIVITY (EVA) on 18 March 1965 outside his EARTH-orbiting *VOSKHOD 2* SPACECRAFT. In July 1975, he served as the Russian spacecraft commander during the international APOLLO-SOYUZ TEST PROJECT (ASTP).

**Leverrier, Urbain-Jean-Joseph** (1811–77) French astronomer and CELESTIAL MECHANICS practitioner whose mathematical predictions in 1846 (independent of JOHN COUCH ADAMS) concerning the possible location of an eighth as yet undetected PLANET allowed JOHANN GOTTFRIED GALLE to discover NEPTUNE quickly by telescopic observation on 23 September 1846. Despite his great success with the predictive discovery of Neptune, he erroneously suggested that observed PERTURBATIONS in the ORBIT of MERCURY were due to another undiscovered planet (called VULCAN), which was much closer to the SUN than Mercury. However, ALBERT EINSTEIN's GENERAL RELATIVITY theory allowed astronomers in the early 20th century to understand the perturbations of Mercury without resorting to Leverrier's hypothetical, nonexistent planet Vulcan.



**Ley, Willy** (1906–69) German-American engineer and technical writer who promoted INTERPLANETARY space travel in the United States following World War II—especially by writing popular books such as *Rockets, Missiles and Space Travel*.

**Lindblad, Bertil** (1895–1965) Swedish astronomer who studied the dynamics of stellar motions and suggested in the mid-1920s that the MILKY WAY GALAXY was rotating. His pioneering work contributed to the overall theory of galactic motion and structure.

**Lippershey, Hans (a.k.a. Jan Lippersheim)** (ca. 1570–1619) Dutch optician who, in 1608, invented and patented a simple, two-lens TELESCOPE. Once the basic concept for this new optical instrument began circulating throughout western Europe, creative persons like GALILEO GALILEI and JOHANNES KEPLER quickly embraced the telescope's role in observational ASTRONOMY and made improved devices of their own design.

**Liwei, Yang** (1965– ) Chinese army officer who became the first TAIKONAUT (ASTRONAUT) from the People's Republic of China on 15 October 2003. He traveled onboard the *SHENZHOU 5* SPACECRAFT as a LONG MARCH 2F ROCKET carried it into ORBIT around EARTH from the Jiuquan Satellite Launch Center. After completing 14 orbits of Earth, Liwei made a successful REENTRY and SOFT LANDING on 16 October in the Chinese portion of Inner Mongolia.

**Lockyer, Sir Joseph Norman** (1836–1920) British physicist who made spectroscopic studies of the SUN (especially SUNSPOTS). In 1868, based on a new line in the SOLAR SPECTRUM (also observed by PIERRE-JULES-CÉSAR JANSSEN), he concluded that the Sun contained a new ELEMENT, which he called HELIUM. This element was not discovered in EARTH'S ATMOSPHERE until 1895.

**Lovell, Sir Alfred Charles Bernard** (1913– ) British radio astronomer who founded and directed the famous Jodrell Bank Experimental Station between 1951 and 1981. It was this RADIO TELESCOPE facility that also recorded the beeping signals from *SPUTNIK 1* and other early Russian SPACECRAFT at the beginning of the Space Age.

**Lovell, James Arthur, Jr.** (1928– ) American ASTRONAUT and U.S. Navy officer who was the commander of the near-fatal NASA *APOLLO 13* mission (1970) to the MOON. Prior to that in-flight aborted LUNAR landing mission, he successfully flew into ORBIT around EARTH with FRANK BORMAN during the *GEMINI 7* mission (1965) and with EDWIN E. “BUZZ” ALDRIN, JR., on the *Gemini 12* mission (1966). Together with Borman and WILLIAM A. ANDERS, Lovell also participated in the historic *Apollo 8* mission (December 1968)—the first human flight to the vicinity of the Moon.

**Lowell, Percival** (1855–1916) American astronomer who used his own money to establish an astronomical OBSERVATORY (the Lowell Observatory) near Flagstaff, Arizona—primarily to support his study of MARS and his aggressive search for signs of an intelligent civilization. Lowell had mistakenly interpreted GIOVANNI VIRGINIO SCHIAPARELLI’s reports of CANALI on the MARTIAN surface as evidence of large, water-bearing canals built by intelligent beings. He was consumed by this search and wrote *Mars and Its Canals* (1906) and *Mars As the Abode of Life* (1908) to express these ideas. Although his nonscientific (but popular) interpretation of observed surface features on Mars was not accurate, his astronomical instincts were quite correct in another quest. Based on PERTURBATIONS in the ORBIT of NEPTUNE, he predicted, in 1915, the existence of a planet-sized TRANS-NEPTUNIAN OBJECT. The tiny DWARF PLANET PLUTO was discovered in 1930 by CLYDE WILLIAM TOMBAUGH while working at the Lowell Observatory.

**Lucid, Shannon W.** (1943– ) American ASTRONAUT who served as a NASA mission specialist on five separate SPACE SHUTTLE flights: STS-51G (June 1985), STS-34 (October 1989), STS-43 (August 1991), and STS-58 (October 1993). She was also the cosmonaut engineer 2 aboard Russia’s *MIR* SPACE STATION (1996)—joining the Russian crew from the space shuttle *Atlantis* (STS-76 mission) in March and returning to EARTH on the space shuttle *Atlantis* (STS-79 mission) after 188 days in ORBIT.

**Lundmark, Knut Emil** (1889–1958) Swedish astronomer who investigated galactic phenomena and suggested that the term



Shannon W. Lucid (Courtesy of NASA)

*SUPERNOVA* be applied to the brightest *NOVAS* observed in other *GALAXIES*.

**Luyten, Willem Jacob** (1899–1994) Dutch-American astronomer who specialized in the detection and identification of *WHITE DWARF STARS*.

**Lyot, Bernard-Ferdinand** (1897–1952) French astronomer who invented the coronagraph in 1930. This device allowed astronomers to study the *CORONA* of the *SUN* in the absence of a *SOLAR ECLIPSE*—thereby greatly advancing the field of *SOLAR* physics.

**Mach, Ernst** (1838–1916) Austrian physicist who investigated the phenomena associated with high-speed flow.

**Magellan, Ferdinand** (1480–1521) Portuguese explorer who, in 1519, became the first person to record the two *DWARF GALAXIES* visible to the *NAKED EYE* in the Southern Hemisphere. These nearby galaxies are now called the *MAGELLANIC CLOUDS* in his honor.

**Maskelyne, Nevil** (1732–1811) British astronomer who served as the fifth *ASTRONOMER ROYAL* (1765–1811) and made significant contributions to the use of astronomical observations in navigation. In 1769, he studied a *TRANSIT* of *VENUS* and used data from this event to calculate the *EARTH-SUN* distance (the *ASTRONOMICAL UNIT*) to within 1 percent of its modern value.

**Mattingly, Thomas K., II** (1936– ) American *ASTRONAUT* and U.S. Navy officer who served as the *SPACECRAFT* pilot during *NASA'S APOLLO 16* *MOON-landing* mission (April 1972) while astronauts *JOHN W. YOUNG* and *CHARLES MOSS DUKE, JR.*, descended to the surface in the *LUNAR MODULE (LM)*. He also commanded the *SPACE SHUTTLE* on the *STS-4* (1982) and *STS-51C* (1985) orbital missions.

**Maxwell, James Clerk** (1831–1879) Scottish theoretical physicist who made many important contributions to physics—including the fundamental concept of *ELECTROMAGNETIC RADIATION*. He made a major contribution to *ASTRONOMY* in 1857 by correctly predicting from theoretical principles alone that the *RINGS* of *SATURN* must consist of numerous small *PARTICLES*.

**McAuliffe, S. Christa Corrigan** (1948–86) American ASTRONAUT and school teacher (NASA Teacher in Space program participant) who died along with the rest of the STS-51L mission crew when the SPACE SHUTTLE *Challenger* exploded during LAUNCH ascent on 28 January 1986.

**McNair, Ronald E.** (1950–86) American ASTRONAUT and NASA mission specialist who successfully traveled in OUTER SPACE during the STS-41B mission of the SPACE SHUTTLE *Challenger* (February 1984) but then lost his life along with the rest of the *Challenger's* crew when the space shuttle vehicle exploded during LAUNCH ascent on 28 January 1986 at the start of the STS-51L mission.

**Messier, Charles** (1730–1817) French astronomer who, in about 1781, compiled a list (now called the MESSIER CATALOGUE) of NEBULAS and STAR CLUSTERS. As an avid COMET hunter, he personally discovered at least 13 new comets and codiscovered perhaps six others. He assembled his list of “unmoving” fuzzy nebulas and star clusters as a tool for those engaged in comet searches, because these celestial objects were often mistaken for comets. He designated each of the approximately 100 entries with a separate number, prefixed by the letter *M*. For example, Messier object M1 is the CRAB NEBULA and M31 is the ANDROMEDA GALAXY. These designations are still used in ASTRONOMY.

**Meton (of Athens)** (ca. 460 B.C.E.–?) Greek astronomer who discovered around 432 B.C.E. that a period of 235 LUNAR months coincides with precisely an interval of 19 YEARS. After each 19-year interval, the PHASES OF THE MOON start taking place on the same days of the year. Both the ancient Greek and Jewish CALENDARS used the METONIC CYCLE, and it became the main calendar of the ancient Mediterranean world until replaced by the JULIAN CALENDAR in 46 B.C.E.

**Michelson, Albert Abraham** (1852–1931) Polish-born, German-American physicist who, in 1878, accurately measured the SPEED OF LIGHT and received the 1907 Nobel Prize in physics for his precise optical measurements. He also collaborated with EDWARD WILLIAMS MORLEY in 1887 to perform an important experiment (now called the Michelson-Morley experiment)



S. Christa Corrigan McAuliffe  
(Courtesy of NASA)

that dispelled the prevailing concept of LIGHT traveling through the UNIVERSE by using an invisible ether as the medium. They could not detect this hypothetical, all-pervading ether. Its absence also provided ALBERT EINSTEIN with important empirical evidence upon which to construct his SPECIAL RELATIVITY theory in 1905.

**Miller, Stanley Lloyd** (1930–2007) American chemist who was a pioneer in the field of ASTROBIOLOGY and the chemical origins of life. In 1953, while a graduate student at the University of Chicago working for HAROLD C. UREY, Miller performed the classic astrobiology experiment now called the Urey-Miller experiment. It involved gaseous mixtures simulating EARTH's primitive ATMOSPHERE. When Miller subjected a “chemical soup” rich in methane, ammonia, CARBON DIOXIDE, and water to an ENERGY source such as an electric spark, the gaseous compounds reacted to produce AMINO ACIDS—the building blocks of proteins in living matter.

**Milne, Edward Arthur** (1896–1950) British astrophysicist who studied the dynamic processes and ENERGY transfer mechanisms in stellar atmospheres.

**Minkowski, Rudolph Leo** (1895–1976) German-American astrophysicist who used SPECTROSCOPY to examine NEBULAS (especially the CRAB NEBULA) and SUPERNOVA remnants. In the mid-1950s, he collaborated with WALTER BAADE in the optical identification of several EXTRAGALACTIC RADIO WAVE sources.

**Mitchell, Edgar Dean** (1930– ) American ASTRONAUT and U.S. Navy officer who served as the LUNAR MODULE (LM) pilot during the APOLLO 14 MOON-landing mission (January–February 1971). Although this was his first NASA SPACE mission, Mitchell immediately became a member of the exclusive Moon walkers club when he accompanied ALAN B. SHEPARD as they explored the Fra Mauro region of the LUNAR surface.

**Mitchell, Maria** (1818–89) American astronomer who achieved international recognition for discovering a COMET in 1847. As the first professionally recognized American woman astronomer, she worked as a human computer for the Nautical Almanac Office of the U.S. government from about 1849 to

1868—carefully performing (by hand) precise calculations for the motions of the PLANET VENUS. From 1865 until her death, she served as a professor of ASTRONOMY at the newly opened Vassar (Female) College in Poughkeepsie, New York, and also directed the school's OBSERVATORY.

**Morgan, William Wilson** (1906–94) American astronomer who performed detailed investigations of large bluish-white STARS (that is, stars having an O-type or B-type SPECTRAL CLASSIFICATION) in the MILKY WAY GALAXY. Morgan then used these data in 1951 to infer the structure of the two nearest galactic spiral arms. Previous to that effort, Morgan collaborated with PHILIP CHILDS KEENAN at YERKES OBSERVATORY and published the *Atlas of Stellar Spectra* in 1943. This work introduced the new, more sophisticated spectral classification system called the MORGAN-KEENAN (MK) CLASSIFICATION SYSTEM.

**Morley, Edward Williams** (1838–1923) American chemist who collaborated with ALBERT ABRAHAM MICHELSON in conducting the classic ether drift experiment of 1887 that led to the collapse of the commonly held (but erroneous) concept that LIGHT needed this invisible ether medium to propagate through OUTER SPACE.

**Newcomb, Simon** (1835–1909) Canadian-born American mathematical astronomer who prepared extremely accurate tables for the movement of SOLAR SYSTEM bodies while working for the Nautical Almanac Office of the U.S. NAVAL OBSERVATORY in the 19th century. In 1860, he presented a paper suggesting that the MAIN-BELT ASTEROIDS did not originate from the disintegration of a single PLANET—as was commonly assumed at the time.

**Newton, Sir Isaac** (1642–1727) The brilliant, though introverted, British physicist and mathematician whose law of GRAVITATION, three laws of motion, development of calculus, and design of a new type of REFLECTING TELESCOPE identify him as one of the greatest scientific minds in human history. Through the patient encouragement and financial support of EDMOND HALLEY, Newton published his great work, *Mathematical Principles of Natural Philosophy* (or *The Principia*), in 1687. This

## BIOGRAPHIES



Hermann J. Oberth (NASA)



Ellison S. Onizuka (Courtesy of NASA)

## BIOGRAPHIES

### Nicholson – Oort

monumental book transformed the practice of physical science and completed the scientific revolution started by NICHOLAS COPERNICUS, JOHANNES KEPLER, and GALILEO GALILEI. *See also* NEWTONIAN TELESCOPE; NEWTON'S LAW OF GRAVITATION; NEWTON'S LAWS OF MOTION.

**Nicholson, Seth Barnes** (1891–1963) American astronomer who discovered several minor MOONS of JUPITER: Sinope (in 1914), Carme (1938), Lysithea (1938), and Ananke (1951).

**Oberth, Hermann J.** (1894–1989) Transylvanian-born German ROCKET scientist who, like KONSTANTIN TSIOLKOVSKY and ROBERT HUTCHINGS GODDARD, helped establish the field of ASTRONAUTICS and vigorously promoted the concept of space travel throughout his life. His inspirational 1923 publication *The Rocket Into Interplanetary Space* provided a comprehensive discussion of all the major aspects of space travel. His 1929 award-winning book *Roads to Space Travel* popularized the concept of space travel for technical and nontechnical readers alike.

**Olbers, Heinrich Wilhelm** (1758–1840) German astronomer who discovered the MAIN-BELT ASTEROIDS PALLAS (1802) and VESTA (1807). He also formulated (in about 1826) the philosophical discussion known as Olbers's paradox—namely, the question, Why isn't the night sky (with its infinite number of STARS), as bright as the surface of the SUN? The contemporary explanation uses the concept of an expanding UNIVERSE within which very distant stars become obscure due to extensive REDSHIFT, which weakens their LIGHT and keeps the night sky dark.

**Onizuka, Ellison S.** (1946–86) American ASTRONAUT and U.S. Air Force officer who served as a NASA mission specialist on the successful Department of Defense-sponsored STS-51C SPACE SHUTTLE *Discovery* mission (January 1985) and then lost his life on 28 January 1986 when the space shuttle *Challenger* exploded during LAUNCH ascent at the start of the fatal STS-51L mission.

**Oort, Jan Hendrik** (1900–92) Dutch astronomer who made pioneering studies of the dimensions and structure of the MILKY WAY GALAXY in the 1920s and proposed, in 1950,

### Nicholson – Oort

that a large swarm of COMETS (now called the OORT CLOUD) circles the SUN at a distance of between 50,000 and 80,000 ASTRONOMICAL UNITS.

**Oparin, Aleksandr Ivanovich** (1894–1980) The Russian biochemist who explored the biochemical origin of life. In the 1920s, Oparin and the British scientist J. B. S. HALDANE suggested that a reducing ATMOSPHERE (one without oxygen) and high doses of ULTRAVIOLET RADIATION might produce organic MOLECULES. The Oparin-Haldane hypothesis implied that life on EARTH slowly emerged from an ancient biochemical soup.

**Öpik, Ernest Julius** (1893–1985) Estonian astronomer with many astronomical interests who gave emphasis to the study of COMETS and METEORIODS. In 1932, after examining the PERTURBATIONS of cometary ORBITS, he suggested that a huge population of cometary NUCLEI might be at a great distance from the SUN (perhaps at about 60,000 ASTRONOMICAL UNITS). He further speculated that the close passage of a ROGUE STAR might perturb this reservoir of icy CELESTIAL BODIES, causing a few new comets to approach the inner SOLAR SYSTEM. JAN HENDRIK OORT revived this idea in 1950. Öpik also developed a theory of ABLATION to describe how meteroids burn up and disintegrate in EARTH'S ATMOSPHERE due to AERODYNAMIC HEATING.

**Payne-Gaposchkin, Cecilia Helena** (1900–79) British-American astronomer who, in 1925, proposed that the ELEMENT HYDROGEN was the most abundant element in STARS and in the UNIVERSE at large. While collaborating with her husband (Russian-American astronomer Sergei Gaposchkin, 1898–1984) in 1938, she published an extensive catalog of VARIABLE STARS.

**Peachy, Eleanor Margaret** (1922– ) *See* BURBIDGE, (ELEANOR) MARGARET.

**Penzias, Arno Allen** (1933– ) German-American physicist who, in the early 1960s, worked with a colleague (ROBERT WOODROW WILSON) at Bell Laboratories to examine natural sources of RADIO WAVE noise that might interfere with COMMUNICATIONS SATELLITES and discovered the COSMIC MICROWAVE BACKGROUND (CMB) in the process. This all-pervading MICROWAVE



BACKGROUND RADIATION at the edge of the observable UNIVERSE is the cooled remnant (~3 K) of the BIG BANG explosion. Their discovery provided cosmologists with empirical evidence of a very hot, explosive phase at the beginning of the universe. Penzias and Wilson shared the 1978 Nobel Prize in physics for this work.

**Perrine, Charles Dillion** (1867–1951) American astronomer who worked on staff at LICK OBSERVATORY from 1893 to 1909 and then served as the director of the Argentine National Observatory (in South America) from 1909 to 1936. Between 1904 and 1905, Perrine discovered two minor MOONS of JUPITER, Himalia and then Elara.

**Piazzi, Giuseppe** (1746–1826) Italian astronomer and monk who discovered the first ASTEROID (OR MINOR PLANET) on 1 January 1801 from the observatory that he founded and directed in Palermo, Sicily. He named the asteroid CERES after the ancient Roman goddess of agriculture and the patroness of Sicily. Observation of this asteroid was then lost in the SUN's glare. However, calculations of its ORBIT by CARL FRIEDRICH GAUSS (based on only three of Piazzi's observations) allowed HEINRICH WILHELM OLBERS to relocate the CELESTIAL BODY in 1802. When Piazzi died, only four asteroids were known. However, his discovery pointed out the existence of the MAIN-BELT ASTEROIDS in the gap between MARS and JUPITER. The 1,000th asteroid was discovered in 1923 and named Piazzia in his honor.

**Picard, Jean** (1620–82) French astronomer and priest whose careful measurement of EARTH's circumference in 1671 (using the length of a degree on the meridian at Paris) provided the first major improvement since ERATOSTHENES OF CYRENE and came quite close to the modern value.

**Pickering, Edward Charles** (1846–1919) American astronomer and older brother of WILLIAM HENRY PICKERING who, from 1877, served as the director of the HARVARD COLLEGE OBSERVATORY (HCO) for over four decades. He supervised the production of the *Henry Draper Catalogue* (by ANNIE JUMP CANNON, WILLIAMINA PATON FLEMING, HENRIETTA SWAN LEAVITT, and others), which listed 225,000 STARS according to their spectra

as defined by the HARVARD CLASSIFICATION SYSTEM. He promoted ASTROPHOTOGRAPHY and, in 1889, discovered the first spectroscopic BINARY (DOUBLE) STAR SYSTEM—two stars so visually close together that they can be distinguished only by the DOPPLER SHIFT of their SPECTRAL LINES.

**Pickering, William Hayward** (1910–2004) New Zealander-American physicist and engineer who directed the Caltech Jet Propulsion Laboratory (JPL) from 1954 to 1976 and supervised the development of many of the highly successful U.S. planetary exploration SPACECRAFT including the first American SATELLITE (*EXPLORER 1*), NASA's *MARINER* spacecraft to VENUS and MARS, NASA's RANGER PROJECT and SURVEYOR PROJECT to the MOON, NASA's VIKING PROJECT to Mars, and the incredible VOYAGER missions to the OUTER PLANETS and beyond.

**Pickering, William Henry** (1858–1938) American astronomer and younger brother of EDWARD CHARLES PICKERING who established an auxiliary astronomical OBSERVATORY for Harvard at Arequipa, Peru, in 1891. He discovered the ninth MOON of SATURN (called Phoebe) in 1898 at this observatory. He published a photographic atlas of the MOON in 1903 using data collected at Harvard's astronomical station on the island of Jamaica. Unfortunately, he became overzealous in interpreting these LUNAR photographs and reported seeing evidence of vegetation and frost. Influenced by such mistaken evidence, he suspected that life-forms might be on the Moon. He also conducted a photographic search for a PLANET beyond NEPTUNE, and he may have even captured an IMAGE of PLUTO in 1919—but failed to recognize it.

**Planck, Max Karl** (1858–1947) German physicist who introduced QUANTUM THEORY in 1900—a powerful new theory concerned with the transport of ELECTROMAGNETIC RADIATION in discrete ENERGY packets or QUANTA. His work represents one of the two great pillars of modern physics (the other being ALBERT EINSTEIN'S RELATIVITY). Planck received the 1918 Nobel Prize in physics for this important accomplishment. *See also* PLANCK'S RADIATION LAW.

**Pogson, Norman Robert** (1829–91) British astronomer who, in 1856, suggested the use of a new, mathematically based



William Hayward Pickering (left) briefing President Johnson (right) (NASA)

scale for describing stellar MAGNITUDES. First, he verified SIR (FREDERICK) WILLIAM HERSCHEL'S discovery that a first-magnitude STAR is approximately 100 times brighter than a sixth-magnitude star—the limit of NAKED EYE observing as originally proposed by HIPPARCHUS OF NICAIA and later refined by PTOLEMY. He then suggested that because an interval of five magnitudes corresponds to a factor of 100 in brightness, a one-magnitude difference in brightness should correspond to the fifth root of 100, or 2.512. Pogson's scale is now universally used in modern ASTRONOMY.

**Poincaré, (Jules) Henri** (1854–1912) The French mathematician who provided astronomers important partial solutions to the challenging three-body and  $n$ -body problems in CELESTIAL MECHANICS. His pioneering work in orbital motion prediction paved the way for the development of more efficient digital computer-based computational solutions.

**Pond, John** (1767–1836) British astronomer who was appointed as the sixth ASTRONOMER ROYAL in 1811. He served in this position until 1835, upgrading the ROYAL GREENWICH OBSERVATORY with new instruments and publishing a very accurate STAR catalog in 1833.

**Pons, Jean** (1761–1831) French astronomer who was an avid comet hunter, discovering (or codiscovering) 37 COMETS between 1801 and 1827—a number that represents a personal observing record in ASTRONOMY and about 75 percent of all comets discovered within that period.

**Ptolemy (a.k.a. Claudius Ptolemaeus)** (ca. 100–ca. 170 C.E.) Greek astronomer living in Alexandria, Egypt who wrote (in about 150 C.E.) *Syntaxis* (The great mathematical compilation)—a compendium of astronomical and mathematical knowledge from all the great Greek philosophers and astronomers. His book preserved the Greek GEOCENTRIC COSMOLOGY in which EARTH was considered the unmoving center of the UNIVERSE while the wandering PLANETS and FIXED STARS revolved around it. Arab astronomers translated the book in about 820 C.E., calling it *ALMAGEST (Greatest)*. The PTOLEMAIC SYSTEM remained essentially unchallenged in western thinking

until NICHOLAS COPERNICUS and the start of the scientific revolution in the 16th century.

**Pythagoras** (ca. 580 B.C.E.–ca. 500 B.C.E.) Greek philosopher and mathematician who taught that EARTH was a perfect sphere at the center of the UNIVERSE and that the PLANETS and STARS moved in circles around it. His thoughts influenced Greek COSMOLOGY and western thinking for centuries. However, they arose primarily from his mystical belief that the circle was a perfect form rather than via careful observation. Although NICHOLAS COPERNICUS successfully challenged GEOCENTRIC cosmology in the 16th century, JOHANNES KEPLER displaced the concept of circular ORBITS for the planets early in the 17th century.

**Reber, Grote** (1911–2002) American radio engineer who built the world's first RADIO TELESCOPE in his backyard in 1937 and for several years thereafter was the world's only practicing radio astronomer. His steerable, approximately 10 m diameter, parabolic dish antenna detected many radio sources, including the RADIO WAVE signals in the CONSTELLATION Sagittarius from the direction of the center of the MILKY WAY GALAXY—confirming KARL GUTHE JANSKY's discovery in the early 1930s.

**Rees, Sir Martin John** (1942– ) British astrophysicist who investigated the nature of the DARK MATTER of the UNIVERSE and was appointed the 15th ASTRONOMER ROYAL in 1995.

**Reinmuth, Karl** (1892–1979) German astronomer who discovered the 1.4 km diameter ASTEROID that came within 10 million km (about 0.07 ASTRONOMICAL UNIT) of EARTH in 1932. Called Apollo, this asteroid now gives its name to the APOLLO GROUP of NEAR-EARTH ASTEROIDS whose ORBITS cross Earth's orbit around the SUN.

**Resnik, Judith A.** (1949–86) American ASTRONAUT and NASA mission specialist who successfully traveled into ORBIT around EARTH during the SPACE SHUTTLE *Discovery's* STS-41D mission (1984) but then lost her life when the space shuttle *Challenger* exploded during LAUNCH ascent on 28 January 1986 at the start of the STS-51L mission.

**Richer, Jean** (1630–96) French astronomer who led a scientific expedition to Cayenne, French Guiana, in 1671 that provided careful measurements of MARS at the same time GIOVANNI DOMENICO CASSINI was making similar observations in France. These simultaneous observations supported the first adequate PARALLAX of Mars and enabled Cassini to calculate the distance from EARTH to Mars, leading to improved dimensions for the SOLAR SYSTEM that closely approached modern values. On this expedition, Richer also made geophysical observations with a pendulum that eventually allowed SIR ISAAC NEWTON to discover the OBLATENESS of Earth.

**Ride, Sally K.** (1951– ) American ASTRONAUT and NASA mission specialist who was the first American woman to travel in OUTER SPACE. She did this as a crew member on the STS-7 mission of the SPACE SHUTTLE *Challenger*, which lifted off from the KENNEDY SPACE CENTER on 18 June 1983. She flew again in space as a crew member on the STS-41G mission of space shuttle *Challenger* (1984). She also served as a member of the presidential commission that investigated the *CHALLENGER* ACCIDENT (January 1986).

**Roche, Edouard Albert** (1820–83) French mathematician who calculated how close a natural SATELLITE can orbit around its parent PLANET (PRIMARY BODY) before the influence of GRAVITY creates tidal FORCES that rip the MOON apart, creating a RING of debris. By assuming the planet and its satellite have the same DENSITY, he calculated that this limit (called the ROCHE LIMIT) occurs when the moon is at a distance of approximately 2.5 times the radius of the planet or less.

**Roemer, Olaus Christensen (a.k.a. Ole Römer)** (1644–1710) Danish astronomer who, while working at the PARIS OBSERVATORY with GIOVANNI DOMENICO CASSINI, noticed time discrepancies for successive predicted ECLIPSES of the MOONS of JUPITER and correctly concluded that LIGHT must have a finite VELOCITY. He then attempted to calculate the SPEED OF LIGHT in 1675. However, his numerical results (about 227,000 km/s) were lower than the currently accepted value (299,792 km/s) mainly because of the inaccuracies in accepted SOLAR SYSTEM distances at that time.

**Roentgen, Wilhelm Conrad (also spelled Röntgen) (1845–1923)**

The German physicist who started world-changing revolutions in physics, ASTRONOMY, and medicine when he discovered X-RAYS in 1895.

**Roosa, Stuart Allen (1933–94)** American ASTRONAUT and U.S. Air

Force officer who served as the Apollo SPACECRAFT pilot during the *Apollo 14* MOON-landing mission (1971). He remained in LUNAR ORBIT as fellow APOLLO PROJECT astronauts ALAN B. SHEPARD and EDGAR DEAN MITCHELL explored the lunar surface in the Fra Mauro region.

**Rosse, third earl of (a.k.a. William Parsons) (1800–67)** Irish

astronomer who used his personal wealth to construct a massive 1.8 m diameter (72 in) REFLECTING TELESCOPE on his family castle grounds in Ireland. Although located in a geographic region poorly suited for observation, the earl engaged in ASTRONOMY as a hobby and used his giant TELESCOPE (the largest in the world at the time) to detect and study “fuzzy spiral NEBULAS” (many of which were later identified as SPIRAL GALAXIES). He gave the CRAB NEBULA its name in 1848 and also made detailed observations of the ORION NEBULA.

**Rossi, Bruno Benedetto (1905–93)** Italian-American physicist and astronomer who investigated the fundamental nature of COSMIC RAYS in the 1930s and then collaborated with RICCARDO GIACCONI and others in the 1962 discovery of X-RAY sources outside the SOLAR SYSTEM using SENSORS carried into OUTER SPACE by SOUNDING ROCKETS. NASA named a scientific SATELLITE launched in 1995 the *Rossi X-ray Timing Explorer (RXTE)* in his honor.

**Russell, Henry Norris (1877–1957)** American astronomer who collaborated in 1913 with EJNAR HERTZSPRUNG in the development of the HERTZSPRUNG-RUSSELL (H-R) DIAGRAM that is of fundamental importance in understanding the theory of STELLAR EVOLUTION. In 1928, he performed a detailed analysis of the SUN’S SPECTRUM—showing HYDROGEN as its major constituent but also noting the presence of other ELEMENTS and their relative abundances.

**Ryle, Sir Martin** (1918–84) British radio astronomer who established a center for RADIO ASTRONOMY at Cambridge University after World War II and developed (in about 1960) the technique of APERTURE SYNTHESIS. He shared the 1974 Nobel Prize in physics with ANTONY HEWISH for the discovery of the PULSAR and their pioneering techniques in radio astronomy, including the use of aperture synthesis. He also served from 1972 to 1982 as the 12th ASTRONOMER ROYAL.

**Sagan, Carl Edward** (1934–96) American astronomer and science writer who investigated the origin of life on EARTH and the possibility of EXTRATERRESTRIAL LIFE. In the early 1960s, he suggested that a RUNAWAY GREENHOUSE effect could be operating on VENUS. In the 1970s and beyond, he used his collection of popular books and a television series (*Cosmos*) to communicate science effectively, especially ASTRONOMY and ASTROPHYSICS, to the general public.

**Sanger, Eugen** (1905–64) Austrian ASTRONAUTICS pioneer who envisioned ROCKET planes and reusable space transportation systems in the 1920s and 1930s—a technical vision partially fulfilled by NASA’S SPACE SHUTTLE half a century later. During World War II, he directed a rocket research program for the German Air Force and focused his attention on a long-range, winged rocket bomber that could travel intercontinental distances by skipping in and out of EARTH’S ATMOSPHERE.

**Scheiner, Christoph** (1573–1650) German mathematician, astronomer, and Jesuit priest who, independently of GALILEO GALILEI, designed and used his own TELESCOPE to observe the SUN, discovering SUNSPOTS in 1611. By attempting to preserve ARISTOTLE’S hypothesis of the immutable (unchanging) heavens, Scheiner interpreted the sunspots as being small SATELLITES that encircled the Sun as opposed to changing, moving features of the Sun itself. This interpretation stirred up a great controversy with Galileo, who vigorously endorsed the Copernican revolution in ASTRONOMY.

**Schiaparelli, Giovanni Virginio** (1835–1910) Italian astronomer who carefully observed MARS in the 1870s and made a detailed map of its surface, including some straight markings that he described as CANALI, meaning channels (in Italian).

Unfortunately, when translated into English as *canals*, some astronomers (like PERCIVAL LOWELL) completely misunderstood Schiaparelli's meaning and launched a frantic observational search for canals—as the presumed artifacts of an intelligent alien civilization. He also worked on the relationship between METEOR showers and the passage and/or disintegration of COMETS.

**Schirra, Walter M.** (1923–2007) American ASTRONAUT and U.S. Navy officer who was selected as one of NASA's original seven astronauts and is the only one to have traveled into OUTER SPACE in all three 1960s programs: the MERCURY PROJECT, the GEMINI PROJECT, and the APOLLO PROJECT.

**Schmidt, Maarten** (1929– ) Dutch-American astronomer who discovered the first QUASAR in 1963. The quasar had an enormous REDSHIFT in its SPECTRUM, indicating the very distant object was traveling away from EARTH at more than 15 percent of the SPEED OF LIGHT.

**Schmitt, Harrison H.** (1935– ) American ASTRONAUT and former U.S. senator who was a member of the APOLLO 17 LUNAR-landing mission (December 1972). He and EUGENE A. CERNAN became the last human beings to walk on the MOON in the 20th century. They explored the Taurus-Littrow region of the lunar surface.

**Schriever, Bernard** (1913–2005) American U.S. Air Force officer and engineer who supervised the rapid development of the ATLAS, THOR, and TITAN BALLISTIC MISSILES during the COLD WAR. He created and applied an innovative systems engineering approach that saved a great deal of development time. His ROCKETS not only served the United States in the area of national defense, they also supported the SPACE LAUNCH VEHICLE needs of NASA and the civilian space exploration community.

**Schwabe, Samuel Heinrich** (1789–1875) German pharmacist and amateur astronomer who made systematic observations of the SUN for many years while searching for a hypothetical PLANET (VULCAN) that traveled around the Sun inside the ORBIT of MERCURY. Instead of this fictitious planet, he discovered that SUNSPOTS have a cycle of about 11 years or so. He announced



Schiaparelli image on a Hungarian stamp (Courtesy of author)



his findings in 1843 and eventually received recognition for this discovery in the 1860s.

**Schwarzschild, Karl** (1873–1916) German astronomer who applied RELATIVITY theory to very high-DENSITY objects and point masses (SINGULARITIES). In 1916, he introduced the concept of the SCHWARZSCHILD RADIUS—the zone (or EVENT HORIZON) around a superdense, gravitationally collapsing STAR from which nothing, not even LIGHT, can escape. His work marks the start of BLACK HOLE ASTROPHYSICS.

**Scobee, Francis R.** (1939–86) American ASTRONAUT and U.S. Air Force officer who successfully flew into OUTER SPACE as the pilot of the SPACE SHUTTLE *Challenger* on the STS-41C mission (April 1984) and then as commander during the STS-51L mission was killed on 28 January 1986 when the space shuttle *Challenger* exploded during LAUNCH ascent.

**Scott, David R.** (1932– ) American ASTRONAUT and U.S. Air Force officer who participated in the GEMINI PROJECT and APOLLO PROJECT and traveled to the MOON during the *Apollo 15* mission (1971). In this successful LUNAR landing mission, he and astronaut JAMES BENSON IRWIN used an electric-battery powered LUNAR ROVER vehicle for the first time.

**Secchi, Pietro Angelo** (1818–78) Italian astronomer and Jesuit priest who was the first to apply SPECTROSCOPY to ASTRONOMY systematically. By 1863, he completed the first major spectroscopic survey of the STARS and published a catalog containing the SPECTRA of more than 4,000 stars. After examining these data, he proposed (in 1867) that such stellar spectra can be divided into four basic classes—the Secchi classification system. His pioneering work eventually evolved into the HARVARD CLASSIFICATION SYSTEM and to an improved understanding of STELLAR EVOLUTION. He also pursued advances in ASTROPHOTOGRAPHY by photographing SOLAR ECLIPSES to assist in the study of solar phenomena such as PROMINENCES.

**Seyfert, Carl Keenan** (1911–60) American astronomer who, in 1943, discovered a special group of SPIRAL GALAXIES now known as SEYFERT GALAXIES.

**Shapley, Harlow** (1885–1972) American astronomer who used a detailed study of VARIABLE STARS (especially CEPHEID VARIABLES) in about 1914 to establish more accurate dimensions for the MILKY WAY GALAXY and to discover that the SUN was actually two-thirds of the way out in the rim of this SPIRAL GALAXY—some 30,000 LIGHT-YEARS from its center. Up until then, astronomers thought the Sun was located near the center of the galaxy. In 1920, he engaged in a public debate with HEBER DOUST CURTIS concerning the nature of distant spiral NEBULAS, which Shapley originally believed were either part of this galaxy or very close neighbors. He also studied the MAGELLANIC CLOUDS and CLUSTERS OF GALAXIES.

**Shepard, Alan B., Jr.** (1923–98) American astronaut and U.S. Navy officer who was the first American to travel into OUTER SPACE on 5 May 1961 on the MERCURY PROJECT-REDSTONE ROCKET suborbital mission. As one of the original seven Mercury Project astronauts, he rode for about 15 minutes in his tiny *Freedom 7* SPACECRAFT on a BALLISTIC TRAJECTORY and was recovered about 450 km downrange from CAPE CANAVERAL in the Atlantic Ocean. He made a second, much longer journey into space in 1971 as the commander of the *APOLLO 14* MOON-landing mission. Together with EDGAR DEAN MITCHELL, he explored the LUNAR surface in the Fra Mauro region (February 1971).

**Slayton, Deke, Jr.** (1924–93) American ASTRONAUT who was selected as one of the original seven MERCURY PROJECT astronauts and who traveled into OUTER SPACE as part of the first cooperative international RENDEZVOUS and DOCKING mission, the APOLLO-SOYUZ TEST PROJECT (July 1975).

**Slipher, Earl Carl** (1883–1964) American astronomer and brother of VESTO MELVIN SLIPHER who contributed to advances in ASTROPHOTOGRAPHY, especially innovative techniques to produce high-quality IMAGES of MARS, JUPITER, and SATURN.

**Slipher, Vesto Melvin** (1875–1969) American astronomer and brother of EARL CARL SLIPHER who began spectroscopic studies in 1912 of the LIGHT from spiral NEBULAS (now recognized as GALAXIES) and observed DOPPLER SHIFT (REDSHIFT) phenomena—suggesting that these objects were receding from



Alan B. Shepard, Jr. (Courtesy of NASA)

EARTH at very high speed. His work provided the foundation upon which EDWIN POWELL HUBBLE and others developed the concept of an expanding UNIVERSE.

**Smith, Michael J.** (1945–1986) American ASTRONAUT and U.S. Navy officer who served as the pilot on the STS-51L mission of the SPACE SHUTTLE *Challenger*—a fatal mission in which the launch vehicle exploded shortly after LIFTOFF, claiming the lives of Smith and the other six crew members on 28 January 1986.

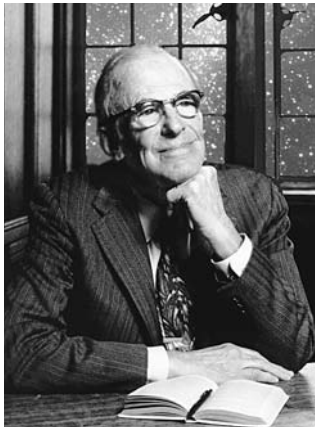

Lyman Spitzer, Jr. (NASA/  
Denise Applewhite/Princeton)

**Spitzer, Lyman, Jr.** (1914–1997) The American astrophysicist who championed the concept of large space-based observatories. In addition to promoting SPACE-BASED ASTRONOMY, Spitzer made major contributions in the areas of stellar dynamics, PLASMA physics, and thermonuclear FUSION. In 2003, NASA successfully launched a large, space-based INFRARED RADIATION observatory and named it the *SPITZER SPACE TELESCOPE*.

**Stafford, Thomas P.** (1930– ) American ASTRONAUT and U.S. Air Force officer who flew into OUTER SPACE as the pilot on NASA's *GEMINI 6* mission (December 1965), as the commander on the *Gemini 9* mission (June 1966), as the commander of the *APOLLO 10* mission (May 1969), and finally as U.S. commander of the APOLLO-SOYUZ TEST PROJECT (July 1975). The *Apollo 10* crew traveled to the MOON and demonstrated all the operational steps for a landing mission while in LUNAR ORBIT except the actual physical landing on the lunar surface—that mission and historic moment were assigned by NASA to the crew of *Apollo 11*.

**Stefan, Josef** (1835–93) Austrian physicist who, in about 1879, experimentally demonstrated that the ENERGY radiated per unit time by a BLACKBODY was proportional to the fourth power of the body's ABSOLUTE TEMPERATURE. In 1884, LUDWIG BOLTZMANN provided the theoretical foundations for this relationship. They collaborated on the formulation of the STEFAN-BOLTZMANN LAW—a physical principle of great importance to astronomers and astrophysicists.

**Struve, Friedrich Georg Wilhelm** (1793–1864) German-Russian astronomer and father of OTTO WILHELM STRUVE who set up the Pulkovo Observatory near St. Petersburg, Russia, in the

mid-1830s and spent many years investigating and cataloging BINARY (DOUBLE) STAR SYSTEMS. In about 1839, he made one of the early attempts to quantify INTERSTELLAR distances by measuring the PARALLAX of the STAR Vega.

**Struve, Otto** (1897–1963) Russian-American astronomer and great-grandson of FRIEDRICH GEORG WILHELM STRUVE who investigated STELLAR EVOLUTION and was a strong proponent for the existence of EXTRASOLAR PLANETS, especially around SUNLIKE STARS. As the childless son of Ludwig Struve, his death in 1963 ended the famous four-generation Struve family dynasty in ASTRONOMY.

**Struve, Otto Wilhelm** (1819–1905) Russian-born German astronomer and son of FRIEDRICH GEORG WILHELM STRUVE who succeeded his father as director of the Pulkovo Observatory and continued the study of BINARY (DOUBLE) STAR SYSTEMS, adding some 500 new binary systems to the list. He had two sons who were also astronomers. Hermann Struve (1854–1920) became director of the Berlin Observatory. Ludwig Struve (1858–1920) became a professor of ASTRONOMY at Kharkov University (Ukraine).

**Sullivan, Kathryn D.** (1951– ) American ASTRONAUT and NASA mission specialist who became the first American woman to perform an EXTRAVEHICULAR ACTIVITY (EVA). This space walk occurred during the STS-41G mission of the SPACE SHUTTLE *Challenger* in October 1984. She traveled again in OUTER SPACE as part of the STS-31 mission (1990) during which the space shuttle *Discovery* crew deployed the *HUBBLE SPACE TELESCOPE* and as part of the STS-45 mission (1992) during which space shuttle *Atlantis* performed EARTH-observing experiments.

**Swigert, John Leonard "Jack," Jr.** (1931–82) American ASTRONAUT who flew as part of NASA'S *APOLLO 13* mission to the MOON (April 1970). An explosion within the Apollo SPACECRAFT service module some 55 hours into the translunar flight forced the crew to reconfigure the LUNAR MODULE (LM) into a lifeboat. Any attempt at landing in the programmed Fra Mauro area was aborted. Although a spaceflight rookie, his skillful response to this serious in-flight emergency helped

fellow astronauts JAMES ARTHUR LOVELL, JR., and FRED WALLACE HAISE, JR., survive this perilous journey and return safely to EARTH.

**Taylor, Joseph H., Jr.** (1941– ) The American radio astronomer who codiscovered the first binary pulsar, called PSR 1913 + 16. In 1974, Taylor together with his then graduate student RUSSELL A. HULSE detected a pair of NEUTRON STARS in a close BINARY STAR SYSTEM. Taylor and Hulse shared the 1993 Nobel Prize in physics for their work, which provided scientists with a very special natural laboratory in OUTER SPACE for investigating the modern theory of GRAVITY and the validity of ALBERT EINSTEIN's general theory of RELATIVITY.

**Tereshkova, Valentina** (1937– ) Russian COSMONAUT who was the first woman to travel in OUTER SPACE. She accomplished this feat on 16 June 1963 by riding the *VOSTOK 6* SPACECRAFT into ORBIT. During her mission, she completed 48 orbits of EARTH. Upon her return, she was awarded the Order of Lenin and made a hero of the (former) Soviet Union.

**Thomson, William** *See* KELVIN, BARON WILLIAM THOMSON.

**Titius, Johann Daniel** (1729–96) German astronomer who, in 1766, was the first to notice an EMPIRICAL relationship describing the distances of the six known PLANETS from the SUN. JOHANN ELERT BODE later popularized this empirical relationship which has become alternately called Bode's law or the Titius-Bode law.

**Titov, Gherman S.** (1935–2000) Russian COSMONAUT who was the second person to travel in ORBIT around EARTH. In August 1961, his *VOSTOK 2* SPACECRAFT made 17 orbits of the PLANET, during which he became the first of many space travelers to experience SPACE SICKNESS.

**Tombaugh, Clyde William** (1906–97) American astronomer who discovered the DWARF PLANET PLUTO on 18 February 1930 while working as an assistant at the Lowell Observatory. He used the blinking comparator (an innovative approach to ASTROPHOTOGRAPHY based on the difference in photographic IMAGES taken a few days apart) to detect the elusive TRANS-NEPTUNIAN OBJECT (TNO) whose existence had been

## Tsiolkovsky – Ulugh

predicted by PERCIVAL LOWELL. He continued to use the comparative technique for the next decade or so to find many new ASTEROIDS, STAR CLUSTERS, and CLUSTERS OF GALAXIES.

**Tsiolkovsky, Konstantin Eduardovich** (1857–1935) Russian SPACE travel pioneer who is regarded as one of the three founding fathers of ASTRONAUTICS—the other two technical visionaries being ROBERT HUTCHINGS GODDARD and HERMANN J. OBERTH. Tsiolkovsky was a nearly deaf schoolteacher in an obscure rural town within czarist Russia. Yet, despite the physical handicap and remote location, his writings accurately projected future space technologies. In 1895, he published the book *Dreams of Earth and Sky*, in which he discussed the concept of an ARTIFICIAL SATELLITE orbiting EARTH. Many of the most important principles of astronautics appeared in his seminal 1903 work *Exploration of Space by Reactive Devices*. This book linked the use of the ROCKET to space travel and even introduced a design for a LIQUID-PROPELLANT ROCKET ENGINE, using LIQUID HYDROGEN and LIQUID OXYGEN as its chemical PROPELLANTS. His 1924 work *Cosmic Rocket Trains* introduced the concept of the MULTISTAGE ROCKET. Although he never personally constructed any of the rockets proposed in his visionary books, these works inspired many future rocket scientists, including SERGEI KOROLEV, whose powerful rockets did place the world's first artificial satellite (*SPUTNIK 1*) into ORBIT in 1957.

**Ulugh, Beg (a.k.a. Muhammed Targai)** (1394–1449) Mongol astronomer, mathematician, and prince (the grandson of the conqueror Timur) who, in about 1420, began developing a great OBSERVATORY in the city of Samarkand (in modern Uzbekistan). By using large instruments, he and his staff carefully observed the positions of the SUN, MOON, PLANETS, and 994 FIXED STARS, publishing an accurate STAR catalog in 1437 called the *Zij-i Sultani*—the first improved listing of stellar positions and MAGNITUDES since PTOLEMY. Following the death, in 1447, of his father the king, he briefly served as ruler over the region but was assassinated by his own son ('Abd al-Latif) in 1449. With his politically inspired

## Tsiolkovsky – Ulugh

## BIOGRAPHIES



Russian stamp portraying Konstantin E. Tsiolkovsky (the author)

## BIOGRAPHIES

## BIOGRAPHIES

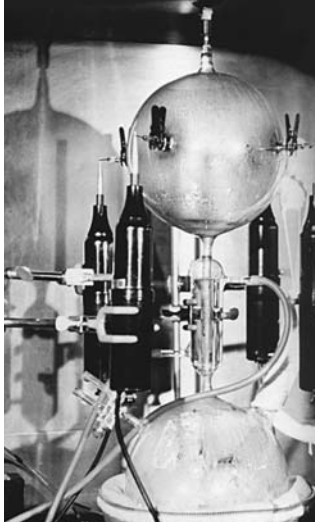

Apparatus for Urey-Miller experiment (NASA)



Stamp from Monaco honoring Jules Verne (the author)

## BIOGRAPHIES

### Urey –Vogel

murderer died Mongol ASTRONOMY and the greatest astronomer of the time.

**Urey, Harold Clayton** (1893–1981) American chemist and early astrobiologist who investigated the possible origins of life on EARTH from a chemical perspective and summarized some of his concepts in the 1952 book *The Planets: Their Origin and Development*. In 1953, together with his student STANLEY MILLER, he performed a classic EXOBIOLGY experiment (the Urey-Miller experiment) in which gaseous mixtures, simulating Earth's primitive ATMOSPHERE, were subjected to ENERGY sources (such as ULTRAVIOLET RADIATION and lightning discharges). AMINO ACIDS (life-forming organic compounds) formed. He had previously been awarded the Nobel Prize in chemistry in 1934 for his discovery of DEUTERIUM. He played a key research role in the American atomic bomb development program (called the Manhattan Project) during World War II.

**Van Allen, James Alfred** (1914–2006) American physicist and pioneering space scientist whose instruments on the first U.S. SATELLITE (*EXPLORER 1*) detected EARTH'S TRAPPED RADIATION BELTS—zones of magnetically trapped atomic PARTICLES now called the VAN ALLEN RADIATION BELTS in his honor. Following World War II, he performed space environment-related research through the use of SOUNDING ROCKETS. He assisted NASA in the development of scientific instrument PAYLOADS for many of the American satellites that were launched in the early 1960s.

**Verne, Jules** (1828–1905) French writer and technical visionary who created modern science fiction and its dream of SPACE travel with his classic 1865 novel *From the Earth to the Moon*, an acknowledged source of youthful inspiration for KONSTANTIN EDUARDOVICH TSIOLKOVSKY, ROBERT HUTCHINGS GODDARD, HERMANN J. OBERTH, and WERNHER VON BRAUN.

**Vogel, Hermann Carl** (1841–1907) German astronomer who performed spectroscopic analyses of STARS that supported the study of STELLAR EVOLUTION and used DOPPLER SHIFT measurements to obtain their radial velocities. In the course of this work in the late 1880s, he was the first to detect spectroscopic BINARY (DOUBLE) STAR SYSTEMS.

### Urey –Vogel

**Von Kármán, Theodore** (1881–1963) Hungarian-American mathematician and research engineer who pioneered the application of advanced mathematics in aerodynamics and ASTRONAUTICS. In 1944, he cofounded Caltech's Jet Propulsion Laboratory and initiated research on both solid- and liquid-propellant ROCKETS. This laboratory would eventually create some of NASA's most successful deep-space exploration SPACECRAFT. In 1963, President JOHN F. KENNEDY awarded him the first National Medal of Science.

**Von Neumann, John** (1903–57) Hungarian-born, German-American mathematician who made significant contributions to nuclear physics, game theory, and computer science. He was selected by the U.S. Air Force in 1953 to chair a special panel of experts who evaluated the American strategic BALLISTIC MISSILE program in the face of an anticipated Soviet ballistic missile threat. As a result of the recommendations from von Neumann's panel, President DWIGHT D. EISENHOWER gave strategic ballistic missile development the highest national priority. General BERNARD SCHRIEVER was tasked with creating an operational ATLAS INTERCONTINENTAL BALLISTIC MISSILE (ICBM) as quickly as possible.

**Webb, James Edwin** (1906–1992) The second Administrator for NASA who served from 14 February 1961 to 7 October 1968. During his tenure, Webb directed the civilian space agency through the turbulent APOLLO PROJECT era. Deeply troubled by the APOLLO 1 TRAGEDY, he retired just a few months before the first human landing on the MOON (July 1969). Webb not only guided a highly successful human spaceflight program (including the MERCURY PROJECT, GEMINI PROJECT, and Apollo Project), but also supported the development of innovative ROBOT SPACECRAFT that accomplished the first American missions to VENUS and MARS. In his honor, NASA has named a new space-based observatory planned for launch in 2013 the JAMES WEBB SPACE TELESCOPE.

**Weizsäcker, Carl Friedrich Baron** (1912–2007) German theoretical physicist who, in 1938, (independent of the work of HANS ALBRECHT BETHE) suggested that STARS derive their ENERGY from a chain of thermonuclear FUSION reactions, primarily by joining HYDROGEN into HELIUM in a process called the CARBON



James E. Webb (NASA)



CYCLE. Reviving (in part) some of the 18th-century work of IMMANUEL KANT and PIERRE SIMON DE MARQUIS LAPLACE, in 1944 he developed a 20th-century version of the NEBULA hypothesis in an attempt to explain how the SOLAR SYSTEM might have formed from an ancient cloud of INTERSTELLAR gas and dust. One of the consequences of his modern version of this hypothesis is that stars with PLANETS are a normal part of STELLAR EVOLUTION.

**Whipple, Fred Lawrence** (1906–2004) American astronomer who proposed in 1949 the dirty snowball hypothesis for COMET NUCLEI, a hypothesis confirmed when the *GIOTTO* SPACECRAFT encountered COMET HALLEY at close range in March 1986.

**White, Edward H., II** (1930–67) American ASTRONAUT and U.S. Air Force officer who performed the first EXTRAVEHICULAR ACTIVITY (EVA) from an orbiting American SPACECRAFT (*GEMINI 4* mission on 3 June 1965) and then died in the flash fire that consumed the interior of the APOLLO PROJECT spacecraft during a training test on the LAUNCH PAD at CAPE CANAVERAL on 27 January 1967. His fellow Apollo astronauts VIRGIL “GUS” I. GRISSOM and ROGER B. CHAFFEE also perished in this fatal accident.

**Wildt, Rupert** (1905–76) German-American astronomer who performed detailed spectroscopic studies of the ATMOSPHERES of JUPITER and SATURN in the 1930s that suggested the presence of methane and ammonia.

**Williams, Sunita L.** (1965– ) The NASA ASTRONAUT who served as a flight engineer aboard the *INTERNATIONAL SPACE STATION (ISS)*. On 9 December 2006, she traveled to the *ISS* aboard the SPACE SHUTTLE *Discovery* during the STS-116 mission, docking with the SPACE STATION on December 11, and becoming a member of the Expedition 14 crew. While in ORBIT on the station, Williams established a world record for female space travelers with four EXTRAVEHICULAR ACTIVITIES (EVAs), totaling 29 hours and 17 minutes of SPACE WALKING. She completed her work on the space station as a member of the Expedition 15 crew and then returned to EARTH aboard the space shuttle *Atlantis*, which touched down at Edwards Air Force Base, California on 22 June 2007 at the conclusion of the STS-117

mission. By traveling 195 days in OUTER SPACE, Williams also broke the existing world record for long duration spaceflight by a female. Astronaut SHANNON LUCID held the previous record of 188 days.

**Wilson, Robert Woodrow** (1936– ) American physicist who collaborated with ARNO ALLEN PENZIAS at Bell Laboratories in the mid-1960s and detected the COSMIC MICROWAVE BACKGROUND (CMB) radiation, a discovery providing EMPIRICAL evidence supporting the BIG BANG theory and for which he and Penzias were awarded the 1978 Nobel Prize for physics.

**Wolf, Johann Rudolph** (1816–93) Swiss astronomer and mathematician who counted SUNSPOTS and sunspot groups to confirm SAMUEL HEINRICH SCHWABE's work and discovered that the period of the sunspot cycle was approximately 11 years. He was also one of several observers who noticed the relationship between sunspot number and SOLAR ACTIVITY. He became director of the Bern Observatory in 1847. In 1849, he formalized his system for describing solar activity by counting sunspots and sunspot groups, a system formerly referred to as Wolf's sunspot numbers and now called the relative sunspot number.

**Wolf, Maximilian "Max" Franz Joseph Cornelius** (1863–1932) German astronomer who pioneered the use of ASTROPHOTOGRAPHY to search for ASTEROIDS. He discovered more than 200 MINOR PLANETS, including asteroid Achilles in 1906, the first of the TROJAN GROUP of asteroids that move around the SUN in JUPITER'S ORBIT 60 degrees ahead of and 60 degrees behind the GIANT PLANET.

**Woolley, Sir Richard van der Riet** (1906–86) British astronomer who investigated stellar and SOLAR ATMOSPHERES, GLOBULAR CLUSTERS, and STELLAR EVOLUTION. He also served as the 11th ASTRONOMER ROYAL from 1956 to 1971.

**Worden, Alfred Merrill** (1932– ) American ASTRONAUT and U.S. Air Force officer who served as the command module pilot during NASA's *Apollo 15* LUNAR landing mission (July–August 1971). While astronauts DAVID R. SCOTT and JAMES BENSON

IRWIN explored the MOON's surface in the HADLEY RILLE area, he orbited overhead in the APOLLO PROJECT SPACECRAFT.

**Young, John W.** (1930– ) American ASTRONAUT and U.S. Navy officer who traveled in OUTER SPACE on six separate NASA missions, starting with the first crewed GEMINI PROJECT flight (*Gemini 3*), which he flew with VIRGIL "GUS" I. GRISSOM on 23 March 1965. After the *Gemini 10* flight (July 1966), he traveled to the MOON as part of the *Apollo 10* mission (May 1969), a key rehearsal mission that orbited the Moon and completed all appropriate APOLLO PROJECT operations just short of landing on the surface. Then, in April 1972, he served as the commander of the *Apollo 16* Moon-landing mission and walked on the LUNAR surface with CHARLES MOSS DUKE, JR. As a tribute to his astronaut skills, NASA selected him to command the SPACE SHUTTLE *Columbia* on the inaugural mission (STS-1) of the SPACE TRANSPORTATION SYSTEM (April 1981). He returned to space for the sixth time as the commander of the space shuttle *Columbia* during the STS-9 mission (1983), which was the first flight of the EUROPEAN SPACE AGENCY'S *SPACELAB*.

**Zucchi, Niccolo** (1586–1670) Italian astronomer, instrument maker, and Jesuit priest who made high-quality early TELESCOPES in the early 17th century, including one of the earliest known REFLECTING TELESCOPES in about 1616. He personally provided JOHANNES KEPLER with one of his telescopes and reported observing colored belts and spots on JUPITER in 1630 (most likely its GREAT RED SPOT) and spots on MARS (about 1640).

**Zwicky, Fritz** (1898–1974) Swiss astronomer who, while collaborating with WALTER BAADE on SUPERNOVA phenomena in 1934, postulated the creation of a NEUTRON STAR as a result of a supernova explosion. He published an extensive catalog of GALAXIES and CLUSTERS OF GALAXIES in the 1960s.

---

SECTION THREE

# CHRONOLOGY

## CHRONOLOGY

ca. 3000 B.C.E. – ca. 350 B.C.E.

- ca. 3000 B.C.E. (to perhaps 1000 B.C.E.) ● STONEHENGE erected on the Salisbury Plain of southern England (possible use: ancient astronomical CALENDAR for prediction of summer SOLSTICE)
- ca. 1300 B.C.E. ● Egyptian astronomers recognize all the PLANETS visible to the NAKED EYE (MERCURY, VENUS, MARS, JUPITER, and SATURN); they also identify over 40 STAR CONSTELLATIONS
- ca. 500 B.C.E. ● Babylonians devise ZODIAC that is later adopted and embellished by Greeks and used by other early peoples
- ca. 432 B.C.E. ● The early Greek astronomer METON (OF ATHENS) discovers that 235 LUNAR months makes up about 19 years
- ca. 375 B.C.E. ● The early Greek mathematician and astronomer EUDOXUS OF CNIDUS starts codifying the ANCIENT CONSTELLATIONS from tales of Greek mythology
- ca. 366 B.C.E. ● The ancient Greek astronomer and mathematician EUDOXUS OF CNIDUS constructs a NAKED-EYE astronomical observatory. Eudoxus also postulates that EARTH is the center of the UNIVERSE and develops a system of 27 concentric spheres (or shells) to explain and predict the motion of the visible PLANETS (MERCURY, VENUS, MARS, JUPITER, and SATURN), the MOON, and the SUN. His GEOCENTRIC model represents the first attempt at a coherent theory of COSMOLOGY. With ARISTOTLE's endorsement, this early Greek cosmological model eventually leads to the dominance of the PTOLEMAIC SYSTEM in Western culture for almost two millennia
- ca. 350 B.C.E. ● Greek astronomer HERACLIDES OF PONTUS suggests EARTH spins daily on an AXIS of ROTATION; also teaches that the PLANETS MERCURY and VENUS move around the SUN.
  - In his work *Concerning the Heavens*, the great Greek philosopher ARISTOTLE suggests EARTH is a sphere and makes an attempt to estimate its circumference. He also endorses and modifies the GEOCENTRIC model of EUDOXUS OF CNIDUS. Because of Aristotle's intellectual prestige, his concentric crystal-sphere model of the heavens (COSMOLOGY)

## CHRONOLOGY

ca. 3000 B.C.E. – ca. 350 B.C.E.

ca. 275 B.C.E. – 820

with Earth at the center of the UNIVERSE essentially remains unchallenged in Western civilization until NICHOLAS COPERNICUS in the 16th century

**ca. 275 B.C.E.** ● The Greek astronomer ARISTARCHUS OF SAMOS suggests an astronomical model of the UNIVERSE (SOLAR SYSTEM) that anticipates the modern HELIOCENTRIC theory proposed by NICHOLAS COPERNICUS. However, these “correct” thoughts that Aristarchus presented in his work *On the Size and Distances of the Sun and the Moon* are essentially ignored in favor of the GEOCENTRIC model proposed by EUDOXUS OF CNIDUS and endorsed by ARISTOTLE

**ca. 225 B.C.E.** ● The Greek astronomer ERATOSTHENES OF CYRENE uses mathematical techniques to estimate the circumference of EARTH

**ca. 129 B.C.E.** ● The Greek astronomer HIPPARCHUS OF NICAIA completes a catalog of 850 STARS that remains important until the 17th century

**0 C.E.** ● According to Christian tradition, the Star of Bethlehem guides three wise men (thought to be Middle Eastern astronomers) to the Nativity

**ca. 60 C.E.** ● The Greek engineer and mathematician HERO OF ALEXANDRIA creates the aeoliphile, a toylike device that demonstrates the action-reaction principle that is the basis of operation of all ROCKET engines

**ca. 150** ● Greek astronomer PTOLEMY writes *Syntaxis* (later called *ALMAGEST* by Arab astronomers and scholars)—an important book that summarizes all the astronomical knowledge of the ancient astronomers, including the GEOCENTRIC model of the UNIVERSE that dominates Western science for more than one and one-half millennia

**820** ● Arab astronomers and mathematicians establish a school of ASTRONOMY in Baghdad and translate PTOLEMY’s work into Arabic after which it became known as the *Great Work* or *al-Majisti* (*ALMAGEST* by medieval scholars)

ca. 275 B.C.E. – 820

CHRONOLOGY

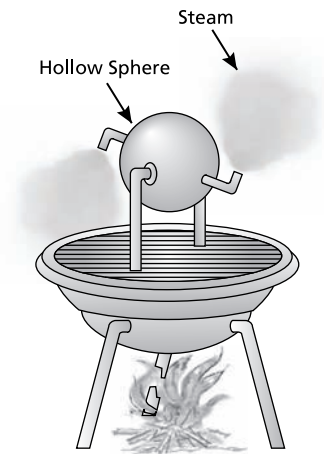

Hero's aeoliphile

CHRONOLOGY

## CHRONOLOGY



Battle of Kaifeng

## 850 – 1519

- 850** ● The Chinese begin to use gunpowder for festive fireworks, including a ROCKET-like device
- 964** ● Arab astronomer ABD AL-RAHMAN AL-SUFI publishes his *Book of the Fixed Stars*, a STAR catalog with Arabic star names; includes earliest known reference to the ANDROMEDA GALAXY
- 1232** ● The Chinese army uses fire arrows (crude gunpowder ROCKETS) to repel Mongol invaders at the Battle of Kaifeng. This is the first reported use of the rocket in warfare
- 1280–90** ● The Arab historian Al-Hasan al Rammah writes *The Book of Fighting on Horseback and War Strategies*, in which he gives instructions for making both gunpowder and ROCKETS
- 1379** ● ROCKETS appear in western Europe; used in the siege of Chioggia (near Venice), Italy
- 1420** ● The Italian military engineer Joanes de Fontana writes *Book of War Machines*, a speculative work that suggests military applications of gunpowder ROCKETS, including a rocket-propelled battering ram and a rocket-propelled torpedo
- 1424** ● Mongolian ruler and astronomer BEG ULUGH constructs a great observatory at Samarkand
- 1429** ● The French army uses gunpowder ROCKETS to defend the city of Orléans. During this period, arsenals throughout Europe begin to test various types of gunpowder rockets as an alternative to early cannons
- ca. 1500** ● According to early ROCKET lore, a Chinese official named Wan-Hu (or Wan-Hoo) attempts to use an innovative rocket-propelled kite assembly to fly through the air. As he sat in the pilot's chair, his servants lit the assembly's 47 gunpowder (black powder) rockets. Unfortunately, this early rocket test pilot disappeared in a bright flash and explosion
- 1519** ● The Portuguese explorer FERDINAND MAGELLAN becomes the first to record observing the two irregular DWARF GALAXIES

## CHRONOLOGY

## 850 – 1519

visible to the NAKED EYE in the Southern Hemisphere that now bear his name as the MAGELLANIC CLOUDS

- 1543 ● The Polish astronomer NICHOLAS COPERNICUS changes history and initiates the Scientific Revolution with his book *On the Revolution of Celestial Orbs (De Revolutionibus Orbium Coelestium)*. This important book, published while Copernicus lay on his deathbed, proposed a Sun-centered (HELIOCENTRIC) model of the UNIVERSE in contrast to the long-standing EARTH-centered (GEOCENTRIC) model advocated by PTOLEMY and many of the early Greek astronomers
- 1572 ● Danish astronomer TYCHO BRAHE discovers a SUPERNOVA that appears in the CONSTELLATION of Cassiopeia. He describes his precise (pretelescope) observations in *De Nova Stella* (1573). The dynamic nature of this “brilliant star” causes Brahe and other astronomers to question the long-cherished hypothesis of ARISTOTLE concerning the unchanging nature of the heavens
- 1576 ● With the generous support of Danish King Frederick II, TYCHO BRAHE starts construction of a great NAKED-EYE astronomical observatory on the island of Hven in the Baltic Sea. For the next two decades, Brahe’s Uraniborg (Castle of the Sky) serves as the world’s center for ASTRONOMY. The precise data from this observatory eventually allow JOHANNES KEPLER to develop his important laws of planetary motion
- 1577 ● The observation of a COMET’s elongated TRAJECTORY causes TYCHO BRAHE to question ARISTOTLE’S GEOCENTRIC, crystal spheres model of planetary motion. He proposes his own Tychonic system—a modified version of Ptolemaic COSMOLOGY in which all the PLANETS (except EARTH) revolve around the SUN and the Sun with its entire assembly of planets and comets revolves around a stationary Earth
- 1601 ● Following the death of TYCHO BRAHE, German Emperor Rudolf II appoints JOHANNES KEPLER to succeed him as the imperial mathematician in Prague. Kepler thus acquires Brahe’s collection of precise, pretelescopic astronomical



## CHRONOLOGY

1602 – 1647

observations and uses them to help develop his three laws of planetary motion

- 1602–04** ● The German astronomer DAVID FABRICIUS makes precise, preTELESCOPE observations of the ORBIT of MARS. These data greatly assist JOHANNES KEPLER in the development of his three laws of planetary motion
- 1608** ● The Dutch optician HANS LIPPERSHEY develops a crude TELESCOPE
- 1609** ● The German astronomer JOHANNES KEPLER publishes *New Astronomy* in which he modifies NICHOLAS COPERNICUS's HELIOCENTRIC model of the UNIVERSE by announcing that the PLANETS have ELLIPTICAL ORBITS rather than circular ones. KEPLER'S LAWS of planetary motion help put an end to more than 2,000 years of GEOCENTRIC Greek ASTRONOMY
- 1610** ● On 7 January 1610, GALILEO GALILEI uses his TELESCOPE to gaze at JUPITER and discovers the PLANET's four major MOONS (CALLISTO, EUROPA, IO, and GANYMEDE). He announces this and other astronomical observations in his book *Starry Messenger (Sidereus Nuncius)*. Discovery of Jupiter's moons encourages Galileo to advocate the HELIOCENTRIC theory of NICHOLAS COPERNICUS vigorously and brings him into direct conflict with church authorities
- 1619** ● JOHANNES KEPLER publishes *The Harmony of the World* in which he presents his third law of planetary motion
- 1639** ● On 24 November (JULIAN CALENDAR), the English astronomer JEREMIAH HORROCKS makes the first observation of a TRANSIT of VENUS
- 1642** ● GALILEO GALILEI dies while under house arrest near Florence, Italy, for his clashes with church authorities concerning the HELIOCENTRIC theory of NICHOLAS COPERNICUS
- 1647** ● The Polish-German astronomer JOHANNES HEVELIUS publishes his work, *Selenographia*, in which he provides a

## CHRONOLOGY

1602 – 1647

## 1655 – 1740

detailed description of features on the surface (NEARSIDE) of the MOON

- 1655 ● Dutch astronomer CHRISTIAAN HUYGENS discovers TITAN, the largest MOON of SATURN
- 1668 ● GIOVANNI DOMENICO CASSINI publishes tables that describe the motions of JUPITER'S major SATELLITES
  - SIR ISAAC NEWTON constructs the first REFLECTING TELESCOPE
- 1675 ● GIOVANNI DOMENICO CASSINI discovers the division of SATURN'S RINGS, a feature that now carries his name
  - English King Charles II establishes the ROYAL GREENWICH OBSERVATORY and appoints JOHN FLAMSTEED as its director and also the first ASTRONOMER ROYAL
- 1680 ● Russian Czar Peter the Great sets up a facility to manufacture ROCKETS in Moscow. The facility later moves to Saint Petersburg and provides the Czarist army with a variety of gunpowder rockets for bombardment, signaling, and nocturnal battlefield illumination
- 1687 ● Financed and encouraged by EDMOND HALLEY, SIR ISAAC NEWTON publishes his great work, *The Principia (Philosophiae Naturalis Principia Mathematica)*. This book provides the mathematical foundations for understanding the motion of almost everything in the UNIVERSE, including the orbital motion of PLANETS and the TRAJECTORIES of ROCKET-propelled vehicles
- 1728 ● The British astronomer JAMES BRADLEY discovers the optical phenomenon of ABERRATION OF STARLIGHT. He explains this phenomenon as a combination of EARTH'S motion around the SUN and LIGHT having a finite speed
- 1740 ● The Swedish astronomer ANDERS CELSIUS assumes responsibility for the construction and management of the Uppsala Observatory. In 1742, he suggests a temperature scale based on 0° as the boiling point of water and 100° as the melting point of ice. Following his death in 1744, his

## CHRONOLOGY

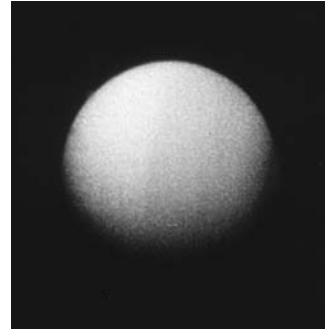

Saturn's largest moon, Titan, discovered in 1655 (NASA/JPL)

## 1655 – 1740

## CHRONOLOGY

## CHRONOLOGY

1748 – 1781

colleagues at the Uppsala Observatory continue to use this new temperature scale but invert it. Their action creates the familiar CELSIUS TEMPERATURE SCALE with 0° as the melting point of ice and 100° as the boiling point of water

- 1748** ● The French physicist PIERRE BOUGUER invents the HELIOMETER—an instrument that measures the LIGHT of the SUN and other luminous bodies
- 1755** ● The German philosopher IMMANUEL KANT introduces the NEBULA hypothesis, suggesting that the SOLAR SYSTEM may have formed out of an ancient cloud of INTERSTELLAR material. He also uses the term ISLAND UNIVERSES to describe distant DISKlike collections of STARS
- 1758** ● The British optician JOHN DOLLAND and his son make the first achromatic (that is, without CHROMATIC ABERRATION) TELESCOPE
- 1766** ● The German astronomers JOHANN ELERT BODE and JOHANN DANIEL TITIUS discover an EMPIRICAL rule (eventually called Bode’s law) that describes the apparently proportional distances of the six known PLANETS from the SUN. Their work stimulates the search by other astronomers to find a “missing” planet between MARS and JUPITER, eventually leading to the discovery of MAIN-BELT ASTEROIDS
- 1772** ● The Italian-French mathematician JOSEPH LEWIS LAGRANGE describes the points in the plane of two objects in ORBIT around their common CENTER OF GRAVITY at which their combined FORCES of GRAVITATION are zero. Today, such points in space are called LAGRANGIAN LIBRATION POINTS
- 1781** ● German-born British astronomer SIR (FREDERICK) WILLIAM HERSCHEL discovers URANUS, the first PLANET to be found through the use of the TELESCOPE. Herschel originally called this new planet Georgium Sidus (George’s Star) to honor the English king, George III. However, astronomers from around the world insisted that a more traditional name from Greco-Roman mythology be used. Herschel

## CHRONOLOGY

1748 – 1781

bowed to peer pressure and eventually chose the name Uranus, as suggested by the German astronomer JOHANN ELERT BODE

- 1780s** ● The Indian ruler Hyder Ally of Mysore creates a ROCKET corps within his army. Hyder's son, Tippo Sultan, successfully uses rockets against the British in a series of battles in India between 1782 and 1799
- 1782** ● The British astronomer JOHN GOODRICKE is the first to recognize that the periodic behavior of the VARIABLE STAR Algol (Beta Persei) is actually that of an eclipsing BINARY (DOUBLE) STAR SYSTEM
- 1786** ● The German-born British astronomer CAROLINE HERSCHEL becomes the world's first (recognized) woman astronomer. While working with her brother SIR (FREDERICK) WILLIAM HERSCHEL, she discovers eight COMETS during the period 1786–97
- 1796** ● The French mathematician and astronomer PIERRE SIMON DE MARQUIS LAPLACE formalizes the nebular hypothesis of planetary formation—suggesting that the SOLAR SYSTEM originated from a massive cloud of gas and that, over time, the FORCES OF GRAVITATION helped the center of this cloud to collapse to form the SUN and smaller remnant clumps of matter to form the PLANETS
- 1801** ● The Italian astronomer GIUSEPPE PIAZZI discovers the first ASTEROID (MINOR PLANET), CERES, on 1 January
- 1802** ● The German astronomer HEINRICH WILHELM OLBERS discovers the second ASTEROID (Pallas) and then continues his search, finding the brightest MINOR PLANET (VESTA) in 1807
- 1804** ● SIR WILLIAM CONGREVE writes *A Concise Account of the Origin and Progress of the Rocket System* and documents the British military's experience in India. He then starts the development of a series of British military (black-powder) ROCKETS

## CHRONOLOGY

### 1807 – 1847

- 1807** ● The British use about 25,000 of SIR WILLIAM CONGREVE's improved military (black-powder) ROCKETS to bombard Copenhagen during the Napoleonic Wars
- 1809** ● The brilliant German mathematician, astronomer, and physicist CARL FRIEDRICH GAUSS publishes a major work on CELESTIAL MECHANICS that revolutionizes the calculation of PERTURBATIONS in planetary ORBITS. His work paves the way for other 19th-century astronomers to anticipate mathematically and then discover NEPTUNE (in 1846), using perturbations in the orbit of URANUS
- 1812** ● British forces use SIR WILLIAM CONGREVE's military ROCKETS against American troops during the War of 1812. British rocket bombardment of Fort William McHenry inspires Francis Scott Key to add "the rockets' red glare" verse in the "Star Spangled Banner"
- 1814–1817** ● The German physicist JOSEPH VON FRAUNHOFER develops the PRISM SPECTROMETER into a precision instrument. He subsequently discovers the dark lines in the SUN's SPECTRUM that now bear his name
- 1840** ● The American astronomers HENRY DRAPER and JOHN WILLIAM DRAPER (his son) photograph the MOON and start the field of ASTROPHOTOGRAPHY
- 1842** ● The Austrian physicist CHRISTIAN JOHANN DOPPLER describes the DOPPLER SHIFT in a scientific paper. This phenomenon is experimentally verified in 1845 through an interesting experiment in which a locomotive pulls an open railroad car carrying several trumpeters
- 1846** ● On 23 September, the German astronomer JOHANN GOTTFRIED GALLE discovers NEPTUNE in the location theoretically predicted and calculated by URBAIN-JEAN-JOSEPH LEVERRIER
- 1847** ● American astronomer MARIA MITCHELL makes the first telescopic discovery of a COMET

## CHRONOLOGY

### 1807 – 1847

## 1850 – 1868

- 1850** ● American astronomer **WILLIAM CRANCH BOND** helps expand the field of **ASTROPHOTOGRAPHY** by successfully photographing the **PLANET JUPITER**
- 1851** ● French physicist **JEAN-BERNARD LÉON FOUCAULT**, using a 70m long pendulum, demonstrates the **ROTATION** of **EARTH** to a large crowd in a Parisian church
  - The British astronomer **WILLIAM LASSELL** discovers the two **SATELLITES** of **URANUS**, named **Ariel** and **Umbriel**
- 1852** ● French physicist **JEAN-BERNARD-LÉON FOUCAULT** constructs the first **GYRO**
- 1864** ● Italian astronomer **GIOVANNI BATTISTA DONATI** collects the **SPECTRUM** of **Comet Tempel**
- 1865** ● The French science fiction writer **JULES VERNE** publishes his famous story, *From the Earth to the Moon* (*De la Terre a la Lune*). This story interests many people in the concept of **SPACE** travel, including three young readers who go on to become the founders of **ASTRONAUTICS**: **ROBERT HUTCHINGS GODDARD**, **HERMANN J. OBERTH**, and **KONSTANTIN EDUARDOVICH TSIOLKOVSKY**
- 1866** ● American astronomer **DANIEL KIRKWOOD** explains the unequal distribution of **ASTEROIDS** found in the main asteroid belt as a **CELESTIAL MECHANICS** resonance phenomenon, involving the **GRAVITATION** of **JUPITER**. In his honor, these empty spaces or gaps are now called the **KIRKWOOD GAPS**.  
*See* **MAIN-BELT ASTEROID**
- 1868** ● During a total **ECLIPSE** of the **SUN**, the French astronomer **PIERRE-JULES-CÉSAR JANSSEN** makes important spectroscopic observations that reveal the gaseous nature of **SOLAR PROMINENCES**
  - The British astronomer **SIR WILLIAM HUGGINS** becomes the first to observe the gaseous spectrum of a **NOVA**
  - While observing the **SUN**, the British astronomer **SIR JOSEPH NORMAN LOCKYER** postulates the existence of an unknown

## CHRONOLOGY



Scene from Jules Verne's *From the Earth to the Moon* (NASA)

## 1850 – 1868

## CHRONOLOGY

## CHRONOLOGY

1869 – 1918

element that he names HELIUM (meaning “the SUN’s ELEMENT”)—but not until 1895 is helium is detected on EARTH

- 1869** ● American clergyman and writer Edward Everett Hale writes *The Brick Moon*—a story that is the first fictional account of a human-crewed SPACE STATION
- 1874** ● The Scottish astronomer SIR DAVID GILL makes the first of several very precise measurements of the distance from EARTH to the SUN while on an expedition to Mauritius (Indian Ocean). He then visits Ascension Island (South Atlantic Ocean) in 1877 to perform similar measurements
- 1877** ● While a staff member at the U.S. NAVAL OBSERVATORY in Washington, D.C., the American astronomer ASAPH HALL discovers and names the two tiny MARTIAN MOONS, DEIMOS and PHOBOS
- 1881** ● The American astronomer and aeronautical engineer SAMUEL PIERPONT LANGLEY leads an expedition to Mount Whitney in the Sierra Nevada to examine how incoming SOLAR RADIATION is absorbed by EARTH’S ATMOSPHERE
- 1897** ● British author H. G. Wells writes the science fiction story *War of the Worlds*—the classic tale about EXTRATERRESTRIAL invaders from MARS
- 1903** ● The Russian technical visionary KONSTANTIN EDUARDOVICH TSIOLKOVSKY becomes the first to link the ROCKET and space travel when he publishes *Exploration of Space with Reactive Devices*
- 1906** ● American astronomer GEORGE ELLERY HALE sets up the first tower TELESCOPE for SOLAR research on Mount Wilson in California
- 1918** ● American physicist ROBERT HUTCHINGS GODDARD writes *The Ultimate Migration*—a far-reaching technology piece within which he postulates an atomic-powered space ark to carry human beings away from a dying SUN. Fearing professional ridicule, Goddard hides the visionary manuscript and it

## CHRONOLOGY

1869 – 1918

remains unpublished until November 1972—many years after his death in 1945

- 1919 ● American ROCKET pioneer ROBERT HUTCHINGS GODDARD publishes the Smithsonian monograph *A Method of Reaching Extreme Altitudes*. This important work presents all the fundamental principles of modern rocketry. Unfortunately, members of the press completely miss the true significance of his technical contribution and decide to sensationalize his comments about possibly reaching the MOON with a small, rocket-propelled package. For such “wild fantasy,” newspaper reporters dubbed Goddard with the unflattering title of “Moon man”
- On 29 May, a British expedition led by the British astronomer SIR ARTHUR EDDINGTON observes a total SOLAR ECLIPSE and provides scientific verification of ALBERT EINSTEIN’S GENERAL RELATIVITY theory by detecting the slight deflection of a beam of LIGHT from a STAR near the edge of the “darkened” SUN. This important experiment helps usher in a new era in humans’ understanding of the physical UNIVERSE
- 1922 ● American astronomer WILLIAM WALLACE CAMPBELL measures the deflection of a beam of starlight that just skims the SUN’S edge during another SOLAR ECLIPSE. This work provides additional scientific evidence in favor of ALBERT EINSTEIN’S GENERAL RELATIVITY theory
- 1923 ● Independently of ROBERT HUTCHINGS GODDARD and KONSTANTIN EDUARDOVICH TSIOLKOVSKY, the German space travel visionary HERMANN J. OBERTH publishes the inspirational book *The Rocket into Interplanetary Space (Die Rakete zu den Planetenräumen)*
- American astronomer EDWIN POWELL HUBBLE uses CEPHEID VARIABLE STARS as astronomical distance indicators and shows that the distance to the spiral ANDROMEDA GALAXY is well beyond the MILKY WAY GALAXY. As a result of Hubble’s work, astronomers begin to postulate that an expanding universe contains many such GALAXIES or ISLAND UNIVERSES

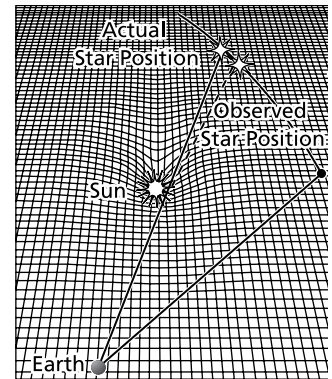

Sun’s gravity bending starlight



## CHRONOLOGY



Goddard and the first liquid propellant rocket (NASA)

## 1924 – 1929

- 1924** ● The German engineer WALTER HOHMANN writes *The Attainability of Celestial Bodies (Die Erreichbarkeit der Himmelskörper)*, an important work that details the mathematical principles of ROCKET and SPACECRAFT motion. He includes a description of the most efficient (that is, minimum ENERGY) ORBIT transfer path between two coplanar orbits—a frequently used space operations maneuver now called the HOHMANN TRANSFER ORBIT
- 1926** ● On 16 March in a snow-covered farm field in Auburn, Massachusetts, American physicist ROBERT HUTCHINGS GODDARD makes space technology history by successfully firing the world's first LIQUID-PROPELLANT ROCKET. Although his primitive gasoline (fuel) and LIQUID OXYGEN (OXIDIXER) device burns for only two and one-half seconds and lands about 60 m away, it represents the technical ancestor of all modern liquid-propellant rocket engines
- In April, the first issue of *Amazing Stories* appears. The publication becomes the world's first magazine dedicated exclusively to science fiction. Through science fact and fiction, the modern ROCKET and space travel become firmly connected. As a result of this union, the visionary high-technology dream for many people in the 1930s (and beyond) becomes that of INTERPLANETARY travel
- 1927** ● Belgian astrophysicist and cosmologist GEORGES-ÉDOUARD LEMAÎTRE publishes a major paper introducing a COSMOLOGY model that features an ancient explosion that starts an EXPANDING UNIVERSE. His work leads to the development of the BIG BANG theory
- 1929** ● American astronomer EDWIN POWELL HUBBLE announces that his measurements of galactic REDSHIFT values indicate that other GALAXIES are receding from this MILKY WAY GALAXY with speeds that increase in proportion to their distance from humans' home galaxy. This observation becomes known as HUBBLE'S LAW
- British scientist and writer JOHN DESMOND BERNAL speculates about large human settlements in OUTER SPACE

## CHRONOLOGY

## 1924 – 1929

(later called BERNAL SPHERES) in his book *The World, The Flesh and the Devil*

- German SPACE travel visionary HERMANN J. OBERTH writes the award-winning book *Roads to Space Travel (Wege zur Raumschiffahrt)* that helps popularize the notion of space travel among nontechnical audiences

**1930** ● On 18 February, American astronomer CLYDE WILLIAM TOMBAUGH discovers the former PLANET PLUTO

**1932** ● In December, American radio engineer KARL GUTHE JANSKY announces his discovery of a stellar radio source in the CONSTELLATION of Sagittarius. His paper is regarded as the birth of RADIO ASTRONOMY

- Following the discovery of the NEUTRON by the British physicist Sir James Chadwick, Russian physicist LEV DAVIDOVICH LANDAU suggests the existence of NEUTRON STARS

**1933** ● P. E. Cleator founds the British Interplanetary Society (BIS), which becomes one of the world's most respected SPACE travel advocacy organizations

**1935** ● KONSTANTIN EDUARDOVICH TSIOLKOVSKY publishes his last book, *On the Moon*, in which he strongly advocates the SPACESHIP as the means of LUNAR and INTERPLANETARY travel

**1936** ● P. E. Cleator, founder of the British Interplanetary Society, writes *Rockets through Space*, the first serious treatment of ASTRONAUTICS in the United Kingdom. However, several established British scientific publications ridicule his book as the premature speculation of an unscientific imagination

**1937** ● American radio engineer GROTE REBER builds the first RADIO TELESCOPE—a modest device located in his backyard. For several years following this construction, Reber is the world's only radio astronomer

**1939–1945** ● Throughout World War II, combating nations use of ROCKETS and GUIDED MISSILES of all sizes and shapes. Of these, the most significant with respect to space exploration

## CHRONOLOGY

1942 – 1945

is the development of the LIQUID-PROPELLANT V-2 ROCKET by the German Army at Peenemünde under WERNHER VON BRAUN

- 1942** ● On 3 October, the German A-4 ROCKET (later renamed VENGEANCE WEAPON 2 or V-2 Rocket) completes its first successful flight from the Peenemünde test site on the Baltic Sea. This is the birth date of the modern military BALLISTIC MISSILE
- 1944** ● In September, the German Army begins a BALLISTIC MISSILE offensive by launching hundreds of unstoppable V-2 ROCKETS (each carrying a one-ton high-explosive WARHEAD) against London and southern England
- 1945** ● After recognizing the war was lost, the German rocket scientist WERNHER VON BRAUN and key members of his staff surrender to American forces near Reutte, Germany, in early May. Within months, U.S. intelligence teams, under Operation Paperclip, interrogate German ROCKET personnel and sort through carloads of captured documents and equipment. Many of these German scientists and engineers join Braun in the United States to continue their rocket work. Hundreds of captured V-2 rockets are also disassembled and shipped back to the United States
  - Similarly, on 5 May, the Soviet Army captures the German ROCKET facility at Peenemünde and hauls away any remaining equipment and personnel. In the closing days of World War II in Europe, captured German rocket technology and personnel help set the stage for the great MISSILE and space race of the COLD WAR
  - On 16 July, the United States explodes the world's first nuclear weapon. The test shot, code named Trinity, occurs in a remote portion of southern New Mexico and changes the nature of warfare forever. As part of the COLD WAR confrontation between the United States and the Soviet Union, the nuclear-armed BALLISTIC MISSILE will become the most powerful weapon ever developed by the human race

## CHRONOLOGY

1942 – 1945

## 1946 – 1949

- In October, British engineer and writer ARTHUR C. CLARKE suggests the use of SATELLITES in GEOSTATIONARY ORBIT to support global communications. His article, “Extra-Terrestrial Relays” in *Wireless World*, represents the birth of the COMMUNICATIONS SATELLITE concept—a use of SPACE technology that vigorously promotes the information revolution
- 1946** ● On 16 April, the U.S. Army launches the first American-adapted, captured German V-2 ROCKET from the White Sands Proving Ground in southern New Mexico
  - Between July and August, the Russian ROCKET engineer SERGEI KOROLEV develops a stretched-out version of the German V-2 rocket. As part of his engineering improvements, he increases the rocket engine’s THRUST and lengthens the vehicle’s PROPELLANT tanks
- 1947** ● On 30 October, Russian ROCKET engineers successfully launch a modified German V-2 rocket from a desert LAUNCH SITE near a place called KAPUSTIN YAR. This rocket impacts about 320 km DOWNRANGE from the launch site
- 1948** ● The September issue of the *Journal of the British Interplanetary Society (JBIS)* starts a four-part series of technical papers by L. R. Shepherd and A. V. Cleaver that explores the feasibility of applying nuclear ENERGY to space travel, including the concepts of NUCLEAR-ELECTRIC PROPULSION and the NUCLEAR ROCKET
- 1949** ● On 29 August, the Soviet Union detonates its first nuclear device at a secret test site in the Kazakh Desert. Code named First Lightning (Pervaya Molniya), this successful test breaks the nuclear weapon monopoly enjoyed by the United States. It plunges the world into a massive nuclear arms race that includes the accelerated development of strategic BALLISTIC MISSILES capable of traveling thousands of kilometers. Because they are well behind the United States in nuclear weapons technology, the leaders of the Soviet Union decide to develop powerful, high-THRUST ROCKETS to carry their heavier, more primitive-design nuclear weapons.

## 1946 – 1949

## CHRONOLOGY



German V-2 rocket (Courtesy of U.S. Army)

## CHRONOLOGY

That decision gives the Soviet Union a major LAUNCH VEHICLE advantage when both superpowers decide to race into OUTER SPACE (starting in 1957) as part of a global demonstration of national power

- **1950** ● On 24 July, the United States successfully LAUNCHES a modified German V-2 ROCKET with an American-designed WAC Corporal second-stage rocket from the U.S. Air Force's newly established long-range proving ground at CAPE CANAVERAL, Florida. The hybrid, MULTISTAGE ROCKET (called the *Bumper 8*) inaugurates the incredible sequence of military MISSILE and SPACE VEHICLE launches to take place from Cape Canaveral—the world's most famous LAUNCH SITE.
- In November, British technical visionary ARTHUR C. CLARKE publishes “Electromagnetic Launching as a Major Contribution to Space-Flight.” Clarke's article suggests mining the MOON and launching the mined LUNAR material into OUTER SPACE with an electromagnetic catapult
- **1951** ● Cinema audiences are shocked by the science fiction movie *The Day the Earth Stood Still*. This classic story involves the arrival of a powerful, humanlike EXTRATERRESTRIAL and his robot companion who come to warn the governments of the world about the foolish nature of their nuclear arms race. It is the first major science fiction story to portray powerful space aliens as friendly, intelligent creatures who come to help EARTH
- Dutch-American astronomer GERARD PETER KUIPER suggests the existence of a large population of small, icy PLANETESIMALS beyond the ORBIT of NEPTUNE—a collection of frozen CELESTIAL BODIES now known as the KUIPER BELT
- **1952** ● *Collier's* magazine helps stimulate a surge of American interest in space travel by publishing a beautifully illustrated series of technical articles written by space experts such as WERNHER VON BRAUN and WILLY LEY. The first of the famous eight-part series appears on 22 March and is boldly

titled “Man Will Conquer Space Soon.” The magazine also hires the most influential space artist, Chesley Bonestell, to provide stunning color illustrations. Subsequent articles in the series introduce millions of American readers to the concept of a SPACE STATION, a mission to the MOON, and an expedition to MARS.

- WERNHER VON BRAUN publishes *The Mars Project (Das Marsprojekt)*, the first serious technical study regarding a human-crewed expedition to MARS. His visionary proposal involves a convoy of 10 SPACESHIPS with a total combined crew of 70 ASTRONAUTS to explore the RED PLANET for about one (EARTH) year and then return to Earth

**1953** ● In August, the Soviet Union detonates its first thermonuclear weapon (a hydrogen bomb). This is a technological feat that intensifies the superpower nuclear arms race and increases emphasis on the emerging role of strategic, nuclear-armed, BALLISTIC MISSILES

- In October, the U.S. Air Force forms a special panel of experts, headed by JOHN VON NEUMANN, to evaluate the American strategic BALLISTIC MISSILE program. In 1954, this panel recommends a major reorganization of the American ballistic missile effort

**1954** ● Following the recommendations of the JOHN VON NEUMANN panel, President DWIGHT D. EISENHOWER gives strategic BALLISTIC MISSILE development the highest national priority. The COLD WAR missile race explodes on the world stage as the fear of a strategic ballistic missile gap sweeps through the American government. CAPE CANAVERAL becomes the famous proving ground for such important ballistic missiles as the THOR, ATLAS, TITAN, Minuteman, and Polaris. Once developed, many of these powerful military ballistic missiles also serve the United States as SPACE LAUNCH VEHICLES. Air Force General BERNARD SCHRIEVER oversees the time-critical development of the Atlas ballistic missile—an astonishing feat of engineering and technical management

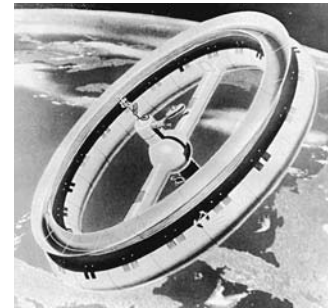

Wernher von Braun's space station concept (NASA)

## CHRONOLOGY

1955 – 1958

- 1955** ● WALT DISNEY (the American entertainment visionary) promotes space travel by producing an inspiring three-part television series that includes appearances by noted space experts like WERNHER VON BRAUN. The first episode, “Man in Space,” airs on 9 March and popularizes the dream of space travel for millions of American television viewers. This show, along with its companion episodes, “Man and the MOON” and “MARS and Beyond,” make Braun and the term *rocket scientist* a popular household phrase
- 1957** ● On 4 October, Russian engineer SERGEI KOROLEV with permission from Soviet Premier NIKITA S. KHRUSHCHEV uses a powerful military ROCKET to place *SPUTNIK 1* (the world’s first ARTIFICIAL SATELLITE) successfully into ORBIT around EARTH. News of the Soviet success sends a political and technical shock wave across the United States. The LAUNCH of *Sputnik 1* marks the beginning of the Space Age. It also is the start of the great space race of the COLD WAR—a period when people measured national strength and global prestige by accomplishments (or failures) in OUTER SPACE
- On 3 November, the Soviet Union launches *Sputnik 2*—the world’s second ARTIFICIAL SATELLITE. It is a massive SPACECRAFT (for the time) that carries a live dog named Laika, which is euthanized at the end of the mission
  - The highly publicized attempt by the United States to launch its first SATELLITE with a newly designed civilian ROCKET ends in complete disaster on 6 December. The *Vanguard* rocket explodes after rising only a few centimeters above its LAUNCH PAD at CAPE CANAVERAL. Soviet successes with *Sputnik 1* and *Sputnik 2* and the dramatic failure of the *Vanguard* rocket heighten American anxiety. The exploration and use of OUTER SPACE becomes a highly visible instrument of COLD WAR politics
- 1958** ● On January 31, the United States successfully launches *EXPLORER 1*—the first American SATELLITE in ORBIT around EARTH. A hastily formed team from the U.S. Army Ballistic Missile Agency (ABMA) and Caltech’s



Mongolian stamp honoring *Sputnik 2* and Laika (Courtesy of author)

## CHRONOLOGY

1955 – 1958

Jet Propulsion Laboratory (JPL), led by WERNHER VON BRAUN, accomplishes what amounts to a national prestige-rescue mission. The team uses a military BALLISTIC MISSILE as the LAUNCH VEHICLE. With instruments supplied by JAMES ALFRED VAN ALLEN of the State University of Iowa, *Explorer 1* discovers EARTH'S TRAPPED RADIATION BELTS—now called the VAN ALLEN RADIATION BELTS in his honor

- The National Aeronautics and Space Administration (NASA) becomes the official civilian space agency for the United States government on 1 October. On 7 October, the newly created NASA announces the start of the MERCURY PROJECT—a pioneering program to put the first American ASTRONAUTS into ORBIT around EARTH
  - In mid-December, an entire ATLAS ROCKET lifts off from CAPE CANAVERAL and goes into orbit around EARTH. The military BALLISTIC MISSILE'S PAYLOAD compartment carries Project SCORE (Signal Communications Orbit Relay Experiment)—a prerecorded Christmas season message from President DWIGHT D. EISENHOWER. This is the first time the human voice is broadcast back to Earth from OUTER SPACE
- 1959** ● On 2 January, the Soviet Union sends a 360 kg SPACECRAFT (called *Lunik 1*) toward the MOON. Although it misses hitting the Moon by between 5,000 and 7,000 km, it is the first human-made object to escape EARTH'S GRAVITY and go into ORBIT around the SUN
- In mid-September, the Soviet Union launches *Lunik 2*. The 390 kg SPACECRAFT successfully impacts on the MOON and becomes the first human-made object to land (crash) on another world. *Lunik 2* carries Soviet emblems and banners to the LUNAR surface
  - The September issue of *Nature* contains the article by Philip Morrison and G. Cocconi, "Searching for Interstellar Communications"—marking the start of SETI (SEARCH FOR EXTRATERRESTRIAL INTELLIGENCE)



Pickering, Van Allen, and Braun hoist an *Explorer 1* model in celebration (Courtesy of NASA)



## CHRONOLOGY

1960

- On 4 October, the Soviet Union sends *Lunik 3* on a mission around the MOON. The SPACECRAFT successfully circumnavigates the Moon and takes the first IMAGES of the lunar FAR SIDE. Because of the SYNCHRONOUS ROTATION of the Moon around EARTH, only the NEAR SIDE of the LUNAR surface is visible to observers on Earth
- 1960** ● The United States launches the *Pioneer 5* SPACECRAFT on 11 March into ORBIT around the SUN. The modest-sized (42 kg) spherical American space probe reports conditions in INTERPLANETARY space between EARTH and VENUS over a distance of about 37 million km
- On 1 April, NASA successfully launches the world's first METEOROLOGICAL SATELLITE, called TIROS (*Television and Infrared Observation Satellite*). The IMAGES of cloud patterns from OUTER SPACE create a revolution in weather forecasting
- The U.S. Navy places the world's first experimental NAVIGATION SATELLITE (called *Transit 1B*) into EARTH ORBIT on 13 April. The SPACECRAFT serves as a space-based beacon, providing RADIO WAVE signals that allow military users to determine their location at sea more precisely
- On 24 May, the U.S. Air Force launches a MIDAS (*Missile Defense Alarm System*) satellite from CAPE CANAVERAL. This event inaugurates an important American program of military SURVEILLANCE SATELLITES intended to detect enemy INTERCONTINENTAL BALLISTIC MISSILE (ICBM) launches by observing the characteristic INFRARED RADIATION (heat) signature of a ROCKET's EXHAUST PLUME. Essentially unknown to the general public for decades because of the classified nature of their mission, the emerging family of missile-surveillance satellites provides U.S. government authorities with a reliable early-warning system concerning a surprise enemy (Soviet) ICBM attack. Surveillance satellites help support the national policy of strategic nuclear deterrence throughout the COLD WAR and prevent an accidental nuclear conflict

## CHRONOLOGY

1960

- The U.S. Air Force successfully launches the *Discoverer 13* SPACECRAFT from VANDENBERG AIR FORCE BASE on 10 August. This spacecraft is actually part of a highly classified Air Force and Central Intelligence Agency (CIA) RECONNAISSANCE SATELLITE program called Corona. Started under special executive order from President DWIGHT D. EISENHOWER, the joint agency SPY SATELLITE program begins to provide important photographic IMAGES of denied areas of the world from OUTER SPACE. On 18 August, *Discoverer 14* (also called *Corona XIV*) provides the U.S. intelligence community its first SATELLITE-acquired images of the former Soviet Union. The era of satellite reconnaissance is born. Data collected by the spy satellites of the NATIONAL RECONNAISSANCE OFFICE (NRO) contribute significantly to U.S. national security and help preserve global stability during many politically troubled times
  - On 12 August, NASA successfully launches the *Echo 1* experimental SPACECRAFT. This large (30.5 m diameter) inflatable, metallized balloon becomes the world's first passive COMMUNICATIONS SATELLITE. At the dawn of space-based TELECOMMUNICATIONS, engineers bounce RADIO WAVE signals off the large, inflated satellite between the United States and the United Kingdom
  - The Soviet Union launches *Sputnik 5* into ORBIT around EARTH on 19 August. This large SPACECRAFT is actually a test vehicle for the new *VOSTOK* spacecraft that will soon carry COSMONAUTS into OUTER SPACE. *Sputnik 5* carries two dogs, Strelka and Belka. When the spacecraft's recovery capsule functions properly the next day, these two dogs become the first living creatures to return to Earth successfully from an orbital flight
- 1961** ● On 31 January, NASA launches a REDSTONE ROCKET with a MERCURY PROJECT SPACE CAPSULE on a suborbital flight from CAPE CANAVERAL. The passenger ASTROCHIMP HAM is recovered DOWNRANGE in the Atlantic Ocean after reaching an ALTITUDE of 250 km. This successful primate space

## CHRONOLOGY



Shepard departs Cape Canaveral on a Redstone rocket (Courtesy of NASA)

1961

mission is a key step in sending American ASTRONAUTS safely into OUTER SPACE

- The former Soviet Union achieves a major space exploration milestone by successfully launching the first human being into ORBIT around EARTH on 12 April. COSMONAUT YURI A. GAGARIN travels into OUTER SPACE in the *VOSTOK 1* SPACECRAFT and becomes the first person to observe Earth directly from an orbiting SPACE VEHICLE
- On 5 May, NASA uses a REDSTONE ROCKET to send ASTRONAUT ALAN B. SHEPARD, JR., on his historic 15-minute suborbital flight into OUTER SPACE from CAPE CANAVERAL. While riding inside his MERCURY PROJECT *Freedom 7* SPACE CAPSULE, Shepard reaches an ALTITUDE of 186 km and becomes the first American to travel in space
- President JOHN F. KENNEDY addresses a joint session of the U.S. Congress on 25 May. In an inspiring speech concerning many urgent national needs, the newly elected president creates a major SPACE challenge for the United States when he declares, “I believe that this nation should commit itself to achieving the goal, before this decade is out, of landing a man on the MOON and returning him safely to EARTH.” This is a daring decision to use a highly visible civilian (NASA) space mission to support national political objectives. Because of his visionary leadership, when American ASTRONAUTS NEIL A. ARMSTRONG and EDWIN E. “BUZZ” ALDRIN, JR., step onto the LUNAR surface for the first time on 20 July 1969, the United States is recognized around the world as the undisputed winner of the COLD WAR space race
- On 29 June, the United States launches the *Transit 4A* NAVIGATION SATELLITE into ORBIT around EARTH. The SPACECRAFT uses a RADIOISOTOPE THERMOELECTRIC GENERATOR (RTG) to provide supplementary electric POWER. The mission represents the first successful use of a nuclear power supply in OUTER SPACE

## CHRONOLOGY

1961

- On 21 July, ASTRONAUT VIRGIL “GUS” I. GRISSOM becomes the second American to travel in OUTER SPACE. A REDSTONE ROCKET successfully hurls his NASA MERCURY PROJECT *Liberty Bell 7* space capsule on a 15-minute suborbital flight from CAPE CANAVERAL
  - The Soviet Union launches the *Vostok 2* SPACECRAFT into ORBIT on 6 August. It carries COSMONAUT GHERMAN S. TITOV—the second person to ORBIT EARTH in a spacecraft successfully. About 10 hours into the flight, Titov also becomes the first of many space travelers to suffer from the temporary discomfort of SPACE SICKNESS, or space adaptation syndrome (SAS)
- 1962**
- On 20 February, ASTRONAUT JOHN HERSCHEL GLENN, JR., becomes the first American to ORBIT EARTH in a SPACECRAFT. An ATLAS ROCKET launches the NASA MERCURY PROJECT *Friendship 7* SPACE CAPSULE from CAPE CANAVERAL. After completing three orbits, Glenn’s capsule safely splashes down in the Atlantic Ocean
  - NASA launches *Telstar 1* on 10 July—the world’s first commercially constructed and funded active COMMUNICATIONS SATELLITE. Despite its relatively low operational ORBIT (about 950 km by 5,600 km), the pioneering American Telephone and Telegraph (AT&T) SATELLITE triggers a revolution in international television broadcasting and TELECOMMUNICATIONS services
  - In late August, NASA sends the *MARINER 2* SPACECRAFT to VENUS from CAPE CANAVERAL. *Mariner 2* passes within 35,000 km of the PLANET on 14 December 1962—thereby becoming the world’s first successful INTERPLANETARY SPACE PROBE. The spacecraft observes very high surface temperatures (~430°C). These data shatter pre-space age visions about Venus being a lush, tropical planetary twin of EARTH
  - During October, the placement of nuclear-armed Soviet offensive BALLISTIC MISSILES in Fidel Castro’s Cuba precipitates the Cuban missile crisis. This dangerous



Glenn’s Mercury Atlas 6 rocket lifts off (NASA)

superpower confrontation brings the world perilously close to nuclear warfare. Fortunately, the crisis dissolves when the Soviet ballistic missiles are withdrawn by Premier NIKITA S. KHRUSHCHEV after much skillful political maneuvering by President JOHN F. KENNEDY and his national security advisers

- **1963** Soviet COSMONAUT VALENTINA TERESHKOVA becomes the first woman to travel in OUTER SPACE. On 16 June, she ascends into space onboard the *VOSTOK 6* SPACECRAFT and then returns to EARTH after a flight of almost three days. While in ORBIT, she flies the *Vostok 6* within 5 km of the *Vostok 5* spacecraft, piloted by Cosmonaut Valery Bykovskiy. During their proximity flight, the two cosmonauts communicate with each other by radio
- On 26 July, NASA successfully launches the *Syncom 2* SATELLITE from CAPE CANAVERAL. This SPACECRAFT is the first COMMUNICATIONS SATELLITE to operate in high ALTITUDE (figure eight) SYNCHRONOUS ORBIT and helps fulfill the vision of ARTHUR C. CLARKE. About a year later, *Syncom 3* will achieve a true GEOSYNCHRONOUS ORBIT above the EQUATOR. Both of these experimental NASA satellites clearly demonstrate the feasibility and great value of placing communications satellites into geostationary orbits. The age of instantaneous global communications is born
- In October, President JOHN F. KENNEDY signs the Limited Test Ban Treaty for the United States, and the important new treaty enters force on 10 October. Within a week (on 16 October), the U.S. Air Force successfully launches the first pair of Vela nuclear detonation detection SATELLITES from CAPE CANAVERAL. These SPACECRAFT orbit EARTH at a very high ALTITUDE and continuously monitor the PLANET and OUTER SPACE for nuclear detonations in violation of the Test Ban Treaty. From that time on, American spacecraft carrying nuclear detonation detection instruments continuously provide the United States with a reliable technical ability to monitor Earth's ATMOSPHERE and outer space for nuclear treaty violations

- Dutch-American astronomer MAARTEN SCHMIDT discovers the first QUASAR
- 1964** ● Following a series of heartbreaking failures, NASA successfully launches the *RANGER 7* SPACECRAFT to the MOON from CAPE CANAVERAL on 24 July. About 68 hours after LIFTOFF, the robot SPACE PROBE transmits over 4,000 high-resolution television IMAGES before crashing into the LUNAR surface in a region known as the Sea of Clouds. The *Ranger 7, 8, and 9* spacecraft help prepare the way for the lunar landing missions by the APOLLO PROJECT ASTRONAUTS (1969–72)
- In August, the International Telecommunications Satellite Organization (INTELSAT) is formed—its mission to develop a global COMMUNICATIONS SATELLITE system
- On 12 October, the former Soviet Union launches the first three-person crew into OUTER SPACE when the specially configured two-person *Voskhod 1* SPACECRAFT is used to carry COSMONAUTS VLADIMIR M. KOMAROV, Boris Yegorov, and Konstantin Feoktistov into ORBIT around EARTH
- On 28 November, NASA's *MARINER 4* SPACECRAFT departs CAPE CANAVERAL on its historic journey as the first spacecraft from EARTH to visit MARS. It successfully encounters the RED PLANET on 14 July 1965 at a FLYBY distance of about 9,800 km. *Mariner 4's* close-up IMAGES reveal a barren, desertlike world and quickly dispel any pre-space age notions about the existence of ancient MARTIAN cities or a giant network of artificial canals
- 1965** ● German-American physicist ARNO ALLEN PENZIAS and American physicist ROBERT WOODROW WILSON detect the faint COSMIC MICROWAVE BACKGROUND considered by cosmologists to be the lingering signal from the BIG BANG explosion
- On 18 March, the former Soviet Union launches the *Voskhod 2* SPACECRAFT, carrying COSMONAUTS Pavel Belyayev and ALEXEI LEONOV. During this mission, Leonov becomes the

## CHRONOLOGY

1965

first person to leave the confines of an orbiting spacecraft and perform an EXTRAVEHICULAR ACTIVITY (EVA). While tethered, he conducts this historic 10-minute SPACE WALK. Then he encounters some significant difficulties when he tries to get back into the VOSKHOD's AIRLOCK with a bloated and cumbersome SPACESUIT. Their REENTRY proves equally challenging, as they land in an isolated portion of a snowy forest with only wolves to greet them. Rescuers arrive the next day, and the entire cosmonaut rescue group departs the improvised campsite on skis

- A TITAN II ROCKET carries ASTRONAUT VIRGIL "Gus" I. GRISSOM and JOHN W. YOUNG into ORBIT on 23 March from CAPE CANAVERAL inside a two-person GEMINI PROJECT SPACECRAFT. NASA's *Gemini 3* flight is the first crewed mission for the new spacecraft and marks the beginning of more sophisticated space activities by American crews in preparation for the APOLLO PROJECT LUNAR missions
- On 6 April, NASA places the *Intelsat-1 (Early Bird)* COMMUNICATIONS SATELLITE into ORBIT from CAPE CANAVERAL. It is the first commercial communications satellite placed into GEOSYNCHRONOUS ORBIT
- The Soviet Union launches its first communications satellite on 23 April. Designed to facilitate TELECOMMUNICATIONS across locations at high northern latitudes, the *Molniya 1A* spacecraft uses a special highly elliptical, 12-hour orbit (about 500 km by 12,000 km). This type of orbit is now called a MOLNIYA ORBIT
- On 3 June, NASA launches the *Gemini 4* mission from CAPE CANAVERAL with ASTRONAUTS James McDivitt and EDWARD H. WHITE II as the crew. During this NASA GEMINI PROJECT mission, astronaut White conducts the first American SPACE WALK, spending about 21 minutes on a tether outside the SPACECRAFT
- In December, NASA expands the scope of the GEMINI PROJECT activities. *Gemini 7* lifts off on 4 December, carrying ASTRONAUTS FRANK BORMAN and JAMES ARTHUR LOVELL,



Astronaut White's space walk during *Gemini 4* mission (NASA)

## CHRONOLOGY

1965

JR., into OUTER SPACE for an almost 14-day mission. On 15 December, they are joined in ORBIT by the *Gemini 6* SPACECRAFT, carrying astronauts WALTER M. SCHIRRA and THOMAS P. STAFFORD. Once in ORBIT, the *Gemini 6* spacecraft comes within two meters of the *Gemini 7* “target spacecraft,” thereby accomplishing the first successful orbital RENDEZVOUS operation

- **1966** ● The former Soviet Union sends the *LUNA 9* SPACECRAFT to the MOON on 31 January. The 100 kg MASS spherical spacecraft makes a SOFT LANDING in the Ocean of Storms region on 3 February, rolls to a stop, opens four petal-like covers, and then transmits the first panoramic television IMAGES from the Moon’s surface
- On March 16, NASA launches the *Gemini 8* mission from CAPE CANAVERAL using a TITAN II ROCKET. ASTRONAUTS NEIL A. ARMSTRONG and DAVID R. SCOTT guide their SPACECRAFT to a Gemini AGENA target vehicle (GATV), accomplishing the first successful RENDEZVOUS and DOCKING operation between a crewed CHASER SPACECRAFT and an uncrewed target vehicle. However, after an initial period of stable flight, the docked spacecraft begin to tumble erratically. Only quick, corrective action by the astronauts prevents a major space disaster. They make an emergency REENTRY and are recovered in a contingency landing zone in the Pacific Ocean
- The Soviet Union launches the *LUNA 10* to the MOON on 31 March. This massive (1,500 kg) SPACECRAFT becomes the first human-made object to achieve ORBIT around the Moon
- On May 30, NASA sends the *SURVEYOR 1* LANDER SPACECRAFT to the MOON. The versatile ROBOT SPACECRAFT successfully makes a SOFT LANDING (1 June) in the Ocean of Storms. It then transmits over 10,000 IMAGES from the LUNAR surface and performs numerous soil mechanics experiments in preparation for the APOLLO PROJECT human-landing missions
- In mid-August, NASA sends the *LUNAR ORBITER 1* SPACECRAFT to the MOON from CAPE CANAVERAL. It is the first of five



*Gemini 6* spacecraft as viewed from *Gemini 7* spacecraft (NASA)



successful missions to collect detailed IMAGES of the Moon from lunar ORBIT. At the end of each mapping mission, the ORBITER spacecraft is intentionally crashed into the Moon to prevent interference with future orbital activities

- On 12 September, NASA launches the *Gemini 11* mission from CAPE CANAVERAL. The GEMINI PROJECT SPACECRAFT with ASTRONAUTS CHARLES (PETE) CONRAD, JR., and RICHARD F. GORDON, JR., quickly accomplishes RENDEZVOUS and DOCKING with an AGENA target vehicle. The astronauts then use the Agena's restartable ROCKET engine to propel themselves (in this docked configuration) to a record-setting ALTITUDE of 1,370 km—the highest ever flown by an EARTH-orbiting, human-crewed spacecraft
- 1967** ● On 27 January, disaster strikes NASA's APOLLO PROJECT. While inside their *Apollo 1* SPACECRAFT during a training exercise on LAUNCH PAD 34 at CAPE CANAVERAL, ASTRONAUTS VIRGIL "GUS" I. GRISSOM, EDWARD H. WHITE, JR., and ROGER B. CHAFFEE are killed when a flash fire sweeps through their SPACE CAPSULE. The MOON landing program is delayed by 18 months, while major design and safety changes are made in the Apollo spacecraft
- On 23 April, tragedy also strikes the Russian space program when the Soviets launch COSMONAUT VLADIMIR M. KOMAROV in the new SOYUZ (union) SPACECRAFT. Following an orbital mission plagued with difficulties, Komarov is killed (on 24 April) during emergency REENTRY operations when the spacecraft's parachute fails to deploy properly and the vehicle impacts the ground at high speed
- On 27 and 30 October (respectively), the Soviet Union launches two uncrewed SOYUZ-type SPACECRAFT, called *COSMOS 186* and *188*. On 30 October, the orbiting spacecraft accomplish the first automatic RENDEZVOUS and DOCKING operation. The craft then separate and are recovered on 31 October and 2 November
- 1968** ● NASA launches the *Apollo 7* mission into ORBIT around EARTH. ASTRONAUTS WALTER M. SCHIRRA, DONN F. EISELE,

and R. WALTER CUNNINGHAM perform a variety of orbital operations with the redesigned APOLLO PROJECT SPACECRAFT

- On 21 December, NASA's *Apollo 8* SPACECRAFT (Command and Service Module only) departs Launch Complex 39 at the KENNEDY SPACE CENTER during the first flight of the mighty SATURN V LAUNCH VEHICLE with a human crew as part of the PAYLOAD. ASTRONAUTS FRANK BORMAN, JAMES ARTHUR LOVELL, JR., and WILLIAM A. ANDERS become the first people to leave EARTH's gravitational influence. They go into orbit around the MOON and capture IMAGES of an incredibly beautiful Earth "rising" above the starkly barren LUNAR horizon—pictures that inspire millions and animate an emerging environmental movement. After 10 orbits around the Moon, the first lunar astronauts return safely to Earth (27 December)

- 1969** ● In a full dress rehearsal for the first MOON landing, NASA's *Apollo 10* mission departs the KENNEDY SPACE CENTER on 18 May. ASTRONAUTS EUGENE A. CERNAN, JOHN W. YOUNG, and THOMAS P. STAFFORD successfully demonstrate the complete APOLLO PROJECT mission profile and evaluate the performance of the LUNAR MODULE (LM) down to within 15 km of the LUNAR surface

- The entire world watches as NASA's *Apollo 11* mission leaves for the MOON on 16 July from the KENNEDY SPACE CENTER. ASTRONAUTS NEIL A. ARMSTRONG, MICHAEL COLLINS, and EDWIN E. "BUZZ" ALDRIN, JR., make a long-held dream of humanity a reality. On 20 July, American Neil Armstrong cautiously descends the steps of the LUNAR MODULE's ladder and steps onto the LUNAR surface, exclaiming: "That's one small step for [a] man, one giant leap for mankind." He and Buzz Aldrin become the first two people to walk on another world. Many people regard the APOLLO PROJECT lunar landings as the greatest technical accomplishment in all human history

- On 14 November, NASA's *Apollo 12* mission lifts off from the KENNEDY SPACE CENTER. ASTRONAUTS CHARLES

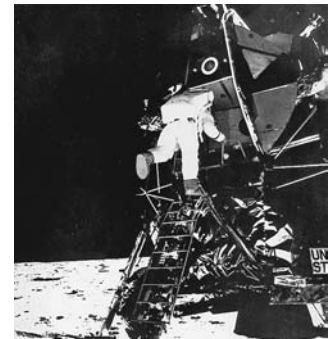

First Moon landing, 20 July 1969 (Courtesy of NASA)

## CHRONOLOGY

1970

(PETE) CONRAD, JR., RICHARD F. GORDON, JR., and ALAN L. BEAN continue the scientific objectives of the APOLLO PROJECT. Conrad and Bean become the third and fourth “Moon walkers,” collecting samples from a larger area and deploying the APOLLO LUNAR SURFACE EXPERIMENT PACKAGE (ALSEP)

- **1970** ● NASA’s *Apollo 13* mission leaves for the MOON on 11 April. Suddenly, on 13 April, a life-threatening explosion occurs in the service module portion of the Apollo SPACECRAFT. ASTRONAUTS JAMES ARTHUR LOVELL, JR., JOHN LEONARD SWIGERT, and FRED WALLACE HAISE, JR., must use their LUNAR MODULE (LM) as a lifeboat. While an anxious world waits and listens, the crew rides their disabled spacecraft around the Moon. With critical supplies running low, they limp back to EARTH on a free-return TRAJECTORY. At just the right moment on 17 April, they abandon the LM *Aquarius* and board the APOLLO PROJECT spacecraft (command module) for a successful atmospheric REENTRY and recovery in the Pacific Ocean
- The Soviet Union launches its *VENERA 7* mission to VENUS on 17 August. When the spacecraft arrives on 15 December, a PROBE is parachuted into the dense VENUSIAN ATMOSPHERE. Subsequent analysis of the data from this hardy instrumented capsule confirms that it has landed on the surface. It records an ambient temperature of approximately 475°C and an atmospheric pressure that is 90 times the pressure found at sea level on EARTH. It is the first successful transmission of scientific data from the surface of another PLANET
- On 12 September, the Soviet Union sends the *LUNA 16* ROBOT SPACECRAFT to the MOON. Russian engineers use TELEOPERATION of the spacecraft’s drill to collect about 100 g of LUNAR dust, which is then placed into a sample return canister. On 21 September, the canister leaves the lunar surface on a TRAJECTORY back to EARTH. Three days later, it lands in Russia. *Luna 16* is the first robot spacecraft to return a sample of material from another world. In similar missions, *Luna 20* (February 1972) and *Luna 24* (August 1976)

## CHRONOLOGY

1970

return automatically collected lunar samples, while *Luna 18* (September 1971) and *Luna 23* (October 1974) land on the Moon but fail to return samples for various technical reasons

- On November 10, the Soviet Union launches another interesting robot mission to the MOON. *Luna 17* lands in the Sea of Rains. On command from Earth, a 750 kg robot ROVER (called *LUNAKHOD 1*) rolls down an extended ramp and begins exploring the LUNAR surface. Russian engineers use TELEOPERATION to control this eight-wheeled rover as it travels for months across the lunar surface—transmitting more than 20,000 television IMAGES and performing more than 500 soil tests at various locations. The mission represents the first successful use of a mobile, remotely controlled (teleoperated) robot vehicle to explore another planetary body. The *Luna 23* mission in January 1973 successfully deploys another rover (*Lunakhod 2*). However, the technical significance of these machine missions is all but ignored in the global glare of NASA'S APOLLO PROJECT and its incredible human triumphs

- 1971** ● NASA sends the *Apollo 14* mission to the MOON on 31 January. While ASTRONAUT STUART ALLEN ROOSA orbits overhead in the APOLLO PROJECT SPACECRAFT, astronauts ALAN B. SHEPARD, JR., and EDGAR DEAN MITCHELL descend to the LUNAR surface. After departing the LUNAR MODULE (LM), they become the fifth and sixth Moon walkers
- On 19 April, the Soviet Union launches the first SPACE STATION (called *SALYUT 1*). It remains initially uninhabited because the three-COSMONAUT crew of the *SOYUZ 10* mission (launched on 22 April) attempts to dock with the station but cannot go on board
  - At the end of May, NASA launches the *MARINER 9* SPACECRAFT to MARS with an ATLAS-CENTAUR ROCKET. The spacecraft successfully enters ORBIT around the PLANET on 13 November 1971 and provides numerous IMAGES of the MARTIAN surface
  - The second Russian spaceflight tragedy occurs in late June. The fatal accident takes place as the crew separates from

*SALYUT 1* to return to EARTH in their *SOYUZ 11* SPACECRAFT after spending 22 days on board the SPACE STATION. While not wearing pressure suits for REENTRY, COSMONAUTS Victor Patseyev, Vladislav Volkov, and Georgi Dobrovolsky suffocate when a pressure valve malfunctions and the air rushes out of their *Soyuz 11* spacecraft. On 30 June, a startled recovery team on Earth finds all three men dead inside their spacecraft

- On July 26, NASA launches the *Apollo 15* mission to the MOON. ASTRONAUT ALFRED MERRILL WORDEN remains in the APOLLO PROJECT SPACECRAFT orbiting the Moon, while astronauts DAVID R. SCOTT and JAMES BENSON IRWIN become the seventh and eighth Moon walkers. They also are the first persons to drive a motor vehicle (electric powered) on another world, using their LUNAR ROVER to scoot across the surface
- 1972**
- In early January, President Richard M. Nixon approves NASA's SPACE SHUTTLE program. This decision shapes the major portion of NASA's program for the next three decades
  - On 2 March, an ATLAS-CENTAUR LAUNCH VEHICLE successfully sends NASA's *PIONEER 10* SPACECRAFT from CAPE CANAVERAL on its historic mission. This far-traveling ROBOT SPACECRAFT becomes the first to transit the MAIN-BELT ASTEROIDS, the first to encounter JUPITER (3 December 1973), and then by crossing the ORBIT of NEPTUNE on 13 June 1983 (which at the time was the farthest PLANET from the SUN), the first human-made object ever to leave the planetary boundaries of the SOLAR SYSTEM. Now on an INTERSTELLAR trajectory, *Pioneer 10* (and its twin, *Pioneer 11*) carries a special plaque, greeting any intelligent alien civilization that might find it drifting through interstellar space millions of years from now
  - On 16 April, NASA launches the *Apollo 16* mission—the fifth human-landing mission to the MOON. While ASTRONAUT THOMAS K. MATTINGLY II orbits the Moon in the APOLLO PROJECT SPACECRAFT, astronauts JOHN W. YOUNG and CHARLES MOSS DUKE, JR., become the ninth and tenth Moon

walkers. They also use the battery-powered LUNAR ROVER to travel across the Moon's surface in the Descartes LUNAR HIGHLANDS

- NASA places a new type of SATELLITE, called the *Earth Resources Technology Satellite-1 (ERTS-1)*, into a SUN-SYNCHRONOUS ORBIT from VANDENBERG AIR FORCE BASE on 23 July. Renamed *LANDSAT-1*, it is the first civilian SPACECRAFT to provide relatively high-resolution, multispectral IMAGES of EARTH'S surface, creating a revolution in the way people look at their home PLANET. Over the next three decades, a technically evolving family of LANDSAT spacecraft helps scientists study the EARTH SYSTEM
- On 7 December, NASA's *Apollo 17* mission, the last expedition to the MOON in the 20th century, departs from the KENNEDY SPACE CENTER, propelled by a mighty SATURN V ROCKET. While ASTRONAUT RONALD E. EVANS remains in lunar orbit, fellow astronauts EUGENE A. CERNAN and HARRISON H. SCHMITT become the 11th and 12th members of the exclusive Moon walkers club. By using a LUNAR ROVER, they explore the Taurus-Littrow region. Their safe return to EARTH on 19 December brings to a close one of the epic periods of human exploration

**1973** ● In early April, while propelled by an ATLAS-CENTAUR ROCKET, NASA's *PIONEER 11* SPACECRAFT departs on an INTERPLANETARY journey from CAPE CANAVERAL. The spacecraft ENCOUNTERS JUPITER (2 December 1974) and then uses a GRAVITY ASSIST maneuver to establish a FLYBY TRAJECTORY to SATURN. It is the first spacecraft to view Saturn at close range (encountered on 1 September 1979) and then follows a path into INTERSTELLAR space

- On 14 May, NASA launches *SKYLAB*—the first American SPACE STATION. A giant SATURN V ROCKET is used to place this large facility into ORBIT. The first crew of three American ASTRONAUTS arrives on 25 May and makes the emergency repairs necessary to save the station, which suffered damage

during LAUNCH. Astronauts CHARLES (PETE) CONRAD, JR., Paul J. Weitz, and Joseph P. Kerwin stay on board for 28 days. They are replaced by Astronauts ALAN L. BEAN, Jack R. Lousma, and Owen K. Garriott, who arrive on 28 July and live in space for about 59 days. The final *Skylab* crew (Astronauts Gerald P. Carr, William R. Pogue, and EDWARD G. GIBSON) arrive on 11 November and reside in the station until 8 February 1974—setting a spaceflight endurance record (for the time) of 84 days. *Skylab* is then abandoned

- In early November, NASA launches the *MARINER 10* SPACECRAFT from CAPE CANAVERAL. It ENCOUNTERS VENUS (5 February 1974) and uses a GRAVITY ASSIST maneuver to become the first spacecraft to investigate MERCURY at close range
- 1974** ● On 30 May, NASA launches the *Applications Technology Satellite (ATS)-6*, which demonstrates the use of a large ANTENNA structure on a GEOSTATIONARY ORBIT COMMUNICATIONS SATELLITE to transmit good-quality television signals to small, inexpensive ground receivers
- 1975** ● In June, the Soviet Union sends twin *VENERA 9* and *10* SPACECRAFT to VENUS. *Venera 9* (launched 8 June) goes into ORBIT around Venus on 22 October. It releases a LANDER that reaches the surface and transmits the first television images of the PLANET's infernolike landscape. *Venera 10* (launched 14 June) follows a similar mission profile
- In July, the United States and the Soviet Union conduct the first cooperative international RENDEZVOUS and DOCKING mission, called the APOLLO-SOYUZ TEST PROJECT (ASTP). On 15 July, the Russians launch the *SOYUZ 19* SPACECRAFT with COSMONAUTS ALEXEI ARKHIPOVICH LEONOV and Valerie N. Kubasov onboard. Several hours later, NASA launches the *Apollo 18* spacecraft with ASTRONAUTS THOMAS P. STAFFORD, Vance D. Brand, and DEKE SLAYTON, JR., on board
- In late August and early September, NASA launches the twin *Viking 1* (20 August) and *Viking 2* (9 September) ORBITER/LANDER combination SPACECRAFT to the RED PLANET from

CAPE CANAVERAL. After arriving at MARS in 1976, all VIKING PROJECT spacecraft (two landers and two orbiters) perform exceptionally well—but the detailed search for microscopic ALIEN LIFE-FORMS on the MARTIAN surface remains inconclusive

- On 16 October, NASA launches the *Geostationary Operational Environmental Satellite (GOES-1)* for the U.S. NATIONAL OCEANIC AND ATMOSPHERIC ADMINISTRATION (NOAA). It is the first in a long series of operational METEOROLOGICAL SATELLITES that monitor weather conditions on a hemispheric scale—providing warnings about hurricanes and other severe weather patterns
- 1976** ● NASA launches the first *laser geodynamics* satellite (*LAGEOS*) on 6 May into a precise orbit around EARTH from VANDENBERG AIR FORCE BASE. The heavy but small (60 cm diameter), golf ball-shaped SPACECRAFT has its surface completely covered with mirrorlike retroreflectors. This joint NASA-Italian Space Agency project demonstrates the use of ground-to-satellite laser-ranging systems in the study of solid Earth dynamics, an important part of EARTH SYSTEM science
- 1977** ● On 20 August, NASA sends the *VOYAGER 2* SPACECRAFT from CAPE CANAVERAL on an epic grand tour mission during which it encounters all four JOVIAN PLANETS and then departs the SOLAR SYSTEM on an INTERSTELLAR TRAJECTORY. By using GRAVITY ASSIST maneuvers, *Voyager 2* visits JUPITER (9 July 1979), SATURN (25 August 1981), URANUS (24 January 1986), and NEPTUNE (25 August 1989). The resilient, far-traveling spacecraft (and its twin, *Voyager 1*) also carries a special interstellar message from EARTH—a digital record entitled *The Sounds of Earth*
- On 5 September, NASA sends the *VOYAGER 1* SPACECRAFT from CAPE CANAVERAL on its fast TRAJECTORY journey to JUPITER (5 March 1979), SATURN (12 March 1980), and beyond the SOLAR SYSTEM
- In late September, the Soviet Union launches the *SALYUT 6* SPACE STATION—a second-generation design with



## CHRONOLOGY

### 1978 – 1979

several important improvements, including an additional DOCKING port and the use of automated *PROGRESS* resupply SPACECRAFT

- NASA launches *Meteosat-1* from CAPE CANAVERAL on 22 November for the EUROPEAN SPACE AGENCY (ESA). Upon reaching GEOSTATIONARY ORBIT, it becomes Europe's first WEATHER SATELLITE
- 1978**
- In May, the British Interplanetary Society releases its PROJECT DAEDALUS report—a conceptual study about a one-way robot SPACECRAFT mission to BARNARD'S STAR at the end of the 21st century
  - NASA successfully launches the PIONEER VENUS MISSION ORBITER (*Pioneer 12*) from CAPE CANAVERAL on 20 May. After arriving 4 December, it becomes the first American spacecraft to ORBIT VENUS. It uses its radar mapping system (from 1978–92) to image extensively the hidden surface of the cloud-enshrouded PLANET
  - American astronomer James Christy discovers PLUTO's large MOON CHARON on 22 June
  - In early August, NASA launches the PIONEER VENUS Multiprobe (*Pioneer 13*), which ENCOUNTERS the PLANET on 9 December and releases four PROBES into the VENUSIAN ATMOSPHERE
  - During a visit to NASA's KENNEDY SPACE CENTER on 1 October, President Jimmy Carter publicly mentions that American RECONNAISSANCE SATELLITES have made immense contributions to international security
- 1979**
- When unable to maintain its own ORBIT, the abandoned NASA SKYLAB becomes a dangerous orbiting derelict that eventually decays in a dramatic fiery plunge through EARTH'S ATMOSPHERE on 11 July—a REENTRY that leaves debris fragments scattered over remote regions of western Australia
  - On 24 December, the EUROPEAN SPACE AGENCY (ESA) successfully launches the first *ARIANE 1* ROCKET from the GUIANA SPACE CENTER in Kourou, French Guiana

## CHRONOLOGY

### 1978 – 1979

*Skylab* debris footprint  
(Courtesy of NASA)

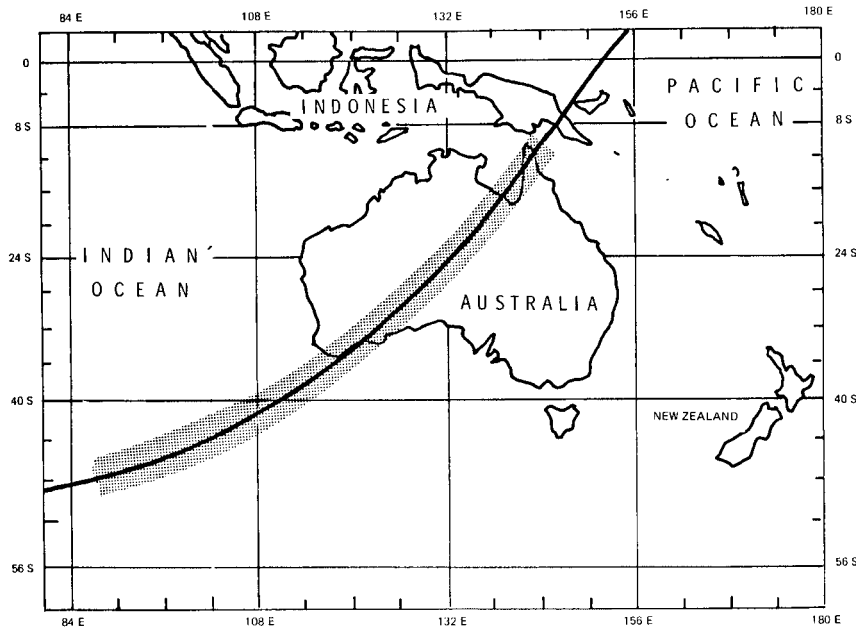

**1980** ● India's Space Research Organization (ISRO) successfully places a modest 35 kg test SATELLITE (called *Rohini*) into LOW EARTH ORBIT on 1 July. The LAUNCH VEHICLE is a four-stage, SOLID-PROPELLANT ROCKET manufactured in India. The SLV-3 (Standard Launch Vehicle-3) gives India independent national access to OUTER SPACE

**1981** ● On 12 April, NASA launches the SPACE SHUTTLE *Columbia* on its maiden orbital flight from Complex 39-A at the KENNEDY SPACE CENTER. ASTRONAUTS JOHN W. YOUNG and ROBERT L. CRIPPEN thoroughly test the new AEROSPACE VEHICLE. Upon REENTRY, it becomes the first SPACECRAFT to return to EARTH by gliding through the ATMOSPHERE and landing like an airplane. Unlike all previous one-time use SPACE VEHICLES, *Columbia* is prepared for other missions in OUTER SPACE

● In Autumn, the Soviet Union sends the *VENERA 13* and *14* SPACECRAFT to VENUS. *Venera 13* departs on 30 October,

## CHRONOLOGY

1982 – 1984

and its LANDER touches down on the VENUSIAN surface on 1 March 1982. *Venera 14* lifts off on 4 November 1981, and its capsule lands on Venus on 5 March 1982. Both hardy robot landers successfully return color IMAGES of the infernolike surface of Venus and perform the first soil-sampling experiments on that PLANET

- **1982** ● On 11 November, NASA launches the SPACE SHUTTLE *Columbia* with a crew of four ASTRONAUTS on the first operational flight (called STS-5) of the U.S. SPACE TRANSPORTATION SYSTEM
- **1983** ● An expendable DELTA ROCKET places the Infrared Astronomy Satellite (IRAS) into a POLAR ORBIT from VANDENBERG AIR FORCE BASE on 25 January. The international scientific SPACECRAFT (NASA-United Kingdom-Netherlands) completes the first comprehensive (all-sky) INFRARED RADIATION survey of the UNIVERSE
  - The first flight of the *Challenger* occurs on 4 April when NASA launches the STS-6 SPACE SHUTTLE mission. During the mission, ASTRONAUTS Donald Peterson and Story Musgrave put on their SPACESUITS and perform the first EXTRAVEHICULAR ACTIVITY (EVA) from an orbiting Shuttle.
  - On 18 June, NASA launches the space shuttle *Challenger* (STS-7 mission) with astronaut SALLY K. RIDE—the first American woman to travel in OUTER SPACE
  - In late August, the space shuttle *Challenger* (STS-8 mission) flies into SPACE with an ASTRONAUT crew of five, including GUION S. BLUFORD, JR.—first African American to orbit EARTH
- **1984** ● In his State of the Union Address on 25 January, President Ronald Reagan calls for a permanent American SPACE STATION. However, his vision must wait until December 1998, when a combined ASTRONAUT and COSMONAUT crew assembles the first two components of the *INTERNATIONAL SPACE STATION* as part of the STS-88 SPACE SHUTTLE mission

## CHRONOLOGY

1982 – 1984

- The Soviet Union launches the *SOYUZ T-12* SPACECRAFT on 17 July. The spacecraft carries three COSMONAUTS, including Svetlana Savitskaya. While the *Soyuz T-12* docks with the *SALYUT-7* SPACE STATION, she performs a series of experiments in OUTER SPACE during an EXTRAVEHICULAR ACTIVITY (EVA)—becoming the first female space walker
- During the STS 41-G SPACE SHUTTLE mission (launched 5 October), astronaut KATHRYN D. SULLIVAN becomes the first American woman to perform an EXTRAVEHICULAR ACTIVITY (EVA)
- 1985** ● On 12 April, NASA’s SPACE SHUTTLE *Discovery* carries U.S. Senator “Jake” Garn into ORBIT as a member of the ASTRONAUT crew of the STS 51-D mission
- 1986** ● On 24 January, NASA’s *VOYAGER 2* SPACECRAFT encounters URANUS
  - On 28 January, the SPACE SHUTTLE *Challenger* lifts off from the NASA KENNEDY SPACE CENTER on its final voyage. At just under 74 seconds into the STS 51-L mission, a deadly explosion occurs, killing the crew and destroying the vehicle. Led by President Ronald Reagan, the United States mourns the seven ASTRONAUTS lost in the *CHALLENGER* ACCIDENT
  - In late February, the Soviet Union launches the first segment of a third-generation SPACE STATION—the modular orbiting complex called *MIR* (peace)
  - In March, an international armada of SPACECRAFT ENCOUNTER COMET HALLEY. The EUROPEAN SPACE AGENCY’s *GIOTTO* spacecraft makes and survives the most hazardous FLYBY—streaking within 610 km of the COMET’S NUCLEUS on 14 March at a relative velocity of 68 km/s
- 1987** ● In late February, SUPERNOVA 1987A is observed in photographic IMAGES of the LARGE MAGELLANIC CLOUD by Canadian astronomer Ian Shelton. It is the first supernova visible to the NAKED EYE since the one discovered by JOHANNES KEPLER in 1604

## CHRONOLOGY

*Challenger* launch ascent  
accident on January 28, 1986  
(NASA)

1988 – 1989



- 1988** ● On 19 September, the State of Israel uses a *Shavit* (comet) three-stage ROCKET to place the country's first SATELLITE (called *Ofeq 1*) into an unusual east-to-west ORBIT—one that is opposite to the direction of EARTH'S ROTATION but necessary because of launch safety restrictions
- As the *Discovery* successfully lifts off on the STS-26 mission, NASA returns the SPACE SHUTTLE to service following a 32-month hiatus after the *CHALLENGER* ACCIDENT
- 1989** ● During the STS-30 mission in early May, the ASTRONAUT crew of the SPACE SHUTTLE *Atlantis* deploys NASA's *MAGELLAN* SPACECRAFT and sends it on an INTERPLANETARY TRAJECTORY TO VENUS
- On 25 August, the *VOYAGER 2* SPACECRAFT encounters NEPTUNE
  - During the STS-34 mission in mid-October, the SPACE SHUTTLE *Atlantis* deploys NASA's *GALILEO* SPACECRAFT for its long INTERPLANETARY journey to JUPITER

## CHRONOLOGY

1988 – 1989

- In mid-November, NASA launches the *COSMIC BACKGROUND EXPLORER (COBE)* into a POLAR ORBIT from VANDENBERG AIR FORCE BASE. The SPACECRAFT carefully measures the COSMIC MICROWAVE BACKGROUND, helping scientists answer key questions about the BIG BANG explosion
- 1990** ● NASA officially begins the Voyager Interstellar Mission (VIM) on 1 January. This is an extended mission in which both VOYAGER SPACECRAFT search for the HELIOPAUSE
- During the STS-31 mission in late April, the ASTRONAUT crew of the SPACE SHUTTLE *Discovery* deploys the NASA *HUBBLE SPACE TELESCOPE (HST)* into ORBIT around EARTH. Subsequent shuttle missions (in 1993, 1997, 1999, 2002, and 2008) repair design flaws and perform maintenance on this orbiting optical OBSERVATORY
- 1991** ● In early April, NASA uses the SPACE SHUTTLE *Atlantis* to deploy the *COMPTON GAMMA RAY OBSERVATORY (GRO)*—a major EARTH-orbiting astrophysical OBSERVATORY that investigates the UNIVERSE in the GAMMA RAY portion of the ELECTROMAGNETIC (EM) SPECTRUM
- On its way to JUPITER, NASA's *GALILEO* SPACECRAFT passes within 1,600 km of the ASTEROID 951 Gaspra. The ENCOUNTER provides the first close-up IMAGES of a MAIN-BELT ASTEROID. Gaspra is a type-S (silicaceous) asteroid about 19 × 12 × 11 km in size
- 1992** ● On 11 February, the NATIONAL SPACE DEVELOPMENT AGENCY OF JAPAN (NASDA) successfully launches that country's first EARTH-OBSERVING SPACECRAFT from the Tanegashima Space Center using a Japanese-manufactured H-1 ROCKET. NASDA becomes the JAPANESE SPACE EXPLORATION AGENCY (JAXA) in October 2003
- NASA successfully launches the *Mars Observer (MO)* SPACECRAFT from CAPE CANAVERAL on 25 September. For unknown reasons, all contact with the spacecraft is lost in late August 1993—just a day or so before it is to go into ORBIT around MARS

## CHRONOLOGY

1993 – 1995

- 1993** ● While coasting to JUPITER, NASA's *GALILEO* SPACECRAFT encounters Ida (a MAIN-BELT ASTEROID) on 28 August at a distance of 2,400 km. *Galileo's* imagery reveals that Ida has a tiny SATELLITE of its own, named DACTYL
  - In early December during the STS-61 mission, the ASTRONAUT crew of the SPACE SHUTTLE *Endeavour* perform a complicated in-orbit repair of NASA's *HUBBLE SPACE TELESCOPE*—thereby restoring the orbiting OBSERVATORY to its planned scientific capabilities
- 1994** ● In late January, a joint Department of Defense and NASA advanced technology demonstration SPACECRAFT, called *Clementine*, lifts off for the MOON from VANDENBERG AIR FORCE BASE. Some of the SPACECRAFT's data suggest that the Moon may actually possess significant quantities of water ice in its permanently shadowed polar regions
  - On 3 February, SPACE SHUTTLE *Discovery* lifts off from the NASA KENNEDY SPACE CENTER. The six-person crew of the STS-60 mission includes COSMONAUT SERGEI KRIKALEV—the first Russian to travel into OUTER SPACE using an American LAUNCH VEHICLE
  - In March, the U.S. Air Force successfully launches the final SATELLITE in the GLOBAL POSITIONING SYSTEM (GPS), and the NAVIGATION SATELLITE system becomes fully operational. GPS revolutionizes navigation on land, at sea, and in the air for numerous military and civilian users
  - In mid-July, fragments of COMET Shoemaker-Levy 9 slam into the PLANET JUPITER, causing observable disturbances in the Jovian ATMOSPHERE that persist for many months
- 1995** ● In February during NASA's STS-63 mission, the SPACE SHUTTLE *Discovery* approaches (ENCOUNTERS) the Russian *MIR* SPACE STATION as a prelude to the development of the *INTERNATIONAL SPACE STATION (ISS)*. ASTRONAUT EILEEN MARIE COLLINS serves as the first female shuttle pilot
  - On 14 March, the Russians launch the *SOYUZ TM-21* (UNION) SPACECRAFT to the *MIR* space station from the BAIKONUR

## CHRONOLOGY

1993 – 1995

COSMODROME. The crew of three includes American ASTRONAUT Norman Thagard—the first American to travel into OUTER SPACE on a Russian ROCKET and the first to stay on the *Mir* space station. The *Soyuz TM-21* COSMONAUTS also relieve the previous *Mir* crew, including cosmonaut Valeriy Polyakov, who returns to EARTH on 22 March after setting a world record for remaining in space for 438 days

- In late June, NASA'S SPACE SHUTTLE *Atlantis* docks with the Russian *MIR* SPACE STATION for the first time. During this shuttle mission (STS-71), *Atlantis* delivers the *Mir 19* crew (COSMONAUTS Anatoly Solovyev and Nikolai Budarin) to the Russian space station and then returns the *Mir 18* crew back to EARTH—including American ASTRONAUT Norman Thagard, who has just spent 115 days in space on board the *Mir*. The shuttle-*Mir* docking program is the first phase of the *INTERNATIONAL SPACE STATION (ISS)*. A total of nine shuttle-*Mir* docking missions will occur between 1995–98
- In early December, NASA'S *GALILEO* SPACECRAFT arrives at JUPITER and starts its multiyear scientific mission by successfully deploying a PROBE into the Jovian ATMOSPHERE

- 1996**
- In late March, the SPACE SHUTTLE *Atlantis* delivers ASTRONAUT SHANNON W. LUCID, who becomes a COSMONAUT researcher and the first American woman to live on the Russian *MIR* SPACE STATION
  - In the summer, a NASA research team from the Johnson Space Center announces that they have found evidence within a MARTIAN METEORITE (called ALH84001) that “strongly suggests primitive life may have existed on MARS more than 3.6 billion years ago.” The Martian microfossil hypothesis touches off a great deal of technical debate
  - In mid-September, the SPACE SHUTTLE *Atlantis* docks with the Russian *MIR* SPACE STATION and returns ASTRONAUT SHANON W. LUCID to EARTH after she spends 188 days on board the *Mir*—setting a new U.S. and world spaceflight record for a woman



*Atlantis* docking with *Mir* space station in July 1995 (NASA)



## CHRONOLOGY

1997 – 1998

- NASA launches the *MARS GLOBAL SURVEYOR (MGS)* on 7 November and then the *MARS PATHFINDER* on 4 December from CAPE CANAVERAL
- 1997** ● In February, the ASTRONAUT crew of the SPACE SHUTTLE *Discovery* (STS-82 mission) successfully accomplishes the second *HUBBLE SPACE TELESCOPE (HST)*-servicing mission
- 1998** ● In early January, NASA sends the *LUNAR PROSPECTOR* to the MOON from CAPE CANAVERAL. Data from this ORBITER SPACECRAFT reinforces previous hints that the LUNAR polar regions may contain large reserves of water ice in a mixture of frozen dust lying at the frigid bottom of some permanently shadowed CRATERS
- On 29 October, the SPACE SHUTTLE *Discovery* (STS-95 mission) lifts off from the NASA KENNEDY SPACE CENTER. Its crew includes ASTRONAUT (U.S. Senator) JOHN HERSCHEL GLENN, JR.—who returns to OUTER SPACE after 36 years



Astronaut Shannon Lucid exercises inside *Mir* space station in 1996 (NASA)

## CHRONOLOGY

1997 – 1998

and becomes the oldest person (at age 77) to experience spaceflight in the 20th century

- In early December, the space shuttle *Endeavour* ascends from the NASA KENNEDY SPACE CENTER on the first assembly mission of the *INTERNATIONAL SPACE STATION (ISS)*. During the STS-88 shuttle mission, *Endeavour* performs a RENDEZVOUS with the previously launched Russian-built ZARYA module. An international crew connects this module with the American-built UNITY module carried in the shuttle's CARGO BAY

- **1999** ● In July, ASTRONAUT EILEEN MARIE COLLINS serves as the first female SPACE SHUTTLE commander (STS-93 mission) as the *Columbia* carries NASA's *CHANDRA X-RAY OBSERVATORY (CXO)* into ORBIT
- After a successful LAUNCH from CAPE CANAVERAL (11 December 1998) and an uneventful INTERPLANETARY trip, NASA loses all contact with the *Mars Climate Orbiter (MCO)*

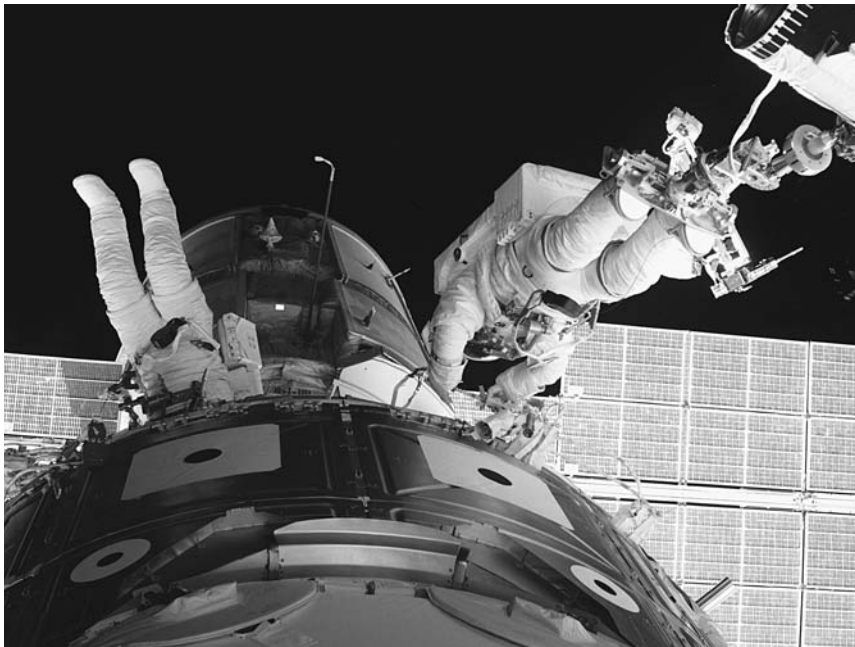

*Endeavour's* astronauts perform first *International Space Station* assembly mission on December 4, 1998 (NASA)

## CHRONOLOGY



Computer-enhanced rendering of *Chandra X-ray Observatory* (NASA/MSFC)

## 2000 – 2002

as it approaches the RED PLANET on 23 September. A TRAJECTORY calculation error has most likely caused the ORBITER SPACECRAFT to approach the MARTIAN ATMOSPHERE too steeply and burn up

- On 3 December, NASA also loses all contact with the *Mars Polar Lander* mission just prior to its arrival at MARS. Although successfully launched from CAPE CANAVERAL on 3 January, it is the second NASA mission to fail upon arrival at the RED PLANET in 1999

**2000** ● Aware of the growing SPACE (ORBITAL) DEBRIS problem, NASA SPACECRAFT controllers intentionally de-orbit the massive *COMPTON GAMMA RAY OBSERVATORY* on 4 June at the end of its useful mission. This insures that any pieces surviving atmospheric REENTRY will fall safely into a remote part of the Pacific Ocean

**2001** ● NASA launches the 2001 *MARS ODYSSEY* mission to the RED PLANET in early April—the SPACECRAFT orbits the PLANET in October

- On 23 March, Russian officials intentionally de-orbit the decommissioned *MIR* SPACE STATION, which has become a large space derelict. Their action assures that any components surviving atmospheric REENTRY will fall harmlessly into a remote part of the Pacific Ocean

**2002** ● In February, NASA's 2001 *MARS ODYSSEY* SPACECRAFT starts using its collection of scientific instruments to begin a detailed study of the RED PLANET

- In March, a seven-member ASTRONAUT crew flies NASA's SPACE SHUTTLE *Columbia* into ORBIT around EARTH as part of the STS-109 mission to successfully service and upgrade the *HUBBLE SPACE TELESCOPE*
- On 4 May, NASA successfully launches its *AQUA* SPACECRAFT from VANDENBERG AIR FORCE BASE. This sophisticated EARTH-OBSERVING SPACECRAFT joins the *TERRA* spacecraft in performing EARTH SYSTEM SCIENCE studies

## CHRONOLOGY

## 2000 – 2002

- The U.S. Department of Defense forms the U.S. Strategic Command as the control center for all American strategic (nuclear) forces on 1 October. USSTRATCOM also conducts military space operations, strategic warning and intelligence assessment, and global strategic planning
- 2003**
- On 1 February, while gliding back to EARTH after a successful 16-day scientific research mission (STS-107), the SPACE SHUTTLE *Columbia* experiences a catastrophic REENTRY accident at an ALTITUDE of about 63 km over the western United States. Traveling at 18 times the speed of sound the ORBITER vehicle disintegrates, taking the lives of all seven crew members: six American ASTRONAUTS (Rick Husband, William McCool, Michael Anderson, Kalpana Chawla, Laurel Clark, and David Brown) and the first Israeli astronaut (Ilan Ramon)
  - NASA's MARS EXPLORATION ROVER *Spirit* is launched by a DELTA II ROCKET to the RED PLANET on 10 June. *Spirit*, also known as MER-A, arrives safely on MARS on 3 January 2004 and begins its teleoperated surface-exploration mission under the supervision of mission controllers at the NASA Jet Propulsion Laboratory
  - NASA launches the second MARS EXPLORATION ROVER (MER), called *Opportunity*, using a DELTA II ROCKET from CAPE CANAVERAL on 7 July. *Opportunity*, also called MER-B, successfully lands on the RED PLANET on 24 January 2004 and starts its teleoperated surface exploration mission under the supervision of mission controllers at the NASA Jet Propulsion Laboratory
  - On August 25, NASA launches the *SPITZER SPACE TELESCOPE*
- 2004**
- On 1 July, NASA's *Cassini* SPACECRAFT arrives at SATURN and begins its four-year primary mission of detailed scientific investigation
  - A DELTA II ROCKET lifts off from VANDENBERG AIR FORCE BASE on 15 July and successfully places the NASA's *AURA* SPACECRAFT into a POLAR ORBIT around EARTH



Mars exploration rover (MER) *Spirit* (Rendering courtesy of NASA)

## CHRONOLOGY



*Spitzer Space Telescope (SST)*  
(Rendering courtesy of NASA/  
JPL-Caltech)

## 2005 – 2006

- In mid-October, the Expedition 10 crew, riding a Russian LAUNCH VEHICLE from the BAIKONUR COSMODROME, arrives at the *INTERNATIONAL SPACE STATION* and the Expedition 9 crew returns safely to EARTH
  - On 24 December, the *HUYGENS* PROBE successfully separates from the CASSINI MISSION MOTHER SPACECRAFT and begins its journey to SATURN'S largest MOON, TITAN
- 2005**
- On 14 January, the *HUYGENS* PROBE enters the ATMOSPHERE of TITAN and successfully reaches the surface some 147 minutes later. *Huygens* is the first SPACECRAFT to land on a moon in the outer SOLAR SYSTEM
  - On 4 July, NASA'S DEEP IMPACT MISSION successfully encounters Comet Tempel 1
  - NASA launches the SPACE SHUTTLE *Discovery* on the STS-114 mission on 26 July from the KENNEDY SPACE CENTER. After docking with the *INTERNATIONAL SPACE STATION*, the *Discovery* returns to EARTH and lands at Edwards Air Force Base, California, on 9 August
  - On 12 August, NASA launches the *MARS RECONNAISSANCE ORBITER* from CAPE CANAVERAL
  - The Expedition 12 crew (Commander William McArthur and Flight Engineer Valery Tokarev) arrives at the *INTERNATIONAL SPACE STATION* on 3 October and replaces the Expedition 11 crew
  - On 12 October, the People's Republic of China successfully launches its second human spaceflight mission, using the *SHENZHOU 6* SPACECRAFT. Two TAIKONAUTS, Fei Junlong and Nie Haisheng, travel in SPACE for almost five days and make 76 ORBITS of EARTH before returning safely by making a parachute-assisted SOFT LANDING in northern Inner Mongolia
- 2006**
- On 15 January, the material collection package from NASA'S STARDUST MISSION SPACECRAFT successfully returns to EARTH. This package contains material samples from Comet Wild 2

## CHRONOLOGY

## 2005 – 2006

- NASA launches the NEW HORIZONS PLUTO–KUIPER BELT FLYBY MISSION from CAPE CANAVERAL on 19 January and successfully sends the ROBOT SPACECRAFT on its long-duration, one-way mission to conduct a scientific ENCOUNTER with the DWARF PLANET PLUTO (in 2015) and then go on to explore portions of the KUIPER BELT
- Follow-up observations by NASA's *HUBBLE SPACE TELESCOPE*, reported by scientists on 22 February, help confirm the presence of two new MOONS around the DWARF PLANET PLUTO. The moons, named Nix and Hydra, were first discovered by the *Hubble Space Telescope* in May 2005, but the science team wanted to validate the discovery with additional observational data
- On 9 March, NASA scientists announce that the CASSINI MISSION SPACECRAFT may have found evidence of liquid water reservoirs that erupt in Yellowstone Park–like geysers on SATURN'S MOON Enceladus
- On 10 March, NASA's *MARS RECONNAISSANCE ORBITER* successfully arrives at MARS and begins a six-month long process of adjusting and trimming the shape of its ORBIT around the RED PLANET prior to performing its operational mapping mission
- The Expedition 13 crew (Commander Pavel Vinogradov and Flight Engineer Jeff Williams) arrive at the *INTERNATIONAL SPACE STATION* on 1 April and replace the Expedition 12 crew. Joining them for several days before returning back to EARTH with the Expedition 12 crew is Brazil's first ASTRONAUT, Marcos Pontes
- NASA launches the SPACE SHUTTLE *Discovery* on 4 July. The STS-121 mission features continued shuttle safety testing and a trip to the *INTERNATIONAL SPACE STATION*
- On 24 August, the members of the INTERNATIONAL ASTRONOMICAL UNION (IAU) meet for the organization's 2006 General Assembly in Prague, the Czech Republic. After much heated debate, the 2,500 assembled professional

astronomers decide (by vote) to demote PLUTO from its traditional status as one of the nine MAJOR PLANETS and place the object into a new class, called the DWARF PLANETS. The IAU decision now leaves the SOLAR SYSTEM with eight major planets, and three dwarf planets: Pluto (which serves as the prototype dwarf planet), CERES (the largest ASTEROID), and the large, distant KUIPER BELT object known as ERIS. Astronomers anticipate the discovery of other dwarf planets in the distant parts of the solar system

- On 9 September, NASA launches the SPACE SHUTTLE *Atlantis* on the STS-115 mission to the *INTERNATIONAL SPACE STATION*. During this mission, the shuttle crew delivers and installs the SPACE STATION's P3/P4 truss structure. *Atlantis* lands at the KENNEDY SPACE CENTER on 21 September, successfully completing the 12-day mission
  - The Expedition 14 crew (Commander Michael Lopez-Alegria, Flight Engineer Mikhail Tyurin) arrives at the *INTERNATIONAL SPACE STATION* on 20 September and replaces the Expedition 13 crew
  - On 9 December, NASA launches the SPACE SHUTTLE *Discovery* on the STS-116 mission to the *INTERNATIONAL SPACE STATION*. American ASTRONAUT SUNITA WILLIAMS joins the Expedition 14 crew of the *ISS* and ESA astronaut Thomas Reiter returns to EARTH onboard *Discovery*, which lands at the KENNEDY SPACE CENTER on 22 December
- 2007**
- The Expedition 15 crew (Commander Fyodor N. Yurchikhin, Flight Engineer Oleg V. Kotov, and Spaceflight Participant Charles Simonyi) arrives at the *INTERNATIONAL SPACE STATION* on 9 April and replaces the Expedition 14 crew
  - On 8 June, the SPACE SHUTTLE *Atlantis* lifts off from the KENNEDY SPACE CENTER on the STS-117 mission. This mission delivers equipment to the *International Space Station*. Expedition 15 flight engineer SUNITA WILLIAMS returns to EARTH aboard the shuttle when it lands at Edwards Air Force Base on 22 June

- NASA successfully launches the PHOENIX MARS MISSION from CAPE CANAVERAL on 4 August. The ROBOT SPACECRAFT is designed to make a SOFT LANDING and explore a scientifically interesting site in the northern polar region of the RED PLANET
  - On 8 August, NASA successfully launches the SPACE SHUTTLE *Endeavour* on the STS-118 mission to the *INTERNATIONAL SPACE STATION*. ASTRONAUT Barbara R. Morgan, originally selected in 1980s for NASA's teacher-in-space project as a backup to S. CHRISTA CORRIGAN MCAULIFFE, serves as a member of the shuttle crew
  - NASA successfully launches the DAWN MISSION on 27 September from CAPE CANAVERAL. Using its ION ENGINES for propulsion, the *Dawn* ROBOT SPACECRAFT will RENDEZVOUS with and ORBIT two interesting objects in the ASTEROID BELT: the large ASTEROID VESTA (in 2011–2012) and the DWARF PLANET CERES (in 2015)
  - The Expedition 16 crew (Commander Peggy Whitson, Flight Engineer Yuri Malenchenko, Spaceflight Participant Sheikh Muszaphar Shukor) arrives at the *INTERNATIONAL SPACE STATION* on 12 October and replaces the Expedition 15 crew
  - On 23 October, NASA launches the SPACE SHUTTLE *Discovery* on the STS-120 mission. This, the 23rd shuttle mission to the *INTERNATIONAL SPACE STATION*, successfully delivers the Italian-built U.S. multi-port module called Harmony to the station
- 2008** ● On 14 January, NASA's *MESSENGER* SPACECRAFT performs the first of three planned FLYBYS of MERCURY—astronautical maneuvers intended to ease the ROBOT SPACECRAFT into a stable working ORBIT around the innermost PLANET by March 2011. Once in this working orbit, the spacecraft will begin its primary science mission
- NASA's PHOENIX MARS MISSION ROBOT SPACECRAFT makes a successful SOFT LANDING in the northern polar region of MARS on 25 May and begins its search for subsurface *water ice*



- On 11 June, NASA successfully launches the *FERMI GAMMA-RAY SPACE TELESCOPE* into ORBIT around EARTH from CAPE CANAVERAL
- NASA's robot ROVER *Opportunity* begins to head back to the plains surrounding Victoria Crater on 26 August, after spending nearly an Earth year descending into this large MARTIAN CRATER. Although showing signs of aging, the twin rovers: *Spirit* and *Opportunity* continue to function and explore different portions of the surface of the RED PLANET
- On 13 November, NASA scientists announce that the *HUBBLE SPACE TELESCOPE* has taken the first visible-LIGHT IMAGE of a PLANET circling another STAR. Estimated at three times the MASS of JUPITER, the planet, called Fomalhaut b, orbits the star Fomalhaut, located 25 LIGHT-YEARS away in the CONSTELLATION Piscis Australis (the Southern Fish)
- The SPACE SHUTTLE *Endeavour* lands successfully on 30 November at Edwards Air Force Base, California, at the completion of the very successful STS-126 mission to the *INTERNATIONAL SPACE STATION*

---

SECTION FOUR

# CHARTS & TABLES

**Special units for astronomical investigations**

Astronomical unit (*AU*): The mean distance from Earth to the Sun—approximately  $1.495979 \times 10^{11}$  m

Light-year (*ly*): The distance light travels in 1 year’s time—approximately  $9.46055 \times 10^{15}$  m

Parsec (*pc*): The parallax shift of 1 second of arc (3.26 light-years)—approximately  $3.085768 \times 10^{16}$  m

Speed of light (*c*):  $2.9979 \times 10^8$  m/s

Source: NASA.

**International System (SI) units and their conversion factors**

Quantity	Name of unit	Symbol	Conversion factor
distance	meter	m	1 km = 0.621 mi.
			1 m = 3.28 ft.
			1 cm = 0.394 in.
			1 mm = 0.039 in.
			1 $\mu$ m = $3.9 \times 10^{-5}$ in. = 104 Å
mass	kilogram	kg	1 tonne = 1.102 tons
			1 kg = 2.20 lb.
			1 g = 0.0022 lb. = 0.035 oz.
time	second	s	1 mg = $2.20 \times 10^{-6}$ lb. = $3.5 \times 10^{-5}$ oz.
			1 yr. = $3.156 \times 10^7$ s
			1 day = $8.64 \times 10^4$ s
			1 hr. = 3,600 s
temperature	kelvin	K	273 K = 0°C = 32°F
			373 K = 100°C = 212°F
area	square meter	m <sup>2</sup>	1 m <sup>2</sup> = 10 <sup>4</sup> cm <sup>2</sup> = 10.8 ft. <sup>2</sup>
volume	cubic meter	m <sup>3</sup>	1 m <sup>3</sup> = 10 <sup>6</sup> cm <sup>3</sup> = 35 ft. <sup>3</sup>
frequency	hertz	Hz	1 Hz = 1 cycle/s
density	kilogram per cubic meter	kg/m <sup>3</sup>	1 kHz = 1,000 cycles/s
			1 MHz = 10 <sup>6</sup> cycles/s
			1 kg/m <sup>3</sup> = 0.001 g/cm <sup>3</sup>
speed, velocity	meter per second	m/s	1 g/cm <sup>3</sup> = density of water
			1 m/s = 3.28 ft./s
			1 km/s = 2,240 mi./hr.
force	newton	N	1 N = 10 <sup>5</sup> dynes = 0.224 lbf
pressure	newton per square meter	N/m <sup>2</sup>	1 N/m <sup>2</sup> = $1.45 \times 10^{-4}$ lb./in. <sup>2</sup>
energy	joule	J	1 J = 0.239 cal
photon energy	electron volt	eV	1 eV = $1.60 \times 10^{-19}$ J; 1 J = 10 <sup>7</sup> erg
power	watt	W	1 W = 1 J/s
atomic mass	atomic mass unit	amu	1 amu = $1.66 \times 10^{-27}$ kg
wavelength of light	angstrom	Å	1 Å = 0.1 nm = 10 <sup>-10</sup> m
acceleration of gravity	g	g	1 g = 9.8 m/s <sup>2</sup>

Source: NASA.

**Common metric/English conversion factors (for space technology activities)**

	<b>Multiply</b>	<b>By</b>	<b>To obtain</b>
length	inches	2.54	centimeters
	centimeters	0.3937	inches
	feet	0.3048	meters
	meters	3.281	feet
	miles	1.6093	kilometers
	kilometers	0.6214	miles
	kilometers	0.54	nautical miles
	nautical miles	1.852	kilometers
	kilometers	3281	feet
	feet	0.0003048	kilometers
weight and mass	ounces	28.350	grams
	grams	0.0353	ounces
	pounds	0.4536	kilograms
	kilograms	2.205	pounds
	tons	0.9072	metric tons
liquid measure	metric tons	1.102	tons
	fluid ounces	0.0296	liters
	gallons	3.7854	liters
	liters	0.2642	gallons
temperature	liters	33.8140	fluid ounces
	degrees Fahrenheit plus 459.67	0.5555	kelvins
	degrees Celsius plus 273.16	1.0	kelvins
	kelvins	1.80	degrees Fahrenheit minus 459.67
	kelvins	1.0	degrees Celsius minus 273.16
thrust (force)	degrees Fahrenheit minus 32	0.5555	degrees Celsius
	degrees Celsius	1.80	degrees Fahrenheit plus 32
	pounds force	4.448	newtons
pressure	newtons	0.225	pounds
	millimeters mercury	133.32	pascals (newtons per square meter)
	pounds per square inch	6.895	kilopascals (1,000 pascals)
	pascals	0.0075	millimeters mercury at 0° C
	kilopascals	0.1450	pounds per square inch

Source: NASA.

**Recommended SI unit prefixes**

Prefix	Abbreviation	Factor by which unit is multiplied
tera-	T	$10^{12}$
giga-	G	$10^9$
mega-	M	$10^6$
kilo-	k	$10^3$
hecto-	h	$10^2$
centi-	c	$10^{-2}$
milli-	m	$10^{-3}$
micro-	$\mu$	$10^{-6}$
nano-	n	$10^{-9}$
pico-	p	$10^{-12}$

Source: NASA.

**Greek alphabet**

A	$\alpha$	alpha	N	$\nu$	nu
B	$\beta$	beta	$\Xi$	$\xi$	xi
$\Gamma$	$\gamma$	gamma	O	o	omicron
$\Delta$	$\delta$	delta	$\Pi$	$\pi$	pi
E	$\epsilon$	epsilon	P	$\rho$	rho
Z	$\zeta$	zeta	$\Sigma$	$\sigma$	sigma
H	$\eta$	eta	T	$\tau$	tau
$\Theta$	$\theta$	theta	Y	$\upsilon$	upsilon
I	$\iota$	iota	$\Phi$	$\phi$	phi
K	$\kappa$	kappa	X	$\chi$	chi
$\Lambda$	$\lambda$	lambda	$\Psi$	$\psi$	psi
M	$\mu$	mu	$\Omega$	$\omega$	omega

**Stellar spectral classes**

Type	Description	Typical surface temperature (K)	Remarks/Examples
O	very hot, large blue stars (hottest)	28,000–40,000	ultraviolet stars; very short lifetimes (3–6 million years)
B	large, hot blue stars	11,000–28,000	Rigel
A	blue-white, white stars	7,500–11,000	Vega, Sirius, Altair
F	white stars	6,000–7,500	Canopus, Polaris
G	yellow stars	5,000–6,000	the Sun
K	orange-red stars	3,500–5,000	Arcturus, Aldebaran
M	red stars (coolest)	<3,500	Antares, Betelgeuse

Source: NASA.

**Constellations of the zodiac**

**Spring Signs**

- ♈ Aries the Ram
- ♉ Taurus the Bull
- ♊ Gemini the Twins

**Summer Signs**

- ♋ Cancer the Crab
- ♌ Leo the Lion
- ♍ Virgo the Virgin

**Autumn Signs**

- ♎ Libra the Scales
- ♏ Scorpio the Scorpion
- ♐ Sagittarius the Archer

**Winter Signs**

- ♑ Capricorn the Goat
- ♒ Aquarius the Water Bearer
- ♓ Pisces the Fishes

**Keplerian elements**

- a** Semimajor Axis—gives the size of the orbit
- e** Eccentricity—gives the shape of the orbit
- i** Inclination Angle—gives the angle of the orbit plane to the central body’s equator
- $\Omega$  Right Ascension of the ascending node—which gives the rotation of the orbit plane from reference axis
- $\omega$  Argument of Perigee—gives the rotation of the orbit in its plane
- $\theta$  True Anomaly—gives the location of the satellite on the orbit

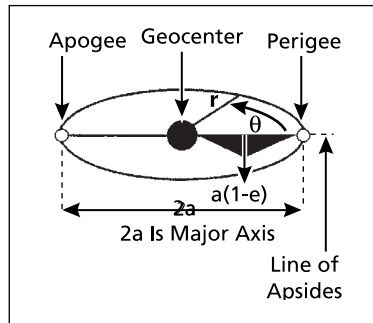

Source: NASA.

## The Constellations

In astronomy, a constellation is a configuration of the brightest stars in a moderately small region of the night sky that can be easily identified by the naked eye. The astronomical heritage of today's constellations began about 2500 B.C.E. with the ancient stargazers of Mesopotamia. Over time, the early Greek astronomers identified 48 so-called ancient constellations—all but one of which are now used. Today, astronomers have 88 officially recognized constellations. These are identified in two tables: the table of ancient constellations and the table of modern constellations. The modern constellations are groupings of (primarily southern hemisphere) stars which gained use in the 17th century at the start of the scientific revolution. Astronomers identify the approximate position on the celestial sphere of each officially recognized constellation by using two coordinates: right ascension (RA) and declination ( $\delta$ ). Right ascension is measured eastward around the celestial equator starting at the vernal equinox and is often expressed in hours (h), where one hour equals 15 degrees. Declination is the angular distance north ( $0^\circ$  to  $90^\circ$  positive) or south ( $0^\circ$  to  $90^\circ$  negative) of the celestial equator.

## The table of ancient constellations

Name/Meaning (Latin [English])	Genitive form of Latin name	Abbreviation	Approximate position (Equatorial coordinates)	
			RA (h)	$\delta$ ( $^{\circ}$ )
Andromeda (name: princess)	Andromedae	And	1	+40
Aquarius (water bearer)	Aquarii	Aqr	23	-15
Aquila (eagle)	Aquilae	Aql	20	+5
Ara (altar)	Arae	Ara	17	-55
Argo Navis (ship of Argonauts) now split into the modern constellations Carina, Puppis, Pyxis, and Vela				
Aries (ram)	Arietis	Ari	3	+20
Auriga (charioteer)	Aurigae	Aur	6	+40
Boötes (herdsman)	Boötis	Boo	15	+30
Cancer (crab)	Cancri	Cnc	9	+20
Canis Major (great dog)	Canis Majoris	CMa	7	-20
Canis Minor (little dog)	Canis Minoris	CMi	8	+5
Capricornus (sea goat)	Capricorni	Cap	21	-20
Cassiopeia (name: queen)	Cassiopeiae	Cas	1	+60
Centaurus (centaur)	Centauri	Cen	13	-50
Cepheus (name: king)	Cephei	Cep	22	+70
Cetus (whale)	Ceti	Cet	2	-10
Corona Austrina (southern crown)	Coronae Australis	CrA	19	-40
Corona Borealis (northern crown)	Coronae Borealis	CrB	16	+30
Corvus (crow)	Corvi	Crv	12	-20
Crater (cup)	Crateris	Crt	11	-15
Cygnus (swan)	Cygni	Cyg	21	+40
Delphinus (dolphin)	Delphini	Del	21	+10
Draco (dragon)	Draconis	Dra	17	+65
Equuleus (little horse)	Equulei	Equ	21	+10
Eridanus (name: river)	Eridani	Eri	3	-20
Gemini (twins)	Geminorum	Gem	7	+20
Hercules (name: hero)	Herculis	Her	17	+30
Hydra (sea serpent; monster)	Hydrae	Hya	10	-20
Leo (lion)	Leonis	Leo	11	+15
Lepus (hare)	Leporis	Lep	6	-20
Libra (scale; balance beam)	Librae	Lib	15	-15
Lupus (wolf)	Lupi	Lup	15	-45
Lyra (lyre)	Lyrae	Lyr	19	+40
Ophiuchus (serpent bearer)	Ophiuchii	Oph	17	0

*(continues)*



The table of ancient constellations (*continued*)

Name/Meaning (Latin [English])	Genitive form of Latin name	Abbreviation	Approximate position (Equatorial coordinates)	
			RA (h)	$\delta$ (°)
Orion (name: great hunter)	Orionis	Ori	5	0
Pegasus (name: winged horse)	Pegasi	Peg	22	+20
Perseus (name: hero)	Persei	Per	3	+45
Pisces (fish)	Piscium	Psc	1	+15
Piscis Austrinus (southern fish)	Piscis Austrini	PsA	22	-30
Sagitta (arrow)	Sagittae	Sge	20	+10
Sagittarius (archer)	Sagittarii	Sgr	19	-25
Scorpius (scorpion)	Scorpii	Sco	17	-40
Serpens (serpent)	Serpentis	Ser	17	0
Taurus (bull)	Tauri	Tau	4	+15
Triangulum (triangle)	Trianguli	Tri	2	+30
Ursa Major (great bear)	Ursae Majoris	UMa	11	+50
Ursa Minor (little bear)	Ursae Minoris	UMi	15	+70
Virgo (virgin; maiden)	Virginis	Vir	13	0

## The table of modern constellations

Name/Meaning (Latin [English])	Genitive form of Latin name	Abbreviation	Approximate position (Equatorial coordinates)	
			RA (h)	$\delta$ (°)
Antlia (air pump)	Antliae	Ant	10	-35
Apus (bird of paradise)	Apodis	Aps	16	-75
Caelum (sculptor's chisel)	Caeli	Cae	5	-40
Camelopardalis (giraffe)	Camelopardalis	Cam	6	+70
Canes Venatici (hunting dogs)	Canum Venaticorum	CVn	13	+40
Carina (keel)*	Carinae	Car	9	-60
Chamaeleon (chameleon)	Chamaeleontis	Cha	11	-80
Circinus (compass)	Circini	Cir	15	-60
Columba (dove)	Columbae	Col	6	-35
Coma Berenices (Berenice's Hair)	Comae Berenices	Com	13	+20
Crux (southern cross)	Crucis	Cru	12	-60
Dorado (swordfish)	Doradus	Dor	5	-65
Fornax (furnace)	Fornacis	For	3	-30
Grus (crane)	Gruis	Gru	22	-45
Horologium (clock)	Horologii	Hor	3	-60
Hydrus (water snake)	Hydri	Hyi	2	-75

Name/Meaning (Latin [English])	Genitive form of Latin name	Abbreviation	Approximate position (Equatorial coordinates)	
			RA (h)	$\delta$ (°)
Indus (Indian)	Indi	Ind	21	-55
Lacerta (lizard)	Lacertae	Lac	22	+45
Leo Minor (little lion)	Leonis Minoris	LMi	10	+35
Lynx (lynx)	Lyncis	Lyn	8	+45
Mensa (table mountain)	Mensae	Men	5	-80
Microscopium (microscope)	Microscopii	Mic	21	-35
Monoceros (unicorn)	Monocerotis	Mon	7	-5
Musca (fly)	Muscae	Mus	12	-70
Norma (carpenter's square)	Normae	Nor	16	-50
Octans (octant; navigation device)	Octantis	Oct	22	-85
Pavo (peacock)	Pavonis	Pav	20	-65
Phoenix (phoenix; mythical bird)	Phoenicis	Phe	1	-50
Pictor (painter's easel)	Pictoris	Pic	6	-55
Puppis (stern)*	Puppis	Pup	8	-40
Pyxis (nautical compass)*	Pyxidis	Pyx	9	-30
Reticulum (net)	Reticuli	Ret	4	-60
Sculptor (sculptor's workshop)	Sculptoris	Scl	0	-30
Scutum (shield)	Scuti	Sct	19	-10
Sextans (sextant)	Sextantis	Sex	10	0
Telescopium (telescope)	Telescopii	Tel	19	-50
Triangulum Australe (southern triangle)	Trianguli Australe	TrA	16	-65
Tucana (toucan)	Tucanae	Tuc	0	-65
Vela (sail)*	Velorum	Vel	9	-50
Volans (flying fish)	Volantis	Vol	8	-70
Vulpecula (fox)	Vulpeculae	Vul	20	+25

\* Originally part of ancient constellation *Argo Navis* (ship of Argonauts).



NASA's space shuttle (NASA)

**NASA space shuttle missions (1981–2008)**

<i>Year</i>	<i>Launches</i>
1981	STS-1, STS-2
1982	STS-3, STS-4, STS-5
1983	STS-6, STS-7, STS-8, STS-9
1984	STS 41-B, STS 41-C, STS 41-D, STS 41-G, STS 51-A
1985	STS 51-C, STS 51-D, STS 51-B, STS 51-G, STS 51-F, STS 51-I, STS 51-J, STS 61-A, STS 61-B
1986	STS 61-C, STS 51-L ( <i>Challenger</i> accident)
1987	No launches
1988	STS-26, STS-27
1989	STS-29, STS-30, STS-28, STS-34, STS-33
1990	STS-32, STS-36, STS-31, STS-41, STS-38, STS-35
1991	STS-37, STS-39, STS-40, STS-43, STS-48, STS-44
1992	STS-42, STS-45, STS-49, STS-50, STS-46, STS-47, STS-52, STS-53
1993	STS-54, STS-56, STS-55, STS-57, STS-51, STS-58, STS-61
1994	STS-60, STS-62, STS-59, STS-65, STS-64, STS-68, STS-66
1995	STS-63, STS-67, STS-71, STS-70, STS-69, STS-73, STS-74
1996	STS-72, STS-75, STS-76, STS-77, STS-78, STS-79, STS-80
1997	STS-81, STS-82, STS-83, STS-84, STS-94, STS-85, STS-86, STS-87
1998	STS-89, STS-90, STS-91, STS-95, STS-88
1999	STS-96, STS-93, STS-103
2000	STS-99, STS-101, STS-106, STS-92, STS-97
2001	STS-98, STS-102, STS-100, STS-104, STS-105, STS-108
2002	STS-109, STS-110, STS-111, STS-112, STS-113
2003	STS-107 ( <i>Columbia</i> accident)
2004	No launches
2005	STS-114
2006	STS-121, STS-115, STS-116
2007	STS-117, STS-118, STS-120
2008	STS-122, STS-123, STS-124, STS-126

*Source:* NASA (as of December 31, 2008).

## Launch Vehicles

## CHARTS & TABLES

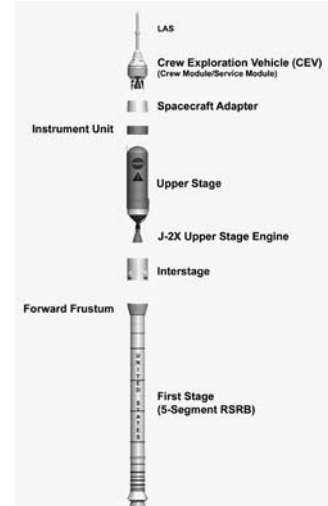
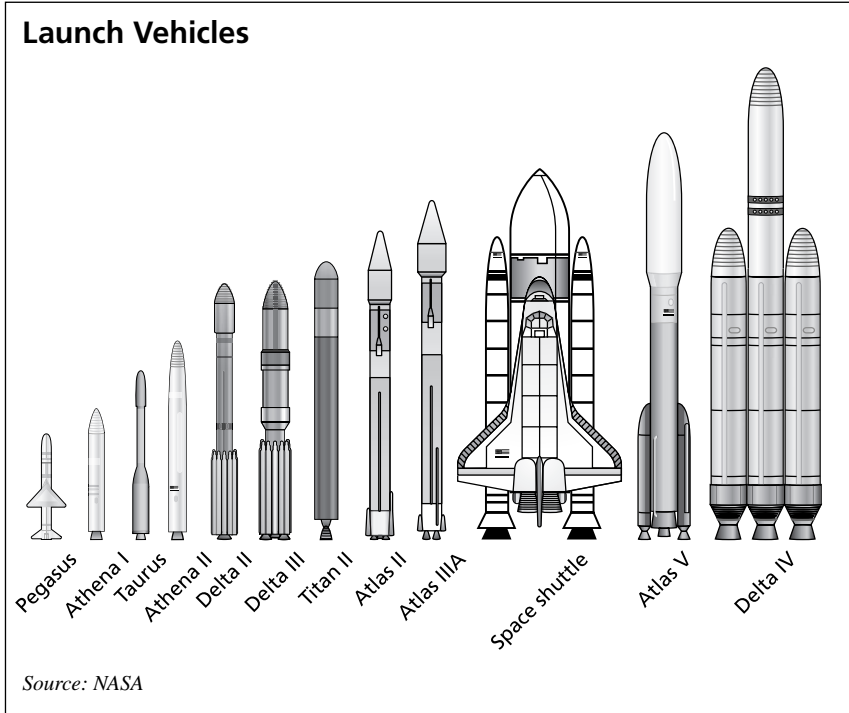

NASA's planned Ares I crew-carrying launch vehicle (NASA)

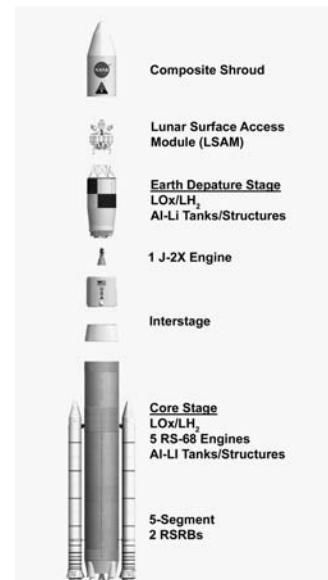

NASA's planned Ares V cargo-carrying launch vehicle (NASA)

## Launch Vehicles

## CHARTS & TABLES

**Characteristics of some of the world's launch vehicles**

<b>Country</b>	<b>Launch Vehicle</b>	<b>Stages</b>	<b>First launch</b>	<b>Performance</b>
China	Long March 2 (CZ-2C)	2 hypergolic, optional solid upper stage	1975	3,175 kg to LEO
	Long March 2F	2 hypergolic, 4 hypergolic strap-on rockets	1992	8,800 kg to LEO
	Long March 3	2 hypergolic, 1 cryogenic	1984	5,000 kg to LEO
	Long March 3A	2 hypergolic, 1 cryogenic	1994	8,500 kg to LEO
	Long March 4	3 hypergolic	1988	4,000 kg to LEO
Europe (ESA/France)	Ariane 40	2 hypergolic, 1 cryogenic	1990	4,625 kg to LEO
	Ariane 42P	2 hypergolic, 1 cryogenic, 2 strap-on solid rockets	1990	6,025 kg to LEO
	Ariane 42L	2 hypergolic, 1 cryogenic 2 hypergolic strap-on rockets	1993	3,550 kg to GTO
	Ariane 5	2 large solid boosters, cryogenic core, hypergolic upper stage	1996	18,000 kg to LEO, 6,800 kg to GTO
India	Polar Space Launch Vehicle (PSLV)	2 solid stages, 2 hypergolic, 6 strap-on solid rockets	1993	3,000 kg to LEO
Israel	Shavit	3 solid-rocket stages	1988	160 kg to LEO
Japan	M-3SII	3 solid-rocket stages, 2 strap-on solid rockets	1985	770 kg to LEO
	H-2	2 cryogenic, 2 strap-on solid rockets	1994	10,000 kg to LEO, 4,000 kg to GTO
Russia	Soyuz	2 cryogenic, 4 cryogenic strap-on rockets	1963	6,900 kg to LEO
	Rokot	3 hypergolic	1994	1,850 kg to LEO
	Tsyklon	3 hypergolic	1977	3,625 kg to LEO
	Proton (D-I)	3 hypergolic	1968	20,950 kg to LEO
	Energia	cryogenic core, 4 cryogenic strap-on rockets, optional cryogenic upper stages	1987	105,200 kg to LEO
USA	Athena I	2 solid stages	1995	800 kg to LEO
	Athena II	3 solid stages	1998	1,900 kg to LEO
	Atlas I	1-1/2 cryogenic lower stage, 1 cryogenic upper stage	1990	5,580 kg to LEO, 2,250 kg GTO
	Atlas II	1-1/2 cryogenic lower stage, 1 cryogenic upper stage	1991	6,530 kg to LEO, 2,800 kg to GTO
	Atlas III	cryogenic lower stage, cryogenic upper stage (Centaur)	2000	~10,000 kg to LEO, ~4,200 kg to GTO
	Atlas V	cryogenic lower stage, cryogenic upper stage (Centaur), various solid or liquid strap-ons	2002	10,300 kg to 20,000 kg to LEO (depending on strap-on configurations)
	Delta II	1 cryogenic, 1 hypergolic, 3, 4 or 9 strap-on solids	1990	900 kg to 2,170 kg to GTO depending on configuration
	Delta IV	cryogenic core stage with various cryogenic upper stages and solid or liquid strap-on rockets providing configurations from medium to heavy payload lift capacity	2002	8,600 kg to 25,800 kg to LEO (depending on configuration)

Country	Launch Vehicle	Stages	First launch	Performance
USA	Pegasus (aircraft-launched)	3 solid stages	1990	290 kg to LEO
	Space shuttle	2 large solid-rocket boosters, cryogenic core	1981	~25,000 kg to LEO
	Taurus	4 solid stages	1994	1,300 kg to LEO
	Titan IV	2 hyperbolic stages, 2 large Strap-on solid rockets, variety of upper stages	1989	18,100 kg to LEO

*LEO, low Earth orbit; GTO, geostationary transfer orbit.*  
*Source: NASA, DoD, and others.*

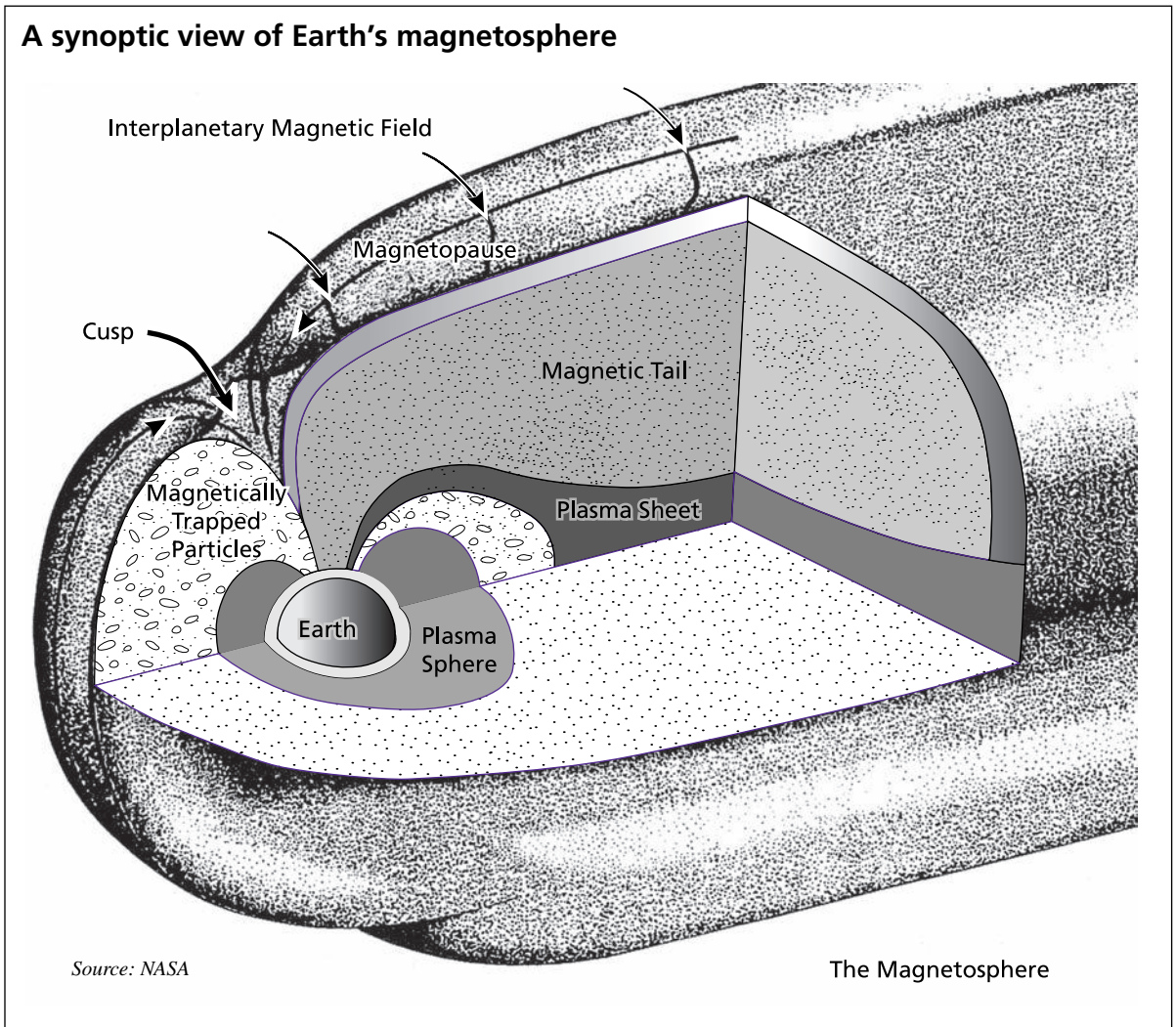

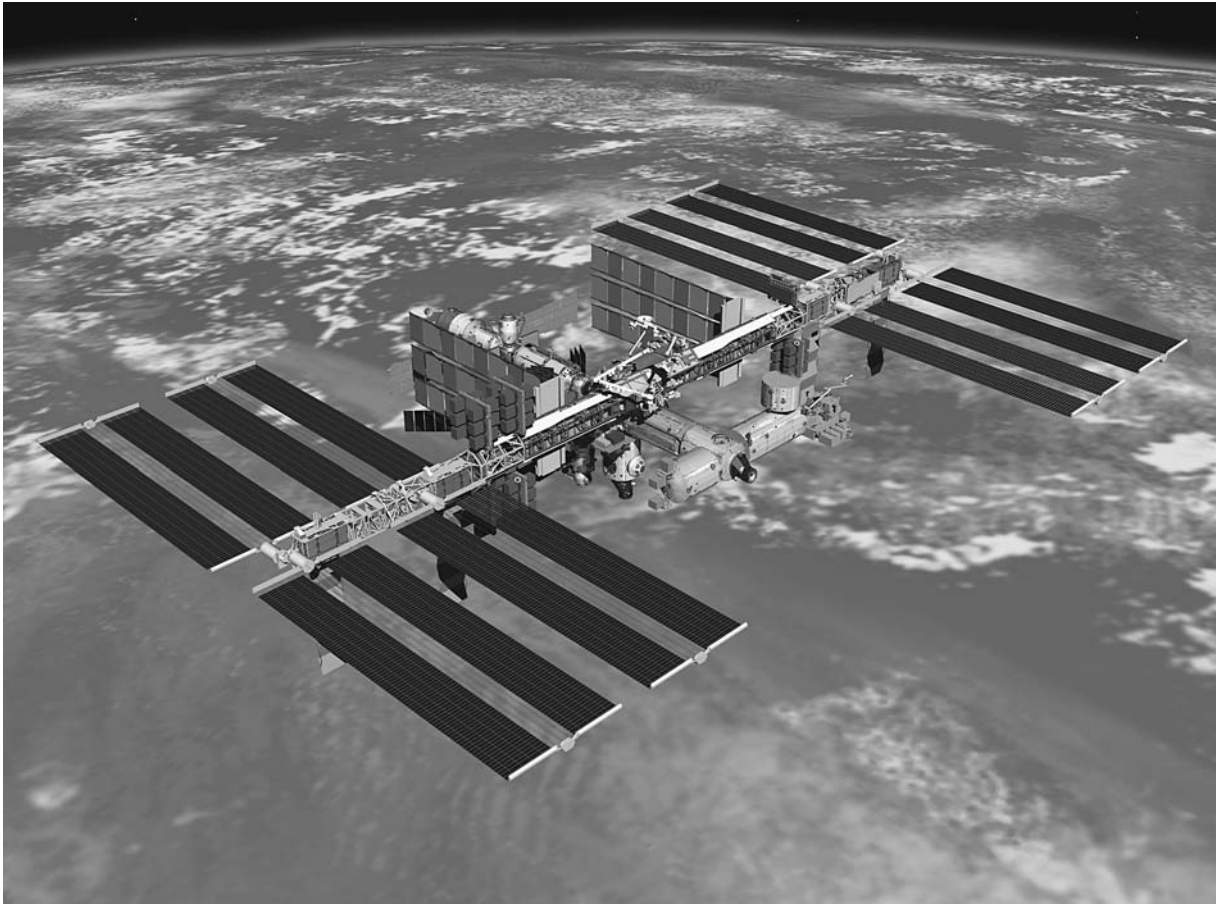

*International Space Station at completion (NASA)*



## Apollo Project summary

Spacecraft name	Crew	Date	Flight time (hours, minutes, seconds)	Revolutions	Remarks
<i>Apollo 7</i>	Walter H. Schirra Donn Eisele Walter Cunningham	10/11–22/68	260:8:45	163	First crewed Apollo flight demonstrated the spacecraft, crew, and support elements. All performed as required.
<i>Apollo 8</i>	Frank Borman James A. Lovell, Jr. William Anders	12/21–27/68	147:00:41	10 rev. of Moon	History's first crewed flight to the vicinity of another celestial body.
<i>Apollo 9</i>	James A. McDivitt David R. Scott Russell L. Schweikart	3/3–13/69	241:00:53	151	First all-up crewed Apollo flight (with <i>Saturn V</i> and command, service, and lunar modules). First Apollo extravehicular activity. First docking of command service module with lunar module (LM).
<i>Apollo 10</i>	Thomas P. Stafford John W. Young Eugene A. Cernan	5/18–26/69	192:03:23	31 rev. of Moon	Apollo LM descended to within 14.5 km of Moon and later rejoined command service module. First rehearsal in lunar environment.
<i>Apollo 11</i>	Neil A. Armstrong Michael Collins Edwin E. Aldrin, Jr.	7/16–24/69	195:18:35	30 rev. of Moon	First landing of a person on the Moon. Total stay time: 21 hr., 36 min.
<i>Apollo 12</i>	Charles Conrad, Jr. Richard F. Gordon, Jr. Alan L. Bean	11/14–24/69	244:36:25	45 rev. of Moon	Second crewed exploration of the Moon. Total stay time: 31 hr., 31 min.
<i>Apollo 13</i>	James A. Lovell, Jr. John L. Swigert, Jr. Fred W. Haise, Jr.	4/11–17/70	142:54:41	—	Mission aborted because of service module oxygen tank failure.
<i>Apollo 14</i>	Alan B. Shepard, Jr. Stuart A. Roosa Edgar D. Mitchell	1/31–2/9/71	216:01:59	34 rev. of Moon	First crewed landing in and exploration of lunar highlands. Total stay time: 33 hr., 31 min.
<i>Apollo 15</i>	David R. Scott Alfred M. Worden James B. Irwin	7/26–8/7/71	295:11:53	74 rev. of Moon	First use of lunar roving vehicle. Total stay time: 66 hr., 55 min.
<i>Apollo 16</i>	John W. Young Thomas K. Mattingly II Charles M. Duke, Jr.	4/16–27/72	265:51:05	64 rev. of Moon	First use of remote-controlled television camera to record liftoff of the lunar module ascent stage from the lunar surface. Total stay time: 71 hr., 2 min.
<i>Apollo 17</i>	Eugene A. Cernan Ronald E. Evans Harrison H. Schmitt	12/7–19/72	301:51:59	75 rev. of Moon	Last crewed lunar landing and exploration of the Moon in the Apollo Program returned 110 kg of lunar samples to Earth. Total stay time: 75 hr.

Source: NASA.

### Components of the natural space radiation environment

#### Galactic cosmic rays

Typically 85% protons, 13% alpha particles, 2% heavier nuclei

Integrated yearly fluence:

$1 \times 10^8$  protons/cm<sup>2</sup> (approximately)

Integrated yearly radiation dose:

4 to 10 rads (approximately)

#### Geomagnetically trapped radiation

Primarily electrons and protons

Radiation dose depends on orbital altitude

Crewed flights below 300 km altitude avoid Van Allen belts

#### Solar particle events

Occur sporadically; not predictable

Energetic protons and alpha particles

Solar-flare events may last for hours to days

Dose very dependent on orbital altitude and amount of shielding

### Skylab mission summary (1973–74)

Mission	Dates	Crew	Mission duration	Remarks
<i>Skylab 1</i>	Launched May 14, 1973	No crew	Reentered atmosphere July 11, 1979	90 metric-ton space station visited by three astronaut crews
<i>Skylab 2</i>	May 25, 1973–June 22, 1973	Charles Conrad, Jr. Paul J. Weitz Joseph P. Kerwin, M.D.	28 days, 49 min.	Repaired <i>Skylab</i> ; 392 hr. experiments; 3 EVAs
<i>Skylab 3</i>	July 28, 1973–September 25, 1973	Alan L Bean Jack R. Lousma Owen K. Garriott, Ph.D.	59 days, 11 hr.	Performed maintenance; 1,081 hr. experiments; 3 EVAs
<i>Skylab 4</i>	November 16, 1973–February 8, 1974	Gerald P. Carr William R. Pogue Edward G. Gibson, Ph.D.	84 days, 1 hr.	Observed Comet Kohoutek; 4 EVAs; 1,563 hr. experiments

### Russian space station experience

#### First-generation space stations (1964–77)

Name	Type	Launched	Remarks
<i>Salyut-1</i>	civilian	1971	first space station
no crew	civilian	1972	failure
<i>Salyut-2</i>	military	1973	first Almaz station; failure
<i>Cosmos 557</i>	civilian	1973	failure
<i>Salyut-3</i>	military	1974–75	Almaz station
<i>Salyut-4</i>	civilian	1974–77	
<i>Salyut-5</i>	military	1976–77	Last Almaz station

#### Second-generation space stations (1977–85)

<i>Salyut-6</i>	civilian	1977–82	highly successful
<i>Salyut-7</i>	civilian	1982–91	last staffed in 1986

#### Third-generation space stations (1986–2001)

<i>Mir</i>	civilian	1986–2001	first permanent space station
------------	----------	-----------	-------------------------------

Source: NASA.

### Expeditions to the *International Space Station* (2000–2008)

Expedition 1	<p>Launch: October 31, 2000            Land: March 8, 2001            Time: 140 days, 23 hours, 28 minutes            Crew: Commander William Shepherd, Soyuz Commander Yuri Gidzenko, Flight Engineer Sergei Krikalev</p>
Expedition 2	<p>Launch: March 8, 2001            Land: August 22, 2001            Time: 167 days, 6 hours, 41 minutes            Crew: Commander Yury Usachev, Flight Engineer Susan Helms, Flight Engineer James Voss</p>
Expedition 3	<p>Launch: August 10, 2001            Land: December 17, 2001            Time: 128 days, 20 hours, 45 minutes            Crew: Commander Frank Culbertson, Soyuz Commander Vladimir Dezhurov, Flight Engineer Mikhail Tyurin</p>
Expedition 4	<p>Launch: December 5, 2001            Land: June 19, 2002            Time: 195 days, 19 hours, 39 minutes            Crew: Commander Yury Onufrienko, Flight Engineer Dan Bursch, Flight Engineer Carl Walz</p>
Expedition 5	<p>Launch: June 6, 2002            Land: December 7, 2002            Time: 184 days, 22 hours, 14 minutes            Crew: Commander Valery Korzun, Flight Engineer Peggy Whitson, Flight Engineer Sergei Treschev</p>
Expedition 6	<p>Launch: November 23, 2002            Land: May 3, 2003            Time: 161 days, 19 hours, 17 minutes            Crew: Commander Ken Bowersox, Flight Engineer Nikolai Budarin, Flight Engineer Don Pettit</p>
Expedition 7	<p>Launch: April 25, 2003            Land: October 27, 2003            Time: 184 days, 21 hours, 47 minutes            Crew: Commander Yuri Malenchenko, Flight Engineer Ed Lu</p>
Expedition 8	<p>Launch: October 18, 2003            Land: April 29, 2004</p>

*(continues)*

### Expeditions to the *International Space Station* (2000–2008) (continued)

	<p>Time: 194 days, 18 hours, 35 minutes            Crew: Commander Michael Foale, Flight Engineer Alexander Kaleri, Flight Engineer (ESA) Pedro Duque*</p> <p>* <i>ESA astronaut Duque launched with Expedition 8 crew on Soyuz TMA-3 spacecraft and returned with Expedition 7 crew on Soyuz TMA-2 spacecraft.</i></p>
Expedition 9	<p>Launch: April 18, 2004            Land: October 23, 2004            Time: 187 days, 21 hours, 17 minutes            Crew: Commander Gennady Padalka, Flight Engineer Mike Fincke, Flight Engineer (ESA) André Kuipers*</p> <p>* <i>ESA astronaut Kuipers launched with Expedition 9 crew on Soyuz TMA-4 spacecraft and returned with Expedition 8 crew on Soyuz TMA-3 spacecraft.</i></p>
Expedition 10	<p>Launch: October 13, 2004            Land: April 24, 2005            Time: 192 days, 19 hours, 2 minutes            Crew: Commander Leroy Chiao, Flight Engineer Salizhan Sharipov, Flight Engineer Yuri Shargin*</p> <p>* <i>Cosmonaut Yuri Shargin launched with the Expedition 10 crew on Soyuz TMA-5 spacecraft and returned with Expedition 9 crew on Soyuz TMA-4 spacecraft.</i></p>
Expedition 11	<p>Launch: April 14, 2005            Land: October 10, 2005            Time: 179 days, 23 minutes            Crew: Commander Sergei Krikalev, Flight Engineer John Phillips, Flight Engineer (ESA) Roberto Vittori*</p> <p>* <i>ESA astronaut Vittori launched with Expedition 11 crew on Soyuz TMA-6 and returned to Earth with Expedition 10 crew on Soyuz TMA-5.</i></p>
Expedition 12	<p>Launch: September 30, 2005            Land: April 8, 2006            Time: 189 days, 19 hours, 53 minutes            Crew: Commander William McArthur, Flight Engineer Valery Tokarev, Space Flight Participant Gregory Olsen*</p> <p>* <i>Olsen launched with Expedition 12 crew on Soyuz TMA-7 and then returned to Earth with Expedition 11 crew on Soyuz TMA-6 under a commercial contract with the Russian Federal Space Agency.</i></p>

Expedition 13	<p>Launch: March 29, 2006            Land: September 28, 2006            Time: 182 days, 23 hours, 44 minutes            Crew: Commander Pavel Vinogradov, Flight Engineer Jeffrey Williams, Flight Engineer (ESA) Thomas Reiter*, Astronaut Marcos Pontes (Brazil)**</p> <p>* <i>Reiter is an ESA astronaut who joined Expedition 13 as part of STS-121 mission of space shuttle Discovery in July 2006.</i></p> <p>** <i>Brazilian astronaut Pontes launched with Expedition 13 crew on Soyuz TMA-8 and then returned to Earth with Expedition 12 crew on Soyuz TMA-7 under a commercial contract with the Russian Federal Space Agency.</i></p>
Expedition 14	<p>Launch: September 18, 2006            Land: April 21, 2007            Time: 215 days, 8 hours, 23 minutes            Crew: Commander Michael Lopez-Alegria, Flight Engineer Mikhail Tyurin, Flight Engineer (ESA) Thomas Reiter*, Flight Engineer Sunita Williams**, Spaceflight Participant Anousheh Ansari***</p> <p>* <i>European Space Agency astronaut Reiter joined Expedition 13 as part of STS-121 mission of space shuttle Discovery in July 2006, remained for part of Expedition 14, and then returned to Earth with crew of Discovery at the conclusion of the STS-116 mission. **NASA astronaut Williams launched with STS-116 crew on Discovery, joined the Expedition 14 crew, and then participated in Expedition 15, returning to Earth in June 2007 with space shuttle Atlantis crew at the conclusion of the STS-117 mission. ***Ansari is an American-Iranian businesswoman who launched with Expedition 14 crew on Soyuz TMA-9 and returned to Earth with Expedition 13 crew on Soyuz TMA-8 under a commercial contract with the Russian Federal Space Agency.</i></p>
Expedition 15	<p>Launch: April 7, 2007            Land: October 21, 2007            Time: 196 days, 17 hours, 17 minutes            Crew: Commander Fyodor Yurchikhin, Flight Engineer Oleg Kotov, Flight Engineer Sunita Williams*, Flight Engineer Clayton Anderson**, Spaceflight Participant Charles Simonyi***</p> <p>* <i>NASA astronaut Williams launched with STS-116 crew on Discovery, joined the Expedition 14 crew, and then participated</i></p>

(continues)

### Expeditions to the *International Space Station* (2000–2008) (continued)

	<p><i>in Expedition 15, returning to Earth in June 2007 with space shuttle Atlantis crew at the conclusion of the STS-117 mission.</i></p> <p><i>** NASA astronaut Clayton Anderson joined Expedition 15 after launching aboard the space shuttle Discovery on the STS-117 mission. He returned to Earth aboard the Discovery during the STS-120 mission.</i></p> <p><i>*** Spaceflight Participant Charles Simonyi launched with the Expedition 15 crew on Soyuz TMA-10 and returned to Earth with the Expedition 14 crew on Soyuz TMA-9.</i></p>
Expedition 16	<p>Launch: October 10, 2007</p> <p>Land: April 19, 2008</p> <p>Time: 191 days, 19 hours, 17 minutes</p> <p>Crew: Commander Peggy A. Whitson, Flight Engineer Yuri Malenchenko, Flight Engineer Clayton Anderson*, and Spaceflight Participant Sheikh Muszaphar Shukor**</p> <p><i>* NASA astronaut Clayton Anderson joined Expedition 15 after launching aboard the space shuttle Discovery on the STS-117 mission. He became part of Expedition 16 crew and then returned to Earth aboard the Discovery during the STS-120 mission.</i></p> <p><i>** Spaceflight Participant Sheikh Muszaphar Shukor launched with the Expedition 16 crew on Soyuz TMA-11 and returned to Earth with the Expedition 15 crew on Soyuz TMA-10.</i></p>
Expedition 17	<p>Launch: April 8, 2008</p> <p>Land: October 23, 2008</p> <p>Crew: Commander Sergei Volkov, Flight Engineer Oleg Kononenko, Flight Engineer Garrett E. Reisman*, Flight Engineer Gregory E. Chamitoff, and Spaceflight Participant So-yeon Yi**</p> <p><i>* NASA astronaut Garrett E. Reisman joined Expedition 16 as a flight Engineer during STS-123 mission of space shuttle Endeavour, remained onboard ISS as part of Expedition 17 crew, and then returned to Earth on June 14 onboard the space shuttle Discovery at the conclusion of the STS-124 mission.</i></p> <p><i>** Spaceflight Participant So-yeon Yi (from South Korea) launched with the Expedition 17 crew on Soyuz TMA-12 and returned to Earth with the Expedition 16 crew on Soyuz TMA-11.</i></p>

Source: NASA; data as of January 23, 2009.

## Properties of Earth–The Major Planets

## CHARTS & TABLES

### Physical and dynamic properties of Earth

diameter (equatorial)	12,756 km
(polar)	12,714 km
mass	$5.97 \times 10^{24}$ kg
density (average)	$5,515 \text{ kg/m}^3$
composition	rocks, metals
acceleration of gravity (at surface)	$9.8 \text{ m/s}^2$
escape velocity	11.2 km/s
period of rotation (a sidereal day)	23.934 hours
axial tilt (inclination of equator)	$23.45^\circ$
distance from the Sun (average)	$149.6 \times 10^6 \text{ km}$ (1.00 AU)
perihelion distance	$147.1 \times 10^6 \text{ km}$ (0.983 AU)
aphelion distance	$152.1 \times 10^6 \text{ km}$ (1.017 AU)
orbital velocity	29.8 km/s
orbital period (a sidereal year)	365.256 days
orbital eccentricity	0.0167
global magnetic field	yes
ring system	none
number of moons	1 (the Moon)
solar irradiance (at 1.00AU)	$1,370 \pm 5 \text{ W/m}^2$ (the solar constant)
albedo (Bond)	0.306
surface temperature	288 K (average) 185 K (minimum) to 331K (maximum)
atmosphere	1 bar ( $1 \times 10^5 \text{ Pa}$ ) pressure at surface main components: nitrogen ( $\text{N}_2$ ) (78.08 percent by volume); oxygen ( $\text{O}_2$ ) (20.95 percent); small amounts of water vapor ( $\text{H}_2\text{O}$ ), argon (Ar), carbon dioxide ( $\text{CO}_2$ ), methane ( $\text{CH}_4$ ), neon (Ne), and helium (He)
discovered by	known to ancients
date of discovery	prehistoric times; but not widely regarded as just another planet in solar system until Copernican revolution (16th century)
namesake	name <i>Earth</i> comes from early Germanic noun <i>ertho</i> meaning ground; in Greek mythology Gaia was the goddess of Earth, as was the goddess Tellus (meaning fertile soil) in Roman mythology

Source: Adapted by author from NASA data.

### The Major Planets

Mercury	☿
Venus	♀
Earth	♁
Mars	♂
Jupiter	♃
Saturn	♄
Uranus	♅
Neptune	♆

## Properties of Earth–The Major Planets

## CHARTS & TABLES



**Physical and dynamic properties of Jupiter**

diameter (equatorial)	142,984 km
mass	$1.90 \times 10^{27}$ kg
density (average)	1,326 kg/m <sup>3</sup>
composition	hydrogen (H), helium (He), and hydrogen compounds, including water (H <sub>2</sub> O), ammonia (NH <sub>3</sub> ), and methane (CH <sub>4</sub> )
acceleration of gravity (at cloud tops)	23.1 m/s <sup>2</sup> (at 1 bar pressure level)
escape velocity (at cloud tops)	59.5 km/s
period of rotation (a Jovian day)	9.9 Earth hours
axial tilt (inclination of equator)	3.1°
distance from the Sun (average)	778.6 x 10 <sup>6</sup> km (5.20 AU)
perihelion distance	740.5 x 10 <sup>6</sup> km (4.95 AU)
aphelion distance	816.6 x 10 <sup>6</sup> km (5.46 AU)
orbital velocity	13.1 km/s
orbital period (a Jovian year)	11.86 Earth years
orbital eccentricity	0.048
global magnetic field	yes (very strong)
ring system	yes
number of moons	63
solar irradiance	50.5 W/m <sup>2</sup> (at 5.20 AU)
albedo (Bond)	0.343
temperature (cloud top)	165 K (at 1 bar pressure level) 112 K (at 0.1 bar pressure level)
atmosphere	gaseous giant (no solid surface) main components: molecular hydrogen (H <sub>2</sub> ) (~89.8 percent by volume); helium (He) (~10.2 percent); minor amounts of water (H <sub>2</sub> O), ammonia (NH <sub>3</sub> ), and methane (CH <sub>4</sub> )
discovered by	known to ancients
date of discovery	prehistoric times
namesake	the king of the gods in Roman mythology (Zeus in Greek mythology) largest planet; fourth brightest object in sky after the Sun, the Moon, and Venus discovery of Jupiter's four major moons (called the Galilean satellites) in 1610 supported acceptance of the Copernican hypothesis and promoted the Scientific Revolution

*Source: Adapted by author from NASA data.*

**Physical and dynamic properties of Mars**

diameter (equatorial)	6,794 km
mass	0.642 x 10 <sup>24</sup> kg
density (average)	3,933 kg/m <sup>3</sup>
composition	rocks, metals
acceleration of gravity (at surface)	3.7 m/s <sup>2</sup>
escape velocity	5.0 km/s
period of rotation (a Martian day)	24.62 Earth hours (often called a sol)
axial tilt (inclination of equator)	25.2°
distance from the Sun (average)	227.9 x 10 <sup>6</sup> km (1.523 AU)
perihelion distance	206.6 x 10 <sup>6</sup> km (1.381 AU)
aphelion distance	249.2 x 10 <sup>6</sup> km (1.666 AU)
orbital velocity	24.1 km/s
orbital period (a Martian year)	687 Earth days (1.88 Earth years)
orbital eccentricity	0.093
global magnetic field	very weak (~ 1/800th that of Earth)
ring system	none
number of moons	2 (Phobos and Deimos)
solar irradiance	590 W/m <sup>2</sup> (at 1.523 AU)
albedo (Bond)	0.250
surface temperature	210 K (average) 184 K (minimum) to 268 K (maximum)
atmosphere	0.00667 bar (667 Pa) pressure at surface main components: carbon dioxide (CO <sub>2</sub> ) (95.32 percent by volume); nitrogen (N <sub>2</sub> ) (2.7 percent); argon (Ar) (1.6 percent); small amounts of oxygen (O <sub>2</sub> ), water vapor (H <sub>2</sub> O), nitrogen oxide (NO), neon (Ne), and carbon monoxide (CO)
discovered by	known to ancients
date of discovery	prehistoric times
namesake	the god of war in Roman mythology (Ares in Greek mythology; Nergal in Babylonian mythology) often called the Red Planet because of its distinctive reddish soil

*Source: Adapted by author from NASA data.*

**Physical and dynamic properties of Mercury**

diameter (equatorial)	4,879 km
mass	$3.30 \times 10^{23}$ kg
density (average)	5,427 kg/m <sup>3</sup>
composition	rocks, metals
acceleration of gravity (at surface)	3.70 m/s <sup>2</sup>
escape velocity	4.25 km/s
period of rotation (a Mercurian day)	58.646 Earth days
axial tilt (inclination of equator)	0°
distance from the Sun (average)	$57.9 \times 10^6$ km (0.387 AU)
perihelion distance	$46.0 \times 10^6$ km (0.307 AU)
aphelion distance	$69.8 \times 10^6$ km (0.467 AU)
orbital velocity	47.9 km/s
orbital period (a Mercurian year)	87.969 Earth days
orbital eccentricity	0.2056 (most eccentric orbit of major planets)
global magnetic field	yes (but very weak; about 1 percent of Earth's)
ring system	none
number of moons	none
surface temperature	100 K (night) to 700 K (day) (largest temperature range of any planetary body)
atmosphere	negligible (transitory wisp)
albedo (Bond)	0.119
discovered by	known to ancients
date of discovery	prehistoric
namesake	Roman messenger of gods (Hermes in Greek mythology)

*Source: Adapted by author from NASA data.*

**Physical and dynamic properties of the Moon**

diameter (equatorial)	3,476 km
mass	$7.35 \times 10^{22}$ kg
density (average)	$3,340 \text{ kg/m}^3$
composition	rocks and metals; possibly water ice in permanently shadowed basins of polar craters
acceleration of gravity (at surface)	$1.6 \text{ m/s}^2$
escape velocity	2.38 km/s
period of rotation (a lunar day)	27.322 Earth days (synchronous with Earth)
axial tilt (inclination of equator)	$6.68^\circ$
distance from Earth (average)	$3.84 \times 10^5$ km (0.00257 AU)
perigee distance	$3.63 \times 10^5$ km (0.00243 AU)
apogee distance	$4.06 \times 10^5$ km (0.00271 AU)
orbital velocity	1.023 km/s
orbital period (a lunar month)	27.322 Earth days (synchronous with Earth)
orbital eccentricity	0.0549
global magnetic field	no (but some returned rocks exhibit remnant magnetism)
solar irradiance	$1,370 \text{ W/m}^2$ (at 1.0 AU)
albedo (Bond)	0.11
temperature (range on surface)	102 K–384 K
atmosphere	extremely tenuous; trace amounts of helium (He), neon (Ne), argon (Ar), and hydrogen ( $\text{H}_2$ ) surface pressure (lunar night) $\sim 3 \times 10^{-15}$ bar
discovered by	known to ancients
date of discovery	prehistoric times in 1610 Galileo Galilei made the first telescopic observations of the Moon; his revolutionary discovery of mountains and valleys showed that the Moon was another world and not some mysterious object in the sky
namesake	Selene was the Moon goddess in early Greek mythology (Luna in Roman mythology); later Artemis, the goddess of the hunt in Greek mythology (Diana in Roman mythology), became associated with the Moon  because of its size and rocky composition, the Moon is often considered a terrestrial planet; some astronomers even regard the Earth–Moon system as a double planet system  due to synchronous orbital motion, nearside of the Moon always faces Earth

*Source: Adapted by author from NASA data.*

**Physical and dynamic properties of Neptune**

diameter (equatorial)	49,528 km
mass	1.02 x 10 <sup>26</sup> kg
density (average)	1,640 kg/m <sup>3</sup>
composition	hydrogen (H), helium (He), and hydrogen compounds, including methane (CH <sub>4</sub> ), water (H <sub>2</sub> O), ammonia (NH <sub>3</sub> ), and hydrogen deuteride (HD)
acceleration of gravity (at cloud tops)	11.0 m/s <sup>2</sup> (at 1 bar pressure level)
escape velocity (at cloud tops)	23.5 km/s
period of rotation (a Neptunian day)	16.1 Earth hours
axial tilt (inclination of equator)	28.3°
distance from the Sun (average)	4.495 x 10 <sup>9</sup> km (30.05 AU)
perihelion distance	4.445 x 10 <sup>9</sup> km (29.71 AU)
aphelion distance	4.546 x 10 <sup>9</sup> km (30.39 AU)
orbital velocity	5.4 km/s
orbital period (a Neptunian year)	164.79 Earth years
orbital eccentricity	0.0086
global magnetic field	yes
ring system	yes
number of moons	13
solar irradiance	1.5 W/m <sup>2</sup> (at 30.05 AU)
albedo (Bond)	0.290
temperature (cloud top)	72 K (at 1 bar pressure level) 55 K (at 0.1 bar pressure level)
atmosphere	gaseous giant (no solid surface) main components: molecular hydrogen (H <sub>2</sub> ) (~80 percent by volume), helium (He) (~18.5 percent), methane (~1.5 percent), and minor amounts of water (H <sub>2</sub> O), ammonia (NH <sub>3</sub> ), and hydrogen deuteride (HD)
discovered by	Johann Gottfried Galle, based on calculations provided by Urbain Jean Joseph Leverrier; John Couch Adams independently performed similar calculations
date of discovery	September 23, 1846
namesake	god of the sea in Roman mythology (Poseidon in Greek mythology) sometimes called an ice giant

*Source: Adapted by author from NASA data.*

**Physical and dynamic properties of Saturn**

diameter (equatorial)	120,536 km
mass	$5.68 \times 10^{26}$ kg
density (average)	687 kg/m <sup>3</sup>
composition	hydrogen (H), helium (He), and hydrogen compounds, including water (H <sub>2</sub> O), ammonia (NH <sub>3</sub> ), and methane (CH <sub>4</sub> )
acceleration of gravity (at cloud tops)	9.0 m/s <sup>2</sup> (at 1 bar pressure level)
escape velocity (at cloud tops)	35.5 km/s
period of rotation (a Saturnian day)	10.7 Earth hours
axial tilt (inclination of equator)	26.7°
distance from the Sun (average)	1.43 x 10 <sup>9</sup> km (9.56 AU)
perihelion distance	1.35 x 10 <sup>9</sup> km (9.02 AU)
aphelion distance	1.51 x 10 <sup>9</sup> km (10.09AU)
orbital velocity	9.67 km/s
orbital period (a Saturnian year)	29.4 Earth years
orbital eccentricity	0.056
global magnetic field	yes (strong)
ring system	yes (complex system)
number of moons	56
solar irradiance	15.0 W/m <sup>2</sup> (at 9.56 AU)
albedo (Bond)	0.342
temperature (cloud top)	134 K (at 1 bar pressure level) 84 K (at 0.1 bar pressure level)
atmosphere	gaseous giant (no solid surface) main components: molecular hydrogen (H <sub>2</sub> ) (~96.3 percent by volume), helium (He) (~3.25 percent), minor amounts of water (H <sub>2</sub> O), ammonia (NH <sub>3</sub> ), and methane (CH <sub>4</sub> )
discovered by	known to ancients
date of discovery	prehistoric times
namesake	god of agriculture in Roman mythology (Cronus in Greek mythology)

*Source: Adapted by author from NASA data.*

**Physical and dynamic properties of Uranus**

diameter (equatorial)	51,118 km
mass	$8.68 \times 10^{25}$ kg
density (average)	1,270 kg/m <sup>3</sup>
composition	hydrogen (H), helium (He), and hydrogen compounds, including water (H <sub>2</sub> O), ammonia (NH <sub>3</sub> ), and methane (CH <sub>4</sub> )
acceleration of gravity (at cloud tops)	8.69 m/s <sup>2</sup> (at 1 bar pressure level)
escape velocity (at cloud tops)	21.3 km/s
period of rotation (an Uranian day)	-17.24 Earth hours (retrograde)
axial tilt (inclination of equator)	97.9°
distance from the Sun (average)	$2.872 \times 10^9$ km (19.20 AU)
perihelion distance	$2.741 \times 10^9$ km (18.32 AU)
aphelion distance	$3.004 \times 10^9$ km (20.80 AU)
orbital velocity	6.8 km/s
orbital period (an Uranian year)	84.0 Earth years
orbital eccentricity	0.047
global magnetic field	yes
ring system	yes
number of moons	27
solar irradiance	3.7 W/m <sup>2</sup> (at 19.20 AU)
albedo (Bond)	0.300
temperature (cloud top)	76 K (at 1 bar pressure level) 53 K (at 0.1 bar pressure level)
atmosphere	gaseous giant (no solid surface) main components: molecular hydrogen (H <sub>2</sub> ) (~82.5 percent by volume), helium (He) (~15.2 percent), methane (~2.3 percent), and minor amounts of water (H <sub>2</sub> O), ammonia (NH <sub>3</sub> ), and hydrogen deuteride (HD)
discovered by	Sir William Herschel
date of discovery	March 13, 1781
namesake	god of the heavens in Greek mythology (husband of Gaia and father of Cronus) sometimes called an ice giant

*Source: Adapted by author from NASA data.*

**Physical and dynamic properties of Venus**

diameter (equatorial)	12,104 km
mass	$4.87 \times 10^{24}$ kg
density (average)	5,243 kg/m <sup>3</sup>
composition	rocks, metals
acceleration of gravity (at surface)	8.9 m/s <sup>2</sup>
escape velocity	10.4 km/s
period of rotation (a Venusian day)	243 Earth days (very slowly and retrograde)
axial tilt (inclination of equator)	177.4°
distance from the Sun (average)	108.2 x 10 <sup>6</sup> km (0.723 AU)
perihelion distance	107.5 x 10 <sup>6</sup> km (0.719 AU)
aphelion distance	108.9 x 10 <sup>6</sup> km (0.728 AU)
orbital velocity	35.0 km/s
orbital period (a Venusian year)	224.7 Earth days (0.615 Earth years)
orbital eccentricity	0.007 (most nearly circular orbit of any planet)
global magnetic field	none
ring system	none
number of moons	none
solar irradiance	2,614 W/m <sup>2</sup> (at 0.723 AU)
albedo (Bond)	0.750 (brightest object in sky after the Sun and the Moon)
surface temperature	740 K (inferno-like runaway greenhouse)
atmosphere	92 bars pressure (92 x 10 <sup>5</sup> Pa) at surface main components: carbon dioxide (CO <sub>2</sub> ) (96.5 percent by volume); nitrogen (N <sub>2</sub> ) (3.5 percent by volume); with minor amounts of sulfur dioxide (SO <sub>2</sub> ), argon (Ar), water (H <sub>2</sub> O), carbon monoxide (CO), and helium (He) CO <sub>2</sub> causing runaway greenhouse conditions
discovered by	known to ancients
date of discovery	prehistoric times
namesake	goddess of love in Roman mythology (Aphrodite in Greek mythology; Ishtar in Babylonian mythology) sometimes called Eosphorus (morning) and Hesperus (evening star) by ancient Greeks almost all surface features on Venus are named for female figures (mythical and real)

*Source: Adapted by author from NASA data.*



**Physical and dynamic properties of dwarf planet Ceres**

diameter (equatorial)	950 km
mass	$9.4 \times 10^{20}$ kg
density (average)	$\sim 2,100$ kg/m <sup>3</sup>
composition	rocky, silicate core covered by a mantle of ices, especially water ice; composition believed similar to that found in carbonaceous chondrite meteorites
acceleration of gravity (at surface)	0.27 m/s <sup>2</sup>
escape velocity	0.5 km/s
period of rotation	9.1 Earth hours
axial tilt (inclination of equator)	$\sim 4^\circ$ (or less)
distance from the Sun (average)	$4.14 \times 10^8$ km (2.77AU)
perihelion distance	$3.81 \times 10^8$ km (2.55 AU)
aphelion distance	$4.47 \times 10^8$ km (2.99 AU)
orbital velocity	17.9 km/s
orbital period	4.6 Earth years
orbital eccentricity	0.097
global magnetic field	none (?)
ring system	no
number of moons	none (?)
solar irradiance	$178.6$ W/m <sup>2</sup> (at 2.77 AU)
albedo (geometric)	$\sim 0.10$
temperature (at surface)	170 K–200 K
atmosphere	possible tenuous atmosphere as ices (such as water and methane) sublime from frost on surface
discovered by	Father Giuseppe Piazzi at the observatory in Palermo, Sicily
date of discovery	January 1, 1801
namesake	goddess of agriculture in Roman mythology (Demeter in Greek mythology) largest asteroid, but upgraded from asteroid to dwarf planet status on August 24, 2006 by International Astronomical Union not yet visited by a spacecraft; NASA's <i>Dawn</i> scheduled to study Ceres in 2015

*Note: Some of these data are speculative.*

*Source: Adapted by author from NASA data.*

**Physical and dynamic properties of dwarf planet Eris**

diameter (equatorial)	~ 2,400 km
mass	1.6 x 10 <sup>22</sup> kg
density (average)	2,300 kg/m <sup>3</sup>
composition	rock and ice, possibly similar to Pluto
acceleration of gravity (at surface)	~ 0.8 m/s <sup>2</sup>
escape velocity	?
period of rotation	~ 8 Earth hours (?)
axial tilt (inclination of equator)	?
distance from the Sun (average)	10.12 x 10 <sup>9</sup> km (67.67 AU)
perihelion distance	5.65 x 10 <sup>9</sup> km (37.77 AU)
aphelion distance	14.61 x 10 <sup>9</sup> km (97.67 AU)
orbital velocity	3.4 km/s
orbital period	557 Earth years
orbital eccentricity	0.442
global magnetic field	none (?)
ring system	no
number of moons	1 (called Dysnomia)
solar irradiance	0.30 W/m <sup>2</sup> (at 67.67AU)
albedo (geometric)	0.80–0.86 (highly reflective)
temperature (at surface)	~ 30 K–50 K
atmosphere	possible tenuous atmosphere of gaseous methane at perihelion; but frozen out on surface at aphelion
discovered by	Michael E. Brown, Chad A. Trujillo, and David Rabinowitz, who used images collected at Palomar Observatory, California
date of discovery	Eris discovered on January 5, 2005, during analysis of images collected on October 21, 2003; discovery formally announced to International Astronomical Union on July 29, 2005
namesake	Eris is goddess of strife and discord in Greek mythology; her daughter (Dysnomia) is the goddess of lawlessness largest dwarf planet and most distant known Kuiper belt object currently at aphelion, making observations difficult and physical data speculative originally known as 2003 UB313

*Note: Some of these data are speculative.*

*Source: Adapted by author from NASA data.*

**Physical and dynamic properties of dwarf planet Pluto**

diameter (equatorial)	~ 2,300 km
mass	1.25 x 10 <sup>22</sup> kg
density (average)	1,750 kg/m <sup>3</sup>
composition	rock and various ices
acceleration of gravity (at surface)	0.6 m/s <sup>2</sup>
escape velocity	1.1 km/s
period of rotation (a Plutonian day)	-6.39 Earth days (retrograde)
axial tilt (inclination of equator)	122.5°
distance from the Sun (average)	5.906 x 10 <sup>9</sup> km (39.48 AU)
perihelion distance	4.437 x 10 <sup>9</sup> km (29.66 AU)
aphelion distance	7.376 x 10 <sup>9</sup> km (49.30 AU)
orbital velocity	4.7 km/s
orbital period (a Plutonian year)	248 Earth years
orbital eccentricity	0.2488
global magnetic field	unknown (?)
ring system	no
number of moons	3
solar irradiance	0.88 W/m <sup>2</sup> (at 39.48 AU)
albedo (Bond)	0.4–0.6
temperature (at surface)	~ 40K–60K
atmosphere	tenuous (a transient phenomenon) gaseous at perihelion and frozen into ice at aphelion most likely nitrogen (N <sub>2</sub> ) and methane (CH <sub>4</sub> )
discovered by	Clyde W. Tombaugh
date of discovery	February 18, 1930
namesake	god of the underworld in Roman mythology (Hades in Greek mythology) downgraded from major planet status on August 24, 2006 by International Astronomical Union not yet visited by a spacecraft; NASA's <i>New Horizons</i> scheduled for flyby in 2015

*Note: Some of these data are speculative.*

*Source: Adapted by author from NASA data.*

**Physical and dynamic properties of the Sun**

diameter (equatorial)	1.39 x 10 <sup>6</sup> km
mass	1.989 x 10 <sup>30</sup> kg
density (average)	1,410 kg/m <sup>3</sup>
composition	hydrogen (~ 70 percent by mass), helium (~ 28 percent by mass), heavier elements (~ 2 percent by mass)
acceleration of gravity (at visible surface)	274 m/s <sup>2</sup>
escape velocity (from surface)	617.7 km/s
period of rotation (Sun experiences differential rotation)	~ 27 Earth days (varies with latitude) 26.8 Earth days (at equator) 36 Earth days (at poles)
distance from Earth (average)	149.6 x 10 <sup>6</sup> km (1.000 AU)
perihelion distance	147.1 x 10 <sup>6</sup> km (0.983 AU)
aphelion distance	152.1 x 10 <sup>6</sup> km (1.017AU)
velocity (relative to nearest stars)	19.7 km/s
Sun's magnetic field	intense (drives solar wind) ~ 22 years for complete solar magnetic cycle (called <i>solar cycle</i> )
sunspot cycle	~ 11 years from solar maximum to solar maximum
solar luminosity	3.9 x 10 <sup>26</sup> W
radiant energy output per unit surface area	6.4 x 10 <sup>7</sup> W/m <sup>2</sup>
stellar spectral class	G2V (a main-sequence yellow star)
temperature	5,800 K (surface) ~ 4,000 K (sunspots) ~ 15,000,000 K (center of core)
discovered by	known to ancients; deified by many early peoples
date of discovery	prehistoric; apparent daily and annual movement through sky recognized and used by most early civilizations Helios was sun god in early Greek mythology (called Sol in Roman mythology); in the late Hellenistic period, the god Apollo became associated with the Sun in Greco-Roman mythology astronomers often use Sol (Latin word for the Sun) as the formal name of Earth's parent star in the 1930s scientists, including Hans A. Bethe, identified nuclear fusion as the source of the Sun's enormous energy release

Source: Adapted by author from NASA data.

**Escape velocity for various objects in the solar system**

Celestial body	Escape velocity ( $v_e$ ) (km/s)
Earth	11.2
Moon	2.4
Mercury	4.3
Venus	10.4
Mars	5.0
Jupiter	~ 59.5
Saturn	~ 36
Uranus	~ 21
Neptune	~ 24
Pluto	~ 1
Sun	~ 618

*Source: Developed by the author from NASA and other sources of astrophysical data.*

**Stellar luminosity classes**

Luminosity class	Type of stars
Ia	Bright Supergiants
Ib	Supergiants
II	Bright Giants
III	Giants
IV	Subgiants
V	Main-Sequence Stars (Dwarfs)
VI	Subdwarfs
VII	White Dwarfs

## Hertzsprung-Russell diagram

## CHARTS & TABLES

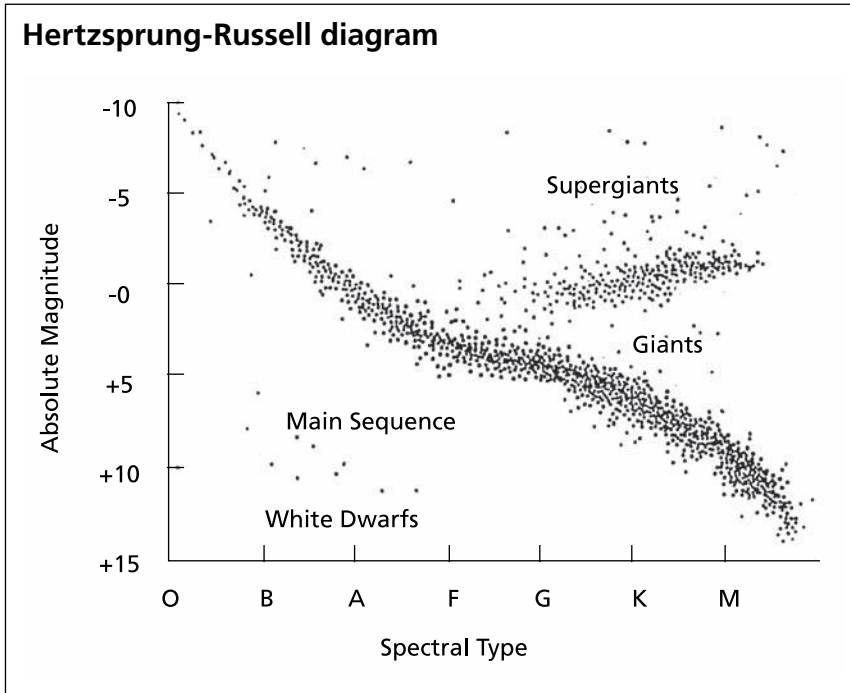

## Hertzsprung-Russell diagram

## CHARTS & TABLES



# APPENDIX A

## Recommended Reading

- Angelo, Joseph A., Jr. *The Dictionary of Space Technology*. Rev. ed. New York: Facts On File, 2004.
- \_\_\_\_\_. *Encyclopedia of Space and Astronomy*. New York: Facts On File, 2006.
- \_\_\_\_\_. *Encyclopedia of Space Exploration*. New York: Facts On File, 2000.
- \_\_\_\_\_. *Life in the Universe*. New York: Facts On File, 2007.
- \_\_\_\_\_. *Rockets*. New York: Facts On File, 2006.
- Angelo, Joseph A., Jr., and Irving W. Ginsberg, eds. *Earth Observations and Global Change Decision Making, 1989: A National Partnership*. Malabar, Fla.: Krieger Publishing, 1990.
- Brown, Robert A., ed. *Endeavour Views the Earth*. New York: Cambridge University Press, 1996.
- Burrows, William E., and Walter Cronkite. *The Infinite Journey: Eyewitness Accounts of NASA and the Age of Space*. New York: Discovery Channel Books, 2000.
- Chaisson, Eric, and Steve McMillan. *Astronomy Today*. 6th ed. Upper Saddle River, N.J.: Pearson Prentice Hall, 2008.
- Cole, Michael D. *International Space Station: A Space Mission*. Springfield, N.J.: Enslow Publishers, 1999.
- Collins, Michael. *Carrying the Fire*. New York: Cooper Square Publishers, 2001.
- Consolmagno, Guy J., et al. *Turn Left at Orion: A Hundred Night Objects to See in a Small Telescope—And How to Find Them*. New York: Cambridge University Press, 2000.
- Damon, Thomas D. *Introduction to Space: The Science of Spaceflight*. 3rd ed. Malabar, Fla.: Krieger Publishing, 2000.
- Dickinson, Terence. *The Universe and Beyond*. 3rd ed. Willowdater, Ont.: Firefly Books, 1999.
- Heppenheimer, Thomas A. *Countdown: A History of Space Flight*. New York: John Wiley & Sons, 1997.
- Kluger, Jeffrey. *Journey beyond Selene: Remarkable Expeditions Past Our Moon and to the Ends of the Solar System*. New York: Simon & Schuster, 1999.
- Kraemer, Robert S. *Beyond the Moon: A Golden Age of Planetary Exploration, 1971–1978*. Smithsonian History of Aviation and Spaceflight Series. Washington, D.C.: Smithsonian Institution Press, 2000.



- Lewis, John S. *Rain of Iron and Ice: The Very Real Threat of Comet and Asteroid Bombardment*. Reading, Mass.: Addison-Wesley, 1996.
- Logsdon, John M. *Together in Orbit: The Origins of International Participation in the Space Station*. Monographs in Aerospace History 11. Washington, D.C.: NASA History Division Office of Policy and Plans, 1998.
- Matloff, Gregory L. *The Urban Astronomer: A Practical Guide for Observers in Cities and Suburbs*. New York: John Wiley & Sons, 1991.
- Neal, Valerie, Cathleen S. Lewis, and Frank H. Winter. *Spaceflight: A Smithsonian Guide*. New York: Macmillan, 1995.
- Pebbles, Curtis L. *The Corona Project: America's First Spy Satellites*. Annapolis, Md.: Naval Institute Press, 1997.
- Sutton, George Paul. *Rocket Propulsion Elements*. 7th ed. New York: John Wiley & Sons, 2000.
- Todd, Deborah, and Joseph A. Angelo, Jr. *A to Z of Scientists in Space and Astronomy*. New York: Facts On File, 2005.

# APPENDIX B

## Cyberspace Destinations

### Exploring Cyberspace

In recent years, numerous Web sites dealing with astronomy, astrophysics, cosmology, space exploration, and the search for life beyond Earth have appeared on the Internet. Visits to such sites can provide information about the status of ongoing missions, such as NASA's *Cassini* spacecraft as it explores the Saturn system. This book can serve as an important companion as you explore a new Web site and encounter a person, technology term, or physical concept unfamiliar to you and not fully discussed within the particular site. To help enrich the content of this book and to make your astronomy- or space technology-related travels in cyberspace more enjoyable and productive, the following is a selected list of Web sites that are recommended for your viewing. From these sites you will be able to link to many other astronomy or space-related locations on the Internet. *Note:* This is obviously just a partial list of the many astronomy and space-related Web sites now available. Every effort has been made at the time of publication to ensure the accuracy of the information provided. However, due to the dynamic nature of the Internet, URL changes do occur; any inconvenience you might experience is regretted.

### Selected Organizational Home Pages

European Space Agency (ESA) is an international organization whose task is to provide for and promote, exclusively for peaceful purposes, cooperation among European states in space research and technology and their applications. Available online. URL: [www.esa.int/esaCP/index.html](http://www.esa.int/esaCP/index.html). Accessed on February 15, 2008.

National Aeronautics and Space Administration (NASA) is the civilian space agency of the United States government and was created in 1958 by an act of Congress. NASA's overall mission is to plan, direct, and conduct American civilian (including scientific) aeronautical and space activities for peaceful purposes. Available online. URL: [www.nasa.gov](http://www.nasa.gov). Accessed on December 15, 2008.

National Oceanic and Atmospheric Administration (NOAA) was established in 1970 as an agency within the U.S. Department of Commerce to ensure the safety of the general public from atmospheric phenomena and to provide the public with an understanding of Earth's environment and resources.

Available online. URL: [www.noaa.gov](http://www.noaa.gov). Accessed on December 15, 2008.

National Reconnaissance Office (NRO) is the organization within the Department of Defense that designs, builds, and operates U.S. reconnaissance satellites. Available online. URL: [www.nro.gov](http://www.nro.gov). Accessed on December 15, 2008.

United States Air Force (USAF) serves as the primary agent for the space defense needs of the United States. All military satellites are launched from Cape Canaveral Air Force Station in Florida or Vandenberg Air Force Base in California. Available online. URL: [www.af.mil](http://www.af.mil). Accessed on December 15, 2008.

United States Strategic Command (USSTRATCOM) is the strategic forces organization within the Department of Defense, which commands and controls U.S. nuclear forces and military space operations. Available online. URL: [www.stratcom.mil](http://www.stratcom.mil). Accessed on December 15, 2008.

### Selected NASA Centers

Ames Research Center (ARC), in Mountain View, California, is NASA's primary center for exobiology, information technology, and aeronautics. Available online. URL: [www.nasa.gov/centers/ames/home/index.html](http://www.nasa.gov/centers/ames/home/index.html). Accessed on December 15, 2008.

Dryden Flight Research Center (DFRC) in Edwards, California, is NASA's center for atmospheric flight operations and aeronautical flight research. Available online. URL: [www.nasa.gov/centers/dryden/home/index.html](http://www.nasa.gov/centers/dryden/home/index.html). Accessed on December 15, 2008.

Glenn Research Center (GRC), in Cleveland, Ohio, develops aerospace propulsion, power, and communications technology for NASA. Available online. URL: [www.nasa.gov/centers/glenn/home/index.html](http://www.nasa.gov/centers/glenn/home/index.html). Accessed on December 15, 2008.

Goddard Space Flight Center (GSFC), in Greenbelt, Maryland, has a diverse range of responsibilities within NASA including Earth system science, astrophysics, and operation of the *Hubble Space Telescope* and other Earth-orbiting spacecraft. Available online. URL: [www.nasa.gov/centers/goddard/home/index.html](http://www.nasa.gov/centers/goddard/home/index.html). Accessed on December 15, 2008.

Jet Propulsion Laboratory (JPL), in Pasadena, California, is a government-owned facility operated for NASA by the California Institute of Technology. JPL manages and operates NASA's deep-space scientific missions, as

well as NASA's Deep Space Network, which communicates with solar system exploration spacecraft. Available online. URL: [www.jpl.nasa.gov](http://www.jpl.nasa.gov). Accessed on December 15, 2008.

Johnson Space Center (JSC), in Houston, Texas, is NASA's primary center for design, development, and testing of spacecraft and associated systems for human spaceflight, including astronaut selection and training. Available online. URL: <http://www.nasa.gov/centers/johnson/home/index.html>. Accessed on December 15, 2008.

Kennedy Space Center (KSC), on Cape Canaveral, Florida, is the NASA center responsible for ground turnaround and support operations, prelaunch checkout, and launch of the space shuttle. This center is also responsible for NASA launch facilities at Vandenberg Air Force Base, in California. Available online. URL: [www.nasa.gov/centers/kennedy/home/index.html](http://www.nasa.gov/centers/kennedy/home/index.html). Accessed on December 15, 2008.

Langley Research Center (LaRC), in Hampton, Virginia, is NASA's center for structures and materials, as well as hypersonic-flight research and aircraft safety. Available online. URL: [www.nasa.gov/centers/langley/home/index.html](http://www.nasa.gov/centers/langley/home/index.html). Accessed on December 15, 2008.

Marshall Space Flight Center (MSFC), in Huntsville, Alabama, serves as NASA's main research center for space propulsion, including contemporary rocket-engine development as well as advanced space transportation system concepts. Available online. URL: [www.nasa.gov/centers/marshall/home/index.html](http://www.nasa.gov/centers/marshall/home/index.html). Accessed on December 15, 2008.

Stennis Space Center (SSC), in Mississippi, is the main NASA center for large rocket engine testing, including space shuttle engines as well as future generations of space launch vehicles. Available online. URL: [www.nasa.gov/centers/stennis/home/index.html](http://www.nasa.gov/centers/stennis/home/index.html). Accessed on December 15, 2008.

Wallops Flight Facility (WFF), on Wallops Island, Virginia, manages NASA's suborbital sounding rocket program and scientific balloon flights to Earth's upper atmosphere. Available online. URL: [www.nasa.gov/centers/wallops/home/index.html](http://www.nasa.gov/centers/wallops/home/index.html). Accessed on December 15, 2008.

White Sands Test Facility (WSTF), in White Sands, New Mexico, supports the space shuttle and space station programs by performing tests on and evaluating potentially hazardous materials, space flight components, and rocket propulsion systems. Available online. URL: [www.nasa.gov/centers/wstf/home/index.html](http://www.nasa.gov/centers/wstf/home/index.html). Accessed on December 15, 2008.

## **Selected Space Missions**

Cassini-Huygens Mission is an ongoing scientific exploration of the planet Saturn. Available online. URL: [saturn.jpl.nasa.gov/home/index.cfm](http://saturn.jpl.nasa.gov/home/index.cfm). Accessed on December 15, 2008.

Exploration of Mars by numerous contemporary and previous flyby, orbiter, and lander robotic spacecraft. Available online. URL: [mars.jpl.nasa.gov](http://mars.jpl.nasa.gov). Accessed on December 15, 2008.

*Chandra X-ray Observatory (CXO)* is a space-based astronomical observatory that is part of NASA's Great Observatory Program. CXO observes the universe in the X-ray portion of the electromagnetic spectrum. Available online. URL: [chandra.harvard.edu](http://chandra.harvard.edu). Accessed on December 15, 2008.

National Space Science Data Center (NSSDC) provides a worldwide compilation of space missions and scientific spacecraft. Available online. URL: [nssdc.gsfc.nasa.gov/planetary](http://nssdc.gsfc.nasa.gov/planetary). Accessed on December 15, 2008.

Voyager (Deep Space/Interstellar) updates the status of NASA's *Voyager 1* and *2* spacecraft as they travel beyond the solar system. Available online. URL: [voyager.jpl.nasa.gov](http://voyager.jpl.nasa.gov). Accessed on December 15, 2008.

### Other Interesting Astronomy and Space Sites

Arecibo Observatory in the tropical jungle of Puerto Rico is the world's largest radio/radar telescope. Available online. URL: [www.naic.edu](http://www.naic.edu). Accessed on December 15, 2008.

Astrogeology describes the U.S. Geological Survey's Astrogeology Research Program, which has a rich history of participation in space exploration efforts and planetary mapping. Available online. URL: [planetarynames.wr.usgs.gov](http://planetarynames.wr.usgs.gov). Accessed on December 15, 2008.

*Hubble Space Telescope (HST)* is an orbiting NASA Great Observatory that is studying the universe primarily in the visible portions of the electromagnetic spectrum. Available online. URL: [hubblesite.org](http://hubblesite.org). Accessed on December 15, 2008.

NASA's Deep Space Network (DSN) is a global network of antennas that provide telecommunications support to distant interplanetary spacecraft and probes. Available online. URL: [deepspace.jpl.nasa.gov/dsn](http://deepspace.jpl.nasa.gov/dsn). Accessed on December 15, 2008.

Science at NASA provides contemporary information about ongoing space science activities. Available online. URL: [science.nasa.gov](http://science.nasa.gov). Accessed on December 15, 2008.

National Air and Space Museum (NASM) of the Smithsonian Institution in Washington, D.C. maintains the largest collection of historic aircraft and spacecraft in the world. Available online. URL: [www.nasm.si.edu](http://www.nasm.si.edu). Accessed on December 15, 2008.

Planetary Photojournal is a NASA Jet Propulsion Laboratory–sponsored Web site that provides an extensive collection of images of celestial objects within and beyond the solar system, historic and contemporary spacecraft used in space

exploration, and advanced aerospace technologies. Available online. URL: [photojournal.jpl.nasa.gov/index.html](http://photojournal.jpl.nasa.gov/index.html). Accessed on December 15, 2008.

Planetary Society is the nonprofit organization founded in 1980 by Carl Sagan and other scientists that encourages all spacefaring nations to explore other worlds. Available online. URL: [planetary.org](http://planetary.org). Accessed on December 15, 2008.

Search for Extraterrestrial Intelligence (SETI) Projects at the University of California–Berkeley is a Web site that involves contemporary activities in the search for extraterrestrial intelligence, especially a radio SETI project that lets anyone with a computer and an Internet connection participate. Available online. URL: [www.setiathome.ssl.berkeley.edu](http://www.setiathome.ssl.berkeley.edu). Accessed on December 15, 2008.

Solar System Exploration is a NASA-sponsored and maintained Web site that presents the latest events, discoveries, and missions involving the exploration of the solar system. Available online. URL: [solarsystem.nasa.gov/index.cfm](http://solarsystem.nasa.gov/index.cfm). Accessed on December 15, 2008.

Human Space Flight (NASA) is a NASA gateway Web site that provides the latest information about human space flight activities, including the *International Space Station (ISS)* and the space shuttle. Available online. URL: [spaceflight.nasa.gov/home/index.html](http://spaceflight.nasa.gov/home/index.html). Accessed on December 15, 2008.



Note: *Italic* page numbers indicate illustrations. Arabic names preceded by particles are filed by the particle, per the text.

- A**
- Abell, George Ogden 150  
 Abell cluster 2, 150  
 aberration  
   chromatic 37, 174  
   of starlight 2, 161, 231  
 ablation 2, 205  
 ablative cooling 2  
 abort 2, 2, 6  
 absolute magnitude 2  
 absolute temperature 2, 28, 116, 159, 192  
 absolute zero 2  
 absorption line 3  
 absorption spectrum 3  
 abundance of elements 3  
 accelerated life tests 3  
 acceleration 3, 66  
   angular 10  
   of gravity 3, 67, 104  
 accelerometer 3  
 accretion 4  
 accretion disk 4, 4  
 Achilles (asteroid) 4, 223  
 acquisition 4  
 acronyms 4  
 action–reaction principle 102, 121  
 active communications satellites 39  
 active galactic nucleus (AGN) 4, 35  
 active galaxies 4  
 active remote sensing 4  
 active satellites 5  
 active Sun 5  
 acute radiation syndrome (ARS) 5, 116  
 Adams, John Couch 150  
 Adams, Walter Sydney 150  
 adapter skirt 5  
 adaptive optics 5  
 adiabatic 5  
*Advanced X-ray Astrophysics Facility (AXAF)* 35, 167  
 aeoliphile 186, 227  
 aero- 5  
 aeroassist 5  
 aerobraking 5  
 aerodynamic force 6, 7  
 aerodynamic heating 6, 118, 205  
 aerodynamic skip 6  
 aerodynamic vehicles 6  
 aeropause 6  
 aerosol 6  
 aerospace 6  
 aerospace ground equipment (AGE) 6  
 aerospace medicine 6, 130  
 aerospace vehicles 6, 7, 131  
 aerospike nozzle 7  
 aerazine 7  
 afterbody 7  
 AGE. *See* aerospace ground equipment  
 Agena (rocket) 7, 7, 253, 254, 289  
 age of the Moon 7  
 agglutinate 7  
 AGN. *See* active galactic nucleus  
 AI. *See* artificial intelligence  
 air 7  
 airfoil 7  
 air launch 8  
 airlock 8, 52, 123  
 Airy, Sir George Biddell 150  
 Aitken, Robert Grant 150  
 Al-Battani (Albatagnius) 150–151  
 albedo 8, 28, 111, 172  
 Aldrin, Edwin E. “Buzz,” Jr. 151, 151, 169, 199, 248, 255  
 ALF. *See* alien life-form  
 Alfonso X of Castile 151  
 Alfvén, Hannes Olof Gösta 151  
 Alfvén waves 151  
 Algol (star) 233  
 algorithm 8  
 alien life-form (ALF) 8  
*Almagest* (Ptolemy) 8, 115, 208, 227  
 Almaz (space station) 8  
 Alnilam (star) 24  
 Alnitak (star) 24  
 Alpha Centauri (star system) 8, 115, 186, 190  
 alphanumeric 8  
 alpha particle 8–9, 36  
 Alpher, Ralph Asher 151, 180  
 ALSEP. *See* Apollo Lunar Surface Experiments Package  
 Al-Sufi, Abd al-Rahman 151, 228  
 altazimuth mounting 9, 9  
 altimeter 9  
 altitude (astronomy) 9, 18  
 altitude (spacecraft) 9  
 Alvarez, Luis Walter 152  
 Al-Wefa, Abu’l 152  
 Amalthea (moon) 9, 9, 156  
 Ambartsumian, Viktor Amazaspovich 28, 152  
 ambient conditions 9  
 Amici, Giovanni Battista 152  
 amino acid 9, 202, 220  
 Amor group (asteroids) 9, 17, 172–173  
 amorphotol 9  
 amplitude 10  
 Ananke (moon) 204  
 Anaxagoras 152  
 Anaximander 153  
 ancient constellations 8, 9, 10, 42, 226, 284–286  
 Anders, William A. 153, 199, 255  
 Anderson, Michael P. 39, 273  
 Andromeda galaxy 10, 88, 133, 151, 155, 172, 186, 189, 228  
 angle 10  
   of incidence 10, 10  
 angstrom 10, 153  
 Ångström, Anders Jonas 10, 153  
 angular acceleration 10  
 angular diameter 10, 10, 160  
 angular measure 11  
 angular momentum 11, 41, 73  
 angular velocity 10, 11  
 annihilation radiation 11, 12  
 annual parallax 11, 11  
 annular nozzle 11  
 anomalistic period 11  
 anomaly (astronomy) 11  
 anomaly (space operations) 11  
 antenna 11  
   Deep Space Network of 48, 48  
   directional 11, 51  
   omnidirectional 11, 104  
   Project Cyclops 113  
 antenna array 12, 113, 142  
 antimatter 12  
 antisatellite (ASAT) spacecraft 12, 12  
 antislosh baffle 12  
 Antoniadi, Eugene Michael 153  
 Antoniadi scale 153  
 apastron 12  
 apeiron 153  
 aperture 12  
 aperture synthesis 12, 212  
 apex 12  
 aphelion 12  
 Aphrodite Terra 12  
 apogee 12, 12, 48, 87  
 apogee motor 13  
 Apollo group (asteroids) 13, 17, 209  
 Apollo Lunar Surface Experiments Package (ALSEP) 13, 256  
 Apollonius of Perga 153–154  
 Apollo Project 13, 14, 52, 54, 69, 89, 162, 175, 192, 193, 213, 214, 221, 251, 252, 253, 254–259, 294  
   *Apollo 1* 13, 166, 184, 221, 222, 254  
   *Apollo 7* 171, 177, 254–255, 294  
   *Apollo 8* 13, 152, 153, 160, 199, 255, 294  
   *Apollo 9* 294  
   *Apollo 10* 166, 216, 224, 255, 294  
   *Apollo 11* 13, 151, 155, 169, 171, 216, 255, 294  
   *Apollo 12* 156, 170, 183, 255–256, 294  
   *Apollo 13* 184, 199, 217–218, 256, 294  
   *Apollo 14* 202, 211, 215, 257, 294  
   *Apollo 15* 73, 190, 214, 223–224, 258, 294  
   *Apollo 16* 175, 200, 224, 258–259, 294  
   *Apollo 17* 13, 166, 178, 213, 259, 294  
   *Apollo 18* 13  
 Apollo–Soyuz Test Project (ASTP) 13, 52, 128–129, 197, 215, 216, 260  
 apolune 14  
 apparent 14  
 apparent diameter 14  
 apparent magnitude 2, 14  
 apparent motion 15  
*Applications Technology Satellite-6 (ATS-6)* 260  
 approach 15  
 apsides, line of 87  
 APU. *See* auxiliary power unit  
*Aqua* (spacecraft) 15, 272  
*Aquarius* (lunar module) 256  
 Arago, Dominique François 154  
 archaeological astronomy 15  
 arc-jet engine 15  
 Arecibo Interstellar Message 15  
 Arecibo Observatory 15, 15  
 Ares I (launch vehicle) 15, 15, 42, 84, 106, 289



- Ares V (launch vehicle) 15–16, 16, 42, 84, 289
- Argelander, Friedrich Wilhelm August 154, 183–184
- Ariane (launch vehicle) 16, 16, 72, 83, 262–263, 290
- Ariel (moon) 196, 235
- Aristarchus of Samos 154, 171, 227
- Aristotle 154–155, 163, 177, 226–227, 229
- Armstrong, Neil A. 151, 155, 155, 169, 248, 253, 255
- Arp, Halton Christian 155
- Arrest, Heinrich Louis d' 155
- Arrhenius, Svante August 107, 155
- ARS. *See* acute radiation syndrome
- artificial gravity 16
- artificial intelligence (AI) 17
- artificial satellites 17, 194, 219, 244
- ASAT. *See* antisatellite spacecraft
- ascending node 17
- ascension, right 120, 284
- asteroid(s) 17, 110, 127. *See also* specific asteroids
- basin of 24
- Earth-crossing 17, 54
- extraterrestrial catastrophe theory of 63, 63
- main-belt 92, 107, 193–194, 203, 204, 206, 232, 258, 267, 268
- near-Earth 9, 13, 17, 19, 100, 172–173, 209
- asteroid belt 17, 85, 109–110, 127, 142
- asteroid/comet
- Centaurus 33
- Chiron 33, 35, 36
- Asteroid-588. *See* Achilles
- ASTP. *See* Apollo-Soyuz Test Project
- astro- 17
- astrobiology 17, 55, 202
- astromble 17
- astrochimps 17, 17, 58, 73–74, 247–248
- astrodynamics 17
- astrolabe 18, 172
- astrology 18
- astrometric binary 18
- astrometry 18
- astronaut(s) 18. *See also* specific astronauts
- astronautics 18, 182, 204, 219, 239
- Astronomer Royal 18, 122, 158, 161, 167, 176, 179, 185, 200, 208, 209, 212, 223
- astronomical unit (AU) 18, 181, 191
- astronomy 18. *See also* specific types
- astrophotography 18–19, 159, 167, 169, 175, 191–192, 214, 215, 218, 223, 234, 235
- astrophysics 19, 129, 169, 176, 185, 188
- Aten group 17, 19
- Athena (launch vehicle) 290
- Atlantis (space shuttle) 50, 105, 199, 217, 222, 266, 267, 269, 269, 276
- Atlas (launch vehicle) 19, 19, 33, 213, 221, 243, 245, 249, 249, 289, 290
- atmosphere
- cabin 19
- Earth 19, 56
- sensible 118, 123
- atmospheric pressure 19
- atmospheric probe 20
- atmospheric window 20, 20
- atom 20
- atomic clock 20, 140
- atomic hydrogen 77
- atomic mass 20
- atomic mass unit 20
- atomic number 20
- atomic weight 20
- ATS-6. *See* Applications Technology Satellite-6
- Attainability of Celestial Bodies, The (Hohmann) 188, 238
- attenuation 21
- attitude 21
- attitude control system 21
- AU. *See* astronomical unit
- Aura (spacecraft) 21, 273
- aurora 21, 158, 166
- Aurora 7 (space capsule) 164
- aurora australis 21
- aurora borealis 21
- auxiliary power unit (APU) 21
- AXAF. *See* Advanced X-ray Astrophysics Facility
- axis/axes 22, 161
- coordinate 31
- semimajor 18, 123
- azimuth 9, 22, 86
- B**
- Baade, (Wilhelm Heinrich) Walter 155–156, 202, 224
- Babcock, Harold Delos 156
- Babcock, Horace 156
- backout 22
- Baikonur Cosmodrome 22, 142, 148
- Baily, Francis 22, 156
- Baily's beads 22, 156
- ballistic missile(s) 19, 22, 22, 28, 54, 80, 84, 98, 111, 118, 139, 175, 177, 193, 194, 221, 240–241, 243, 245, 246, 249–250
- ballistic missile defense (BMD) 22
- ballistic trajectory 23
- band 23
- bandwidth 23
- barbecue mode 23
- Barnard, Edward Emerson 9, 23, 156
- Barnard's star 23, 113, 118, 156, 262
- barred spiral galaxy 23, 23
- barycenter 24
- base
- lunar 89
- Mars 93
- space 129
- basin (impact) 24, 29, 78
- Battani, Al. *See* Al-Battani (Albatagnius)
- baud (rate) 24
- bay, payload 108
- Bayer, Johann 156
- Beagle 2 (Mars lander) 94
- beam 24, 38
- beam rider 24
- Bean, Alan L. 156, 183, 255–256, 260
- Belka (dog in space) 247
- Bell Burnell, (Susan) Jocelyn 156–157, 188
- bell nozzle 24, 24
- Belt of Orion 24
- Belyayev, Pavel 251
- Bernal, John Desmond 24, 157, 238–239
- Bernal sphere 24, 157, 238–239
- berthing 24, 24
- Bessel, Friedrich Wilhelm 157, 168
- beta decay 24–25
- beta particle 25
- Beta Persei (star) 233
- Betelgeuse (star) 136
- Bethe, Hans Albrecht 30, 157, 221
- Biela, Wilhelm von 158
- Biela's comet 158
- Biermann, Ludwig 158
- big bang 12, 25, 45, 151, 159–160, 173, 180–181, 183, 185, 189, 197, 223, 238
- big crunch 25
- binary, astrometric 18
- binary digit (bit) 25
- binary star system 18, 25, 46, 102, 108, 150, 152, 157, 159, 172, 183, 186, 187, 207, 217, 218, 220
- biogenic elements 25–26
- biographies 150–224
- biosphere 26, 30–31, 56, 131
- Biot, Jean-Baptiste 158
- biotelemetry 26
- bipropellant rocket 26
- bird (jargon) 26
- Birkeland, Kristian Olaf Bernhard 158
- bit 25
- blackbody 26, 44, 58, 110, 135, 193, 216
- black box 26
- black dwarf 26, 54, 134
- black holes 26, 26–27, 34–35, 40, 60, 74, 85, 91, 122, 134, 185, 193, 214
- blastoff 27
- blazar 27
- Bliss, Nathaniel 158
- bl lac (bl lacertae) object 27
- blockhouse (block house) 27
- Blue Book, Project 170
- blue giant 27
- blueshift 27, 52, 52, 164, 174
- blue supergiant 27, 136
- Bluford, Guion S., Jr. 158, 264
- BMD. *See* ballistic missile defense
- Bode, Johann Elert 158–159, 218, 232, 233
- Bode's law 158–159, 218, 232
- boiloff 27–28
- Bok, Bartholmeus "Bart" Jan 159
- Bok globules 159
- bolide 28
- bolometer 196
- Boltzmann, Ludwig 28, 135, 159, 216
- Boltzmann constant 28

- Bond, George Phillips 28, 159  
 Bond, William Cranch 159, 235  
 Bond albedo 28  
 Bondi, Sir Hermann 159–160, 183, 188–189  
 Bonestell, Chesley 243  
 booster rockets 28, 49, 86, 108, 128, 128, 131  
 Borman, Frank 152, 160, 199, 252–253, 255  
 Boscovich, Ruggero Giuseppe 160  
 Boss, Benjamin 160  
 Boss, Lewis 160  
 Bouguer, Pierre 160, 232  
 Bowen, Ira Sprague 160–161  
 Bradley, James 158, 161, 231  
 Brahe, Tycho 161, 229  
 Brahmagupta 161  
 Braun, Werner von 61, 161, 161–162, 174, 174, 240, 242–243, 243, 244, 245, 245  
 Brazil 275  
 Bredichin, Fyodor (Fedor) Aleksandrovich 162  
 Brezhnev, Leonid I. 162  
*Brick Moon, The* (Hale) 236  
 bright nebula 101  
 Brown, David M. 39, 273  
 Brown, Ernest Williams 162  
 brown dwarf 28, 54, 134  
 Bruno, Giordano 162  
 Budarin, Nikolai 269  
 bulge of the Earth 28  
 Bunsen, Robert Wilhelm 163, 193  
 Burbidge, Geoffrey Ronald 163, 189  
 Burbidge, (Eleanor) Margaret 163, 189  
 burn, de-orbit 40, 50  
 burning
  - erosive 60
  - helium 75
  - progressive 113
  - radial 116
  - regressive 119
 burnout 28  
 bus 28  
 Bykovskiy, Valery 250  
 Byurakan Astrophysical Observatory 28, 152
- C**  
 cabin atmosphere 19  
 caldera 29  
 calendars 29, 72, 84, 97, 147, 168–169, 201  
 calibration 29  
 Callippus of Cyzicus 163, 177  
 Callisto (moon) 29  
 calorie 29  
 Caloris basin 29  
 Campbell, William Wallace 164, 237  
 Canadian Space Agency 83  
 canali 29, 199, 212–213  
 canard 29  
 cannibalism, galactic 67  
 cannibalize 29  
 Cannon, Annie Jump 164, 206  
 Cape Canaveral 13, 29–30, 30, 242, 243  
 capital satellites 30  
 capsules, space 95, 129, 170, 182, 247–248, 249  
 captive firing 30  
 carbon cycle (astrophysics) 30, 157, 221–222  
 carbon cycle (Earth system) 30–31  
 carbon dioxide 31, 72, 98, 155  
 carbon-nitrogen cycle 30  
 carbon-nitrogen-oxygen cycle 30  
 cargo bay 31  
 Carme (moon) 204  
 Carpenter, Scott 164  
 Carr, Gerald P. 260  
 Carrington, Richard Christopher 164  
 Carter, Jimmy 262  
 Cartesian coordinates 22, 31, 49  
 case (rocket) 31  
 Cassegrain, Guillaume 31, 165  
 Cassegrain telescope 31, 165  
 Cassini, César-François (Cesare Francesco) 165–166  
 Cassini, Giovanni Domenico (Jean-Dominique) 31–32, 165, 210, 231  
 Cassini, Jacques 165  
 Cassini, Jacques-Dominique 165–166  
 Cassini Division 165  
 Cassini-Huygens mission 31–32, 32, 33, 77, 273, 274, 275  
 Castro, Fidel 249  
 cavitation 32  
 CCAFS. *See* Cape Canaveral  
 CCD. *See* charge-coupled device  
 CD nozzle. *See* converging-diverging nozzle  
 celestial 32  
 celestial body 32  
 celestial equator 33, 284  
 celestial latitude 32, 33  
 celestial longitude 32, 33, 41  
 celestial mechanics 32, 33, 188, 195, 196, 208  
 celestial sphere 33  
 Celsius, Anders 33, 166, 231–232  
 Celsius temperature scale 33, 166, 232  
 Centaur (rocket) 33, 176  
 Centaurs (asteroids/comets) 33, 36  
 center of gravity 22, 33  
 center of mass 24, 33  
 central force 33  
 Centre National d'Etudes Spatiales (CNES) 16, 33–34, 133  
 Centre Spatial Guyanais. *See* Guiana Space Center  
 centrifugal force 16, 28, 34  
 centripetal force 34  
 Cepheid variable 34, 155, 189, 196–197, 215, 237  
 Ceres (asteroid) 17, 34, 47, 54, 127, 206, 233, 276, 277, 310  
 Cernan, Eugene A. 166, 178, 213, 255, 259  
 Cerro Tololo Inter-American Observatory (CTIO) 34  
 CEV. *See* crew exploration vehicles  
 CGRO. *See* Compton Gamma Ray Observatory  
 CGS. *See* Guiana Space Center  
 Chadwick, Sir James 239  
 Chaffee, Roger B. 13, 166, 184, 222, 254  
*Challenger* (space shuttle)
  - accident of 34, 105, 191, 201, 204, 209, 210, 214, 216, 219, 265, 266, 266
  - African American on 158, 264
  - American woman on 210, 264
  - flights/missions of 217, 264, 265
 Chandler, Seth Carlo 166  
 Chandler period 166  
 Chandler wobble 166  
 Chandrasekhar, Subrahmanyan 34–35, 166–167  
 Chandrasekhar limit 34–35  
*Chandra X-ray Observatory* (CXO) 35, 35, 71, 167, 169, 271, 272  
 Changzheng-2C (CZ-2C, launch vehicle) 88  
 chaos 35  
 chaotic orbit 35, 36  
 chaotic terrain 35  
 charge-coupled device (CCD) 19, 35–36  
 charged particle 36, 158  
 Charon (moon) 36, 111, 262  
 charts and tables 280–315  
 chaser spacecraft 36, 43, 52, 253  
 chasma/chasmata 36  
 Chawla, Kalpana 39, 273  
 checkout 36, 41  
 chemical rocket 36, 121  
 chilldown 36  
 chimpanzees 17, 17, 58, 73–74, 247–248  
 China 88, 124, 137, 198, 274, 290  
 Chiron (asteroid/comet) 33, 35, 36  
 Chladni, Ernst Florens Friedrich 167  
 choked flow 37  
 Christie, William Henry Mahoney 167  
 Christy, James Walter 36, 262  
 chromatic aberration 37, 174  
 chromosphere 37, 115  
 chronology 226–278  
 Chryse Planitia (Mars) 37  
 chugging 37  
 CHZ. *See* continuously habitable zone  
 circadian rhythms 37  
 circle 41  
 circular orbits 43  
 circumsolar space 37  
 circumstellar 37  
 cislunar 37  
 Clairaut, Alexis-Claude 167  
 Clark, Alvan 167–168  
 Clark, Alvan Graham 168  
 Clark, Laurel Blair Salton 39, 273  
 Clarke, Sir Arthur C. 37, 39–40, 168, 241, 242, 250  
 Clarke orbit 37  
 Claudius Ptolemaeus. *See* Ptolemy  
 Clausius, Rudolf Julius Emmanuel 74, 168  
 Clavius, Christopher 72, 168–169  
 Cleator, P. E. 239  
 Cleaver, A. V. 241  
*Clementine* (spacecraft) 268

- clock  
 atomic 20, 140  
 spacecraft 129
- closed universe 25, 37–38, 45
- cluster  
 galactic 68  
 of galaxies 2, 38, 88, 150, 215, 224  
 globular 15, 70, 112  
 open 68  
 star 134, 134
- CMB. *See* cosmic microwave background
- CME. *See* coronal mass ejection
- CNES. *See* Centre National d'Etudes Spatiales
- COBE. *See* Cosmic Background Explorer
- Cocconi, G. 245
- cold-flow test 38
- cold war 38, 193, 194, 243, 244, 246
- collimator 38
- Collins, Eileen Marie 169, 169, 268, 271
- Collins, Michael 169, 255
- color 38
- Columbia (space shuttle)  
 accident of 38–39, 105, 273  
 flights/missions of 171, 224, 263, 264, 271, 272
- coma 36, 39, 137–138
- combustion chamber 26, 38, 39
- comet(s) 39  
 basin of 24  
 coma of 36, 39, 137–138  
 extraterrestrial catastrophe  
 theory of 63, 63, 152  
 long-period 88  
 nucleus of 103, 103, 222  
 Oort cloud of 104  
 periodic 39, 108  
 short-period 124, 158  
 tail of 39, 137–138, 158, 162  
 telescopic discovery of 234
- Comet Encke 177
- Comet Halley 39, 70, 73, 154, 167, 171, 181–182, 185, 222, 265
- Comet Shoemaker-Levy 9 268
- Comet Tempel 48, 174, 235, 274
- Comet Wild 2 134, 274
- command destruct 39, 50
- Common, Andrew Ainslie 169  
 communication and contact,  
 interstellar 81, 144
- communications satellite(s)  
 39–40, 168, 205, 241, 247,  
 249, 250, 251, 252, 260  
 active 39  
 direct broadcast 51  
 orbit of 37, 39–40, 98  
 passive 39
- compact body 40
- companion body 7, 40
- compressible flow 40
- Compton, Arthur Holly 40, 169
- Compton Gamma Ray  
 Observatory (CGRO) 40, 40,  
 64, 71, 169, 267, 272
- Compton scattering 40, 169
- concave lens 40, 52
- Condon, Edward Uhler 169–170
- conduction 40, 74
- Congreve, Sir William 170,  
 233, 234
- conic section 40–41, 153  
 conjunction 41, 41
- Conrad, Charles “Pete,” Jr. 156,  
 170, 183, 254, 255–256, 260
- conservation  
 of angular momentum 41  
 of energy 41  
 of mass and energy 41  
 of momentum 41, 102
- console 41–42
- constellation (aerospace) 42, 100
- constellation (astronomy) 8,  
 9, 10, 42, 42, 226, 283,  
 284–287
- Constellation Program 42
- continuously crewed spacecraft  
 42
- continuously habitable zone  
 (CHZ) 42, 55, 56
- continuously manned spacecraft  
 42
- control rocket 42
- convection 42–43, 74
- converging-diverging (CD)  
 nozzle 43, 49, 172
- converging lens 43, 87
- convex lens 43
- cooling  
 ablative 2  
 film 65  
 mass transfer 2
- Cooper, Leroy Gordon, Jr. 170
- cooperative target 43
- co-orbital 43
- coordinate axes 31
- coordinate planes 31
- Copernican system 43, 180
- Copernicus, Nicholas 43, 44,  
 162, 171, 171, 180, 192, 204,  
 208–209, 227, 229–230
- Copernicus Observatory  
 (spacecraft) 44
- Cordelia (moon) 124
- core (planetary) 44
- core (stellar) 44
- corona 44, 200
- Corona (reconnaissance  
 program) 247
- Corona XIV (satellite) 247
- coronal mass ejection (CME) 44
- Cosmic Background Explorer  
 (COBE) 44, 146, 267
- cosmic microwave background  
 (CMB) 25, 44, 146, 151, 173,  
 205–206, 223, 251, 267
- cosmic ray(s) 44–45, 78, 187,  
 211  
 galactic 45, 130  
 solar 45
- cosmic ray astronomy 44
- cosmic station 44
- cosmological principle 45  
 perfect 108, 183
- cosmology 45. *See also* specific  
 theories
- cosmonauts 44, 45, 128, 247.  
*See also* specific cosmonauts
- Cosmos 557 (space station) 296
- Cosmos spacecraft 45, 254
- countdown 41, 46, 76
- Cowell, Philip Herbert 162, 171
- Crab Nebula 46, 180, 201, 202,  
 211
- crater(s) 46  
 eruptive 46  
 impact 46, 56, 78, 79, 79,  
 117  
 lunar 89, 270  
 secondary 123
- crêpe ring of Saturn 172
- crewed 93
- crew exploration vehicles  
 (CEV) 106, 106
- crew-tended spacecraft 46
- Crippen, Robert L. 171, 263
- critical point 46
- critical pressure 46
- critical temperature 46
- Crommelin, Andrew Claude  
 171
- cruise phase 46
- crust 46
- cryogenic propellant 27–28, 46,  
 50, 62, 62, 114
- cryosphere 46
- CTIO. *See* Cerro Tololo Inter-  
 American Observatory
- Cuban missile crisis 193,  
 249–250
- Cunningham, R. Walter 171,  
 254–255
- Curtis, Heber Doust 172, 215
- cutoff 46, 58
- CXO. *See* Chandra X-ray  
 Observatory
- Cyclops, Project 113
- Cygnus A (galaxy) 117
- Cygnus X-1 (x-ray source) 46
- CZ-2C. *See* Changzheng-2C

## D

- Dactyl (moon) 47, 268
- Daedalus, Project 113, 262
- Danjon, André 172
- dark energy 45, 47, 50
- dark matter 47, 91, 146, 209
- dark nebula 47, 101, 159
- Darwin, Sir George Howard 172
- Dawes, William Rutter 172
- Dawn mission 47, 277
- day  
 lunar 89  
 Martian (sol) 125
- Day the Earth Stood Still, *The*  
 (movie) 242
- DBS. *See* direct broadcast  
 satellites
- de-boost 47
- debris 40, 47, 125, 130, 130,  
 262, 263, 272
- decay (orbital) 48
- decay (radioactive) 24–25, 48
- declination 48
- Deep Impact (spacecraft) 48
- Deep Impact mission 48, 274
- Deep Space Communication  
 Complexes (DSCCs) 48
- Deep Space Network (DSN)  
 48, 48
- deep-space probe 48
- Defense Meteorological  
 Satellite Program (DMSP)  
 48, 48
- Defense Support Program  
 (DSP) 48–49
- degenerate star 49, 102
- degrees of freedom (DOF) 49
- Deimos (moon) 49, 167, 185,  
 236

- De La Rue, Warren 172  
 De Laval, Carl Gustaf Patrik 49, 172  
 De Laval nozzle 49, 172  
 Delporte, Eugène-Joseph 9, 172–173  
 Delta (launch vehicle) 49, 49, 273, 289  
 delta-V 49, 49  
 dendrochronology 174  
 Denning, William Frederick 173  
 density 49  
 density parameter 49–50  
 de-orbit burn 40, 50  
 Descartes, René 31  
 descending node 50  
 DeSitter, Willem 173  
 Destiny (laboratory) 50  
 destruct 39, 50  
 deuterium 50, 77, 220  
 DeVaucouleurs, Gérard-Henri 173  
 Dewar, Sir James 50, 173  
 Dewar flask 50, 173  
 diameter  
   angular 10, 10, 160  
   apparent 14  
 diamonds (pattern) 50  
 Dicke, Robert Henry 173  
 diffraction 51  
 dinosaur extinction 63  
 Dione (moon) 165  
 Dirac, Paul Adrien Maurice 173–174  
 direct broadcast satellites (DBS) 51  
 direct conversion 51, 67, 117, 125  
 directional antenna 11, 51  
 direct readout 51  
*Discoverer 13* (satellite) 247  
*Discoverer 14* (satellite) 247  
*Discovery* (space shuttle) 77, 105, 169, 182, 194–195, 209, 265, 266, 267, 268, 270–271, 274, 275, 277  
 disk 52  
 Disney, Walter Elias “Walt” 162, 174, 174, 244  
 diurnal 52  
 diverging lens 52, 87  
 DMSP. *See* Defense Meteorological Satellite Program  
 Dobrovolsky, Georgi 128, 258  
 docking 13, 15, 43, 52, 120, 215, 253, 254, 260  
 docking module 52  
 DOF. *See* degrees of freedom  
 doffing 52  
 dogleg 52  
 dogs in space 244, 244, 247  
 Dolland, John 174, 232  
 Donati, Giovanni Battista 174, 235  
 donning 52  
 Doppler, Christian Johann 52–53, 174, 234  
 Doppler shift 27, 52, 52–53, 76–77, 115, 118, 164, 174, 189, 204, 207, 213, 215–216, 220, 234, 238  
 double-base propellant 53  
 double star system. *See* binary star system  
 Douglass, Andrew Ellicott 174  
 downlink 11, 53  
 downrange 53  
 drag 53, 108–109  
 Drake, Frank Donald 53, 113, 175  
 Drake equation 53, 175  
 Draper, Charles Stark 175  
 Draper, Henry 175, 189, 234  
 Draper, John William 175, 234  
 Dreyer, Johan Ludvig Emil 101, 175  
 drogue parachute 53  
 dry emplacement 53  
 DSCCs. *See* Deep Space Communication Complexes  
 DSN. *See* Deep Space Network  
 DSP. *See* Defense Support Program  
 Duke, Charles Moss, Jr. 175, 200, 224, 258–259  
 dust, interplanetary 81  
 dwarf galaxy 53, 200  
 dwarf planets 17, 34, 47, 53–54, 59–60, 92, 106, 110, 111, 127, 199, 275–276, 310–312  
 dwarf star 54. *See also* specific types  
 Dyna-Soar (dynamic soaring) 54, 54  
 Dyson, Sir Frank Watson 176  
 Dyson, Freeman John 176
- E**  
*Early Bird* (satellite) 252  
 early-warning satellites 54  
 Earth 54, 127, 301  
   atmosphere of 19  
   bulge of 28  
   global change on 70  
   as inner planet 80  
   as major planet 92, 110  
   rotation of 121, 172, 179, 186, 235  
   solid 56, 128  
   as terrestrial planet 138  
   trapped radiation belts of 55, 61, 130, 220, 245  
 Earth-based telescope 54  
 Earth-crossing asteroid (ECA) 17, 54  
 Earthlike planets 55, 85  
 Earth-Moon system 24, 137, 172  
 Earth-observing spacecraft 15, 21, 55, 86, 96, 116, 133, 138, 145, 196, 259, 267, 272  
 Earth radiation budget (ERB) 55  
*Earth Resources Technology Satellite-1* (ERTS-1) 259  
 Earth satellites 55  
 earthshine 55  
 Earth system 26, 30–31, 55–56, 261  
 ECA. *See* Earth-crossing asteroid  
 eccentricity 41, 56  
*Echo 1* (spacecraft) 247  
 eclipse 56  
   lunar 56  
   solar 22, 56, 156, 214  
 ecliptic (plane) 56  
 ecosphere 56  
 Eddington, Sir Arthur Stanley 164, 176, 237  
 Ehricke, Krafft A. 33, 176  
 Einstein, Albert 41, 69, 71, 76, 119, 131, 132, 164, 176, 196, 202, 207, 237  
*Einstein X-ray Observatory*. *See* HEAO-2 (satellite)  
 Eisele, Donn F. 177, 254–255  
 Eisenhower, Dwight D. 177, 221, 243, 245, 247  
 ejecta 56  
 ejection capsule 57  
 Elara (moon) 206  
 electric propulsion 57, 121  
 electromagnetic radiation (EMR) 57, 103, 200  
   attenuation of 21  
   beam of 24, 38  
   blackbody of 26  
   diffraction of 51  
   in interstellar communication 81  
   global change of 83, 190  
   polarization of 111–112  
   reflection of (albedo) 8, 28, 111, 172  
   in remote sensing 120  
   wavelength of 10, 153  
 electromagnetic spectrum 51, 57, 87, 132, 132  
 electron 36, 57  
 electron volt 57  
 element(s) 20, 57  
   abundance of 3  
   biogenic 25–26  
 ellipse 40–41, 57–58  
 elliptical orbit 43, 58, 108, 192  
 elliptical galaxy 58, 76  
 ELVs. *See* expendable launch vehicles  
 emissivity 58  
 emittance 58  
 empirical 58  
 EMR. *See* electromagnetic radiation  
 Enceladus (moon) 275  
 Encke, Johann Franz 177  
 encounter 58  
*Endeavour* (space shuttle) 105, 140, 268, 271, 271, 277, 278  
 endoatmospheric 58  
 endothermic reaction 58  
 Energia (launch vehicle) 290  
 energy 58  
   conservation of 41  
   dark 45, 47, 50  
   joule of 83  
   kinetic 22, 28, 43, 49, 85  
   potential 112  
   solar 51, 125, 126, 127  
 engine(s)  
   arc-jet 15  
   ion 82, 82  
   liquid-propellant rocket 88, 88  
   main space shuttle 131  
   reaction 117, 121  
   RP-1 122  
   vernier 42, 142  
 engine cutoff 58  
 Enos (astrochimp) 58  
 entropy 58, 168  
 environmental satellites. *See* Earth-observing spacecraft  
 ephemeris 59  
 epicycle 59, 154

- Epsilon Ring 124  
 equator  
   celestial 33, 59, 284  
   Earth's 59  
 equatorial bulge 28, 59  
 equatorial orbit 59  
 equatorial satellites 59  
 equinox 59, 72, 112, 142, 284  
 Eratosthenes of Cyrene 177, 206, 227  
 ERB. *See* Earth radiation budget  
 ergometer 59  
 Eris (dwarf planet) 54, 59–60, 127, 276, 311  
 erosive burning 60  
 ERTS-1. *See* Earth Resources Technology Satellite-1  
 eruptive crater 46  
 ESA. *See* European Space Agency  
 escape rocket 60, 60  
 escape tower 60  
 escape velocity 13, 27, 60, 314  
 ESO. *See* European Organisation for Astronomical Research in the Southern Hemisphere  
 ET. *See* extraterrestrial  
 Eudoxus of Cnidus 154, 163, 177, 226, 227  
 Euler, Leonhard 177–178  
 Europa (moon) 60, 60  
 European Organisation for Astronomical Research in the Southern Hemisphere (ESO) 60  
 European Southern Observatory (ESO) 60  
 European Space Agency (ESA) 16, 31–32, 60, 70, 72, 77, 83, 93, 129, 142, 182, 224, 262–263, 265, 290  
 EUV. *See* extreme ultraviolet radiation  
 EUVE. *See* Extreme Ultraviolet Explorer  
 EVA. *See* extravehicular activity  
 Evans, Ronald E. 178, 259  
 evening star 60  
 event horizon 27, 60, 122, 214  
 evolution, stellar 40, 135, 179, 187, 191, 211, 214, 217, 220, 222  
 evolved star 61, 102  
 exhaust plume 61  
 exoatmospheric 61  
 exobiology 17, 220  
 exosphere 61  
 exothermic reaction 61, 99  
 expanding universe 45, 47, 49–50, 61, 104, 173, 176, 197, 238  
 expendable launch vehicles (ELVs) 49, 54, 61, 86, 88, 114, 123, 139  
 experimental vehicles (X) 61  
 exploding galaxies 61  
 Explorer 1 (satellite) 61, 84, 207, 220, 244–245, 245  
 Explorer spacecraft 61–62, 63  
 external tank 62, 62, 131  
 extragalactic 62  
 extragalactic astronomy 62  
 extrasolar 62  
 extrasolar planets 62, 62, 70, 217  
 extraterrestrial (ET) 63  
 extraterrestrial catastrophe theory 63, 63, 152  
 extraterrestrial contamination 63  
 extraterrestrial life 8, 63, 123, 245  
   communication and contact with 81, 143–144  
   Drake equation and 53  
   Fermi paradox and 65, 85, 178  
   “infective theory” and 79  
   “laboratory hypothesis” of 85–86  
   little green men 88  
   Project Cyclops and 113  
   Project Ozma and 113, 175  
   Sagan (Carl Edward) and 212  
   *War of the Worlds* and 236  
   “zoo hypothesis” of 85, 148  
 extravehicular activity (EVA) 26, 63, 63, 131, 142–143, 195, 197, 217, 222, 252, 264, 265  
 Extreme Ultraviolet Explorer (EUVE) 63–64  
 extreme ultraviolet (EUV) radiation 64  
 extremophile 64  
 eyeballs in, eyeballs out 64  
 eyepiece 64
- F**  
 Fabricius, David 178, 230  
 facula 64  
 Faith-7 (space capsule) 170  
 fallaway section 64  
 farside 64, 64, 246  
 Fei, Junlong 124, 274  
 Feoktistov, Konstantin 251  
 Fermi, Enrico 64, 65, 178, 178  
 Fermi Gamma-ray Space Telescope (FGST) 64, 278  
 Fermi paradox 65, 85, 148, 178  
 ferret satellites 65  
 ferry flight 65  
 FGST. *See* Fermi Gamma-ray Space Telescope  
 field of view (FOV) 65  
 film cooling 65  
 fire arrow 65  
 fireball (bolide) 28  
 fission (nuclear) 65, 176  
 fission products 65  
 fixed satellites 65  
 fixed stars 65, 125, 188  
 flame bucket 66  
 Flamsteed, John 18, 178–179, 185, 231  
 flare, solar 45, 66, 126, 127, 164  
 flat universe model 45  
 Fleming, Williamina Paton 179, 206  
 flight crew 66  
 flight test vehicles 66  
 flux 66  
 flux, radiant 58  
 flyby 58, 66  
 focal length 66  
 folded optics 66  
 Fomalhaut b (planet) 278  
 Fontana, Joanes de 228  
 force 66  
 forced convection 42–43  
 fossa 66  
 Foucault, Jean-Bernard-Léon 179, 235  
 FOV. *See* field of view  
 Fowler, William Alfred 163, 166–167, 179, 189  
 France 16, 33–34, 72–73, 133, 290  
 Fraunhofer, Joseph von 179, 193, 234  
 freedom, degrees of 49  
 Freedom 7 (space capsule) 215, 248  
 free fall 67, 97, 145, 148  
 free-flying spacecraft (free-flyer) 67  
 frequency 67  
   band of 23  
   screaming 123  
 Friedman, Herbert 179–180  
 Friendship 7 (space capsule) 95, 182, 249  
 From the Earth to the Moon (Verne) 220, 235, 235  
 fuel. *See* propellants; specific types of fuel  
 fuel cell 51, 67  
 Functional Cargo Block (module) 147  
 fuselage 67  
 fusion 30, 44, 67, 75, 103, 134, 157, 216, 221–222
- G**  
 g (acceleration of gravity) 3, 67, 104  
 Gagarin, Yuri A. 143, 180, 180, 193, 248  
 galactic cannibalism 67  
 galactic cluster 68  
 galactic cosmic rays (GCRs) 45, 130  
 galactic nucleus 4, 35, 61, 68, 103  
 Galaxy 68. *See also* Milky Way  
 Galaxy galaxy(ies)  
   active 4  
   Andromeda 10, 151, 155, 172, 186, 189, 228  
   closed universe and 37–38  
   cluster of 2, 38, 88, 150, 215, 224  
   cosmological principle and 45  
   disk of 52  
   dwarf 53, 200  
   elliptical 58, 76  
   exploding 61  
   Hubble classification of 76  
   irregular 76, 82, 86, 125  
   Local Group of 38, 88  
   radio 117  
   Seyfert 124, 214  
   spiral 10, 23, 23, 76, 112, 124, 133, 133, 172, 211, 214  
 Galilean satellites 29, 68, 68, 81, 81, 180  
 Galilean telescope 68, 180  
 Galileo (spacecraft) 9, 20, 266, 267, 268, 269

- Galileo Galilei 3, 18, 60, 68, 93, 119, 176, 178, 180, 180, 198, 204, 212, 230
- Galileo Project 20, 47, 68, 266, 267, 268, 269
- Galle, Johann Gottfried 150, 180, 195, 196, 197
- gamma ray 57, 64, 68, 103, 107, 138, 169
- gamma ray astronomy 40, 68, 75–76
- Gamma-ray Large Area Space Telescope (GLAST)* 64
- Gamow, George 151, 180–181, 197
- Ganymede (moon) 69
- Gaposchkin, Sergei 205
- Garn, Edwin Jacob “Jake” 265
- Garriott, Owen K. 260
- Gaspra (asteroid) 267
- Gauss, Carl Friedrich 181, 181, 206, 234
- GCRs. *See* galactic cosmic rays
- GDS. *See* Great Dark Spot
- Gemini Project 54, 69, 170, 184, 213, 214, 221, 224, 252–253, 254
- Gemini 3* 252
- Gemini 4* 222, 252, 252
- Gemini 6* 216, 253, 253
- Gemini 7* 160, 199, 252–253
- Gemini 8* 253
- Gemini 9* 216
- Gemini 10* 224
- Gemini 11* 254
- Gemini 12* 199
- general relativity 69, 71, 119, 131, 164, 173, 176, 185, 193, 197, 218, 237
- GEO. *See* geostationary orbit; geosynchronous orbit
- geocentric 43, 69, 115, 161, 163, 171, 177, 186, 188, 208–209
- geographic information system (GIS) 69
- geomagnetic storm 44, 69
- geosphere 69
- Geostationary Operational Environmental Satellite (GOES-1)* 261
- geostationary orbit (GEO) 37, 39–40, 51, 69
- geosynchronous orbit (GEO) 48–49, 69–70, 168, 250, 252
- GET. *See* ground-elapsed time
- Giacconi, Riccardo 181, 211
- giant-impact model 70, 172
- giant molecular cloud (GMC) 70
- giant planets 70
- giant stars 70, 99, 134, 135, 315
- Gibson, Edward G. 181, 260
- Gill, Sir David 181, 191, 236
- Giotto di Bondone 181–182
- Giotto* (spacecraft) 39, 70, 182, 222
- GIS. *See* geographic information system
- GLAST. *See* *Gamma-ray Large Area Space Telescope*
- Glenn, John Herschel, Jr. 95, 182, 182, 249, 249, 270–271
- global change 70
- Global Positioning System (GPS) 20, 42, 70, 70, 268
- globular cluster 15, 70, 112
- glossary 2–148
- GLTS. *See* gun-launch to space
- GM. *See* guided missile
- GMC. *See* giant molecular cloud
- GMT. *See* Greenwich mean time
- Goddard, Robert Hutchings 121, 182, 182–183, 204, 219, 235, 236–237, 238
- GOES-1. See Geostationary Operational Environmental Satellite*
- Gold, Thomas 159, 183, 188–189
- Goldilocks Zone 42
- Goodricke, John 183, 233
- Gordon, Richard F., Jr. 183, 254, 255–256
- Gould, Benjamin Apthorp 183–184
- GPS. *See* Global Positioning System
- grain 70–71
- gravitation 33, 38, 45, 49, 69, 71, 102, 119, 127, 160, 203
- gravitational collapse 71
- graviton 71, 81
- gravity 71
- acceleration of 3, 67, 104
- artificial 16
- center of 22, 33
- Sun’s, and starlight 176, 237, 237
- gravity anomaly 71
- gravity assist 71
- gravity well 71
- gray body 71
- Great Dark Spot (GDS) 71
- Great Observatories Program 71, 133
- Great Red Spot (GRS) 72, 224
- Great Spiral Galaxy 10
- greenhouse effect 56, 72, 122, 155, 212
- green satellites 72
- Greenwich mean time (GMT) 72, 148
- Gregorian calendar 72, 147, 168–169
- Gregorian telescope 184
- Gregory, James 184
- Grissom, Virgil “Gus” I. 13, 166, 184, 222, 224, 249, 252, 254
- ground-elapsed time (GET) 72
- ground equipment, aerospace 6
- ground support equipment (GSE) 72
- ground track 72
- ground truth 72
- GRS. *See* Great Red Spot
- GSE. *See* ground support equipment
- Guiana Space Center 16, 33–34, 72–73, 83
- guidance system 73, 175
- guided missile (GM) 73, 98, 239
- gun-launch to space (GLTS) 73
- gyro (gyroscope) 73, 175, 235
- H**
- H I region 73
- H II region 73
- habitable payload 73
- Hadley Rille 73, 190, 224
- Haise, Fred Wallace, Jr. 184, 218, 256
- Haisheng, Nie 124, 274
- Haldane, John Burdon Sanderson 184, 205
- Hale, Edward Everett 236
- Hale, George Ellery 107, 185, 236
- half-life (radioactive) 73
- Hall, Asaph 49, 167, 185, 236
- Halley, Edmond 161, 185, 203, 231
- Halley Comet. *See* Comet Halley
- halo orbit 73
- halophile 73
- Ham (astrochimp) 17, 73–74, 247–248
- hang fire 74
- hard landing 74, 129
- Harmony (module) 277
- Harvard classification system 74, 99, 164, 179, 206–207, 214
- Harvard College Observatory (HCO) 74, 159, 164, 179, 196, 206–207
- hatch 52, 74
- Hawking, Stephen William 74, 185–186
- Hawking radiation 74, 186
- HCO. *See* Harvard College Observatory
- HEAO-1* (satellite) 75
- HEAO-2* (satellite) 75–76, 181
- HEAO-3* (satellite) 75
- heat conversion, direct 51, 67, 117, 125
- heat death of universe 74, 168
- heating, aerodynamic 6, 118, 205
- heat soak 74
- heat transfer 40, 42–43, 74, 135
- heavy hydrogen 50
- heavy-lift launch vehicles (HLLV) 74–75
- HEL. *See* high-energy laser weapons
- Helin, Eleanor Kay 19
- heliocentric 43, 75, 154–155, 162, 171, 180, 192, 229–230
- heliocentric parallax 11
- heliometer 75, 160, 174, 232
- heliopause 75, 267
- heliosphere 75
- heliostat 75
- helium 30, 75, 157, 191, 196, 198, 235–236
- helium burning 75
- Henderson, Thomas 186
- Henry Draper Catalogue* 164, 175, 179, 206–207
- HEO. *See* high Earth orbit
- Heraclides of Pontus 186, 226
- Hero of Alexandria (Heron) 186, 227
- Herschel, Caroline 177, 186, 233
- Herschel, Sir John (Frederick William) 186

- Herschel, Sir (Frederick)  
William 141, 186, 187, 208,  
232–233
- hertz 75, 187
- Hertz, Heinrich Rudolf 187
- Hertzsprung, Ejnar 75, 187, 211
- Hertzsprung–Russell (H-R)  
diagram 27, 70, 75, 187,  
211, 315
- Hess, Victor Francis 45, 187
- Hevelius, Johannes 187,  
230–231
- Hewish, Antony 156–157, 188,  
212
- high Earth orbit (HEO) 75
- High Energy Astronomy  
Observatory (HEAO) 75–76,  
181
- high-energy laser (HEL)  
weapons 22
- highlands, lunar 89, 175, 259
- high-performance interceptor  
missiles 22
- Hill, George William 162, 188
- Himalia (moon) 206
- Hipparchus of Nicaea 153–154,  
188, 208, 227
- HLLV. *See* heavy-lift launch  
vehicles
- Hohmann, Walter 76, 188, 238
- Hohmann transfer orbit 76, 188
- hold 76
- holddown test 30, 76
- Horrocks, Jeremiah 188, 230
- Horsehead Nebula 47, 76
- hot-fire test 76
- hot Jupiter 76, 76
- housekeeping (spacecraft) 76
- Hoyle, Sir Fred 159, 163, 183,  
188–189
- H-R diagram. *See* Hertzsprung–  
Russell diagram
- HST. *See* Hubble Space  
Telescope
- Hubble, Edwin Powell 76–77,  
172, 173, 189, 190, 197, 237,  
238
- Hubble classification 76
- Hubble constant 76–77,  
173–174
- Hubble's law 76–77, 189, 238
- Hubble Space Telescope (HST)  
24, 36, 71, 77, 77, 83, 104,  
217, 267, 268, 270, 272, 275,  
278
- Huggins, Margaret Lindsay 189
- Huggins, Sir William 189, 235
- Hulse, Russell Alan 190
- human factors engineering 77
- Humason, Milton Lassell 190
- Husband, Rick D. 39, 273
- Huygens (probe) 31, 77, 274
- Huygens, Christiaan 32, 77,  
139, 190, 231
- Hyder Ally of Mysore 233
- Hydra (moon) 36, 111, 275
- hydrazine 7, 77, 99
- hydrogen 77–78, 205, 211  
atomic 77  
conversion to helium 30,  
157  
in cosmic rays 45  
heavy 50, 77  
in H I region 73  
in H II region 73  
ionized 77  
isotopes of 77  
liquid 33, 46, 77–78, 88,  
131, 173, 219  
molecular 77, 98  
ordinary 77, 114  
radioactive 77, 139
- hydrogen bomb 243
- hydrosphere 56, 78
- hyperbola 40–41
- hyperbolic orbit 78
- hypergolic fuel 78, 88, 114
- hypergolic ignition 78
- Hyperion (moon) 159, 196
- hypersonic 78
- hypervelocity impact 78
- HZE particles 78
- I**
- Apetus (moon) 165
- IAU. *See* International  
Astronomical Union
- ICBM. *See* Intercontinental  
ballistic missile
- ice catastrophe 56, 78
- Ida (asteroid) 47, 78, 268
- igniter 78
- ignition, hypergolic 78
- image 78
- imagine instrument. *See* charge-  
coupled device
- Imbrium basin 78
- impact 78
- impact crater 46, 56, 78, 79,  
79, 117
- impulse, specific 132
- incidence, angle of 10, 10
- inclination 79
- inclination, orbit 105
- incompressible fluid 79
- India's Space Research  
Organization (ISRO) 263
- inertia 67, 79
- inertial upper stage (IUS) 79
- “infertive theory of life” 79
- inferior conjunction 41
- inferior planets 79
- infinity 79
- in-flight phase 79
- infrared astronomy 60, 79, 83
- Infrared Astronomy Satellite  
(IRAS) 264
- infrared radiation (IR) 54, 55,  
57, 79, 83, 138, 187, 196, 264
- injection, orbital 104
- injector 80
- inner planets 80
- Innes, Robert Thorburn Ayton  
190
- insertion 80
- integration 80
- intelligence  
artificial 17  
extraterrestrial, search for  
53, 113, 123, 123, 144,  
175, 245
- INTELSAT. *See* International  
Telecommunications Satellite  
Organization
- Intelsat-1* (Early Bird, satellite)  
252
- intercontinental ballistic missile  
(ICBM) 19, 28, 80, 177, 193,  
194, 221, 246
- interferometer 80
- intergalactic 80
- intermediate-range ballistic  
missile (IRBM) 80, 139
- International Astronomical  
Union (IAU) 34, 53, 80, 110,  
275–276
- International Space Station*  
(ISS) 42, 50, 80, 80, 83, 140,  
147, 148, 194–195, 222–223,  
264, 268, 269, 271, 271, 274,  
275, 276, 277, 278, 293,  
297–300
- international system of units.  
*See* SI units
- International Telecommunications  
Satellite Organization  
(INTELSAT) 251
- interplanetary 80
- interplanetary dust (IPD) 81
- interstage section 81
- interstellar 37, 81
- interstellar communication and  
contact 81, 144
- interstellar medium (ISM) 14, 81
- interstellar probe 81, 81
- intravehicular activity (IVA) 81
- inverse square law 21, 81
- inviscid fluid 81
- Io (satellite) 81, 81
- ion 36, 81
- ion engine 82, 82
- ionized hydrogen 77
- ionizing radiation 5, 82, 103,  
116
- ionosphere 82
- IPD. *See* interplanetary dust
- IR. *See* infrared radiation
- IRAS. *See* Infrared Astronomy  
Satellite
- IRBM. *See* intermediate-range  
ballistic missile
- irregular galaxy 76, 82, 86, 125
- Irwin, James Benson 190,  
223–224, 258
- Ishtar Terra 82
- island universe 82, 172, 189,  
191, 232, 237
- ISM. *See* interstellar medium
- isotope 83, 117
- isotropic 45, 83
- Israel 29, 266, 273, 290
- ISRO. *See* India's Space  
Research Organization
- ISS. *See* International Space  
Station
- Italian Space Agency 93
- IUS. *See* inertial upper stage
- IVA. *See* intravehicular activity
- J**
- James Webb Space Telescope*  
(JWST) 83, 221
- jansky 83, 190
- Jansky, Karl Guthe 83, 190,  
209, 239
- Janssen, Pierre-Jules-César  
190–191, 198, 235
- Japanese Space Exploration  
Agency (JAXA) 83, 267, 290
- Jarvis, Gregory B. 34, 191
- JAXA. *See* Japanese Space  
Exploration Agency
- Jeans, Sir James Hopwood 191
- jettison 83

- Jiuquan Satellite Launch Center 124  
 Jodrell Bank Experimental Station 198  
 Jones, Sir Harold Spencer 191  
 joule 29, 83  
 Joule, James Prescott 83  
 Jovian planet 83–84, 91  
 Julian calendar 72, 84, 168–169, 201  
 Jupiter 84, 84, 127, 302  
   auroras of 21  
   comet collision with 268  
   Galilean satellite of 81, 81  
   Galileo Project to 20, 68, 266, 267, 269  
   as giant planet 70  
   Great Red Spot of 72, 224  
   as major planet 92, 110  
   moons of 9, 9, 29, 60, 60, 69, 152, 156, 180, 204, 206, 210  
   as outer planet 106  
   *Pioneer* spacecraft to 109–110, 258, 259  
   rings of 121  
   Voyager mission to 143–144, 261  
 Jupiter C (rocket) 61, 84  
 Jupiter-like planet 83–84  
 JWST. *See James Webb Space Telescope*
- K**
- Kaifeng, Battle of 228, 228  
 Kant, Immanuel 82, 191, 196, 222, 232  
 Kapteyn, Jacobus Cornelius 191–192  
 Kapustin Yar 84, 241  
 Kármán, Theodore von. *See Von Kármán, Theodore*  
 Keck Observatory 83, 84, 104  
 Keeler, John Edward 192  
 Keenan, Philip Childs 99, 192, 203  
 kelvin 84, 192  
 Kelvin, William Thomson, Lord 84, 192  
 Kennedy, John F. 13, 192, 192, 193, 221, 248, 250  
 Kennedy Space Center (KSC) 29–30, 34, 84, 84, 130  
 Kepler (spacecraft) 85  
 Kepler, Johannes 18, 43, 85, 152, 161, 178, 192, 192–193, 198, 204, 209, 229–230, 265  
 Keplerian elements 79, 85, 283  
 Kepler mission 85  
 Kepler's laws 85, 192  
 Kerr, Roy Patrick 85, 193  
 Kerr black hole 85, 193  
 Kerwin, Joseph P. 260  
 Key, Francis Scott 234  
 Khrushchev, Nikita S. 193, 194, 250  
 kilocalorie 29  
 kinetic energy 22, 28, 43, 49, 85  
 Kirchhoff, Gustav Robert 163, 193  
 Kirkwood, Daniel 85, 193–194, 235  
 Kirkwood gaps 85, 193–194, 235  
 Komarov, Vladimir M. 128, 194, 251, 254  
 Korolev, Sergei 194, 194, 219, 241, 244  
*Kosmos* (spacecraft) 45  
 Kotov, Oleg V. 276  
 Krikalev, Sergei 194–195, 268  
 KSC. *See Kennedy Space Center*  
 Kubasov, Valerie N. 260  
 Kubrick, Stanley 168  
 Kuiper, Gerard Peter 85, 195, 242  
 Kuiper belt 54, 85, 101, 111, 115, 139, 195, 242, 275, 276
- L**
- “laboratory hypothesis” 85–86  
 Lacaille, Nicolas-Louis de 195  
 LAGEOS (satellite) 261  
 Lagrange, Joseph-Louis 86, 195, 232  
 Lagrangian libration points 73, 83, 86, 86, 195, 232  
 Laika (dog in space) 244, 244  
 Lalande, Joseph-Jérôme Le Français de 195  
 Landau, Lev Davidovich 196, 239  
 lander (spacecraft) 86  
 landing  
   hard 74, 129  
   soft 93, 125, 129  
 LANDSAT 86, 259  
 Langley, Samuel Pierpont 192, 196, 196, 236  
 Laplace, Pierre-Simon, marquis de 196, 222, 233  
 Large Magellanic Cloud (LMC) 86, 91, 265  
 La Silla Paranal Observatory 60  
 Lassell, William 196, 235  
 latitude  
   celestial 32, 33  
   and Earth radiation budget 55  
 launch 41, 73, 86  
 launch azimuth 86  
 launchpad 86, 106  
 launch site 86. *See also* specific sites  
   downrange from 53  
   dry emplacement 53  
   spaceport 130  
   wet emplacement 146  
 launch vehicle(s) 86, 213, 243, 289, 289–291. *See also* specific launch vehicles  
   characteristics of 290–291  
   expendable 49, 54, 61, 86, 88, 114, 123, 139  
   heavy-lift 74–75  
   reusable 86, 120  
   Russian 114, 114, 128, 128, 142, 147, 193, 242, 290  
   space 130  
 launch window 86  
 Leavitt, Henrietta Swan 196–197, 206  
 LEM. *See* lunar module  
 Lemaître, Georges-Édouard 181, 197, 238  
 lens 87, 119  
   concave 40, 52  
   converging 43, 87  
   convex 43  
   diverging 52, 87  
 LEO. *See* low Earth orbit  
 Leo, constellation of 27  
 Leonov, Alexei Arkhipovich 128–129, 142–143, 197, 251–252, 260  
 Leverrier, Urbain-Jean-Joseph 150, 180, 181, 197, 234  
 Ley, Willy 198, 242–243  
 LGP. *See* light-gathering power  
*Liberty Bell 7* (space capsule) 184, 249  
 libration point, Lagrangian 73, 83, 86, 86, 195, 232  
 Lick Observatory 87, 206  
 life, infective theory of 79  
 life support system (LSS) 87, 119  
 life tests, accelerated 3  
 liftoff 27, 64, 87, 87  
 light 57, 87  
   color of 38  
   reflection of 118  
   refraction of 119  
   speed of 119, 132, 179, 187, 201, 210  
   visual 38  
   zodiacal 148  
 light-gathering power (LGP) 87  
 light pollution 87  
 light time 87  
 light-year 87  
 limb 87  
 Limited Test Ban Treaty 250  
 Lindblad, Bertil 198  
 line of apsides 87  
 line of sight (LOS) 88, 164  
 Lippersheim, Jan. *See* Lippershey, Hans  
 Lippershey, Hans 119, 198, 230  
 liquid hydrogen 33, 46, 77–78, 88, 131, 173, 219  
 liquid oxygen 46, 78, 88, 131, 219, 238  
 liquid propellant 46, 88, 99, 114, 121, 131, 162, 219  
   cavitation in 32  
   chugging of 37  
   cold-flow test of 38  
   first use of 33, 182, 238, 238  
   sloshing of 125  
 liquid-propellant rocket engine 88, 88  
 lithium hydroxide (LiOH) 88  
 little green men (LGM) 88  
 little Pluto 111  
 LM. *See* lunar module  
 LMC. *See* Large Magellanic Cloud  
 Local Group 38, 88  
 Lockyer, Sir Joseph Norman 75, 190–191, 198, 235–236  
 longitude, celestial 32, 33, 41  
 Long March (LM, launch vehicle) 88, 124, 198, 290  
 long-period comet 88  
 Lopez-Alegria, Michael 276  
 Lousma, Jack R. 260  
 Lovell, Sir Alfred Charles Bernard 198



- Lovell, James Arthur, Jr. 152, 184, 199, 218, 252–253, 255, 256
- low Earth orbit (LEO) 89
- Lowell, Percival 29, 199, 213, 218–219
- LRO. *See* *Lunar Reconnaissance Orbiter*
- LSS. *See* life support system
- Lucid, Shannon W. 199, 199, 223, 269, 270
- luminosity 89
- luminosity class, stellar 70, 75, 89, 99, 135, 314
- Luna (spacecraft) 89, 90, 253, 256–257
- lunar 89
- lunar base 89
- lunar crater 89
- lunar day 89
- lunar eclipse 56
- lunar excursion module (LEM). *See* lunar module
- lunar highlands 89, 175, 259
- lunar module 89, 89, 255, 256, 257
- lunar orbiter 89
- Lunar Orbiter* (spacecraft) 89, 253–254
- lunar probe 89
- Lunar Prospector* (spacecraft) 89, 270
- Lunar Reconnaissance Orbiter* (LRO) 89–90
- lunar rover 90, 90, 214, 258, 259
- Lundmark, Knut Emil 199–200
- Lunik* (spacecraft) 245–246
- Lunokhod* (robot vehicle) 90, 91
- Luyten, Willem Jacob 200
- Lyot, Bernard-Ferdinand 200
- Lysithea (moon) 204
- M**
- Mach, Ernst 200
- Mach number 43, 91
- MACHO 91
- Magellan, Ferdinand 91, 200, 228–229
- Magellanic Clouds 53, 86, 91, 125, 173, 200, 215, 265
- Magellan mission 91, 91, 266
- magma 91
- magnetograph 156
- magnetohydrodynamics (MHD) 51, 91, 151
- magnetometer 92
- magnetosphere 92, 116, 158, 292
- magnitude 92, 92, 207–208
- absolute 2
- apparent 2, 14
- maximum 10
- minimum 10
- order of 105
- main-belt asteroid 92, 107, 193–194, 203, 204, 206, 232, 258, 267, 268
- main-sequence star 44, 54, 92, 99, 117, 135, 315
- main stage 92
- major planets 92, 110, 127, 301
- Malenchenko, Yuri 277
- maneuverability, delta-V of 49, 49
- manipulator 92, 119, 119
- manned 93
- man-tended spacecraft 46
- maria 93, 95
- Mariner spacecraft 93, 93, 141, 207, 249, 251, 257, 260
- Mars 93, 93, 127, 303
- canali of 29, 199, 212–213
- Chryse Planitia of 37
- Constellation Program to 42
- as inner planet 80
- as major planet 92, 110
- Mariner mission to 93, 141, 207, 251, 257
- moons of 49, 109, 167, 185, 236
- Olympus Mons of 104, 104
- Phoenix mission to 109, 277
- as terrestrial planet 138
- Utopia Planitia of 141
- Valles Marineris of 141
- Victorial Crater of 278
- Viking Project to 37, 142, 143, 207, 260–261
- Mars base 93
- Mars Climate Orbiter* (MCO) 271–272
- Mars expedition 93, 93
- Mars Exploration Rover (MER) 93, 94, 273, 273
- Mars Express* (spacecraft) 93–94, 142
- Mars Global Surveyor* (MGS, spacecraft) 94, 270
- Mars Observer* (spacecraft) 267
- Mars Odyssey* (spacecraft) 94, 272
- Mars Pathfinder* (spacecraft) 93, 94, 270
- Mars Polar Lander* 272
- Mars Project, The* (von Braun) 243
- Mars Reconnaissance Orbiter* (MRO) 94, 94, 274, 275
- Mars surface rovers 94
- Martian 94
- Martian day (sol) 125
- Martian meteorites 94–95, 95, 269
- mascon 95
- Maskelyne, Nevil 200
- mass 95
- atomic 20
- center of 24, 33
- conservation of 41
- missing 47
- solar 126
- mass-energy equation 41, 119
- mass fraction 95
- mass number 95
- mass transfer cooling 2
- mating 95
- matter, dark 47
- Mattingly, Thomas K., II 200, 258–259
- Maxwell, James Clerk 192, 200
- Maxwell Montes 95
- McArthur, William 274
- McAuliffe, S. Christa Corrigan 34, 201, 201, 277
- McCool, William C. 39, 273
- McDivitt, James 252
- McNair, Ronald E. 34, 201
- MCO*. *See* *Mars Climate Orbiter*
- mean solar time 72, 95
- medicine
- aerospace 6, 130
- space 130
- mediocrity, principle of 53
- megaparsec 95
- MER. *See* Mars Exploration Rover
- Mercury 95, 95, 127, 304
- Caloris basin of 29
- as inferior planet 79
- as inner planet 80
- as major planet 92, 110
- Mariner mission to 93, 260
- Messenger* spacecraft to 96, 277
- orbit of 186
- as terrestrial planet 138
- Mercury Project 54, 58, 69, 73–74, 95, 164, 170, 182, 184, 213, 215, 221, 245, 247–248, 249
- Messenger* (spacecraft) 96, 277
- Messier, Charles 96, 201
- Messier catalogue 46, 96, 101, 201
- meteor(s) 28, 96
- meteorite(s) 96
- extraterrestrial origin of 158, 167
- Martian 94–95, 95, 269
- meteoroids 96
- meteorological rockets 96
- meteorological satellites 96, 100, 145, 145, 246, 261, 262
- Meteorat-1* (satellite) 262
- methanogen 96
- Metonic calendar 97, 201
- Meton of Athens 97, 201, 226
- metric system 281. *See also* SI units
- MGS*. *See* *Mars Global Surveyor*
- MHD. *See* magnetohydrodynamics
- Michelson, Albert Abraham 201–202, 203
- Michelson-Morley experiment 201–202
- microgravity 80, 97, 97
- micrometer 97
- microwave background radiation. *See* cosmic microwave background
- microwave radiation 97, 122
- MIDAS (satellite) 246
- military satellites (MILSAT) 48–49, 54, 98, 117, 137, 137, 246
- Milky Way Galaxy 68, 88, 98, 98, 133, 187, 198, 204–205, 215
- Miller, Stanley Lloyd 202, 220
- Milne, Edward Arthur 202
- MILSAT. *See* military satellites
- minimum magnitude 10
- Minkowski, Rudolph Leo 202
- minor planets. *See* asteroid(s)
- Mintaka (star) 24
- Minuteman (missile) 243
- Mir* (space station) 52, 98, 169, 199, 265, 268–269, 269, 270, 272, 296
- Miranda (moon) 195

- mirror  
 concave 40, 52  
 converging 43  
 convex 43  
 diverging 52  
 largest in space 83  
 primary 118  
 mirror matter 12
- missiles 98. *See also* specific types  
 destruct of 39, 50  
 guided 73, 98, 239  
 satellite surveillance for 48–49, 54
- missing mass 47
- mission control 41–42
- Mitchell, Edgar Dean 202, 211, 215, 257
- Mitchell, Maria 202–203, 234
- MK system. *See* Morgan-Keenan classification system
- modulation 98
- molecular cloud, giant 70
- molecular hydrogen 77, 98
- molecule 98
- Molniya orbit 98, 252
- momentum 98  
 angular 11, 41, 73  
 Compton scattering and 40  
 conservation of 41, 102  
 force and 66, 102
- monopropellant 99
- month, sidereal 124
- Moon 99, 305. *See also* Earth-Moon system  
 age of 7  
 Apollo Project to 13, 14, 89, 162, 175, 192, 193, 213, 214, 221, 251, 252, 253, 254–259, 294  
 base on 89  
 Clementine mission to 268  
 Constellation Program to 42  
 craters of 89, 117, 270  
 farside of 64, 64, 246  
 first landing on 155, 248, 255, 255  
 Hadley Rille of 73, 190, 224  
 highlands of 89, 175, 259  
 Imbrium basin of 78  
 Kennedy challenge and 13, 248  
 mascon of 95  
 nearside of 99, 101, 109, 187, 246
- orbit of 188  
 origin of, giant-impact model of 70, 172  
 phases of 97, 109, 109, 201  
 Ranger Project to 117, 117, 207  
 rays of 117  
 regolith of 119  
 return to 89–90, 106, 106  
 rilles of 120  
 Russian mission to 89, 90, 245, 253, 256–257  
 Surveyor Project to 137, 137, 207, 253
- moon(s) 99, 127. *See also* specific moons  
 craters of 46  
 Roche limit and 121, 210  
 shepherd 124  
 synchronous rotation of 137
- Morgan, Barbara R. 277
- Morgan, William Wilson 99, 192, 203
- Morgan-Keenan classification system 99, 192, 203
- Morley, Edward Williams 201–202, 203
- Morrison, Philip 245
- mother spacecraft 99
- motion  
 apparent 15  
 degrees of freedom 49  
 Newton's laws of 66, 98, 102, 121, 185, 203  
 proper 18, 23, 114  
 retrograde 120
- MRO. See Mars Reconnaissance Orbiter*
- multispectral sensing 86, 99
- multistage rocket 92, 99, 141, 219, 242
- Musgrave, Story 264
- N**
- nadir 99
- naked eye 100
- nanometer 100
- NASA 100, 245. *See also* specific astronauts, missions, and spacecraft
- NASDA. *See* Japanese Space Exploration Agency
- National Aeronautics and Space Administration. *See* NASA
- National Environmental Satellite, Data, and Information Service (NESDIS) 100
- National Oceanic and Atmospheric Administration (NOAA) 100, 261
- National Radio Astronomy Observatory (NRAO) 100, 113, 142, 175
- National Reconnaissance Office (NRO) 100, 247
- National Space Development Agency of Japan. *See* Japanese Space Exploration Agency
- natural convection 42
- natural satellites. *See* Moon; moon(s)
- navigation satellites 100, 246, 248, 268
- near-Earth asteroids (NEAs) 9, 13, 17, 19, 100, 172–173, 209  
 nearside 99, 101, 109, 187, 246  
 NEAs. *See* near-Earth asteroids
- nebula 101, 186, 196, 232, 233. *See also* specific nebulae  
 bright 101  
 dark 47, 101, 159  
 planetary 111  
 solar 126  
 spiral 172, 211, 215
- Nie, Haisheng 124, 274
- NEP. *See* nuclear-electric propulsion
- Neptune 101, 101, 127, 306  
 auroras of 21  
 discovery of 150, 155, 180, 181, 195, 197, 234  
 as giant planet 70  
 Great Dark Spot of 71  
 as major planet 92, 110  
 moons of 139, 140, 195, 196  
 as outer planet 106  
 rings of 121  
 Voyager mission to 143–144, 261, 266
- Nereid (moon) 195
- NESDIS. *See* National Environmental Satellite, Data, and Information Service
- neutrino 81, 101
- neutron 101, 239
- neutron star 35, 40, 101, 115, 134, 183, 190, 196, 218, 224, 239
- Newcomb, Simon 203
- New General Catalog of Nebulae and Cluster of Stars (NGC)* 101
- New Horizons Pluto–Kuiper Belt Flyby mission 36, 101, 101, 275
- newton 101
- Newton, Sir Isaac 3, 101, 102, 119, 152, 176, 179, 203, 231
- Newtonian telescope 102, 118, 203
- Newton's law of gravitation 71, 102, 160, 203
- Newton's laws of motion 66, 98, 102, 121, 185, 203
- Nicholson, Seth Barnes 204
- Nix (moon) 36, 111, 275
- Nixon, Richard M. 258
- NOAA. *See* National Oceanic and Atmospheric Administration
- northbound node 17
- nose cone 40, 102
- nova 102, 235
- nozzle 102, 102  
 aerospike 7  
 annular 11  
 bell 24, 24  
 converging-diverging 43, 49, 172  
 De Laval 49, 172
- NRAO. *See* National Radio Astronomy Observatory
- NRO. *See* National Reconnaissance Office
- nuclear-electric propulsion (NEP) 102, 241
- nuclear fission 65, 176
- nuclear fusion 67, 75, 103, 134, 157, 216, 221–222
- nuclear radiation 103
- nuclear reactor 103
- nuclear rocket 103, 241
- nuclear thermal rocket 103, 103
- nuclear weapons 240–241, 243, 249–250
- nucleon 103
- nucleosynthesis 103, 151, 163, 179, 189
- nucleus (atomic) 103
- nucleus (cometary) 103, 104, 222
- nucleus (galactic) 4, 35, 61, 68, 103
- nuclide 103

## O

- OAO. *See* Orbiting  
Astronomical Observatory
- Oberth, Hermann J. 121,  
161–162, 182, 204, 204, 219,  
235, 237, 239
- objective 103, 118, 119
- oblateness 104, 167, 210
- observable universe 104
- observatory(ies)  
Arecibo 15, 15  
Byurakan Astrophysical  
28, 152  
Cerro Tololo Inter-  
American 34  
*Chandra X-ray* 35, 35, 71,  
167, 169, 271, 272  
*Compton Gamma Ray* 40,  
40, 64, 71, 169, 267, 272  
*Copernicus* 44  
Great Observatories  
Program 71, 133  
Harvard College 74, 159,  
164, 179, 196, 206–207  
High Energy Astronomy  
75–76  
*Hubble Space Telescope*  
24, 36, 71, 77, 83, 104,  
217, 267, 268, 270, 272,  
275, 278  
Keck 83, 84, 104  
La Silla Paranal 60  
Lick 87, 206  
National Radio Astronomy  
100, 113, 142, 175  
Orbiting Astronomical 105  
Palomar 107, 107, 185  
Paris 107, 165–166, 210  
Royal Greenwich 18, 121–  
122, 150, 158, 162, 163,  
167, 178–179, 208  
U.S. Naval 141, 167, 185,  
203, 236  
Yerkes 99, 147, 185, 203
- occult (occultation) 104
- Odyssey* (Mars orbiter) 94
- ogive 104
- Olbers, Heinrich Wilhelm 107,  
204, 206, 233
- Olbers's paradox 204
- Olympus Mons 104, 104
- omnidirectional antenna 11,  
104
- one-g* 104
- Onizuka, Ellison S. 34, 204,  
204
- Oort, Jan Hendrik 104,  
204–205
- Oort cloud 104, 204–205
- Oparin, Aleksander Ivanovich  
184, 205
- Oparin-Haldane hypothesis  
185, 205
- open cluster 68
- open universe 45, 104
- operational orbital vehicles  
(OV) 105
- Ophelia (moon) 124
- Öpik, Ernest Julius 205
- Opportunity* (Mars rover) 93,  
94, 273, 278
- opposition 104
- optical interferometer 80
- optics  
adaptive 5  
folded 66
- OQF. *See* Orbiting Quarantine  
Facility
- orbit(s) 104  
apastron of 12  
aphelion of 12  
apogee of 12, 12, 48, 87  
apolune of 14  
ascending node of 17  
chaotic 35, 36  
circular 43  
Clarke 37  
descending node of 50  
elliptical 43, 58, 108, 192  
equatorial 59  
geostationary 37, 39–40,  
51, 69  
geosynchronous 48–49,  
69–70, 168, 250, 252  
halo 73  
high Earth 75  
Hohmann transfer 76,  
188  
hyperbolic 78  
lines of apsides in 87  
low Earth 89  
Molniya 98, 252  
parking 13, 107  
perigee of 48, 87, 108  
perihelion of 108  
perilune of 108  
perturbation of 108–109,  
234  
polar 112, 112  
prograde 113  
sun-synchronous 136  
synchronous 137, 250  
transfer 139
- orbital debris 40, 47, 125, 130,  
130, 262, 263, 272
- orbital decay 48
- orbital elements 79, 85
- orbital injection 104
- orbital period 105, 108
- orbital plane 105
- orbital transfer vehicles (OTV)  
79, 105
- Orbiter (space shuttle) 7, 105
- orbiter (spacecraft) 105
- orbit inclination 52, 105
- Orbiting Astronomical  
Observatory (OAO) 44, 105
- Orbiting Quarantine Facility  
(OQF) 105
- order of magnitude 105
- Orion* (spacecraft) 42, 106, 106
- Orion, Belt of 24
- Orion Nebula 96, 101, 106,  
169, 175, 189, 211
- oscillating universe 106
- OTV. *See* orbital transfer  
vehicles
- outer planets 70, 106
- outer space 106, 129
- OV. *See* operational orbital  
vehicles
- oxidizer 26, 53, 106
- oxygen, liquid 46, 78, 88, 131,  
219, 238
- Ozma, Project 113, 175
- P**
- pad 86, 106
- pair production 107, 173
- Pallas (asteroid) 107, 204, 233
- Palomar Observatory 107, 107,  
185
- PAM. *See* payload assist module
- panspermia 107, 155
- parabola 40–41
- parachute, drogue 53
- parallax 107, 107, 160  
annual 11, 11
- Paris Observatory 107, 165–  
166, 210
- parking orbit 13, 107
- parsec 107
- Parsons, William 211
- particle(s) 107. *See also*  
specific types  
alpha 8–9, 36  
beam of 24, 38  
beta 25
- charged 36, 158  
cosmic ray 44–45  
HZE 78
- pascal 107–108
- Pascal, Blaise 107–108
- passive communications  
satellites 39
- Pathfinder* (Mars rover) 94
- Patseyev, Victor 128, 258
- payload 73, 108, 123, 220
- payload assist module (PAM)  
108
- payload bay 108
- Payne-Gaposchkin, Cecilia  
Helena 205
- PBV. *See* postboost vehicles
- PCC. *See* permanently crewed  
capability
- Peachey, Eleanor Margaret. *See*  
Burbridge, (Eleanor) Margaret
- Pegasus (launch vehicle) 108,  
291
- penumbra 136
- Penzias, Arno Allen 25, 173,  
205–206, 223, 251
- perceived color 38
- perfect cosmological principle  
108, 183
- peri- 108
- periastron 108
- perigee 48, 87, 108
- perihelion 108
- perilune 108
- period  
Chandler 166  
orbital 105, 108  
sidereal 125
- periodic comet 39, 108
- permanently crewed capability  
(PCC) 108
- Perrine, Charles Dillion 206
- perturbation 108–109, 196, 234
- Peterson, Donald 264
- phases of Moon 97, 109, 109,  
201
- Phobos (moon) 109, 167, 185,  
236
- Phoebe (moon) 207
- Phoenix Mars Lander*  
(spacecraft) 109
- Phoenix Mars mission 109, 277
- photography 18–19
- photoheliograph 109, 172
- photometer 109, 160
- photon 109
- photosphere 37, 64, 109, 115,  
126

photovoltaic cell 51, 125  
 photovoltaic conversion 127  
 physics, space 130  
 Piazzzi, Giuseppe 17, 34, 206, 233  
 Picard, Jean 206  
 Pickering, Edward Charles 74, 164, 179, 206–207  
 Pickering, William Hayward 207, 207, 245  
 Pickering, William Henry 206, 207  
*Pioneer 5* (spacecraft) 246  
 Pioneer plaque 110  
*Pioneer 10, 11* (spacecraft) 109–110, 258, 259  
 Pioneer Venus mission 110, 262  
 Piscis Australis (constellation) 278  
 pitch 21, 49, 110, 110  
 pitchover 110  
 pixel 110  
 plage 110  
 Plains of Gold (Mars) 37  
 Planck, Max Karl 110, 115, 207  
 Planck's radiation law 110, 207  
 planet(s) 110–111. *See also* specific planets  
     core of 44  
     craters of 46  
     dwarf 17, 34, 47, 53–54, 59–60, 92, 106, 110, 111, 127, 199, 275–276, 310–312  
     Earthlike 55, 85  
     extrasolar 62, 62, 70, 217  
     giant 70  
     inferior 79  
     inner 80  
     Jovian 83–84, 91  
     major 92, 110, 127, 301  
     minor. *See* asteroid(s)  
     outer 70, 106  
     superior 41, 136  
     terrestrial 80, 138  
 planetary albedo 8, 28, 111, 172  
 planetary nebula 111  
 planetary probe 111  
 planetary ring 120–121, 121  
 planetessimals 39, 85, 111, 114, 195  
 planet fall 111  
 planetoid. *See* asteroid(s)  
 plasma 111, 128, 134, 151, 216  
 platform, space 130  
 Plesetek (launch site) 111  
 plume 111  
 plutino 111, 139  
 Pluto 111, 127, 312  
     discovery of 218–219, 239  
     as dwarf planet 54, 92, 106, 110, 111, 199, 275–276  
     moons of 36, 101, 111, 262, 275  
     New Horizons mission to 36, 101, 101, 275  
 Pluto–Kuiper Express Mission. *See* New Horizons Pluto–Kuiper Belt Flyby Mission  
 Pogson, Norman Robert 92, 207–208  
 Pogson scale. *See* magnitude  
 Pogue, William R. 260  
 Poincaré, (Jules) Henri 208  
 Polaris (missile) 243  
 polarization 111–112, 154  
 polar orbit 112, 112  
 Polar Space Launch Vehicle (PSLV) 290  
 poles 112  
 Polyakov, Valeriy 269  
 Pond, John 208  
 Pons, Jean 177, 208  
 Pontes, Marcos 275  
 Population I stars 112, 155–156  
 Population II stars 112, 155–156  
 posigrade rocket 112  
 positron 112, 173  
 postboost vehicles (PBV) 28  
 potential energy 112  
 power 112  
 power unit, auxiliary 21  
 precession 112  
 precession of equinoxes 112  
 pressure, atmospheric 19  
 pressure discontinuities 50  
 pressurized habitable environment 112  
 primal glow 44  
 primary body 113  
*Principia, The* (Newton) 185, 203–204, 231  
 prism 113, 179, 187, 234  
 probes  
     atmospheric 20  
     deep-space 48  
     interstellar 81, 81  
     lunar 89  
     planetary 111  
     star 134–135  
 prograde orbit 113  
*Progress* (spacecraft) 113, 262  
 progressive burning 113  
 Project Blue Book 170

Project Cyclops 113  
 Project Daedalus 113, 262  
 Project Ozma 113, 175  
 Project SCORE 245  
 prominence 37, 114, 214, 235  
 propellants 114  
     burnout of 28  
     case for 31  
     combustion chamber for 39  
     cryogenic 27–28, 50, 62, 62, 114  
     cutoff of 46  
     double-base 53  
     injector for 80  
     liquid 88. *See also* liquid propellant  
     solid 121, 170  
     storable 135  
 proper motion 18, 23, 114  
 propulsion  
     electric 57, 121  
     nuclear-electric 102, 241  
     solar-electric 126, 126  
 propulsion systems 114  
     captive firing of 30  
     cold-flow test of 38  
     delta-V of 49  
     hot-fire test of 76  
     orbital transfer vehicle 79, 105  
 protium 77, 114  
 protogalaxy 114  
 proton 36, 114  
 Proton (launch vehicle) 114, 114, 290  
 proton-proton reaction 114, 157  
 proton storm 114  
 protoplanet 114  
 protostar 114  
 Proxima Centauri (star) 8, 115, 190  
 Ptolemaic system 43, 115, 171, 180, 208–209  
 Ptolemy 8, 10, 153–154, 177, 208–209, 227  
 pulsar 46, 101, 115, 156–157, 183, 188, 190, 218  
 purge 115  
 Pythagoras 209  
**Q**  
 QSO. *See* quasar  
 quantum 110, 115, 207  
 quantum mechanics 34–35, 74, 115, 173, 185  
 quantum theory 109, 115, 207  
 Quaoar (object in Kuiper belt) 115  
 quasar 115, 163, 213, 251  
 quasi-stellar object (QSO). *See* quasar  
 quasar  
     quiet Sun 115  
**R**  
 radar astronomy 116  
*Radarsat* (satellite) 116  
 radial burning 116  
 radian 116  
 radiant flux 58  
 radiation 116. *See also* specific types  
     radiation belt 116  
     radiation belts, Earth's trapped 55, 61, 130, 220, 245  
     radiation budget, Earth's 55  
     radiation environment, space 90, 130, 295  
     radiation sickness 5, 116  
     radiation syndrome, acute 5  
     radioactive decay 24–25, 48  
     radioactive half-life 73  
     radioactive hydrogen 77  
     radio astronomy 80, 83, 100, 116, 190, 212, 239  
     radio frequency (RF) 51, 104, 116  
         modification of 98  
         water hole of 113, 144  
     radio galaxy 117  
     radio interferometer 80  
     radioisotope 65, 117  
     radioisotope thermoelectric generator (RTG) 117, 248  
     radio telescope 11, 117, 117, 138, 198, 209, 239  
     radio waves 57, 113, 117, 175, 187, 188, 190, 202, 205, 209, 246, 247  
     Ramon, Ilan 39, 273  
     Ranger Project 117, 117, 207  
     *Ranger 7, 8, and 9* (spacecraft) 251  
     rays, lunar 117  
     reaction engine 117, 121  
     Reagan, Ronald 264, 265  
     Reber, Grote 209, 239  
     reconnaissance satellites 100, 117, 177, 247, 262  
     red dwarf 23, 113, 117–118, 156

- red giant 118  
 Red Planet 118. *See also* Mars  
 redshift 52, 52, 76–77, 115,  
 118, 164, 174, 204, 213,  
 215–216, 238  
 Redstone (missile) 84, 118,  
 215, 247, 248, 248, 249  
 red supergiant 136  
 reentry 118, 170  
 reentry vehicles (RV) 22, 118  
 Rees, Sir Martin John 209  
 reflecting telescope 31, 34, 84,  
 102, 107, 118, 138, 152, 165,  
 184, 211, 224  
 reflection 118–119  
 angle of 10  
 from surface (albedo) 8,  
 28, 111, 172  
 refracting telescope 68, 119,  
 138, 167, 168  
 refraction 119  
 regenerative life support system  
 (RLSS) 119  
 regolith 119  
 regressive burning 119  
 Regulus 27  
 Reinmuth, Karl 13, 209  
 Reiter, Thomas 276  
 relativity 34–35, 41, 69, 71,  
 119, 131, 132, 164, 173, 176,  
 185, 193, 197, 202, 214, 218,  
 237  
 remote manipulator system  
 (RMS) 24, 92, 119, 119  
 remote sensing 120  
 active 4  
 ground truth in 72  
 multispectral 86, 99  
 rendezvous 13, 15, 43, 58, 120,  
 215, 253, 254, 260  
 Resnik, Judith A. 34, 209  
 resolution 120  
 resources, space 130–131  
 retrograde motion 120  
 retrograde rocket. *See*  
 retrorocket  
 retrorocket 42, 64, 112, 120  
 reusable launch vehicles (RLV)  
 86, 120  
 revolution 120  
 RF. *See* radio frequency  
 RGO. *See* Royal Greenwich  
 Observatory  
 Rhea (moon) 165  
 Richer, Jean 165, 210  
 Ride, Sally K. 210, 264  
 rift valley 120  
 Rigel (star) 27, 136  
 right ascension 120, 284  
 rille 120, 190, 224  
 ring, planetary 120–121, 121  
 ringed world 121  
 RLSS. *See* regenerative life  
 support system  
 RLV. *See* reusable launch  
 vehicles  
 RMS. *See* remote manipulator  
 system  
*Roads to Space Travel* (Oberth)  
 204, 239  
 robot spacecraft 17, 47, 68, 81,  
 89, 101, 109, 113, 121, 221  
 Roche, Edouard Albert 121, 210  
 Roche limit 121, 210  
 rocket(s) 121. *See also* launch  
 vehicle(s); specific rockets  
 bipropellant 26  
 booster 28, 49, 108, 128,  
 128, 131  
 burnout of 28  
 case of 31  
 chemical 36, 121  
 control 42  
 escape 60, 60  
 first use in warfare 228,  
 228  
 meteorological 96  
 multistage 92, 99, 141,  
 219, 242  
 nuclear 103, 121, 241  
 nuclear thermal 103, 103  
 posigrade 112  
 retrograde 42, 64, 112, 120  
 solid-propellant 128  
 sounding 96, 128, 179–  
 180, 211, 220  
 staging of 134  
*Rocket into Interplanetary  
 Space, The* (Oberth) 204, 237  
 rocket scientist 244  
 Roemer, Olaus Christensen 210  
 Roentgen, Wilhelm Conrad 211  
 rogue star 121, 205  
 Rokot (launch vehicle) 290  
 roll 21, 23, 49, 121  
 Römer, Ole. *See* Roemer, Olaus  
 Christensen  
 Roosa, Stuart Allen 211, 257  
 Roosevelt, Franklin D. 176  
 Rosse, third earl of 211  
 Rossi, Bruno Benedetto 211  
*Rossi X-ray Timing Explorer  
 (RXTE)* 211  
 rotation 121  
 Earth's 121, 172, 179, 186,  
 235  
 Sun's 164  
 synchronous 137  
 rover  
 lunar 90, 90, 214, 258, 259  
 Mars 93, 94, 273, 273,  
 278  
 Rover Program 121  
 Royal Greenwich Observatory  
 (RGO) 18, 121–122, 150, 158,  
 162, 163, 167, 178–179, 208  
 RP-1 (rocket engine) 122  
 RTG. *See* radioisotope  
 thermoelectric generator  
 runaway greenhouse 56, 122, 212  
 Russell, Henry Norris 75, 211  
 Russia. *See also* specific  
 cosmonauts, missions, and  
 spacecraft  
 cold war with 38, 193, 194,  
 243, 244, 246  
 cosmic term in 44  
 cosmonauts of 44, 45  
 ISS modules of 147, 148  
 launch sites of 22, 84, 111,  
 142, 148, 241  
 launch vehicles of 114,  
 114, 128, 128, 142, 147,  
 193, 242, 290  
 Moon mission of 89, 90,  
 245, 253, 256–257  
 rocket development in  
 241–242  
 space stations of 2, 8, 52,  
 98, 113, 122, 162, 169,  
 199, 257–258, 261–262,  
 265, 268–269, 269, 270,  
 272, 296  
 RV. *See* reentry vehicles  
 RXTE. *See* Rossi X-ray Timing  
 Explorer  
 Ryle, Sir Martin 157, 188, 212
- S**  
 Sagan, Carl Edward 212  
 Salyut (space station) 8, 122,  
 257–258, 261–262, 296  
 Sänger, Eugen 212  
 SAR. *See* synthetic aperture radar  
 satellite(s) 122. *See also*  
 specific satellites  
 active 5  
 apogee of 12, 12  
 artificial 17, 194, 219, 244  
 capital 30  
 communications 37, 39–40,  
 51, 98, 168, 205, 241, 247,  
 249, 250, 251, 252, 260  
 constellation of 42, 100  
 destruction of, spacecraft  
 for 12, 12  
 direct broadcast 51  
 early-warning 54  
 Earth 55  
 environmental. *See* Earth-  
 observing spacecraft  
 equatorial 59  
 ferret 65  
 first American (*Explorer  
 1*) 61, 84, 207, 220,  
 244–245, 245  
 first Soviet (*Sputnik 1*) 17,  
 133–134, 134, 194, 198,  
 219, 244  
 fixed 65  
 Galilean 29, 68, 68, 81,  
 81, 180  
 geostationary orbit of 69  
 geosynchronous orbit of  
 69–70, 250, 252  
 green 72  
 Keplerian elements for 85  
 meteorological 48, 48, 100,  
 145, 145, 246, 261, 262  
 military 48–49, 54, 98,  
 117, 137, 137, 246  
 missile surveillance 48–49  
 Molniya orbit of 98  
 natural. *See* Moon; moon(s)  
 navigation 100, 246, 248,  
 268  
 reconnaissance 100, 117,  
 177, 247, 262  
 Roche limit and 121, 210  
 spy 134, 247  
 surveillance 137, 137, 246  
 synchronous 137, 250  
 satellite power system (SPS)  
 122, 122, 131  
 Saturn (launch vehicle) 122,  
 162, 255, 259, 289  
 Saturn (planet) 122, 127, 307  
 auroras of 21  
 Cassini-Huygens mission to  
 31–32, 32, 33, 77, 273,  
 274, 275  
 as giant planet 70  
 as major planet 92, 110  
 moons of 31, 77, 139, 139,  
 159, 165, 190, 195, 196,  
 207, 231, 231, 274, 275  
 as outer planet 106

- Pioneer* spacecraft to 109–110, 259  
rings of 121, 121, 172, 190, 200, 231  
Voyager mission to 143–144, 261
- Saturnian 122  
Savitskaya, Svetlana 265  
scarp 122  
scattering 122  
Scheiner, Christoph 178, 212  
Schiaparelli, Giovanni Virginio 29, 152, 199, 212–213, 213  
Schirra, Walter M. 213, 253, 254–255  
Schmidt, Maarten 213, 251  
Schmitt, Harrison H. 178, 213, 259  
Schriever, Bernard 19, 213, 221, 243  
Schwabe, Samuel Heinrich 72, 213–214, 223  
Schwarzschild, Karl 214  
Schwarzschild black hole 85, 122, 214  
Schwarzschild radius 26–27, 60, 122, 214  
science payload 123  
scientific airlock 123  
Scobee, Francis R. 34, 214  
SCORE, Project 245  
Scott, David R. 214, 223–224, 253, 258  
Scout (launch vehicle) 123, 289  
screaming 123  
scrub 123  
search for extraterrestrial intelligence (SETI) 53, 113, 123, 123, 144, 175, 245  
Secchi, Pietro Angelo 179, 214  
secondary crater 123  
Sedna (trans-Neptunian object) 123  
self-replicating system (SRS) 123  
semimajor axis 18, 123  
sensible atmosphere 118, 123  
sensor 124  
SEP. *See* solar-electric propulsion  
SETI. *See* search for extraterrestrial intelligence  
settlement, space 24, 131, 157, 238–239  
Seyfert, Carl 124  
Seyfert, Carl Keenan 124, 214  
Seyfert galaxy 124, 214  
Shapley, Harlow 196–197, 215  
Shavit (rocket) 266, 290  
Shelton, Ian 265  
*Shenzhou 5* (spacecraft) 124, 198  
*Shenzhou 6* (spacecraft) 124, 274  
Shepard, Alan B., Jr. 202, 211, 215, 215, 248, 248, 257  
Shepard, L. R. 241  
shepherd moon 124  
shield volcano 104, 124  
shirtsleeve environment 73, 124  
Shoemaker-Levy 9 Comet 268  
short-period comet 124, 158  
Shukor, Sheikh Muszaphar 277  
shuttles. *See* space shuttles  
sidereal 124  
sidereal month 124  
sidereal period 125  
sidereal year 125  
sight, line of 88  
singularity 25, 27, 125, 214  
Sinope (moon) 204  
Sirius (star) 167–168  
Sirius B (star) 167–168  
*SIRTF*. *See* *Space Infrared Telescope Facility*  
SI units 125, 280, 282  
*Skylab* (space station) 125, 156, 170, 181, 259–260, 262, 263, 295  
SL. *See* *Spacelab*  
Slayton, Deke, Jr. 215, 260  
Slipher, Earl Carl 215  
Slipher, Vesto Melvin 215–216  
sloshing 125  
SLV. *See* space launch vehicles  
Small Magellanic Cloud (SMC) 91, 125  
SMC. *See* Small Magellanic Cloud  
Smith, Michael J. 34, 216  
soft landing 93, 125, 129  
*Sojourner* (robot) 94  
Sol 125. *See also* Sun  
sol (Martian day) 125  
solar 125  
solar activity 125, 174, 223  
solar apex 12  
solar cell 51, 125, 127  
solar constant 126  
solar cosmic rays 45  
solar cycle 126  
solar eclipse 22, 56, 156, 214  
solar-electric propulsion (SEP) 126, 126  
solar energy 51, 125, 126, 127  
solar flare 45, 66, 126, 127, 164  
solar mass 126  
solar nebula 126  
solar panel 127  
solar particle event (SPE) 127, 130  
solar photovoltaic conversion 127  
solar radiation 55, 127, 192, 196  
solar storm 127  
solar system 127, 127  
solar time, mean 72, 95  
solar wind 75, 116, 128, 138, 158  
solid Earth 56, 128  
solid propellant 121, 170  
solid-propellant rocket 128  
solid-rocket booster (SRB) 128, 128, 131  
Solov'yev, Anatoly 269  
solstice 128, 177  
sounding rocket 96, 128, 179–180, 211, 220  
Soviet Union. *See* Russia  
Soyuz launch vehicle 128, 128, 142  
Soyuz spacecraft 52, 128–129, 129, 254, 257–258, 265, 268–269, 290  
    *Soyuz 1* 128, 194  
    *Soyuz 11* 128  
    *Soyuz 19* 13, 128–129  
    *Soyuz TMA-1* 129  
space 129  
space adaptation syndrome 6, 249  
space base 129  
space-based astronomy 129, 216  
space capsule 95, 129, 170, 182, 247–248, 249  
spacecraft 129. *See also* specific crafts and types  
    antisatellite 12, 12  
    chaser 36, 43, 52, 253  
    continuously crewed 42  
    crew-tended 46  
    Earth-observing 15, 21, 55, 86, 96, 116, 133, 138, 145, 196, 259, 267, 272  
    free-flying 67  
    lander 86  
    mother 99  
    target 52  
spacecraft clock 129  
space debris 40, 47, 125, 130, 130, 262, 263, 272  
Space Infrared Telescope Facility (SIRTF) 133  
*Spacelab* (SL) 129, 224  
space launch vehicles (SLV) 130  
space lift vehicles. *See* launch vehicle(s)  
spaceman 130  
space medicine 130  
space physics 130  
space platform 130  
spaceport 130  
space radiation environment 90, 130, 295  
space resources 130–131  
space settlement 24, 131, 157, 238–239  
spaceship 131  
space shuttles 6, 7, 131, 131, 258, 288. *See also* specific shuttles  
    aerodynamic heating and 6  
    cargo bay of 31  
    external tank of 62, 62, 131  
    first operational flight of 264  
    Glenn (John Herschel, Jr.) on 270–271  
    launch site of 84, 84, 130  
    as launch vehicle 289, 291  
    maiden flight of 263  
    main engines of 131  
    missions of 288  
    Orbiter of 7, 105  
    reentry of 118  
    remote manipulator system of 24, 92, 119, 119  
    Sänger (Eugen) and 212  
    *Spacelab* and 129, 224  
space sickness 6, 131, 218, 249  
space stations 131. *See also* specific stations  
    Braun's (Wernher von) concept of 243  
    first fictional account of 236  
    permanently crewed capability of 108  
    Reagan (Ronald) and 264  
    Russian 8, 52, 98, 113, 122, 162, 169, 199, 257–258, 261–262, 265, 268–269, 269, 270, 272, 296  
spacesuit 52, 63, 63, 131, 131, 252  
space-time 69, 71, 81, 119, 131

## INDEX

space transportation system (STS) 131, 224. *See also* space shuttles  
 space vehicles 131  
 space walk 131, 142–143, 197, 217, 222, 252, 252, 265  
 space workhorse vehicles 49  
 SPE. *See* solar particle event  
 special relativity 119, 131, 132, 202  
 specific impulse 132  
 spectral classification 27, 132, 164, 179, 282  
 spectral color 38  
 spectral line 23, 132, 135, 160–161, 164, 179, 185, 190–191, 193, 207  
 spectrogram 132  
 spectroheliograph 185  
 spectrometer 132, 179, 234  
 spectroscopy 132, 153, 167, 189, 193, 202, 214  
 spectrum 51, 132, 132, 163  
 speed of light 119, 132, 179, 187, 201, 210  
 spin stabilization 132  
 spiral galaxy(ies) 76, 112, 124, 133, 133, 172, 211, 214  
   barred 23, 23  
   Great (Andromeda) 10  
*Spirit* (Mars rover) 93, 94, 273, 278  
 Spitzer, Lyman, Jr. 133, 216, 216  
*Spitzer Space Telescope* (SST)  
   71, 83, 133, 216, 273  
 SPOT (spacecraft) 133  
 SPS. *See* satellite power system  
*Sputnik 1* (satellite) 17, 133–134, 134, 194, 198, 219, 244  
*Sputnik 2* (satellite) 244, 244  
*Sputnik 5* (satellite) 247  
 spy satellites 134, 247  
 SRS. *See* self-replicating system  
 SST. *See* *Spitzer Space Telescope*  
 stabilization, spin 132  
 Stafford, Thomas P. 216, 253, 255, 260  
 staging 134  
 star(s) 134  
   black dwarf 26, 54, 134  
   blue giant 27  
   brown dwarf 28, 54, 134  
   classification of  
     Harvard system of 74, 99, 164, 179, 206–207, 214

  Hertzsprung–Russell 27, 70, 75  
   luminosity 70, 75, 89, 99, 135, 314  
   Morgan–Keenan (MK) system of 99, 192, 203  
   spectral 27, 132, 164, 179, 282  
   core of 44  
   corona of 44  
   death of (black hole) 26–27  
   degenerate 49, 102  
   dwarf 54  
   evolution of 40, 135, 179, 187, 191, 211, 214, 217, 220, 222  
   evolved 61, 102  
   fixed 65, 125, 188  
   giant 70, 99, 134, 135, 315  
   main-sequence 44, 54, 92, 99, 117, 135, 315  
   neutron 35, 40, 101, 115, 134, 183, 190, 196, 218, 224, 239  
   Population I 112, 155–156  
   Population II 112, 155–156  
   red dwarf 23, 113, 117–118, 156  
   red giant 118  
   rogue 121, 205  
   sunlike 136, 217  
   supergiant 27, 99, 135, 136, 315  
   variable 34, 134, 141, 154, 155, 178, 183, 189, 196–197, 205, 215, 237  
   white dwarf 26, 35, 40, 54, 134, 146, 166, 167, 168, 200, 315  
 star cluster 134, 134  
 Stardust mission 134, 274  
 starlight  
   aberration of 2, 161, 231  
   Sun's gravity and 176, 237, 237  
 star probe 134–135  
 starship 135, 135  
 “Star Spangled Banner” 234  
 station keeping 15, 135  
 stations, space. *See* space stations  
 steady state 135  
 steady-state universe 135, 159–160, 183, 188–189, 191  
 Stefan, Josef 135, 159, 216  
 Stefan-Boltzmann law 116, 135, 159, 216  
 stellar evolution 40, 135, 179, 187, 191, 211, 214, 217, 220, 222  
 stellar luminosity class 70, 75, 89, 99, 135, 314  
 steradian 135  
 Stonehenge 135, 226  
 storable propellant 135  
 storm  
   geomagnetic 44, 69  
   proton 114  
   solar 127  
 Strelka (dog in space) 247  
 Struve, Friedrich Georg Wilhelm 216–217  
 Struve, Hermann 217  
 Struve, Ludwig 217  
 Struve, Otto 217  
 Struve, Otto Wilhelm 216, 217  
 STS. *See* space transportation system  
 Sufi, Abd al-Rahman, Al-. *See* Al-Sufi, Abd al-Rahman  
 Sullivan, Kathryn D. 217, 265  
 Sun 136, 136, 313  
   active 5  
   in Copernican system 43  
   corona of 44, 200  
   gravity of, and starlight 176, 237, 237  
   quiet 115  
   rotation of 164  
   spectral classification of 132, 136  
   star probe to 134–135  
   stellar classification of 99  
   sunlike star 136, 217  
 sunspot 126, 136, 151, 164, 174, 178, 198, 212, 213, 223  
 sunspot cycle 136  
 sun-synchronous orbit 136  
 supergiant star 27, 99, 135, 136, 315  
 superior conjunction 41  
 superior planets 41, 136  
 supernova 45, 46, 101, 136–137, 161, 192–193, 199–200, 224, 265  
 surveillance satellites 137, 137, 246  
 Surveyor Project 137, 137, 207, 253  
 Swigert, John Leonard “Jack,” Jr. 184, 217–218, 256  
 synchronous orbit 137, 250  
 synchronous rotation 137  
 synchronous satellites 137

synchrotron radiation 137  
*Syncom 2* (satellite) 250  
 synthetic aperture radar (SAR) 4, 116, 137

## T

taikonaut 124, 137, 198, 274  
 tail (cometary) 39, 137–138, 158, 162  
 Tanegashima Space Center 267  
 target, cooperative 43  
 target spacecraft 52  
 Taurus (constellation) 42  
 Taurus (launch vehicle) 291  
 Taylor, Joseph H., Jr. 190, 218  
 telecommunications 40, 116, 138, 247, 249, 252. *See also* communications satellite(s)  
 telemetry 11, 26, 51, 53, 138  
 teleoperation 138  
 telepresence 94, 138, 138  
 telescope(s) 138  
   adaptive 5  
   altazimuth mounting of 9, 9  
   Arecibo Observatory 15, 15  
   Cassegrain 31, 165  
   Cerro Tololo Inter-American Observatory 34  
   charge-coupled device of 36  
   Earth-based 54  
   eyepiece of 64  
   *Fermi Gamma-ray Space* 64, 278  
   Galilean 68, 180  
   Gregorian 184  
   *Hubble Space* 24, 36, 71, 77, 77, 83, 104, 217, 267, 268, 270, 272, 275, 278  
   *James Webb Space* 83, 221  
   Kepler Mission 85  
   Newtonian 102, 118, 203  
   photoheliograph 109  
   radio 11, 117, 117, 138, 198, 209, 239  
   reflecting 31, 84, 102, 107, 118, 138, 152, 165, 184, 211, 224  
   refracting 68, 119, 138, 167, 168  
   *Spitzer Space* 71, 83, 133, 216, 273  
 teloperation 94, 257

## INDEX

## space transportation system–teloperation

- Telstar 1* (satellite) 249  
 Tempel (comet) 48, 174, 235, 274  
 temperature  
   absolute 2, 28, 116, 159, 192  
   critical 46  
 temperature scale, Celsius 33, 166, 232  
 Tereshkova, Valentina 218, 250  
 terminator 138  
*Terra* (spacecraft) 138, 272  
 terrestrial 138  
 terrestrial biosphere 131  
 terrestrial planets 80, 138  
 Tethys (moon) 165  
 Thagard, Norman 269  
 thermonuclear. *See* fusion  
 Thomson, William. *See* Kelvin, William Thomson, Lord  
 Thor (missile) 139, 213, 243  
 throttling 139  
 thrust 139  
 tidal force 139  
 time  
   Greenwich mean 72, 148  
   ground-elapsed 72  
   light 87  
   mean solar 72, 95  
   space and 69, 71, 81, 119, 131  
   zulu 72, 148  
 TIROS (satellite) 246  
 Titan (launch vehicle) 139, 139, 213, 243, 252, 253, 289, 291  
 Titan (moon) 31, 77, 139, 139, 190, 195, 231, 231, 274  
 Titius, Johann Daniel 159, 218, 232  
 Titov, Gherman S. 218, 249  
 Titus-Bode law 218  
 TNO. *See* trans-Neptunian object  
 Tokarev, Valery 274  
 Tombaugh, Clyde William 111, 199, 218–219, 239  
 tower, escape 60  
 tracking 139  
 trajectory 139  
   ballistic 23  
 transfer orbit 139  
 transit 139  
*Transit 1B* (satellite) 246  
*Transit 4A* (satellite) 248  
 trans-Neptunian object (TNO) 59, 115, 123, 139, 199, 218–219  
 trapped radiation belts, Earth's 55, 61, 130, 220, 245  
 Trident ballistic missile 22  
 tritium 77, 139  
 Triton (moon) 139, 140, 196  
 Trojan group (asteroids) 4, 140, 223  
 Tsiolkovsky, Konstantin Eduardovich 16, 121, 182, 204, 219, 219, 235, 236, 237, 239  
 Tsyklon (launch vehicle) 290  
 Tunguska event 140  
 turbopump system 32, 140  
 Tyuratam Launch Site 22  
 Tyurin, Mikhail 276
- U**  
 UFOs. *See* unidentified flying objects  
*Uhuru X-Ray Satellite* 181  
 ullage 140  
*Ultimate Migration, The* (Goddard) 236–237  
 ultraviolet astronomy 44, 105, 140  
 ultraviolet radiation (UV) 57, 64, 138, 140  
 Ulugh, Beg (Muhammed Targai) 219–220, 228  
 umbilical 140  
 umbra 136  
 Umbriel (moon) 196, 235  
 unidentified flying objects (UFOs) 169–170  
 Unity (space station component) 140  
 universal time coordinated (UTC) 140  
 universe 140, 140  
   big bang of 25, 45, 151, 159–160, 173, 180–181, 183, 185, 189, 197, 223, 238  
   closed 25, 37–38, 45  
   cosmological principle of 45  
   Earth v. Sun as center of 43  
   expanding 45, 47, 49–50, 61, 104, 173, 176, 197, 238  
   flat 45  
   heat death of 74, 168  
   island 82, 172, 189, 191, 232, 237  
   microwave radiation from  
     origin of 44  
   observable 104  
   open 45, 104  
   oscillating 106  
   steady-state 135, 159–160, 183, 188–189, 191  
 uplink 11, 140  
 upper stage 141, 176  
 Uranus 127, 141, 308  
   auroras of 21  
   discovery of 187, 232–233  
   as giant planet 70  
   as major planet 92, 110  
   moons of 124, 195, 196, 235  
   as outer planet 106  
   rings of 121, 124  
   Voyager mission to 143–144, 261, 265  
 Urey, Harold Clayton 202, 220  
 Urey-Miller experiment 202, 220, 220  
 U.S. Naval Observatory (USNO) 141, 167, 185, 203, 236  
 U.S. Strategic Command 273  
 USNO. *See* U.S. Naval Observatory  
 UTC. *See* universal time coordinated  
 Utopia Panitia (Plains of Utopia) 141  
 UV. *See* ultraviolet radiation
- V**  
 VAFB. *See* Vandenberg Air Force Base  
 Valles Marineris 141  
 Van Allen, James Alfred 55, 61, 220, 245, 245  
 Van Allen radiation belts 55, 61, 130, 220, 245  
 Vandenberg Air Force Base (VAFB) 15, 21, 138, 141, 141, 247  
*Vanguard* accident 2, 244  
 variable star 34, 134, 141, 154, 155, 178, 183, 189, 196–197, 205, 215, 237  
 vector 141  
 velocity 141  
   angular 10, 11  
   control rocket and 42  
   delta-V of 49, 49  
   escape 13, 27, 60, 314  
 Venera (spacecraft) 141, 141, 256, 260, 263–264  
 vengeance weapon 2 (V-2 rocket) 84, 141–142, 161, 240, 241, 241, 242  
 Venus 127, 142, 142, 309  
   Aphrodite Terra of 12  
   as evening star 60  
   greenhouse effect on 212  
   as inferior planet 79  
   as inner planet 80  
   Ishtar Terra of 82  
   Magellan mission to 91, 91, 266  
   as major planet 92, 110  
   Mariner mission to 93, 207, 249, 260  
   Maxwell Montes of 95  
   orbit of 186  
   Pioneer mission to 110, 262  
   as terrestrial planet 138  
   transit of 165, 166, 188, 200  
   Venera mission to 141, 141, 256, 260, 263–264  
 Venus Express Mission 142  
 Venesian 142  
 vernal equinox 59, 72, 120, 142, 284  
 Verne, Jules 220, 220, 235, 235  
 vernier engine 42, 142  
 Very Large Array (VLA) 142  
 Vesta (asteroid) 47, 142, 204, 233, 277  
 Victoria Crater (Mars) 278  
 Viking Project 37, 141, 142, 143, 207, 260–261  
 Vinogradov, Pavel 275  
 visible radiation. *See* light  
 visual light 38  
 VLA. *See* Very Large Array  
 Vogel, Hermann Carl 220  
 volcano 56, 104, 124, 142  
 Volkov, Vladislav 128, 258  
 Von Kármán, Theodore 221  
 Von Neumann, John 221, 243  
 Voskhod (spacecraft) 142–143, 197, 251–252  
*Vostok* (spacecraft) 143, 180, 218, 247, 248, 249, 250  
 Voyager spacecraft 143–144, 144, 207, 261, 265, 266, 267  
 Vulcan (hypothetical planet) 144, 197, 213



## W

- walk, space 131, 142–143, 197, 217, 222, 252, 252, 265
- Wan-Hu (Wan-Hoo) 228
- warhead 28, 144, 240
- War of the Worlds* (Wells) 236
- water hole 113, 144
- watt 144
- wavelength 145  
and color 38  
of electromagnetic radiation 10, 153
- wave number 145
- weather satellites 48, 48, 96, 100, 145, 145, 246, 261, 262
- Webb, James E. 83
- Webb, James Edwin 83, 221, 221
- Wefa, Abu'l, Al-. *See* Al-Wefa, Abu'l
- weight 145  
atomic 20
- weightlessness 97, 97, 145–146, 148
- Weitz, Paul J. 260
- Weizsäcker, Carl Friedrich Baron 30, 221–222
- Wells, H.G. 236
- wet emplacement 146
- “Where are they?” (Fermi paradox) 65, 178
- Whipple, Fred Lawrence 222
- White, Edward H., II 13, 166, 222, 252, 252, 254
- white dwarf 26, 35, 40, 54, 134, 146, 166, 167, 168, 200, 315
- Whitson, Peggy 277
- Wildt, Rupert 222
- Wild 2 (comet) 134, 274
- Wilkinson Microwave Anisotropy Probe* (WMAP) 146
- Williams, Jeff 275
- Williams, Sunita L. 222–223, 276
- Wilson, Robert Woodrow 25, 173, 205–206, 223, 251
- WIMP (hypothetical particle) 146
- wind, solar 75, 116, 128, 138, 158
- W.M. Keck Observatory. *See* Keck Observatory
- WMAP. *See* *Wilkinson Microwave Anisotropy Probe*
- Wolf, Johann Rudolph 223
- Wolf, Maximilian “Max” Franz Joseph Cornelius 4, 223
- Woolley, Sir Richard van der Riet 223
- Worden, Alfred Merrill 223–224, 258
- work 146
- workhorse vehicles, space 49
- World, the Flesh and the Devil, The* (Bernal) 157, 238–239
- World War II 239–240
- Yegorov, Boris 251
- Yerkes Observatory 99, 147, 185, 203
- Yohkoh* (satellite) 147
- Young, John W. 175, 200, 224, 252, 255, 258–259, 263
- young stellar object (YSO) 147
- Yurchikhin, Fyodor N. 276

## Z

- Zarya (module) 140, 147, 271
- zenith 99, 147
- Zenit/Zenith (launch vehicle) 147
- zero, absolute 2
- zero-g 148
- zodiac 10, 18, 148, 226, 283
- zodiacal light 148
- Zond (spacecraft) 148
- “zoo hypothesis” 85, 148
- Z-time. *See* zulu time
- Zucchi, Niccolo 224
- zulu time (Z-time) 72, 148
- Zvezda (module) 148
- Zwicky, Fritz 224