

Did Anybody Really Land On The Moon?

Eric Hufschmid, last edited 6 May 2004

<http://www.EricHufschmid.net>

Computer technology was very primitive in the 1960's

Transistors were just beginning to replace **vacuum tubes**, and **slide rules** were used for calculations.

Computers and software in the 1960's were so crummy that the rocket scientists would have been better off with a modern **pocket calculator**.



Manufacturing technology was also very primitive

For example, milling machines were operated by hand, which meant that cutting curved shapes in metal was extremely difficult.

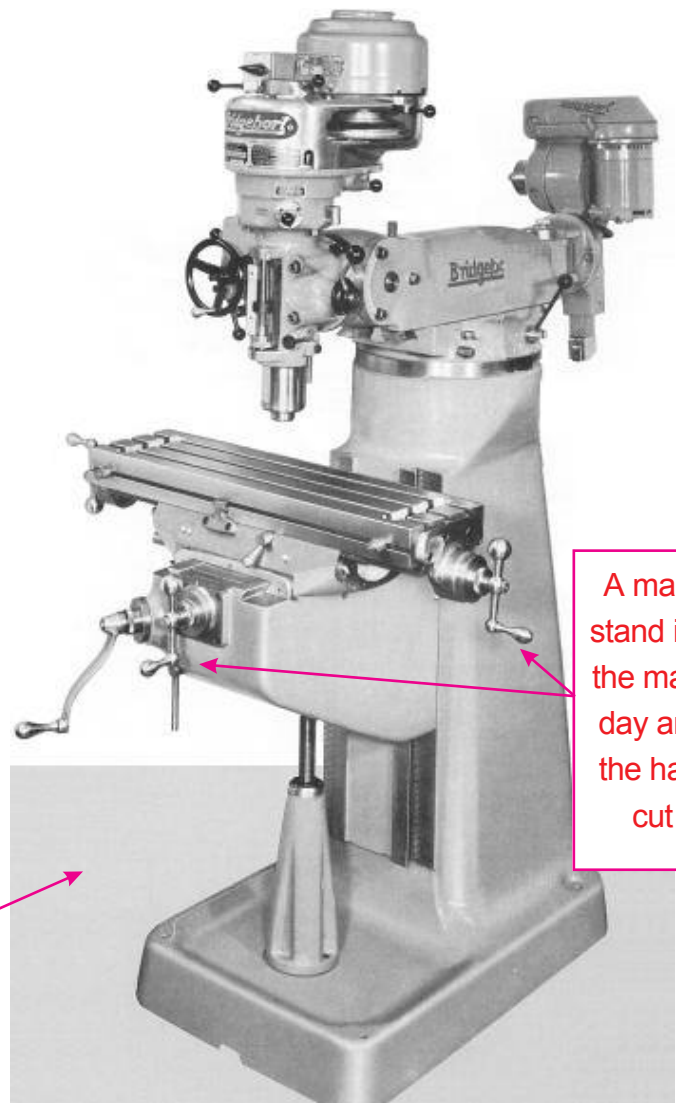

This "*Bridgeport*" brand of milling machine was **advanced technology** in the 1960's

A man had to stand in front of the machine all day and crank the handles to cut parts.

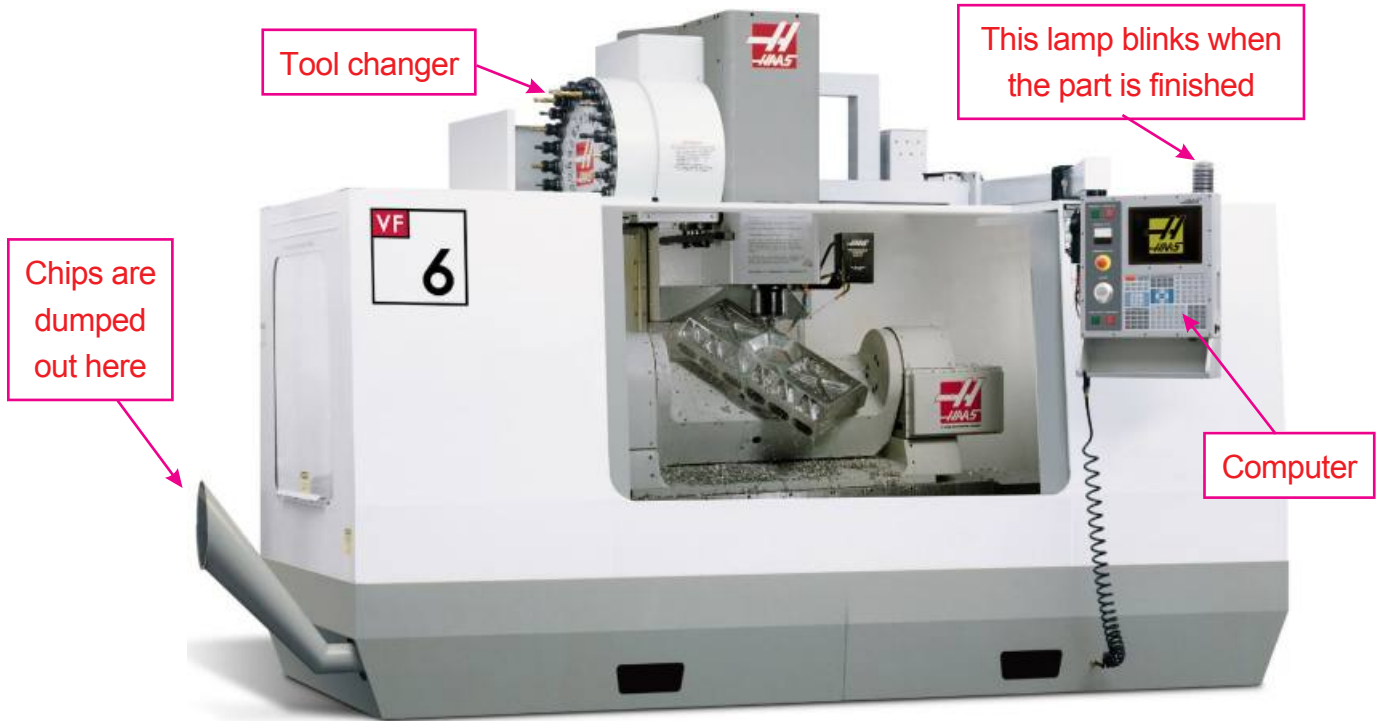

Today a person loads a block of metal, pushes the **Start** button, and lets the computer cut the part. The computer cuts the part much faster, and with incredible precision, even curved shapes.

How did Americans in 1969 do what nobody can do today?

When something happens that has never happened before, and which has never happened since, (such as fire causing steel buildings to disintegrate) we should question it.



If Americans could get to the moon with 1960's technology, it would be **easy** for us to get to the moon today. However, all nations have **extreme difficulty** putting an object into a **high Earth orbit**.

Tell me one technical achievement of the past that we of today cannot do faster, better, and for less money.

Email your answer to:

PainfulQuestions@aol.com

Furthermore, if Americans had such incredible engineering talent, why can't we make incredible automobiles, train systems, and other products?

The Lunar Lander had Never Been Tested.

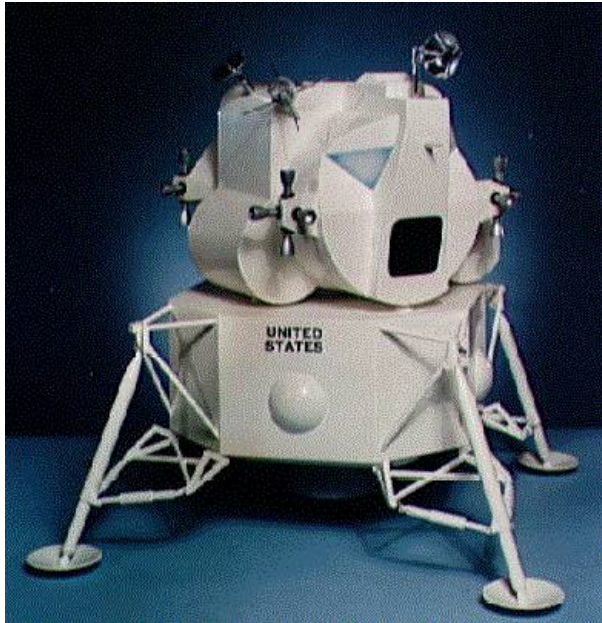

Where are the technical specs for the lunar lander?

For example, the top section blasted off the moon with how much fuel ?

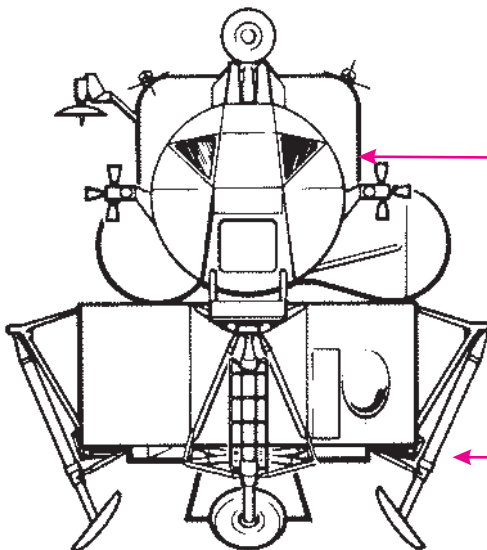
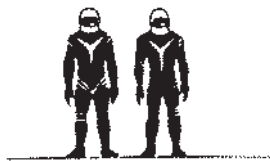

Perhaps it is because I develop software, and I cannot write software that works perfectly, I would want the engineers to **prove the equipment and software works!**

They could start by putting animals into Earth orbit. When they figured that out they could send an unmanned rocket into moon orbit. When they got that working, they could send an unmanned rocket to land on the moon, and then the lunar lander would fly back to the earth.

However, while NASA did practice putting animals and people into Earth orbit, they skipped the testing of the lunar landing and return to Earth!

Considering all the failures and deaths in the space program, how could engineers send people to the moon with rockets that had never been tested? Sure, some astronauts were willing to take the risk, but it would have made Americans look like jerks if the astronauts died on the moon because an **untested Lunar Lander** didn't work correctly.

How did two men live in this tiny module? Why doesn't NASA provide details on how they accomplished the miracle of keeping men alive in an incredibly harsh environment? Did anybody vomit from the zero gravity of space? Did the astronauts wear diapers?

The bottom half was a rocket with...how much fuel?? Is NASA keeping this info a secret? If so, why?

NASA did not need to test the Lunar Rocket



NASA claims that the scientists were 100% confident that the lunar rocket worked, so there was **no need to test it**.

However, NASA was not 100% sure the astronauts could climb the ladder of the lunar lander, so they made the astronauts practice climbing in and out of a simulator.



NASA was not 100% certain that the astronauts could display the flag, either, so NASA made them practice unpacking the flag and shoving it into simulated moon dirt.



Astronaut Gene Cernan practices putting the flag into the dirt. His wife and daughter are watching.

His daughter must be proud that he learned to do this correctly!

Or was Gene Cernan **rehearsing** for a fake moon landing? Would his daughter be proud of **that**?

Apollo 12

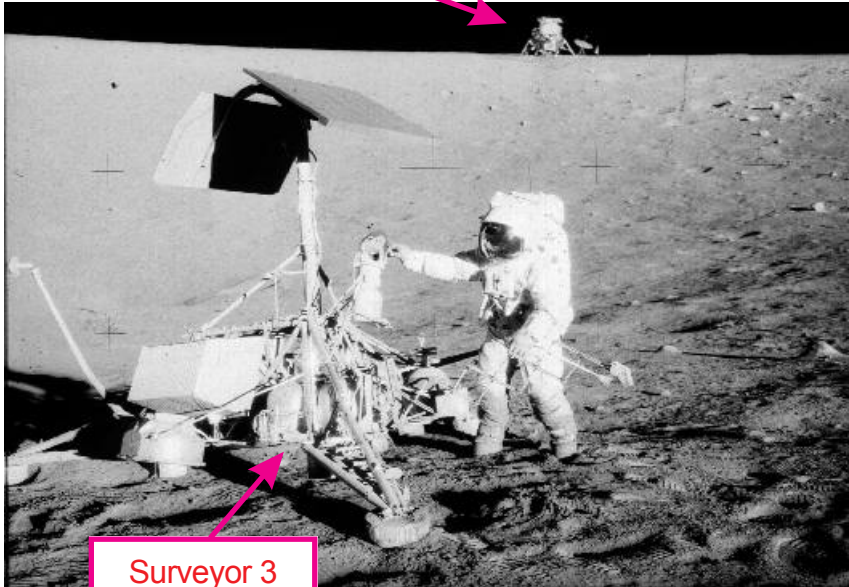

Surveyor 3

Apollo 12...

The **Stupidest** Astronauts?

The astronauts walked over to a Surveyor 3 craft which landed on the moon 2½ years earlier.

They took photos. Then they removed its TV camera and brought it back to the earth.

NASA created a **realistic** training center for the astronauts to practice walking over to Surveyor 3 craft, taking photos of it, and removing its TV camera. The simulated Surveyor craft was even placed on an **inclined plane** to duplicate its position on a slope.



Could any astronaut really be so stupid that he needed to practice this?

And did the simulated Surveyor craft really have to be this **detailed**?

Or was this "training" actually a **rehearsal** for a fake moon walk over to a fake Surveyor craft?

Why the Amazing Realism?



Why did NASA go to the trouble of making some - but not all - of the training areas appear visually **identical** to what we assume the moon looks like?

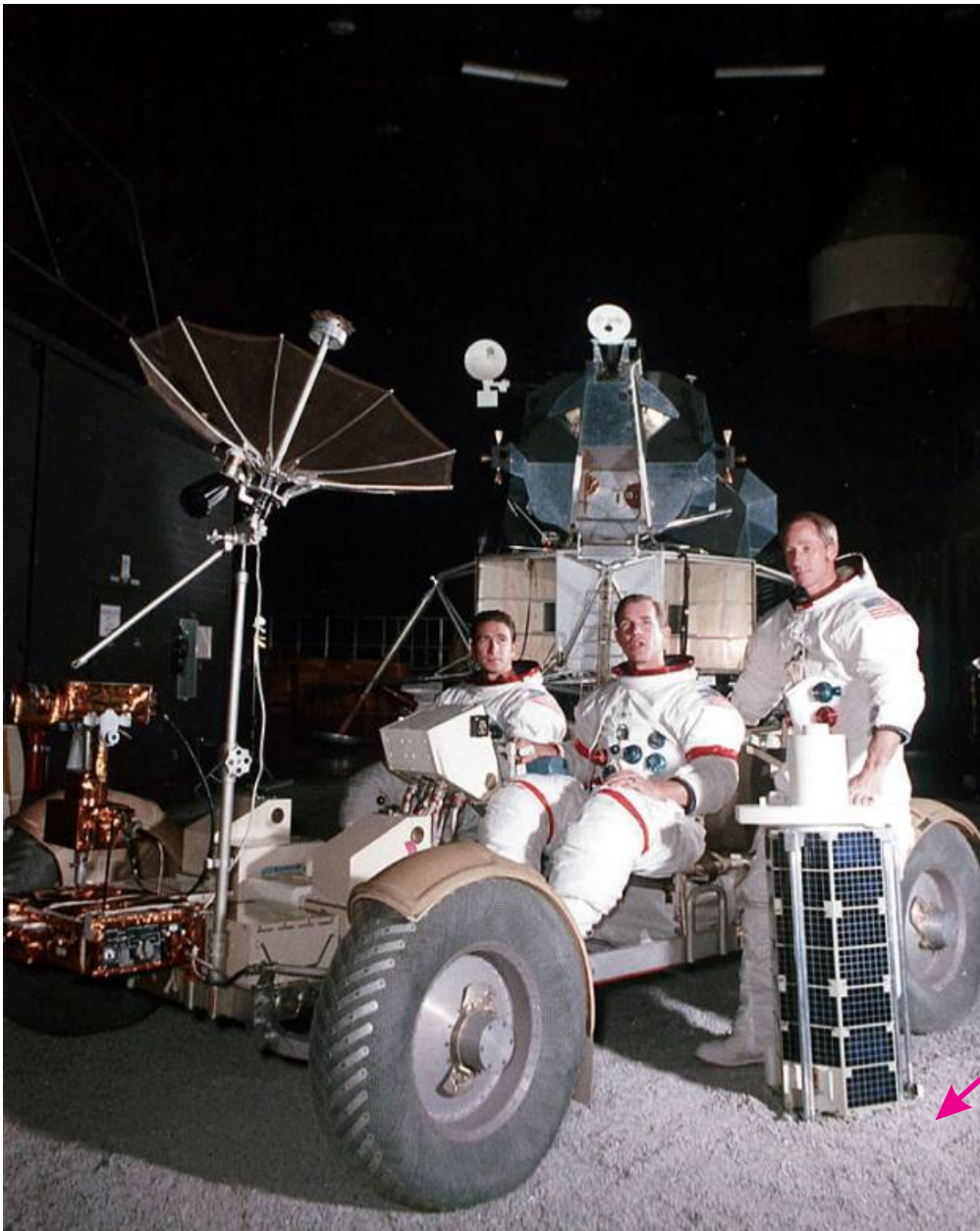

NASA created this moon landscape **inside a building**.

Is it just a coincidence that some of the training centers could be used to create photos for a fake moon landing?

Fake lunar dirt
on the floor.
What was the
purpose for this?

Why in 1963 did Kennedy and the scientists want to cancel the moon race?

Here is an interesting document from NASA on the history of Apollo:

<http://www.hq.nasa.gov/office/pao/History/SP-4204/contents.html>

The above NASA document shows that in 1963 the scientists were questioning the Apollo project. For example:

...Now the very concept of Apollo began to be questioned. When the great debate that Kennedy had asked for two years before finally got under way, scientists began to see that the space program made distorting demands on skilled manpower, economic resources, and human determination. And they began to ask if it was really worth doing. Did we have to beat the Russians? Was this the most important scientific effort we could perform? Was NASA perhaps traveling too fast? The President himself seemed to have his doubts when he began to suggest joint space efforts with the Russians.

And how about this sentence:

In an address to the United Nations General Assembly on 20 September 1963, President Kennedy stated that joint U.S.-USSR efforts in space had merit, including "a joint expedition to the moon."

A few sentences further is this bizarre remark:

Scientists began to talk of other priorities, such as the declining water table in the West and the challenge of oceanography.

After reading the NASA document, answer these questions:

- Why would scientists in 1963 suddenly have more important priorities?
- Why would scientists question the Apollo mission if they were **only 5½ years away from success**?
- Why would Kennedy consider canceling the moon mission in favor of a joint space program with the Russians?

My guess is that the scientists realized that it was **impossible** to get to the moon by 1969. Rather than admit the moon mission was an unrealistic fantasy, I think Kennedy was considering working with the Russians in space exploration. This would:

- Avoid admitting the USA couldn't get to the moon
- Help make Russians and Americans more friendly

However, the 1960's was the era of **commie paranoia**. If Kennedy wanted to cancel Apollo, but if the CIA and military leaders wanted to fake a moon landing in order to intimidate the Russians, we could have another of the many possible reasons that the CIA and military wanted to kill Kennedy.



Dry dust in the Earth's deserts does not leave crisp impressions, so why does lunar dust?

These two photos are from the Apollo astronauts.

Without moisture or organic material, what is holding the particles of dust together?

Also, why does the Apollo moon dirt look different from the moon dirt in the photos that were taken by the Surveyor craft? (see next page)

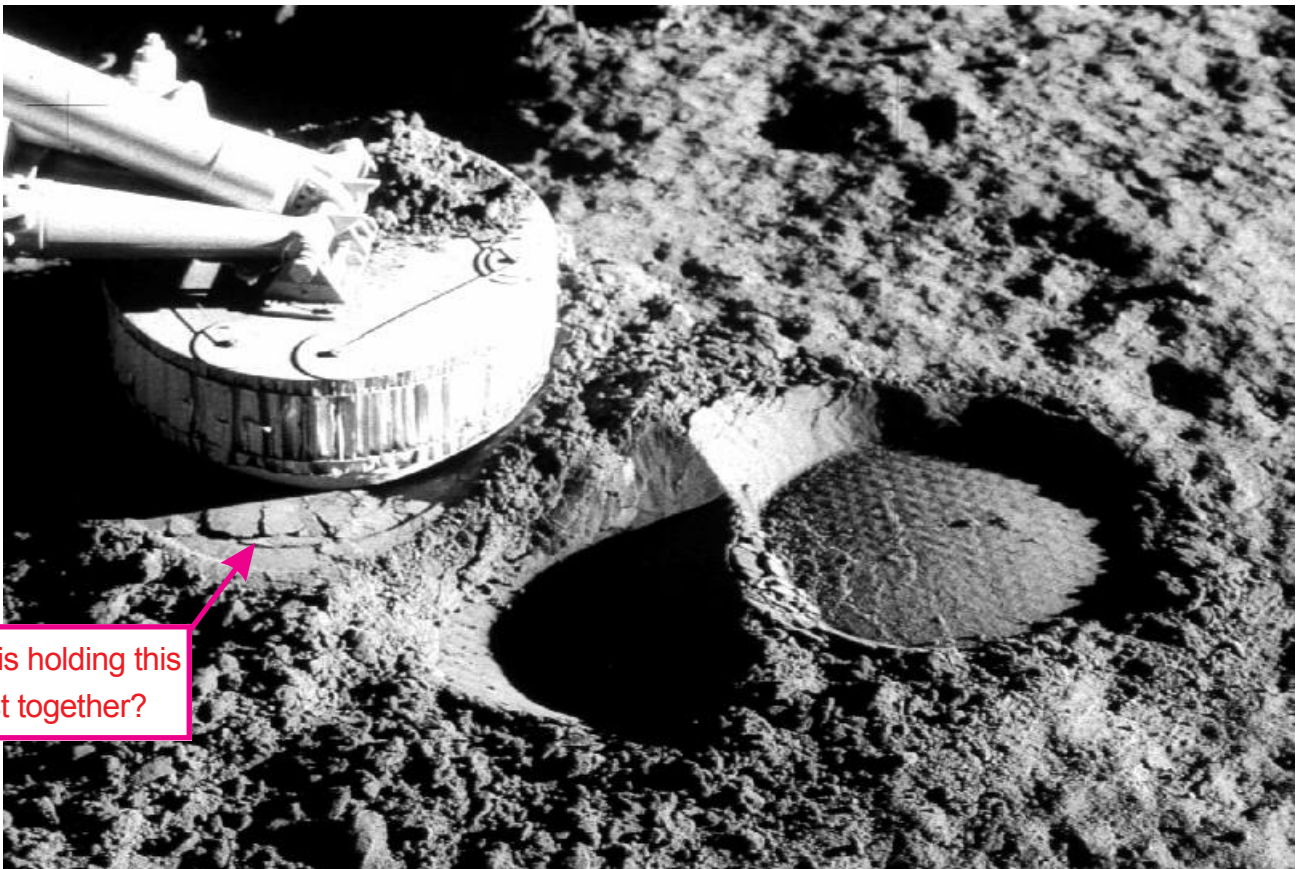

What is holding this dust together?

The astronauts walked over to a Surveyor craft which landed on the moon 2½ years earlier. The footprints after 2½ years were still crisp. Furthermore, 2½ years of bombardment by space dust had no effect.

Close up view of the footpad of Surveyor 5 on the lunar surface:

http://nssdc.gsfc.nasa.gov/imgcat/html/object_page/su5_67_h_1340.html

Compare the dirt on top of this footpad to the Apollo photo - this dirt does **not** clump

Compare this dirt to any Apollo photo...
how could this dirt leave footprints?

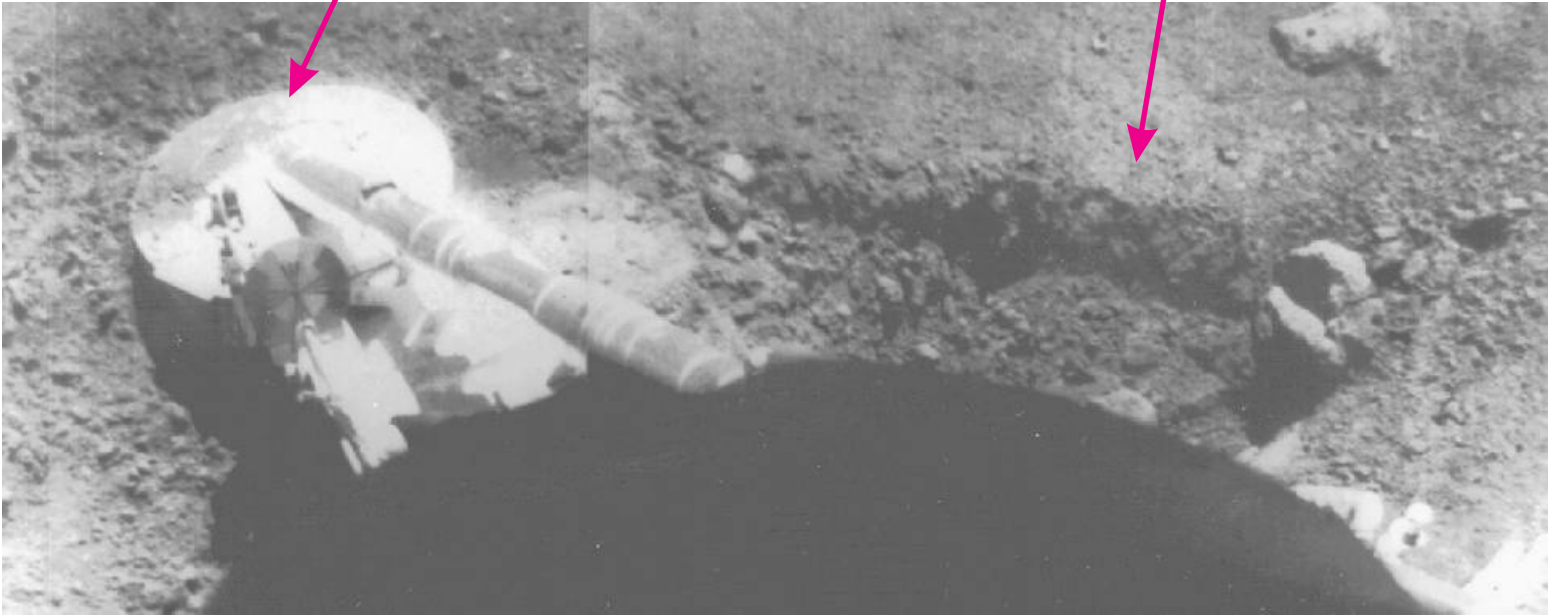

These two photos are from a Surveyor craft camera, **not the astronauts**.

The moon dirt in all Surveyor photos appears to **resemble Mars dirt**; ie, moon dirt appears to be the result of rocks that have been pounded repeatedly by meteors. The moon dirt appears to be a mix of powder, sand, and rocks of every size.

Notice that there are **no crisp footprints** in any Surveyor craft photos.

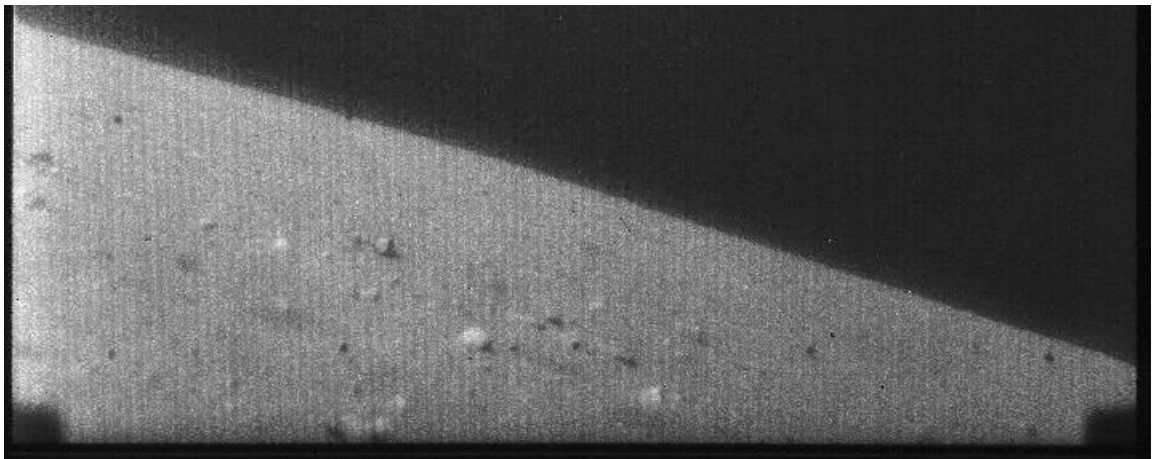

The Surveyor camera was lousy, but in this view of the moon, notice that the sunlight spreads all over the surface. Pages 18 and 19 have Apollo photos that show uneven lighting.

Surveyor photos: <http://nssdcftp.gsfc.nasa.gov/miscellaneous/planetary/surveyor/>

Note: Photos were compressed to make the PDF file smaller, which causes *details to disappear*.

To see high resolution Surveyor photos, go to the web site at top of this page

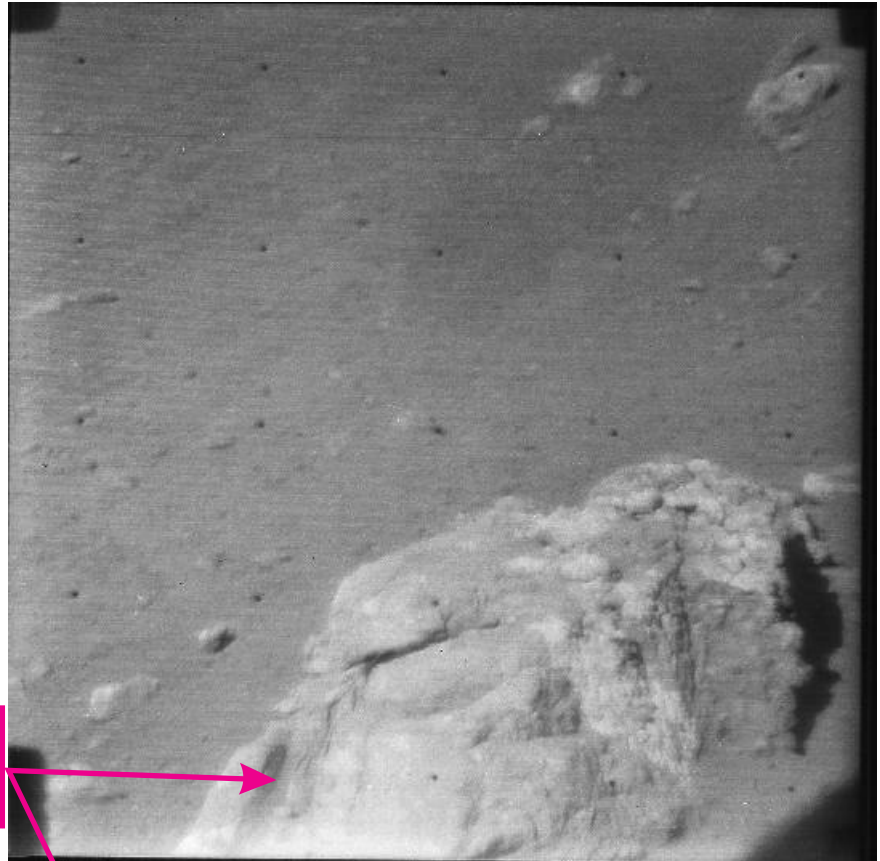

This is the same rock



These two photos were taken by the Surveyor craft camera.

As with all **real** moon photos, these photos show the moon to be a random mix of crushed rocks of various sizes.

I challenge you to explain how a mixture of broken rocks can hold themselves together to leave crisp footprints.

A sequence of 11 photos from Apollo 17



AS17-134-20377
 He walks over to the flag. (This is one of the low resolution photos.)

NOTES:

- The numbers are NASA's photo ID numbers
- Only some of the photos are available in high resolution.

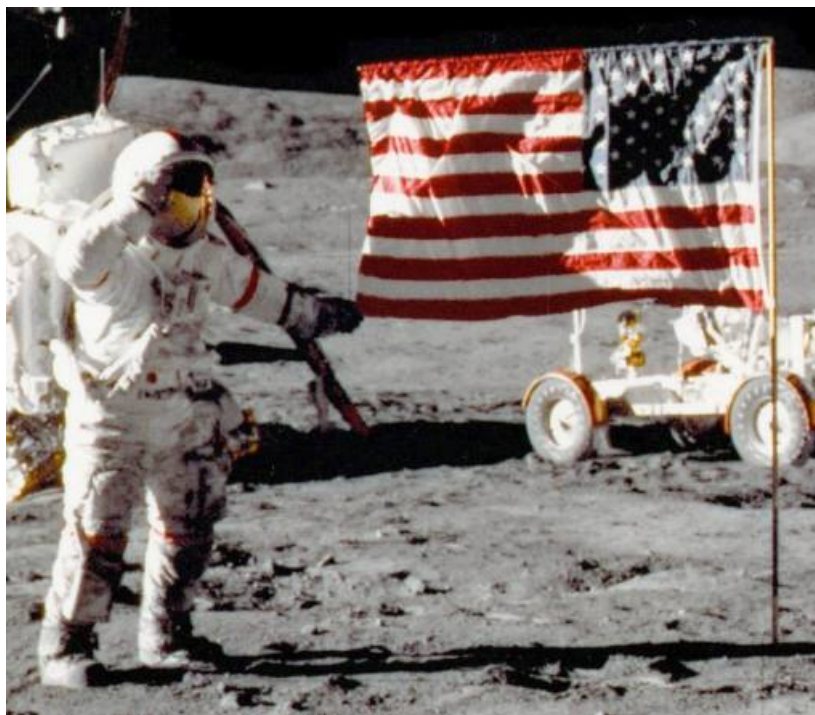

AS17-134-20378
 He pulls the lower corner of the flag to straighten it, and he salutes the flag while holding onto it.

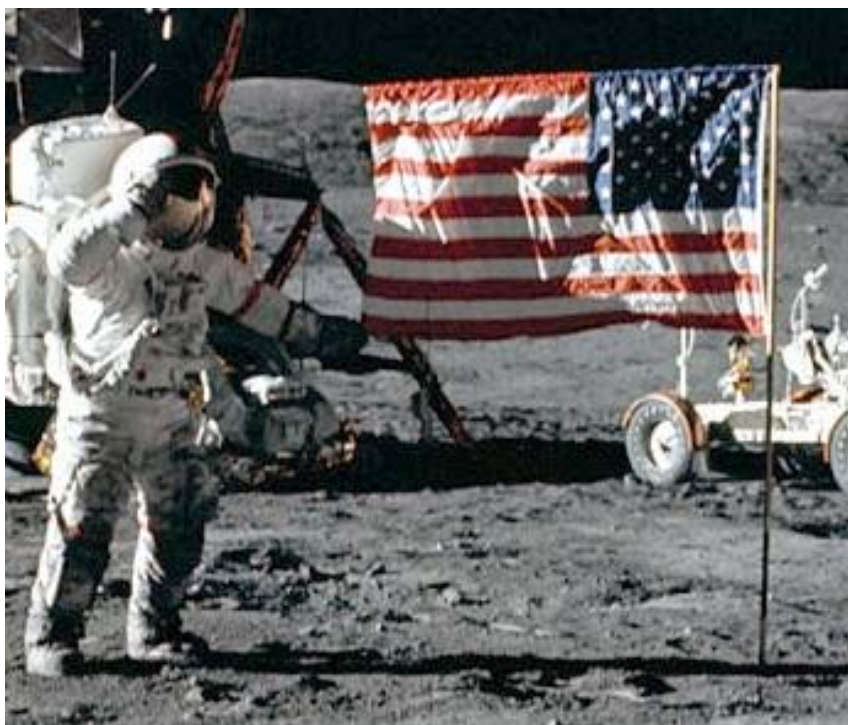

AS17-134-20379
 The photographer has moved, but the astronaut continues to hold the corner of the flag.

How long does he have to hold the flag to dampen all motion?

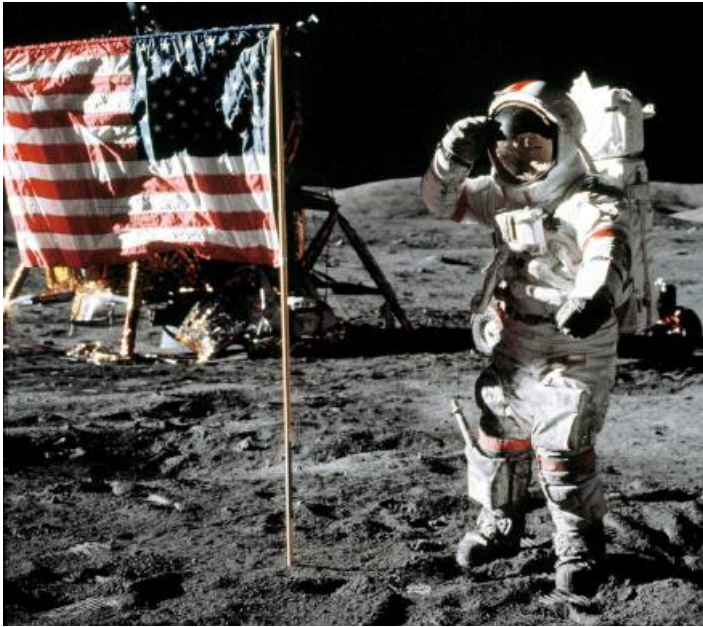

AS17-134-20380
He finally let go of the flag.

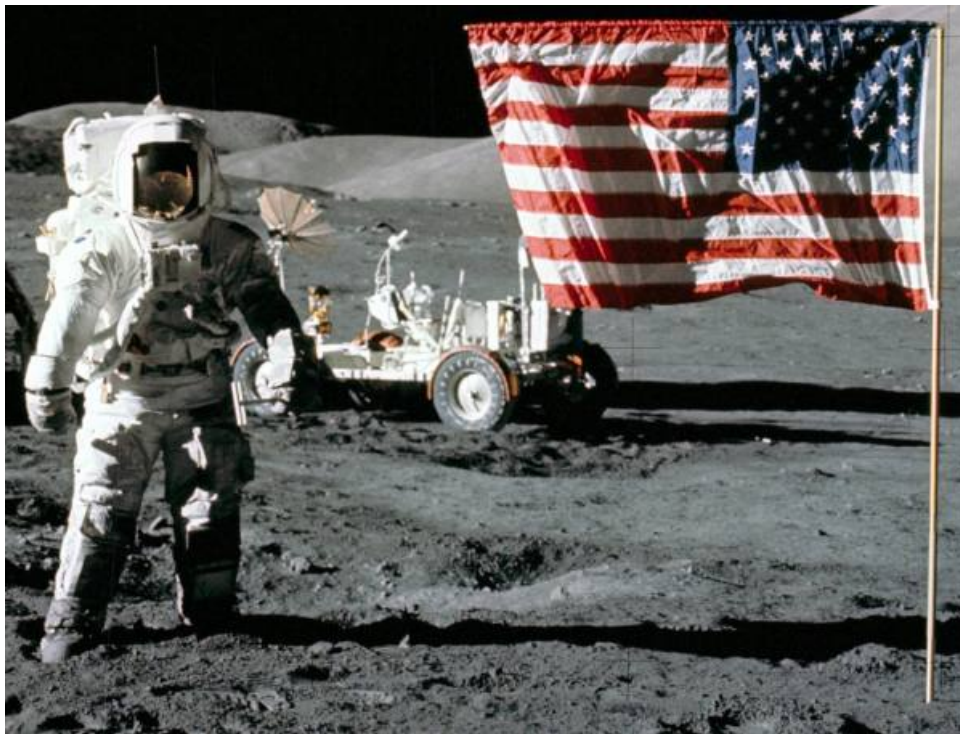

AS17-134-20381
He takes a rest.

However, it appears that the corner of the flag has moved compared to AS17-134-20378



AS17-134-20382
The photographer has changed positions again.
(Another low resolution photo)



AS17-134-20383

The photographer tries a close-up of the flag.



AS17-134-20384

Another attempt at a close-up of the flag.



AS17-134-20385

Now he grabs the corner of the flag again. What could have caused the corner of the flag to change its position?

Did the "solar wind" start to blow?



AS17-134-20386

Now he is once again saluting the flag while holding onto it.

Why is he holding the flag? Is he upset that the flag is **crumpled**? Or is he trying to stop the wind from **blowing the flag** around?

Why didn't the flag hold its position? What force was acting on it to cause it to move?



Why such a tight grip? And how did he bend his fingers so easily in pressurized gloves?



AS17-134-20387

He stopped saluting the flag, but he is **still holding onto it**.

The photographer stopped taking photos after this one.

Does this sequence of photos help you understand why some people complain the flag was waving in the wind?

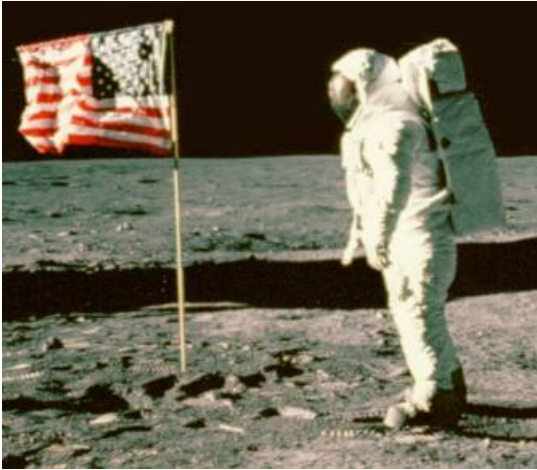

This above photo is from Apollo 11, the first to land on the moon.

There are **lots** of silly photos of the flag, but they did **not** take photos - or talk about - **the stars, Venus, or the Milky Way Galaxy**. The astronauts orbiting the moon had lots of free time, but they never talked about or took photos of the stars or planets, either.

The astronauts also had a perfect opportunity to demonstrate lunar gravity and physics to the TV audience. For example, an astronaut could have dropped a handful of dirt at the same time he dropped a rock. That would show:

- Dust falls as fast as rocks in a vacuum.
- Objects fall more slowly on the moon.

But the astronauts wasted their time on flag photos and golfing. Were the astronauts **boneheads**? Or were they actually on the Earth?

Where are the Stars?

Wouldn't the stars and planets be brighter and more numerous to astronauts than to U2 pilots?

NASA claims that stars and planets are difficult to see in space. However, pilots of high altitude aircraft tell us that stars are **everywhere**. For example, here is a comment from a U2 pilot:

"The air is so much clearer up there; you can see what seems to be 10 times more stars. They just carpet the sky."

(<http://www2.acc.af.mil/accnews/jan98/980025.html>)

The stars and planets are bright even from the windows of ordinary commercial jets. For example, Jerry Lodriguss was one of the millions of people who believed the stars are difficult to see from space. Recently he was a passenger in a flight at night. He looked out the window and noticed a bright light. He was very confused, but soon realized it was Venus. He wrote about this incident for his Internet site:

"Here I was, thinking of myself as a very experienced astronomical observer, and I didn't even recognize Venus!"

Doh!

What a dummy!

...I had never seen Venus that bright before."

(http://www.astropix.com/HTML/L_STORY/CLOSE.HTM)

Jerry may be correct that he is a dummy, but I suspect his main problem is that he **trusted NASA**, and therefore he was under the impression that the stars and planets would be dim from an airplane window and on the moon.

NASA's rebuttal to "Where are the Stars?"

"stars are not readily seen in the daylight lunar sky by either the human eye or a camera because of the brightness of the sunlight surface"

That remark is at: <http://www.hq.nasa.gov/alsj/a13/images13.html>

NASA gets away with this scam because of the technical ignorance of the majority of citizens - only a few people know why the Earth's sky is **blue**.

When an astronaut looks up at the stars, the sunlight will **not** enter his eyes. Instead, the light from **billions of stars** will enter his eyes. The sky on the moon will be **black** and full of stars, **not bright** from scattered sunlight.

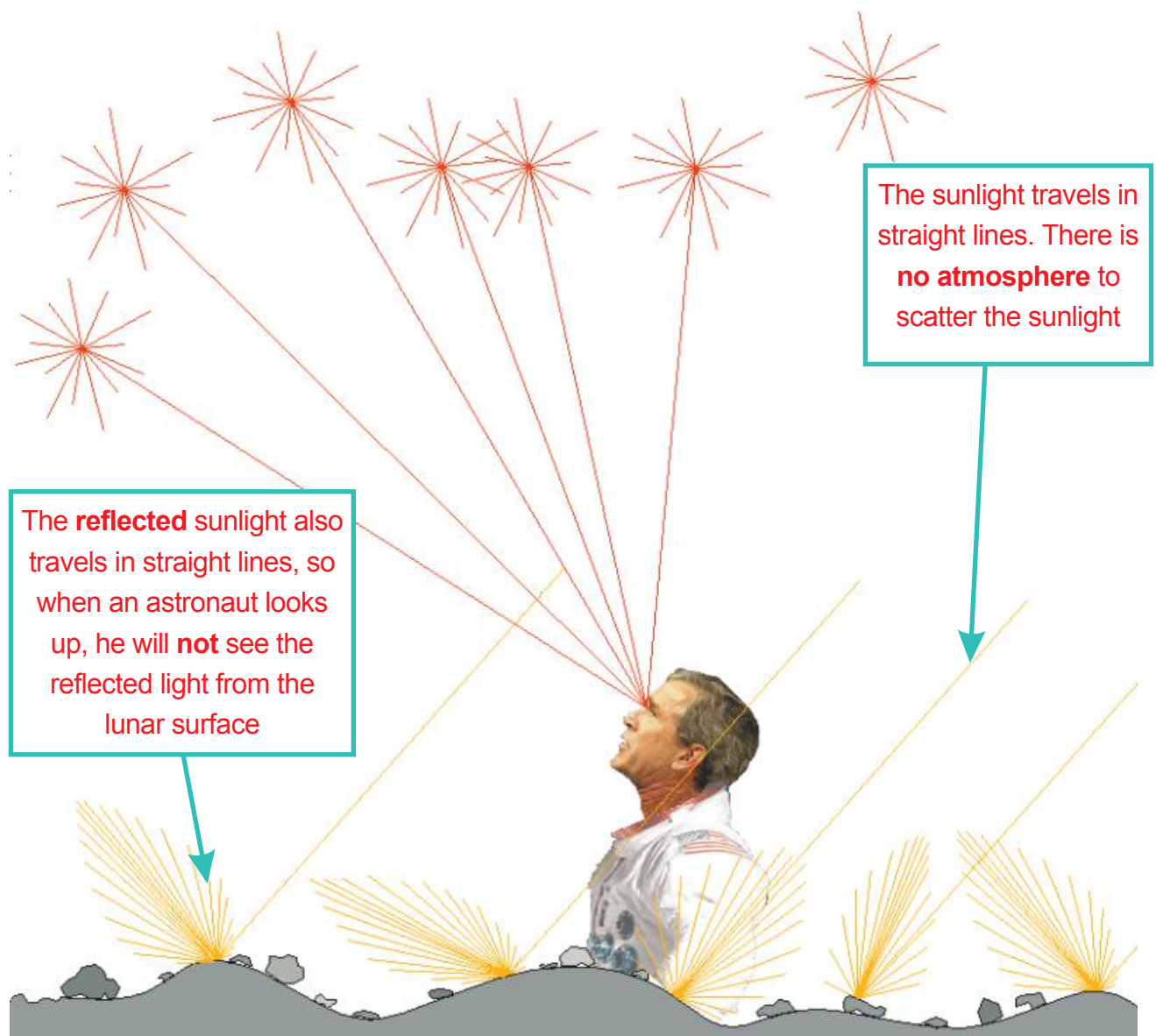

China and India recently announced a plan to go to the moon. This makes me wonder...will they also **fake** a moon landing? Will these scams ever stop? Will any nation elect a government that is truly respectable?

Were there two, separate space programs at NASA?

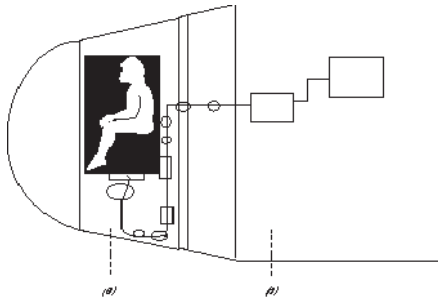

NASA drawing of the **Biosatellite 3** program, which put a monkey in orbit in 1969

John Glenn and other early astronauts spent only a few hours in earth orbit. Before sending people to the moon, NASA decided to conduct an experiment to determine the effect of a longer space flight. So on 29 June 1969 NASA sent a monkey into orbit around the earth for 30 days. Unfortunately, after a few days the monkey's health began deteriorating, and by the ninth day NASA decided to bring the spacecraft down. The monkey died eight hours after the spacecraft was recovered.

Would **you** get onto a spacecraft that is heading to the moon after watching a monkey die after only nine days in Earth orbit? Well, a week after that monkey died, Apollo 11 took off for the moon.

The monkey may have died simply because of the way NASA confined it to a tiny spacecraft, but even so, I would consider its death to be a sign that NASA was not ready to send people to the moon.

One and a half years later, in November 1970, NASA sent two frogs into orbit for 7 days. Unlike the monkey, NASA had no intention of bringing the frogs back to earth. They simply wanted to observe the frogs. Did the death of the monkey cause NASA to wonder if they can keep **anything** alive in space for more than a few days?

It seems that there were two separate programs going on at NASA. One was of the wonderfully successful landing of men on the moon, and the other was the real space program, which often ended in disappointment and failure.

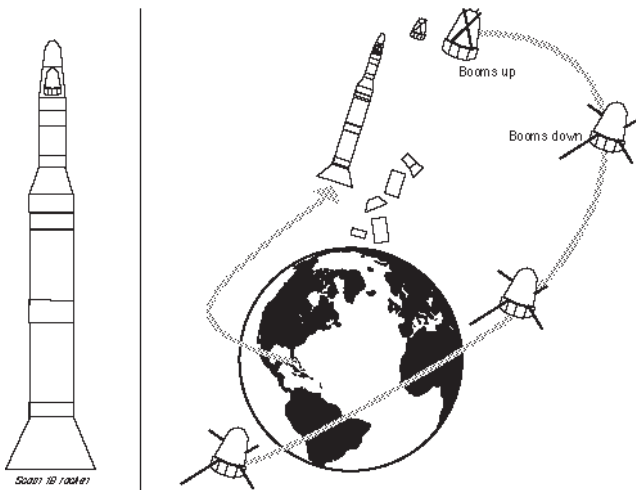

NASA drawing of the **Orbiting Frog Otolith-A**, which put 2 frogs in orbit for 7 days in November 1970

Most photos taken on the moon are low quality, but NASA claims to have provided the astronauts with excellent cameras.

The details are blurred; shadows are strange; sunlight reflects in odd manners... were the astronauts lousy photographers? Or did the radiation damage the film? Or were the photos edited in order to hide the fact that they were taken on the Earth?

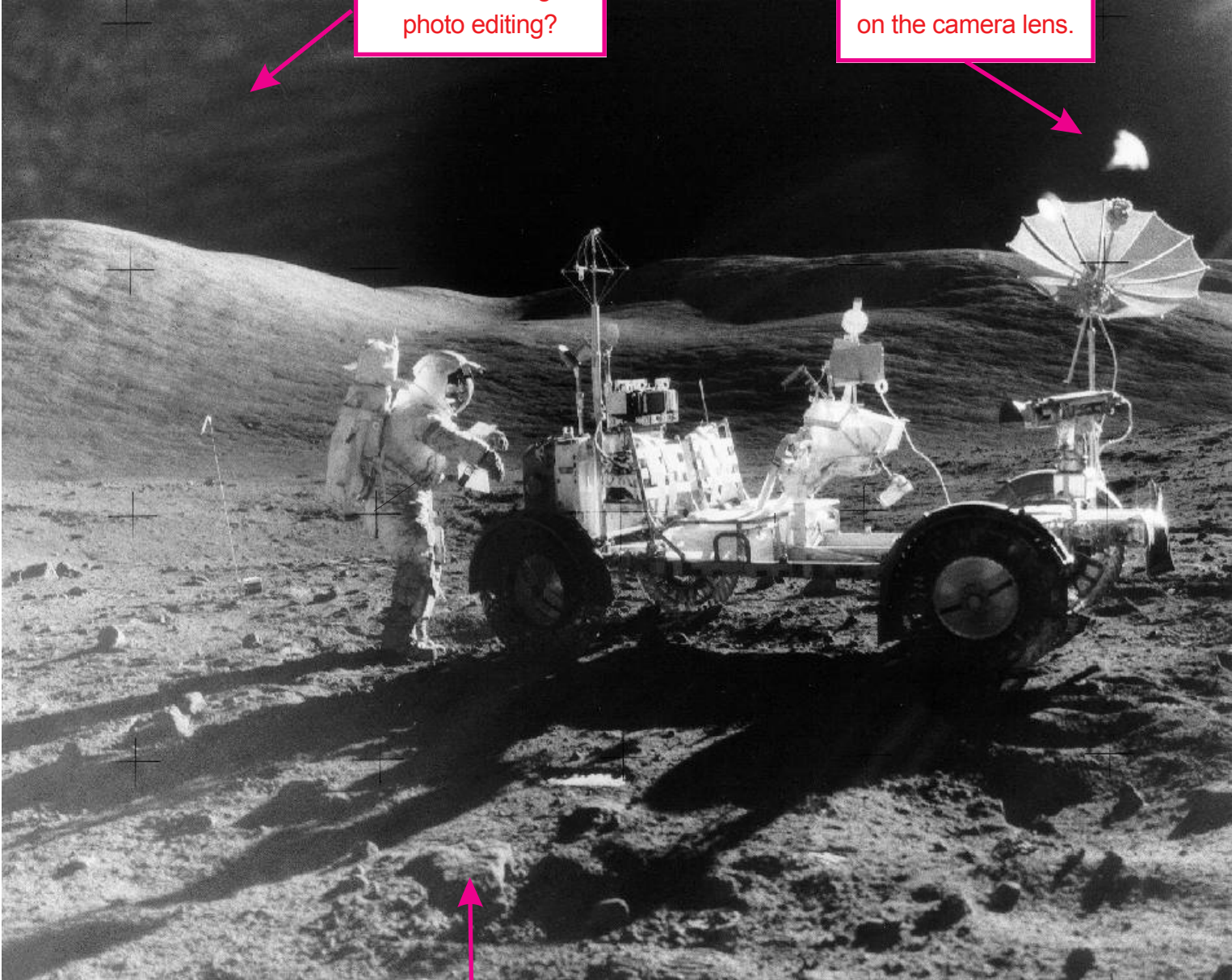

Clouds? Or a sign of photo editing?

Reflections of the sun on the camera lens.

Do these shadows seem parallel to you? NASA supporters claim the cameras had "wide angle lenses" that distorted the shadows. Why didn't NASA give them cameras that provide **accurate images**?

Is this our sun?



Dozens of photos have the "sun" directly in front of the camera, but the sun does not have the intensity to wash out the photo.

Also, the moon's surface is brighter near the sun, as if it is a Hollywood studio lamp only 100 meters from the Astronauts, rather than a powerful sun 150 million kilometers away.

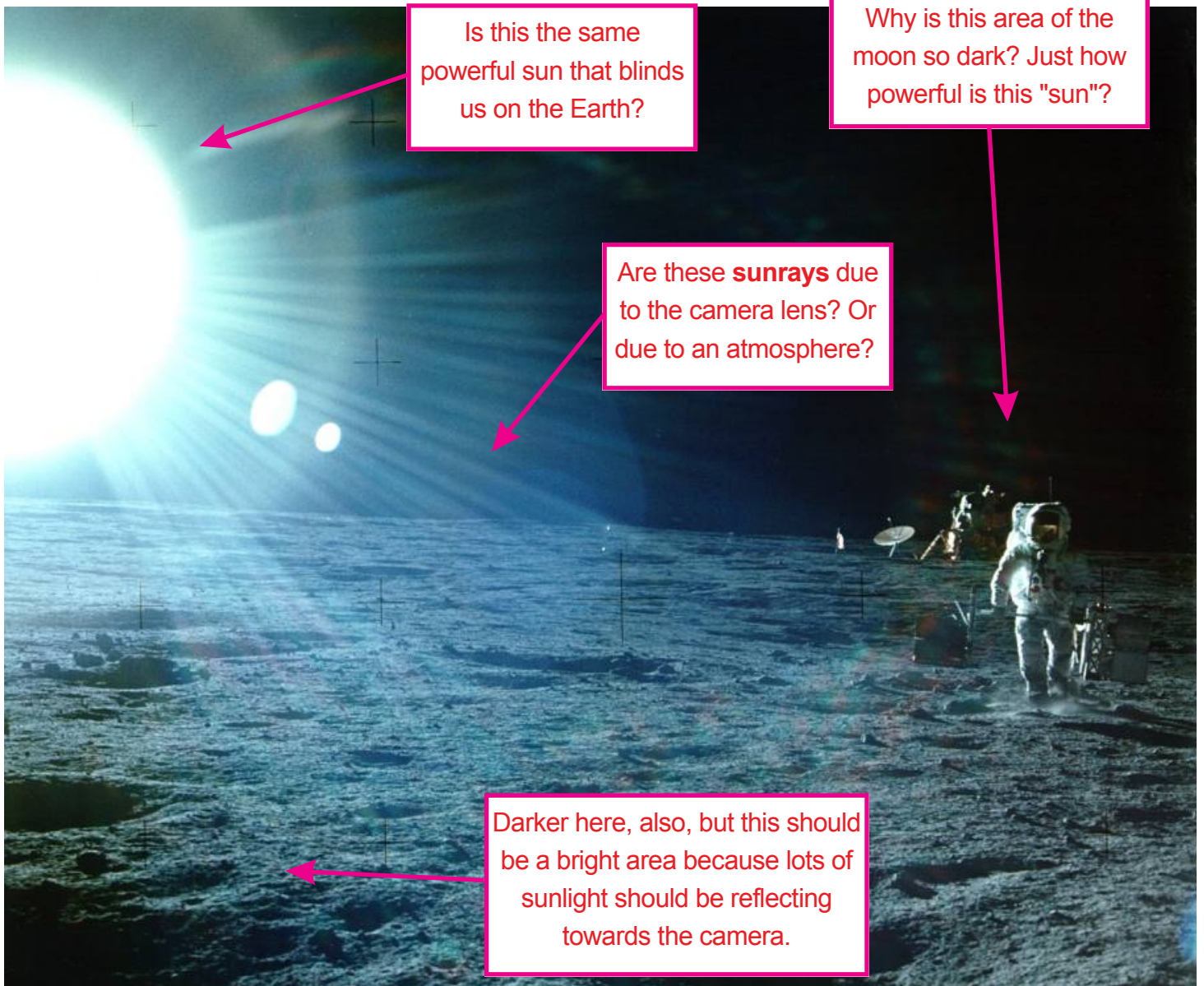

Is this the same powerful sun that blinds us on the Earth?

Why is this area of the moon so dark? Just how powerful is this "sun"?

Are these **sunrays** due to the camera lens? Or due to an atmosphere?

Darker here, also, but this should be a bright area because lots of sunlight should be reflecting towards the camera.



NASA claims this facility was only for training.

NASA did not bother to test the Lunar Module, but they built these angled-walls so the astronauts could practice walking in low gravity so that they wouldn't fall down on the moon.

Why make astronauts practice moon-walks when we cannot be sure the Lunar Module will work? What kind of scientists have such priorities?



An angled wall can be used to fake brief moon walks ... just make a large wall and turn the camera sideways.



The moon
before painting

For more photos like this, check out:
<http://www.geocities.com/apolloreality/>



Shall we convince
ourselves that this
moon was only for
a museum?



Or shall we
convince
ourselves that
this was for
flight training?



Is it possible to land
on the moon without
getting dust on the
gold foil, and without
the foil being
damaged by the
engine exhaust?

Or did that man in the
upper photo land this
rocket on the moon?

Questions to Ponder

- If you had been asked to pretend to be the first person on the moon, would you have taken the job? Would you be able to announce (without your voice showing signs of embarrassment):

"That's one small step for man, one giant leap for mankind"

- How many more decades will Americans make themselves look like ignorant fools for boasting that they landed on the moon?