

APPLIED PHARMACOLOGY

for Veterinary Technicians

Fourth Edition



SAUNDERS
ELSEVIER

Boyce P. Wanamaker
Kathy Lockett Massey

Copyrighted material

APPLIED PHARMACOLOGY
for Veterinary Technicians

Fourth Edition

This page intentionally left blank

APPLIED PHARMACOLOGY

for Veterinary Technicians

Fourth Edition

Boyce P. Wanamaker, DVM, MS

Director,
Veterinary Technology Program,
Columbia State Community College,
Columbia, Tennessee

Kathy Lockett Massey, LVMT

Veterinary Technology Department,
Columbia State Community College,
Columbia, Tennessee

with 150 illustrations



SAUNDERS

An Imprint of Elsevier Inc.

11830 Westline Industrial Drive
St. Louis, Missouri 63146

APPLIED PHARMACOLOGY FOR VETERINARY TECHNICIANS

ISBN: 978-1-4160-5633-1

Copyright © 2009, Elsevier (USA). All rights reserved.

All rights reserved. No part of this publication may be reproduced or transmitted in any form or by any means, electronic or mechanical, including photocopying, recording, or any information storage and retrieval system, without permission in writing from the publisher. Permissions may be sought directly from Elsevier's Rights Department: phone: (+1) 215 239 3804 (US) or (+44) 1865 843830 (UK); fax: (+44) 1865 853333; e-mail: healthpermissions@elsevier.com. You may also complete your request on-line via the Elsevier website at <http://www.elsevier.com/permissions>.

Notice

Knowledge and best practice in this field are constantly changing. As new research and experience broaden our knowledge, changes in practice, treatment and drug therapy may become necessary or appropriate. Readers are advised to check the most current information provided (i) on procedures featured or (ii) by the manufacturer of each product to be administered, to verify the recommended dose or formula, the method and duration of administration, and contraindications. It is the responsibility of the practitioner, relying on their own experience and knowledge of the patient, to make diagnoses, to determine dosages and the best treatment for each individual patient, and to take all appropriate safety precautions. To the fullest extent of the law, neither the Publisher nor the Editors/Authors assume any liability for any injury and/or damage to persons or property arising out of or related to any use of the material contained in this book.

Previous editions copyrighted 2004, 2000, 1996.

Library of Congress Control Number: 2007940438

Vice President and Publisher: Linda L. Duncan
Managing Editor: Teri Merchant
Developmental Editor: Shelly Stringer
Publishing Services Manager: Pat Joiner-Myers
Senior Project Manager: David Stein
Design Direction: Kim Derando
Cover Design: Kim Derando

Printed in Canada.

Last digit is the print number: 9 8 7 6 5 4 3 2 1

Working together to grow
libraries in developing countries

www.elsevier.com | www.bookaid.org | www.sabre.org

ELSEVIER

Foundat

THIS BOOK IS DEDICATED TO:

Tippy, Mammy, Meghan, Skye, and the other dogs of my past and future for their unwavering loyalty, affection, and companionship.

Doris and Preston, my parents, for a lifetime of encouragement, discipline, and love.

Karen, my wife, for her emotional support and editorial assistance.

The students with whom I have had the pleasure to share knowledge through the years.

B.W.

Thanks to God for the loving miracle of my parents, Harry and Bettie Lockett, who chose me to share their lives with.

To my children, Eric and Darla, you are the light of my life.

Try to give back to the world more than you take.

To Dr. Wanamaker for his patience.

To Dr. Frankie Locklar for teaching me about tolerance and other life lessons.

To all the technicians and students I've worked with, don't ever forget that we are not just helping animals, but people too. If an animal can make a person laugh, our job may have a twofold purpose.

Perhaps mirth is the epitome of human health.

K.M.

This page intentionally left blank

PREFACE

Applied Pharmacology for Veterinary Technicians, fourth edition, is designed for both the graduate technician and the student. As a teaching and reference book, its purpose is to help veterinary technicians become familiar with the many veterinary pharmacologic agents and their uses, adverse side effects, and dosage forms. We believe it is very important for the technician to understand the uses of pharmacologic agents and to have the ability to provide client education under the supervision of the attending veterinarian. A key feature of this publication is a format intended to provide easy and quick access to chapter information. Each chapter is introduced with learning objectives, a chapter outline, and key terms with simple definitions. “Technician’s Notes” throughout the text provide helpful hints and important points technicians should be aware of to avoid errors and increase efficiency.

NEW TO THIS EDITION

New features have been added to the fourth edition to aid the student and technician in the study and application of pharmacology. Chapter 2 has new and practical information on performing calculations for constant rate infusion problems. Chapter 16 has new and updated material related to neoplasia and antineoplastic drugs. Chapter 18 has a new section on herbal medicine and Appendix D has updated information on regulations that apply to controlled substances.

NEW TO THE EVOLVE SITE

Evolve Student Learning Resources offer the following new features to reinforce textbook content and help students master key concepts:

- **Drug Administration Videos**—12 videos demonstrate drug administration techniques (oral, injectable, inhaled) and IV preparation for dogs and cats
- **Drug Calculators with Related Exercises**—Six drug calculators with accompanying word problems help students perform accurate drug calculations
- **Drug Label Image Collection**—137 photos of drug labels, divided by chapter and organized alphabetically, help students become familiar with drug information and packaging encountered in practice
- **Animations**—Animations of pharmacologic processes, such as passive diffusion and receptor interaction, help students visualize and understand key concepts
- **Dosage Calculation Exercises**—Exercises reinforce calculation skills and provide valuable practice in the areas of:
 - Drug Calculation Methods
 - Oral and Enteral Medication Administration
 - Intravenous Infusion
 - Critical Care Calculations
- **Answers to Review Questions**—Answers to chapter review questions allow students to gauge comprehension of key topics

Our intent in writing this book has been to combine the comprehensiveness of a veterinary pharmacology textbook with the coverage of pharmacologic fundamentals needed by veterinary technicians. No longer will veterinary technician educators have to draw from two sources for this type of coverage. The scope and organization of the information in this book will make it a useful reference for the practicing technician as well.

Boyce P. Wanamaker, DVM, MS
Kathy Lockett Massey, LVMT

VET TECH THREADS

We are inaugurating a set of features and design elements that will be shared with other vet tech titles on the Mosby and Saunders lists. The purpose of the “Vet Tech Threads” is to make it easier for students and instructors to incorporate multiple books into the fast-paced and demanding vet tech curriculum.

The shared features in *Applied Pharmacology for Veterinary Technicians*, fourth edition, include the following:

- Lists of **Objectives** begin each chapter
 - **Technician’s Notes** boxes appear throughout the text to emphasize information particularly relevant to the role of veterinary technicians
 - **Key Terms** are in bold the first time they appear in the chapter
 - An extensive **Glossary** of the key terms is at the end of the text
-
- Cover and internal **design similarities**: the colorful, student-friendly design encourages reading and learning of this core content

ACKNOWLEDGMENTS

I would like to acknowledge the editors and staff at Elsevier including Teri Merchant, David Stein, and Shelly Stringer for their support and assistance in making this edition possible.

I would also like to recognize veterinary technicians and veterinary technology students everywhere whose desire for knowledge and dedication to quality animal care have made animal nursing a true profession.

I also want to recognize the technical support and expertise of Stewart Marston in the production of the video clips for the CD-ROM.

Boyce P. Wanamaker

I would like to thank: Boyce Wanamaker, DVM, Columbia State Community College; Mary Kirby, LVMT, Columbia State Community College; Bill Henson, DVM, Henson Animal Clinic, Corinth, Mississippi; Jim Jackson, DVM, Jackson Animal Clinic, Corinth, Mississippi; Forrest Cutlip, DVM, Milan Animal Hospital, Milan, Tennessee; C.E. Locklar, Jr., DVM, Maury County Veterinary Hospital, Columbia, Tennessee; Martha Locklar, CPA, Maury County Veterinary Hospital, Columbia, Tennessee; Steve Grubbs, DVM, PhD, Princeton, New Jersey; Robert Myers, DVM, Maury County Veterinary Hospital, Columbia, Tennessee; Christi Cartwright, LVMT, Maury County Veterinary Hospital, Columbia, Tennessee.

Kathy Lockett Massey

This page intentionally left blank

CONTENTS

1 GENERAL PHARMACOLOGY, 1

- Introduction, 2
- Drug Sources, 3
- Inactive Ingredients, 3
- Pharmacotherapeutics, 3
- Pharmacokinetics, 5
 - Routes of Administration*, 6
 - Drug Absorption*, 8
 - Drug Distribution*, 10
 - Biotransformation*, 11
 - Drug Excretion*, 11
- Pharmacodynamics, 13
- Drug Interactions, 15
- Drug Names, 16
- Drug Labels, 17
- Development and Approval of New Drugs, 19
 - Regulatory Agencies*, 19
 - Steps in the Development of a New Drug*, 21
- Federal Laws Related to Drug Development and Use, 21
 - The Animal Medicinal Drug Use Clarification Act*, 22
 - Compounding of Veterinary Drugs*, 22
 - The Veterinary Feed Directive*, 23
 - The Minor Use and Minor Species Animal Health Act*, 23
- Dispensing Versus Prescribing Drugs, 23
- Marketing of Drugs, 23

2 ROUTES AND TECHNIQUES OF DRUG ADMINISTRATION, 27

- Introduction, 28
- Dosage Forms, 28
- Drug Preservatives and Solvents, 35
- Drug Administration, 35
 - Oral Medications*, 36
 - Parenteral Medications*, 38
 - Intramuscular Injections*, 46
 - Subcutaneous Injections*, 46
 - Inhalation Medications*, 46
 - Topical Medications*, 47
- Medication Orders, 48
- Controlled Substances, 49
- Client Education, 50

3 PRACTICAL CALCULATIONS IN PHARMACOLOGY, 53

- Introduction, 54
- Mathematics Fundamentals, 54
- Systems of Measurement, 55
 - Metric System*, 55
 - Conversion Between Metric Units*, 55
 - Apothecary and Household Systems*, 57
- Dosage Calculations, 58
- Solutions, 59
- Percent Concentrations, 59
 - Calculations Involving Concentrations*, 60
- Milliequivalents, 61
- Calculations Involving IV Fluid Administration, 61
 - Calculations for Constant Rate Infusion Problems*, 61

4 DRUGS USED IN NERVOUS SYSTEM DISORDERS, 69

- Introduction, 70
- Anatomy and Physiology, 70
- Autonomic Nervous System, 75
 - How Drugs Affect the Autonomic Nervous System* 78
- Classes of Autonomic Nervous System Agents, 78
- CHOLINERGIC AGENTS, 78
 - Direct-Acting Cholinergics*, 78
 - Indirect-Acting Cholinergic (Anticholinesterase) Agents*, 78
- CHOLINERGIC BLOCKING AGENTS (ANTICHOLINERGIC), 79
- ADRENERGIC (SYMPATHOMIMETIC) AGENTS, 80
- ADRENERGIC BLOCKING AGENTS, 80
 - Alpha Blockers*, 81
 - Beta Blockers*, 81
 - Ganglionic Blockers*, 81
- Central Nervous System, 81
- TRANQUILIZERS, 82
 - Phenothiazine Derivatives*, 82
 - Benzodiazepine Derivatives*, 82
 - Xylazine Hydrochloride*, 83
 - Detomidine Hydrochloride*, 83
 - Medetomidine*, 84
 - Romifidine*, 84

- BARBITURATES, 84
 - Long-Acting Barbiturates, 84
 - Short-Acting Barbiturates, 85
 - Ultrashort-Acting Barbiturates, 85
 - DISSOCIATIVE AGENTS, 86
 - OPIOID AGONISTS, 86
 - Naturally Occurring Narcotics, 87
 - Synthetic Narcotics, 87
 - OPIOID ANTAGONISTS, 88
 - NEUROLEPTANALGESICS, 89
 - DRUGS GIVEN TO PREVENT OR CONTROL SEIZURES, 89
 - INHALANT ANESTHETICS, 90
 - MISCELLANEOUS CENTRAL NERVOUS SYSTEM DRUGS, 92
 - Propofol, 92
 - Glyceryl Guaiacolate or Guaifenesin (Guaifenesin, Gecolate), 93
 - Chloral Hydrate/Magnesium Sulfate, 93
 - CENTRAL NERVOUS SYSTEM STIMULANTS, 93
 - Doxapram, 94
 - Pentylenetetrazol (Metrazol), 94
 - Caffeine, 94
 - Amphetamines, 94
 - NEUROMUSCULAR BLOCKING DRUGS, 94
 - Behavioral Pharmacotherapy, 95
 - Pharmacotherapeutic Agents, 95
 - ANTI-ANXIETY MEDICATIONS, 95
 - Benzodiazepines, 95
 - Azapirones, 96
 - ANTIDEPRESSANTS, 96
 - Tricyclics, 96
 - Serotonin Reuptake Inhibitors, 96
 - Monoamine Oxidase-B Inhibitors, 96
 - Synthetic Progestins, 97
 - EUTHANASIA AGENTS, 97
- 5 DRUGS USED IN RESPIRATORY SYSTEM DISORDERS, 101**
- Introduction, 102
 - Respiratory Anatomy and Physiology, 102
 - Respiratory Defense Mechanisms, 104
 - Principles of Respiratory Therapeutics, 104
 - Inhalation Therapy for Respiratory Disease, 105
 - Categories of Respiratory Drugs, 105
- EXPECTORANTS, 105
 - Guaifenesin (Glyceryl Guaiacolate), 105
 - MUCOLYTICS: ACETYLCYSTEINE, 106
 - ANTITUSSIVES: CENTRALLY ACTING AGENTS, 106
 - Butorphanol Tartrate, 106
 - Hydrocodone Bitartrate, 106
 - Codeine, 107
 - Dextromethorphan, 108
 - Temaril-P, 108
 - BRONCHODILATORS, 108
 - Cholinergic Blockers, 109
 - Antihistamines, 109
 - Beta-2-Adrenergic Agonists, 109
 - Methylxanthines, 109
 - DECONGESTANTS, 110
 - ANTIHISTAMINES, 110
 - CORTICOSTEROIDS, 110
 - MISCELLANEOUS RESPIRATORY DRUGS, 111
 - Respiratory Stimulants, 111
- 6 DRUGS USED IN RENAL AND URINARY TRACT DISORDERS, 114**
- Introduction, 115
 - Physiologic Principles, 116
 - Renal Failure, 119
 - Drugs Commonly Used for the Treatment of Renal Dysfunction and Associated Hypertension, 120
 - DIURETIC DRUGS, 120
 - Loop Diuretics, 120
 - Osmotic Diuretics, 120
 - Thiazide Diuretics, 120
 - Potassium-Sparing Diuretics, 120
 - Carbonic Anhydrase Inhibitors, 121
 - CHOLINERGIC AGONISTS, 121
 - ANTICHOLINERGIC DRUGS, 121
 - ADRENERGIC ANTAGONISTS, 122
 - Alpha-Adrenergic Antagonists, 122
 - Beta-Adrenergic Antagonists, 122
 - ANGIOTENSIN-CONVERTING ENZYME INHIBITORS, 123
 - VASODILATORS AND CALCIUM CHANNEL BLOCKERS, 123
 - ANTIDIURETIC HORMONE, 123
 - URINARY ACIDIFIERS, 123

- XANTHINE OXIDASE INHIBITORS, 124
- URINARY ALKALIZERS, 124
- Pharmacotherapy of Renal Failure
Complications, 124
- Pharmacotherapy of Urinary Incontinence, 125
- MISCELLANEOUS RENAL DRUGS, 125
- Urinary Tract Analgesics, 125
 - Tricyclic Antidepressants, 125
 - Glycosaminoglycans, 126
 - Other Agents, 126
- Technician's Role, 127
- 7 DRUGS USED IN CARDIOVASCULAR SYSTEM DISORDERS, 129**
- Introduction, 130
- Anatomy and Physiology of the Heart, 130
- Compensatory Mechanisms of the Cardiovascular System, 133
- Basic Objectives in the Treatment of Cardiovascular Disease, 135
- Categories of Cardiovascular Drugs, 135
- POSITIVE INOTROPIC DRUGS, 135
- Cardiac Glycosides (*Digitalis*), 135
 - Catecholamines, 136
 - Bipyridine Derivatives, 137
 - Inotropic, Mixed Dilator, 137
- ANTIARRHYTHMIC DRUGS, 138
- Class IA, 138
 - Class IB, 139
 - Class IC, 139
 - Class II, 139
 - Class III, 140
 - Class IV, 140
 - Other Class IV Antiarrhythmics, 141
- VASODILATOR DRUGS, 141
- Hydralazine, 142
 - Nitroglycerin Ointment, 142
 - Prazosin, 143
 - Angiotensin-Converting Enzyme Inhibitors, 143
- DIURETICS, 143
- Furosemide, 144
 - Thiazides, 144
 - Spirolactone, 144
- Dietary Management of Heart Disease, 144
- Ancillary Treatment of Heart Failure, 145
- Bronchodilators, 145
 - Oxygen Therapy, 145
 - Sedation, 145
 - Aspirin, 145
 - Thoracentesis and Abdominocentesis, 145
- 8 DRUGS USED IN GASTROINTESTINAL SYSTEM DISORDERS, 149**
- Introduction, 150
- Anatomy and Physiology, 150
- Regulation of the Gastrointestinal System, 153
- Vomiting, 154
- EMETICS, 154
- Centrally Acting Emetics, 154
 - Locally Acting Emetics, 155
- ANTIEMETICS, 155
- Phenothiazine Derivatives, 156
 - Procainamide Derivatives:
 - Metoclopramide, 156
 - Antihistamines, 157
 - Anticholinergics, 157
 - Butyrophenones, 158
 - Serotonin Receptor Antagonists, 158
 - NK-1 Receptor Antagonists, 158
- ANTIULCER MEDICATIONS, 158
- H₂ Receptor Antagonists, 158
 - Proton Pump Inhibitors, 160
 - Antacids, 160
 - Gastromucosal Protectants, 160
 - Prostaglandin E-1 Analogs, 161
- Diarrhea, 161
- ANTIDIARRHEAL MEDICATIONS, 161
- Narcotic Analgesics, 161
 - Anticholinergics/Antispasmodics, 162
 - Protectants/Adsorbents, 162
- LAXATIVES, 163
- Saline/Hyperosmotic Agents, 163
 - Bulk-Producing Agents, 163
 - Lubricants, 164
 - Surfactants/Stool Softeners, 164
 - Irritants, 164
- GASTROINTESTINAL PROKINETICS/STIMULANTS, 164
- Dopaminergic Antagonists, 165
 - Serotonergic Drugs, 165
 - Motilin-like Drugs, 165
 - Direct Cholinergics, 165
 - Acetylcholinesterase Inhibitors, 166
- DIGESTIVE ENZYMES, 166

MISCELLANEOUS GASTROINTESTINAL
DRUGS, 166

- Antibiotics, 166*
- Antiinflammatory Agents, 167*
- Antifoaming Agents, 167*
- Weight-Loss Products, 167*
- Probiotics, 168*
- Appetite Stimulants, 168*

ORAL PRODUCTS, 168

- Dentifrice and Cleansing Products, 168*
- Fluoride Products, 168*
- Perioceutic Agents, 169*
- Polishing Paste, 169*
- Disclosing Solution, 169*

**9 DRUGS USED IN HORMONAL, ENDOCRINE,
AND REPRODUCTIVE DISORDERS, 172**

Introduction, 173

Anatomy and Physiology, 173

- Pituitary Gland, 173*
- Control of the Endocrine System, 175*

Hormonal Drugs Associated With

Reproduction, 177

GONADOTROPINS AND GONADAL
HORMONES, 177

- Gonadotropins, 177*
- Estrogens, 178*
- Androgens, 178*
- Progestins, 179*

PROSTAGLANDINS, 180

- Dinoprost Tromethamine, 181*
- Fenprostalene, 181*
- Fluprostenol, 181*
- Cloprostenol Sodium, 182*

DRUGS THAT AFFECT UTERINE
CONTRACTILITY, 182

- Oxytocin, 182*
- Ergot, 183*
- Prostaglandins, 183*
- Corticosteroids, 183*

MISCELLANEOUS REPRODUCTIVE
DRUGS, 183

- Bromocriptine, 183*
- Leuprolide, 183*
- Melatonin, 183*
- Neutersol, 183*

PHEROMONES, 183

Thyroid Hormones, 184

DRUGS USED TO TREAT
HYPOTHYROIDISM, 184

- Levothyroxine Sodium (T_4), 184*
- Liothyronine Sodium, 185*
- Thyroid-Stimulating Hormone, 185*

DRUGS USED TO TREAT
HYPERTHYROIDISM, 185

- Methimazole, 185*
- Carbimazole, 185*
- Iodate, 186*
- Propylthiouracil, 186*
- Radioactive Iodine, 186*
- Propranolol, 186*

AGENTS FOR THE TREATMENT
OF DIABETES MELLITUS, 186

- Insulin, 186*
- Oral Hypoglycemic Agents, 189*

HYPERGLYCEMIC AGENTS, 189

Hormones That Act As Growth Promoters, 190

SEX STEROIDS, SYNTHETIC STEROID
ANALOGS, AND NONSTEROIDAL

ANALOGS, 190

GROWTH HORMONE: BOVINE
SOMATOTROPIN, BOVINE GROWTH
HORMONE, 191

Anabolic Steroids, 191

- Stanozolol, 191*
- Boldenone Undecylenate, 192*
- Nandrolone Decanoate, 192*

**10 DRUGS USED IN OPHTHALMIC AND OTIC
DISORDERS, 195**

Ophthalmic Agents, 196

MYDRIATICS AND CYCLOPLEGICS, 197

- Phenylephrine Hydrochloride, 197*
- Atropine Sulfate, 197*
- Homatropine Hydrobromide, 198*
- Cyclopentolate Hydrochloride, 198*
- Tropicamide, 198*
- Epinephrine, 198*

MIOTICS, 198

- Pilocarpine, 198*
- Demecarium Bromide, 199*

OTHER AGENTS THAT REDUCE
INTRAOCULAR PRESSURE, 199

- Carbonic Anhydrase Inhibitors, 199*
- Beta-Adrenergic Antagonists, 199*
- Sympathomimetics, 200*

- Topical Prostaglandins, 200
- Osmotic Diuretics, 200
- TOPICAL ANESTHETICS, 201
 - Proparacaine Hydrochloride, 201
 - Tetracaine and Tetracaine Hydrochloride, 201
- OPHTHALMIC STAINS, 201
- COLLAGEN SHIELDS, 202
- TOPICAL OPHTHALMIC ANTIINFECTIVES, 202
 - Antiviral Agents, 202
 - Antifungal Agents, 202
 - Antibacterial Agents, 202
- TOPICAL OPHTHALMIC ANTIINFLAMMATORY AGENTS, 203
 - Nonsteroidal Agents, 203
 - Topical Corticosteroid Agents, 203
- AGENTS FOR THE TREATMENT OF KERATOCONJUNCTIVITIS SICCA, 204
 - Cyclosporine, 204
 - Artificial Tear Products and Ocular Lubricants, 204
- MISCELLANEOUS OPHTHALMIC AGENTS, 204
 - Anticollagenase Agents, 204
 - Viscoelastic Substances, 204
- Otic Drugs, 204
- TOPICAL OTIC ANTIINFECTIVE AGENTS, 205
 - Gentamicin Sulfate, 205
 - Chloramphenicol, 206
 - Neomycin Sulfate, 206
 - Enrofloxacin, 206
- ANTIPARASITICS, 206
 - Pyrethrins, 207
 - Rotenone, 207
 - Ivermectin/Milbemycin, 207
- DRYING AGENTS, 207
- CLEANING AGENTS, 207
- MISCELLANEOUS OTIC AGENTS, 208
 - Tris-EDTA, 208
 - Silver Sulfadiazine, 208
- 11 DRUGS USED IN SKIN DISORDERS, 210**
 - Introduction, 211
 - Anatomy and Physiology, 211
 - TOPICAL ANTISEBORRHEICS, 213
 - Sulfur, 213
 - Salicylic Acid, 213
 - Coal Tar, 215
 - Benzoyl Peroxide, 215
 - Selenium Sulfide, 215
 - TOPICAL MEDICATIONS MIXED WITH WATER, 215
 - Aluminum Acetate, 216
 - Magnesium Sulfate, 216
 - Bath Oils, 216
 - TOPICAL ANTIPRURITICS, 216
 - Nonsteroidal Antipruritics, 216
 - Topical Corticosteroids, 217
 - ASTRINGENTS, 217
 - ANTISEPTICS FOR THE SKIN, 217
 - Alcohols, 217
 - Propylene Glycol, 217
 - Chlorhexidine, 217
 - Acetic Acid, 218
 - Iodine, 218
 - Benzalkonium Chloride, 218
 - Wound Healing, 218
 - TOPICAL WOUND DRESSINGS, 219
 - Healing Stimulators, 219
 - Wound Cleansers, 219
 - Protectants, 220
 - OTHER DRUGS USED IN DERMATOLOGIC THERAPY, 220
 - Systemic Corticosteroids, 220
 - Topical Antibacterial Agents, 220
 - Topical Antifungal Agents, 221
 - Fatty Acid Supplements, 221
 - COUNTERIRRITANTS, 222
 - Vesication, 222
 - CAUSTICS, 223
 - MISCELLANEOUS DRUGS, 223
 - SELECTIVE IMMUNOSUPPRESSORS, 223
- 12 ANTIINFECTIVE DRUGS, 226**
 - Introduction, 227
 - Mechanism of Action, 227
 - PENICILLINS, 229
 - Pharmacokinetics, 229
 - Pharmacodynamics, 229
 - CEPHALOSPORINS, 232
 - Pharmacokinetics, 232
 - Pharmacodynamics, 233

- TETRACYCLINES, 234
 - Pharmacokinetics, 234
 - Pharmacodynamics, 234
- AMINOGLYCOSIDES, 236
 - Pharmacokinetics, 236
 - Pharmacodynamics, 237
- FLUOROQUINOLONES, 237
 - Pharmacokinetics, 237
 - Pharmacodynamics, 237
- OTHER ANTIINFECTIVES, 238
 - Chloramphenicol, 238
 - Florfenicol, 238
 - Macrolides and Lincosamides, 239
 - Vancomycin, 240
 - Spectinomycin, 240
 - Polymyxin B and Bacitracin, 240
 - Sulfonamides, 241
 - Nitrofurans, 241
 - Rifampin, 241
- ANTIFUNGAL DRUGS, 241
 - Polyene Antifungal Agents, 242
 - Imidazole Antifungal Agents, 242
 - Antimetabolic Antifungal Agents, 243
 - Superficial Antifungal Agents, 243
 - Other Antifungal Agents, 243
- ANTIVIRAL DRUGS, 243
 - Acyclovir, 244
 - Interferon Alfa-2A, Human Recombinant, 244
- DISINFECTANTS/ANTISEPTICS, 244
 - Alcohols, 244
 - Ethylene Oxide, 245
 - Formaldehyde, 246
 - Chlorines and Iodines, 246
 - Phenolics: Saponated Cresol, Semisynthetic Phenols, 246
 - Quaternary Ammonium Compounds:
 - Cationic Detergents, 247
 - Biguanide Compounds, 247
 - Other Disinfectants, 247
- 13 ANTIPARASITIC DRUGS, 250**
 - Introduction, 251
 - Endoparasites, 253
 - ANTINEMATODAL, 253
 - Benzimidazoles, 253
 - Organophosphates, 261
 - Tetrahydropyrimidines, 261
 - Imidazothiazoles, 262
 - Avermectins, 262
 - Other Agents, 263
 - ANTICESTODAL, 263
 - Bunamidine (Scolaban), 263
 - Epsiprantel (Cestex), 263
 - ANTITREMATODAL, 263
 - Clorsulon (Curatrem), 263
 - Albendazole (Valbazen), 264
 - Praziquantel (Droncit), 264
 - TOPICAL SOLUTIONS, 264
 - Emodepside/Praziquantel (Profender), 264
 - ANTIPROTOZOAL, 264
 - Drugs for Treating Coccidia and Other Protozoa, 264
 - Drugs for Treating Giardia, 264
 - Drugs for Preventing Giardia, 265
 - Drugs for Treating Babesia, 265
 - Heartworm Disease, 265
 - ADULTICIDES, 265
 - Melarsomine Dihydrochloride (Immiticide), 265
 - MICROFILARICIDES, 267
 - PREVENTIVES, 267
 - Imidacloprid + Moxidectin (Advantage Multi), 267
 - Ivermectin (Heartgard, Heartgard Plus, Heartgard for Cats), 267
 - Milbemycin Oxime (Interceptor, Sentinel), 267
 - Moxidectin (ProHeart), 267
 - Selamectin (Revolution), 268
 - Diethylcarbamazine Citrate (Carbam, Filaribits, Filaribits Plus), 268
 - Ectoparasites, 268
 - APPLICATION SYSTEMS, 268
 - Prediluted Sprays, 268
 - Emulsifiable Concentrates, 270
 - Monthly Flea and Tick Products, 271
 - INSECTICIDES, 272
 - Pyrethrins, 272
 - Synthetic Pyrethroids, 273
 - Chlorinated Hydrocarbons, 273
 - Carbamates, 273
 - Organophosphates, 273
 - Formamidines, 274
 - Nitenpyram (Capstar), 274
 - Synergists, 274
 - Repellents, 274

- Insect Growth Regulators (IGRs), Insect Growth Hormones), 274
 - Other Insecticides, 274
- 14 DRUGS USED TO RELIEVE PAIN AND INFLAMMATION, 277**
- Introduction, 278
 - Anatomy and Physiology, 279
 - NONSTEROIDAL ANTIINFLAMMATORY DRUGS, 281
 - Salicylates, 282
 - Pyrazolone Derivatives, 282
 - Flunixin Meglumine (Banamine), 283
 - Dimethyl Sulfoxide, 283
 - Buscopan Compositum, 284
 - Acetaminophen, 284
 - Propionic Acid Derivatives, 284
 - OTHER NONSTEROIDAL ANTIINFLAMMATORY DRUGS, 285
 - Etorolac, 285
 - Deracoxib, 285
 - Firocoxib, 286
 - Tepoxalin, 286
 - Meloxicam, 286
 - Polysulfated Glycosaminoglycan (Adequan), 286
 - Hyaluronate Sodium (Hyalovet), 286
 - Legend, 286
 - Meclofenamic Acid (Arquel Granules), 286
 - Selenium and Vitamin E (Seletoc), 286
 - Ketorolac, 286
 - Orgotein (Palosein), 286
 - OPIOID ANALGESICS, 286
 - Opioid Agonists, 287
 - Opioid Agonists-Antagonists, 287
 - Opioid Partial Agonists, 287
 - Other Pain Control Agents, 288
 - ANTIHISTAMINES, 288
 - H₁ Blockers, 289
 - H₂ Blockers, 289
 - MUSCLE RELAXANTS, 289
 - Methocarbamol (Robaxin-V), 289
 - Other Muscle Relaxants, 289
 - CORTICOSTEROIDS, 289
 - Injectables, 292
 - Oral, 292
 - Topical, 292
- 15 THERAPEUTIC NUTRITIONAL, FLUID, AND ELECTROLYTE REPLACEMENTS, 298**
- Introduction, 299
 - Anatomy, Physiology, and Chemistry, 299
 - Distribution of Body Water and Electrolytes, 299
 - Composition of Body and Therapeutic Fluids, 300
 - Osmotic Pressure and Tonicity of Fluids, 301
 - Principles of Fluid Therapy, 304
 - Indications for Fluid Therapy, 304
 - Fluid Balance, 305
 - History, Physical Examination, and Laboratory Findings, 305
 - Determining the Amount of Fluid to Administer, 305
 - Routes of Fluid Administration, 307
 - Rate of Administration, 308
 - Monitoring Fluid Administration, 309
 - Preparing Fluid Administration Equipment, 310
 - Types of Solutions Used in Fluid Therapy, 313
 - CRYSTALLOID SOLUTIONS, 313
 - Physiologic Saline, 313
 - Lactated Ringer's Solution, 313
 - Dextrose 5% in Water, 313
 - Ringer's Solution, 314
 - 2.5% Dextrose in Half-Strength (0.45%) Saline/Potassium Added, 314
 - Multisol-R/Normosol-R, 314
 - Normosol-M in 5% Dextrose, 314
 - Plasma-Lyte/Plasma-Lyte M in 5% Dextrose, 314
 - COLLOID SOLUTIONS, 314
 - HYPERTONIC SOLUTIONS, 315
 - FLUID ADDITIVES, 315
 - Sodium Bicarbonate, 315
 - Potassium Chloride, 316
 - Calcium Supplements, 316
 - 50% Dextrose, 317
 - Vitamin Supplements, 318
 - Oral Electrolyte Preparations, 318
 - Parenteral Nutrition, 319
 - Parenteral Vitamin/Mineral Products, 319

- WATER-SOLUBLE VITAMINS, 320
 Vitamin B Complex, 320
 Thiamine Hydrochloride (Vitamin B₁), 320
 Vitamin B₁₂ (Cyanocobalamin), 320
- FAT-SOLUBLE VITAMINS, 321
 Vitamin A, 321
 Vitamin D, 321
 Vitamin E, 321
 Vitamin K, 321
- 16 BLOOD-MODIFYING, ANTINEOPLASTIC, AND IMMUNOSUPPRESSANT DRUGS, 325**
 Introduction, 326
 Blood-Modifying Drugs/Agents, 326
 HEMATINICS, 326
 Iron Compounds, 327
 Erythropoietin, 328
 Androgens, 328
 Blood Substitutes, 328
 ANTICOAGULANTS, 329
 Heparin, 329
 Ethylenediaminetetraacetic Acid (EDTA), 331
 Coumarin Derivatives, 331
 Acid Citrate Dextrose (ACD) Solution and Citrate Phosphate Dextrose Adenine (CPDA-1), 331
 Antiplatelet Drugs, 332
 HEMOSTATICS/ANTICOAGULANT ANTAGONISTS, 332
 Topical Agents, 332
 Parenteral Agents, 332
 FIBRINOLYTIC (THROMBOLYTIC) DRUGS, 333
 Antineoplastic Drugs, 333
 Principles of Chemotherapy, 334
 ALKYLATING AGENTS, 336
 ANTHRACYCLINES, 336
 ANTIMETABOLITES, 340
 ANTITUBULIN AGENTS, 340
 MISCELLANEOUS ANTINEOPLASTIC DRUGS, 341
 Platinum Drugs, 341
 Asparaginase, 341
 Glucocorticoids, 341
 BIOLOGIC RESPONSE MODIFIERS, 342
 Monoclonal Antibodies, 342
 Interferon, 343
 Other Biologic Response Modifiers, 343
- IMMUNOSUPPRESSIVE DRUGS, 344
 Azathioprine, 344
 Cyclosporine, 344
 Metronidazole, 345
 Cyclophosphamide, 345
 Corticosteroids, 345
 Other Immunosuppressive Agents, 345
- 17 IMMUNOLOGIC DRUGS, 348**
 Principles of Vaccination, 349
 Common Vaccine Types That Produce Active Immunity, 351
 INACTIVATED, 351
 LIVE, 351
 MODIFIED LIVE, 351
 RECOMBINANT, 352
 TOXOID, 352
 Common Vaccine Types That Produce Passive Immunity, 353
 ANTITOXIN, 353
 ANTISERUM, 353
 Other Types of Vaccines, 353
 AUTOGENOUS VACCINE, 353
 MIXED VACCINE, 353
 Administration of Vaccines, 354
 Biologic Care and Vaccine Failure, 355
 Adverse Vaccination Responses, 355
 Vaccinations for Preventive Health Programs, 356
 Canine, 356
 Equine, 356
 Feline, 356
 Bovine, 358
 Others, 364
 Immunotherapeutic Drugs, 365
 IMMUNOSTIMULANTS, 366
 Complex Carbohydrates, 366
 Immunomodulatory Bacterins, 366
- 18 MISCELLANEOUS THERAPEUTIC AGENTS, 369**
 Alternative Medicines, 370
 CHONDROPROTECTIVES, 370
 Polysulfated Glycosaminoglycans, 370
 NUTRACEUTICALS, 370
 Glucosamine and Chondroitin Sulfate, 372
 Fatty Acids, 372
 S-Adenosylmethionine (SAMe), 372

- Superoxide Dismutase, 372
 - Coenzyme Q, 372
 - HERBAL MEDICINES, 372
 - Summary of Herbal Medicines, 374
 - MISCELLANEOUS ANTIDOTES, 376
 - Activated Charcoal, 376
 - Calcium EDTA, 376
 - Methylene Blue, 377
 - Acetylcysteine, 377
 - Dimercaprol, 378
 - Pralidoxime Chloride, 378
 - Penicillamine, 378
 - Sodium Thiosulfate, 379
 - Ethanol, 379
 - Fomepizole, 379
 - Antivenin Polyvalent (*Crotalidae*)/Antivenin (*Micruis fulvius*) Coral Snake, 380
 - Vitamin K₁ (Phytonadione), 380
 - Thiamine HCl, 380
 - REVERSAL AGENTS, 380
 - Atipamezole HCl, 380
 - Flumazenil, 380
 - Naloxone HCl, 381
 - Tolazoline HCl, 381
 - Yohimbine HCl, 381
 - LUBRICANTS, 381
- 19 INVENTORY: THE VETERINARY TECHNICIAN'S ROLE, 385**
- Introduction, 386
 - Inventory, 387
 - THE TIME EQUATION, 388
 - TURNOVER, 390
 - Calculating Turnover Rate, 390
 - Controlling Inventory, 390
 - PROACTIVE INVENTORY CONTROL SYSTEM, 391
 - KEEPING ACCURATE RECORDS, 391
 - INVENTORY RECORDS, 394
 - Reorder Quantity, 397
 - Rabies Vaccine, 397
 - ORGANIZING INVENTORY, 397
 - Pharmacy and ICM Office, 397
 - Organizing Inventory in the Veterinary Hospital, 399
 - Staff Memos, 399
 - Special Conditions, 399
 - PHYSICAL INVENTORY, 399
 - Monthly Inventory Versus Rotating Inventory, 399
 - PURCHASING INFORMATION, 401
 - Incoming Freight, 401
 - FOB Rules and Shipment Contracts, 402
 - Receiving Freight, 402
 - Stocking Shelves, 403
 - Vendors, 403
 - Communicating With Sales Representatives, 404
 - DEA Forms, 404
 - Special Orders, 404
 - Human Pharmacy, 404
 - COMPUTERS AND INVENTORY, 404
 - THE JOB OF ICM, 405
- APPENDIX A COMMON ABBREVIATIONS USED IN VETERINARY MEDICINE, 409**
- APPENDIX B WEIGHTS AND MEASURES, 411**
- APPENDIX C RESOURCE INFORMATION, 413**
- APPENDIX D CONTROLLED SUBSTANCES INFORMATION SUMMARY, 417**
- BIBLIOGRAPHY, 421**
- REVIEW QUESTION ANSWERS, 425**
- GLOSSARY, 439**

This page intentionally left blank

APPLIED PHARMACOLOGY
for Veterinary Technicians

Fourth Edition

This page intentionally left blank

- Oral
- Parenteral
- Inhalation
- Topical
- Drug Absorption
- Drug Distribution
- Biotransformation
- Drug Excretion
- Pharmacodynamics
- Drug Interactions
- Drug Names
- Drug Labels
- Development and Approval of New Drugs
- Regulatory Agencies
 - The Food Animal Residue Avoidance Databank
- Steps in the Development of a New Drug
 - Preliminary Trials
 - Preclinical (Animal Safety) Trials
 - Clinical Trials
 - Submission of a New Animal Drug Application
 - Final Review by the FDA
 - Product Monitoring
 - The Green Book
- Federal Laws Related to Drug Development and Use
- The Animal Medicinal Drug Use Clarification Act
- Compounding of Veterinary Drugs
- The Veterinary Feed Directive
- The Minor Use and Minor Species Animal Health Act
- Dispensing Versus Prescribing Drugs
- Marketing of Drugs

CHAPTER 1

General Pharmacology

LEARNING OBJECTIVES

After studying this chapter, you should be able to:

1. Define terms related to general pharmacology.
2. List common sources of drugs used in veterinary medicine.
3. Outline the basic principles of pharmacotherapeutics.
4. Define the difference between prescription and over-the-counter drugs.
5. Describe the events that occur after a drug is administered to a patient.
6. List and describe the routes used for administration of drugs.
7. Define *biotransformation*, and list common chemical reactions involved in this process.
8. List the routes of drug excretion.
9. Discuss in basic terms the mechanisms by which drugs produce their effects in the body.
10. Discuss the mechanisms of clinically important drug interactions.
11. Discuss the different names that a particular drug is given.
12. List the items that should be included on a drug label.
13. List the steps and discuss the processes involved in gaining approval for a new drug.
14. List the government agencies involved in the regulation of animal health products.
15. Describe reasons for dispensing rather than prescribing drugs in veterinary medicine.
16. Discuss the primary methods of drug marketing.



KEY TERMS

ADVERSE DRUG REACTION An undesirable response to a drug by a patient. It may vary in severity from mild to fatal.

AGONIST A drug that brings about a specific action by binding with the appropriate receptor.

ANTAGONIST A drug that inhibits a specific action by binding with a particular receptor.

COMPOUNDING Any manipulation (e.g., diluting, combining) performed to produce a dosage-form drug, other than the manipulations described in the directions for use on the labeling of an approved drug product.

DRUG A substance used to diagnose, prevent, or treat disease.

EFFICACY The extent to which a drug causes the intended effects in a patient.

EXTRALABEL USE The use of a drug that is not specifically listed on the U.S. Food and Drug Administration (FDA)-approved label.

HALF-LIFE The amount of time (usually expressed in hours) that it takes for the quantity of a drug in the body to be reduced by 50%.

MANUFACTURING The bulk production of drugs for resale outside of the veterinarian-client-patient relationship.

METABOLISM (BIOTRANSFORMATION) The biochemical process that alters a drug from an active form to a form that is inactive or that can be eliminated from the body.

PARENTERAL The route of administration of injectable drugs.

PARTITION COEFFICIENT The ratio of the solubility of substances (e.g., gas anesthetics) between two states in which they may be found (e.g., blood and gas, gas and rubber goods).

PRESCRIPTION (LEGEND) DRUG A drug that is limited to use under the supervision of a veterinarian because of potential danger, difficulty of administration, or other considerations. The legend that designates a prescription drug states the following: "Caution: Federal law restricts this drug to use by or on the order of a licensed veterinarian."

REGIMEN A program for administration of a drug that includes the route, the dose (how much), the frequency (how often), and the duration (for how long) of administration.

RESIDUE An amount of a drug still present in animal tissue or products (e.g., meat, milk, eggs) at a particular point (slaughter or collection).

VETERINARIAN-CLIENT-PATIENT RELATIONSHIP

The set of circumstances that must exist between the veterinarian, the client, and the patient before the dispensing of prescription drugs is appropriate.

WITHDRAWAL TIME The length of time it takes for a drug to be eliminated from animal tissue or products after it is no longer used.

INTRODUCTION

Veterinary technicians are an essential component of the efficient health care delivery team in veterinary medicine. One of the important tasks that veterinary technicians carry out is administration of **drugs** to animals on the order of a veterinarian. Because this task may have serious consequences in terms of the outcome of a case, it is mandatory that technicians have a thorough knowledge of the types and actions of drugs used in veterinary medicine. They should have an understanding of the reasons for using drugs, called *indications*, and the reasons for not using drugs, called *contraindications* (pharmacotherapeutics). They also should know what happens to drugs once they

enter the body (pharmacokinetics), how drugs exert their effects (pharmacodynamics), and how adverse drug reactions manifest themselves (toxicity). Because veterinarians dispense a large number of drugs, technicians also must be well versed in the components of a valid **veterinarian-client-patient relationship**, the importance of proper labeling of dispensed products, and methods of client education on the proper use of products to avoid toxic effects or residue. Finally, technicians should have a basic understanding of the laws that apply to drug use in veterinary medicine and the concept of the marketing of veterinary drugs. In short, veterinary technicians must have a working knowledge of the science of veterinary pharmacology.

DRUG SOURCES

Traditional sources of drugs are plants (botanical) and minerals. Plants have long been a source of drugs. The active components of plants that are useful as drugs include alkaloids, glycosides, gums, resins, and oils. The names of alkaloids usually end in *-ine*, and the names of glycosides end in *-in* (Williams and Baer, 1990). Examples of alkaloids include atropine, caffeine, and nicotine. Digoxin and digitoxin are examples of glycosides. Bacteria and molds (e.g., *Penicillium*) produce many of the antibiotics (penicillin) and anthelmintics (ivermectin) in use today. Animals once were important as a source of hormones such as insulin, and as a source of anticoagulants such as heparin. Today, most hormones are synthesized in a laboratory. Mineral sources of drugs include electrolytes (sodium, potassium, and chloride), iron, selenium, and others. Laboratories are one of the most important sources of currently used drugs because chemists are finding methods of reproducing drugs previously obtained through plant and animal sources. Advances in recombinant deoxyribonucleic acid (DNA) technology have made it possible for animal and human products (e.g., insulin) in bacteria to be produced in large quantities.

INACTIVE INGREDIENTS

Veterinary pharmaceutical products and supplements may contain substances in addition to active ingredients. Inactive ingredients are classified as binders, coatings, coloring agents, disintegrants, emulsifiers, fillers, flavorings, flow agents, humectants, preservatives, sweeteners, and thickeners (Table 1-1).

PHARMACOTHERAPEUTICS

Veterinarians are challenged by the task of assessing a patient to determine a diagnosis and arrive at a plan of treatment. If the plan of treatment includes the use of drugs, the veterinarian must choose an appropriate drug and a drug regimen. The drug is selected through the use of one or more broadly defined methods

called *diagnostic*, *empirical*, or *symptomatic*. The diagnostic method involves assessment of a patient, including a history, physical examination, laboratory tests, and other diagnostic procedures, to arrive at a specific diagnosis. Once the diagnosis has been determined, the causative microorganism or altered physiologic state is revealed to allow selection of the appropriate drug. The empirical method calls on the use of practical experience and common sense when the drug choice is made. In other instances, drugs are chosen to treat the symptoms or signs of a disease if a specific diagnosis cannot be determined. In veterinary medicine, the comparative cost of a drug also may be an important consideration in selection of an appropriate drug. Once the drug to be used in treatment has been decided, the next step for the veterinarian is to design the plan for administering the drug. This plan, called a **regimen**, includes details about the following:

- The route of administration
- The amount to be given (dosage)
- How often the drug is to be given (frequency)
- How long the drug will be given (duration)

Every drug has the potential to cause harmful effects if it is given to the wrong patient or according to the wrong regimen. Some medications have greater potential than others for producing harmful outcomes. According to the U.S. Food and Drug Administration (FDA), when a drug has potential toxic effects or must be administered in a way that requires the services of trained personnel, that drug cannot be approved for animal use except when given under the supervision of a veterinarian. In such a case, the drug is classified as a **prescription drug** and must be labeled with the following statement: "Caution: Federal law restricts the use of this drug to use by or on the order of a licensed veterinarian." This statement sometimes is referred to as the *legend*, and the drug is called a *legend (prescription) drug*. Labels that state "For veterinary use only" or "Sold to veterinarians only" do not designate prescription drugs. Technicians should be aware that prescription drugs often have been approved by the FDA for use in specific species or for particular diseases or conditions. Veterinarians have some discretion to use a drug in ways not indicated

Table 1-1 Inactive Ingredients

Inactive Ingredient	Function	Examples
Binder	Holds tablet together	Cellulose, lactose, methylcellulose, sorbitol, starch, xylitol, and others
Coating	Protects tablet from breaking, absorbing moisture, and early disintegration	Beeswax, carob extract, methylcellulose, cellulose acetate, acrylic resin, and others
Coloring agents	Provide color and enhance appearance	Yellow No. 5, annatto, caramel color, titanium oxide, FD&C Blue No. 1, FD&C Red No. 3, and others
Disintegrants	Expand when exposed to liquid, allowing tablets and capsules to dissolve and disperse their active ingredients	Cellulose products, crospovidone, sodium starch glycolate, and starch
Emulsifiers	Allow fat-soluble and water-soluble agents to mix, so they do not separate	Stearic acid, xanthan gum, lecithin, and vegetable oils
Fillers/diluents	Increase bulk or volume	Calcium carbonate, calcium sulfate, cellulose lactose, mannitol, sorbitol, starch, sucrose, and vegetable oils
Flavor agents	Create a desired taste or mask an undesired taste	Beeswax, carob extract, glyceryl triacetate, and natural orange
Flow agents	Prevent powders from sticking together	Calcium stearate, glyceryl triacetate, polyethylene glycol, silica, sodium benzoate, and talc
Humectants	Hold moisture in a product	Glycerin, glycerol, glycerol triacetate, and sorbitol
Preservatives	Prevent degradation and extend the shelf life of a product	Citric acid, glycerol, potassium benzoate, sodium benzoate, and others
Sweetening agents	Improve taste	Aspartate, fructose, glycerin, sorbitol, sucrose, and xylitol
Thickening agents	Increase the viscosity of a product	Methylcellulose, povidone, sorbitol, and others

Adapted from "Review Article: Inactive Ingredients in Supplements," 2007, ConsumerLab.com.

by the label, if they take responsibility for the outcome of use. Use of a drug in a way not specified by the label is called **extralabel use**.

Federal law and sound medical practices dictate that prescription drugs should not be dispensed indiscriminately. Before prescription drugs are issued or extralabel use is undertaken, a valid veterinarian-client-patient relationship must exist. For this relationship to occur, several conditions must be met. These include, but are not limited to, the following:

- The veterinarian has assumed responsibility for making clinical judgments about the health of the animal(s) and the need for treatment, and

the client has agreed to follow the veterinarian's instructions.

- The veterinarian has sufficient knowledge of the animal(s) to issue a diagnosis. The veterinarian must have seen the animal recently and must be acquainted with its husbandry.
- The veterinarian must be available for follow-up evaluation of the patient.

Drugs that do not have enough potential to be toxic or that do not require administration in special ways do not require the supervision of a veterinarian for administration. These drugs are called *over-the-counter* drugs because they may be purchased without a prescription. Drugs that have the

potential for abuse or dependence have been classified as *controlled substances*. Careful records of the inventory and use of these drugs must be maintained, and some of them must be kept in a locked storage area.

When a drug and its regimen have been selected, veterinary technicians often are directed through verbal or written orders to administer the drug. Technicians have several important responsibilities in carrying out these orders:

1. Making sure that the correct drug is being administered
2. Administering the drug by the correct route and at the correct time
3. Carefully observing the animal's response to the drug
4. Questioning any medication orders that are not clear
5. Creating and affixing labels to medication containers accurately
6. Explaining administration instructions to clients
7. Recording appropriate information in the medical record

Technicians should be aware that even when the correct drug is administered in a correct manner, an unexpected adverse reaction might occur in a patient. All adverse reactions should be reported immediately to the veterinarian.

PHARMACOKINETICS

Pharmacokinetics is the complex sequence of events that occurs after a drug is administered to a patient (Figure 1-1). Once a drug has been given,

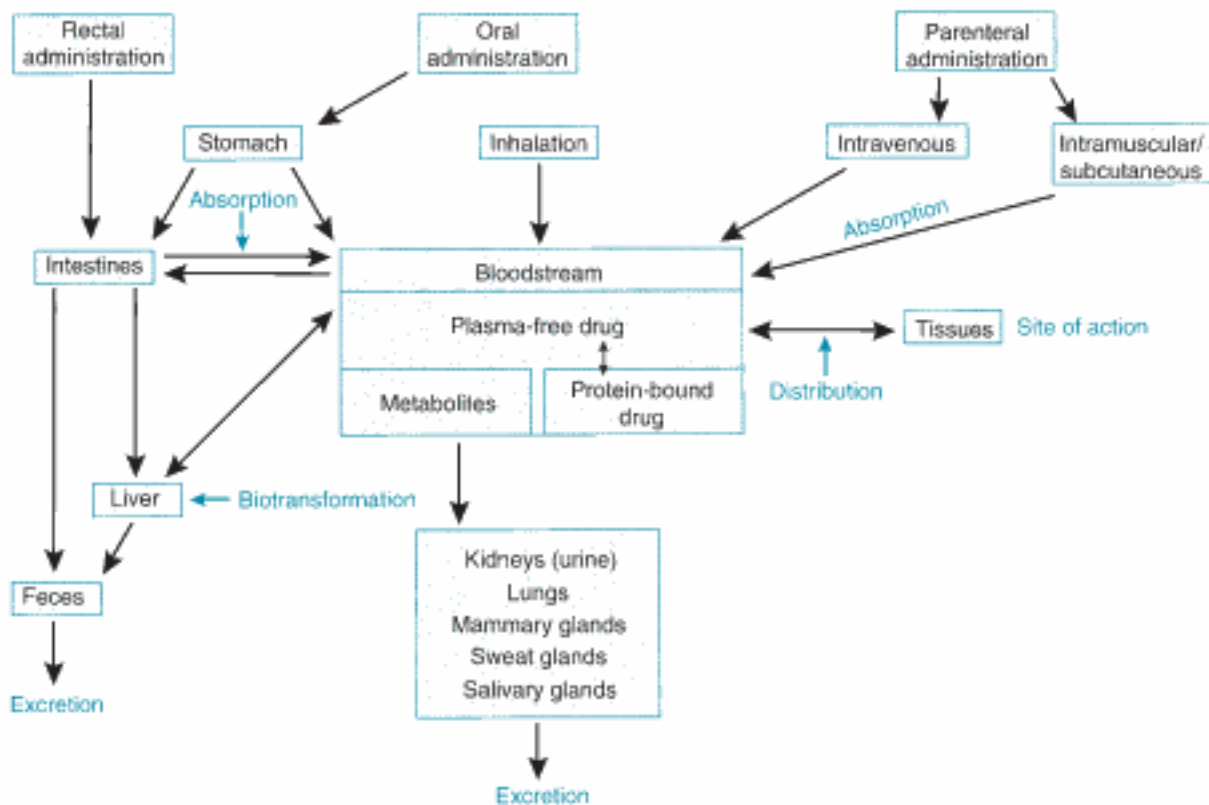

FIGURE 1-1

Outline of the possible sequence of events that a drug may follow in an animal's body.

it is available for absorption into the bloodstream and delivery to the site where it will exert its action. After a drug is absorbed, it is distributed to various fluids and tissues in the body. It is not enough for the drug simply to reach the desired area, however. It also must accumulate in that fluid or tissue at the required concentration to be effective. Because the body immediately begins to break down and excrete the drug, the amount available to the target tissue becomes less and less over time. The veterinarian then must administer the drug repeatedly and at fixed time intervals to maintain the drug at the site of action in the desired concentration. Some drugs are administered at a high dose (loading dose) until an appropriate blood level is reached. Then the dose is reduced to an amount that replaces the amount lost through elimination. Doses of other drugs are at the replacement level throughout the regimen. The point at which drug accumulation equals drug elimination is called the *steady state*. Underdosing leads to less-than-effective levels in tissue, and overdosing may result in toxic levels (Figure 1-2). Drug levels can be measured in blood, urine, cerebrospinal fluid, and other appropriate body fluids to help a veterinarian determine whether an appropriate level has been achieved. This procedure, which is called *therapeutic drug monitoring*, is being used increasingly in veterinary practice. Nonsteroidal antiinflammatory drugs (NSAIDs), cardiac

drugs, anticonvulsants, and thyroid drugs are commonly monitored.

The primary factors that influence blood concentration levels of a drug and a patient's response to it include the following:

1. Rate of drug absorption
2. Amount of drug absorbed
3. Distribution of the drug throughout the body
4. Drug metabolism or biotransformation
5. Rate and route of excretion

These factors are explored after the drug administration routes have been discussed.

Routes of Administration

A drug is of no use unless it can be delivered to the patient in an appropriate form at an appropriate site. The way in which a drug is administered to an animal patient is influenced by several factors:

- Available pharmaceutical form of the drug
- Physical or chemical properties (irritation) of the drug
- How quickly onset of action should occur
- Use of restraint or behavioral characteristics of the patient
- Nature of the condition being treated

The routes of administration of drugs to animal patients are discussed next.

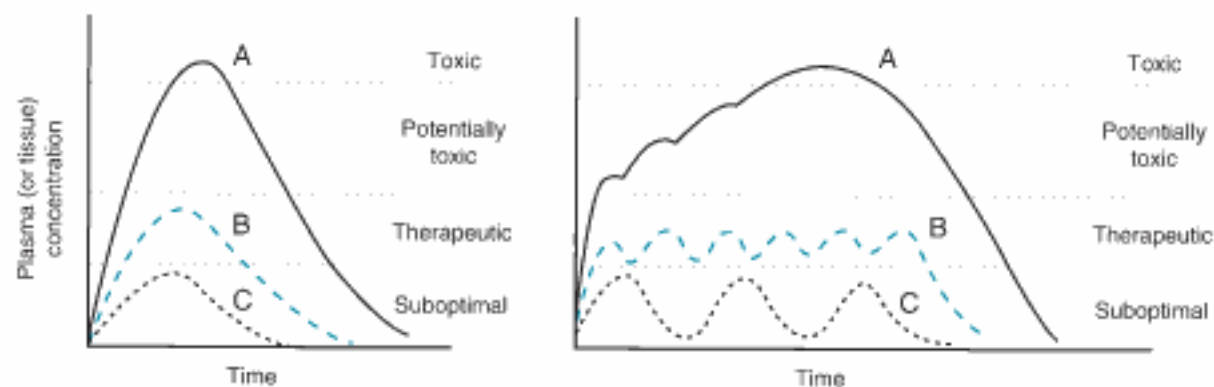

FIGURE 1-2

The effect of dose amounts on the effectiveness of a drug. (From Jenkins WL: In Ettinger SJ, editor: *Textbook of veterinary internal medicine, diseases of the dog and cat*, Philadelphia, 1983, WB Saunders.)

ORAL

In veterinary medicine, drugs commonly are administered through the oral route. Medications given by this route may be placed directly in the mouth or may be given via a tube passed through the nasal passages (nasogastric tube) or through the mouth (orogastric tube). The mucosa of the digestive tract is a large absorptive surface area with a rich blood supply. Drugs given by this route, however, are not absorbed as quickly as drugs administered by injection, and their effects are subject to species (e.g., ruminants vs. animals with a simple stomach) and individual differences. Many factors may influence the absorption of drugs from the digestive tract, including the pH of the drug, its solubility (fat vs. water), the size and shape of the molecule, the presence or absence of food in the digestive tract, the degree of gastrointestinal (GI) motility, and the presence and nature of disease processes. *This route is not suitable for animals that are vomiting or have diarrhea.* Drugs given by this route generally produce a longer-lasting effect than those given by injection.

PARENTERAL

Drugs that are given by injection are called **parenteral** drugs. A drug can be injected via many different routes:

- Intravenous (IV)
- Intramuscular (IM)
- Subcutaneous (SC)
- Intradermal (ID)
- Intraperitoneal (IP)
- Intraarterial (IA)
- Intraarticular
- Intracardiac
- Intramedullary
- Epidural/subdural

Drugs given by the intravenous route produce the most rapid onset of action, accompanied by the shortest duration. Medications that are irritating to tissue generally are given by this route because of the diluting effect of blood. Intravenous medications should be administered slowly to lessen the possibility of a toxic or allergic reaction. Unless a product is specifically labeled for intravenous use, it

should never be given by this route. Oil-based drugs and those with suspended particles (i.e., those that look cloudy or thick) generally should not be given intravenously because of the possibility of an embolism. Special care should be taken to ensure that irritating drugs are injected into the vein and not around it, to avoid causing phlebitis.

The intramuscular route of administration produces a slower onset of action than the intravenous route but usually provides a longer duration of action. The onset of action by this route can be relatively fast with a water-based form (aqueous) and is slower with other diluents (vehicles) such as oil or with other forms such as microfine crystals. When an injectable drug is placed in a substance that delays its absorption, this may be referred to as a *depot* preparation. Altering the molecule of the drug itself can influence its onset or duration of action. Onset of action usually is inversely related to duration of action. Irritating drugs should not be given by the intramuscular route, and back pressure always should be applied to the syringe plunger before intramuscular administration of a drug to ensure that the injection is not directed into a blood vessel.

In some texts, the subcutaneous route has been called *hypodermoclysis*. It produces a slower onset of action but a slightly longer duration than the intramuscular route. Irritating or hyperosmotic solutions (i.e., those with a greater number of suspended particles than are found in body fluid) should not be given by this route.

Quantities of medications that are appropriate for the species or individual being treated should be used to prevent possible dissection of the skin from underlying tissue, which could lead to death and loss (sloughing) of surface skin. Adding an enzyme called *hyaluronidase* to a drug that is given subcutaneously may speed its absorption.

The intradermal route involves injecting a drug into the skin. This route is used in veterinary medicine primarily for testing for tuberculosis and allergic conditions.

The intraperitoneal route is used to deliver drugs into the abdominal cavity. The onset and duration of action of drugs given by this route are variable. This route is used to administer fluids, blood, and other medications when normal routes are not

available or are not practical. Problems such as adhesions and puncture of abdominal organs may be caused by this method.

The intraarterial route involves injecting a drug directly into an artery. This route seldom is used intentionally, but this may happen by mistake. Administration of drugs into the jugular vein of a horse must be done with caution to avoid injection into the underlying carotid artery. Intracarotid injection into an animal results in delivery of a high concentration of the drug directly to the brain, and seizures or death may result.

Through the intraarticular route, a drug is injected directly into a joint. This method is used primarily to treat inflammatory conditions of the joint. Extreme care must be exercised to ensure that sterile technique is used when an intraarticular injection is given. Technicians usually do not use this route.

The intracardiac route is used to inject drugs through the chest wall directly into the chambers of the heart. This provides immediate access to the bloodstream and ensures that the drug is delivered quickly to all tissue in the body. This method is often used in cases of cardiopulmonary resuscitation and in euthanasia.

The intramedullary route is another route that is seldom used in veterinary medicine. It involves injection of the substance directly into the bone marrow. The bones used most often are the femur and the humerus. The intramedullary route usually is used to provide blood or fluids to animals with very small or damaged veins, or for treatment of animals with very low blood pressure.

When spinal anesthesia is provided, drugs may be injected into the epidural or subdural space. The epidural space is outside the dura mater (meninges) but inside the spinal canal. The subdural space is inside the dura mater. Injection of drugs into the subdural space (cerebrospinal fluid) is also called the *intrathecal route*. A veterinarian usually carries out these methods of drug delivery.

INHALATION

Medications may be delivered to a patient in inspired air by converting a liquid form into a gaseous form through the use of a vaporizer or nebulizer. Examples

of drugs that may be given by this route include anesthetics, antibiotics, and bronchodilators.

TOPICAL

Drugs that are administered topically are placed on the skin or on mucous membranes. Drugs generally are absorbed more slowly through the skin than through other body membranes. The rate of absorption may be increased or absorption facilitated by placement of the drug in a vehicle such as dimethyl sulfoxide (DMSO). Medication also may be applied to the mucosa of the oral cavity (sublingual), the rectum (suppositories), the uterus, the vagina, the mammary glands, the eyes, and the ears. In horses, caustic materials may be applied topically to inhibit the growth of exuberant granulation tissue (proud flesh).

Transdermal drug administration is a form of topical administration that involves the use of a patch applied to the skin to deliver a drug through intact skin directly into the blood. This method is used most commonly to administer an analgesic in a slow, continuous manner or to administer compounded drugs to animals when oral administration may be difficult (e.g., cats).

Drug Absorption

Before drugs can reach their site of action, they must pass across a series of cellular membranes that make up the absorptive surfaces of the sites of administration. The degree to which a drug is absorbed and reaches the general circulation is called *bioavailability*.

The **manufacturing** process can have a significant effect on the physical and chemical characteristics of drug molecules that influence their bioavailability. Because of manufacturing differences, the generic form of a drug may differ somewhat from a trademark form in overall efficacy. Bioavailability often is demonstrated with the use of a blood level curve (Figure 1-3). Factors that may affect the absorption process include the following (Upson, 1988; Boothe, 2001):

- Mechanism of absorption
- pH and ionization status of the drug
- Absorptive surface area

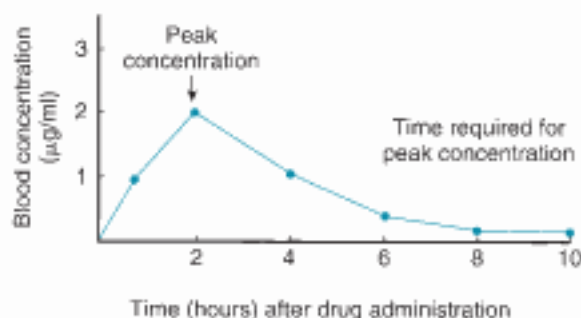

FIGURE 1-3

The blood level of a drug varies with the passage of time.

- Blood supply to the area
- Solubility of the drug
- Dosage form
- Status of the GI tract (motility, permeability, and thickness of the mucosal epithelium)
- Interaction with other medications

Drugs pass across cellular membranes through three common methods. Passive absorption (transport) occurs by simple diffusion of a drug molecule from an area of high concentration of drug on one side of the membrane to an area of lower concentration on the other side. This method requires no expenditure of energy by the cell. The drug may pass through small pores in the cell membrane or may dissolve into the cell membrane on one side, pass through the membrane, and exit on the other side. For example, a disintegrated tablet or capsule results in a high concentration of drug in the GI tract. This concentration then passes through the cellular membranes of intestinal villi and adjacent capillaries, and the drug then appears in lesser concentration in the bloodstream. Alternatively, a drug may cross a membrane passively with the help of a carrier.

Some small drug molecules such as electrolytes may simply move with fluid through pores in cell membranes. Active transport of drugs across cell membranes moves molecules from an area of lower concentration to an area of higher concentration and requires that the cell use energy. This is the usual mechanism for the absorption of sodium, potassium, and other electrolytes. In pinocytosis, a third method of passive transport, cells engulf drug molecules by invaginating their cell membrane to

form a vesicle that then breaks off from the membrane in the interior of the cell. The method of absorption that occurs in a particular situation depends on whether the drug is fat soluble or water soluble, the size and shape of the drug molecule, and the degree of ionization of the drug.

Many drugs can pass through a cell membrane only if they are nonionized (i.e., not positively or negatively charged). Most drugs exist in the body in a state that consists of both ionized and nonionized forms. The pH of a drug and the pH of the area in which the drug is located can determine the degree to which a drug becomes ionized and thus is absorbed. Weakly acidic drugs in an acidic environment do not ionize readily and therefore are absorbed well. The absorption of basic drugs is more favorable in an alkaline environment. If a drug is placed in an environment in which it readily ionizes such as a mildly acidic drug in an alkaline environment or a mildly alkaline drug in an acidic environment, it does not diffuse and may become trapped in that environment.

As the absorptive surface of the area of drug placement increases, so does the rate of absorption. One of the largest absorptive surfaces in the body is found in the small intestine because the efficient design of the villi maximizes the surface area.

At any site of drug administration, as the blood supply to an area increases, so does the rate of absorption of the drug. Drugs are absorbed from an intramuscular site at a faster rate than from a subcutaneous site because of the proportionately greater blood supply to the muscle. Initiating the fight-or-flight response increases blood flow to the muscle but decreases blood flow to the intestines. Heat and massage also increase blood flow to an area. Poor circulation, which may occur during shock or cardiac failure, decreases blood flow, as does cooling or elevation of a body part. These factors then can positively or negatively influence drug absorption.

Another important factor that determines the rate at which drugs pass across cell membranes is the solubility of the drug. The lipid (fat) solubility of a drug tends to be directly proportional to the degree of drug nonionization. As was stated previously, the nonionized form is the one that usually is

absorbed. The degree of lipid solubility of a drug often is expressed as its lipid **partition coefficient**. A high lipid partition coefficient indicates enhanced drug absorption.

Drug absorption rates often depend on the formulation of the drug. Various inert ingredients, such as carriers (vehicles), binding agents, and coatings, are used to prepare dosage forms. These substances have major effects on the rate at which formulations dissolve. *Depot* and *spanule* are terms that are associated with prolonged- or sustained-release formulations in veterinary medicine. Subcutaneous implants that contain growth stimulants that break down slowly and release their products over prolonged periods are used in some situations.

When drugs are given orally, the condition of the GI tract can have a major influence on the rate and extent of drug absorption. Factors such as degree of intestinal motility, emptying time of the stomach, irritation or inflammation of the mucosa (e.g., gastritis, enteritis), damage to or loss of villi (e.g., viral diseases), composition and amount of food material, and changes in intestinal microorganisms can affect the rate and extent of absorbance of medications. Another consideration regarding drugs that are absorbed from the GI tract is the first-pass effect (see Figure 1-6). This refers to the fact that substances are absorbed from the GI tract into the portal venous system, which delivers the drug to the liver before it enters the general circulation. In some instances, a drug then is metabolized in the liver to altered forms; this process may make the drug inactive or less active.

The process of combining some drugs with other drugs or with certain foods can negatively affect drug absorption. The availability of tetracycline is reduced if it is administered with milk or milk products. Antacids may reduce the absorption of phenylbutazone or iron products. Technicians always should consult appropriate references about potential interactions before administering new drugs.

Drug Distribution

Drug distribution is the process by which a drug is carried from its site of absorption to its site of action. Drugs move from the absorption site into the plasma of the bloodstream, out of the plasma into

the interstitial fluid that surrounds cells, and from the interstitial fluid into the cells, where they combine with cellular receptors to create an action. Equilibrium soon is established between these three compartments while the drug moves out of the blood into the tissue and then out of the tissue back into the blood (Figure 1-4). How well a drug is distributed throughout the body depends on several factors.

The rate of movement of drug molecules from one of the previously listed compartments to the other is proportional to the differences between the amounts of drug in all areas. The difference between the amounts of drug in two compartments is called the *concentration gradient*, and as the gradient increases (difference), so does the tendency of the drug to move from the area of higher concentration to the area of lower concentration.

A drug within the plasma comes into contact with various proteins (e.g., albumin) and binds with them or remains free. When a drug is bound to a protein, it becomes inactive and is unavailable for binding with cell receptors or for metabolism. A bound drug may be regarded as a storage site of a drug because a bound drug eventually frees itself from the protein. Low levels of plasma proteins may occur in malnutrition or in certain diseases, and plasma binding may be reduced.

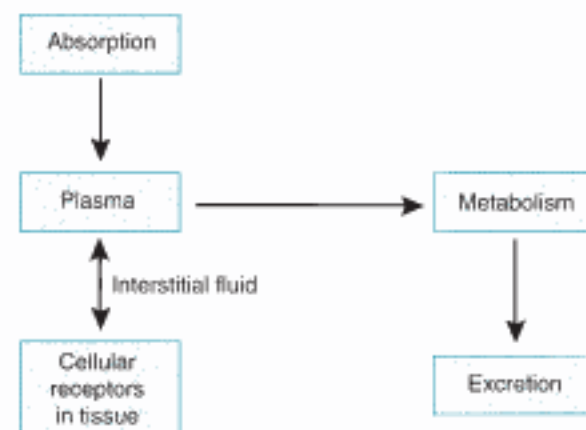

FIGURE 1-4

Drug distribution establishes an equilibrium between the amount of drug at the site of absorption, the amount in the plasma, and the amount at the cellular receptor sites.

Drugs that are highly lipid soluble tend to move readily out of the plasma and into the interstitial fluid. Drugs in the nonionized form follow a similar pattern. Once a drug is present in a tissue, it may become bound or stored there. Tissues such as fat, liver, kidney, and bone may act as storage sites for drugs such as barbiturates, inhalation anesthetics, and others. When a drug moves out of the storage tissue back into the blood, and additional doses are given, an exaggerated or prolonged effect may result because of the additive effects.

Barriers that exist in particular tissues tend to retard the movement of all or certain classes of drugs into them. The exact nature of these barriers has not been well explained in the literature. The placenta acts as a barrier to some drugs that could be toxic to a fetus and permits the passage of others. Anesthetics that do not excessively depress a fetus must be chosen when a cesarean section is performed. The so-called blood-brain barrier is generally minimally permeable to all drugs, although it becomes relatively permeable to many antibiotics upon inflammation. A defect in the p-glycoprotein drug transporter in the blood-brain barrier has been identified in individuals of several dog breeds including collies, Old English sheepdogs, Australian shepherds, Shetland sheepdogs, and English shepherds. The eye also has a barrier that impedes some drugs from diffusing into its tissue.

Disease processes can interfere with drug distribution. Antibiotics usually do not diffuse well into abscesses or exudates. Heart failure and shock can reduce normal blood flow to tissue and thus impede drug distribution. Kidney failure (uremia) can alter the plasma binding of some drugs such as furosemide and phenylbutazone. Liver failure can cause a reduction in the amount of protein (albumin) available for protein binding.

Some clinicians believe that reptiles have a renal-portal system that can distribute potentially toxic levels of a drug to the kidney if the drug is injected into the posterior one third of the body.

Biotransformation

Biotransformation, or **metabolism**, is the body's ability to change a drug chemically from the form in which it was administered into a form that can

be eliminated from the body. Most biotransformation occurs in the liver because of the action of microsomal enzymes found in liver cells. These enzymes induce chemical reactions that render a drug water soluble, allowing its subsequent elimination in the urine. Once a drug has been biotransformed, it is called a *metabolite*. Metabolites are usually inactive but in some cases may be active. A few highly lipid-soluble drugs are incorporated into bile and are eliminated through the biliary system. Some biotransformation does occur in other tissues such as the kidney, lung, and nervous system.

The following four chemical reactions are induced by microsomal enzymes in the liver to biotransform drugs:

1. Oxidation—loss of electrons
2. Reduction—gain of electrons
3. Hydrolysis—splitting of the drug molecule with the addition of a water molecule to each of the split portions
4. Conjugation—the addition of glucuronic acid to the drug molecule; when glucuronic acid is attached to a drug molecule, the drug becomes much more water soluble

Many factors, including species, age, nutritional status, tissue storage, and health status, can alter drug metabolism. Cats have limited ability to metabolize aspirin, narcotics, and barbiturates because of their reduced ability to form glucuronic acid. Young animals usually have poor ability to biotransform drugs because their liver enzyme systems are not fully developed. Old animals have a decreased capacity to biotransform because their ability to synthesize needed liver enzymes is impaired. Malnourished animals have fewer protein raw materials available for use in manufacturing enzymes for biotransformation, and animals with liver disease are not able to process the raw materials available for enzyme production. Drugs present in storage compartments such as fat or plasma proteins are not available to be metabolized.

Drug Excretion

Most drugs are metabolized by the liver and then are eliminated from the body by the kidneys via the urine. They can be excreted, however, by the liver

(bile), mammary glands, lungs, intestinal tract, sweat glands, salivary glands, and skin. An understanding of the route of excretion of drugs is very important because alterations or diseases of a particular organ can cause a reduced capacity to excrete the drug, and toxic accumulation may result. For example, the anesthetic agent ketamine can cause serious central nervous system (CNS) depression in cats with urinary obstruction because the kidneys excrete this drug.

Kidneys excrete drugs by two principal mechanisms. The first method is called *glomerular filtration*. A glomerulus and its corresponding tubule make up the individual functional unit of the kidney, called a *nephron*. A glomerulus acts like a sieve to filter drug molecules (metabolites) out of the blood into the glomerular filtrate, which is then eliminated as urine (Figure 1-5). The second mechanism that kidneys use to excrete drugs is called *tubular secretion*. Kidney tubule cells secrete metabolites out of the capillaries surrounding the

tubule and into the glomerular filtrate, which becomes urine as it exits the kidneys. In some instances, drug molecules may be reabsorbed out of the glomerular filtrate and back into the blood through *tubular reabsorption*.

It is important that the nephrons (glomerulus and corresponding tubule) are healthy and that they have an adequate blood supply, so they can do an effective job of excreting metabolites. The lower urinary tract (bladder and urethra) also must be functioning normally, so filtered or secreted metabolites can be eliminated. If any part of this system from the glomerulus to the urethra is compromised or diseased, toxic levels of a drug may accumulate.

The liver excretes drugs by first incorporating them into bile, which is eliminated into the small intestine. In the small intestine, the drug then may become a part of the feces and be eliminated from the body, or it may be reabsorbed into the bloodstream (Figure 1-6).

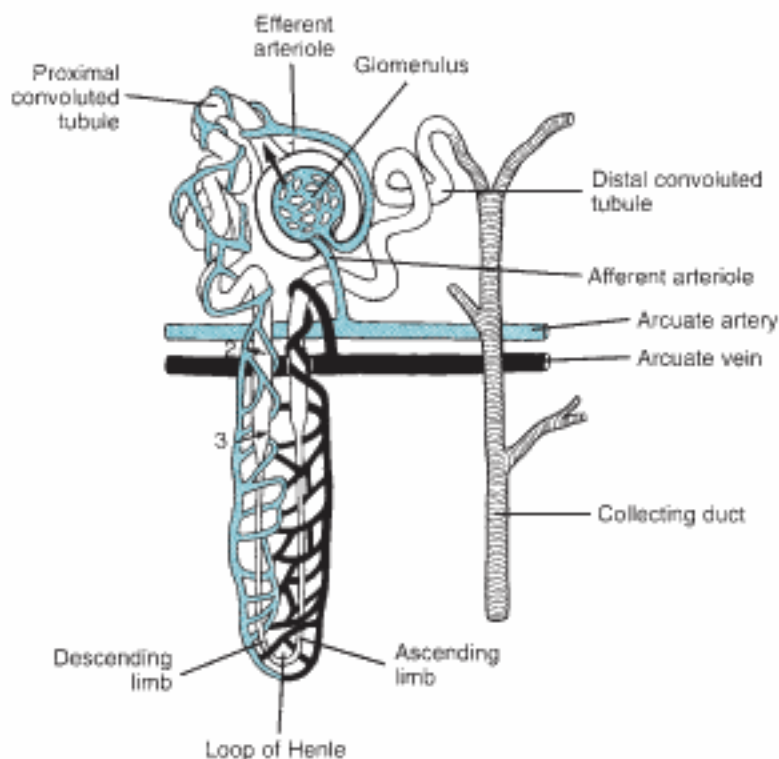

FIGURE 1-5

The kidneys eliminate or conserve drug metabolites by glomerular filtration (1), tubular reabsorption (2), and tubular secretion (3).

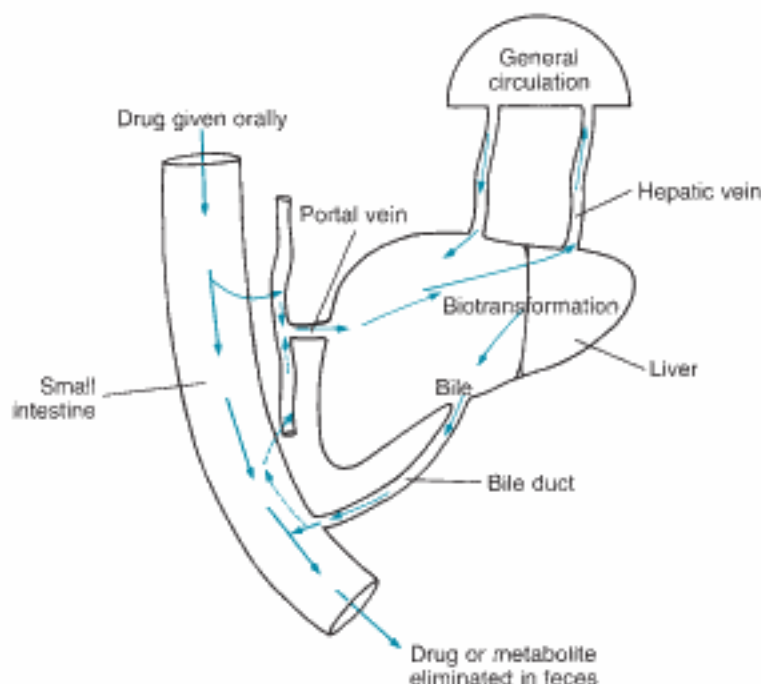

FIGURE 1-6

Drugs or their metabolites in the intestine may be eliminated in the feces or absorbed/reabsorbed for a pass through the liver.

Some drugs or their metabolites may pass directly out of the blood and into the milk via the mammary glands. This is an important consideration because of the potential effects of the drug on nursing offspring or on people who drink the milk. Quantities of drug that remain in animal products when they are consumed are called *residues*. Residues found in milk, eggs, or meat products are potentially dangerous to people for the following reasons:

- People may be allergic to the drug.
- Prolonged exposure to antibiotic residues can result in resistant strains of bacteria.
- Residue of some drugs may cause cancer in humans.

Drugs that convert readily between a liquid and a gaseous state (gas anesthetics) may be eliminated from the blood via the lungs. These gas molecules move out of the blood and into the alveoli of the lungs to be eliminated in expired air.

Drugs that are given orally and are not absorbed readily out of the intestinal tract may pass through the tract and be eliminated through feces. As was

mentioned previously, some drugs are excreted through the bile into the intestinal tract, and a few may be actively secreted across the intestinal mucosa into the intestine for elimination.

Some drugs are eliminated through sweat and saliva, although these routes usually are not clinically important. The rate of drug loss from the body can be estimated by calculating the drug's **half-life**. The half-life is the time required for the amount of drug present in the body to be reduced by one half (Figure 1-7).

PHARMACODYNAMICS

Pharmacodynamics is the study of the mechanisms by which drugs produce physiologic changes in the body. Drugs may enhance or depress the physiologic activity of a cell or a tissue. Drug molecules combine with components of the cell membrane or with internal components of the cell to cause alterations in cell function. The way in which drugs combine with structures (receptors) on or in a cell

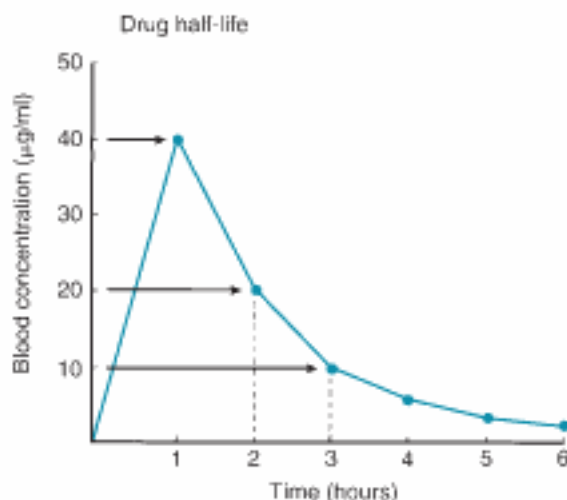

FIGURE 1-7
This graph illustrates a drug half-life of 1 hour.

can be compared with a lock-and-key model. The geometric match of a drug molecule and a cellular receptor must be exact for the appropriate action to occur (Figure 1-8). The tendency of a drug to combine with a receptor is called *affinity*, and the degree to which the drug binds with its receptor helps to determine drug efficacy. A drug with a high level of affinity and efficacy causes a specific action and is an **agonist**. A drug with less affinity and efficacy is a partial agonist. A drug that blocks another drug from combining with a receptor is an **antagonist**. The combining of a drug with its receptor causes a particular drug action, and this interaction produces a particular drug effect. Examples of drug effects include stimulation, depression, irritation, and cell death. Sometimes, a drug replaces a substance that is missing or is in short supply in the body.

A dose-response curve displays the relationship between the dose of a drug and the body's response. The dose-response curve shows that as a dose increases, an increase in response occurs until a maximum response or plateau is achieved. *No drug produces a single effect*. Low doses of a narcotic may be used to treat patients with diarrhea. Higher doses may be used for pain relief, and even higher doses may depress the respiratory system. The *potency* of a drug is described as the amount of a drug needed to produce a desired response and is represented by a position along the dose-response curve.

The **efficacy** of a drug represents the degree to which a drug produces its desired response in a patient. Once the efficacy level of a drug has been reached, increasing the dose does not improve the effect.

The *therapeutic index* is the relationship between a drug's ability to achieve the desired effect and its tendency to produce toxic effects. The therapeutic index, which is expressed as the ratio between the LD_{50} and the ED_{50} , quantitates the drug's margin of safety. The LD_{50} is the dose of a drug that is lethal to 50% of the animals in a dose-related trial. The ED_{50} is the dose of a drug that produces the desired effect in 50% of the animals in a dose-related trial. The index is calculated as follows: Therapeutic index = LD_{50}/ED_{50} .

The larger the number that is produced by dividing the LD_{50} by the ED_{50} , the greater is the level of safety. Drugs with a narrow margin of safety (low therapeutic index) must be administered with caution to prevent toxic or fatal effects. The drugs used to treat cancer often have a low therapeutic index.

An **adverse drug reaction** is an undesirable response to a drug that can range from mild to life threatening. Adverse reactions can be related to the characteristics of the drug itself, the quality or purity of the drug, or the amount of drug used. Phenobarbital is potentially toxic to the liver, and amphotericin

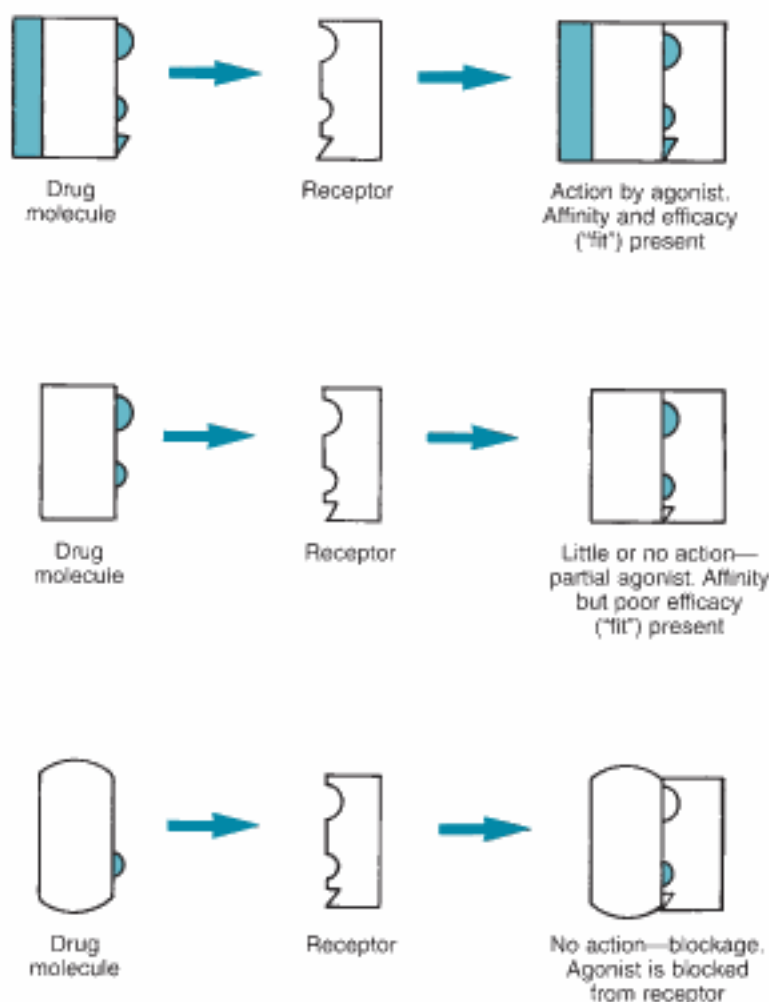

FIGURE 1-8
Drug molecules must combine with specific cellular receptors to exert their effects.

B may damage the kidneys. Drugs can have carriers or vehicles that are toxic to some individuals. Some adverse reactions are allergic and can cause a range of reactions from dermatitis to anaphylactic shock. Drugs can cause changes in the skin that make it very sensitive to sunlight. This type of reaction is called *photosensitivity*.

Other types of adverse responses include abortion, liver or kidney damage, infertility, vomiting or diarrhea, and cancer. An unusual or unexpected reaction is called an *idiosyncratic drug reaction*. All adverse reactions should be reported to the drug manufacturer or the FDA. If the report is made to the drug company, the company is obligated to report the incident to the FDA.

DRUG INTERACTIONS

An altered pharmacologic response to a drug that is caused by the presence of a second drug is called a *drug interaction*. The normal response to the drug may be increased or decreased as a consequence of this interaction. The interaction may be beneficial or harmful to the patient.

Drug interactions can be classified as pharmacokinetic, pharmacodynamic, or pharmaceutical. A pharmacokinetic interaction is one in which plasma or tissue levels of a drug are altered by the presence of another. This alteration may be due to changes in absorption, distribution, metabolism, or excretion of the other drug. Metoclopramide hastens

gastric emptying and promotes the delivery of a drug to the small intestine for absorption. When calcium and tetracycline are administered at the same time orally, calcium binds the tetracycline and the complex is not absorbed. Displacement of albumin-bound drugs by other drugs with a greater binding affinity may result in an increase in the free drug, leading to an increased response. Many drugs are metabolized by the cytochrome P-450 enzyme system found in the liver, and several drugs can alter the activity (increase or decrease) of the P-450 system, causing drug interaction.

A pharmacodynamic interaction is one in which the action or effect of one drug is altered by another. These reactions occur at the site of drug action. These actions may be antagonistic (reversal of an alpha agonist with yohimbine), additive (CNS depression with combinations of preanesthetics), or synergistic (sulfonamide-trimethoprim combinations).

A pharmaceutical interaction occurs when physical or chemical reactions take place as a result of mixing of drugs in a syringe or other container. Amphotericin B may form a precipitate when mixed with electrolyte solutions other than 5% dextrose. Diazepam may precipitate if mixed with certain drugs. Ampicillin and furosemide may be

chemically inactivated if mixed with an acid medium (Ahrens, 1996).

Drug interactions are described as involving an object drug (the one being acted upon) and a precipitant drug (the one that influences the other) (Mealey, 2002). Table 1-2 lists selected drug combinations that may have undesired consequences.

Technician's Notes

1. It generally is recommended that mixing of drugs in the same syringe or fluid administration system should be avoided unless the drugs are known to be compatible.
2. When two drugs metabolized by the liver are given, one should anticipate a drug interaction.
3. Concurrent use of drugs from the "behavior modifying" category can cause serious problems such as serotonin syndrome or hypertensive reactions.

DRUG NAMES

During the course of its testing, development, and marketing, a drug may be assigned several different names. These multiple names can be a source of

Table 1-2 Drug Combinations That May Have Undesired Consequences

Precipitant Drug	Object Drug	Consequences
Antacids	Tetracycline	Reduced absorption of tetracycline
Ketoconazole	Digoxin, cyclosporine, tricyclic antidepressants	Decreased metabolism of object drugs
Sucralfate	Fluoroquinolones	Decreased metabolism of fluoroquinolones
Fluoroquinolones	Theophylline	Decreased metabolism of theophylline
Omeprazole	Ketoconazole/itraconazole	Decreased oral absorption of object drugs
Phenobarbital	Theophylline, doxycycline, beta blockers	Increased metabolism of object drugs (cytochrome P-450 induction)
Cimetidine	Diazepam and theophylline	Decreased metabolism of object drugs (cytochrome P-450 inhibition)
MAO Inhibitors	Amitraz, selective serotonin reuptake inhibitors, tricyclic antidepressants, other MAOs	Dangerous accumulation of biogenic amines leading to serotonin syndrome or hypertensive state
Tetracyclines	Penicillins	Tetracyclines slow bacterial growth and inhibit penicillins that are most effective against rapidly growing bacteria

confusion. For practical purposes, drugs are given the following types of names:

1. **Chemical**—the name that describes the molecular structure of a drug. These names are scientifically very accurate, but they are complex and are impractical for use in clinical settings.
2. **Code or laboratory**—the name given to a drug by the research and development investigators. It is used for communication between research teams and consists of abbreviations and code numbers.
3. **Compendial**—the name listed in the *United States Pharmacopoeia (USP)*. The *USP* is the legally accepted compendium that lists drugs and standards for their quality and purity.
4. **Official**—usually the same as the compendial or generic name.
5. **Proprietary or trade**—the name chosen by the manufacturing company. When it is registered, it is the exclusive property of the company. A name that is short and can be easily recalled is usually selected for the proprietary name. Federal copyright and trademark laws protect this name. On drug container labels, in package inserts, and in drug references, the proprietary name can be distinguished by a superscript R with a circle around it after the name.
6. **Generic**—the common name chosen by the company. It is not the exclusive right of the company. It may be the same as the official or compendial name. These are drugs with patents that have expired, or they were never patented.

The following illustration illustrates use of the various name categories. Ketaset, Ketaject, Ketavet, and Vetalar are proprietary names for ketamine, which is the generic and compendial name for 2-(*o*-chlorophenyl)-2-methyl-aminocyclohexanone (chemical name). Code or laboratory names for this drug include CI-581 and CI-369 (Webb and Aeschbacher, 1993).

In textbooks and other scholarly works, generic names begin with a lowercase letter, and proprietary names begin with a capital letter. This practice is followed throughout this text (e.g., ketamine [Ketaset]).

DRUG LABELS

The Center for Veterinary Medicine (CVM) of the FDA requires that drug container labels must list the following items (Webb and Aeschbacher, 1993):

- Drug names (both generic and trade names)
- Drug concentration and quantity
- Name and address of the manufacturer
- Controlled substance status
- Manufacturer's control or lot number
- Drug's expiration date

The labeling is also required to list instructions for use of the drug and warnings of possible adverse effects of the drug. Because the label on the container usually has limited space, many manufacturers list this added information in an insert. An insert is a small folder that is placed inside the box with the drug container or is provided as a tear-off portion of the label.

The trade name usually is placed first on a drug label and is scripted in bold letters (Figure 1-9). The generic name typically follows the trade name in smaller print. The label must display the concentration (strength) of a drug and the total quantity in the container. Drug strength often is expressed as milligrams or units per dosage unit (mg/ml, mg/capsule, and so forth). Some drugs are sold in different concentrations with similar labels, and underdosing or overdosing can result. When the same drug is marketed in different strengths with similar labels, some companies use different sizes of bottles for the different strengths and display the concentrations in bold print. Atropine and xylazine are examples of drugs that are marketed in different concentrations for large and small animals.

The label must include the name and address of the manufacturer of the drug. This is important so that one can know whom to contact if adverse drug reactions occur, or if other problems with the drug arise.

Drugs that have potential for abuse by humans are controlled under the Comprehensive Drug Abuse Prevention and Control Act of 1970. The Drug Enforcement Administration places drugs into categories or schedules according to their

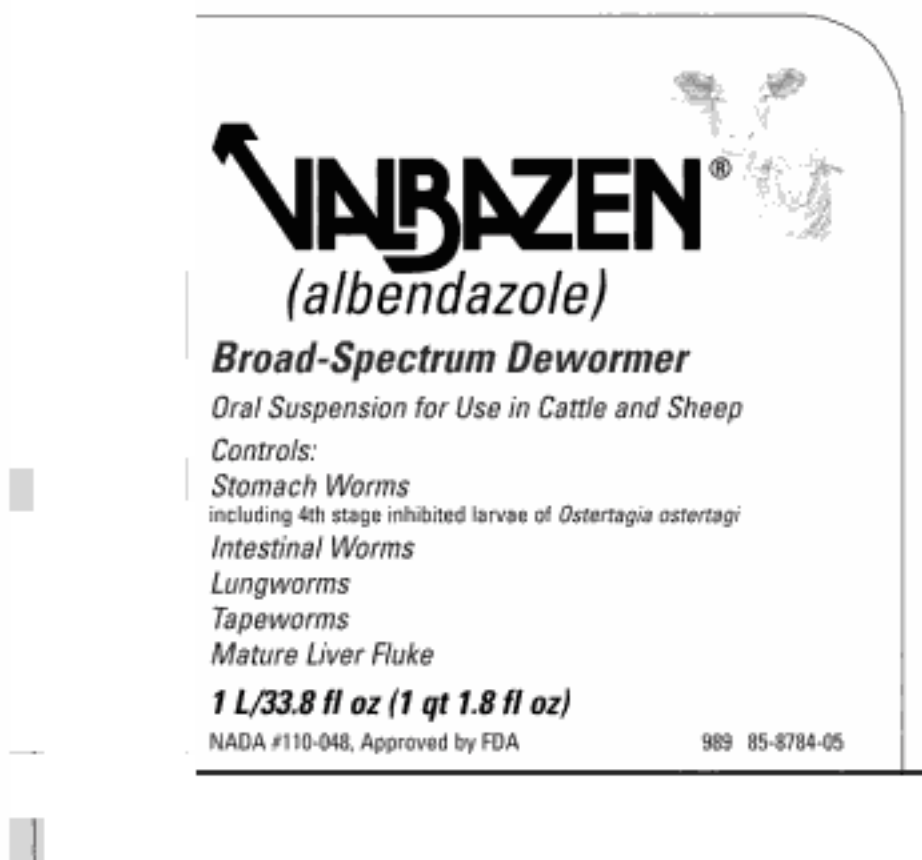

FIGURE 1-9

A label showing the components of a drug as required by the U.S. Food and Drug Administration (FDA). (Courtesy Pfizer Animal Health, Exton, Pa.)

potential for abuse and requires that the label of a container for a controlled substance must be identified with a capital C, followed by a Roman numeral that identifies which of the five categories is appropriate. This labeling must be placed on the upper right side of the container label.

Drug labels are required to list an expiration date for the product. This is to ensure that dispensed drugs have the intended safety and efficacy. Drugs are tested during development to determine the effective shelf life and proper storage conditions. Some drugs must be stored in refrigeration, and others must be stored in light-resistant (amber) containers to ensure that the shelf life is not shortened.

Storage instructions on the label should be followed carefully to validate the expiration date.

All drugs must have a lot or batch number on the label. The purpose of the lot number is to allow the manufacturer to know the exact time and date of production of the product and the quality and quantity of the ingredients. The lot number is determined by the manufacturer and may consist of numbers, or numbers and letters.

Another feature that is often found on a drug label but is not required by the FDA is the national drug code (NDC) number. The NDC is a 10-digit number that identifies the manufacturer or distributor, the drug formulation, and the package size.



VetBAZEM®
(albendazole)

Broad-Spectrum Dewormer
Oral Suspension for Use in Cattle and Sheep
For removal and control of liver flukes, tapeworms, stomach worms, intestinal worms, lungworms

Active Ingredient: Albendazole (Equivalent to 11.3% mg/mL)

Indications: VetBazem is a broad-spectrum anthelmintic effective in the removal and control of the following internal parasites in cattle and sheep:

Parasite	Cattle	Sheep
Adult Liver Flukes	<i>Fasciola hepatica</i>	Parasite Infection: <i>Fascioloides magna</i>
Pinworm and Segments of Tapeworms	<i>Oxyuris equi</i> , <i>M. axei</i>	Colostrum Tapeworms (Intestine Infection), Pinworm Tapeworms (Intestine Infection)
Adult and 4th Stage Larvae of Stomach Worms	Brown Stomach Worms, including 4th stage larval stage larvae (Chargarsee worm), Barber's Pole Worm (Intestine Infection), or related, small stomach worms (Intestine Infection)	Brown Stomach Worms (Intestine Infection), Whitehead Worm (Intestine Infection), Small Stomach Worm (Intestine Infection)
Adult and 4th Stage Larvae of Intestinal Worms	Thread and related worms (Intestine Infection), <i>H. helicostephalum</i> , Small Intestine Worm (Intestine Infection), <i>C. caryophallus</i>	Thread-necked Intestinal Worm (Intestine Infection), <i>H. contortus</i> , Cooper's Worm (Cooper's Infection), Cervical Worm (Intestine Infection), (Intestine Infection) (Intestine Infection), (Intestine Infection), (Intestine Infection)
Adult Stages of Intestinal Worms	Hookworm (Intestine Infection), Chargarsee Worm (Intestine Infection), Nodule Worm (Intestine Infection)	
Adult and 4th Stage Larvae of Lungworms	<i>Dictyocaulus viviparus</i>	
Adult and Larval Stages of Lungworms		<i>Dictyocaulus viviparus</i>

Dosage and Administration: VetBazem Suspension should be administered to cattle at the recommended rate of 4 mL/100 lb of body weight (equivalent to 4.34 mg of albendazole/kg, 18 mg/kg) and to sheep at the recommended rate of 8.75 mL/25 lb of body weight (equivalent to 21.4 mg of albendazole/kg, 1.6 mg/kg). The following table reflects recommended dosing rates.

Cattle				Sheep			
Body Weight	Dosage	Body Weight	Dosage	Body Weight	Dosage	Body Weight	Dosage
100 lb	40 mL	100 lb	40 mL	25 lb	8.75 mL	100 lb	3.5 mL
200 lb	80 mL	200 lb	80 mL	50 lb	1.75 mL	200 lb	7.0 mL
300 lb	120 mL	300 lb	120 mL	75 lb	2.63 mL	300 lb	10.5 mL

Cattle: 1 liter of VetBazem 11.3% Suspension will treat 50 animals weighing 100 lb.
Sheep: 1 liter of VetBazem 11.3% Suspension will treat 50 animals weighing 25 lb.

VetBazem 11.3% Suspension: should be given orally using any type of standard dosing gun or dose syringe.

Warnings: Avoid the use of this weight of the cattle and sheep or increased use should be avoided for most effective results with this product. Animals consistently exposed to albendazole water should be treated as reinfections.

Caution: Cattle should not be slaughtered within 21 days following last treatment. Sheep must not be slaughtered within 7 days following last treatment. See user withdrawal time in this case has not been established; do not eat or handle dairy cattle of breeding age.

Caution: Do not administer to female cattle during first 45 days of pregnancy or for 45 days after removal of fetus. Do not administer to goats during the first 30 days of pregnancy or for 30 days after removal of fetus. Consult your veterinarian for assistance in the diagnosis, treatment, and control of infections.

Keep This and All Medication Out of Reach of Children
Store Well Before Using
For Use in Animals Only
Store at Controlled Room Temperature (20°-25°C (68°-77°F))
Protect From Freezing
U.S. Patent Nos. 5,215,880 and 5,255,499
961 86 67000
made in USA



0 87219 01421 9



Animal Health
Pfizer Inc.
New York, NY 10017

FIGURE 1-9, cont'd

Drugs intended for animals that may be consumed by humans must have the appropriate withdrawal time listed on the insert or label.

DEVELOPMENT AND APPROVAL OF NEW DRUGS

The federal government requires that before any new animal health product can be marketed, its safety and efficacy must be proved through rigorous testing. This testing requires the expenditure of much time and money. It has been estimated that on average, to get a new animal drug on the market, 7 to 10 years of testing is required at a cost of \$15 million to \$20 million to the manufacturer. The steps in this process are outlined in Figure 1-10.

The development of new animal health products begins in the research and development department of the manufacturing company. The company wants to ensure that the drug not only is safe and effective for animals but also is safe for the environment and for the people who will consume products from animals treated with the drug. The company wants to be certain that a market is available for the product, that it will be produced at a cost that is reasonable for consumers, and that the product will be profitable for the company.

Regulatory Agencies

The three agencies of the U.S. government that regulate animal health products are the FDA, the Environmental Protection Agency (EPA), and the U.S. Department of Agriculture (USDA). The FDA

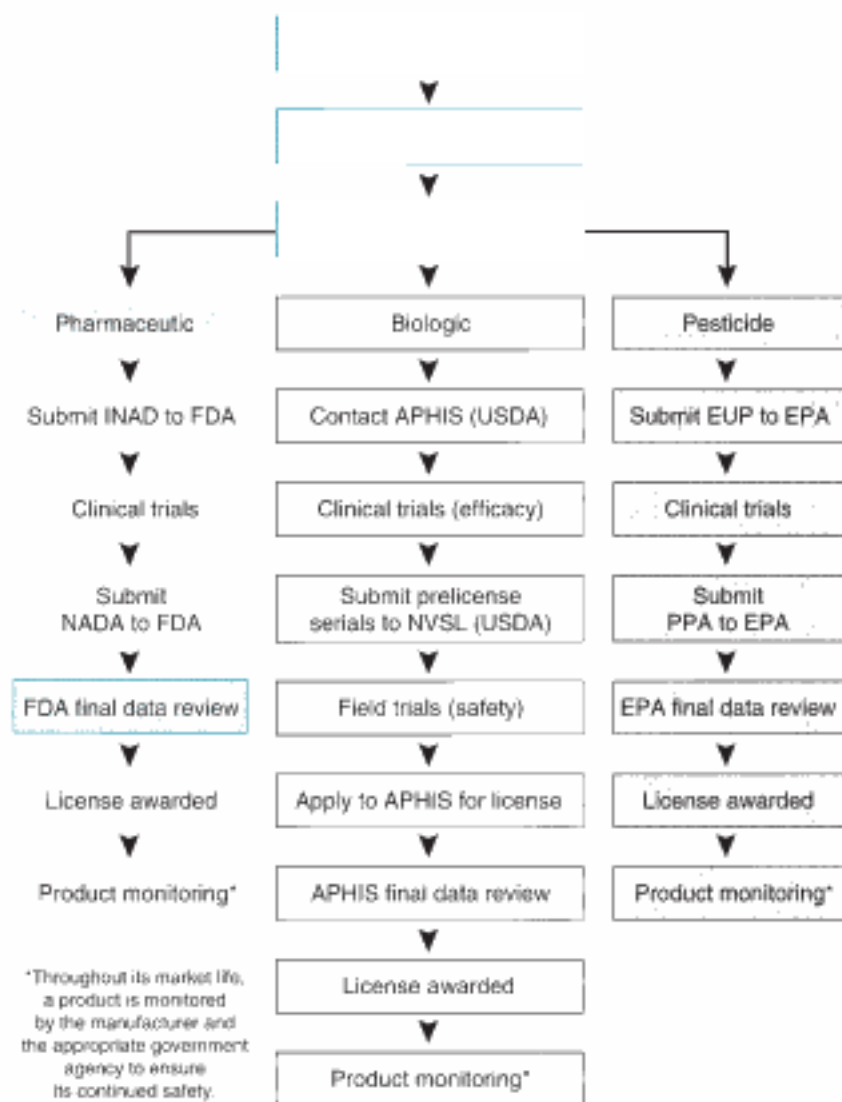

FIGURE 1-10

A flow chart of the animal health product approval process: Investigational New Animal Drug (INAD); U.S. Food and Drug Administration (FDA); Animal and Plant Health Inspection Service (APHIS); National Veterinary Services Laboratory (NVSL); U.S. Department of Agriculture (USDA); Experimental Use Permit (EUP); Environmental Protection Agency (EPA); Pesticide Permit Application (PPA). (From Etchison K: The path to approval: how research discoveries become federally licensed products, *Top Vet Med* 4[1]:13, 1993.)

regulates the development and approval of animal drugs and feed additives through its Center for Veterinary Medicine. The EPA regulates the development and approval of animal topical pesticides, and the USDA regulates the development and approval of biologics (vaccines, serums, antitoxins, and similar products).

THE FOOD ANIMAL RESIDUE AVOIDANCE DATABANK

The Food Animal Residue Avoidance Databank (FARAD), a project sponsored by the USDA Extension Service, serves as a repository of residue avoidance information and educational materials. FARAD provides expert advice concerning the

avoidance of drug residues in an effort to achieve its goal of producing “safe foods of animal origin.” FARAD produces a compendium of FDA-approved drugs and provides information about withholding times for milk and preslaughter withdrawal times for meat. The information in this compendium is available online (www.farad.org), and direct telephone access is provided for situations in which online information is not sufficient.

Steps in the Development of a New Drug

PRELIMINARY TRIALS

When a new drug or product shows the potential for development by a company, it is first subjected to a series of preliminary trials. The company wants to know whether the product will actually perform as expected, whether it has potentially harmful adverse effects, and whether it will be profitable to market. If these concerns are satisfactorily answered, testing begins. First, the product is tested in a laboratory on simple organisms such as bacteria, yeasts, or molds. Computer models may be used to simulate animal models at this time.

PRECLINICAL (ANIMAL SAFETY) TRIALS

If preliminary trial findings prove satisfactory, the next step involves preclinical trials. These trials usually are carried out with the use of laboratory animals to gather information about appropriate doses of the drug. A few target (intended species) animals may be used as well. If the results of the preclinical trials are satisfactory, the company then notifies the appropriate government agency that a new drug is under investigation. It does this by filing an Investigational New Animal Drug (INAD) application with the FDA. If the product is a pesticide, the company files for an Experimental Use Permit (EUP) from the EPA. If a biologic is involved, the company contacts the Animal and Plant Health Inspection Service of the USDA.

CLINICAL TRIALS

By this time, the manufacturer has compiled enough information to decide whether the product should be tested in the target species. These tests must prove that the drug is safe and effective. Potential toxic and adverse effects must be identified. Tissue

residue and withdrawal time information must be accumulated if the product will be used in food-producing animals. Possible toxic effects on pregnant animals are explored, along with information about the potential for birth defects (teratogenesis). Shelf life studies also must be conducted to establish expiration date data. Results of these studies are validated through the use of statistical analysis.

SUBMISSION OF A NEW ANIMAL DRUG APPLICATION

If the manufacturing company decides to market the drug, it then must file with the FDA a New Animal Drug Application (NADA). Procedures for pesticides and biologics are similar.

FINAL REVIEW BY THE FDA

Volumes of research are submitted to the FDA, EPA, or USDA for review. Approval and a license for manufacture are granted if the appropriate agency validates the information.

PRODUCT MONITORING

As long as a product is marketed, it is monitored constantly by the company and the government to ensure its continuing safety and efficacy.

THE GREEN BOOK

The Green Book is a list of all animal drug products that have been approved by the FDA for safety and effectiveness. This list was first published in 1989 as a cooperative, nonprofit effort between the USDA and Virginia Polytechnic Institute and State University. It is funded through an interagency agreement between the USDA and the FDA. Monthly updates are made to the list, and the entire list is published each January. *The Green Book* is available electronically at the FDA-CVM World Wide Web site (<http://www.fda.gov/cvm/greenbook/greenbook.html>).

FEDERAL LAWS RELATED TO DRUG DEVELOPMENT AND USE

In 1906, Congress passed the first legislation designed to regulate the manufacture, use, and sale of drugs. Table 1-3 provides a list of the major acts of

Table 1-3 Federal Laws Regulating the Use of Pharmaceuticals

Date	Legislation	Summary
1958	Food additives amendment	Regulation of substances added to food for human consumption. Delaney clause provided that no additive may be added if it causes cancer in humans or animals.
1962	Kefauver-Harris amendment	Provided for safety and effectiveness of drugs by strict control of manufacturing for new animal drugs.
1968	Animal drug amendment	Provided regulations for new animal drugs.
1970	Comprehensive drug abuse and control act	Placed controlled substances into schedules according to their potential for abuse. Called for registration of veterinarians.

legislation passed before the 1990s and describes the significance of each.

The Animal Medicinal Drug Use Clarification Act

In 1994, Congress passed the Animal Medicinal Drug Use Clarification Act (AMDUCA). This legislation made extralabel use of approved veterinary drugs legal under specific well-defined conditions. This act came about because of the lobbying efforts of the American Veterinary Medical Association (AVMA) and other groups in response to the FDA, which had tightened its policies on extralabel use of veterinary drugs. Previously, veterinarians had been permitted to use any drug as long as it could be legally obtained, was used according to sound professional practice, and left no residue in food products (Coppoc, 2003). However, public concerns over food safety issues related to residues of substances such as diethylstilbestrol, chloramphenicol, and antibiotics caused the FDA to issue compliance policy guidelines (CPGs) that made extralabel use illegal. Even though the FDA would not routinely prosecute veterinarians for extralabel use after issuance of the CPGs, practitioners nonetheless were placed in the position of breaking federal law to meet their obligations to animals and their owners. The AMDUCA allows veterinarians to legally select the most efficacious drugs for their patients. The AVMA issued an *AMDUCA Guidance Brochure* in 1998.

This brochure outlines requirements of the act and provides an algorithm that can be used to determine when extralabel use is appropriate.

A section of the AMDUCA states that the FDA may prohibit an extralabel use in animals if the agency finds that such use presents a risk to the public health. The following drugs and substances are prohibited for extralabel use in all food-producing animals:

- Chloramphenicol
- Clenbuterol
- Diethylstilbestrol
- Dimetridazole
- Iprnidazole
- Other nitroimidazoles
- Furazolidone
- Sulfonamide drugs in lactating dairy cattle
- Sulfadimethoxine, sulfabromomethazine, and sulfaethoxypyridazine
- Fluoroquinolones
- Glycopeptides
- Phenylbutazone in dairy cattle 20 months of age and older

Compounding of Veterinary Drugs

FDA-approved drugs are labeled for specific therapeutic uses in defined species. Because veterinarians must treat a variety of animal species that may vary greatly in size, it is not always possible to use an

approved drug for every clinical situation; therefore, veterinarians may have to dilute or combine (compound) existing medications. For example, it may be in the best interest of a horse to combine more than one drug in a single syringe to minimize the number of injections. It also may be essential to dilute an injectable agent to obtain an appropriate concentration for a bird or mouse, or to prepare an antidote (e.g., sodium sulfate) that is not commercially available. None of these activities would be permitted under a strict interpretation of FDA regulations, which traditionally have not distinguished the act of diluting or combining drugs from the act of manufacturing. Any alteration of a drug by a veterinarian or his or her employee that changes the concentration of the active ingredient, the preservatives, or the vehicles results in a new animal drug that is subject to the FDA approval process (Davidson, 1997). Recognizing the difficulties imposed by these regulations, the FDA issued a CPG (608.400) in 1996 to better define the conditions for which compounding is permitted. These conditions include but may not be limited to (1) identification of a legitimate veterinary medical need; (2) the need for an appropriate regimen for a particular species, size, gender, or medical condition; (3) lack of an approved animal or human drug that when used as labeled will treat the condition; and (4) too long a time interval for securing the drug to treat the condition.

The Veterinary Feed Directive

Congress established the Veterinary Feed Directive (VFD) as part of the Animal Drug Availability Act of 1996. The VFD established a new category of drugs “as an alternative to prescription status” for certain antimicrobial animal feed additives. Before this directive, all commercially available animal drugs for use in medicated feeds were available on an over-the-counter basis. The VFD therefore provides the FDA CVM greater control over the use of some new animal feed additives. Use of VFD drugs requires a valid veterinarian-patient-client relationship and the issuance of a VFD form by a veterinarian. The animal producer must secure the VFD form from the veterinarian and must present it to a feed mill to receive the medicated feed.

The Minor Use and Minor Species Animal Health Act

There is a shortage in the United States of approved animal drugs intended for use in less common animal species or those with less common conditions. The drugs that do exist may not be used legally in the animals that need the treatment. The Minor Use and Minor Species (MUMS) Animal Health Act of 2001 is intended as a mechanism to provide FDA-authorized drugs for those less common species and indications, similarly to the human Orphan Drug Act of 1983. MUMS specifically defines the provision of labeled drugs for minor species, including sheep, goats, game birds, emus, rancher deer, alpacas, llamas, deer, elk, rabbits, guinea pigs, pet birds, reptiles, ornamental and other fish, shellfish, wildlife, zoo, and aquarium animals. MUMS is also designed to provide major species (e.g., cats, dogs, horses, cattle, swine, turkeys, chickens) with needed drugs for uncommon indications (minor uses).

DISPENSING VERSUS PRESCRIBING DRUGS

Although most physicians prescribe drugs, most veterinarians prescribe and dispense them. The primary reason why veterinarians maintain a pharmacy in their hospitals is that drug sales represent an important source of income. Food animal practitioners in particular use profit from drug sales to supplement their income because it may be difficult for them to charge sufficiently for their time. Another reason why veterinarians dispense drugs from their hospitals is that human pharmacies usually do not stock veterinary drugs. A few drugs are available only from human pharmacies, and others are used so infrequently that veterinarians find it more practical and economical to write a prescription for them.

MARKETING OF DRUGS

Pharmaceutical products are purchased by veterinarians from various sources. Some products are purchased directly from the manufacturer by telephone

or by mail; others are obtained from sales representatives (detail persons) who call on veterinary clinics. Distributors (wholesalers) are companies that buy products from many different manufacturers and then resell the products to veterinarians through sales representatives or by phone. Generic drug companies sell generic products under their own label, usually by mail order.

Most of the pharmaceutical manufacturers are large companies that have separate divisions. One division sells products to veterinarians only, and the other sells over-the-counter products. It should be noted that the statement "sold to graduate veterinarians only" on a drug label does not mean that the product is a prescription drug. It only indicates a sales policy of the company. In a few instances, the same product is sold under different labels to veterinarians only and to over-the-counter markets. Some feed stores and cooperatives are able to sell over-the-counter products (similar to products sold by veterinarians) to consumers at prices lower than veterinarians can charge because of the quantity purchasing power of the stores. This can be a source of tension between veterinarians and retail markets.

In recent years, Internet pharmacies have emerged on the marketing scene. Many clients attempt to use these resources because of the reduced cost of some products. The primary concern in the veterinary community is that some Internet pharmacies are supplying prescription drugs to consumers without the authorization of a veterinarian with a veterinarian-client-patient-relationship. The prescription may be issued by an out-of-state veterinarian who responds to client questionnaire information, rather than through actual patient and client contact. Solving these problems may be difficult because the FDA regulates the drug products themselves, not the practice of the pharmacy. The board of pharmacy in the individual states where the Internet pharmacy is located and registered regulates the practice of pharmacy. The board of

pharmacy in states where consumers are given prescriptions enforces requirements for out-of-state pharmacies. The AVMA advocates a program called "VIPPS" to validate the legitimacy of online pharmacies. VIPPS (Anonymous, 2007) is a voluntary certification program that was created by the National Association of Boards of Pharmacy. The VIPPS seal of approval validates that the online pharmacy is appropriately licensed and is conducting business legitimately. A related issue is the sale of "ethical products" by these Internet companies. These are products for which the manufacturer has voluntarily limited their sale to veterinarians as a marketing decision. Some flea and tick control products are ethical products registered with the EPA or the FDA in the over-the-counter category. Improper sale of these ethical products may then be an ethical rather than a legal issue.

REFERENCES

- Ahrens AA: Pharmacology, the national veterinary medical series for independent study, Philadelphia, 1996, Lippincott Williams & Wilkins.
- Anonymous: AVMA Position Statement on Internet Pharmacies, 2007, http://www.avma.org/issues/policy/internet_pharmacies.asp
- Boothe DM: Principles of drug therapy. In Boothe DM, editor: Small animal clinical pharmacology, Philadelphia, 2001, WB Saunders.
- Coppoc GL: Drug residue avoidance, 2007. In Class notes for BMS 513: <http://www.vet.purdue.edu/bms/courses/bms513/scavma97.htm>
- Davidson G: Pharmacy update: new FDA policy gives clear guidance for compounding, *Vet Tech* 18(3):195-201, 1997.
- Mealey KL: Clinically significant drug interactions, *Compend Contin Educ Proc Pract Vet* 24(1):10-22, 2002.
- Upton DW: General principles. In Upton DW, editor: Handbook of clinical veterinary pharmacology, Manhattan, Kansas, 1988, Dan Upton Enterprises.
- Webb AI, Aeschbacher G: Animal drug container labels: a guide to the reader, *JAVMA* 202:1591-1599, 1993.
- Williams BR, Baer C: Introduction to pharmacology. In Williams BR, Baer C, editors: Essentials of clinical pharmacology in nursing, Springhouse, Pa, 1990, Springhouse Corp.



REVIEW QUESTIONS

- Define the following terms:
 - Agonist _____
 - Contraindication _____
 - Efficacy _____
 - Over-the-counter drug _____
 - Prescription drug _____
 - Receptor _____
 - Therapeutic index _____
 - Withdrawal time _____
 - Veterinarian-client-patient relationship _____
- List four sources of drugs used in veterinary medicine. _____
- What are four components of a drug regimen? _____
- Discuss the conditions that must be met before a valid veterinarian-client-patient relationship can be shown to exist. _____
- Discuss the responsibilities of a veterinary technician in the administration of drug orders. _____
- Describe the sequence of events that a drug undergoes from administration to excretion. _____
- List 11 possible routes for administering a drug to a patient, and discuss the advantages and/or disadvantages of each. _____
- List some of the factors that influence drug absorption. _____
- Most biotransformation of drugs occurs in which of the following?
 - Kidney
 - Liver
 - Spleen
 - Pancreas
- Most drug excretion occurs via which of the following?
 - Kidneys
 - Liver
 - Spleen
 - Intestine
- Drugs usually produce their effects by combining with specific cellular _____.
- The drug name that is chosen by the manufacturer and that is the exclusive property of that company is called _____.
- What are six items that must be included on a drug label? _____
- What are three government agencies that regulate the development, approval, and use of animal health products? _____
- Why do many veterinary clinics dispense rather than prescribe most of the drugs that they use? _____
- Describe the marketing of animal health products. _____
- All FDA-approved veterinary drugs are listed in the publication entitled _____.
- What is the purpose of FARAD? _____
- Extralabel veterinary drug use was made legal (under prescribed circumstances) by what act of Congress? _____
- Define compounding. _____
- What are the potential dangers of residues in animal products? _____
- List three classes of drug interactions.
 - _____
 - _____
 - _____
- Drug interaction can be anticipated when two drugs are given that are both metabolized by the _____.
- Define "ethical product." _____
- Once a drug has been biotransformed, it is called a _____.
- An(a) _____ is a reason to use a drug.
 - contraindication
 - indication

27. The diagnostic method of choosing a drug is based on all of the following except _____.
- practical experience
 - assessment of the patient
 - obtaining a history
 - performing laboratory tests
28. Extralabel use means _____.
- sold over the counter (OTC)
 - using a drug in a way not specified by the label
 - using a drug according to the empirical method
 - deciding how long the drug should be given
29. All the following are true about a veterinarian-client-patient relationship except:
- The veterinarian has seen and treated all the client's pets except a dog for which the owner would like to buy heartworm preventative.
 - The veterinarian has assumed responsibility for making clinical judgments about the health of the animal(s) and the need for treatment, and the client has agreed to follow the veterinarian's instructions.
 - The veterinarian has sufficient knowledge of the animal(s) to issue a diagnosis. The veterinarian must have recently seen the animal and must be acquainted with its husbandry.
 - The veterinarian must be available for follow-up evaluation of the patient.
30. _____ is the complex sequence of events that occurs after a drug is administered to a patient.
- Half-life
 - Metabolism (biotransformation)
 - Pharmacokinetics
 - Residue
31. Parenteral drugs are administered _____.
- orally
 - by injection
 - SC
 - ID
32. _____ is the body's ability to change a drug chemically from the form in which it was administered into a form that can be eliminated from the body.
- Half-life
 - Metabolism (biotransformation)
 - Pharmacokinetics
 - Residue
33. The _____ of a drug represents the degree to which a drug produces its desired response in a patient.
- pharmacodynamics
 - pharmacokinetics
 - efficacy
 - metabolism
34. An adverse drug reaction is always life threatening.
- True.
 - False.
35. All the following agencies regulate animal health products except _____.
- FDA
 - EPA
 - AVMA
 - USDA

CHAPTER 2

Routes and Techniques of Drug Administration

LEARNING OBJECTIVES

After studying this chapter, you should be able to:

1. Discuss the many types of available drug forms.
2. List and explain the five rights of administering medication.
3. Name available types of syringes and needles, and describe their common uses.
4. Correctly read doses in a syringe.
5. Explain the techniques available for administering medications, the routes commonly used, and how the treatment should be documented.
6. Describe what is involved in preparing a prescription and explain how the prescription is posted to the medical record.
7. List the U.S. Drug Enforcement Administration (DEA) requirements for keeping inventory and dispensing controlled substances.



KEY TERMS

CERUMEN A waxy secretion of the glands of the external ear canal.

COUNTERIRRITANT An agent that produces superficial irritation that is intended to relieve some other irritation.

CREAM A semisolid preparation of oil, water, and a medicinal agent.

ELIXIR A hydroalcoholic liquid that contains sweeteners, flavoring, and a medicinal agent.

EMULSION A medicinal agent that consists of oily substances dispersed in an aqueous medium with an additive to stabilize the dispersion.

LINIMENT A medicine in an oily, soapy, or alcoholic vehicle to be rubbed on the skin to relieve pain or to act as a counterirritant.

OINTMENT A semisolid preparation that contains medicinal agents for application to the skin or eyes.

PARENTERAL Administration by a route other than the alimentary canal (e.g., intramuscular, subcutaneous, intravenous).

SPECULUM An instrument for dilating a body orifice or cavity to allow visual inspection.

SUSPENSION A preparation of solid particles dispersed in a liquid but not dissolved in it.

INTRODUCTION

In a busy veterinary practice, a veterinary technician often administers treatments ordered by the veterinarian. Proper administration techniques should be used along with accurate documentation on the medical record. Additionally, a veterinary technician must be knowledgeable about dosage forms, syringe construction, and hatch marks and must be able to draw correct amounts of medication within a syringe, know the five rights of drug administration, be capable of administering medication by all available routes, be knowledgeable in the area of client education regarding drugs, and know how to properly handle controlled substances. Proper documentation of administered treatments is of utmost importance and ensures that the same treatment is not repeated by other veterinary personnel. Knowledge of adverse reactions that animals may have to particular medications is also crucial. The veterinary technician is the veterinarian's most important employee in a busy practice. Through observation of the patient during treatments, the technician is able to provide the veterinarian with information regarding the patient's response. The doctor, thus informed, can easily reach decisions regarding adjustment of the treatment regimen. The technician who recognizes the importance of administering proper treatment to the patient and who uses observation skills

in assessing patient response to that treatment is an invaluable asset to the practice.

DOSAGE FORMS

Pharmaceutical companies manufacture drugs in various forms. Some drugs are available in a variety of forms; others may be available for administration in only one form. Most pharmaceutical companies endeavor to provide comfort to the patient and to ensure ease of administration when formulating their drugs. Some common drug preparations may be administered orally, parenterally, through inhalation, intrarectally, and topically. The most common type of preparation is an oral medication. Oral preparations are usually easy to administer, have extended expiration dates, and are manufactured uniformly with respect to the content of the drug.

Tablets are the most commonly used oral form (Figure 2-1). A tablet may be scored or unscored. A scored tablet has indentions that have been made into its surface, allowing it to be broken into halves or quarters. Therefore, a scored tablet provides a way of administering a smaller dose to the patient. A tablet that is unscored may be cut into a smaller size with the use of a pill cutter device. However, scored tablets break more readily and are less likely to fragment. Some tablets whose drug type may be irritating to the gastrointestinal tract

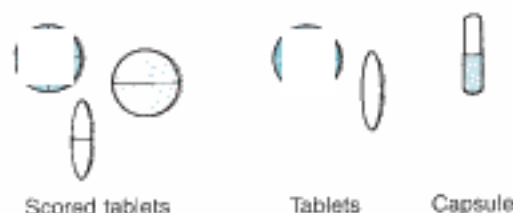

FIGURE 2-1

Tablets and capsules are the most common forms of oral medications.

may be enteric-coated. Capsules are containers that house medication. The capsule itself may be made of gelatin and glycerin. The contents of a capsule may be in powder or liquid form. Capsules may be advantageous to use because they allow a patient to be treated without an unpalatable taste coming into contact with the oral mucosa. Unfortunately, capsules cannot be broken down the way a scored tablet can to provide a smaller dose. Boluses are large rectangular tablets that may be scored or unscored. Boluses are used in the treatment of large animals (e.g., cattle, horses, sheep). Boluses usually are administered to bovines with the aid of a special instrument called a *balling gun*.

Liquid preparations for oral administration may be purchased in several different forms (e.g., mixtures, emulsions, syrups, elixirs). Mixtures consist of aqueous solutions (i.e., water) and suspensions for oral administration. A **suspension** usually separates after long periods of shelf life and must be shaken well before it is used, to provide a uniform dose. Syrups often are used as cough remedies; they contain the drug and a flavoring in a concentrated solution of sugar water or other aqueous liquid. In veterinary medicine, an antitussive (e.g., Torbugesic) may be mixed with a liquid vitamin (e.g., Lixotinic) to ensure a more palatable taste for the patient. **Elixirs** usually consist of a hydroalcoholic liquid that contains sweeteners, flavoring, and a medicinal agent. **Emulsions** consist of oily substances dispersed in an aqueous medium with an additive that stabilizes the mixture. All liquid oral medications should be administered slowly to allow the patient to swallow before more liquid is given. Rapid administration of oral medication can

result in aspiration into the lungs, thereby causing pulmonary problems.

Technician's Notes

Rapid administration of oral medication can cause the liquid to be aspirated into the lungs, thereby causing pulmonary problems.

Two forms of parenteral injection are available: injections and implants.

Two forms of parenteral injection that are available are injections and implants. Injections are available as single-dose vials, multidose vials, ampules, or large-volume bottles, which may be used to administer intravenous infusions (Figure 2-2). A vial is a bottle that is sealed with a rubber diaphragm. A vial may contain a single dose or multiple doses. A single-dose vial must be discarded after one use (dose). Multidose vials usually contain preservatives that enable them to have a longer shelf life; thus they may be used for more than one dose. Ampules contain a single dose of medication in a small glass container with a thin neck, which is usually scored so that it can be snapped off easily. Some drugs may be unstable in solution and may require reconstitution with sterile water or another diluent; these may be used immediately for injection (Procedure 2-1).

Technician's Notes

It is a good idea to place a paper towel over the neck of an ampule before breaking it, to protect the fingers from glass cuts.

Syringes and needles are used for parenteral administration of drugs (Box 2-1). This equipment must be sterile. Drugs should never be stored in syringes for a long time before administration occurs because some drugs may be absorbed into the plastic makeup of the syringe, resulting in an inadequate dose.

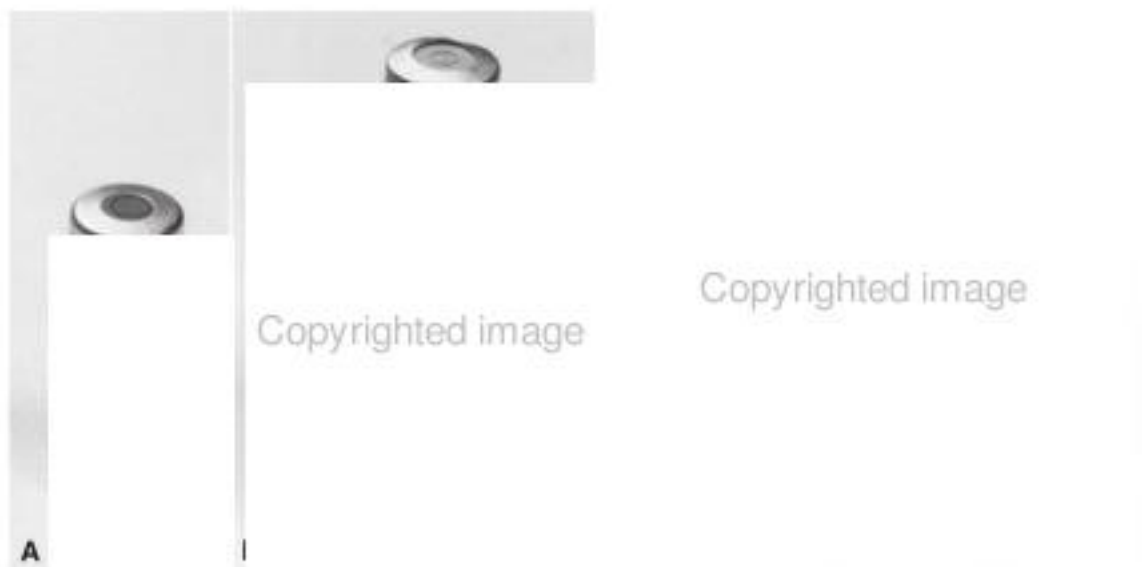

FIGURE 2-2

Parenteral medications are supplied in single-dose vials **(A)**, multidose vials **(B)**, ampules **(C)**, and large-volume bottles or bags used for intravenous administration **(D)**.

Table 2-1 Animal and Commonly Used Needle Gauges

Animal	Needle Gauge
Swine	16, 18
Cattle	16, 18
Horses	16, 18, 20
Dogs	20, 21, 22, 25
Cats	22, 25
Small exotics	23, 25, 27

PROCEDURE 2-1

Reconstitution of a Medication

Materials Needed

Syringe of adequate size for the amount of diluent with a needle attached
70% isopropyl alcohol
Cotton swab

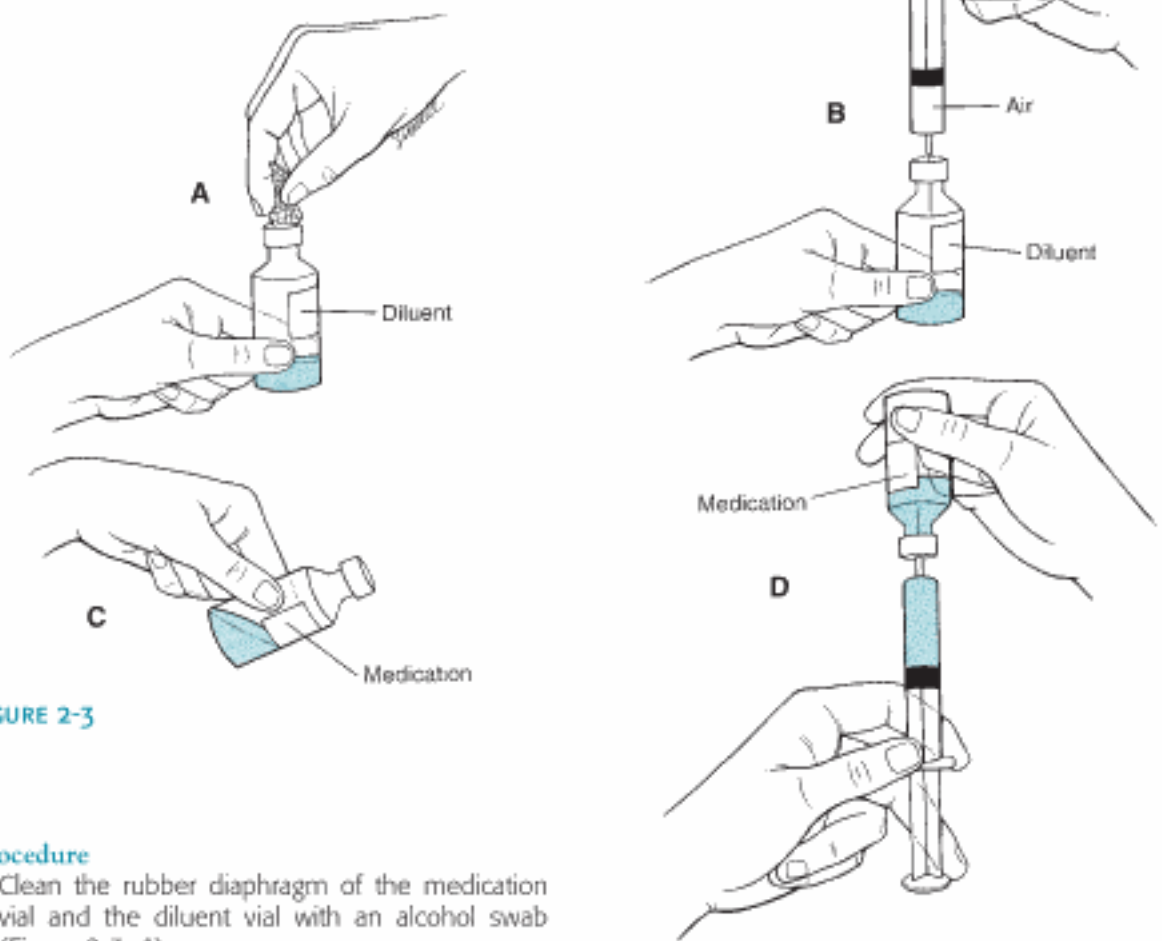

FIGURE 2-3

Procedure

1. Clean the rubber diaphragm of the medication vial and the diluent vial with an alcohol swab (Figure 2-3, A).
2. Remove the needle cap and pull back on the plunger to fill the barrel with air equal to the desired amount of diluent. Inject the air into the vial of diluent to create positive pressure and to ease withdrawal (Figure 2-3, B). Invert the diluent vial and withdraw the desired amount of diluent.
3. Inject the diluent into the medication vial and withdraw the syringe and needle. Shake the vial to mix well (Figure 2-3, C).
4. Positive pressure may be created in the freshly mixed medication vial before the desired amount of medication has been withdrawn. Once the medication has been withdrawn (Figure 2-3, D), label the syringe if needed, or administer the drug to the patient. After withdrawing the patient's medication, dispose of the vial, or store it according to the label.

BOX 2-1 Syringes and Needles

Syringes

Syringes are available in various sizes and styles. The most commonly used sizes are 3 ml, 6 ml, 12 ml, 20 ml, 35 ml, and 60 ml. Syringes may be ordered from the manufacturer with or without an attached needle. The tip of the syringe, where the needle attaches, can be one of four types: Luer-lok tip (Figure 2-4, A), slip tip (Figure 2-4, B), eccentric tip (Figure 2-4, C), or catheter tip (Figure 2-4, D). Each type of tip has its own advantages and disadvantages and is often chosen because of personal preference. A complete syringe consists of a plunger, barrel, hub, needle, and dead space (Figure 2-5). The area in which fluid remains when the plunger is completely depressed is called dead space.

Copyrighted image

Tuberculin syringe

A tuberculin syringe (Figure 2-6) holds up to 1 ml of medication. It usually is available with a 25-gauge or smaller attached needle. This syringe is commonly used for injections of less than 1 ml. Some tuberculin syringes have a dead space. Although the patient receives the proper amount of medicine, some liquid remains in this dead space, thus wasting the drug and costing the practice money. This is also important to remember when a tuberculin syringe is used to draw up controlled substances. The dead space will cause the controlled substance log book to reflect more of the controlled substance than is actually in the vial. Thus, the dead space should be considered when

Copyrighted image



FIGURE 2-4

Syringes are available with different tips, such as Luer-lok tip (A), slip tip (B), eccentric tip (C), and catheter tip (D). (Courtesy Sherwood Medical, St. Louis, Mo.)



FIGURE 2-5

The parts of a needle and syringe. (Courtesy Sherwood Medical, St. Louis, Mo.)



Copyrighted image

FIGURE 2-6

A tuberculin syringe with needle attached. (Courtesy Sherwood Medical, St. Louis, Mo.)

BOX 2-1 Syringes and Needle cont'd

amounts used are documented. Some tuberculin syringes are manufactured with low dead space or no dead space at all. In the case of syringes with no dead



FIGURE 2-7
A multidose syringe.

space, the needle screws into the TB syringe instead of attaching to the tip.

Multidose syringe

A multidose syringe (Figure 2-7) is commonly used for large animals when several animals require the same injection. It allows the user to set the dose and to give repeated injections until the barrel is empty of medication. This type of syringe may be disassembled and disinfected for reuse.

Insulin syringe

An insulin syringe (Figure 2-8) usually is supplied with a 25-gauge needle and, different from other syringes, it has no dead space. The syringe is divided into units instead of milliliters and should be used only for insulin injection.

Figure 2-9 illustrates the importance of being familiar with the different types of syringes and the units of measurement found on each. This is necessary to ensure that one can draw up an accurate amount of medication.



FIGURE 2-8
An insulin syringe with needle attached. (Courtesy Sherwood Medical, St. Louis, Mo.)

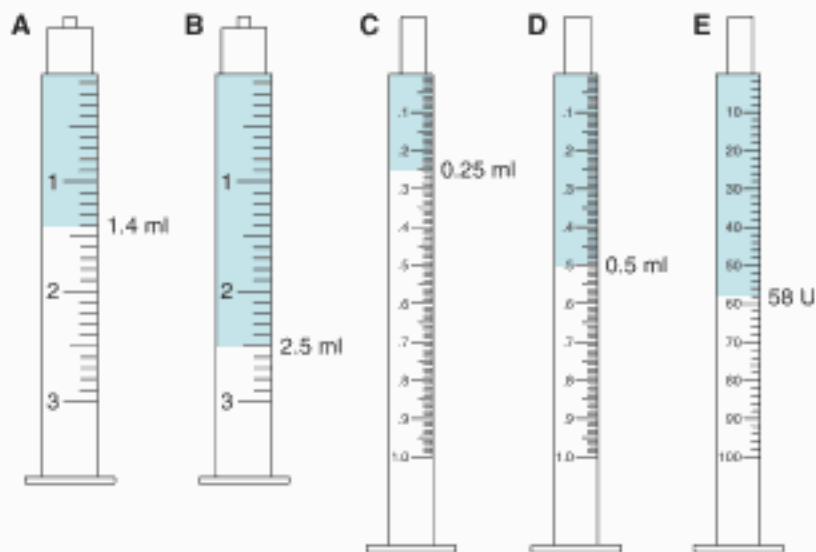

FIGURE 2-9
Examples of how to read amounts of medication contained in a syringe.

Continued

BOX 2-1 Syringes and Needles cont'd

Needles

Needles are available in various sizes and styles, but all needles have the following three parts: hub, shaft, and bevel (Figure 2-10). Needle sizes vary by gauge and by length (Table 2-1). The gauge refers to the inside diameter of the shaft; the larger the gauge number, the smaller the diameter. The length of the needle is measured from the tip of the hub to the end of the shaft. Lengths longer than 1 inch usually are used in large animals and occasionally for biopsy. The bevel is the angle of the opening at the needle tip. It is often helpful

when venipuncture is performed to have the beveled side of the needle facing up before the needle is inserted into the patient.

Bleeding needles (Figure 2-11) may be up to 3 inches long, are large gauge (14 to 16 gauge), and usually are used for obtaining blood from cattle and swine. These needles are made of stainless steel and are reusable after proper cleaning and disinfecting. Biopsy needles (Figure 2-12) are used for obtaining bone marrow or soft tissue and organ specimens. These needles vary in size and style.

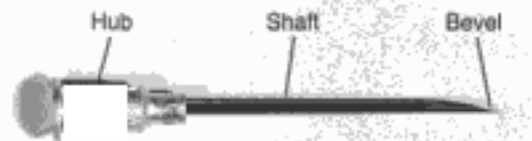
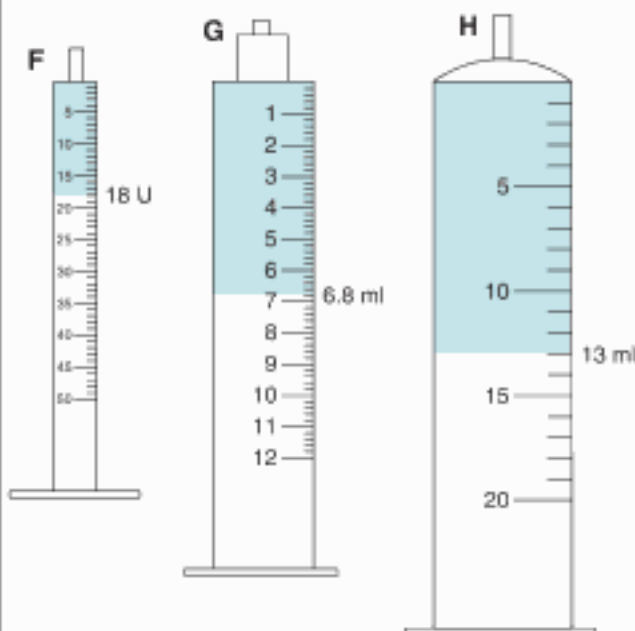

FIGURE 2-10

A needle consists of three parts: hub, shaft, and bevel.

FIGURE 2-9—cont'd



FIGURE 2-11

A 3-inch stainless steel bleeding needle.



FIGURE 2-12

A stainless steel biopsy needle.

Technician's Notes

All used needles should be discarded properly into a sharps container.

Implants are very hard sterile pellets that contain a chemical or a hormonal agent. Implants are inserted subcutaneously and are absorbed by the body over an extended time. Growth hormones are commonly manufactured in this form for use in cattle and are implanted in the subcutaneous dorsal aspect of the ear.

Topical medications are available in several forms. **Liniments** are medicinal preparations for use on the skin as a **counterirritant** or to relieve pain. Lotions are liquid suspensions or solutions with soothing substances that may be applied to the skin. An **ointment** is a semisolid preparation of oil and water, plus a medicinal agent. The water in an ointment evaporates after application and leaves the drug behind on the skin's surface. Dusting powders (e.g., flea powder) are mixtures of drugs in powder form for topical application. Additionally, powders may have adsorbent (corn starch) or lubricant (talcum) properties. Aerosols are drugs that have been incorporated into a suitable solvent and packaged under pressure with a propellant. Dusting powders and aerosols are common forms for some topical insecticides and wound dressings.

Microencapsulation is a drug form that stabilizes substances commonly considered unstable. Microencapsulation also may be used for drugs intended to be released slowly over a period of time (e.g., moxidectin [ProHeart injection]). (Note: ProHeart has been taken off the market.) When the drug's active ingredients are microencapsulated, a protective environment is formed against harmful substances and the stability of the product is improved. Microencapsulation completely masks the flavor of a drug and allows oral treatments to be administered with greater ease because the patient is unable to taste or smell the ingredients.

DRUG PRESERVATIVES AND SOLVENTS

In addition to the active ingredient, many drugs contain organic or inorganic agents as additives or pharmaceutical aids. These inactive (or inert) ingredients facilitate tablet administration, improve solubility, or increase stability. Although the quantity of inert ingredients is usually small, these ingredients can cause adverse effects, or a patient may be sensitive to or may smell the ingredients.

Parenterally administered drugs often contain chemical preservatives that are used to prevent destruction and loss of potency through oxidation or hydrolysis. The amount of preservative in the formulation of parenterally administered drugs is an optimal concentration and the reconstituted medication should be used immediately to prevent the possibility of fungal or bacterial growth. Dilution of the drug reduces the effectiveness of the preservatives. Most drugs are water soluble, although some may need additives to increase solubility. Glycols are one example of additives used to increase solubility. Generally, propylene glycol and polyethylene glycols are preferred.

Technician's Notes

Some vaccines may contain antibiotic preservatives. Care should be taken by personnel during reconstitution of these vaccines because liquid that escapes from the rubber seal of the vial could be sprayed inadvertently into an allergic person's eye (e.g., those persons with hypersensitivity to penicillin).

DRUG ADMINISTRATION

A veterinarian initiates administration of drugs for therapeutic purposes. (It is unlawful for a veterinary technician to prescribe drugs for an animal patient.) The role of the technician is to administer drugs to the patient on the order of a veterinarian. When doing this, a technician must always follow the *five rights*:

1. Right patient
2. Right drug—check label three times before administering the drug

3. Right dose
4. Right route
5. Right time and frequency

By following these rules, a technician will efficiently and effectively medicate a patient.

Oral Medications

The most common forms of drug therapy are tablets and capsules. These are easily administered (Procedure 2-2) and are sometimes used in conjunction with other drug forms.

PROCEDURE 2-2

Oral Administration of Tablets or Capsules for Dogs and Cats

Materials Needed

Medication in tablet or capsule form
Pilling gun (optional) (Figure 2-13)

Procedure

1. Hold the animal's upper jaw with one hand and apply pressure against the upper premolars to cause the mouth to open.
2. Push the medication over the tongue of the animal with the other hand or with the pilling gun (Figure 2-14).
3. Close the animal's mouth.
4. Initiate swallowing by blowing into the animal's nose and/or rubbing its throat (Figure 2-15).



FIGURE 2-13

Example of a small-animal pilling gun.

Copyrighted image

FIGURE 2-14

PROCEDURE 2-2

Oral Administration of Tablets or Capsules for Dogs and Cats—cont'd

Technician's Notes

Coating the tablet or capsule with a palatable substance such as Cat Lax, peanut butter, or canned food may help in pilling difficult animals.

Copyrighted image

FIGURE 2-15

Copyrighted image

FIGURE 2-16

A balling gun used to administer a bolus to large animals.

In large animals, a balling gun (Figure 2-16) is used to administer boluses. With proper restraint, this is usually not too difficult.

Liquid oral medications may be administered to small animals through a syringe with the needle removed (Procedure 2-3 and Figure 2-17) or, in some instances, through an orogastric or nasogastric tube. Most liquid medications are made palatable to ease administration. Oral liquid medications are used

Copyrighted image

FIGURE 2-17

A syringe without a needle may be used to administer oral liquid medication.

commonly in exotics and may be administered through the drinking water or an orogastric tube. In large animals, a stomach tube usually is used to administer oral liquid medications (Figure 2-18). In cattle, the stomach tube is passed through a Frick speculum (Figure 2-19).

Technician's Notes

Oral Medications

1. Remember when administering oral medications, that it takes longer for a drug to be absorbed into the bloodstream by this route as compared with parenteral injection.
2. Do not use oral administration in animals that are vomiting.

Copyrighted image

Copyrighted image

FIGURE 2-18

A large-animal stomach tube may be used to administer liquid medications to cattle or horses.

FIGURE 2-19

A Frick speculum can be used to facilitate passage of the stomach tube through the mouths of cattle.

PROCEDURE 2-3

Oral Administration of Oral Liquid Medication With a Syringe for Dogs and Cats

Materials Needed

Syringe with the needle removed or oral dose syringe
Oral medication in liquid form

Procedure

1. Fill syringe with the calculated amount of medication.
2. Tilt the animal's head up slightly.
3. Insert the tip of the syringe into the animal's cheek pouch (Figure 2-20).
4. Administer the medication slowly.

Technician's Notes

Attachment of a J-12 Teat Infusion Cannula (Jorgensen Laboratories, Loveland, Colorado) is handy for administering oral liquid medications.

Copyrighted image

FIGURE 2-20

Parenteral Medications

Parenteral administration (i.e., injection) of liquid medications may be used alone or in conjunction with other forms of medication. Some conditions are unfavorable for oral administration (e.g., in vomiting patients), and some drugs are available only for parenteral administration.

Approximately 10 routes are used commonly for parenteral administration of drugs; the most commonly used are the intramuscular, subcutaneous, and intravenous routes (Figures 2-21 to 2-23). A veterinary technician must be aware of the proper route of administration for each drug. For those in doubt, the route of administration usually is listed

Copyrighted material

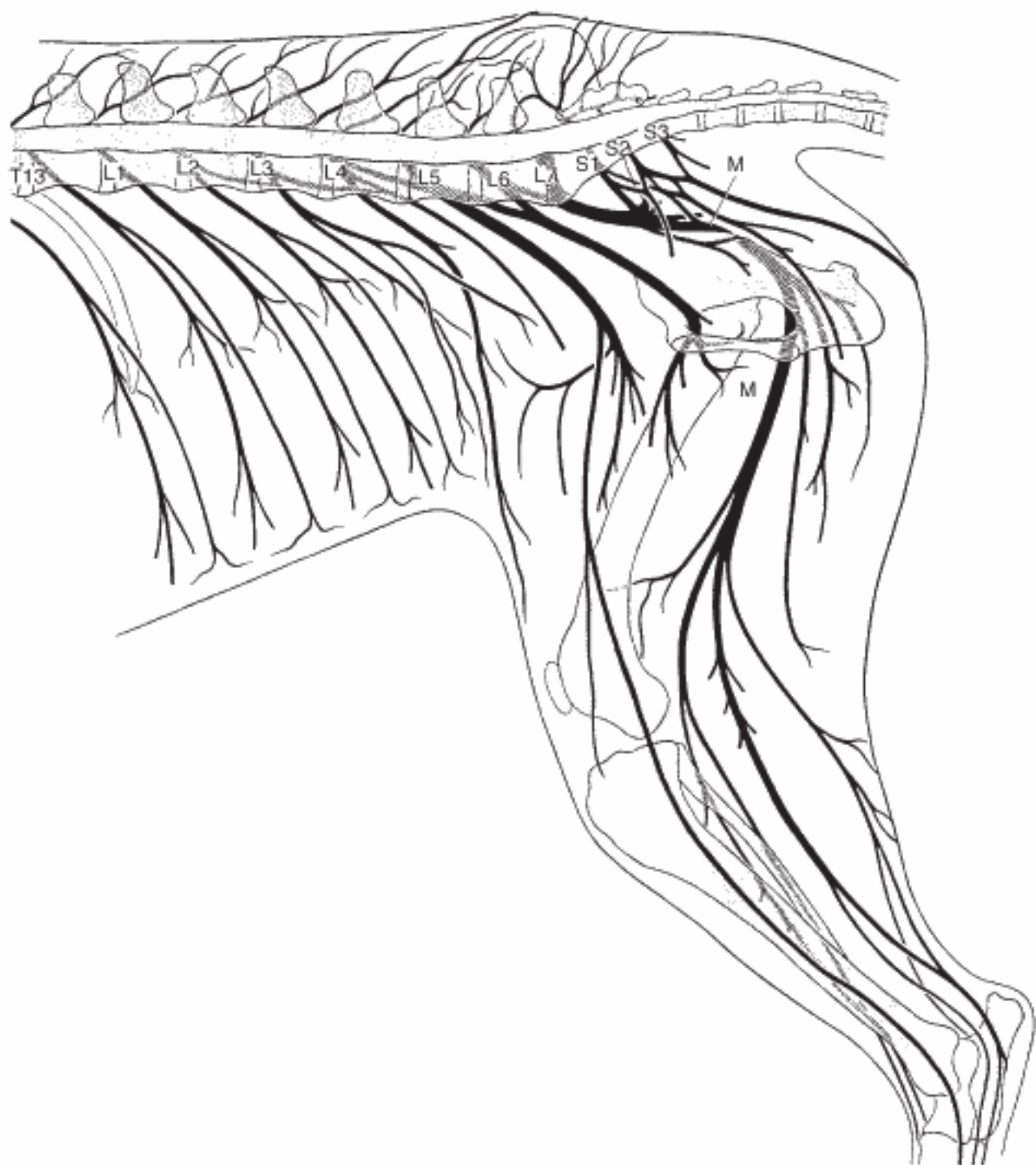
**FIGURE 2-21**

Intramuscular injections in the pelvic limb should be given in an area that avoids the large sciatic nerve, labeled as *M*.

Copyrighted image

FIGURE 2-22
Subcutaneous injection.

on the drug label or the package insert. Sometimes, complications may result after parenteral administration of a drug. Common complications include irritation, necrosis, and infection of the injection site. Sometimes, allergic reactions to medications may occur. Clinical signs of an allergic reaction after a parenteral drug has been administered include swelling around the face or extremities, raised bumps or swellings on the skin's surface, edema, and salivation. If any complications are observed, these should be reported immediately to the veterinarian. Care should be exercised when an intramuscular injection is administered, so that nerve damage or accidental injection into a vein or artery can be avoided. Negative pressure should be applied to the plunger of the syringe before an intramuscular (or subcutaneous) injection is performed. Should any blood be observed in the hub of the needle, the needle should be redirected or removed. Care should also be exercised when intraperitoneal injections are provided, so that peritonitis does not develop and damage to the abdominal viscera does not occur. Proper administration involves knowing (1) what equipment is needed, (2) how the dose should be calculated, and (3) the proper method for withdrawing and administering medication (Procedure 2-4).

Copyrighted image

FIGURE 2-23
Intravenous injection.

Intravenous (IV) administration allows the most rapid and effective drug administration (Procedure 2-5). IV therapy is used most commonly to maintain and restore fluid and electrolyte balance, to administer drugs, and to transfuse blood. IV administration also is used when the medication is contraindicated for other routes of administration. Sites for IV administration include the cephalic vein, the jugular vein, the lateral saphenous vein, and sometimes the femoral veins. Long-term IV therapy is best achieved with the cephalic or jugular veins.

In some cases, an animal may need repeated IV injections. The veterinarian may order the placement of an indwelling IV catheter in an effort to lessen vein damage and pain for the animal (Procedures 2-6 and 2-7).

Technician's Notes

An IV catheter must be removed after 72 hours and replaced with a new one. Time can be accounted for by writing (e.g., use a permanent marker) placement time on the adhesive bandage that secures the IV catheter in the animal's vein. Additionally, IV tubing should be changed after a 24- to 48-hour period.

PROCEDURE 2-4

Parenteral Administration of Medications—Intramuscular or Subcutaneous

Materials Needed

Syringe and needle (Figure 2-24)
 Parenteral medication
 Cotton swabs
 70% isopropyl alcohol

Procedure

1. If the syringe is not supplied ready-to-use, firmly attach the needle to the syringe.
2. Swab the bottle's rubber diaphragm with cotton that is saturated with alcohol.
3. Remove the needle cap, insert the needle at an angle into the rubber diaphragm, and withdraw the calculated amount of the drug.
4. Hold the syringe with the needle pointing upward, and remove the large air bubbles by briskly tapping the barrel of the syringe.
5. Release the air bubbles by slightly pushing on the syringe plunger. Carefully replace the needle cap if the medication is not to be given immediately. Avoid contamination.
6. Swab the injection site with another cotton swab that is saturated with alcohol.

7. Insert the needle into the appropriate site and pull slightly on the plunger. If no blood is seen, inject the medication and remove the needle from the site. Blood indicates that a vessel has been entered. Withdraw the needle and continue with the same procedure at a different site.
8. Massage the injection site to aid distribution and decrease pain.
9. Properly dispose of the syringe and needle.

Guidelines for Parenteral Doses

- Round up to the nearest tenth if the amount is greater than 1 ml, and measure in a 3-ml syringe.
- Measure amounts less than 1 ml in a tuberculin (TB) syringe.
- In cats weighing less than 9 lb, 0.5 to 1.0 ml is an appropriate amount for intramuscular (IM) injection.
- In cats weighing more than 9 lb, 1 to 1.5 ml is an appropriate amount for IM injection.
- In dogs weighing up to 10 lb, 0.5 to 1 ml is an appropriate amount for IM injection.
- In dogs weighing 10 to 30 lb, 1 to 2 ml is an appropriate amount for IM injection.
- In dogs weighing more than 30 lb, 2 to 4 ml is an appropriate amount for IM injection.



FIGURE 2-24

(Courtesy Sherwood Medical, St. Louis, Mo.)

Technician's Notes

Injecting multidose vials with air sometimes allows easier withdrawal of medication.

PROCEDURE 2-5

Parenteral Administration of Medication—Intravenous Direct Bolus

Materials Needed

Syringe containing calculated dose with needle attached

Cotton swabs

70% isopropyl alcohol or surgical scrub

Butterfly catheter (scalp vein needle, Figure 2-25)
—optional

Syringe containing 3 ml of flushing solution (e.g., heparinized saline: 500 IU sodium heparin in 250 ml of normal saline)

Tape (optional)

Procedure Without Catheter

1. Clip the area over the venipuncture site, if desired.
2. Prepare the area with alcohol swabs or surgical scrub.
3. Have the restraint person hold pressure on the vein or use a tourniquet.
4. Perform venipuncture with the medication syringe and needle. If blood enters the hub of the needle, the venipuncture is successful.
5. Release pressure from the vein and proceed to inject the medication over the recommended time interval.

6. Remove the needle and apply pressure to the site to stop bleeding.
7. A bandage made of tape and cotton may be applied, if needed.

Procedure With a Butterfly Catheter

Proceed with steps 1 through 3 as described in the previous section (McCurnin and Bassert, 2006).

1. Remove the cap from the catheter tubing and needle cover.
2. Perform venipuncture with the catheter. If this is successful, blood will return into the catheter tubing.
3. Release pressure from the vein, and allow the blood to fill the catheter tubing.
4. Remove the needle from the medication syringe and attach the syringe hub to the catheter tubing.
5. Administer the medication at the recommended time interval.
6. Remove the needle from the syringe containing the flushing solution. Remove the medication syringe from the catheter and attach the syringe containing the flushing solution.
7. Flush the catheter with 1 to 2 ml of solution to ensure administration of all medication.
8. Remove the catheter and apply pressure to the site to stop the bleeding.
9. A bandage may be applied as described earlier.
10. Properly dispose of all syringes and needles in an approved sharps container.



FIGURE 2-25
Butterfly catheter.

Technician's Notes

Watch for swelling at the injection site. Swelling may signal extravascular injection. Notify the veterinarian immediately if this should occur.

PROCEDURE 2-6**Administration by Bolus With an Indwelling Intravenous Catheter****Materials Needed**

Syringe containing flushing solution (about 3 ml)
70% isopropyl alcohol
Cotton swabs
Syringe with medication and attached needle

Procedure

1. Clean the cap of the indwelling catheter with an alcohol swab.
2. Insert into the catheter cap the needle of the syringe containing the flushing solution. (Use the smallest-gauge needle possible to help prevent a leak in the catheter cap.)
3. Gently aspirate to determine correct placement of the catheter (blood entering the hub shows proper placement).
4. Inject half the flushing solution into the catheter. Observe the area over the vein for swelling.
5. Remove the syringe and needle, and carefully replace the cap to prevent contamination.
6. Insert into the catheter cap the needle of the syringe containing the medication, and inject the medication over the recommended time interval.
7. Remove the syringe and needle from the catheter.
8. Flush the catheter with the remaining flushing solution.

9. Observe the area for swelling and look for signs of discomfort. Report any abnormal observations to the veterinarian.
10. Properly dispose of syringes and needles.

Technician's Notes

Some hospitals may require that with flushing solution, two syringes should be used instead of the same syringe and needle for both flushes. Keep additional male adapter plugs (catheter caps) (Figure 2-26) in stock to replace a leaky cap.

FIGURE 2-26

Examples of a male adapter plug. (Manufactured by Abbott Laboratories, Abbott Park, Ill.)

PROCEDURE 2-7**Administration of Intravenous Fluids****Materials Needed**

Indwelling catheter (Figure 2-27)

Tape

70% isopropyl alcohol or surgical scrub

Infusion set

IV fluids

Clippers

Procedure

1. Remove the IV tubing from the container and the protective covering from the medication bottle or bag.
2. Remove the covering of the diaphragm of the medication bag or bottle.
3. Close the clamp on the IV tubing. Remove the cap of the IV tubing spike and insert it into the diaphragm of the medication bag or bottle.
4. Squeeze the drip chamber to allow fluid to collect in the chamber. Fill to the designated line or about half full.
5. Remove the protective cap from the end of the IV tubing and slowly open the roller clamp to allow the fluid to clear the tubing of air. Replace the protective cap and hang the medication bag or bottle on the IV pole near the patient.
6. Clip and scrub the chosen site for catheter placement.
7. After successful catheter placement, cap the catheter, wipe away any blood, and quickly tape in place. The time of placement should be recorded on the adhesive tape with a permanent marker.
8. Remove the catheter cap and the protective cap of the IV tubing and insert the end of the tubing directly into the end of the catheter. Or, if desired, a needle may be placed on the end of the tubing and inserted into the catheter cap.
9. Open the clamp to begin a slow drip and lower the medication bag or bottle to below the IV site to confirm correct placement.
10. Return the bottle or bag to the IV pole and set at desired flow rate.
11. Tape the tubing to the patient at the catheter site.

Technician's Notes

1. Mark the fluid level and time on tape placed on the bag with a permanent marker (tape can be used on bottles). Use this procedure each time the patient is checked.
2. If any medications are added to the fluids, write the medication, time, and amount on the medication bag or tape.
3. Tape the catheter cap to the bag or bottle so that it will be ready when needed.

FIGURE 2-27

A 14-gauge indwelling catheter. (ABBOCATH is a registered trademark of Abbott Laboratories, Abbott Park, Ill.)

PROCEDURE 2-8

Administration by Bolus Using the Y-Injection Site

Materials Needed

Syringe with medication and the needle attached
Cotton swabs
70% isopropyl alcohol

Procedure

1. Close the clamp on the infusion set.
2. Clean the Y-injection site (Figure 2-28) with an alcohol swab.



FIGURE 2-28

Intravenous set with Cair clamp and Y-injection site.

3. Insert the needle of the medication syringe into the Y-injection site.
4. Inject the medication over the recommended time interval.
5. Remove the medication syringe and needle.
6. Open the clamp on the infusion set. Allow enough fluid to flow through the infusion set to ensure that all medication is received. Then return to the desired flow rate.
7. Properly dispose of the syringe and needle.
8. *Note:* No flushing solution is required for this procedure.

Technician's Notes

To check for proper placement of the IV catheter, remove the bag of fluids from the IV pole and hold the bag and tubing below the level of the catheter (do not close the clamp on the infusion set). If blood returns into the tubing, the catheter is properly placed. Return the bag to the IV pole and continue fluid administration.

If the patient is receiving IV fluids, the Y-injection site (see Figure 2-28)—located on the IV tubing—may be used to administer medications by direct bolus (see Procedure 2-8). When medications are to be administered continuously and for long periods, the IV tubing must be changed after a 24- to 48-hour period. Once the medication bottle or bag has been emptied, replacement is necessary to facilitate care of the patient. An indwelling catheter must be removed after 72 hours and replaced with a new one in a different vein location (McCurnin, 2006). If the IV catheter is not used continuously, it should be flushed with heparinized saline every 8 to 12 hours.

A simplex (i.e., gravity set) IV set is used to administer medications or fluids intravenously to large animals (Figure 2-29). This administration set may be disinfected and reused. Disposable IV sets and large-volume fluid bags are available for large animals that require continuous IV therapy.

In pediatric patients and small exotics, IV medications may be administered by intraosseous cannulation. This route also may be used in larger patients when rapid administration of fluids or drugs is necessary and a vein is not readily available. If needed, large volumes of fluid may be administered in this manner.



FIGURE 2-29
A large-animal intravenous set.

In some veterinary hospitals, use of an infusion pump may facilitate continuous IV administration. Once the necessary flow rate is known (the rate is ordered by the veterinarian), the technician can set the infusion pump to deliver a constant amount of solution per minute or hour. To determine the pump settings, the technician considers the total amount of solution to be given and the time interval for infusion. The operating instructions for the infusion pump should be followed because each model may operate in a slightly different manner.

Technician's Notes

It should be remembered that any patient on IV fluid therapy should be monitored every 15 to 30 minutes.

Monitoring involves evaluating drip rate; ensuring that the IV catheter is properly placed in the vein; making sure the patient has not moved around in the cage to such an extent that the IV tubing has become kinked; and, most important, ensuring that the patient has not chewed the IV catheter out. Animals can do surprising things, and it is up to the technician to provide an excellent level of nursing to ensure that no harm comes to the patient.

Technician's Notes

Parenteral Medications

1. Some liquid medications for parenteral administration may "settle out" or precipitate (e.g., penicillin, Vetalog). Therefore these medications should be shaken gently to mix the solution before it is injected into the patient.
2. Drugs that may cause tissue irritation are administered by the intravenous route (e.g., pentothal, vincristine). Therefore, one should be sure to check the drug's package insert to identify the correct way to administer the drug.

Intramuscular Injections

1. Ketaset can be administered by intramuscular injection. Ketaset has a tendency to burn upon injection, and careful restraint methods, along with rapid injection of this drug, should be used in cats.
2. Upon insertion of the needle into the chosen muscle, always apply negative pressure to the syringe's plunger to be certain that the needle has not entered a blood vessel. If blood is seen in the hub of the syringe, remove and redirect the needle.

Subcutaneous Injections

1. Most vaccines can be administered subcutaneously. However, the intrascapular area should always be avoided when subcutaneous injections are given.

Inhalation Medications

In veterinary medicine, inhalation is used primarily to produce anesthesia. The inhalant gas is placed into the anesthetic machine in liquid form and then is vaporized through the machine and delivered to the patient via an endotracheal tube, an anesthetic gas mask, or an induction chamber (Figures 2-30 to 2-32). Medications occasionally may be nebulized to treat an upper respiratory tract (URT) problem, and oxygen may be delivered to a patient with dyspnea with the use of inhalation techniques.



FIGURE 2-30
Endotracheal tube with cuff.

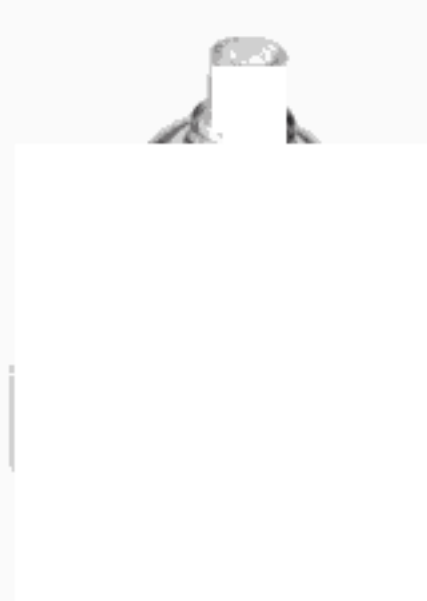

FIGURE 2-31
A small-animal anesthetic mask.

Topical Medications

Topical administration of medicine involves application of drugs (creams, ointments, and drops) to the body's surface. Topical preparations usually provide local effects instead of systemic ones. Clipping hair from the affected area provides better visualization during treatment and makes application easier and absorption faster. The technician should observe the area after treatment and should report



FIGURE 2-32
A small-animal induction chamber.

adverse reactions to the veterinarian. The technician should provide client education regarding skin medications, including information on frequency and number of applications. Many clients apply too much medication, which not only is unnecessary but can be quite costly with some medications.

Ophthalmic drugs are supplied as an ointment or a solution. The eyes have the ability to remove foreign substances rapidly. Therefore, these preparations usually are applied several times a day. Application frequency depends on the disease or disorder, the drug, and the type of formulation. When ophthalmic preparations are applied, the hand that is holding the medication should rest on the animal's head above

the affected eye (Figure 2-33). Drops should be placed at the inner canthus of the eye. If application of ointment is necessary, a small strip should be applied along the lower palpebral border, with assurance that the applicator tip does not come into contact with the eye or conjunctiva. When you are demonstrating to a client how to apply eye medications, point out that the applicators have blunt tips. Therefore, should the applicator tip inadvertently touch the eye, no harm should occur.

Drugs may be applied topically to the ears for local effect to soften **cerumen** and ease its removal, or to treat a superficial infection or ear mites. Cleaning of the ears before otic medication is applied aids the effectiveness of treatment. The veterinary technician should provide instruction to

the client regarding the correct ways to clean ears and to apply ear medication. By explaining the ear's anatomy, the technician can assure the client that it is difficult to reach the animal's eardrum when one is swabbing the ear clean.

MEDICATION ORDERS

In a veterinary hospital, most medication orders are written or verbal. A written order may be provided in prescription form or may be noted in the medical record. Verbal orders are given directly to the technician by the veterinarian. When filling a prescription, the technician must be familiar with abbreviations frequently applied to the medical record to describe drug therapy. Appendix A lists abbreviations commonly used in veterinary medicine. The technician must know the patient being treated, the route of administration used, and the frequency of administration. This information is described in the medication order. After the medication has been administered to the patient, a notation should be made in the medical record describing when, what, how, and by whom the medication was administered. Observations of the patient's progress should be noted in the medical record (Figure 2-34). If the medication order is a prescription (Figure 2-35) to be filled, the order should be dated and noted in the medical record (Figure 2-36). If the owner picks up the prescription at the veterinary hospital, the medical record should be retrieved and presented to the veterinarian for approval of the refill. The same procedure as described earlier should be followed for dispensing medication.

FIGURE 2-33

Ointment is applied to the dog's eye on the lower palpebral border.

6-18-95 9:30 AM patient B&A
 T-102°
 250 mg Amoxi PO, flushed IV catheter with
 heparinized saline, continue IV LR at
 15 gtt/min C. Smith, LVMT

FIGURE 2-34

After medication is administered to a patient, a notation should be made in the patient's medical record.

PET CARE ANIMAL HOSPITAL	
1554 Straight Road Anytown, USA 12345 455-555-1222	
Patient <u>Tuffy Fox</u>	Date <u>8/28/98</u>
<i>Sporanox</i> <i>1 capsule po bid x 3 wks</i> <i>give with food</i>	
<u>Sarah Jones, DVM D.V.M.</u> DISPENSE AS WRITTEN	
_____ D.V.M.	<u>0</u> Refills
SUBSTITUTION ALLOWED _____	DEA # _____

FIGURE 2-35
Sample prescription order.

4-10-95 Rx per Dr. Smith
 Amoxi 250 mg 1 tab po bid x 10 days
 Bute 100 mg 2 tab po sid x 3 days
 give c̄ food K. Jones, LVMT

FIGURE 2-36
Prescriptions should be written in the patient's medical record.

CONTROLLED SUBSTANCES

Substances that have the ability to become habit-forming for humans are labeled as *controlled substances*. The Drug Enforcement Agency (DEA) requires that the upper right corner of the original container should show a code containing a capital C (controlled), followed by a Roman numeral indicating one of the five schedules defined by the *Code of Federal Regulations*. Because some of these drugs may be misused, the DEA requires that they be kept in an unmovable locked area, and that an inventory

log be kept to report amounts used and on hand (Figure 2-37). Each time a controlled drug is administered or dispensed to a patient, this must be reported in the controlled substance inventory log, as well in the patient's medical record. This documentation should include the following: (1) date, (2) owner's name, (3) patient's name, (4) drug name, (5) amount administered or dispensed, and (6) the names of veterinary personnel who dispensed the drug. If the drug is to be dispensed, the label must bear the following warning: "Caution: Federal law prohibits the transfer of this drug to any

Drug: diazepam

Patient	Owner	Beginning	Administered	On hand	Initials
Toy	Smith	5 ml	0.2 ml	4.8 ml	BD/JC
Prissy	Potts	4.8 ml	0.15 ml	4.65 ml	LW/RW
Gilbert	Pettes	4.65 ml	0.5 ml	4.15	LW/RW
T.J.	Curtis	4.15 ml	0.2 ml	3.95	BD/JC

FIGURE 2-37

Example of a controlled substance inventory log.

person other than the patient for whom it was prescribed" (Webb and Aeschbacher, 1993). A list of the controlled substances most commonly used in veterinary medicine is available in Appendix D.

*Technician's Notes***Drug Storage**

1. The manufacturer's instructions should be followed closely to facilitate safe storage.
2. Some drugs are sensitive to light and humidity.
3. The location of the pharmacy in a veterinary hospital should not be accessible to the public.

CLIENT EDUCATION

Veterinary technicians should make themselves familiar with all administered and dispensed drugs. Often, it is the technician's duty to educate clients

about how a medication should be administered and why it has been prescribed, and about any adverse reactions that may occur. The technician should consult the veterinarian to gather information about any questions that he or she cannot answer. If needed, written information about the medication should be available for the client's reference purposes.

REFERENCES

- McCurnin DM, Bassett JM, editors: Clinical textbook for veterinary technicians, ed 6, Philadelphia, 2006, Elsevier Saunders.
- Webb AI, Aeschbacher G: Animal drug container labels: a guide to the reader, JAVMA 202:10, 1993.



REVIEW QUESTIONS

- Name four common drug preparations.

- Boluses are used in the treatment of _____ animals and are administered with a _____.
- Name two types of parenteral injection forms.

- Vials may be either _____ dose or _____ dose.
- All used needles should be discarded in a _____.
- Name the five rights of drug administration.

- Oral drugs should never be administered in animals that are _____.
- Intravenous administration of drugs allows the most _____ and effective drug administration.
- An indwelling catheter should be replaced with a new one every _____ hours.
- A simplex (i.e., gravity set) IV system is used to administer fluids to _____ animals.
- Name six items that should be recorded in the controlled substance log.
- Why should drugs given by injection not be stored in syringes for any length of time before administration? _____.
- List four types of syringe tips that are available for use. _____.
- A tuberculin syringe holds up to _____ ml of medication.
- What type of syringe is divided into units rather than milliliters?
- A(n) _____ is an agent that produces superficial irritation that is intended to relieve some other irritation.
 - elixir
 - emulsion
 - liniment
 - counterirritant
- A(n) _____ will usually separate after long periods of shelf life and must be shaken well before use to provide a uniform dose.
 - elixir
 - antimicrobial
 - suspension
 - anthelmintic
- This type of syringe is constructed in such a way that the needle screws onto the tip of the syringe.
 - slip tip
 - eccentric tip
 - catheter tip
 - Luer-lok tip
- All the following are sites for IV administration in small animals, except:
 - jugular vein
 - carotid artery
 - lateral saphenous vein
 - phalic vein
- An indwelling catheter must be replaced every _____ hours.
 - 48
 - 24
 - 60
 - 72
- If an IV catheter is not used continuously, it should be flushed with heparinized saline every _____ to _____ hours.
 - 6; 12
 - 4; 18
 - 8; 12
 - 8; 10
- Cerumen is a substance that is commonly found in what anatomic part of the body?
 - urinary bladder
 - ear
 - rectum
 - crown of the tooth

23. Any patient on IV fluid therapy should be monitored every ___ to ___ minutes.
- a. 1; 2
 - b. 15; 30
 - c. 90; 120
 - d. 60; 120
24. IV tubing should be changed after a ___- to ___-hour period.
- a. 12; 24
 - b. 12; 48
 - c. 12; 36
 - d. 24; 48
25. When an intramuscular injection is given in the pelvic limb of a dog or cat, the area near the _____ nerve should be avoided.
- a. radial
 - b. sciatic
 - c. ischiatic
 - d. both b and c

Dosage Calculations
Solutions
Percent Concentrations
Calculations Involving Concentrations
Milliequivalents
Calculations Involving IV Fluid
Administration
Calculations for Constant Rate Infusion
Problems

CHAPTER 3

Practical Calculations in Pharmacology

LEARNING OBJECTIVES

After studying this chapter, you should be able to:

1. Exhibit an understanding of the systems of measurement.
2. Explain how to perform conversions while using the metric system and other systems of measurement.
3. Demonstrate how to perform dosage calculations.
4. Explain how percent concentrations are prepared.



KEY TERMS

EQUIVALENT WEIGHT 1 g molecular weight (from periodic chart) divided by the total positive valence of the material.

MILLIEQUIVALENT 1/1000 of an equivalent weight. A term used to express the concentration of electrolytes in a solution.

INTRODUCTION

Veterinary technicians often are called on to prepare and administer medications to animal patients. A veterinarian's orders may call for administration of a specific number of milligrams or units of medication (dose). The technician then must determine the quantity (in milliliters, tablets, and so forth) of the preparation that contains the appropriate dose. In other instances, the technician may be called on to calculate the dose on the basis of a dosage rate (found in the insert or in reference books) and the animal's weight. In either case, an error in calculation can seriously affect the health of a patient. This chapter provides the background information and applications needed by the veterinary technician to accurately carry out a veterinarian's medication orders.

MATHEMATICS FUNDAMENTALS

It is assumed that the student who uses this text has a basic understanding of fractions and decimals. With these fundamentals as a background, the concepts of percent, ratio, and proportion should be reviewed before the practice problems are solved.

Percent is defined as parts per hundred. Percent is a fraction with the percent as the numerator and 100 the denominator (e.g., $5\% = 5/100$). Percents may be written as decimals, fractions, or whole numbers.

Example 1: Decimal: 0.3%
(three-tenths percent [$3/10 \div 100$])
Fraction: $1/5\%$
(one-fifth percent [$1/5 \div 100$])
Whole number: 5%
(five percent [$5 \div 100$])

Percent may be changed to fractions or decimals.

Example 2: Change to a fraction:
 $5\% = 5/100 = 1/20$
Change to a decimal:

$$5\% = 5/100 = 0.05$$

Note that a percent can be changed to a decimal quickly by dropping the percent sign and moving the decimal two places to the left.

Example 3: $5\% = 0.05$

A ratio is a way of expressing the relationship of a number, quantity, substance, or degree between two components. In reality, ratios are fractions, with the first number in the ratio the numerator and the second number the denominator. The numbers may be placed side by side, separated by a colon, or they may be set up as a numerator/denominator (e.g., 1:5, $1/5$). In mathematics, a ratio may be expressed as a quotient, a fraction, or a decimal, per the following:

Example 4: $1 \div 5$, $1/5$, $5/1.0 = 0.2$

A *proportion* shows the relationship between two ratios. When a proportion is set up, the two ratios usually are separated by an = (equals) sign.

Example 5: 8:16 1:2 or $\frac{8}{16} = \frac{1}{2}$

The proportions above read "8 is to 16 as 1 is to 2." The two inner numbers in the first example (16 and 1) are called the *means*, and the two outer numbers (8 and 2) are called the *extremes*. In a true proportion, the product of the means equals the product of the extremes ($16 \times 1 = 16$; $8 \times 2 = 16$). This fact makes the proportion a useful mathematical tool. When a part of the

problem is unknown, “X” can be substituted for the unknown part in the proportion and the equation solved for “X.” Care must be taken to ensure that the proportion is set up correctly, and that the same unit of measure is used on both sides of the equation.

Example 6: $8:16=1:X$ or $\frac{8}{16} = \frac{1}{X}$
 $8X=16$
 $X=2$

Example 7: To convert 0.2 g to milligrams, calculate the following:

$$1000 \text{ mg}:1 \text{ g} = X \text{ mg}:0.2 \text{ g} \text{ or } \frac{1000 \text{ mg}}{1 \text{ g}} = \frac{X \text{ mg}}{0.2 \text{ g}}$$

$$X = 200(1000 \times 0.2)$$

SYSTEMS OF MEASUREMENT

The first step in the successful calculation of doses is to develop an understanding of the units of measure used to carry out the calculations. These units are components of the following three separate systems:

1. Metric system
2. Apothecary system
3. Household system

All three systems are expressed in the fundamental units of weight, volume, and length. Technicians

should be able to convert values within each system and between the three systems.

Metric System

The fundamental units of measurement in the metric system are the gram (weight), the liter (volume), and the meter (length). Gram is abbreviated g or gm, liter is abbreviated L or l, and meter is abbreviated m. The usefulness of the metric system is that all units are powers of the fundamental units. Prefixes are used in combination with fundamental units to denote smaller or larger quantities. Table 3-1 illustrates the units of measurement used in the biologic sciences.

The units that are used most commonly in dosage calculations include the gram, the kilogram (kg; 1000 g), the milligram (mg; 1/1000 g), and the milliliter (ml; 1/1000 L). It should be noted that a milliliter is equivalent to the quantity of water contained in 1 cubic centimeter (cc), which is also equivalent to 1 g of weight. Therefore, for practical purposes, it may be said that 1 ml = 1 cc = 1 g.

On occasion, the microgram (μg) may be used. (It should be noted that this unit also may be abbreviated as mcg.) Care should be taken to differentiate this abbreviation from mg, which looks very similar when written orders are used.

Conversion Between Metric Units

The most fundamental way to convert between metric units is to multiply the units given by the conversion factor involving the units desired. If the desired

Table 3-1 Units of Measure for the Biologic Sciences

Weight	Volume	Length	Multiple Power of 10
Gram (g)	Liter (L)	Meter (m)	1
Kilogram (kg)	Kiloliter (kl)	Kilometer (km)	1000
Decigram (dg)	Deciliter (dl)	Decimeter (dm)	1/10
Centigram (cg)	Centiliter (cl)	Centimeter (cm)	1/100
Milligram (mg)	Milliliter (ml)	Millimeter (mm)	1/1000
Microgram (μg)	Microliter (μl)	Micrometer (μm)	1/1,000,000
Nanogram (ng)	Nanoliter (nl)	Nanometer (nm)	1/1,000,000,000
Picogram (pg)	Picoliter (pl)	Picometer (pm)	1/1,000,000,000,000

conversion is from milligrams (mg) to grams (g), the number of milligrams given should be multiplied by the factor $1\text{ g}/1000\text{ mg}$ because $1\text{ g} = 1000\text{ mg}$. The following steps would be involved in this conversion:

1. Write down the number of milligrams to be converted to grams.
2. To the right of that number, write down the number of milligrams in 1 g, with the milligrams as the denominator. (The numerator should always contain the unit to which you wish to convert.)
3. Multiply the two numbers together.

Example 1: Convert 3000 mg to grams.

1. 3000 mg
2. $3000\text{ mg} \frac{1\text{ g}}{1000\text{ mg}}$
3. $3000\text{ mg} \times \frac{1\text{ g}}{1000\text{ mg}} = 3\text{ g}$

Figure 3-1 illustrates the stairstep method of converting from one unit to another within the metric system. When converting measurements in the metric system via the stairstep method, divide by 10 for each step up to the desired measurement, and multiply by 10 for each step down to the desired measurement.

You also may think of converting measurements with this method by remembering that for each step up, the decimal point is moved one place to the left. For each step down, the decimal point is moved one place to the right.

Example 2: $500\text{ ml} = \underline{\hspace{2cm}}\text{ L}$

Conversion of milliliters to liters requires three steps upward. Therefore, divide 500 by 10 three times (or $500 \div 1000$). This moves the decimal point three places to the left, and the answer is $500\text{ ml} = 0.5\text{ L}$.

Example 3: $2\text{ g} = \underline{\hspace{2cm}}\text{ mg}$

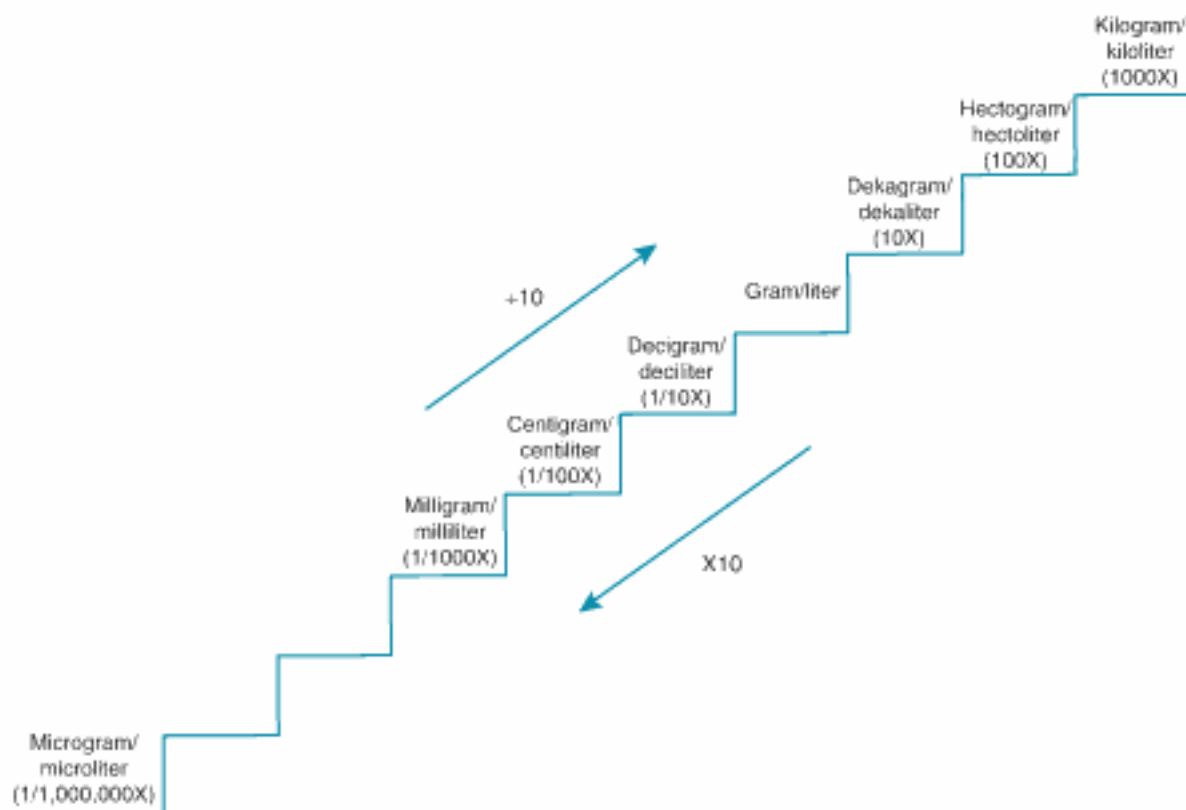

FIGURE 3-1

The stairstep method for converting within the metric system. For each step up the stairs, divide the given amount by 10. For each step down the stairs, multiply the given amount by 10.

To convert grams to milligrams, go down three steps. Multiply 2 by 10 three times (or 2×1000). This moves the decimal point three places to the right, and the answer is $2 \text{ g} = 2000 \text{ mg}$.

A second method for performing conversions in the metric system can be called the *arrow method*. When this method is used, it is paramount to remember which units of measure are larger. Conversions between the commonly used units of kilograms, grams, milligrams, and micrograms are illustrated in the following text.

A kilogram is 1000 times larger than a gram (g), a gram is 1000 times larger than a milligram (mg), and a milligram is 1000 times larger than a microgram (mcg). This relationship can be abbreviated as follows with the use of the "greater than" symbol (>):

$$\text{kg} > \text{g} > \text{mg} > \text{mcg}$$

Many times, the technician will have to calculate the amount of drug to be given when the supply on hand is not measured in the same units as the order calls for. For example, the order is for 0.3 g of drug A, and the supply on hand is 150-mg tablets. Before it can be determined how many tablets should be given, 0.3 g must be converted to milligrams. Because it is known that $1 \text{ g} = 1000 \text{ mg}$, 0.3 g can be changed to milligrams by multiplying 0.3 g by 1000 mg/g ($0.3 \times 1000 = 300 \text{ mg}$). The decimal point is moved three places to the right ($0.3 \rightarrow 3\underset{1}{0}\underset{2}{0}\underset{3}{0}$).

The conversion could have been made very quickly by simply moving the decimal point three places to the right. To know which direction to move the decimal, one should determine which way the arrow is pointing (e.g., $\text{kg} > \text{g} > \text{mg} > \text{mcg}$).

Any time the conversion is made between two adjacent units in the relationship of $\text{kg} > \text{g} > \text{mg} > \text{mcg}$, the decimal point will be moved three places.

The steps for converting grams to milligrams with the use of this method are as follows:

1. Write down the order first, using the units called for (0.3 g).
2. Write down the equivalent units (on hand) needed next to the order units ($0.3 \text{ g} = \underline{\quad} \text{mg}$).
3. Place an arrow between the two units, with the closed part of the arrow pointing toward the smaller unit ($\text{g} > \text{mg}$).
4. Move the decimal point three places in the direction the arrow points ($0.3 \text{ g} \rightarrow 3\underset{1}{0}\underset{2}{0}\underset{3}{0}$).

In the previous problem, it would take two 150-mg tablets to fill the 300-mg order.

If the order had been for 300,000 mcg of drug A, and the supply on hand had consisted of 150-mg tablets, micrograms would have to be converted to milligrams through the following steps:

1. Write the order (300,000 mcg).
2. Write down the equivalent units needed next to the order units (300,000 mcg = mg).
3. Place an arrow between the two units, with the closed part of the arrow pointing toward the smaller units ($\text{mcg} < \text{mg}$).
4. Move the decimal three places in the direction the arrow points ($300 \text{ mg} \leftarrow 300\underset{3}{0}\underset{2}{0}\underset{1}{0}$ mcg).

In this problem, it would take two 150-mg (150,000 mcg) tablets to fill the 300,000-mcg order.

Additional problems for converting within the metric system are provided at the end of this chapter.

Apothecary and Household Systems

The apothecary and household systems of measurement are older systems than the metric system. The apothecary system is seldom used, but the household system is used for giving clients instructions about dosage.

The units most often encountered in the apothecary system are the minim, abbreviated *m* or *min*; the dram, abbreviated *dr*; the ounce, abbreviated *oz*; and the grain, abbreviated *gr*. A minim is equal to 1 drop, a dram is equal to 4 ml, an ounce is equal to 30 ml, and a grain is equal to 65 mg (64.8, sometimes rounded off to 65). When quantities related to grains are written, the symbol *gr* should be placed before the number, and common fractions are used when appropriate (e.g., *gr* 1/50). The apothecary pound (12 *oz*) is not used when doses are calculated. Instead, the avoirdupois pound (16 *oz*) is used.

Units commonly used in the household system include the drop, abbreviated *gtt*; the tablespoon,

abbreviated *T* or *Tbsp*; and the teaspoon, abbreviated *t* or *tsp*. One drop is equivalent to 1 min, 1 *Tbsp* is equivalent to 15 ml, and 1 *tsp* is equivalent to 5 ml. The pint, quart, and gallon are other units that are sometimes encountered. Boxes 3-1 and 3-2 illustrate equivalent values that are useful in dosage calculations. Problems on converting within and between the apothecary and household systems are found at the end of this chapter.

DOSAGE CALCULATIONS

The quantity of drug to be delivered to a patient is called the *dose*. A dosage rate expressed in milligrams per kilogram (or milligrams per pound) is multiplied by the animal's weight in kilograms (or pounds) to determine the dose. The dose then is divided by the amount (concentration) of the drug in the pharmaceutical form (tablet, solution, and so forth) to determine the actual amount of the

pharmaceutical form to be administered. The formula for dosage calculation, which should be committed to memory, is as follows:

$$\text{Dose} = \frac{\text{Animal's weight} \times \text{dosage rate}}{\text{Concentration of drug}}$$

Example 1: If a 20-kg dog is to be given amoxicillin at the rate of 10 mg/kg, and injectable amoxicillin at a concentration of 100 mg/ml is available, the dosage calculation would be as follows:

$$\text{Dose} = \frac{20 \text{ kg} \times 10 \text{ mg/kg}}{100 \text{ mg/ml}} = \frac{200 \text{ mg}}{100 \text{ mg/ml}} = 2 \text{ ml}$$

Note that in the first step of the calculation, kilograms cancel out to leave only milligrams in the numerator. In the second step, milligrams cancel out to leave milliliters. If 100-mg amoxicillin tablets are available, the formula becomes as follows:

$$\text{Dose} = \frac{20 \text{ kg} \times 10 \text{ mg/kg}}{100 \text{ mg/tablet}} = \frac{200 \text{ mg}}{100 \text{ mg/tablet}} = 2 \text{ tablets}$$

Because most scales used to weigh animals for drug dosage calculation provide the weight in pounds, a conversion must be made from pounds to kilograms. To do this, divide the weight in pounds by 2.2.

Example 2: The dog in the previous problem weighed 44 lb, and 44 divided by 2.2 equals 20 kg. To convert kilograms to pounds (if the dose is provided in milligrams per pound), multiply the weight in kilograms by 2.2 (e.g., 20 kg \times 2.2 = 44 lb).

If the order to the technician is to "give a dog 300 mg of amoxicillin," then the ordered amount is simply divided by the concentration of the drug to determine the amount to be administered.

Example 3: If the order is to give a dog 300 mg of amoxicillin (concentration 100 mg/ml), the calculation would be as follows:

$$\frac{300 \text{ mg}}{100 \text{ mg/ml}} = 3 \text{ ml}$$

BOX 3-1 Weight Equivalents

1 kg = 1000 g = 2.2 lb
 1 g = 1000 mg
 1 mg = 1000 μ g = 0.001 g
 65 mg = 1 g
 1 μ g = 0.001 mg = 0.000001 g
 1 lb = 453.6 g = 0.4536 kg = 16 oz
 1 oz = 28.35 g

BOX 3-2 Volume Equivalents

1 L = 1000 ml = 1 qt (946.4 ml)
 500 ml = 1 pt (473 ml) = 2 cups (equivalent to 1 lb of water)
 15 ml = 1 *Tbsp*
 5 ml = 1 *tsp*
 30 ml = 1 oz
 240 ml = 1 cup/glass
 4 ml = 1 dram
 1 ml = 15gtt/min*

*The number of drops/minute in 1 ml depends on the size of the dropper. With a standard-size dropper, 1 ml equals 15 drops.

It should be noted that the dose of most drugs used to treat neoplasms is calculated according to the total body surface area of the patient. Body surface area is correlated with the weight of the animal. A table is available in Chapter 16 (see Table 16-2) for converting an animal's weight to surface area in square meters (sq M or m^2). In these cases, the formula for dosage calculation becomes the following:

$$\text{Dose} = \text{mg/m}^2 \text{ (from insert)} \times \text{m}^2 \text{ (from table)}$$

Dosage calculation problems are provided at the end of this chapter.

SOLUTIONS

To understand dosage calculation problems and how to prepare dilutions of substances (e.g., formalin and dextrose), a technician must have a basic understanding of solutions. Solutions are mixtures of substances that usually are not chemically combined with each other. Solutions are made up of a dissolving substance, called the *solvent*, and a dissolved substance, called the *solute*. Not all substances form solutions with each other. Those that form solutions are called *miscible*, and those that do not are called *immiscible*. A solution is referred to as *saturated* if it contains the maximum amount of solute at a particular temperature and pressure. Under some circumstances, a solution can become supersaturated. Mixtures of substances in which the solute is made up of very large particles are called *suspensions*. The particles in suspensions settle upon standing, and the mixture must be agitated before it is administered. True solutions do not settle out and remain mixed without agitation. All parts of solutions contain equal parts of the solute.

When working with solutions, it is important to know the amount of solute in the solvent or to be able to measure it. The amount of solute dissolved in the solvent is referred to as the *concentration* of the substance. Concentrations may be expressed in a number of ways, including the following:

1. Parts
2. Weight per volume (w/v) for liquids
3. Volume per volume (v/v) for liquids
4. Weight per weight (w/w) for solids

Solutions can be described in terms of parts without any reference to units of measurement. The parts simply refer to the relationship between the solvent and the solute. For example, instructions may call for a 1-to-30 (1:30) dilution of a disinfectant.

One unit that describes the relationship of parts is called *parts per million* (ppm). Parts per million is equal to 1 mg of a solute in a kilogram or liter of solvent. One part per million is also equivalent to 1 μg in a gram or milliliter. Upson (1988) reports that 1 ppm is equivalent to 1 minute in approximately 2 years or 1 oz of sand in approximately 31 tons of cement. Parts per billion is a unit that is used occasionally. It is equivalent to 1 μg in a kilogram or liter, or 1 nanogram in a gram or milliliter.

The most common way of expressing drug concentration when the solute is a solid and the solvent is a liquid is weight per volume (w/v). For example, the concentration of most pharmaceutical preparations is expressed as milligrams per milliliter (mg/ml); the concentration for Ketaset is 100 mg/ml. The weight-per-weight (w/w) and the volume-per-volume (v/v) solutions are not used as often in veterinary pharmaceutical preparations as the w/v preparations.

PERCENT CONCENTRATIONS

The term *percent concentration* may be used when w/v, w/w, or v/v concentrations are described. Percent (percentage) means parts of solute per 100 parts of the solution. Percent w/v means the number of grams of solute in 100 ml of solution; percent w/w describes the number of grams of solute in 100 g of solution; and v/v expresses the number of milliliters of solute in 100 ml of the solution.

A 100% solution (w/v) contains 100 g of solute per 100 ml of solution. Another way to say this is that it contains 1 g (1000 mg) of solute per 1 ml of solution (1000 mg/ml). To convert from a percent

solution to mg/ml, multiply the percentage by 10 (e.g., a 5% Lasix solution contains 50 mg/ml). To convert milligrams per milliliter to a percent, divide the milligrams per milliliter by 10 (e.g., a Lasix solution containing 50 mg/ml is a 5% solution). Sometimes, the term milligrams percent (mg%) is encountered. This term is used to refer to the number of milligrams in 100 ml of solution. It is an expression of concentration but not of percent concentration (g/100 ml). A more accurate description of mg% would be milligrams per deciliter (mg/dl), because a deciliter is equal to 100 ml.

A 100% solution (w/w) contains 100 g of solute in 100 g of solution. A 5% solution (w/w) of sodium chloride would contain 5 g of sodium in 100 g of solution. To make this preparation, weigh out 5 g of sodium chloride and mix it with 95 g of water.

A 100% solution (v/v) would simply be pure drug or chemical. A 10% solution would contain 10 ml of the chemical in 100 ml of solution. When a w/v solution or a v/v solution is prepared, the desired amount of solute is added to a container, and enough solvent is added to create the desired volume. This process is called *diluting up*, or it may be said that you *q.s.* to the desired volume. The abbreviation *q.s.* means to add a "quantity sufficient" to arrive at the desired volume. For example, to make 100 ml of a 10% formalin solution, place 10 ml of formaldehyde (100% formalin) in a container and *q.s.* (quantity sufficient) to 100 ml (10 ml formalin, 90 ml distilled water).

Calculations Involving Concentrations

To determine the amount of solute needed to make a desired amount of solution, you may use the following formula:

$$\begin{aligned} &\text{Grams of solute to } q.s. \text{ to desired volume} \\ &= \frac{\% \times \text{desired volume}}{100} \end{aligned}$$

Example 1: How many grams of sodium chloride are needed to make 1 L of 0.9% sodium chloride?

$$\text{Answer} \quad \text{Grams needed} = \frac{0.9 \times 1000 \text{ ml}}{100} = 9 \text{ g}$$

Nine grams of sodium chloride are added to a container and is diluted up to 1000 ml.

When the amount of solute and the volume of solution are known, the percent solution may be calculated as follows:

$$\text{Percent solution} = \frac{\text{grams of solute} \times 100}{\text{volume of solution}}$$

Example 2: What percentage is a solution that contains 9 g of sodium chloride?

$$\text{Answer} \quad \text{Percent solution} = \frac{9 \times 100}{1000} = \frac{900}{1000} = 0.9\%$$

To solve problems involving a change in concentration of the solution, the following formula may be used:

$$\begin{aligned} &\text{Volume one} \times \text{Concentration one} \\ &= \text{Volume two} \times \text{Concentration two} \end{aligned}$$

Example 3: How would you prepare 100 ml of a 5% dextrose solution from a 50% dextrose solution?

$$\begin{aligned} \text{Answer} \quad V_1 \times C_1 &= V_2 \times C_2 \\ 100 \times 5 &= V_2 \times 50 \\ 500 &= 50V_2 \\ 10 &= V_2 \end{aligned}$$

This formula demonstrates that you would take 10 ml of the 50% dextrose solution and add *q.s.* to 100 ml to prepare the 5% solution.

Another formula that may be used to solve problems in which a change in concentration is involved is as follows:

$$\frac{\text{Desired strength}}{\text{Available strength}} = \frac{\text{amount to use}}{\text{amount to make}}$$

Example 4: In solving the foregoing problem, the desired strength is 5%, the available strength is 50%, the amount to make is 100 ml, and the amount to use is the unknown.

$$\begin{aligned} \text{Answer} \quad \frac{5}{50} &= \frac{X}{100} \\ 50X &= 500 \\ X &= 10 \text{ ml} \end{aligned}$$

MILLIEQUIVALENTS

When electrolytes are involved, the concentration of a solution is often expressed in terms of **milliequivalents** (mEq). One milliequivalent is equal to 1/1000 of an equivalent. An **equivalent weight** is equal to (for practical applications) 1 g molecular weight divided by the total positive valence of the material in question (Blankenship and Campbell, 1976). The concentration of an electrolyte solution is expressed as milliequivalents per liter (mEq/L), which can be calculated when the concentration of the solution is known by using the following formula:

$$\text{mEq/L} = \frac{\text{mg/dl} \times 10}{\text{eq wt}}$$

Example 1: How many milliequivalents per liter is found in a sodium chloride solution that contains 700 mg/dl?

$$\text{mEq/L} = \frac{700 \times 10}{58.5} = 119.66$$

The number of milligrams per deciliter also can be calculated when the number of milliequivalents per liter is known by manipulating the previous formula as follows:

$$\text{mg/dl} = \frac{\text{mEq/L} \times \text{eq wt}}{10}$$

Example 2: How many milligrams per deciliter is contained in a solution that has 119.66 mEq/L?

Answer $\text{mg/dl} = \frac{119.66 \times 58.5}{10} = \frac{7000}{10} = 700 \text{ mg/dl}$

CALCULATIONS INVOLVING IV FLUID ADMINISTRATION

Calculations for determining the volume of fluid to administer are covered in Chapter 15. The rate at which to run intravenous fluids (in drops per minute) can be determined by dividing the volume of fluids to be given by the time in minutes during administration, and then multiplying that number

by the drops per milliliter delivered by the administration set.

$$\frac{\text{Volume of infusion (ml)}}{\text{Time of infusion (min)}} \times \text{drop factor (gtt/ml)} \\ = \text{drops per minute}$$

The drip rate in drops per minute can be divided by 60 to determine the rate in drops per second—a number that is easier to work with when one is actually adjusting the flow.

Example 1: Give 480 ml of lactated Ringer's solution to Dog A over a 4-hour period using a standard 15 gtt/ml administration set.

$$\frac{480 \text{ ml}}{240 \text{ min}} = \frac{2 \text{ ml}}{\text{min}} \times \frac{15 \text{ gtt}}{\text{ml}} = \frac{30 \text{ gtt}}{\text{min}} \times \frac{1 \text{ min}}{60 \text{ sec}} = \frac{1 \text{ gtt}}{2 \text{ sec}}$$

Giving one drop every 2 seconds will deliver 30 drops in a minute.

Calculations for Constant Rate Infusion Problems

Sometimes, medications given by intravenous infusion have to be administered at a dose delivered at a constant rate over a specified period of time. The dosage is often ordered in micrograms per kilogram per minute.

This dosage can be confusing because most drugs are available in a concentration expressed as milligrams/milliliter (mg/ml) and are delivered through infusion pumps at a rate expressed as milliliters/hour (ml/hr). The following example problem illustrates a method for solving these problems without the use of an infusion pump.

Example 1: A 44-lb dog in acute heart failure is ordered to receive 10 mcg/kg/min of dopamine. You will add a 200-mg vial of dopamine to a 1-L bag of D₅W (dextrose 5% in water) solution (0.2 mg/ml). At what rate in drops per minute will you administer this solution to deliver the correct dosage?

Step 1: Convert to the same units. The dose is expressed in mcg/kg, so the patient's weight

must be converted from pounds to kilograms, and the drug concentration must be expressed in mcg/ml.

$$44 \text{ lbs} \times \frac{1 \text{ kg}}{2.2 \text{ lbs}} = \frac{44 \text{ kg}}{2.2} = 20 \text{ kg}$$

$$\frac{0.2 \text{ mg}}{1 \text{ ml}} \times \frac{1000 \text{ mcg}}{1 \text{ mg}} = \frac{200 \text{ mcg}}{1 \text{ ml}}$$

Step 2: Determine the number of mcg/min.

$$20 \text{ kg} \times \frac{10 \text{ mcg}}{\text{kg/min}} = \frac{200 \text{ mcg}}{\text{min}}$$

Step 3: Determine the number of ml per minute.

$$\frac{200 \text{ mcg}}{1 \text{ min}} \times \frac{1 \text{ ml}}{200 \text{ mcg}} = \frac{1 \text{ ml}}{1 \text{ min}}$$

Step 4: Determine the number of drops per minute using a minibip (60 gtt/ml) administration set.

$$\frac{1 \text{ ml}}{\text{min}} \times \frac{60 \text{ gtt}}{1 \text{ ml}} = \frac{60 \text{ gtt}}{1 \text{ min}} \text{ or } 1 \text{ gtt/sec}$$

Formulas and recipes have been devised to simplify the constant rate infusion (CRI) calculations (Macintire and Tefend, 2004). The following formula can be used to determine the number of milligrams of drug that must be added to a bag of fluids to deliver a predetermined dosage rate to a patient. A volume of the delivery fluid equal to the volume of the drug added should be removed before the drug is added, to keep the dose and volume accurate.

$$M = \frac{(D) (W) (V)}{(R) (16.67)}$$

M = number of mg of drug to add to delivery fluid

D = dosage of drug in mcg/kg/min

W = patient body weight in kg

V = volume in ml of delivery fluid

R = rate of delivery in ml/hr

16.67 = conversion factor

The next formula can be used to adjust the dosage (mcg/kg/min) in accordance with the response of the animal.

$$R = \frac{(D) (W) (V)}{(M) (16.67)}$$

Another formula allows rapid calculation of the amount of drug to be added to a standard volume of 250 ml of fluid at a standard delivery rate of 15 ml/hr.

$$\text{Drug dosage (mcg/kg/min)} \times \text{Body weight (kg)} = \text{mg of drug to add to 250 ml fluid and run at 15 ml/hr}$$

Some CRI drugs are dosed in milligrams (mg)/kg/hr rather than mcg/kg/min. The following formula determines the amount of drug (mg) to be added to 250 ml of fluid for a delivery rate of 10 ml/hr.

$$\frac{\text{Dose (mg/kg/hr)} \times \text{Body weight (BW) (kg)} \times 25 \text{ hr}}{\text{Drug concentration (mg/ml)}} = \text{Number of ml of drug to add to 250 ml delivery fluid and administer at 10 ml/hr}$$

A combination of morphine and ketamine (MK) sometimes is delivered as a CRI for pain control in dogs and cats. A recipe (Ortel, 2006) for this combination calls for adding to a single 500-ml bag of fluids the following:

60 mg of ketamine (100 mg/ml)

60 mg of morphine (15 mg/ml)

When the two drugs are added, the patient's weight in kilograms becomes the infusion rate in ml/hr that is set on the infusion pump. The delivery dose is 1 ml/kg/hr or 2 mcg/kg/min ketamine and 2 mcg/kg/min morphine.

For dogs, lidocaine (500 mg of a 20 mg/ml concentration) can be added to the MK recipe above to make the MLK mixture. The MLK mixture also is run at a delivery rate of 1 ml/kg/hr, delivering 17 mcg/kg/min of lidocaine, in addition to the ketamine and morphine.

REFERENCES

Blankenship J, Campbell JB: Solutions. In Blankenship J, Campbell JB, editors: Laboratory mathematics: medical and biological applications, St. Louis, 1976, Mosby.

Macintire DK, Tefend M: Constant rate infusions: practical use, North American Veterinary Conference Clinician's Brief April:25-28, 2004.

Ortel SO: Constant-rate infusions, Veterinary Technician 27(1):47-50, 2006.

Upson DW: General principles. In Upson DW, editor: Handbook of clinical veterinary pharmacology, ed 3, Manhattan, Kansas, 1988, Dan Upson Enterprises.



REVIEW QUESTIONS

PROBLEMS USING RATIOS AND PROPORTIONS

Ratios

- Express 1/4 as a ratio and as a decimal.
- Express 0.75 as a ratio and as a fraction.
- Express 0.004 as a ratio and as a fraction.
- Express 1:80 as a fraction and as a decimal.
- Express 9/1000 as a ratio and as a decimal.
- Express 1:32 as a fraction and as a decimal.

Proportions (Solve for X.)

- $25:X = 5:10$
- $\frac{4}{5} = \frac{X}{10}$
- $1/2:100 = X:500$
- $\frac{1/4}{X} = \frac{20}{400}$
- Convert 0.2 g to milligrams using a proportion.

$$\frac{1000 \text{ mg}}{1 \text{ g}} = \frac{X \text{ mg}}{0.2 \text{ g}}$$

- If a drug concentration is labeled 5 ml = 250 mg, how many mg are in three fourths of a milliliter?

$$\frac{250 \text{ mg}}{5 \text{ ml}} = \frac{X}{\frac{3}{4} \text{ ml}}$$

- How much bleach would you use to prepare 1000 ml of a 1:32 solution?

$$1:32 = X:1000$$

- How much bleach would you use to prepare 1 gallon (3784 ml) of a 1:32 solution?

$$1:32 = X:3784$$

- If you were to give a horse 1 ml per 250 lb of body weight of an anthelmintic, how many milliliters would you give to a horse that weighs 1250 lb?

$$\frac{1}{250} = \frac{X}{1250}$$

- If a 10-lb dog gets one fourth of a tablet of an antibiotic, how many tablets will a 50-lb dog get?

$$1/4:10 = X:50$$

PROBLEMS USING THE METRIC SYSTEM

- 150 mg = _____ g
- 2 L = _____ ml
- 2250 mg = _____ g
- 5 g = _____ mg
- 3000 ml = _____ L
- 2 kg = _____ g
- 0.5 kg = _____ g
- 5000 mg = _____ kg
- 1.25 mg = _____ g
- 0.004 g = _____ mg

- 2050 μg = _____ mg
- How many grams would you administer if the veterinarian ordered 10 mg of acepromazine?

- If the medical order is for 0.5 L of sodium chloride 0.9%, how many milliliters would be administered? _____
- How many liters would you give to the patient if the order called for 750 ml to be administered? _____
- If the veterinarian orders 300 μg of vitamin B₁₂, how much is this in milligrams?

- If the order is for 2.5 mg of vitamin B₁₂, how many micrograms are administered?

PROBLEMS USING THE APOTHECARY AND HOUSEHOLD SYSTEMS

- 1.5 qt = _____ pt
- 12 pt = _____ gal
- 3 tsp = _____ Tbsp
- 3 qt = _____ cups
- 12 cups = _____ pt
- 2 oz = _____ Tbsp
- 1 gal = _____ oz
- 1 pt = _____ oz
- 6 pt = _____ qt

PROBLEMS COMBINING THE TWO SYSTEMS

- 1 pt = _____ ml
- 2 Tbsp = _____ ml
- 15 ml = _____ cc
- 2 cups = _____ oz
- 6.5 ml = _____ pt
- 125 ml = _____ tsp
- 1.5 oz = _____ ml
- 15 kg = _____ lb
- 250 ml = _____ pt
- 5 oz = _____ ml
- 35 lb = _____ kg

PROBLEMS MEASURING ORAL MEDICATIONS

- The order is for 500 mg of amoxicillin, and tablets on hand are 250 mg. How many tablets will be administered? _____

- The order is for 15 mg of prednisone, and 10-mg (scored) tablets are on hand. How many tablets will be administered?

- The order is for 960 mg of SMZ-TMP. Tablets on hand are 240 mg. How many tablets will be administered? _____
- The order is for enrofloxacin to be given once daily at 5 mg/kg to a 10-lb cat for 7 days. How many 22.7-mg tablets should be dispensed to the client?
- The veterinarian prescribes 15 mg of prednisone every other day for 10 days. The tablets on hand are 10 mg. How many tablets will be administered? How many tablets will be dispensed?

- The veterinarian prescribes 100 mg of cephalexin twice a day (b.i.d.) for 10 days. You have 100-mg tablets on hand. How many will be dispensed? _____
- The veterinarian prescribes Albon for *Coccidia*. Your patient is a puppy that weighs 8 lb and needs treatment for 21 days. The dose for Albon is 25 mg/lb loading dose and 12.5 mg/lb maintenance dose to be given once daily (s.i.d.). The drug is supplied at 250 mg/5 ml. How many milligrams does your patient need for a loading dose?

A maintenance dose? _____

How many mg/ml are there in Albon?

How many milliliters does your patient need for a loading dose? _____

A maintenance dose? _____
How many milliliters will be dispensed?

- The veterinarian orders 4.4 mg/kg of carprofen for pain control divided into two equal daily doses for a 50-lb dog. On hand are 100-mg scored tablets. How many tablets is/are administered each morning and afternoon?

- The order is for 0.5 mg/kg enalapril twice daily for a 20-kg dog for 30 days. On hand are 10-mg scored tablets. How many tablets should be dispensed? _____

10. The veterinarian prescribes 2.5 mg of acepromazine t.i.d. for 3 days, and tablets on hand are 5 mg (scored). How many tablets will be administered? _____
How many will be dispensed? _____
11. The veterinarian prescribes aminophylline to be given three times daily for 14 days to a 15-lb dog. The dose for aminophylline is 10 mg/kg. How many kilograms does your patient weigh? _____
How many milligrams have to be administered to your patient? _____
Because the tablets on hand are 100 mg (scored), how many tablets will you give to the patient? _____
How many tablets will be dispensed? _____
12. The veterinarian has ordered 5 mg/kg ponazuril once daily for a 1200-lb horse for 28 days. Tubes of 127 g of ponazuril paste are available; these contain 150 mg ponazuril per gram. How many tubes of the medication are needed for the 28-day treatment?
13. A farmer has 10 calves that weigh approximately 100 lb each. A microscopic fecal examination reveals *Coccidia*. The veterinarian chooses to treat all 10 calves with Corid powder (20% amprolium) by drenching daily for 10 days. To make a drench solution, mix 3 oz of Corid powder in 1 qt of water (1 oz of powder = 3.5 Tbsp). The dose of Corid for drenching is 1 oz of solution per 100 lb of body weight. How much solution should be mixed to drench these 10 calves for 10 days? _____
14. Doxycycline has been chosen as a treatment for a 1-kg Amazon parrot at the rate of 25 mg/kg b.i.d. for 7 days. The tablets on hand are 50 mg (scored). How many tablets will be given for each treatment? _____
How many tablets will be dispensed? _____
15. The veterinarian orders clenbuterol syrup for a 200-lb foal. The dosage is 0.8 micrograms/kg twice daily for 3 days. The syrup contains 72.5 micrograms/ml. How many milliliters is given at each dose? _____

PROBLEMS MEASURING PARENTERAL MEDICATIONS

1. The veterinarian orders prednisone, 20 mg intramuscularly (IM). The vial is labeled 50 mg/ml. How many milliliters will be administered? _____
2. The veterinarian orders an injection of Percorten-V for a 20-lb dog at the dosage rate of 2.2 mg/kg. The concentration of Percorten-V is 25 mg/ml. How much of the drug should be injected? _____
3. The veterinarian orders phenylbutazone to be administered to a 1500-lb horse at a dose of 5 mg/kg intravenously. The vial is labeled 200 mg/ml. How many milliliters will be administered? _____
4. The veterinarian orders penicillin G procaine for a 25-lb dog to be administered at a dose of 40,000 U/kg IM. The vial is labeled 300,000 U/ml. How many milliliters will be administered? _____
5. The veterinarian orders cefazolin to be given to a 23-lb dog at a dosage of 20 mg/kg IV for surgical prophylaxis. The concentration of cefazolin on hand is 100 mg/ml. How much of the drug should be given? _____
How many milliliters will be administered at each treatment? _____
6. A 78-lb dog is to be administered ampicillin trihydrate at a dose of 5 mg/lb subcutaneously. The antibiotic has been reconstituted, and the concentration is 200 mg/ml. How many milliliters will be administered to the patient? _____
7. A microscopic fecal examination reveals a *Giardia* infection in a 500-g African gray parrot. The veterinarian chooses to treat the infection with metronidazole injectable at a dosage of 30 mg/kg daily for 3 days. How many milligrams will the parrot receive at each treatment? _____
8. A 45-lb dog is to be treated for lymphosarcoma with vincristine sulfate, 1 mg/ml. The dose is 0.5 mg/m². How many square meters of body surface area does this patient have? _____
How many milligrams will be given to the patient? _____

How many milliliters?

9. The veterinarian orders lincomycin HCl for a 500-lb Yorkshire boar. The dosage to be administered is 5 mg/lb/day IM for 5 days. The medication on hand is 100 mg/ml in a 50-ml multidose vial. How many milligrams will be administered to the boar each day?

How many milliliters will be administered to the boar each day? _____
How many bottles of medication does the owner have to purchase to treat the boar for 5 days? _____
10. A cat weighing 8 lb that has a small laceration on its left hip is to be administered ketamine HCl to produce anesthesia. The veterinarian orders 15 mg/kg IM. The vial is labeled 100 mg/ml. How many milligrams will be administered to the cat? _____
How many milliliters will be administered?

11. The veterinarian orders 7 mEq of potassium chloride to be added to the IV fluids. The vial is labeled 20 mEq in 10 ml. How many milliliters will be added to the fluids?

12. The veterinarian orders 4 U of regular insulin to be administered to a diabetic cat. The regular insulin is labeled 40 U/ml. How many milliliters will be administered?

13. The veterinarian orders testosterone propionate for a 475-lb Landrace boar. The dose to be administered is 1 mg/10 lb. The label on

the vial is 25 mg/ml. How many milligrams will be administered? _____

How many milliliters will be administered?

14. The veterinarian orders dexamethasone 60 mg IV to be given to a patient. The vial is labeled 2 mg/ml. How many milliliters will be administered? _____
15. The veterinarian orders 15 mg of vitamin K₁. The vial is labeled 10 mg/ml. How many milliliters will be administered?

16. The order is for meloxicam at 0.2 mg/kg to control postsurgical pain in a 4.5-kg cat. The concentration of the drug is 5 mg/ml. What volume of the drug should be given?

17. A rabbit weighing 12 lb is to be given 0.02 mg/kg of buprenorphine subcutaneously for pain control. The concentration of the drug is 0.3 mg/ml. How much of the drug should be given?

18. Atropine (0.5 mg/ml) is ordered at 0.01 mg/lb to control bradycardia in a 75-lb dog. How much of the drug should be given?

19. The veterinarian orders enrofloxacin at 5 mg/kg IM for a 7-kg python with respiratory disease. The product contains 100 mg/ml. How much should be injected? _____
20. The order is for an injection of metoclopramide at 0.4 mg/kg for a 15-kg dog. The concentration of available product is 5 mg/ml. How much should be injected?



INJECTION PROBLEMS

Order	Give	Stock
1.	0.5 g IM	250 mg/ml
2.	20 mEq IV	40 mEq/10 ml
3.	0.75 mg IM	0.50 mg/ml
4.	150 mg IM	0.2 g/5 ml
5.	25 mg IM	100 mg/ml
6.	0.5 mg IM	0.5 mg/2 ml
7.	0.3 mg IV	0.4 mg/ml
8.	300,000 U SC	40,000 U/ml
9.	0.3 mg IM	0.5 mg/ml
10.	55 mg SC	250 mg/ml

PREPARING SOLUTIONS

- Order: 100 ml of 10% formalin solution
On hand: formaldehyde 37% (considered as 100% formalin) and water
Amount needed: _____
- Order: 1000 ml 0.9% NaCl and 5% dextrose
On hand: 1000 ml 0.9% NaCl and 500 ml 50% dextrose
Amount of each needed: _____
- Order: 100 ml 50% dextrose
On hand: 500 ml 50% dextrose and 250 ml sterile water for injection
Amount needed: _____
- Order: 500 ml 0.45% NaCl and 5% dextrose
On hand: 500 ml 0.9% NaCl and 500 ml 5% dextrose
Amount of each needed: _____
- Order: 2000 ml lactated Ringer's solution and 2.5% dextrose
On hand: 2 containers of 1000 ml lactated Ringer's solution and 250 ml 50% dextrose
Amount of each needed: _____
- Order: 50 ml 5% dextrose
On hand: 1000 ml sterile water for injection and 250 ml 50% dextrose
Amount of each needed: _____

- Order: 500 ml 2.5% dextrose and 0.45% NaCl
On hand: 1000 ml 0.45% NaCl and 500 ml 50% dextrose
Amount of each needed: _____
- Order: 1000 ml of 10% glyceryl guaiacolate solution
On hand: packets containing 50 g guaifenesin (GG) powder and 1000 ml sterile water for injection
Amount of each needed: _____
- Order: 8% thiamylal sodium solution
On hand: One 5-g vial of powder and sterile water for injection
Amount of sterile water needed: _____
- Order: 5 ml of 2% cyclosporine ophthalmic solution
On hand: 50 ml Sandimmune Oral Solution (cyclosporine) 100 mg/ml and 16 oz of extra virgin olive oil
Amount of each needed: _____
- Order: 50 ml of 2% formalin for Knott's heart-worm test
On hand: 37% formaldehyde and water
Amount of each needed: _____

PROBLEMS CALCULATING

IV DRIP RATES

- What drip rate will you use to administer 500 ml of lactated Ringer's solution over a 3-hour period with a standard (15 gtt/ml) administration set?
- What drip rate would you use to deliver 120 ml 0.9% NaCl over a 2-hour period using a micro-drip (60 gtt/ml) administration set?
- What drip rate would you use to deliver 1.2 L of Normosol over a 10-hour period using a standard (15 gtt/ml) administration set?
- What drip rate would you use to deliver 8 mcg/kg/min of drug C (500 mg/250 ml) to

- an 83-lb dog using a microdrip (60 gtt/ml) administration set?
5. What drip rate would you use to deliver 10 mcg/kg/min of dopamine (0.2 mg/ml) to a 22-lb dog using the microdrip (60 gtt/ml) administration set?
 6. Using the formula $M = \frac{(D)(W)(V)}{R(16.67)}$ how much nitroprusside (25 mg/ml) would you add to 1000 ml of 5% dextrose to deliver 2 mcg/kg/min of nitroprusside at a delivery rate of 12 ml/hr to a 3.8-kg dog?
 7. Using the formula $R = \frac{(D)(W)(V)}{M(16.67)}$ calculate the new fluid delivery rate needed to increase the dosage of nitroprusside in problem 6 to 3 mcg/kg/min.
 8. Using the formula $M = \frac{(D)(W)(V)}{R(16.67)}$ how much dobutamine (12.5 mg/ml) would you add to 100 ml of a 5% dextrose solution to administer 15 mcg/kg/min to a 28-kg dog at a delivery rate of 10 ml/hr?
 9. How much furosemide (10 mg/ml) would you add to a 250-ml fluid bag to deliver 3 mcg/kg/min to a 5-kg patient with the fluid pump set at 15 ml/hr?
 10. How much morphine (15 mg/kg) would you add to a 250-ml fluid bag to deliver 0.2 mg/kg/hr to a 10-kg animal with the pump set on 10 ml/hr?

CHOLINERGIC AGENTS

Direct-Acting Cholinergics
Indirect-Acting Cholinergic
(Anticholinesterase) Agents

**CHOLINERGIC BLOCKING AGENTS
(ANTICHOLINERGIC)**

**ADRENERGIC (SYMPATHOMIMETIC)
AGENTS**

ADRENERGIC BLOCKING AGENTS

Alpha Blockers
Beta Blockers
Ganglionic Blockers

Central Nervous System

TRANQUILIZERS

Phenothiazine Derivatives
Benzodiazepine Derivatives
Xylazine Hydrochloride
Detomidine Hydrochloride
Medetomidine
Romifidine

BARBITURATES

Long-Acting Barbiturates
Short-Acting Barbiturates
Ultrashort-Acting Barbiturates

DISSOCIATIVE AGENTS

OPIOID AGONISTS

Naturally Occurring Narcotics
Synthetic Narcotics

OPIOID ANTAGONISTS

NEUROLEPTANALGESICS

DRUGS GIVEN TO PREVENT

OR CONTROL SEIZURES

INHALANT ANESTHETICS

**MISCELLANEOUS CENTRAL NERVOUS
SYSTEM DRUGS**

Propofol
Glycerol Guaiacolate or Guaiifenesin
Chloral Hydrate/Magnesium Sulfate

CENTRAL NERVOUS SYSTEM

STIMULANTS

Doxapram
Pentylentetrazol (Metrazol)
Caffeine
Amphetamines

NEUROMUSCULAR BLOCKING DRUGS

Behavioral Pharmacotherapy

Pharmacotherapeutic Agents

ANTIANKIETY MEDICATIONS

Benzodiazepines

Azapirones

ANTIDEPRESSANTS

Tricyclics
Serotonin Reuptake Inhibitors
Monoamine Oxidase-B Inhibitors
Synthetic Progestins

EUTHANASIA AGENTS

CHAPTER 4

Drugs Used in Nervous System Disorders

LEARNING OBJECTIVES

After studying this chapter, you should be able to:

1. Define terms related to the pharmacology of the nervous system.
2. Develop a basic understanding of the anatomy and physiology of the nervous system.
3. Describe the subdivisions, functions, and primary neurotransmitters of the autonomic nervous system (ANS).
4. Describe how drugs affect the ANS.
5. List the different classes of ANS drugs.
6. List the two major classification schemes of barbiturates.
7. List indications and precautions for the use of barbiturates.
8. Describe dissociative anesthesia, and list three dissociative agents.
9. List the opiate receptors and the basic function of each.
10. List the indications for the use of narcotics.
11. List potential side effects of narcotic use or overdose.
12. Describe how opioid antagonists exert their effects, and list three examples of this category of drug.
13. Define neuroleptanalgesic and give an example.
14. List examples of drugs used to control seizures.
15. List commonly used inhalant anesthetic agents and compare their characteristics.
16. Describe the primary uses of central nervous system (CNS) stimulants.
17. List drugs used in behavioral pharmacotherapy.
18. Describe the characteristics of a good euthanasia agent.



KEY TERMS

ACETYLCHOLINE A neurotransmitter that allows a nerve impulse to cross the synaptic junction (gap) between two nerve fibers or between a nerve fiber and an organ (e.g., muscle, gland).

ACETYLCHOLINESTERASE An enzyme that brings about the breakdown of acetylcholine in the synaptic gap.

ADRENERGIC A term used to describe an action or a receptor that is activated by epinephrine or norepinephrine.

ANALGESIA Loss of pain sensation (other sensations may be present).

ANESTHESIA The loss of all sensation. May be described as local (affecting a small area), regional, or surgical (accompanied by unconsciousness).

AUTONOMIC NERVOUS SYSTEM That portion of the nervous system that controls involuntary activities.

CATALEPSY A state of involuntary muscle rigidity that is accompanied by immobility, amnesia, and variable amounts of analgesia. Some reflexes may be preserved.

CATECHOLAMINE The class of neurotransmitters that includes dopamine, epinephrine, and norepinephrine. When given therapeutically, catecholamines mimic the effects of stimulating the sympathetic nervous system.

CHOLINERGIC A term used to describe an action or receptor that is activated by acetylcholine.

EFFECTOR A gland, organ, or tissue that responds to nerve stimulation with a specific action.

GANGLIONIC SYNAPSE The site of the synapse between neuron one and neuron two of the autonomic nervous system.

MUSCARINIC RECEPTORS Receptors activated by acetylcholine and muscarine that are found in glands, the heart, and smooth muscle. An acronym for remembering muscarinic effects is "SLUD": S = salivation; L = lacrimation; U = urination; D = defecation.

NICOTINIC RECEPTORS Receptors activated by acetylcholine and nicotine found at the neuromuscular junction of the skeletal muscle and at the ganglionic synapses.

PARASYMPATHETIC NERVOUS SYSTEM That portion of the autonomic nervous system that arises from the craniosacral portion of the spinal cord, is mediated by the neurotransmitter acetylcholine, and is concerned primarily with conserving and restoring a steady state in the body.

PARASYMPATHOMIMETIC A drug that mimics the effects of stimulating the parasympathetic nervous system.

SYMPATHETIC NERVOUS SYSTEM That portion of the autonomic nervous system that arises from the thoracolumbar spinal cord, is mediated by catecholamines, and is concerned with the fight-or-flight response.

SYMPATHOMIMETIC A drug that mimics the effects of stimulating the sympathetic nervous system.

INTRODUCTION

The nervous system is the body's primary communication and control center. It functions in harmony with the endocrine system to allow an animal to respond and adapt to its environment and to maintain a relatively constant internal environment (homeostasis) through control of the many internal organ systems. In broad terms, the nervous system serves three functions: (1) sensory, (2) integrative (analysis), and (3) motor (action). It senses changes within the environment and within the body, interprets the information, and responds to the interpretation by bringing about an appropriate action. The nervous system carries out this complex activity very rapidly

by sending electric-like messages over a network of nerve fibers. The endocrine system works much more slowly by sending chemical messengers (hormones) through the bloodstream to target structures. The two systems are very closely interrelated functionally and anatomically. The nervous system exerts control over the endocrine system through the influence of the hypothalamus (brain) on the pituitary gland.

ANATOMY AND PHYSIOLOGY

The nervous system has two main divisions, the central nervous system (CNS) and the peripheral nervous system, as well as their related subdivisions

(Figure 4-1). The CNS is composed of the brain and the spinal cord and serves as the control center of the entire nervous system. All sensory information must be relayed to the CNS before it can be interpreted and acted on. Most impulses that stimulate glands to act and muscles to contract originate in the CNS.

The nerve processes that connect the CNS with the various glands, muscles, and receptors in the body make up the peripheral nervous system. Functionally, the peripheral nervous system is divided into afferent and efferent portions. The afferent portion is composed of nerve cells that carry information from receptors in the periphery of the body

to the CNS. The efferent system consists of nerve cells that carry impulses from the CNS to muscles and glands. Anatomically, the peripheral nervous system is composed of cranial nerves and spinal nerves.

The peripheral nervous system is also subdivided into a somatic nervous system and an **autonomic nervous system (ANS)**. The somatic nervous system consists of efferent nerves that carry impulses from the CNS to skeletal muscle tissue. It is under conscious control and is therefore called *voluntary*. The ANS consists of efferent nerve cells that carry information from the CNS to cardiac muscle, glands, and smooth muscle. It is under unconscious control and is

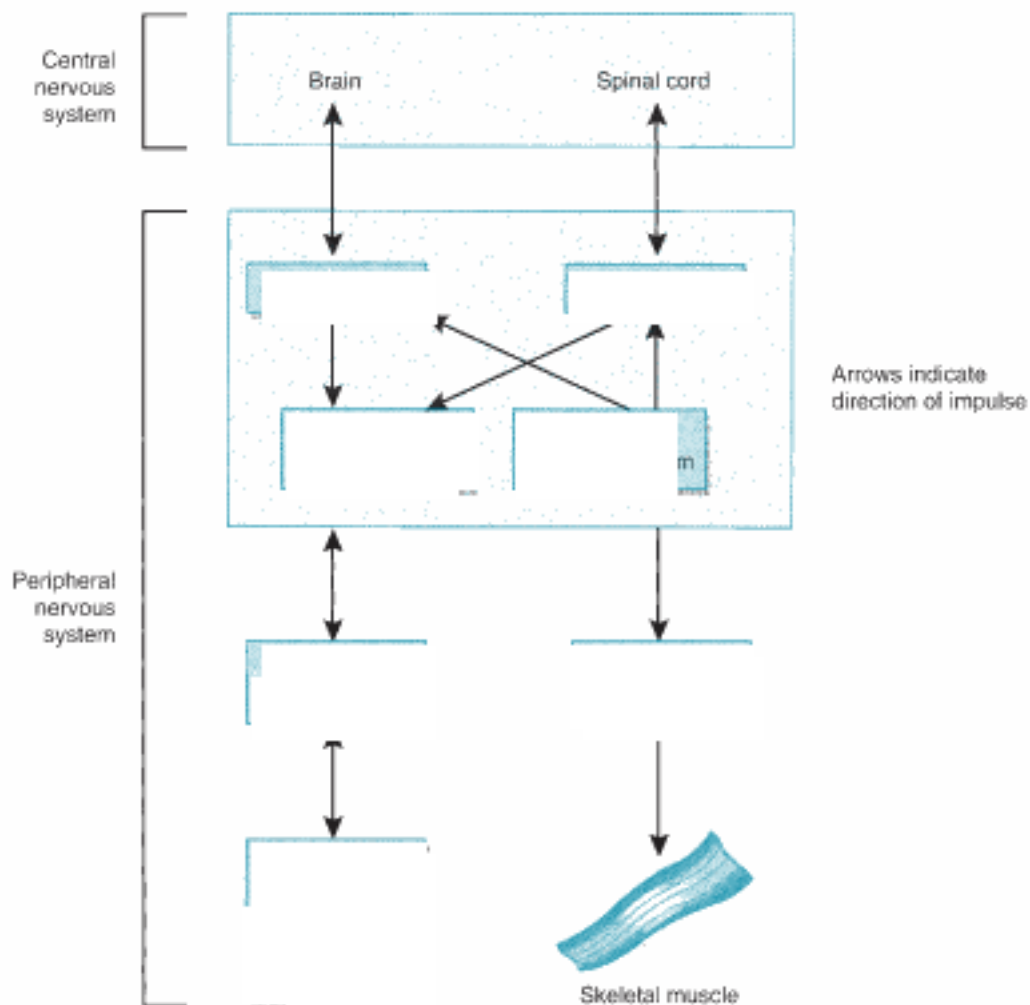

FIGURE 4-1
Organization of the nervous system.

called *involuntary*. The ANS has two subdivisions, the **sympathetic nervous system** and the **parasympathetic nervous system**. Most tissues innervated by the ANS receive both sympathetic and parasympathetic fibers. In general, one division stimulates an activity by a receptor and the other inhibits the activity to serve as a method of checks and balances.

The fundamental unit of all branches and divisions of the nervous system is the neuron (nerve cell). Neurons have the amazing ability to transmit information from point to point. The second point may be nearby or at a great distance. Similar to all cells in the body, neurons have a nucleus surrounded by cytoplasm. Different from other cells, however, neurons have cellular extensions or processes called *axons* and *dendrites*. Axons carry electric-like messages away from the nerve cell, and dendrites carry electric-like messages toward the nerve cell (Figure 4-2). Transmission of these messages along nerve fibers occurs through a wave of charge reversal that moves down the fiber (Figure 4-3). The resting (polarized) fiber has positive charges lined up on the outside of its membrane and negative charges lined up on the inside of its membrane. When a stimulus of sufficient magnitude reaches the fiber, depolarization or charge reversal (positive in, negative out) occurs in a progressive wave down the fiber toward the synapse. Repolarization is the movement of charges back to their original positions.

Axons may be short or long (up to 4 feet in humans), and they end, or terminate, in as many as 10,000 nerve endings called *telodendria* (Snyder, 1986). The large number of nerve endings allows for great variety in the number and type of connections made with other neurons. The synaptic end bulbs of the telodendria pass nerve impulses to an

adjacent structure (another neuron, gland, or muscle) by emitting a chemical messenger called a *neurotransmitter* into the gap or junction (*synapse*) between the nerve ending and the adjacent structure (Figure 4-4). Neurotransmitters then combine with receptors on the dendritic side of the synapse and cause a stimulatory or inhibitory effect. Dendrites may respond to neurotransmitters by generating a nerve impulse, which is conducted

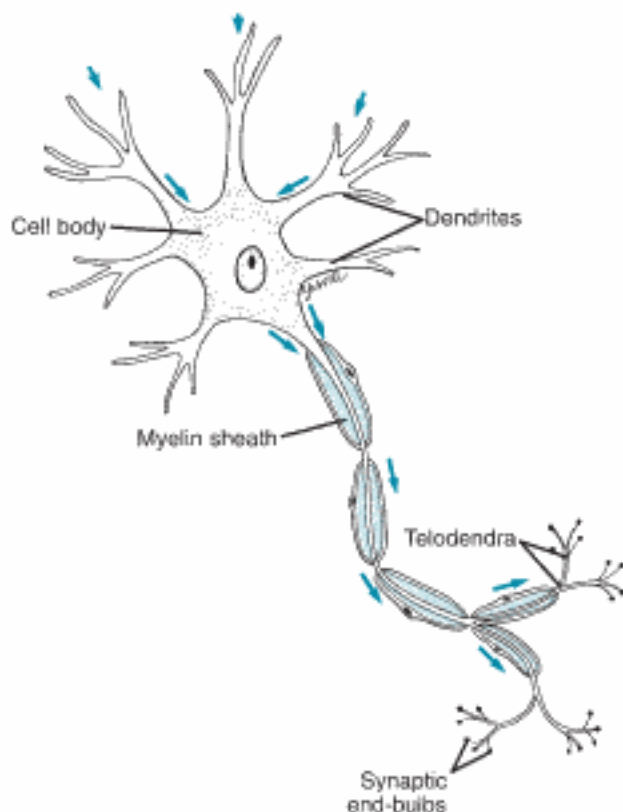

FIGURE 4-2
Impulse transmission through the neuron.

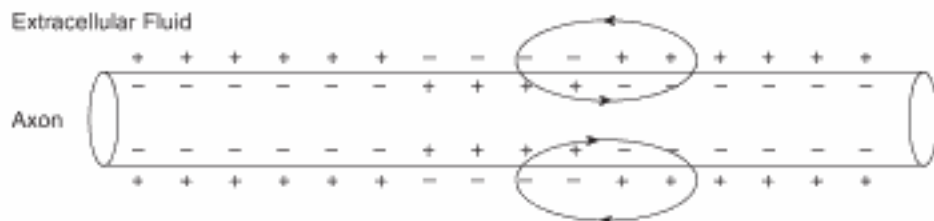

FIGURE 4-3
Electrical impulse transmission along a nerve fiber.

via the axon to the adjacent structure (neuron, gland, or muscle). Neurotransmitters can be mimicked or blocked by the use of appropriate drugs (Figure 4-5).

Nerve fibers (nerves) may have a large diameter (A fibers), a medium diameter (B fibers), or a small diameter (C fibers) (Boothe, 2001). Fibers with large diameters conduct nerve impulses faster than those with small diameters. Fibers that are surrounded by the insulating substance called *myelin* also transmit impulses faster than nonmyelinated fibers. Type A and B fibers are generally myelinated fibers.

The most basic impulse conduction system through the nervous system is the reflex arc (Figure 4-6). The reflex arc is composed of the following:

1. A receptor
2. A sensory neuron
3. A center in the CNS for a synapse

4. A motor neuron
5. An effector

The receptor of the reflex arc may be located in a peripheral site—such as the skin—or in a central area—such as a muscle, tendon, or visceral organ. The sensory neuron carries the impulse from the receptor to the CNS. In the CNS, the sensory neuron synapses with interneurons in the spinal cord. These interneurons send the impulse to the brain for interpretation or send the impulse to a motor neuron. The motor neuron carries the message to an effector organ. If the impulse travels around the arc without going to the brain for analysis, the sequence of events is called a *spinal reflex* (see Figure 4-6). A spinal reflex can occur even if the spinal cord is completely severed. For example, a hemostat applied to the toe of a dog with a severed cord can cause the dog to withdraw its leg by means of the spinal reflex.

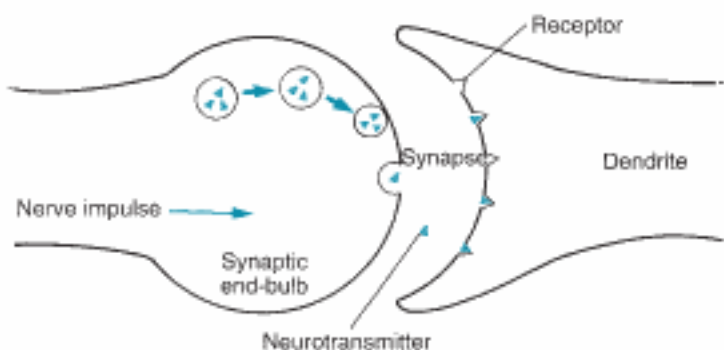

FIGURE 4-4
Neurotransmitter release.

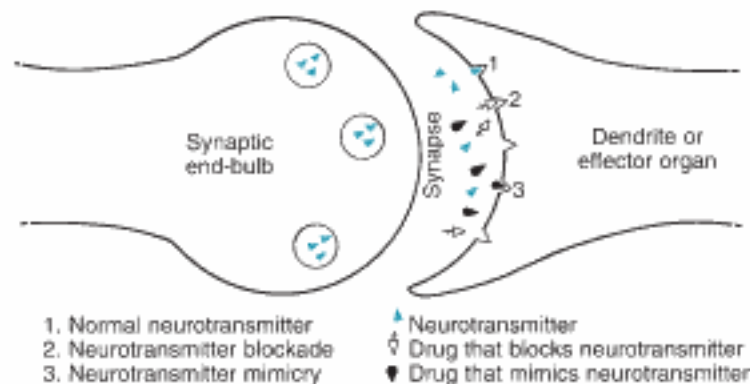

FIGURE 4-5
Neurotransmitter activity.

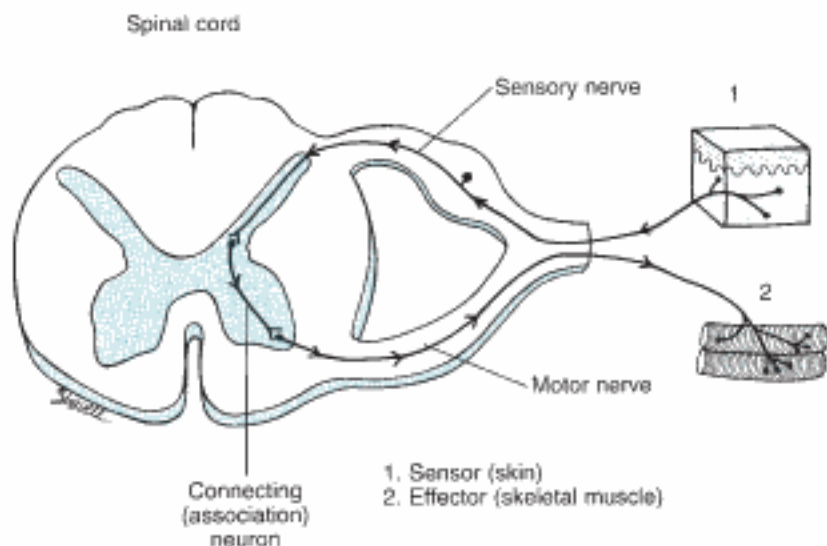

FIGURE 4-6
The reflex arc.

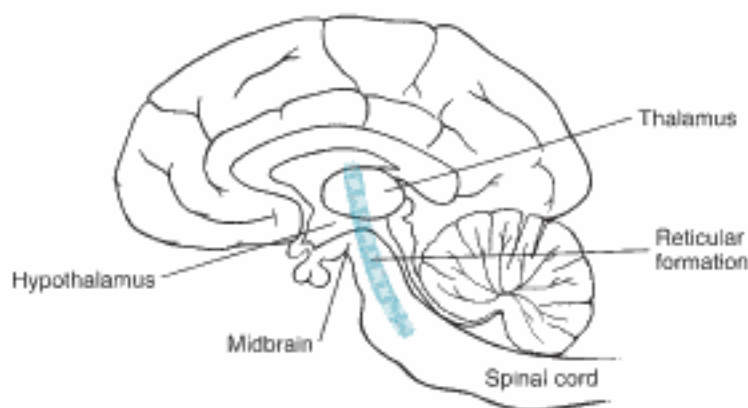

FIGURE 4-7
Pharmacologically important areas of the brain.

Areas of the brain that have importance to an understanding of the pharmacology of the CNS are illustrated in Figure 4-7. The cerebrum is responsible for higher functions of the brain, such as learning, memory, and interpretation of sensory input (vision, pain recognition, and so forth). The thalamus serves as a relay center for sensory impulses from the spinal cord, brain stem, and cerebellum to the cerebrum. The thalamus also may be involved in pain interpretation. The hypothalamus serves as the primary mediator between the nervous system

and the endocrine system through its control of the pituitary gland. The hypothalamus also controls and regulates the ANS. The medulla carries both sensory and motor impulses between the spinal cord and the brain. It contains centers that control vital physiologic activities, such as breathing, heart-beat, blood pressure, vomiting, swallowing, coughing, body temperature, hunger, thirst, and others. The reticular formation is a network of nerve cells scattered through bundles of fibers that begin in the medulla and extend upward through the brain

stem. The reticular activating system is a part of the reticular formation, which functions to arouse the cerebral cortex and is responsible for consciousness, sleep, and wakefulness (DeLahunta, 1983).

In summary, nerve activity is usually described as the generation of nerve impulses that occurs in a dendrite or cell body and then travels down an axon by electric-like activity, which is similar to the passage of an electric current down a wire. When this current reaches a synapse, a chemical “bridge” or neurotransmitter allows the message to be passed to one or as many as thousands of other neurons. Neurotransmitter substances include acetylcholine, norepinephrine, dopamine, serotonin, and gamma-aminobutyric acid (GABA). These other neurons then carry the message to an interpretation center or a structure that takes appropriate action. CNS drugs act by mimicking or blocking the effects of neurotransmitters.

AUTONOMIC NERVOUS SYSTEM

The ANS is that portion of the nervous system that controls unconscious body activities. ANS fibers innervate smooth muscle, heart muscle, salivary glands, and other viscera. This system operates automatically and involuntarily to control visceral functions, such as gastrointestinal (GI) motility, rate and force of the heartbeat, secretion by glands, sizes of the pupils, and various other involuntary functions and characteristics. In contrast to the somatic nervous system, the ANS has two subdivisions: parasympathetic (**cholinergic**) and sympathetic (**adrenergic**). The sympathetic division regulates energy-expending activities (fight-or-flight responses), and the parasympathetic division regulates energy-conserving activities.

The ANS has two neurons that carry impulses to target structures (in contrast to the somatic nervous system, which has only one). The cell body of the first neuron arises in the CNS—in the thoracolumbar cord for the sympathetic nervous system and in the craniosacral cord for the parasympathetic nervous system (Figure 4-8). The axon of the first neuron leaves the CNS and travels to a ganglion, where it synapses with dendrites of the second

neuron. This second neuron then travels to the target structure (Figure 4-9). Axons of the first neuron are called *preganglionic*, and those of the second are called *postganglionic*. The synapse between the preganglionic neuron and the postganglionic neuron is called the **ganglionic synapse**.

Preganglionic fibers of the sympathetic nervous system are short. They end in ganglia adjacent to the spinal cord. The only exception is the preganglionic fiber to the adrenal medulla. The adrenal medulla itself is analogous to a postganglionic fiber because it releases epinephrine and norepinephrine directly into the bloodstream when stimulated by preganglionic fibers. Postganglionic sympathetic fibers are long.

Preganglionic fibers of the parasympathetic nervous system are generally long. They travel to ganglia located in the wall of the target organ. Postganglionic fibers are consequently short.

Normally, target sites of the ANS have both sympathetic and parasympathetic innervation. The physiologic functions of the two systems usually oppose each other and thereby bring about a state of balance. When this balance is disrupted, drug therapy may be indicated to restore the balance. The adrenal medulla, sweat glands, and hair follicles have only sympathetic fibers.

Stimulation of the sympathetic nervous system causes an increase in heart rate and respiratory rate, a decrease in GI activity, dilation of the pupils, constriction of blood vessels in smooth muscle, dilation of blood vessels in skeletal muscle, dilation of bronchioles, and an increase in blood glucose levels. These actions prepare an animal to fight or to flee. On the other hand, stimulation of the parasympathetic nervous system causes a decrease in heart rate and respiratory rate, an increase in GI activity, constriction of the pupils, and constriction of the bronchioles.

Receptors of the sympathetic (adrenergic) nervous system are subdivided as follows (Figure 4-10):

1. Alpha-1
2. Alpha-2
3. Beta-1
4. Beta-2
5. Dopaminergic

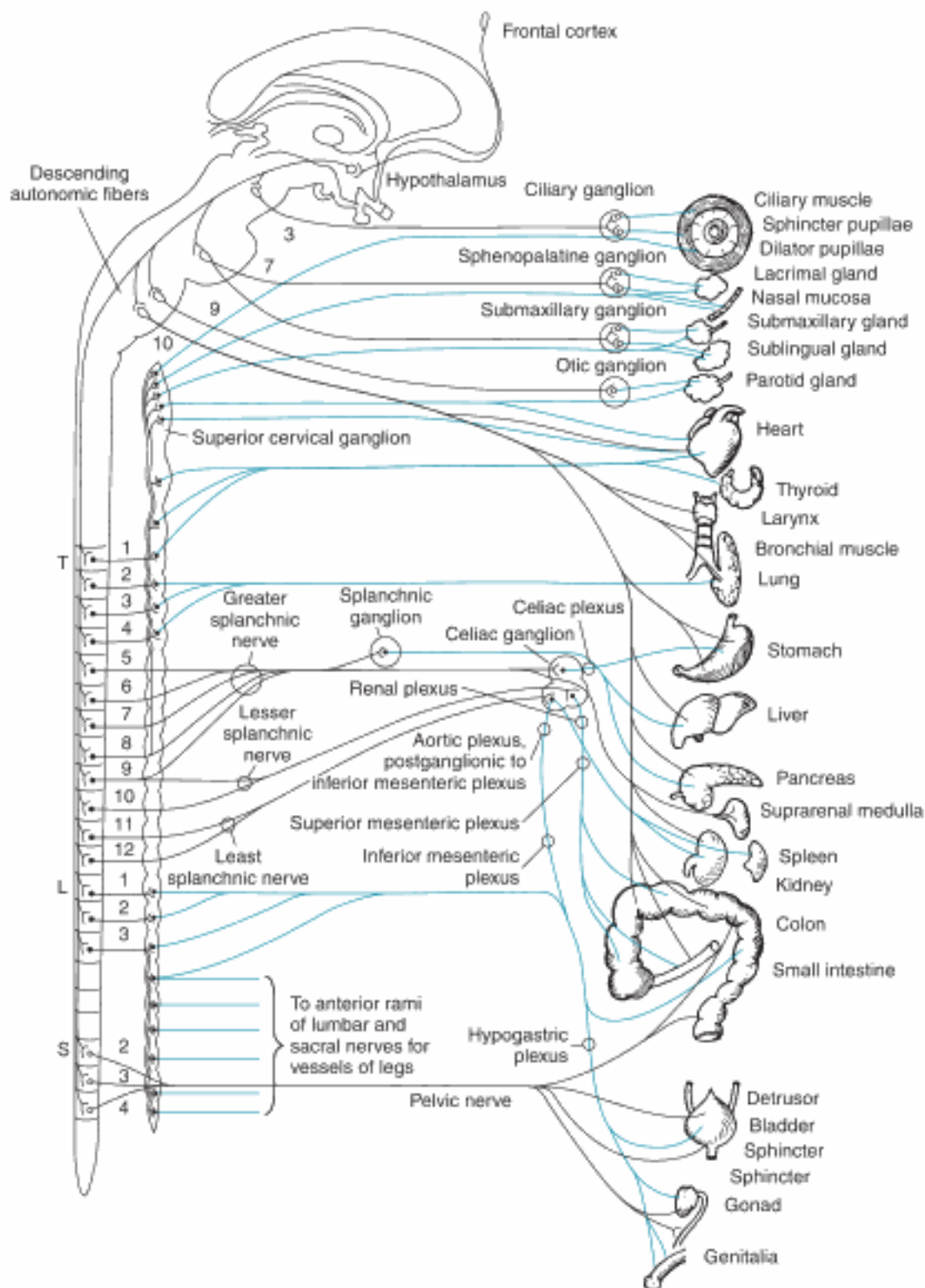

FIGURE 4-8

Schematic of the autonomic nervous system. (From Thibodeau JA: *Anatomy and physiology*, St. Louis, 1987, Mosby.)

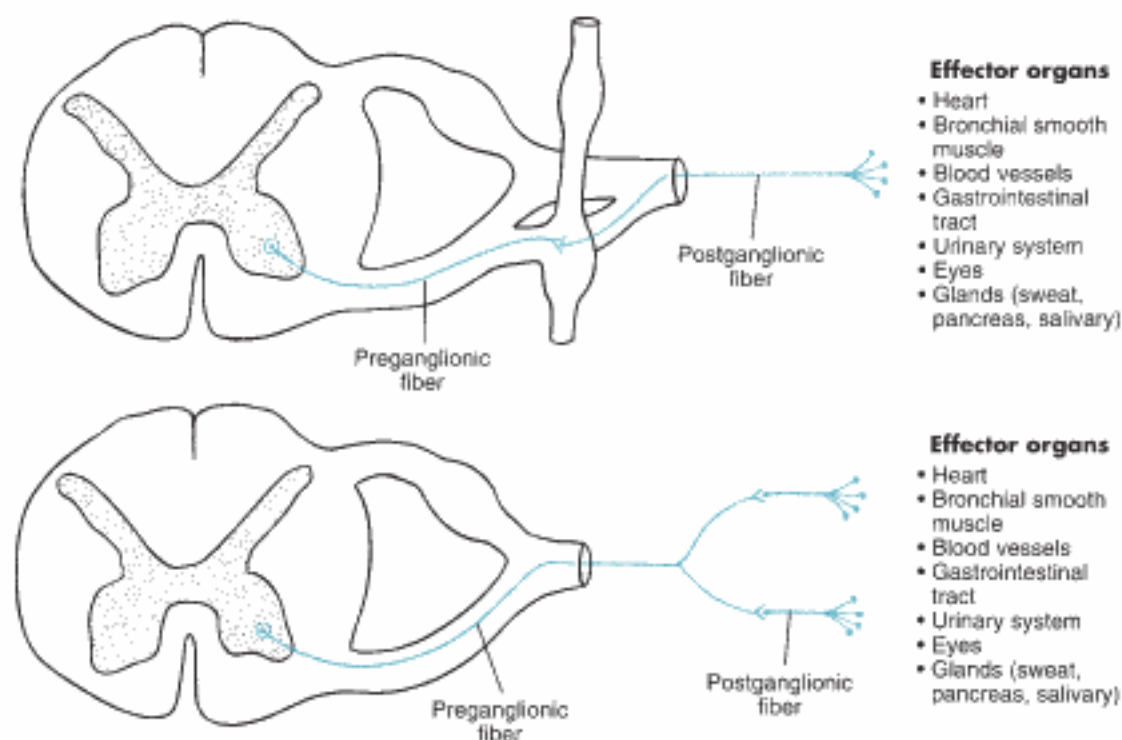

FIGURE 4-9 Preganglionic and postganglionic fibers of the autonomic nervous system. **A**, Sympathetic. **B**, Parasympathetic.

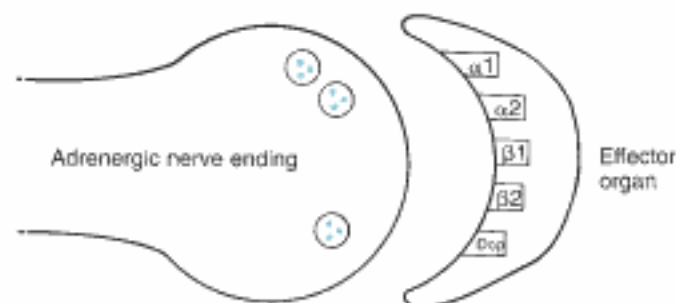

FIGURE 4-10 Adrenergic receptor types.

Generally, alpha receptors are stimulatory and beta receptors are inhibitory (Table 4-1). The parasympathetic (cholinergic) nervous system has **nicotinic** and **muscarinic receptors**. Effector organs have one or a combination of these receptors. A drug's effect is determined by the number of receptors in the effector and the drug's specificity for the receptor (Williams and Baer, 1990).

The primary neurotransmitters for adrenergic sites are norepinephrine, epinephrine, and dopamine. Epinephrine equally stimulates alpha and beta receptors and is therefore a potent stimulator of the heart and an equally powerful dilator of bronchioles. Acetylcholine is the neurotransmitter at sympathetic postganglionic fibers to sweat glands and the smooth muscle of blood vessels (muscarinic sites).

Table 4-1 Adrenergic Receptor Responses

Receptor	Target Organ	Response
Alpha-1	Arterioles	Constriction
	Urethra	Increased tone
	Eye	Dilation of pupil
Alpha-2	Skeletal muscle	Constriction
Beta-1	Heart	Increased rate, conduction, and contractility
Beta-2	Kidneys	Renin release
	Skeletal blood vessels	Dilation
Dopaminergic	Bronchioles	Dilation
	Kidneys	Dilation of blood vessels
	Heart	Dilation of coronary vessels
	Mesenteric blood vessels	Dilation

The neurotransmitter for cholinergic sites is **acetylcholine**. Acetylcholine combines with both nicotinic and muscarinic receptors.

Cholinergic sites are found in both the sympathetic and parasympathetic nervous systems. Nicotinic receptors are found in all autonomic ganglia, in the adrenal medulla, and at the neuromuscular junction of the somatic nervous system. Muscarinic receptors are found at the synapse of postganglionic fibers of the parasympathetic nervous system and at a few of the sympathetic postganglionic fibers.

How Drugs Affect the Autonomic Nervous System

Autonomic drugs bring about their effects by influencing the sequence of events that involve neurotransmitters. Most autonomic drugs bring about this alteration of events by doing the following:

1. Mimicking neurotransmitters
2. Interfering with neurotransmitter release
3. Blocking the attachment of neurotransmitters to receptors
4. Interfering with the breakdown or reuptake of neurotransmitters at the synapse

CLASSES OF AUTONOMIC NERVOUS SYSTEM AGENTS



Cholinergic Agents

Cholinergic agents are drugs that stimulate receptor sites mediated by acetylcholine. They achieve these effects by mimicking the action of acetylcholine (direct acting) or by inhibiting its breakdown (indirect acting). Cholinergic agents are also called **parasympathomimetic** because their effects resemble those produced by stimulating parasympathetic nerves.

Clinical Uses

Cholinergic agents do the following:

1. Aid in the diagnosis of myasthenia gravis
2. Reduce the intraocular pressure of glaucoma
3. Stimulate GI motility
4. Treat urinary retention
5. Control vomiting
6. Act as an antidote for neuromuscular blockers

Direct-Acting Cholinergics

1. Acetylcholine. Acetylcholine is seldom used clinically because it is broken down so rapidly by **acetylcholinesterase**.
2. Carbamylcholine. This product has been used to treat atony of the GI tract and to stimulate uterine contractions in swine.
3. Bethanechol (Urecholine). Bethanechol is used to treat GI and urinary tract atony.
4. Pilocarpine (Isopto Carpine, Akarpine, Pilocar). Pilocarpine reduces intraocular pressure associated with glaucoma.
5. Metoclopramide (Reglan). Metoclopramide is used to control vomiting and to promote gastric tract emptying.

Indirect-Acting Cholinergic (Anticholinesterase) Agents

1. Edrophonium (Tensilon). Edrophonium is used to diagnose myasthenia gravis.
2. Neostigmine (Prostigmine, Stiglyn). These products are used to treat urine retention and

GI atony and as an antidote to neuromuscular blocking agents.

3. Physostigmine (Antilitium, Eserine). Uses of this product are similar to those of neostigmine.
4. Organophosphate compounds. These are commonly used as insecticide dips and may result in toxicity if used inappropriately. See Pralidoxime below.
5. Demecarium (Humorsol). This drug is used in the preventive management of glaucoma.
6. Pyridostigmine (Mestinon). This drug is used for the treatment of myasthenia gravis.

Adverse Side Effects

Adverse side effects of the cholinergic drugs may include bradycardia, hypotension, heart block, lacrimation, diarrhea, vomiting, increased intestinal activity, intestinal rupture, and increased bronchial secretions.



Cholinergic Blocking Agents (Anticholinergic)

Cholinergic blocking agents are drugs that block the action of acetylcholine at muscarinic receptors of the parasympathetic nervous system.

Clinical Uses

Clinical uses of these drugs are as follows:

1. Treatment of diarrhea and vomiting by decreasing GI motility
2. As a preanesthetic to dry secretions and prevent bradycardia
3. To dilate the pupils for ophthalmic examination
4. To relieve ciliary spasm of the eye
5. To treat sinus bradycardia

The belladonna alkaloids of the deadly nightshade family of plants have been used as drugs for centuries and represent the prototype for this category of agents.

Dosage Forms

1. Atropine. Numerous generic and trade name products are available for parenteral or ophthalmic administration. Atropine is used as

a preanesthetic to dry secretions and to prevent bradycardia; as an antidote to organophosphate poisoning; to dilate the pupils for ophthalmic examination; to control ciliary spasms of the eye; to treat sinus bradycardia; and to slow a hypermotile gut.

2. Scopolamine. This is used in antidiarrheal medications.
3. Methscopolamine is an ingredient of Biosol-M. Methscopolamine is used to control diarrhea.
4. Glycopyrrolate (Robinul-V). Glycopyrrolate is a quaternary ammonium compound with actions similar to atropine. It provides longer action than atropine and is used primarily as a preanesthetic.
5. Aminopentamide (Centrine). Aminopentamide is used to control vomiting and diarrhea in dogs and cats.
6. Propantheline (Pro-Banthine). Propantheline is used to treat diarrhea, urinary incontinence, and bradycardia, and to reduce colonic peristalsis in horses to allow rectal examination. Propantheline, similar to glycopyrrolate, is a quaternary ammonium compound.
7. Pralidoxime (Protopam, 2-PAM). A cholinesterase reactivator used to treat organophosphate intoxication.

Adverse Side Effects

Adverse side effects of the cholinergic blockers are dose related. Overdose can cause drowsiness, disorientation, tachycardia, photophobia, constipation, anxiety, and burning at the injection site.

Technician's Notes

1. Atropine administered as a preanesthetic causes dilation of the pupils. It dries secretions and prevents bradycardia.
2. Atropine is packaged in small-animal and large-animal concentrations. Care should be taken not to confuse the two preparations.

Adrenergic (Sympathomimetic) Agents

Adrenergic (sympathomimetic) agents bring about action at receptors mediated by epinephrine or norepinephrine. Adrenergic agents may be classified as **catecholamines** or noncatecholamines, and either category can also be classified according to the specific receptor types activated (alpha-1, alpha-2, beta-1, beta-2). In most cases, alpha receptor activity causes an excitatory response (except in the GI tract), and beta stimulation causes an inhibitory response (except in the heart). Adrenergic activity is a complex subject, and more advanced texts should be consulted for a thorough explanation.

Clinical Uses

Adrenergic agents are used for the following purposes:

1. To stimulate the heart to beat during cardiac arrest
2. To reverse the hypotension and bronchoconstriction of anaphylactic shock
3. To strengthen the heart during congestive heart failure
4. To correct hypotension through vasoconstriction
5. To reduce capillary bleeding through vasoconstriction
6. To treat urinary incontinence
7. To reduce mucous membrane congestion (vasoconstriction) in allergic conditions
8. To prolong the effects of local anesthetic agents by causing vasoconstriction of blood vessels at the injection site, thereby prolonging their absorption
9. To treat glaucoma (alpha stimulation increases the outflow of and beta stimulation decreases the production of aqueous humor)

Dosage Forms

1. Epinephrine (Adrenalin). Epinephrine stimulates all receptors to cause an increase in heart rate and cardiac output, constriction of the blood vessels in the skin, dilation of the blood vessels in muscle, dilation of the bronchioles, and an increase in metabolic rate.

2. Norepinephrine (Levophed, Noradrenalin). Norepinephrine is mostly an alpha stimulator with some beta stimulation. Its primary influence is that of a vasopressor (to raise blood pressure).
3. Isoproterenol (Isuprel). Isoproterenol is a pure beta stimulator. Its primary use is for bronchodilation.
4. Phenylephrine (Neo-Synephrine). Phenylephrine is an alpha stimulator that is used as a nasal vasoconstrictor.
5. Dopamine (Intropin). Dopamine is a precursor of epinephrine and norepinephrine. Its action is dose dependent. It is used to treat shock and congestive heart failure and to increase renal perfusion.
6. Phenylpropanolamine (Ornade, Prolamine, Dexatrim). Phenylpropanolamine is used to treat urinary incontinence in dogs.
7. Dobutamine (Dobutrex). Dobutamine is a beta-1 agonist that is used for short-term treatment of heart failure.
8. Ephedrine (Vatronol), terbutaline (Brethine), and albuterol (Proventil). These products are beta agonists and their main use is bronchodilation.

Adverse Side Effects

These may include tachycardia, hypertension, nervousness, and cardiac arrhythmias. Hypertension, arrhythmia, and pulmonary edema may occur with an overdose.

Technician's Notes

Epinephrine is normally packaged as a 1:1000 dilution. Many clinicians prefer a 1:10,000 dilution for treating cardiac arrest. Mix 1 ml of the original dilution with 9 ml of sterile water to prepare a 1:10,000 dilution. Epinephrine is stored under refrigeration. A note should be placed in the emergency crash cart noting the location of this drug.

Adrenergic Blocking Agents

Adrenergic blocking agents are used to disrupt the activity of the sympathetic nervous system. They are classified according to the site of their action as an

alpha blocker, beta blocker, or ganglionic blocker. Drugs usually block only one category of receptor.

Alpha Blockers

Alpha blockers have had limited use in veterinary medicine. Phenoxybenzamine has been advocated by some clinicians for the treatment of laminitis in horses and urethral obstruction in cats. Yohimbine is used for xylazine antagonism.

Clinical Uses

See Dosage Forms.

Dosage Forms

1. Phenoxybenzamine (Dibenzylin). Phenoxybenzamine is a hypotensive (vasodilator) agent.
2. Tranquilizers (acepromazine, droperidol). These tranquilizers act as alpha blockers and cause vasodilation.
3. Prazosin (Minipress). Prazosin is a hypotensive agent.
4. Yohimbine (Yobine). Yohimbine is used as an antidote for xylazine toxicity.
5. Atipamezole (Antisedan). Atipamezole is a reversal agent for medetomidine.

Adverse Side Effects

Adverse side effects may include hypotension (phenoxybenzamine, tranquilizers, prazosin), tachycardia (phenoxybenzamine), muscle tremors (yohimbine), and seizures (acepromazine).

Beta Blockers

Beta blockers are used to treat glaucoma, arrhythmias, and hypertrophic cardiomyopathy.

Clinical Uses

See Dosage Forms.

Dosage Forms

1. Propranolol (Inderal). Propranolol is used to treat cardiac arrhythmias and hypertrophic cardiomyopathy.
2. Timolol (Timoptic). Timolol is an ophthalmic preparation that is used to treat glaucoma.
3. Atenolol. Used in a similar way to propranolol.

Adverse Side Effects

These include bradycardia, hypotension, worsening of heart failure, bronchoconstriction, heart block, and syncope.

Ganglionic Blockers

Ganglionic blockers are seldom used in veterinary medicine.

CENTRAL NERVOUS SYSTEM

CNS drugs have various uses in veterinary medicine. Depressant drugs are used to tranquilize or sedate animals to facilitate restraint or anesthetic procedures. They are also used to control pain, to induce **anesthesia**, and to prevent or control seizures. CNS drugs are also available to antagonize (reverse) the effects of some depressant drugs. Another group of CNS agents is used to stimulate the CNS to treat cardiac or respiratory depression or arrest. Euthanasia drugs allow veterinarians to provide a quick and painless end to hopeless medical situations.

Drugs that affect the CNS generally cause depression or stimulation. They are thought to generate these changes by altering nerve impulse transmissions between the spinal cord and the brain or within the brain itself. Altering impulse transmissions within the thalamus could prevent messages regarding painful stimuli from reaching interpretation centers within the cerebrum. Interfering with impulses within the reticular activating system could alter levels of consciousness or wakefulness (Ganong, 2003). The changes that occur in the transmission of nerve impulses as a result of administration of CNS drugs are probably brought about by altered neurotransmitter activity.

The categories of CNS drugs that are covered in this chapter include the following:

1. Tranquilizers
2. Barbiturates
3. Dissociatives
4. Opioid/antagonists

5. Neuroleptanalgesics/antagonists
6. Drugs to prevent or control seizures
7. Inhalants
8. Miscellaneous CNS drugs
9. CNS stimulants
10. Euthanasia agents



Tranquilizers

Phenothiazine Derivatives

The mechanism of action of the phenothiazine derivatives on the CNS is not well understood. However, it has been proposed that they are dopamine blockers (Muir and Hubbell, 2007). The effects on the cardiovascular system are a result of alpha-adrenergic blockade.

Phenothiazine derivative tranquilizers produce sedation and allay fear and anxiety without producing significant analgesia. Sudden painful stimuli arouse the animal. Phenothiazine derivative tranquilizers produce an antiemetic effect by depressing the chemoreceptor trigger zone in the brain and have a mild antipruritic effect. These agents also reduce the tendency of epinephrine to induce cardiac arrhythmias.

Clinical Uses

Phenothiazine derivatives are used for prevention or treatment of vomiting, relief of mild pruritus, and sedation/tranquilization.

Dosage Forms

1. Acepromazine maleate (Acepromazine, Promace)
2. Chlorpromazine hydrochloride (Thorazine)
3. Promazine HCl (Sparine)
4. Prochlorperazine/isopropamide (Darbazine, Compazine)

Adverse Side Effects

Phenothiazine derivative tranquilizers can cause hypotension and hypothermia through their vasodilator effects (alpha blockade). They also can induce seizures (by lowering the seizure threshold) in epileptic animals.

Technician's Notes

1. Phenothiazine derivatives should not be used within 1 month of worming with an organophosphate anthelmintic.
2. The tranquilizing effect may be reduced in an excited animal.

Phenothiazine derivative tranquilizers are approved for use in a wide variety of animals and for administration by almost any route. They generally are relatively safe drugs to use when administered appropriately. They should be given with care when used with other CNS depressants because of the additive effect. Most phenothiazine derivative tranquilizers are metabolized by the liver and excreted by the kidneys.

Benzodiazepine Derivatives

The mechanism of action of diazepam occurs through depression of the thalamic and hypothalamic areas of the brain. This drug produces sedation, muscle relaxation, appetite stimulation (especially in cats), and anticonvulsant activity. Diazepam also produces minimal depression of the cardiovascular and respiratory systems when compared with other CNS depressants. It sometimes is used in combination with ketamine to induce short-term anesthesia. Diazepam is very useful for treating seizures in progress.

Several potential drug interactions can occur when diazepam is administered simultaneously with other drugs, and appropriate references should be consulted.

Clinical Uses

Clinical uses include sedation, relief of anxiety and behavioral disorders, treatment of seizures, and appetite stimulation. Diazepam can be used as an injectable anesthetic.

Dosage Forms

1. Diazepam (Valium, Vazepam)
2. Midazolam (Versed)
3. Alprazolam (Xanax)

Adverse Side Effects

These are limited when used as directed. Dogs can exhibit excitement. Overdose may cause excessive CNS depression.

Technician's Notes

1. Diazepam should be stored at room temperature and protected from light.
2. Diazepam should not be stored in plastic syringes or in solution bags because it can be absorbed into the plastic.
3. Manufacturers recommend that it not be mixed with other medications or solutions.
4. Diazepam is metabolized by the liver and eliminated by the kidneys.
5. Alprazolam is also used as an appetite stimulant.

Xylazine Hydrochloride

Xylazine is an alpha-2 agonist with sedative, analgesic, and muscle relaxant properties. It is approved for use in dogs, cats, horses, deer, and elk. This agent causes vomiting in a large percentage of cats and in some dogs. Xylazine is antagonized by yohimbine. It produces effective analgesia in horses and is often used for treating the pain associated with colic and for sedation for minor procedures. It is also used in combination with ketamine for short-term field procedures in horses, such as castration and suturing of extensive wounds, because this combination usually produces 15 to 20 minutes of recumbency. Extralabel use of xylazine for cesarean sections in cattle and other surgical procedures is common. Xylazine is used in cats and dogs as a tranquilizer and in combination with other injectable agents for surgical procedures.

Clinical Uses

Clinical uses include sedation, analgesia, short-term anesthesia (when combined with other agents), and induction of vomiting.

Dosage Forms

1. Rompun
2. AnaSed
3. Gemini
4. Sedazine

Adverse Side Effects

These include bradycardia, hypotension, respiratory depression, and increased sensitivity to epinephrine, resulting in cardiac arrhythmias. An overdose increases the potential for these effects.

Technician's Notes

1. Because of the potential of xylazine to cause bradycardia or heart block in dogs, atropine should be used as a premedicant in this species.
2. Xylazine is used in cattle at one tenth of the equine dose.
3. Horses may appear heavily sedated with xylazine and still respond to painful stimuli by kicking.
4. Small-animal (20 mg/ml) and large-animal (100 mg/ml) concentrations are available. Care should be taken not to confuse them when administering a drug dose to an animal.

Detomidine Hydrochloride

Detomidine, similar to xylazine, is an alpha-2 agonist. It is approved as a sedative/analgesic for horses, and clinicians often report excellent analgesic properties in their patients when using this product. It is used for procedures in horses when sedation and analgesia are needed and reportedly produces better analgesia of the rear limbs than does xylazine.

Clinical Uses

Detomidine is used for sedation and analgesia in horses.

Dosage Form

Dormosedan

Adverse Side Effects

These may include sweating, muscle tremors, penile prolapse, bradycardia, and heart block.

Technician's Notes

The manufacturer warns that detomidine should be used very carefully with other sedative drugs, and that it should not be used with potentiated sulfa drugs such as trimethoprim/sulfa.

Medetomidine

Medetomidine is an alpha-2-adrenergic agonist labeled for use as a sedative and analgesic in dogs older than 12 weeks of age. Atipamezole (Antisedan) is the reversal agent for this drug.

Clinical Uses

Uses include facilitating clinical examination, minor surgical procedures, and minor dental procedures that do not require intubation.

Dosage Form

Domitor

Adverse Side Effects

Side effects include bradycardia (product insert states that hemodynamics are maintained), atrioventricular (AV) heart block, decreased respirations, hypothermia, urination, vomiting, hyperglycemia, and pain at the injection site.

Technician's Notes

1. Treatment of medetomidine-induced bradycardia with anticholinergic drugs (atropine or glycopyrrolate) is not recommended because of the potential for more serious arrhythmias.
2. Antisedan is recommended for treatment of medetomidine-induced effects.
3. Before the use of medetomidine in combination with other sedatives is attempted, references should be consulted for potential side effects and dosages.

Romifidine

Romifidine is an alpha-2-adrenergic agonist labeled for use in horses.

Clinical Uses

Romifidine is used as a sedative to facilitate handling, examination, and treatment, and as a premedication prior to general anesthesia.

Dosage Form

Sedivet



Barbiturates

The barbiturates are one of the oldest categories of CNS depressants used in veterinary medicine. They are derived from the parent compound barbituric acid and cause various responses ranging from sedation to death, depending on the dose and the circumstances of use. Barbiturates are used in veterinary medicine as sedatives, anticonvulsants, general anesthetics, and euthanasia agents. They are easy and cheap to administer. They have great potential for complications because of their potent depressing effects on the cardiac and pulmonary systems (especially in cats), and because they are nonreversible and must be metabolized by the liver before elimination can occur. Individual patients with poor liver function, little body fat, or preexisting illnesses that cause acidosis may be at risk when receiving barbiturates. Because of their alkalinity, the ultrashort-acting barbiturates can cause necrosis of the tissue if administered outside the vein in the subcutaneous space. Barbiturates are metabolized by the liver and are potent depressors of the respiratory system.

Barbiturates are classified according to their duration of action as long-acting, short-acting, and ultrashort-acting. Or they are classified according to the chemical side chain on the barbituric acid molecule as an oxybarbiturate or a thiobarbiturate (Table 4-2). The long- and short-acting barbiturates have a side chain that is connected by oxygen; they are therefore called *oxybarbiturates*. The thiobarbiturates have a side chain connected by a sulfur. The thiobarbiturates are highly soluble in fat and tend to move rapidly out of the CNS into the fat stores of the body, thus accounting for their ultrashort activity.

Clinical Uses

Clinical uses include the prevention and treatment of seizures, as well as sedation, anesthesia, and euthanasia.

Long-Acting Barbiturates (Oxybarbiturates, 8 to 12 Hours)

Phenobarbital. Numerous proprietary and generic products are available. Phenobarbital is used primarily as an anticonvulsant to prevent epileptic

Table 4-2 Barbiturate Classifications

Generic Name	Proprietary Name	Classification	Duration of Action
Phenobarbital	Luminal	Long-acting oxybarbiturate	4 to 8 hours
Pentobarbital	Nembutal	Short-acting oxybarbiturate	½ to 2 hours
Thiopental	Pentothal	Ultrashort-acting thiobarbiturate	10 to 30 minutes

seizures. It is administered by the oral route. Phenobarbital is a Class IV controlled substance.

Short-Acting Barbiturates (Oxybarbiturates, 45 Minutes to 1.5 Hours)

Pentobarbital sodium (Nembutal and numerous generic products). Pentobarbital is given by intravenous injection (the intraperitoneal route also may be used) and provides 1 to 2 hours of general anesthesia. In the early days of veterinary anesthesia, it was the general anesthetic that was routinely used in dogs. Today, pentobarbital is used primarily to control seizures in progress and as a euthanasia agent. Intravenous administration of glucose or concurrent use of chloramphenicol may prolong the recovery period. Pentobarbital is a Class II controlled substance.

Ultrashort-Acting Barbiturates (Thiobarbiturates, 5 to 30 Minutes)

Thiobarbiturates are very alkaline (especially at the higher concentrations) and must be given intravenously to avoid necrosis and subsequent sloughing of tissue. Thiobarbiturates are redistributed into the fat stores of the body within 5 to 30 minutes.

Extreme care should be taken when a thiobarbiturate is administered to a thin animal because of the lack of fat stores. Thiobarbiturates are prepared as a sterile powder in vials for dilution up to the desired concentration. They are stable for long periods in undiluted form. Sterile water for injection should be used as the diluent because solutions with electrolytes hasten precipitate formation. Solutions should not be administered if precipitates are present.

Thiobarbiturates can cause a period of apnea when they are rapidly administered intravenously. If spontaneous respirations do not resume in a short

time, controlled respirations should be started. Barbiturates can also cause a period of CNS excitement when administered intravenously if they are given too slowly. It is often recommended to give one third to one half of the calculated dose rapidly to avoid the excitement phase. The remainder of the dose is administered in increments until the desired effect is achieved.

Dosage Forms

1. Thiopental (Pentothal). Thiopental is used as an intravenous agent to induce general anesthesia.
2. Methohexital (Brevane). Methohexital is an ultrashort-acting barbiturate that produces 5 to 10 minutes of anesthesia. It has been recommended for use in sight hounds because of its rapid redistribution and metabolism by the liver.

Adverse Side Effects

These include excessive CNS depression, paradoxical CNS excitement, severe respiratory depression, and cardiovascular depression. Tissue irritation may occur when barbiturates are injected perivascularly.

Technician's Notes

1. Recovery from pentobarbital is often prolonged, and dogs exhibit padding limb movements during this time.
2. Thiobarbiturates should not be used in sight hounds or in any very thin animal.
3. Giving additional doses of thiobarbiturates may prolong recovery.
4. Barbiturates are potent depressors of the respiratory system.



Dissociative Agents

The dissociative agents belong to the cyclohexylamine family, which includes phencyclidine, ketamine, and tiletamine. Involuntary muscle rigidity (**cataplexy**), amnesia, and analgesia characterize dissociative anesthesia. Pharyngeal/laryngeal reflexes are maintained, and muscle tone is increased. Because deep abdominal pain is not eliminated (surgical stage III is not usually reached) with dissociative anesthesia, it is recommended only for restraint, diagnostic procedures, and minor surgery. Dissociative agents often are combined with other agents for abdominal surgery, however. Dissociative drugs produce minor cardiac stimulation, and respiratory depression can occur with higher doses. These agents act by altering neurotransmitter activity, causing depression of the thalamus and cerebral cortex, and activating the limbic system (Plumb, 2005).

Some species are often ataxic and hyperresponsive during induction and recovery with dissociative agents (Muir and Hubbell, 2007). Tremors, spasticity, and convulsions can occur at higher doses. Hallucinations have been reported in humans and are suspected in cats.

Clinical Uses

Dissociative agents are used for sedation, restraint, and anesthesia.

Dosage Forms

1. Ketamine HCl (Ketaset, Vetalar, Ketalar). Ketamine is approved for use in humans, primates, and cats but has extralabel uses in various species, including dogs, horses, birds, small ruminants, and reptiles. Tranquilizers, such as acepromazine, xylazine, and diazepam, are often used concurrently with ketamine to enhance muscle relaxation and to deepen the level of anesthesia. Oral, ocular, and laryngeal reflexes are maintained when ketamine is used alone (except at high doses). Occasional spastic jerking movements can occur in cats that are administered ketamine. Ketamine produces good somatic analgesia but poor visceral analgesia.

Increased salivation may accompany administration of this drug and can be controlled or prevented with the use of atropine or glycopyrrolate. An ophthalmic lubricant should be used because cats' eyes remain open after administration of ketamine. Ketamine is a Class III controlled substance.

2. Tiletamine HCl (Telazol—tiletamine plus zolazepam HCl). Telazol is an injectable anesthetic that consists of a combination of tiletamine (chemically related to ketamine) and zolazepam (a tranquilizer). Telazol is approved for use in dogs and cats. The pharmacokinetics and pharmacotherapeutics of tiletamine are similar to those of ketamine. Because of the zolazepam in this product, additional agents are not needed for muscle relaxation. Ocular lubrication should be used in cats receiving Telazol. Telazol is a Class III controlled substance.
3. Phencyclidine (Sernylan). This dissociative agent is no longer available. It was originally used as an immobilizing agent for nonhuman primates. Its street name is "PCP" or "angel dust" (Upson, 1988).

Adverse Side Effects

These are usually associated with high doses and include spastic jerking movement, convulsions, respiratory depression, burning at the intramuscular injection site, and drying of the cornea.

Technician's Notes

1. Both ketamine and tiletamine may cause burning at the injection site. Adequate restraint should be used to ensure injection of all medication.
2. Metabolites of the dissociative agents are excreted through the kidneys. These drugs may be contraindicated in animals with compromised kidney function.



Opioid Agonists

An opioid is any compound derived from opium poppy alkaloids and synthetic drugs with similar pharmacologic properties. These drugs produce analgesia and sedation (hypnosis) while reducing

anxiety and fear. Narcotic effects are produced in combination with opiate receptors at deep levels of the brain (e.g., thalamus, hypothalamus, limbic system). Opioid receptors are grouped into the following four classes (Paddleford, 1999):

1. Mu—found in pain-regulating areas of the brain; contribute to analgesia, euphoria, respiratory depression, physical dependence, and hypothermic actions
2. Kappa—found in the cerebral cortex and spinal cord; contribute to analgesia, sedation, and miosis
3. Sigma—may be responsible for struggling, whinnying, hallucinations, and mydriatic effects
4. Delta—modify mu receptor activity

Opioids are used as preanesthetics or postanesthetics because of their sedative and analgesic properties. Sedation is more pronounced at higher doses. They are sometimes used alone or in combination with tranquilizers as anesthetics for surgical procedures, for relief of colic pain in horses, and for restraint/capture of wild/zoo animals. At low doses, the opioids have antitussive (cough suppression) properties owing to depression of the cough center in the brain and antidiarrheal action because they cause a reduction in peristalsis or segmental contractions. Several potential adverse side effects are associated with narcotics. Opioids are potent respiratory depressants. Because they affect the thermoregulatory centers in the brain (the body's thermostat), they may cause panting, defecation, flatulence, and vomiting. Sound sensitivity may also occur. Excitement may occur in dogs if the narcotic is rapidly given intravenously. Cats and horses are reported to be sensitive to the opioids and may exhibit excitatory effects at high doses. Because opioids cross the placenta fairly slowly and their effects can be antagonized, they can be useful when cesarean section is performed. The liver metabolizes opioids, and resultant metabolites are eliminated in the urine. Most opioid preparations are Class II controlled substances, and narcotic antagonists can antagonize them.

Clinical Uses

Opioid agonists are used for analgesia, sedation, restraint, anesthesia, treatment of coughing, and treatment of diarrhea.

Naturally Occurring Narcotics

1. Opium (laudanum—10% opium), paregoric. Opium is derived from the seed capsule of the opium poppy. Paregoric, also called *camphorated tincture of opium*, has been used for longer than 100 years for the treatment of diarrhea. It has been used in veterinary medicine for treating diarrhea, primarily in calves and foals.
2. Morphine sulfate (Duramorph). Morphine is an opium derivative used to treat severe pain. Occasionally, it is used as a preanesthetic or anesthetic agent (e.g., cesarean section in dogs). It is also used to relieve anxiety associated with acute congestive heart failure. It exerts its effects primarily on mu receptors. Morphine is a Class II controlled substance that should be used under strict supervision because of its potential for abuse. It is the standard opioid with which all others are compared in terms of analgesic effect.

Synthetic Narcotics

1. Meperidine (Demerol). Meperidine is a mu agonist that is approximately one eighth as potent an analgesic as morphine. It is used for relief of acute pain, such as that occurring after orthopedic procedures. It also may be combined with a tranquilizer for use as an anesthetic agent (neuroleptanalgesic). No meperidine products carry a veterinary label. However, human products often have extralabel uses in animals. Naloxone is the preferred antagonist.
2. Oxymorphone (Numorphan). Oxymorphone is a semisynthetic opioid that is a mu agonist. It is approximately 10 times more potent an analgesic than morphine. This drug is used primarily in dogs for restraint, for diagnostic procedures, and for minor surgical procedures. It may be combined with tranquilizers to produce neuroleptanalgesia; naloxone is the antagonist.
3. Butorphanol tartrate (Torbutrol, Torbugesic). Butorphanol is a synthetic, partial opioid agonist. Its narcotic activity is exerted on kappa and sigma receptors. It is a Class IV controlled substance. Butorphanol has 4 to 7 times the analgesic properties of morphine and significant antitussive effects (Plumb, 2005). Torbutrol is a product that is approved as an antitussive agent

- in dogs. It is also used in dogs and cats as an analgesic and preanesthetic. Torbugesic is approved for the treatment of pain associated with colic in horses. It is also used in combination with other sedatives/tranquilizers in horses, dogs, and cats as a preanesthetic or for minor surgical procedures.
4. Fentanyl (Sublimaze). Fentanyl is an opioid agonist that is found in the neuroleptanalgesic Innovar-Vet. It has approximately 100 times the analgesic properties of morphine. Fentanyl is a Class II controlled substance. Fentanyl transdermal patches are sometimes used in animals to control chronic pain (see Chapter 14).
 5. Hydrocodone bitartrate (Hycodan, Tussiong). Hydrocodone is an opioid agonist that is used as an antitussive agent in dogs. It is a Class III controlled substance.
 6. Etorphine (M-99). Etorphine is an opioid that produces analgesic effects 1000 times those of morphine. It is restricted to use by veterinarians in zoo or exotic animal practice (Upson, 1988). It is lethal to people who accidentally inject themselves (it also can be absorbed through intact skin) if the antagonist (diprenorphine) is not administered immediately. Etorphine is a Class II controlled substance.
 7. Pentazocine (Talwin, Talwin-V). Pentazocine is a partial opioid agonist that is approved for pain relief in horses and dogs. It is a Class IV controlled substance.
 8. Diphenoxylate (Lomotil). Diphenoxylate is a synthetic opioid agonist that is combined with atropine for use as an antidiarrheal agent. This drug is a Class V controlled substance.
 9. Apomorphine—generic labeling. Apomorphine is an opioid with the principal effect of inducing vomiting by stimulating the chemoreceptor trigger zone in the brain. This drug is often administered by placing a portion of a tablet in the conjunctival sac for absorption (see Chapter 8)
 10. Methadone (Dolophine). Methadone is a synthetic opioid that was developed as a treatment for morphine and heroin addiction in humans. Its primary use in veterinary medicine

is in the treatment of colic pain in horses.

Methadone is a Class II controlled substance.

11. Codeine—generic labeling or in combination. Codeine is an opioid that is available in human label products for use as an antitussive in dogs.
12. Carfentanil (Wildnil). Carfentanil is used to induce wildlife anesthesia. It has 10,000 times the potency of morphine.
13. Buprenorphine (Buprenex). Buprenorphine is a human label, partial mu agonist-antagonist. It is a potent analgesic that is used in several small animal species.

Adverse Side Effects

These can include respiratory depression, excitement (cats and horses), nausea, vomiting, diarrhea, defecation, panting, and convulsions. Overdose causes profound respiratory depression.



Opioid Antagonists

Opioid antagonists block the effects of opioids by binding with opiate receptors, displacing narcotic molecules already present, and preventing further narcotic binding at the sites. These antagonists are classified as pure antagonists or as partial antagonists. The partial antagonists may have some agonist activity (analgesic and respiratory depressant effects).

These drugs usually are administered by the intravenous route and exert their effects very rapidly (15 to 60 seconds).

Clinical Uses

Opioid antagonists are used to antagonize the effects of opioid agonists.

Dosage Forms

1. Naloxone (naloxone HCl injection, Narcan). Naloxone is a pure opioid antagonist that is chemically similar to oxymorphone, with high affinity for mu receptors. It has no agonist activity.
2. Nalorphine (Nalline). Nalorphine is a partial antagonist that may produce untoward analgesic and respiratory depressant effects.

Adverse Side Effects

Nalorphine may induce respiratory depression. Naloxone usually has few adverse effects if given in the correct dose.

Neuroleptanalgesics

A neuroleptanalgesic agent consists of an opioid and a tranquilizer. Animals that receive neuroleptanalgesics may or may not remain conscious (Muir and Hubbell, 2007). They often defecate and are highly responsive to sound stimuli. The opioid effects of the neuroleptanalgesics can be antagonized with the opioid antagonists.

Clinical Uses

Neuroleptanalgesics are used for sedation and restraint, and to produce anesthesia.

Dosage Forms

1. Fentanyl and droperidol (Innovar-Vet). Innovar-Vet is the only commercially available neuroleptanalgesic. It may be used for restraint, for diagnostic procedures, as a preanesthetic, and for minor surgical procedures.
2. Other neuroleptanalgesics may be prepared by a clinician and include the following:
 - Acepromazine and morphine
 - Acepromazine and oxymorphone
 - Xylazine and butorphanol

Adverse Side Effects

These can include panting, flatulence, personality changes, increased sound sensitivity, and bradycardia. Overdose may cause severe depression of the CNS, respiratory system, and cardiovascular system.

Drugs Given to Prevent or Control Seizures

Seizures occur in animals for various reasons, which include but are not limited to unknown (idiopathic), infectious (postdistemper), traumatic (head injury), toxicity (strychnine poisoning), and metabolic (heatstroke) factors. Prolonged seizures in progress

require emergency action with intravenous therapy. Periodic, recurring seizures require preventive oral medication. Oral preventive therapy often must be titrated to the individual patient and reviewed regularly for the appropriate dose adjustment that controls seizure activity.

Clinical Uses

These drugs are used to prevent seizures or to control seizures in progress.

Dosage Forms

1. Diazepam (Valium). Diazepam is a tranquilizer with potent antiseizure properties. It is administered intravenously and has a 3- to 4-hour duration of action.
2. Pentobarbital—generic products. Pentobarbital is a short-acting barbiturate that is effective for controlling seizures. It is administered intravenously and has a 1- to 3-hour duration.
3. Phenobarbital (Luminal, Solfoton, generic formulations). Phenobarbital is an effective antiseizure drug that is available in oral and parenteral formulations. The oral route is the usual means of administering this drug to dogs and cats. The injectable form is used in horses (foals) by some clinicians. Drowsiness is a potential side effect of phenobarbital. Phenobarbital is a Class IV controlled substance.
4. Primidone (Mylepsin). Primidone is similar chemically to phenobarbital, and a portion of the primidone dose is metabolized to phenobarbital by the liver. It is administered orally to dogs and cats, although its use in cats is controversial. Adverse side effects may include agitation, anxiety, polyuria, polydipsia, and dermatitis.
5. Phenytoin sodium (Dilantin). The use of phenytoin has declined considerably through the years because of its variable pharmacokinetics in dogs and cats (Plumb, 2005). It may occasionally be used in combination with other antiseizure medications.
6. Bromide is an old anticonvulsant that has sparked renewed interest, mainly as an adjunct to phenobarbital or primidone therapy.
7. Clorazepate
8. Felbamate

Adverse Side Effects

These may include drowsiness, CNS depression, anxiety, agitation, polyuria, polydipsia, and hepatotoxicity (phenobarbital and primidone). Consult product inserts or appropriate references for specific effects.

Technician's Notes

1. Inadequate client compliance is a frequent cause of failure of anticonvulsant therapy. Clients should be advised about the importance of following medication instructions carefully.
2. Reserpine and phenothiazine drugs should not be given to epileptic animals.



Inhalant Anesthetics

Inhalant anesthetic agents are used to produce general anesthesia. They are converted from a liquid to a gaseous phase by an anesthetic vaporizer and are delivered to the lungs with the use of an oxygen source and a patient breathing circuit. From the alveoli of the lungs, they are absorbed into the bloodstream and delivered to the CNS, where they produce unconsciousness, analgesia, and muscle relaxation through mechanisms not fully understood.

Inhalants generally require little biotransformation for elimination from the body. They enter and exit the body through the lungs, and this facilitates a rapid induction and recovery from the effects of the agent compared with injectable anesthetic agents. It also permits a quicker alteration of the depth of anesthesia.

The amount (partial pressure) of inhalant anesthetic in the brain is proportionate to the alveolar concentration of the agent. Alveolar concentration depends on the amount of agent delivered to the lungs compared with the amount removed from the lungs. Delivery of the agent to the lungs can be increased by increasing the vaporizer setting, increasing the fresh gas (oxygen) flow, increasing minute ventilation, or decreasing mechanical and physiologic dead space. Factors that influence removal of the agent from the lungs include the

solubility (blood-gas partition coefficient) of the agent, the molecular weight of the agent, the partial pressure difference between the agent in the alveolus and the agent in the blood, the amount of alveolar surface available for exchange (absence of lung pathology), and cardiac output.

Uptake by tissue of an anesthetic agent depends mainly on the degree of tissue perfusion and the solubility of the agent in the tissue. Vessel-rich tissue (brain, heart, lungs, liver, kidneys, intestine, and endocrine glands) receives the greatest percentage of cardiac output and is consequently the first to reach equilibrium during uptake of an anesthetic gas and the first to download an agent. Lipid-rich cells, similar to brain cells, absorb more agent than do lipid-poor cells.

Characteristics important to the understanding of inhalant agents include MAC (minimum alveolar concentration), partition coefficient, and vapor pressure (Table 4-3). The MAC value of an anesthetic agent is a measure of potency and is the alveolar concentration that prevents gross purposeful movement in 50% of patients in response to a standardized painful stimulus. Lower numbers indicate more potent agents, and values may vary slightly between species. The partition coefficient is the ratio of the number of molecules of an anesthetic gas that exist in two phases (blood/gas). It indicates the solubility of an agent in a tissue like blood and correlates with the speed of induction and recovery. Lower numbers indicate faster agents. Vapor pressure of an agent indicates how volatile it is and the maximum concentration that can be achieved. Higher numbers indicate greater volatility and the need for a precision vaporizer.

Exposure to anesthetic waste gases can pose a health hazard to the veterinary technician if improper scavenging of waste is not carried out. Reproductive, hepatic, and renal effects have been noted. Toxicity is likely due to the biotransformation of by-products of the agents. Inhalant agents are biodegraded to various degrees (methoxyflurane, 50%; halothane, 25%; isoflurane, <0.2%; sevoflurane, 3%; nitrous oxide, 0.0004%).

Clinical Uses

Inhalant anesthetics are used to induce and maintain general anesthesia in animal patients.

Table 4-3 Physical Properties of Currently Used Inhalation Anesthetics

Property	Sevoflurane	Desflurane	Isoflurane	Halothane	Methoxyflurane	Nitrous Oxide
Formula	$ \begin{array}{c} \text{F} \\ \\ \text{H} \text{---} \text{C} \text{---} \text{F} \\ \quad \\ \text{F} \text{---} \text{C} \text{---} \text{O} \text{---} \text{C} \text{---} \text{H} \\ \quad \\ \text{H} \quad \text{F} \text{---} \text{C} \text{---} \text{F} \\ \\ \text{F} \end{array} $	$ \begin{array}{c} \text{F} \text{ H} \quad \text{F} \\ \quad \quad \\ \text{F} \text{---} \text{C} \text{---} \text{C} \text{---} \text{O} \text{---} \text{C} \text{---} \text{H} \\ \quad \quad \\ \text{F} \quad \text{F} \quad \text{F} \end{array} $	$ \begin{array}{c} \text{F} \text{ H} \quad \text{F} \\ \quad \quad \\ \text{F} \text{---} \text{C} \text{---} \text{C} \text{---} \text{O} \text{---} \text{C} \text{---} \text{H} \\ \quad \quad \\ \text{F} \quad \text{Cl} \quad \text{F} \end{array} $	$ \begin{array}{c} \text{Br} \text{ F} \\ \quad \\ \text{H} \text{---} \text{C} \text{---} \text{C} \text{---} \text{F} \\ \quad \\ \text{Cl} \quad \text{F} \end{array} $	$ \begin{array}{c} \text{Cl} \text{ F} \quad \text{H} \\ \quad \quad \\ \text{H} \text{---} \text{C} \text{---} \text{C} \text{---} \text{O} \text{---} \text{C} \text{---} \text{H} \\ \quad \quad \\ \text{Cl} \quad \text{F} \quad \text{H} \end{array} $	
Molecular weight	200	168	184.5	197.4	165.3	44
Specific gravity (20° C)	1.52	1.47	1.49	1.86	1.41	–
Boiling point (° C)	59	23.5	48.5	50.2	104.7	–
Vapor pressure at 20° C (mm Hg)	160	664	239.5	244.1	22.8	–
ml vapor/ml liquid at 20° C	182.7	209.7	194.7	227	207	–
Preservative	None	None	None	0.01% thymol	0.01% butyl hydroxytoluene	None
Stability						
Soda lime	No?	Stable	Stable	Decomposes	Decomposes	Stable
UV light	–	–	Stable	Decomposes	Decomposes	–

From Padleked RR: Manual of small animal anesthesia, ed 2, Philadelphia, 1999, WB Saunders Co.

Dosage Forms

The inhalant agents discussed in this section include isoflurane, sevoflurane, halothane, methoxyflurane, and nitrous oxide.

1. **Isoflurane (Forane, Isoflo).** Isoflurane was synthesized in 1968 and was used clinically in people by 1970. Isoflurane is a colorless liquid with a pungent odor. It is stable and does not require a preservative. A halogenated ether, it is one of the least soluble of the inhalant agents. It is less potent than halothane and methoxyflurane but has very rapid induction and recovery times. Isoflurane allows a stable heart rhythm and does not decrease cardiac output at clinically used levels. It is metabolized at a very low rate (<0.2%) This agent is used in a wide variety of species.
2. **Sevoflurane (SevoFlo).** Sevoflurane is a halogenated ether with little odor, which makes it a good choice for mask induction. This agent is characterized by very rapid induction and recovery times. Its cardiovascular and respiratory effects are similar to those of isoflurane. Sevoflurane is often used in high-risk, small-animal patients because of its safety and rapid, smooth induction. Only 3% of sevoflurane is metabolized. The disadvantage of the use of this agent is its cost compared with that of isoflurane.
3. **Halothane (Halothane).** Halothane is a halogenated hydrocarbon that was first used clinically in human anesthesia in 1956. Halothane decomposes when exposed to ultraviolet light and for this reason has thymol added as an antioxidant. Halothane sensitizes the heart to the catecholamines; this may result in cardiac dysrhythmias. Similar to isoflurane and sevoflurane, halothane has a high vapor pressure and must be used in precision vaporizers. "Halothane hepatitis" has been reported in humans but is a very rare occurrence. This agent is metabolized at the rate of 25%, a considerably higher rate than that of the previous two agents.
4. **Methoxyflurane (Metofane).** Methoxyflurane has been used since 1959. It is a methyl-ethyl-ether that is highly soluble in blood and other tissues. It consequently has a very slow induction and

recovery time. Methoxyflurane is the most potent (MAC = 0.23% to 0.27%) of the agents considered in this section. It has a relatively low vapor pressure, making 3% the maximum level that can be vaporized. Also, because of this low vapor pressure, it can be used in nonprecision, in-circuit vaporizers or precision, out-of-circuit vaporizers. Methoxyflurane undergoes the greatest biotransformation (50%) of any of the inhalants. It has been associated with renal toxicity in human patients.

5. **Nitrous oxide.** Nitrous oxide is a colorless inorganic gas. It was discovered to have anesthetic properties in the late 1700s. Nitrous oxide may be used as an adjunct to more potent agents during mask induction to speed the induction of anesthesia. General anesthesia cannot be produced with nitrous oxide alone. It is compressed to form a liquid and is supplied in blue cylinders. It has the lowest solubility coefficient of any of the inhalants, which means that it enters and exits the blood and tissue rapidly. Because nitrous oxide is 30 times more soluble than nitrogen, it displaces nitrogen from the alveoli, blood, and gas-filled cavities of the body. This means that it will diffuse into and potentially cause distention of the intestines and other gas-filled areas (e.g., the pneumothorax). Nitrous oxide is delivered through a flowmeter and must always be given with oxygen to prevent hypoxia. Oxygen should always be administered for several minutes after the nitrous oxide is turned off to prevent diffusion hypoxia. (The rapid exit of nitrous oxide from the blood will dilute the oxygen in the alveoli.)



Miscellaneous Central Nervous System Drugs

Propofol

Propofol is a short-acting hypnotic that is unrelated to other general anesthetic agents. Its mechanism of action is not well understood. Chemically, it is an alkylphenol derivative. The product that is commercially available is an emulsion that contains soybean oil, glycerol, and egg lecithin. Because of its

white color, some clinicians have called this product “milk of amnesia.” Propofol produces a rapid and smooth anesthetic induction in dogs when given slowly intravenously. It produces sedation, restraint, or unconsciousness, depending on the dose. A single bolus lasts 2 to 5 minutes, making it particularly useful when rapid recovery is important.

Clinical Uses

Propofol is useful for anesthetic induction before administration of an inhalant anesthetic, for outpatient procedures, as a substitute for barbiturates in sight hounds, and for patients with preexisting cardiac arrhythmia. It is also useful as an anesthetic agent for dogs undergoing a cesarean section since it does not cross the placental barrier.

Dosage Forms

1. Rapinovet
2. PropoFlo
3. Diprivan (human label)

Adverse Side Effects

Apnea may occur if propofol is given too rapidly intravenously. Occasional seizure-like signs may be seen. Prolonged recovery and/or Heinz body production may be seen in cats with repeated use.

Technician's Notes

Propofol is an expensive agent that contains no preservatives. Opened bottles should be stored under refrigeration.

Glyceryl Guaiacolate or Guaifenesin (Guailaxin, Gecolate)

Guaifenesin is a skeletal muscle relaxant that exerts its effects on the connecting neurons of the spinal cord and brain stem (Plumb, 2005). It is used primarily in equine medicine to induce general anesthesia or to extend the anesthetic activity of other injectable field anesthetics (i.e., ketamine and xylazine). It may be used as a 5% or 10% solution in 5% dextrose. Some clinicians add an ultrashort-acting barbiturate to the solution before administering it

intravenously. Relatively large amounts are required to induce general anesthesia, and small increments are given to maintain or extend the anesthetic effects of other agents.

Clinical Uses

These include induction or prolongation of general anesthesia in large animals and occasional use as an expectorant.

Dosage Forms

1. Guailaxin
2. Gecolate

Adverse Side Effects

Adverse side effects are limited. Hemolysis has been reported when greater than 5% solutions are used.

Technician's Notes

1. Guaifenesin is packaged as a soluble powder. It may be difficult to dissolve when the diluent is added. Warming 5% dextrose before mixing may aid solution preparation. It should be mixed only immediately before use because a precipitate forms if the solution is allowed to stand for several hours.
2. When increments of guaifenesin are administered to maintain or extend anesthesia, one should communicate thoroughly with the veterinarian to understand the quantity of this drug that should be administered.

Chloral Hydrate/Magnesium Sulfate

This combination has been used as an intravenous agent to produce anesthesia in large animals. Because of the potential for severe irritation of tissue if administered outside of the vein, and because of the advent of more efficacious agents, this combination is seldom used.



Central Nervous System Stimulants

The primary medical use of the CNS stimulants is for treatment of respiratory depression or arrest. Many of the other uses of CNS stimulants are

illegal or unethical (e.g., to enhance athletic performance).

Doxapram

Doxapram activates the respiratory system by stimulating respiratory centers in the medulla. It is labeled for use in dogs, cats, and horses. Its main indications are to stimulate respirations during or after general anesthesia; it is used in newborns and in cases of cardiopulmonary arrest. It is labeled for intravenous use, but it may be administered under the tongue (1 to 2 drops) or into the umbilical vein of the newborn.

Clinical Uses

These include use to stimulate respiration in newborns and use during or after anesthesia.

Dosage Forms

1. Dopram-V
2. Dopram. Approved for use in humans.

Adverse Side Effects

Adverse side effects are rare and usually are associated with overdose. Hypertension, seizures, and hyperventilation may occur.

Technician's Notes

One to two drops of doxapram may be placed under the tongue or injected into the umbilical vein of the newborn to stimulate respirations.

Pentylentetrazol (Metrazol)

Pentylentetrazol is a generalized stimulant of the CNS that has been used to stimulate respirations and to hasten recovery from anesthesia. It has limited use in veterinary medicine.

Caffeine

Caffeine is a general CNS stimulant that promotes wakefulness.

Amphetamines

Amphetamines, which are potent stimulants of the cerebral cortex, are similar chemically to epinephrine. They have no legitimate medical indications in veterinary medicine.



Neuromuscular Blocking Drugs

Neuromuscular blocking drugs, sometimes called muscle relaxants, interfere with neuromuscular transmission of impulses and are used as an adjunct to general anesthesia. These drugs provide no analgesia or sedation. However, they do stop ventilation, and this makes ventilation and constant patient monitoring necessary (Muir and Hubbell, 2007).

Neuromuscular blocking drugs are classified as depolarizing agents or nondepolarizing agents. Depolarizing agents act in a way that is similar to that of acetylcholine at the neuromuscular synapse, but the effects last longer, leading to muscle paralysis (Phase I block). These drugs are not broken down by acetylcholinesterase and have no antagonist. Nondepolarizing agents prevent (competitive inhibition) acetylcholine from binding to receptor sites (Phase II block). These drugs are not degraded by cholinesterase, but they can be antagonized by edrophonium or neostigmine.

Clinical Uses

Neuromuscular blocking agents are used as an adjunct to general anesthesia (e.g., ophthalmic/orthopedic) and to facilitate endotracheal intubation.

Dosage Forms

Depolarizing

1. Succinylcholine chloride (Succostrin, Anectine)
2. Decamethonium (Syncurine)

Nondepolarizing

1. d-Tubocurarine chloride (Curare)
2. Gallamine (Flaxedil)
3. Pancuronium bromide (Pavulon)
4. Vecuronium bromide (Norcuron)
5. Atracurium (Tracrium)

BEHAVIORAL PHARMACOTHERAPY

The use of drugs to treat behavioral problems in animals is a relatively new but rapidly growing area of veterinary medicine. Behavior problems—such as separation anxiety, fears and phobias, unruliness, hyperactivity, compulsive disorders, cognitive dysfunction in older dogs, and inappropriate elimination in cats—are being diagnosed in increasing numbers. Many animals with behavioral disorders are taken in desperation to animal shelters, but a growing number of clients are willing to attempt to correct these conditions with environmental management, behavior modification, and/or pharmacotherapy.

Informed consent should be obtained from the client before these drugs are used (Shull, 1998) because many of the drugs used in behavioral pharmacotherapy are human psychiatric drugs that have not been approved for use in animals. The technician or veterinarian should explain to the animal owner the extralabel status of the drug, its possible side effects or precautions, and the medical effects to be expected in the pet. Owners should also be aware that pharmacotherapy may not be a cure-all for problems of behavior, and that these problems may return after therapy is discontinued.

All drugs used in psychotherapy are thought to produce their effects through alteration of neurotransmitter activity in the brain (Simpson and Simpson, 1996a, 1996b). The five neurotransmitters of clinical importance in behavioral pharmacotherapy are acetylcholine, dopamine, norepinephrine, serotonin, and GABA.

Dopamine, norepinephrine, and serotonin are called *monoamine neurotransmitters* because they have similar chemical structures. Monoamines are found in large quantities in areas of the brain often associated with expression and control of emotions. The primary method by which monoamines are inactivated is through their reuptake from the synapse back into synaptic vesicles in nerve endings (see Figure 4-4). Drugs that block or inhibit their reuptake increase their activity. Acetylcholine is the most widely distributed neurotransmitter in the

body. It is associated with a variety of behavioral effects and is inactivated by cholinesterase at the synapse. Some of the most common side effects of drugs used in behavioral psychotherapy are related to their anticholinergic effects, such as dry mouth, increased heart rate, urine retention, and constipation. GABA is considered to be an inhibitory neurotransmitter and is widely distributed in the brain.

Pharmacotherapeutic Agents

Drugs most commonly used in treating behavioral problems in veterinary medicine include antianxiety medications, antidepressants, and miscellaneous agents—such as synthetic progestins. All drugs listed in the following section carry a human label, except those that are otherwise indicated.

Antianxiety Medications

Benzodiazepines

The benzodiazepines most commonly used in veterinary medicine include diazepam, alprazolam, and lorazepam. All the benzodiazepines are similar in structure and mechanism of action. They are thought to bind with and promote GABA activity in the cerebral cortex and in subcortical areas, such as the limbic system.

Clinical Uses

Behavioral uses of benzodiazepines include the treatment of fears and phobias, separation anxiety, aggression, anxiety-induced stereotypes, urine marking in cats, and appetite stimulation.

Dosage Forms

1. Diazepam (Valium)
2. Alprazolam (Xanax)
3. Lorazepam (Ativan)

Adverse Side Effects

These may include lethargy, ataxia, polyuria and polydipsia (PUPD), hyperexcitability, and hepatic necrosis (cats).

Azapirones

Buspirone is the azapirone agent that is used in behavioral pharmacotherapy. In contrast to the benzodiazepines, it possesses no muscle relaxant, anticonvulsant, or sedative effects. Its antianxiety effect is thought to be caused by blocking serotonin receptors.

Clinical Uses

Veterinary uses include the control of urine spraying/ marking and the control of fearfulness and anxiety.

Dosage Form

Buspirone (BuSpar)

Adverse Side Effects

Few serious side effects appear to exist.



Antidepressants

Tricyclics

Tricyclics used commonly in veterinary medicine include amitriptyline, imipramine, and clomipramine. These drugs are thought to exert their effects by preventing reuptake of norepinephrine and serotonin. Clomipramine is apparently a selective inhibitor of serotonin reuptake. The tricyclic group is often used on a long-term basis and may take several weeks of use to become effective. Some of the tricyclics are available in the generic form and are relatively inexpensive to use.

Clinical Uses

Uses include the treatment of separation anxiety, obsessive disorders (e.g., lick granuloma, tail chasing), fearful aggression, hyperactivity, hypervocalization, and urine marking.

Dosage Forms

1. Amitriptyline (Elavil, generic forms)
2. Imipramine (Tofranil)
3. Clomipramine (Anafranil, Clomicalm [veterinary label])

Adverse Side Effects

Side effects may include sedation, tachycardia, heart block, mydriasis, dry mouth, reduced tear production, urine retention, and constipation.

Serotonin Reuptake Inhibitors

Serotonin reuptake inhibitors include fluoxetine, sertraline, paroxetine, and fluvoxamine. As their name indicates, these drugs increase the amount of serotonin in the synapse by inhibiting its reuptake back into the nerve terminal. Serotonin reuptake inhibitors have fewer potential side effects than the tricyclics but are usually more expensive.

Clinical Uses

Used for a variety of behavioral syndromes, including obsessive disorders, phobias, aggression, and separation anxiety.

Dosage Forms

1. Fluoxetine (Prozac, human label) (Reconcile, labeled for use in dogs)
2. Sertraline (Zoloft)
3. Paroxetine (Paxil)
4. Fluvoxamine (Luvox)

Adverse Side Effects

Side effects are relatively few but include anorexia, nausea, lethargy, anxiety, and diarrhea.

Monoamine Oxidase-B Inhibitors

The neurotransmitter dopamine is broken down by the enzyme monoamine oxidase-B (MAO-B). Substances such as selegiline (a MAO-B inhibitor) block or inhibit MAO-B and allow dopamine levels to increase. Decreased dopamine levels may be associated with certain types of dementia that are seen in older dogs (canine cognitive dysfunction). Canine cognitive dysfunction is characterized by disorientation, decreased activity level, abnormal sleep-wake cycles, loss of house training, decreased or altered responsiveness, and decreased or altered greeting behavior.

Clinical Uses

Uses include treatment of old-dog dementia and treatment of canine Cushing's disease.

Dosage Form

Selegiline (Eldepryl, Atapryl, Anipryl [veterinary label])

Adverse Side Effects

Side effects include vomiting, diarrhea, anorexia, restlessness, lethargy, salivation, shaking, and deafness.

Synthetic Progestins

Synthetic progestins are sometimes used to treat behavioral problems through mechanisms associated with changing hormonal levels (reduced gonadotropins) or through some direct effect on the cerebral cortex.

Clinical Uses

Uses include the treatment of urine spraying/markings, intermale aggression, and dominance aggression.

Dosage Forms

1. Megestrol acetate (Megace, Ovaban [veterinary label])
2. Medroxyprogesterone (Depo-Provera)

Adverse Side Effects

Transient diabetes mellitus (cats), PUPD, increased weight gain, personality changes, endometritis, endometrial hyperplasia, mammary hypertrophy, mammary tumor, adrenal atrophy, and lactation are side effects.

**Euthanasia Agents**

Euthanasia agents should have several properties that make them effective medically and aesthetically for this emotion-laden procedure. These drugs should rapidly produce unconsciousness without struggling, vocalizations, or excessive involuntary movement. Death should follow quickly owing to the cessation of all vital functions, such as respiratory and cardiac functions.

The main component of most of the euthanasia agents is pentobarbital. Pentobarbital may also be combined with other agents, such as propylene glycol and alcohol. Pentobarbital alone is a Class II controlled substance, and pentobarbital combinations usually are Class III controlled substances.

Clinical Uses

These agents are used to produce a rapid, humane death.

Dosage Forms

1. Pentobarbital sodium (Sleepaway, pentobarbital generic). These products are Class II controlled substances for intravenous use.
2. Pentobarbital sodium (Beuthanasia-D). This drug is a Class III controlled substance for intravenous use. This product is different from the pentobarbital sodium described previously in that it contains rhodamine B, a bluish-red dye that helps to distinguish it from other parenteral pentobarbital solutions, as well as phenytoin and preservatives.
3. Euthanasia-6. This product contains pentobarbital only.
4. T-61. T-61 is a nonnarcotic, nonbarbiturate agent that contains a general anesthetic, a local anesthetic, and a muscle paralyzer. It is not a controlled substance. It must be administered according to manufacturer instructions (first two thirds slowly) to avoid apparent anxiety or pain.
5. Fatal-Plus. Contains pentobarbital sodium and is available as a sterile powder for dilution or as a prepared solution. The solution contains a stabilizer, a solvent, and a preservative.
6. Euthasol-C III.

Adverse Side Effects

These may include muscle twitching; death may be delayed if the drug is injected outside the vein.

REFERENCES

- Boothe DM: Control of pain in small animals: opioid agonists and antagonists and other locally and centrally acting analgesics. In Boothe DM, editor: *Small animal clinical pharmacology and therapeutics*, Philadelphia, 2001, WB Saunders.
- DeLahunta A: Diencephalon. In DeLahunta A, editor: *Veterinary neuroanatomy and clinical neurology*, Philadelphia, 1983, WB Saunders.
- Ganong WF: *Review of medical physiology*, ed 21, New York, 2003, McGraw-Hill.
- Muir WW, Hubbell JA: *Handbook of veterinary anesthesia*, ed 4, St. Louis, 2007, Mosby Elsevier.
- Paddleford RR: *Manual of small animal anesthesia*, Philadelphia, 1999, WB Saunders.
- Plumb DC: *Veterinary drug handbook*, ed 5, Ames, 2005, Iowa State University Press.
- Shull EA: *Psychopharmacology in veterinary behavioral medicine*, Annual Conference for Veterinarians and Technicians, Knoxville, Tenn, 1998, UT-CVM.

- Simpson BS, Simpson DM: Behavioral pharmacotherapy part I: antipsychotics and antidepressants, *Compend Contin Educ Pract Vet* 18(10):1067-1081, 1996.
- Simpson BS, Simpson DM: Behavioral pharmacotherapy part II: anxiolytics and mood stabilizers, *Compend Contin Educ Proc Vet* 18(11):1203-1210, 1996.
- Snyder S: Mood modifiers. In Snyder S, editor: *Drugs and the brain*, New York, 1986, Scientific American Library.
- Upton DW: Central nervous system. In Upton DW, editor: *Handbook of clinical veterinary pharmacology*, ed 3, Manhattan, Kan, 1988, Dan Upton Enterprises.
- Williams BR, Baer C: Drugs affecting the autonomic nervous system. In Williams BR, Baer C, editors: *Essentials of clinical pharmacology in nursing*, Springhouse, Pa, 1990, Springhouse Corp.



REVIEW QUESTIONS

- Define the difference between an agonist and an opioid antagonist. _____
- Define neurotransmitter. _____
- The area of the brain that serves to relay information from the spinal cord and brain stem to the interpretation center in the cerebrum is the
 - Cerebellum
 - Thalamus
 - Hypothalamus
 - Hippocampus
- Most CNS drugs act by _____ or _____ the effects of neurotransmitters.
- What are the primary neurotransmitters for adrenergic receptors? _____
- List the four primary ways in which drugs affect the ANS. _____
- List five indications for the use of cholinergic agents. _____
- Atropine, scopolamine, glycopyrrolate, and aminopentamide are examples of what specific drug class? _____
- What category of drug is used to treat cardiac arrest and anaphylactic shock? _____
- Propranolol is an example of what category of drug?
 - Alpha agonist
 - Beta agonist
 - Alpha blocker
 - Beta blocker
- What are some adverse side effects of xylazine, and what drug may be used to antagonize its effects? _____
- Why would you be concerned about using a thiobarbiturate to induce anesthesia in a very thin dog? _____
- What are some of the characteristics of a cat anesthetized with ketamine? _____
- List some of the signs of a narcotic overdose. _____
- List two narcotic antagonists. _____
- Why should glyceryl guaiacolate not be mixed until just before use? _____
- You are assisting in the delivery of a litter of puppies and you deliver one that is not breathing adequately. What drug would the veterinarian instruct to give, and by what route? _____
- Why are euthanasia solutions that contain only pentobarbital classified as Class II controlled substances, whereas those that contain pentobarbital and other substances are classified as Class III controlled substances? _____
- All psychotherapy drugs are thought to produce their effects by altering _____ activity in the brain.
- Dissociative agents, such as ketamine and tiletamine, may cause _____ at the injection site.
- A hypnotic (anesthetic) known for its very short duration and its white color is _____.
- An inhibitory neurotransmitter that is widely distributed in the brain is _____.
- A benzodiazepine that is used as an antianxiety medication and as an appetite stimulant in cats is _____.
- An example of a tricyclic antidepressant used in veterinary medicine for separation anxiety in dogs is _____.

25. _____ is used to treat old-dog dementia.
26. The nervous system carries out activity very rapidly by sending electric-like messages over a network of nerve fibers. The _____ system works much more slowly by sending chemical messengers through the bloodstream to target structures.
- hematopoietic
 - endocrine
 - exocrine
 - cytokine
27. The _____ nervous system is under voluntary control.
- somatic
 - autonomic
28. The _____ is the fundamental unit of the nervous system.
- hepatocyte
 - nephron
 - beta cell
 - neuron
29. Axons carry electric-like messages _____ (from) the nerve cell, and dendrites carry electric-like messages _____ (from) the nerve cell.
- away; toward
 - toward; away
30. Neurotransmitters cannot be mimicked or blocked by the use of appropriate drugs, and that is why patients with nervous system disorders do not have a very good prognosis.
- True
 - False
31. The ANS is that portion of the nervous system that controls _____ body activities.
- conscious
 - unconscious
32. The neurotransmitter for cholinergic sites is _____.
- atropine
 - scopolamine
 - pralidoxime
 - acetylcholine
33. Epinephrine (adrenaline) is responsible for all of the following except _____.
- can cause an increase in metabolic rate
 - can cause an increase in heart rate and cardiac output
 - communication with stem cells in the bone marrow
 - can constrict blood vessels in the skin
34. Xylazine is antagonized by _____.
- hemp
 - detomidine HCl
 - Valium
 - yohimbine
35. All the following are benzodiazepines except _____.
- yohimbine
 - diazepam
 - alprazolam
 - lorazepam

Disease

Categories of Respiratory Drugs

EXPECTORANTS

Guaifenesin (Glyceryl Guaiacolate)

MUCOLYTICS: ACETYLCYSTEINE

ANTITUSSIVES: CENTRALLY

ACTING AGENTS

Butorphanol Tartrate

Hydrocodone Bitartrate

Codeine

Dextromethorphan

Temaril-P

BRONCHODILATORS

Cholinergic Blockers

Antihistamines

Beta-2-Adrenergic Agonists

Methylxanthines

DECONGESTANTS

ANTIHISTAMINES

CORTICOSTEROIDS

**MISCELLANEOUS RESPIRATORY
DRUGS**

Respiratory Stimulants

Doxapram Hydrochloride

Naloxone

Yobine

CHAPTER 5

Drugs Used in Respiratory System Disorders

LEARNING OBJECTIVES

After studying this chapter, you should be able to:

1. Describe the basic anatomy and physiology of the respiratory system.
2. List the protective mechanisms of the respiratory system.
3. Describe the fundamental principles of treatment of the respiratory system.
4. List the differences between the actions of expectorants, antitussives, and mucolytics.
5. Describe the action of bronchodilators.
6. Describe the use of antihistamines and decongestants in respiratory disease.
7. List potential uses for respiratory stimulants.
8. List the advantages and disadvantages of inhalant therapy.



KEY TERMS

AEROSOLIZATION The conversion of a liquid into a fine mist or colloidal suspension in air.

ANTITUSSIVE A drug that inhibits or suppresses the cough reflex.

BRONCHOCONSTRICTION Narrowing of the bronchi and bronchioles, which results in increased airway resistance and decreased airflow.

BRONCHODILATION Widening lumen of bronchi and bronchioles, which results from relaxation of smooth muscle in the walls of the bronchi and bronchioles. Airway resistance is decreased, and airflow is increased.

DECONGESTANT A substance that reduces the swelling of mucous membranes.

EXPECTORANT A drug that enhances the expulsion of secretions from the respiratory tract.

HUMIDIFICATION Addition of moisture to the air.

IGA Class of antibody produced on mucous membrane surfaces, such as those of the respiratory tract.

INSPISSATED Thickened or dried out.

MUCOLYTIC Having the ability to break down mucus.

NEBULIZATION The process of converting liquid medications into a spray that can be carried into the respiratory system by inhaled air.

NONPRODUCTIVE COUGH A cough that does not result in coughing up of mucus, secretions, or debris (a dry cough).

PRODUCTIVE COUGH A cough that results in coughing up of mucus, secretions, or debris.

REVERSE SNEEZE Aspiration reflex—short periods of noisy inspiratory effort in dogs.

SURFACTANT A mixture of phospholipids secreted by type II alveolar cells that reduce surface tension in pulmonary fluids.

VISCID Sticky.

INTRODUCTION

Veterinary references list a wide variety of diseases of the respiratory system. A partial listing of general origins includes the following:

1. Allergy
2. Aspiration
3. Bacteria
4. Congenital defects
5. Fungi
6. Immunologic factors
7. Neoplasia
8. Neurologic conditions
9. Parasites
10. Trauma
11. Viruses

The respiratory system has a series of defense mechanisms by which it protects itself from disease. These natural defenses can be damaged by management practices such as those that cause a buildup of ammonia in enclosed, poorly ventilated housing. They can also be suppressed by inappropriate

therapy, such as the use of cough suppressants for a productive cough. Because it is essential that these defense mechanisms function optimally for prompt recovery from respiratory disease, it is very important that technicians have a basic understanding of respiratory anatomy and physiology, respiratory defense mechanisms, and respiratory therapeutics.

RESPIRATORY ANATOMY AND PHYSIOLOGY

The respiratory system consists of the lungs and the passageways that carry air into and out of the lungs (Figure 5-1). These passageways include the nostrils, nasal cavity, pharynx, larynx, trachea, bronchi, and bronchioles.

The passageways that lead to the lungs are referred to as the *upper respiratory system*. The upper respiratory system begins with the nostrils, which open into the nasal cavity. The nasal cavity contains turbinates that are covered with mucous membranes. These turbinates increase the surface

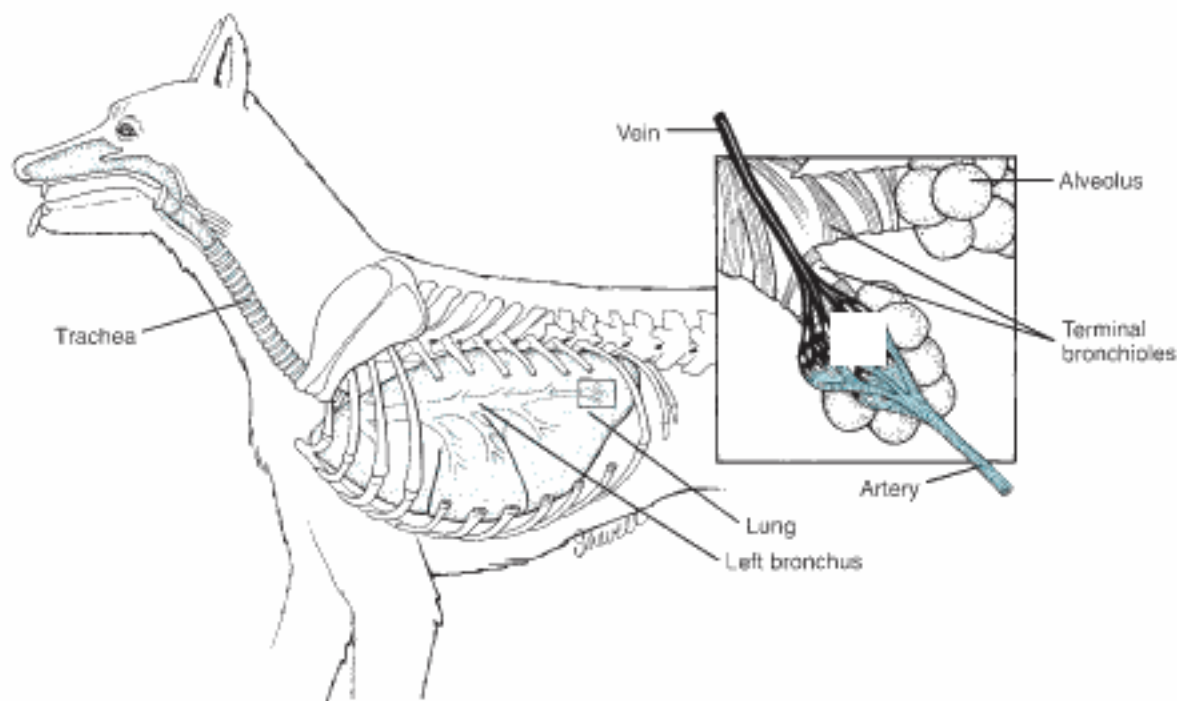

FIGURE 5-1
Anatomy of the respiratory system.

area of the nasal cavity to allow **humidification** and warming of inspired air. Air that passes out of the nasal cavity moves in turn through the pharynx and the larynx into the trachea. The trachea bifurcates into right and left bronchi, which lead to right and left lungs, respectively. Each bronchus then divides into a series of passageways of decreasing size, called *bronchioles*. Smooth muscle fibers are found in the walls of the bronchioles. Contraction of smooth muscle fibers decreases the diameter of the bronchioles, and relaxation of fibers allows the diameter to return to normal size (Figure 5-2).

The upper respiratory tract is lined with ciliated, pseudostratified columnar epithelial cells. Interspersed between the epithelial cells are goblet cells capable of secreting mucus. Mucus is secreted onto the surface of the epithelial cells and is moved toward the pharynx by movement of the cilia (mucociliary apparatus).

Sympathetic stimulation results in decreased production of mucus by the goblet cells and relaxation of smooth muscle in the walls of the bronchioles, leading to **bronchodilation**.



FIGURE 5-2
Smooth muscle fibers in the walls of the bronchioles relax to allow bronchodilation and contract to cause bronchoconstriction.

Parasympathetic stimulation causes increased secretion of mucus and constriction of smooth muscle (**bronchoconstriction**) (Figure 5-3).

The bronchioles terminate in small, sac-like structures called *alveoli*. The alveoli are arranged in grape-like clusters and are lined with a chemical

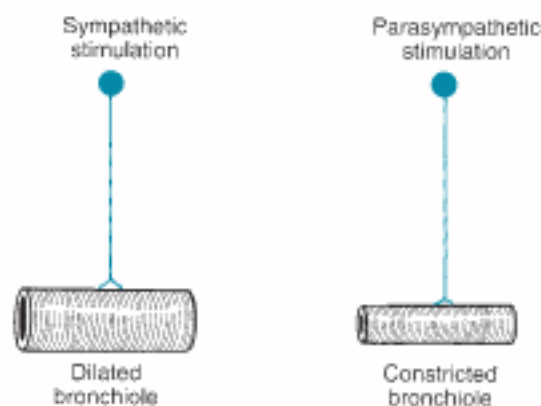

FIGURE 5-3

Effects of autonomic stimulation on bronchioles.

substance called **surfactant**, which reduces the surface tension of the alveoli and helps to keep them from collapsing. The alveoli are surrounded by capillaries; this makes it possible for the blood to unload its carbon dioxide into the alveoli and to pick up oxygen from the alveoli.

Functions that the respiratory system serves include the following:

1. Oxygen-carbon dioxide exchange
2. Regulation of acid-base balance
3. Body temperature regulation
4. Voice production

The work of the respiratory system can be divided into the following four parts:

1. Ventilation—movement of air into and out of the lungs. The inspiratory portion of ventilation is usually an active process, whereas expiration is usually a passive process. Forced inspiration may be associated with upper airway obstruction, and active expiration may be related to intrathoracic airway obstruction (Tilley and Smith, 2000).
2. Distribution—distributing of inspired gases throughout the lungs.
3. Diffusion—movement of gases across the alveolar membrane.
4. Perfusion—supply of blood to the alveoli. The ratio of perfusion to ventilation of the alveoli is normally close to 1:1.

RESPIRATORY DEFENSE MECHANISMS

The respiratory system has several effective methods of defense against disease processes, including the following:

1. Nasal cavity: The turbinates of the nasal cavity provide a large surface area for warming and humidifying inspired air. Hair in the nasal passages also may help to filter out larger particulate matter.
2. Protective reflexes: The cough, the sneeze, and perhaps the **reverse sneeze** respond to stimulation of receptors on the surfaces of air passages to forcefully expel foreign material. Laryngospasm and bronchospasm also help to prevent introduction of materials into the lung tissue.
3. Mucociliary clearance: The layer of mucus secreted onto the surface of the epithelial lining of the respiratory tract helps to trap foreign debris that enters the respiratory passages. Wave-like actions of the cilia then move the debris up the passages ("escalator" action) to the pharynx, where it can be swallowed or expelled. Macrophages and immunoglobulin (**IgA**) also contribute to the defensive qualities of the mucociliary apparatus by immobilizing or phagocytizing foreign material.

PRINCIPLES OF RESPIRATORY THERAPEUTICS

It is important that a specific diagnosis be made through radiology, cytology, or appropriate culture before treatment of respiratory disease is initiated because the correct treatment for one type of disease may be contraindicated for another. Once the diagnosis has been made, treatment for respiratory disease is divided into the following three general goals (McKiernan, 1988):

1. Control of secretions: Secretions may be reduced by decreasing their production or increasing their elimination. Removing the cause of the secretions by means of antibiotic, antifungal, antiparasitic, or other appropriate therapy is

of vital concern. Methods are also aimed at making the secretions less **viscid** through the use of expectorants or through **nebulization** of **mucolytics** (aerosol therapy).

2. Control of reflexes: Coughing may be suppressed through the use of antitussives or bronchodilators if the cough is **nonproductive**. Sneezing is controlled by removal of the offending agent or through the use of vasoconstrictors. Bronchospasms may be controlled with bronchodilators and corticosteroids.
3. Maintaining normal airflow to the alveoli: Airflow to the alveoli may be maintained by reversing bronchoconstriction, by removing edema or mucus from alveoli and air passages, and by providing oxygen therapy. Intermittent positive-pressure ventilation and other ventilation strategies are often used in humans and may have application in selected animal cases.

INHALATION THERAPY FOR RESPIRATORY DISEASE

Although drugs used to treat respiratory disease are often administered by the oral or parenteral route, inhalant therapy may also be useful. **Aerosolization** (nebulization) of drugs allows their delivery at high concentrations directly into the airways while minimizing their blood levels—a feature that may reduce the chance of toxic reaction. The efficacy of an inhaled drug depends on the dose and on how well it is distributed in the lungs. Distribution of an aerosol depends on several factors such as the size, shape, and pattern of the airways and the breathing pattern of the animal. The size of the inhaled particle plays a significant role in its distribution. The optimum particle size for entry into the peripheral airways is 1 to 5 microns (Lavoie, 2001). Particles smaller than 0.5 micron are likely to be exhaled, and those larger than 5 microns could be deposited in the upper airways. Airway pathology (e.g., excessive mucus or exudate) can interfere with distribution of the drug, causing some clinicians to assert that inhalant therapy should always be accompanied by systemic treatment (Boothe, 2001). Concurrent use of a bronchodilator and/or a mucolytic may be a helpful

adjunct to inhalant therapy. Relatively inexpensive infant units for inhalation therapy are available for use in small animals (Opti-Chamber, Aero-Chamber) and horses (Aero-Mask).

CATEGORIES OF RESPIRATORY DRUGS



Expectorants

Expectorants are drugs that liquefy and dilute viscid secretions of the respiratory tract, thereby helping in evacuation of those secretions. Most expectorants are administered orally, although a few are given by inhalation or parenterally. Expectorants are thought to act directly on the mucus-secreting glands or by reducing the adhesiveness of mucus. Expectorants are indicated when a **productive cough** is present and are often combined with other substances, such as ammonium chloride, antihistamines, or dextromethorphan.

Guaiifenesin (Glyceryl Guaiacolate)

Guaiifenesin is found in a few veterinary label products and in many human label over-the-counter cough preparations. Guaiifenesin is more commonly used in equine practice to induce or maintain general anesthesia.

Clinical Uses

These include relief of cough symptoms related to upper respiratory tract conditions.

Dosage Forms

These are primarily liquid (syrup) and tablet preparations.

1. Antitussive syrup
2. Cough syrup
3. Cough tablets
4. Robitussin-AC
5. Triaminic Expectorant

Adverse Side Effects

Adverse side effects of guaiifenesin are rare, although mild drowsiness or nausea may occur.



Mucolytics: Acetylcysteine

Mucolytics, such as acetylcysteine, decrease the viscosity of respiratory secretions by altering the chemical composition of the mucus through the breakdown of chemical (disulfide) bonds. Acetylcysteine is the only mucolytic of clinical significance in veterinary medicine. It is administered by nebulization for pulmonary uses. This drug is also administered orally as an antidote for acetaminophen toxicity.

Clinical Uses

Acetylcysteine is used to break down thick or inspissated respiratory mucus and to treat acetaminophen toxicity.

Dosage Forms

Dosage forms with a human label include a 10% solution and a 20% solution in 4-ml, 10-ml, and 30-ml vials. A veterinary labeled product for horses is available in powder form for oral administration.

1. Mucomyst
2. Mucosil-10
3. Mucosil-20
4. Dembrexine (Sputlosin)—veterinary label

Adverse Side Effects

Adverse side effects are few when acetylcysteine is nebulized. However, the drug may cause nausea or vomiting when administered orally.



Antitussives: Centrally Acting Agents

Antitussives are drugs that inhibit or suppress coughing. Antitussives are classified as centrally acting or peripherally acting (Figure 5-4). Centrally acting agents suppress cough by depressing the cough center in the brain, whereas peripherally acting agents depress cough receptors in the airways. Peripherally acting antitussives are seldom used in veterinary medicine because they are usually prepared as cough drops or lozenges, which are not practical to administer to animal patients.

Butorphanol Tartrate

Butorphanol is a synthetic opiate, partial agonist with significant antitussive activity. It is a Class IV controlled substance. It is also used as a preanesthetic and as an analgesic.

Clinical Uses

Butorphanol tartrate is used for the relief of chronic nonproductive cough in dogs and for analgesia and preanesthesia in dogs and cats.

Dosage Forms

Dosage forms include injectable and tablet forms.

1. Butorphanol (Torbutrol) injection (0.5 mg/ml, 10-ml vial); approved for use in dogs
2. Butorphanol (Torbugesic) injection (10 mg/ml, 50 ml); approved for use in horses
3. Butorphanol (Torbutrol) tablets (1 mg, 5 mg, and 10 mg; 100/bottle)

Adverse Side Effects

Adverse side effects may include sedation and ataxia.

Hydrocodone Bitartrate

Hydrocodone is a schedule III opiate agonist used for the treatment of nonproductive cough in dogs.

Clinical Uses

Hydrocodone is used primarily as an antitussive for harsh, nonproductive cough.

Dosage Forms

Dosage forms include several human label combination products in syrup and tablet form.

1. Hycodan (hydrocodone and homatropine) tablets
2. Tussigon (hydrocodone and homatropine) tablets
3. Hycodan (hydrocodone and homatropine) syrup
4. Hydropan (hydrocodone and homatropine) syrup
5. Codan syrup (hydrocodone and homatropine)
6. Generic hydrocodone syrup

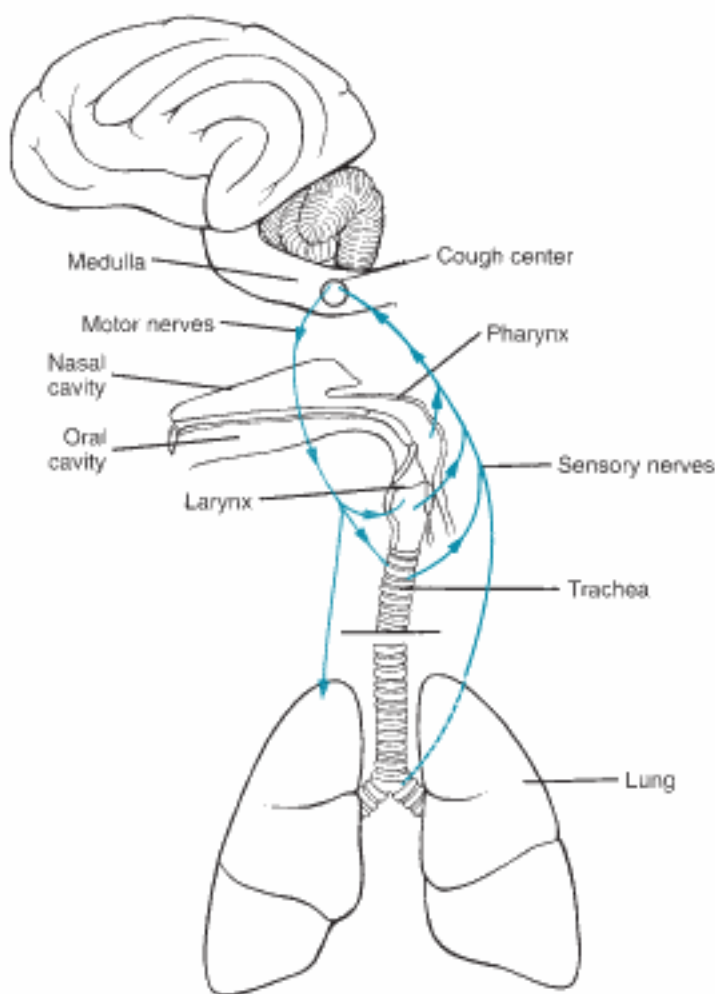

FIGURE 5-4
Antitussives act peripherally on sensory nerve endings or centrally on cough centers.

Adverse Side Effects

These include potential sedation, constipation, and gastrointestinal upset.

Codeine

Codeine is a schedule V opiate agonist that is used as an antitussive in human label combination products.

Clinical Uses

Clinical uses of codeine are similar to those of hydrocodone.

Dosage Forms

These include combination human label products primarily in syrup form.

1. Codeine phosphate oral tablets, 30 mg and 60 mg
2. Codeine sulfate oral tablets, 15 mg, 30 mg, and 60 mg
3. Codeine phosphate with aspirin (Empirin with codeine)

Adverse Side Effects

Adverse side effects include sedation and constipation.

Technician's Notes

1. Codeine-only products are Class II (C-II).
2. Codeine with aspirin or acetaminophen is C-III.
3. Codeine syrups are C-III or C-V (by state).

Dextromethorphan

Dextromethorphan is a nonnarcotic antitussive that is chemically similar to codeine. It has no analgesic or addictive properties. It acts centrally and elevates the cough threshold. Similar to the two drugs previously mentioned, it is available primarily in human label combination products.

Clinical Uses

Dextromethorphan is used to suppress a nonproductive cough.

Dosage Forms

The primary dosage form is the syrup product.

1. Phenergan with dextromethorphan
2. Dimetapp DM (dextromethorphan, phenylpropanolamine, and brompheniramine)
3. Robitussin DM (dextromethorphan and guaifenesin)

Adverse Side Effects

Adverse side effects are rare when this drug is given in the correct dose but can include drowsiness and gastrointestinal upset.

Technician's Notes

Technicians who administer combination products to cats should take special precautions to ensure that the product does not contain acetaminophen.

Temaril-P

Temaril-P is a combination product that contains a centrally acting antitussive (trimeprazine tartrate) and a corticosteroid (prednisolone).

Clinical Uses

Temaril-P is used as an antitussive and as an antipruritic.

Dosage Forms

Dosage forms include tablets. Temaril-P tablets (5 mg trimeprazine tartrate, 2 mg prednisolone).

Adverse Side Effects

These include sedation, depression, hypotension, and minor central nervous system signs.

Bronchodilators

Contraction of the smooth muscle fibers that surround the bronchioles results in bronchoconstriction and often corresponding dyspnea. Contraction of these smooth muscle fibers can result from the following three basic mechanisms (Bill, 2006) (Figure 5-5):

1. Release of acetylcholine at parasympathetic nerve endings or inhibition of acetylcholinesterase. Increased acetylcholine levels also tend to increase secretions of the respiratory tract, thus reducing airflow and adding to the level of dyspnea.
2. Release of histamine through allergic or inflammatory mechanisms. Histamine combines with H_1 receptors on smooth muscle fibers to cause bronchoconstriction. Histamine also increases the inflammatory response in the airways, further leading to increased levels of secretion and viscosity.
3. Blockade of beta-2-adrenergic receptors by drugs such as propranolol results in bronchoconstriction. Stimulation of beta-2-adrenergic receptors, however, produces bronchodilation.

Drugs that cause bronchodilation are of four basic categories. Those categories include the cholinergic blockers, the antihistamines, the beta-2 adrenergics, and the methylxanthines (Boothe, 2001).

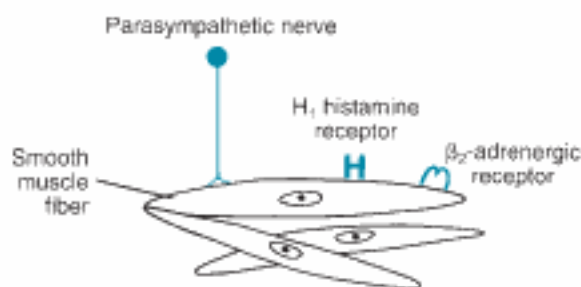

FIGURE 5-5

Bronchoconstriction may result from (1) acetylcholine release at parasympathetic nerve endings, (2) stimulation of H_1 histamine receptors, and (3) blockade of beta-2-adrenergic receptors.

Cholinergic Blockers

Cholinergic blockers produce bronchodilation by combining with acetylcholine receptors on smooth muscle fibers and preventing the bronchoconstrictive effects of acetylcholine. Cholinergic blockers such as atropine, aminopentamide (Centrine), and glycopyrrolate (Robinul-V) have limited use in treating bronchoconstriction, except in cases of organophosphate or carbamate toxicity. Ipratropium bromide, a synthetic anticholinergic, may be of some value in treating equine pulmonary obstructive disease (Hoffman, 2001).

Antihistamines

Antihistamines are discussed later in this chapter.

Beta-2-Adrenergic Agonists

Beta-2-adrenergic agonists combine with appropriate receptors on the smooth muscle fibers and effect relaxation of those fibers. They also stabilize mast cells and reduce the amount of histamine released (Bill, 2006). It is preferred that these drugs have limited beta-1 activity because beta-1 stimulation can produce tachycardia.

Clinical Uses

Beta-2-adrenergic agonists are used as bronchodilators.

Dosage Forms

1. Epinephrine. This drug is a potent bronchodilator that is used only in life-threatening situations (e.g., anaphylactic shock) because it also produces significant tachycardia.
2. Isoproterenol (Isuprel). Also causes beta-1 stimulation and has limited use as a bronchodilator in veterinary medicine.
3. Albuterol (Ventolin, Proventil), clenbuterol (Ventipulmin syrup and clenbuterol HCl oral syrup), terbutaline (Brethine), and metaproterenol (Alupent). These beta-2 agonists have little stimulatory influence on the heart. Clenbuterol is veterinary approved for horses and is not intended for food. None of the other products carry a veterinary label.
4. Salmeterol (Serevent).

Adverse Side Effects

These include tachycardia and hypertension.

Methylxanthines

Methylxanthine derivatives that are used therapeutically include aminophylline and theophylline. These two products are very similar in their chemistry and pharmacologic effects. Both inhibit an enzyme in smooth muscle cells called *phosphodiesterase*. When beta-2 receptors are stimulated, a chemical messenger called *cyclic adenosine monophosphate (cyclic AMP)* that is released in the smooth muscle cell completes the relaxation response to allow dilation. Phosphodiesterase inhibits cyclic AMP in the cell, thereby tending to promote bronchoconstriction. By inhibiting the inhibitor (phosphodiesterase) and allowing cyclic AMP to accumulate, the methylxanthines tend to promote bronchodilation.

Methylxanthines also cause mild stimulation of the heart and respiratory muscles and minor diuresis.

Caffeine and theobromine (found in chocolate) are methylxanthines.

Aminophylline is an ethylenediamine salt of theophylline. It is available in various human label products. One hundred milligrams of aminophylline contains approximately 79 mg of theophylline (Plumb, 2005). Injectable forms are available, as are immediate- and sustained-release oral forms.

Clinical Uses

Methylxanthines are used for bronchodilation in respiratory and cardiac conditions and for mild heart stimulation (positive inotropic effect).

Dosage Forms

1. Theo-Dur
2. Slo-bid
3. Choledyl SA
4. Aminophylline (generic)

Adverse Side Effects

These may include gastrointestinal upset, central nervous system stimulation, tachycardia, ataxia, and arrhythmia.

Technician's Notes

Because theophylline may interact adversely with many drugs, including phenobarbital, cimetidine, erythromycin, thiabendazole, clindamycin, and lincomycin, appropriate precautions should be taken before this drug is administered.

Decongestants

Decongestants are drugs that reduce the congestion of nasal membranes by reducing associated swelling. Decongestants may be administered as a spray or as nose drops or may be given orally as a liquid or as a tablet. These drugs act directly or indirectly (Williams and Baer, 1990) to reduce congestion through vasoconstriction of nasal blood vessels. These products have limited use in veterinary medicine but may be used to treat selected feline upper respiratory tract disease.

Many human label decongestants are available. Those that are given orally and act systemically include ephedrine (Primatene), pseudoephedrine (Sudafed), and phenylpropanolamine (Ornade). Topically applied decongestants include oxymetazoline (Afrin) and phenylephrine (Neo-Synephrine).

Antihistamines

Antihistamines are substances that are used to block the effects of histamine. Histamine is released from mast cells by the allergic response and combines with H_1 receptors on bronchiole smooth muscle to cause bronchoconstriction. Antihistamines may be useful in treating respiratory disease because they prevent mast cell degranulation and block H_1 receptors on smooth muscle. Antihistamines are thought to be more effective when used preventively because they apparently do not replace histamine that has already combined with receptors (Bill, 2006).

Respiratory conditions that may be treated with antihistamines include "heaves" in horses, pneumonia in cattle, feline asthma, and insect bites.

Generic names for antihistamines often are easily recognized because most end in the suffix "-amine" (e.g., pyrilamine, diphenhydramine, chlorpheniramine).

Veterinary label antihistamines for treating respiratory conditions are available in injectable and oral preparations.

Clinical Uses

Antihistamines are used in the treatment of allergic and respiratory conditions. They also may be used for their antiemetic effects.

Dosage Forms

1. Pyrilamine (Histavet-P)
2. Tripelennamine (Re-Covr)
3. Probahist Syrup
4. Antihistamine Injection
5. Diphenhydramine (Benadryl). Human approved
6. Doxylamine (A-H, injection or tablets)
7. Hydroxyzine (Atarax)
8. Terfenadine (Seldane). Human approved
9. Clemastine (Tavist)
10. Cyproheptadine (Periactin). May be used in cats to block bronchoconstriction and also as an appetite stimulant.

Adverse Side Effects

These include sedation and, occasionally, gastrointestinal effects.

Corticosteroids

Corticosteroids are used primarily in the treatment of allergic respiratory conditions. They are considered the most effective drugs in the treatment of equine chronic obstructive pulmonary disease (Lavoie, 2001). Corticosteroids prepared for inhalation therapy have strong antiinflammatory effects locally in the lungs and are rapidly biodegraded when absorbed into the general circulation. Oral corticosteroids (prednisone or prednisolone) are considered the drugs of choice in the treatment of chronic airway inflammation in dogs and cats (Dowling, 2001). Corticosteroid therapy controls the signs of respiratory disease, not the cause; good

short-term effects often ensue with few residual effects that may require long-term use.

Clinical Uses

Corticosteroids are used in the treatment of equine heaves, feline asthma, acute respiratory distress syndrome, and allergic pneumonia.

Dosage Forms

1. Prednisolone sodium succinate (Solu-Delta-Cortef, Delta-Cortef)
2. Prednisolone (Delta Albaplex, Temaril-P, generic forms)
3. Dexamethasone (Dexasone, Dexamethasone Solution, Azium)
4. Beclomethasone dipropionate (Vanceryl) (For inhalation)
5. Fluticasone propionate (Flo Vent) (For inhalation)
6. Triamcinolone (Vetalog, Aristocort)

Adverse Side Effects

Few adverse side effects are noted if these products are used according to recommendations.



Miscellaneous Respiratory Drugs

Many other drugs are used to treat respiratory disorders. These include antimicrobials, mast cell stabilizers, and diuretics. Antimicrobials are used in cases of bacterial infection of the respiratory tract and may be administered parenterally or by nebulization. Mast cell stabilizers, such as cromolyn, are most effective if used before inflammatory activation. Diuretics are used to treat respiratory disease in which pulmonary edema is a major problem.

Respiratory Stimulants

DOXAPRAM HYDROCHLORIDE

Doxapram is a general central nervous system stimulant that is used primarily as a stimulant for the respiratory system.

Clinical Uses

Doxapram is used for stimulation of respiration during and after anesthesia and to speed awakening

and restoration of reflexes after anesthesia. In neonatal animals, doxapram is used to stimulate respiration after dystocia or cesarean section.

Dosage Form

An injectable form is Dopram-V for injection (20 mg/ml, 20-ml vial)

Adverse Side Effects

These include hypertension, arrhythmia, hyperventilation, central nervous system excitation, and seizures. These effects are most likely to occur at high doses (Plumb, 2005). The safety of doxapram in pregnant animals has not been established.

NALOXONE

Naloxone is used to stimulate respirations in narcotic overdose.

YOBINE

Yobine is used to stimulate respirations in xylazine overdose.

REFERENCES

- Bill R: Drugs affecting the respiratory system. In Bill R, editor: *Pharmacology for veterinary technicians*, ed 3, St Louis, 2006, Mosby.
- Boothe DM: Drugs affecting the respiratory system. In *Small animal clinical pharmacology and therapeutics*, Philadelphia, 2001, WB Saunders.
- Dowling PM: Respiratory drugs, *Proceedings of the Annual Meeting of the American Veterinary Medical Association*, Boston, Massachusetts, 2001.
- Hoffman AM: What's new with aerosol medications in the horse, *Proceedings of the Annual Meeting of the American Veterinary Medical Association*, Boston, Massachusetts, 2001.
- Lavoie JP: Inhalation therapy for equine heaves, *Comp Contin Educ Prac Vet* 23(5):475-477, 2001.
- McKiernan B: Respiratory therapeutics, *Proceedings of the 17th Seminar for Veterinary Technicians, The Western Veterinary Conference*, Las Vegas, Nevada, 1988.
- Plumb DC: *Veterinary drug handbook*, ed 5, Ames, 2005, Iowa State University Press.
- Tilley LP, Smith WK: *The 5-minute veterinary consult: canine and feline*, ed 2, Baltimore, 2000, Lippincott Williams & Wilkins.
- Williams BR, Baer C: *Essentials of clinical pharmacology in nursing*, Springhouse, Pa, 1990, Springhouse Publishing Corp.



REVIEW QUESTIONS

1. What structures would a molecule of oxygen pass over or through as it travels from the environment to the alveoli?

2. What are the four primary functions of the respiratory system? _____
3. Describe the function of the three basic defense mechanisms of the respiratory system.

4. What are three important principles of respiratory therapeutics? _____
5. Expectorants are indicated when what type of cough is present? _____
6. Mucolytics decrease the viscosity of respiratory mucus by what mechanism?

7. Acetylcysteine is administered by what method for pulmonary uses?

8. What is the mechanism of action of most anti-tussives used in veterinary medicine?

9. Codeine is classified in what category of controlled substances? _____
10. List three mechanisms that can cause smooth muscle contraction in the bronchioles.

11. List two bronchodilators that are beta-2-adrenergic agonists. _____
12. The methylxanthines bring about bronchodilation by inhibiting what cellular enzyme?

13. List two potential uses for antihistamines in veterinary medicine. _____
14. What suffix is found at the end of many antihistamine names? _____
15. List two potential uses for Dopram.

16. Use your textbook and formulary to answer the following questions.
Maxi Jones is being treated for canine infectious tracheobronchitis. Dr. Ladd has instructed you to dispense Hycodan tablets at 0.22 mg/kg b.i.d. for 7 days. Maxi weighs 50 lb.
What dose of Hycodan does Maxi require?

How many tablets will you dispense?

Create a label for this prescription.

17. List two uses of acetylcysteine in veterinary medicine. 1. _____
2. _____
18. Which of the following is not an example of a methylxanthine?
a. Aminophylline
b. Theophylline
c. Caffeine
d. Theobromine
e. These are all examples of methylxanthines.
19. Particles of what size are capable of reaching the alveoli?

20. Give an example of a beta-2-adrenergic agonist bronchodilator.

21. All of the following are functions of the respiratory system, except _____.
a. oxygen-carbon dioxide exchange
b. regulation of acid-base balance
c. production of sodium bicarbonate to aid in regulation of acid-base balance
d. body temperature regulation
22. _____ are drugs that liquefy and dilute viscid secretions of the respiratory tract and thereby help in evacuating those secretions.
a. Antitussives
b. Decongestants
c. Bronchodilators
d. Expectorants

23. _____ are drugs that inhibit or suppress coughing.
- Antitussives
 - Decongestants
 - Bronchodilators
 - Expectorants
24. _____ is used for the relief of chronic nonproductive cough in dogs and for analgesia and preanesthesia in dogs and cats.
- Hydrocodone bitartrate
 - Butorphanol tartrate
 - Temaril P
 - Doxapram HCl
25. Drug products with codeine alone are in what schedule of controlled substances?
- Class I
 - Class III
 - Class V
 - Class II
26. Temaril-P is a combination product that contains a centrally acting antitussive (trimeprazine tartrate) and _____.
- prednisolone
 - aminophylline
 - furosemide
 - theophylline
27. Aminophylline and theophylline are _____ derivatives.
- adrenergic
 - cholinergic
 - methylxanthine
 - acetylcysteine
28. _____ are drugs that reduce the congestion of nasal membranes by reducing associated swelling.
- Antihistamines
 - Decongestants
 - Bronchodilators
 - Expectorants
29. _____ are substances that are used to block the effects of histamine.
- Antihistamines
 - Decongestants
 - Bronchodilators
 - Expectorants
30. Solu-Delta-Cortef is a brand name for _____.
- prednisolone
 - dexamethasone
 - prednisolone Na succinate
 - fluticasone propionate

DIURETIC DRUGS

Loop Diuretics
Osmotic Diuretics
Thiazide Diuretics
Potassium-Sparing Diuretics
Carbonic Anhydrase Inhibitors

CHOLINERGIC AGONISTS

ANTICHOLINERGIC DRUGS

ADRENERGIC ANTAGONISTS

Alpha-Adrenergic Antagonists
Beta-Adrenergic Antagonists

**ANGIOTENSIN-CONVERTING
ENZYME INHIBITORS**

**VASODILATORS AND CALCIUM
CHANNEL BLOCKERS**

ANTI-DIURETIC HORMONE

URINARY ACIDIFIERS

XANTHINE OXIDASE INHIBITORS

URINARY ALKALIZERS

**Pharmacotherapy of Renal Failure
Complications**

Epoetin Alpha

**Pharmacotherapy of Urinary
Incontinence**

MISCELLANEOUS RENAL DRUGS

Urinary Tract Analgesics

Phenazopyridine

Tricyclic Antidepressants

Amitriptyline

Glycosaminoglycans

Pentosan Polysulfate Sodium (Elmiron)

Other Agents

Epakitin

Azodyl

Technician's Role

CHAPTER 6

Drugs Used in Renal and Urinary Tract Disorders

LEARNING OBJECTIVES

After studying this chapter, you should be able to:

1. Identify the anatomic features of the urinary system.
2. Discuss the formation of urine through glomerular filtration, tubular reabsorption, and tubular secretion.
3. Compare the different classes of drugs and describe the indications for each class.
4. Explain how renal dysfunction can affect the metabolism and excretion of many drugs and their metabolites.

KEY TERMS

AGONIST A drug that competes for the same receptor site as another drug or natural substance and that enhances or stimulates the receptor's functional properties.

ANTAGONIST A drug that competes for the same receptor site as another drug or natural substance but does not produce a physiologic effect by itself.

ATONY The absence or lack of normal tone or strength.

CATECHOLAMINE A group of sympathomimetic amines, including dopamine, norepinephrine, and epinephrine.

DETRUSOR The smooth muscle of the urinary bladder that is mainly responsible for emptying the bladder during urination.

DETRUSOR AREFLEXIA The absence of detrusor contractions.

ERYTHROPOIESIS The formation of erythrocytes.

ERYTHROPOIETIN A glycoprotein hormone secreted mainly by the kidney; it acts on stem cells of the bone marrow to stimulate red blood cell production.

HEMATURIA Blood in the urine.

HYPERTENSION Persistently high blood pressure.

HYPERTONUS The state characterized by an increased tonicity or tension.

HYPOKALEMIA Abnormally low potassium concentration in the blood.

LOWER MOTOR NEURONS Peripheral neurons whose cell bodies lie in the central gray columns of the spinal cord and whose terminations lie in skeletal muscle. A sufficient number of lesions of lower motor neurons cause muscles supplied by the nerve to atrophy, resulting in weak reflexes and flaccid paralysis.

NEPHROLOGY The study of the urinary (renal) system.

NEPHRON The basic functional unit of the kidney.

POLYDIPSIA Excessive thirst manifested by increased water consumption.

POLYURIA Excessive urination.

UPPER MOTOR NEURONS Neurons in the cerebral cortex that conduct impulses from the motor cortex to the motor nuclei of the cerebral nerves or to the ventral gray columns of the spinal column. A sufficient number of lesions of upper motor neurons interrupt the inhibitory effect that upper motor neurons have on lower motor neurons, resulting in exaggerated or hyperactive reflexes.

UREMIA Abnormally high concentrations of urea, creatinine, and other nitrogenous end products of protein and amino acid metabolism in the blood.

URINARY INCONTINENCE Lack of voluntary control over the normal excretion of urine.

URINARY TRACT INFECTION Infection of the urinary tract. Infection may be localized or may affect the entire urinary tract.

INTRODUCTION

The urinary system (the renal system) is composed of two kidneys, two ureters, a urinary bladder, and a urethra (Figures 6-1 to 6-4). The medical study of the renal system is known as **nephrology**, because the basic functional unit of the kidney is the **nephron**. The kidneys act in the body the way a filter acts in a fish aquarium. All water in the aquarium is sent through the filter to capture waste products in the water to keep it clean. Thus, the kidneys filter all waste products out of the bloodstream but allow those elements needed by the body to stay in the bloodstream. The kidneys are bean-shaped and lie on each side of the spine. They are also retroperitoneal.

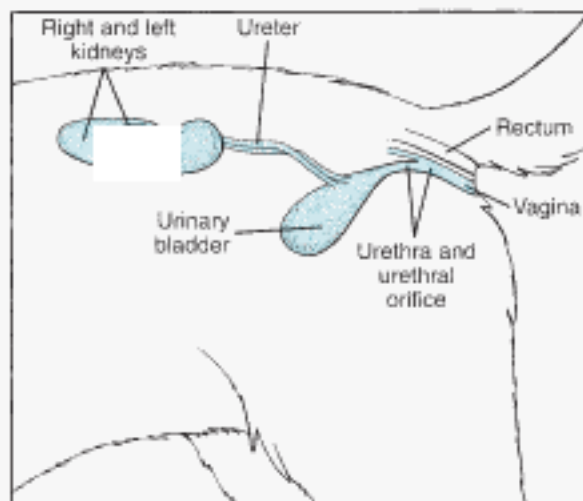

FIGURE 6-1

Side view of the urogenital system of a female dog.

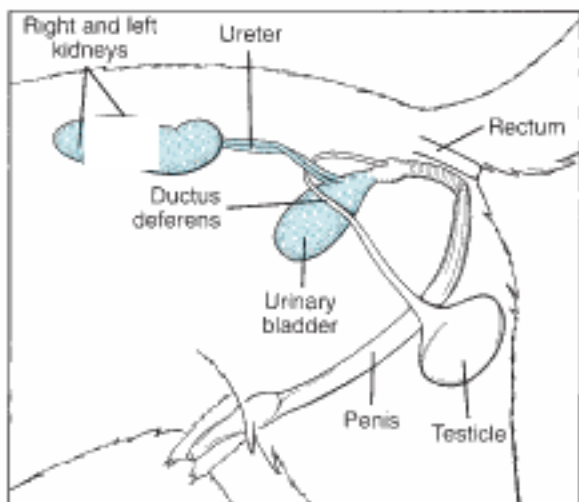

FIGURE 6-2
Side view of the urogenital system of a male dog.

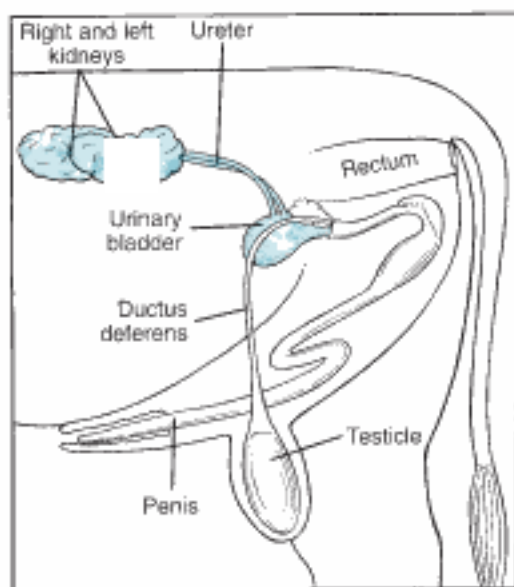

FIGURE 6-4
Side view of the urogenital system of a bull.

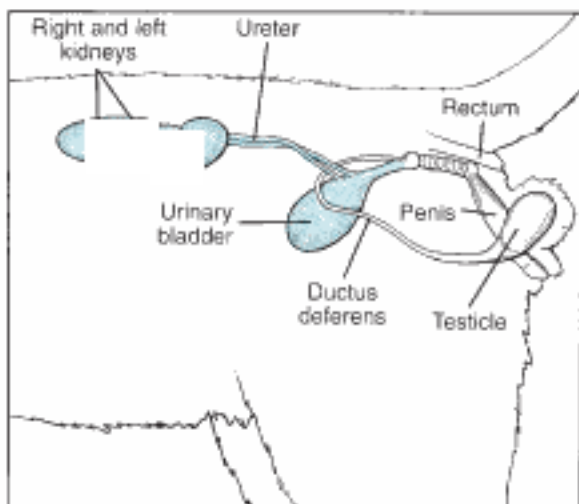

FIGURE 6-3
Side view of the urogenital system of a male cat.

The job of the nephron is to regulate water and soluble matter (especially electrolytes) in the body. Nephrons filter the blood under pressure and then reabsorb necessary fluid and molecules back into the blood, while secreting other unneeded molecules. The kidneys thus excrete a variety of waste products produced by metabolism such as urea, uric acid, and water. The kidneys are involved in factors of homeostasis such as acid-base balance, regulation of electrolyte concentrations, blood volume control,

and regulation of blood pressure. The kidneys communicate with other organs in the body through hormones that are secreted into the bloodstream.

Veterinary technicians should educate clients regarding the importance of nutrition, especially in those dog breeds predisposed to developing bladder stones (e.g., dalmatians, miniature schnauzers). Fresh water should be available for animals at all times. Companion animals observed straining to urinate or with bloody urine (i.e., **hematuria**) should be brought to the veterinary hospital immediately.

PHYSIOLOGIC PRINCIPLES

The formation of urine is a rather complex process that involves glomerular filtration, tubular reabsorption, and tubular secretion (Figure 6-5). The glomerular filtrate is composed of water and dissolved substances, which pass from the plasma into the glomerular capsule. The formation of glomerular filtrate is controlled by effective filtration pressure ($EFP = \text{arterial blood pressure} - [\text{plasma osmotic pressure} + \text{capsule pressure}]$). The amount of glomerular filtrate is directly proportional to the effective filtration pressure (Figure 6-6). Changes in blood

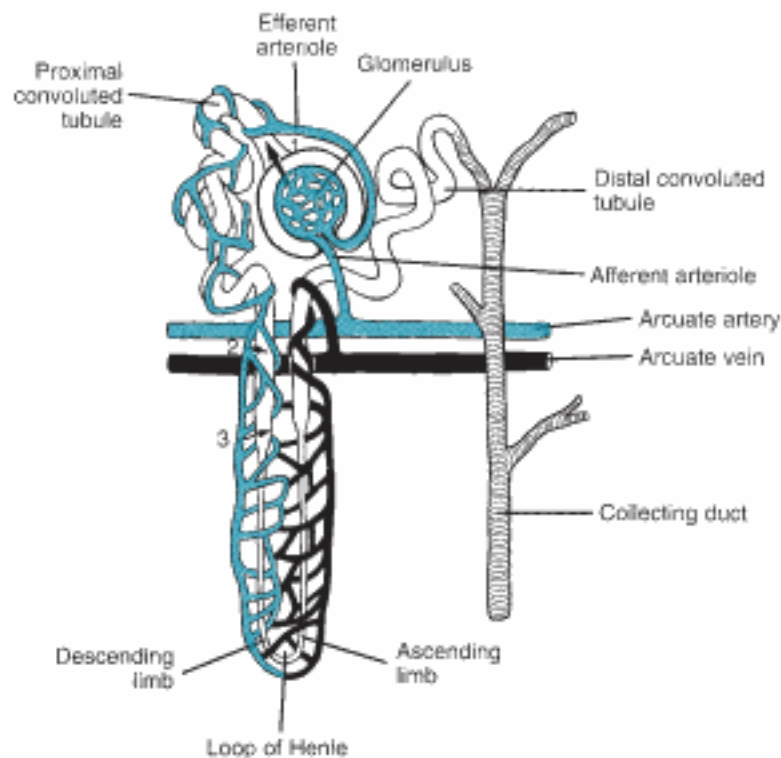

FIGURE 6-5

Shown are the direction and location of glomerular filtration: 1, tubular reabsorption; 2, tubular secretion; and 3, as they would occur in the glomerulus and the proximal tubule.

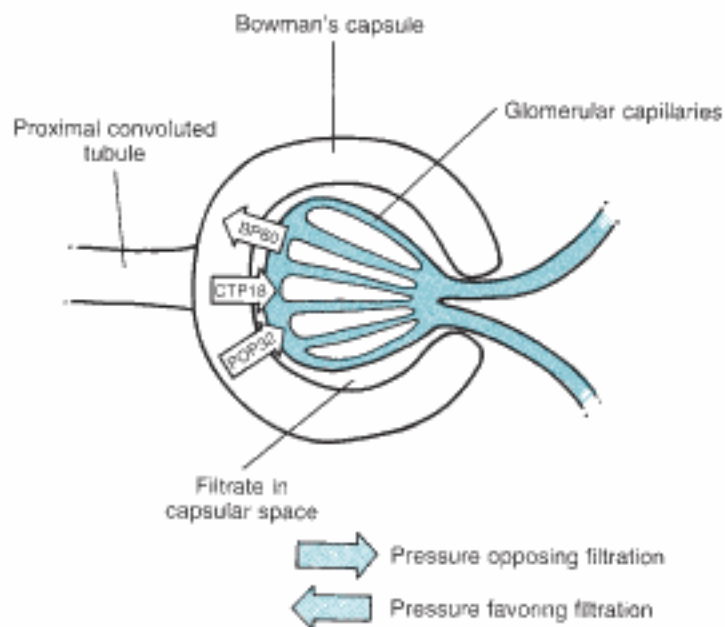

FIGURE 6-6

Filtration occurs through the glomerular membrane within Bowman's capsule. The amount of filtrate produced is determined by the difference between the pressures favoring filtration and those opposing filtration. This diagram shows that filtration occurs because $60 - (32 + 18) = 10$ mm Hg. Values greater than or less than 10 mmHg would correlate with more or less filtration, respectively. Pressure values (60, 32, 18) are measured in mm Hg. BP, Blood pressure; CTP, capsular tissue pressure; POP, plasma osmotic pressure.

flow through the glomerulus, glomerular blood pressure, plasma osmotic pressure, and capsule pressure affect glomerular filtration.

The kidney tubules are responsible for the reabsorption, or the secretion, of specific substances. Substances needed by the body are reabsorbed from the filtrate, pass through the tubular cell wall, and reenter the plasma. This process filters needed substances and returns them to the body. Reabsorbed materials include water, glucose, amino acids, urea, and ions such as Na^+ , K^+ , Ca^{2+} , Cl^- , HCO_3^- , and HPO_4^{2-} . Any excess of these substances or of substances that are not useful remains in the filtrate and is excreted in the urine.

Tubular secretion occurs when substances are carried to the tubular lumen. This involves the active transport of certain endogenous substances and many exogenous substances. These secreted substances include potassium and hydrogen ions, ammonia,

creatinine, and some drugs. The main effects of tubular secretion are to rid the body of certain materials and to help control blood pH (Figure 6-7). The kidneys are active in the metabolism and excretion of many drugs and their metabolites. Therefore, it is very important to remember that these actions may be inhibited in cases of renal failure or dysfunction. Drug therapy in animals with renal dysfunction has increased risks. Renal failure can impair a drug's absorption from an administration site or can affect a drug's distribution in the body.

If the kidneys' functionality is decreased, **erythropoiesis** may not occur correctly. Erythropoiesis is the formation of erythrocytes. **Erythropoietin** is a hormone secreted by the healthy kidney that communicates with the bone marrow to make more red blood cells. In diseased kidneys, this hormone is secreted in reduced amounts or not at all, and the animal may develop a nonregenerative anemia as a

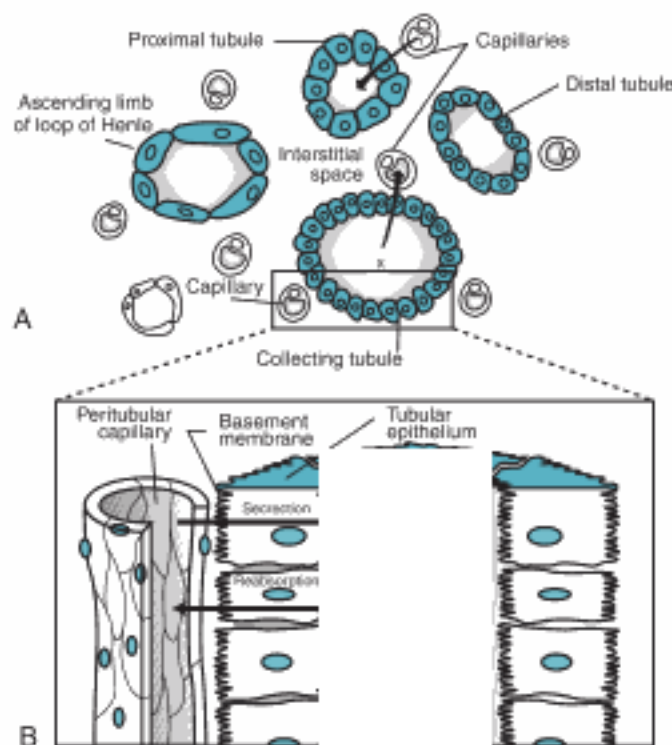

FIGURE 6-7

Tubular reabsorption and secretion. **A**, Cross-section of nephron tubules and peritubular capillaries. Interstitial fluid occupies the interstitial space. Reabsorption is represented by substance X going from tubule to capillary, and secretion is represented by substance Y going from capillary to tubule. **B**, Longitudinal section of nephron tubule. Shown is the relationship among the tubular lumen, epithelial cell, and capillary.

result. Injections of human recombinant erythropoietin may be given to animals to treat this anemia.

Uremia can increase the sensitivity of some tissues to certain drugs. For example, sensitivity to central nervous system depressants is increased, and therefore the dose of opiates, barbiturates, and tranquilizers should be reduced, in uremic patients. Xylazine (Rompun) and ketamine hydrochloride (Ketaset) are contraindicated in uremic patients. Impaired renal excretion or biotransformation causes delayed elimination of many drugs and enhances their toxicity and duration of action.

Box 6-1 lists drugs that commonly require dosage modification in renal insufficiency. Modification can be made by measuring the plasma concentrations of drugs and adjusting the dose accordingly. Because this is impractical in most clinical settings, a veterinarian

may use the normal dose but lengthen the time intervals at which it is administered, or give a smaller dose at normal time intervals. Technicians may be responsible for administering anesthesia, and it is important to remember that patients with renal failure are at greater anesthetic risk and require even closer monitoring than patients with normal renal function.

RENAL FAILURE

Renal failure is among the major causes of nonaccidental death in dogs and cats. Although the disease is most common in older animals, it may be diagnosed in younger animals. Renal damage may stem from many causes, including infectious disease, diabetes mellitus, toxins, neoplasia, congenital

BOX 6-1 Dosage Modification in Renal Insufficiency

Drugs That Require Dosage Modification or That Are Contraindicated in Renal Insufficiency

Acetazolamide
Antimonials
Aspirin
Atropine
Barbital
Bendroflumethiazide
Cephalothins
Chelating agents
Chlorothiazide
Clindamycin
Colistin and polymyxin
Decamethonium
Digoxin
Erythromycin
Furosemide (increased dose)
Gentamicin
Iodide
Kanamycin
Lincomycin
Mannitol
Mercurials
Methenamine
Methotrexate
Neomycin
Neostigmine

Nitrofurantoin
Ouabain
Penicillins
Phenazopyridine
Procainamide
Spironolactone
Streptomycin
Sulfonamides
Tetracyclines
Tetraethyl-ammonium
Tubocurarine, gallamine
Vancomycin

Drugs That Do Not Require Dosage Modification or That Are Not Contraindicated in Renal Insufficiency

Acetaminophen
Chloramphenicol
Diazepam
Narcotic analgesics
Novobiocin
Pentobarbital
Phenobarbital
Phenothiazine
Phenytoin
Procaine
Propranolol

disorders, immunologic problems, and amyloidosis. Diets with excessive protein, phosphorus, and sodium are other factors that may cause renal damage. Renal damage may be categorized as prerenal, renal, or postrenal. Renal failure may be differentiated as acute, chronic, or end-stage, according to parameters common to each stage.

DRUGS COMMONLY USED FOR THE TREATMENT OF RENAL DYSFUNCTION AND ASSOCIATED HYPERTENSION



Diuretic Drugs

Diuretics are used to remove excess extracellular fluid by increasing urine flow and sodium excretion and reducing **hypertension**. A number of conditions may indicate the need for a diuretic drug. Classifications of commonly used diuretics include loop diuretics, osmotic diuretics, thiazide and thiazide-like diuretics, potassium-sparing diuretics, and carbonic anhydrase inhibitors.

Loop Diuretics

Loop diuretics are highly potent diuretics that inhibit the tubular reabsorption of sodium. Once administered, their actions are generally rapid. Additionally, loop diuretics promote the excretion of chloride, potassium, and water. Some patients on long-term loop diuretic therapy may have to be placed on potassium supplementation.

Dosage Forms

1. Furosemide (Lasix, Disal, Diuride)
2. Ethacrynic acid (Edecrin—human label)

Adverse Side Effects

These include **hypokalemia** because of the increased excretion of potassium.

Technician's Notes

To prevent hypokalemia, a potassium supplement may be given to patients who are receiving long-term potassium-depleting diuretic therapy.

Osmotic Diuretics

Osmotic diuretics can be administered intravenously to promote diuresis by exerting high osmotic pressure in the kidney tubules and limiting tubular reabsorption. Water is drawn into the glomerular filtrate, reducing its reabsorption and increasing the excretion of water. These drugs may be used to treat oliguric acute renal failure and to reduce intracranial pressure.

Dosage Forms

1. Mannitol 20%
2. Glucose

Adverse Side Effects

These are uncommon.

Technician's Notes

These drugs are administered over a 10- to 15-minute period.

Thiazide Diuretics

Thiazide diuretics reduce edema by inhibiting reabsorption of sodium, chloride, and water. Their duration of action is longer than that of loop diuretics.

Dosage Forms

1. Chlorothiazide (Diuril—human label)
2. Hydrochlorothiazide (HydroDIURIL—human label)

Adverse Side Effects

These include hypokalemia if therapy is prolonged.

Technician's Notes

1. Similar to loop diuretics, thiazide diuretics cause an increase in potassium excretion. A potassium supplement may be necessary to prevent hypokalemia.
2. These drugs cross the placental border.

Potassium-Sparing Diuretics

Potassium-sparing diuretics have weaker diuretic and antihypertensive effects than other diuretics, but they have the ability to conserve potassium.

These agents are also referred to as *aldosterone antagonists*. They work by antagonizing aldosterone, an adrenal mineralocorticoid. This action enhances the excretion of sodium and water and reduces the excretion of potassium. Aldosterone secretion may be a factor in edema associated with heart failure.

Dosage Forms

1. Spironolactone (Aldactone—human label)
2. Triamterene (Diazide, Dyrenium—human label)

Adverse Side Effects

These are uncommon, but hyperkalemia may result if these drugs are administered concurrently with potassium supplements or angiotensin-converting enzyme (ACE) inhibitors, such as captopril or enalapril.

Technician's Notes

These drugs may be used alone or with other diuretic agents.

Carbonic Anhydrase Inhibitors

A carbonic anhydrase inhibitor is a substance that decreases the rate of carbonic acid and H^+ production in the kidney, thereby promoting the excretion of solutes and increasing the rate of urinary output (Mosby, 1998). These drugs also reduce intraocular pressure by reducing the production of aqueous humor and may be used in the treatment of glaucoma.

Dosage Forms

1. Acetazolamide (Diamox—human label)
2. Dichlorphenamide (Daranide—human label)

Adverse Side Effects

These include the ability to cause hypokalemia.

Technician's Notes

Carbonic anhydrase inhibitors have the least efficacy when compared with the other tubular inhibitors and are not commonly used to treat edema.



Cholinergic Agonists

Cholinergic agents act directly or indirectly to promote the function of acetylcholine. Cholinergic agents also may be referred to as *parasympathomimetic* agents because their effects mimic stimulation of the parasympathetic nervous system. Cholinergic **agonists** mimic the action of natural acetylcholine by directly stimulating cholinergic receptors. Once the cholinergic agonist binds with receptors on the cell membrane of smooth muscles, the permeability of the cell membrane changes, permitting calcium and sodium to enter into the cells. Depolarization of the cell membrane occurs, and muscle contraction is achieved.

Clinical Uses

Cholinergic agents are used to help void the urinary bladder. Their action increases the tone of the detrusor muscle of the bladder and decreases bladder capacity.

Dosage Form

Bethanechol (Urecholine—human label)

Adverse Side Effects

These include the potential for cholinergic toxicity.

Technician's Notes

1. Observe the patient for signs of cholinergic toxicity (e.g., vomiting, defecation, dyspnea, tremors).
2. Atropine is antidotal.



Anticholinergic Drugs

The action of anticholinergic drugs is the opposite of that of cholinergic agents. They block the action of acetylcholine at receptor sites in the parasympathetic nervous system. These drugs may also be described as *parasympatholytic* because of their ability to block the passage of impulses through the parasympathetic nerves. Their action produces muscle relaxation.

Clinical Uses

Anticholinergic drugs can be used for treating urge incontinence by promoting the retention of urine in the urinary bladder.

Dosage Forms

1. Propantheline (Pro-Banthine—human label)
2. Butyl hyoscine (Buscopan)

Adverse Side Effects

These include decreased gastric motility and delayed gastric emptying, which may decrease the absorption of other medications.

**Adrenergic Antagonists**

Adrenergic blocking agents disrupt the sympathetic nervous system by blocking impulse transmission at adrenergic neurons, adrenergic receptor sites, or adrenergic ganglia. These agents also may be described as sympatholytic agents because of their ability to block sympathetic nervous system stimulation. The classification of adrenergic **antagonists** is based on their site of action (i.e., alpha blockers, beta blockers, or autonomic ganglionic blockers).

Alpha-Adrenergic Antagonists

Alpha-adrenergic antagonists relax vascular smooth muscle, enhance peripheral vasodilation, and decrease blood pressure by interrupting the actions of sympathomimetic agents at alpha-adrenergic receptor sites.

Clinical Uses

In the urinary system, these drugs reduce internal sphincter tone when the urethral sphincter is in **hypertonus**. This action is useful in the treatment of urinary retention because of **detrusor areflexia** or functional urethral obstruction. Prazosin is effective in controlling moderate to severe hypertension, which may be a complicating factor in chronic renal failure.

Dosage Forms

1. Phenoxybenzamine (Dibenzylamine—human label)
2. Nicergoline (Sermion)

3. Moxisylyte (Carlytene)
4. Prazosin (Minipress—human label)

Adverse Side Effects

These include rapid decrease in blood pressure, resulting in weakness or syncope after the first dose of prazosin. This is usually self-limiting.

Technician's Notes

1. Prazosin may be used alone or combined with a diuretic to produce the desired effect.
2. Because alpha-adrenergic antagonists are metabolized by the liver, dosage modification is not necessary in patients with renal dysfunction.

Beta-Adrenergic Antagonists

Beta-adrenergic antagonists inhibit the action of **catecholamines** and other sympathomimetic agents at beta-adrenergic receptor sites and thereby inhibit stimulation of the sympathetic nervous system.

Clinical Uses

These include control of mild to moderate hypertension associated with chronic renal failure.

Dosage Form

Propranolol (Inderal—human label)

Adverse Side Effects

These include decreased cardiac output and the promotion of bronchospasm. Therefore, caution should be exercised with their use in patients with cardiac or pulmonary disease (Cowgill, 1991).

Technician's Notes

Combination with a diuretic is common because of the tendency of beta-adrenergic antagonists to cause salt and fluid retention.

Angiotensin-Converting Enzyme Inhibitors

ACE inhibitors block the conversion of angiotensin I to angiotensin II, decrease aldosterone secretion, reduce peripheral arterial resistance, and alleviate vasoconstriction.

Clinical Uses

ACE inhibitors are used to treat nonresponding hypertension or moderate to severe hypertension.

Dosage Forms

1. Benazepril
 - a. Fortekor (veterinary label)
 - b. Benazepril Lotensin (human label)
2. Captopril (Capoten—human label)
3. Enalapril (Enacard)

Adverse Side Effects

These include complications in patients with renal insufficiency caused by excretion by the kidneys.

Vasodilators and Calcium Channel Blockers

A vasodilator or calcium channel blocker may be substituted for or used in combination with other medications if previous drug therapy to control hypertension fails.

Clinical Uses

These drugs are used to treat nonresponding hypertension. Dopamine may be used to promote diuresis in patients unresponsive to loop or osmotic diuretics.

Dosage Forms

1. Vasodilators
 - a. Hydralazine (Apresoline—human label)
 - b. Dopamine (Intropin—human label)
2. Calcium channel blockers
 - a. Diltiazem (Cardizem—human label)
 - b. Verapamil (Isoptin—human label)
 - c. Amlodipine (Norvasc and Besylate—human label)

Adverse Side Effects

These include hypotension, edema, conduction disturbances, heart failure, and bradycardia (Cowgill, 1991). Hydralazine is excreted by the kidneys and requires dosage modification when used to treat hypertension in patients with renal failure.

Antidiuretic Hormone

Antidiuretic hormone (ADH) is normally secreted by the posterior pituitary gland. This secretion regulates fluid balance in the body. In some conditions, such as pituitary diabetes insipidus, this hormone fails to be synthesized or excreted properly, and **polyuria** and **polydipsia** occur.

Clinical Uses

ADH is used to treat diabetes insipidus.

Dosage Form

Vasopressin (Pitressin—human label)

Adverse Side Effects

These are uncommon.

Technician's Notes

Chlorpropamide (Diabinese, Glucamide) is a human product that is used to control type II diabetes mellitus. It potentiates the action of ADH and may be used to treat mild diabetes insipidus.

Urinary Acidifiers

Urinary acidifiers are used to produce acid urine, which assists in dissolving and preventing formation of struvite uroliths. Since the introduction of urinary acidifying diets, urinary acidifiers have not been routinely prescribed.

Dosage Forms

1. Methionine (Methigel, Methio-Tabs)
2. Ammonium chloride (Urozeze)

Adverse Side Effects

These include gastrointestinal disturbances. These products should not be administered to patients with severe liver, kidney, or pancreatic disease or to those who exhibit acidosis.

Technician's Notes

It is very important to inform clients who may change from using an acidifier to one of the available acidifying diets that while the diet is being administered, no acidifiers, salt, vitamin or mineral supplements, or any other food items—other than what is allowed in the diet—should be given to the patient.

Xanthine Oxidase Inhibitors

Xanthine oxidase inhibitors decrease the production of uric acid and are used in combination with a urate calculolytic diet for the dissolution of ammonium acid urate uroliths. Once dissolution occurs, a urine-alkalizing, low-protein, low-purine, low-oxalate diet is usually prescribed to prevent recurrence of uroliths.

Dosage Form

Allopurinol (Zyloprim—human label)

Adverse Side Effects

These are uncommon, but because excretion occurs via the kidneys, the dosage may be altered in patients with renal insufficiency.

Technician's Notes

In cases of recurrence, allopurinol may once again be prescribed.

Urinary Alkalizers

Urinary alkalizers may be used in the management of ammonium acid urate, calcium oxalate, and cystine urolithiasis.

Dosage Forms

1. Potassium citrate (Urocit-K—human label)
2. Sodium bicarbonate, administered orally
3. Tiopronin tablets (Thiola—human label)

Adverse Side Effects

These include possible fluid and electrolyte imbalance with the use of sodium bicarbonate.

PHARMACOTHERAPY OF RENAL FAILURE COMPLICATIONS

Because the renal cortex produces erythropoietin, chronic renal failure can cause an absolute or relative deficiency in its production. The resultant complication is normocytic, normochromic anemia that is classified as nonregenerative. Parenteral androgens, such as nandrolone (Durabolin) and testosterone enanthate, are capable of stimulating the production of red blood cell precursors and may increase the level of erythropoietin. Injections of recombinant human erythropoietin (Epoen, Procrit) have been shown to correct anemia associated with chronic renal failure (Ettinger, 2000). When a regimen of erythropoietin is administered, packed cell volume (PCV) values should be monitored on a weekly basis until improvement is reached and until after the dose has been decreased. It also may be advisable to place animals on supplemental iron as an adjunct in supporting RBC production (Merck, 2006). Vitamin D supplements may be used in the control of renal secondary hyperparathyroidism. Rocaltrol (calcitriol) and dihydrotachysterol (Hytakerol) may be used for this purpose. Serum calcium, creatinine, and phosphate levels should be monitored in patients receiving this therapy because hypercalcemia, hyperphosphatemia, or deteriorating renal function can occur (Ettinger, 2000).

EPOETIN ALPHA (EPOGEN, PROCIT)**Adverse Side Effects**

These include local or systemic allergic reaction in animals and pain occurring at the injection site. Headaches, along with seizures, have occurred in humans.

PHARMACOTHERAPY OF URINARY INCONTINENCE

Erringer (2000) states: "Pharmacologic agents are selected for management of **urinary incontinence** when **urinary tract infection**, morphologic abnormalities, and mechanical types of excessive outlet resistance have been excluded as possible causes of the problem." Urinary incontinence may be described as a neurogenic disorder or a nonneurogenic disorder. A neurogenic disorder is evidenced by a neurologic lesion that affects the **upper motor neuron** segments or the **lower motor neuron** segments. When upper motor neuron segments are affected, the result is a spastic neuropathic bladder.

Detrusor muscle contractions are normal, but bladder and urethral functions are abnormal. Therefore, as the bladder fills with urine, contractions occur more frequently (hypercontractility) and bladder capacity decreases. Also, contraction of the detrusor muscle and relaxation of the urethral sphincter often are not coordinated. This results in interrupted, incomplete, and involuntary urination.

Functional urinary obstruction and urinary retention may also be present. When lower motor neuron segments are affected, the result is an **atonic**, neuropathic bladder. With this disorder, detrusor muscle contractions are abnormal and the sensation of fullness is absent when the bladder fills (hypocontractility). This causes the bladder to distend, and eventually, bladder capacity increases. Bladder distention may cause damage to the tight junctions between smooth muscle fibers. Urination eventually occurs when pressure inside the bladder exceeds urethral outlet resistance.

Nonneurogenic disorders occur as a result of some type of anatomic anomaly of the lower urinary tract. In the young dog, this is usually a congenital anomaly. A congenital anomaly seen in young female dogs is ectopic ureter, which causes constant dribbling of urine. This occurs when the ureters end in abnormal places rather than at normal sphincters. In the older dog, acquired anatomic anomalies are usually responsible for nonneurogenic disorders. Conditions that commonly cause such problems include chronic cystitis, chronic urethritis, neoplasia, urolithiasis, and postsurgical adhesions. Other

nonneurogenic disorders include functional abnormalities such as urethral incompetence and partial urethral obstruction. One type of nonneurogenic urethral incompetence is often seen in spayed female dogs and is usually responsive to hormonal therapy. Once the cause of the urinary incontinence has been identified, medical or surgical management begins. If a morphologic abnormality is causing urinary incontinence, surgical correction of the problem is necessary.

Medical management may include treatment for infection, if present, and treatment for the cause of the urinary incontinence (e.g., urethral incompetence, bladder hypercontractility or hypocontractility). Drugs used in the medical management of urinary incontinence include the previously mentioned cholinergic agonists, anticholinergics, alpha-adrenergic antagonists, smooth muscle relaxants, skeletal muscle relaxants, tranquilizers, alpha-adrenergic agonists, and hormones such as estrogen and testosterone. Table 6-1 outlines these drugs for easy reference.



Miscellaneous Renal Drugs

Urinary Tract Analgesics

PHENAZOPYRIDINE

Phenazopyridine is used in humans as a urinary tract analgesic. It can be bought over-the-counter. It can be used alone or with sulfa drugs. Its use is contraindicated in felines because they are quite susceptible to dose-related methemoglobinemia, and oxidative changes in hemoglobin may be irreversible, causing formation of Heinz bodies and anemia (Osborne, 2001).

Tricyclic Antidepressants

AMITRIPTYLINE

Dosage Form

Amitriptyline (Elavil)

Amitriptyline has many properties and has been used in treating interstitial cystitis in humans. Its mechanism is not fully understood. Amitriptyline is a tricyclic antidepressant and anxiolytic drug with anticholinergic, antihistaminic, anti-alpha-adrenergic, antiinflammatory, and analgesic properties. It has

Table 6-1 Pharmacotherapy of Urinary Incontinence

Drug	Action	Examples of Indications
Bethanechol (Urecholine)	Cholinergic agonist	Bladder hypocontractility
Propantheline (Pro-Banthine)	Anticholinergic agent	Urge incontinence, bladder hypercontractility
Butyl hyoscine (Buscopan)	Anticholinergic agent	Urge incontinence, bladder hypercontractility
Phenoxybenzamine (Dibenzyline)	Alpha-adrenergic antagonist	Urethral hyperreflexia
Nicergoline (Sermion)	Alpha-adrenergic antagonist	Urethral hyperreflexia
Moxisylyte (Carlytene)	Alpha-adrenergic antagonist	Urethral hyperreflexia
Aminopropazine (Jenotone)	Smooth muscle relaxant	Urge incontinence, bladder hypercontractility
Dantrolene (Dantrium)	Skeletal muscle relaxant	Urethral hyperreflexia
Diazepam (Valium)	Tranquilizer/skeletal muscle relaxant	Urethral hyperreflexia
Phenylpropanolamine	Alpha-adrenergic agonist	Urethral incompetence
Diethylstilbestrol (DES)	Antineoplastic, estrogen (hormone)	Hormone-responsive urethral incompetence
Testosterone cypionate	Hormone	Hormone-responsive urethral incompetence
Testosterone propionate	Hormone	Hormone-responsive urethral incompetence

been used extensively for the treatment of interstitial cystitis in humans. Although it is a popular drug, its exact mechanism of action and therapeutic value in managing patients with interstitial cystitis remain unknown. This drug has been used recently for symptomatic treatment of idiopathic feline lower urinary tract disease (LUTD) (Osborne, 2001).

Adverse Side Effects

Many side effects such as dry mouth, rapid heart rate, and sedation (i.e., antihistamine effects) are associated with this drug. High doses can cause heart toxicity. Sometimes it may cause cats to be less interested in grooming themselves. Additionally, weight gain may occur (Papich, 2002).

Glycosaminoglycans

Glycosaminoglycans (GAGs) are found covering the transitional epithelium of the urinary tract. These urothelial GAGs have the ability to keep microorganisms and crystals from adhering to the bladder wall and limit the transepithelial movement of urine proteins and solutes (ionic or nonionic). Defects in surface GAGs and subsequent urothelial permeability are believed to be a factor in the pathogenesis of feline idiopathic LUTD (Osborne, 2001).

PENTOSAN POLYSULFATE SODIUM (ELMIRON)

Clinical Uses

Often used to manage human interstitial cystitis. Used to reinforce urothelial GAGs and to reduce transitional cell injury.

Adverse Side Effects

The safety and efficacy of pentosan polysulfate or other GAGs for the treatment of feline LUTD have not been reported. This treatment remains a logical choice, but it is not possible to make recommendations at this time (Osborne, 2001).

Other Agents

EPAKITIN

Epakitin is a chitosen-based nutritional supplement made from a polysaccharide extracted from crab and shrimp shells.

Clinical Uses

Product information states that Epakitin binds phosphorus in the intestine, causing phosphorus to be eliminated through the intestinal tract. Reducing the amount of phosphorus absorbed then helps to lower the elevated levels of phosphorus noted in renal failure.

AZODYL

Azodyl product information claims that this product has the potential to reduce the azotemia of renal failure through “enteric dialysis.”

TECHNICIAN'S ROLE

Veterinary technicians have a vital role in the care of patients with problems that affect the urinary system. This role includes providing client support and education, carrying out patient nursing care, performing necessary laboratory or radiologic examinations, giving surgical assistance, and understanding the various drugs and diets available for the treatment of renal disease.

REFERENCES

- Cowgill LD: Clinical significance, diagnosis, and management of systemic hypertension in dogs and cats. In Cowgill LD, editor: *Managing renal disease and hypertension*, 1991, Harmon-Smith.
- Ertinger SJ: *Textbook of veterinary internal medicine*, vol I and II, ed 5, Philadelphia, 2000, WB Saunders.
- Mosby's pocket dictionary of medicine, nursing and allied health, ed 3, St. Louis, 1998, Mosby.
- Osborne CA: Idiopathic lower urinary tract diseases: therapeutic rights and wrongs. *Proceedings of the Annual Meeting of the American Veterinary Medical Association*, Boston, Massachusetts, 2001.
- Papich MG: *Saunders handbook of veterinary drugs*, Philadelphia, 2002, WB Saunders.
- Merck Veterinary Manual (2006): www.merckvetmanual.com/mvm/index.jsp?cfile=htm/bc/10207.htm&word=erythropoietin

**REVIEW QUESTIONS**

- What structures constitute the urinary system?

- Name two drugs that are contraindicated in uremic patients. _____
- Renal damage may be categorized as _____, or _____.
- Explain how diuretics work.

- What supplement may be administered in conjunction with loop diuretics?

- ACE inhibitors block the conversion of angiotensin I to _____.
- Urinary acidifiers are used to produce acid urine, which assists in dissolving and preventing the formation of _____ uroliths.
- The renal cortex produces _____; thus chronic renal failure can cause an absolute or relative _____ in its production.
- Why is furosemide referred to as a loop diuretic?

- Where is ADH secreted? _____
- The ureters _____.
 - originate from the urinary bladder and lead to the outside of the body
 - originate from the kidneys and connect with the urinary bladder
 - are found inside the nephrons
 - are found inside the glomerulus
- Persistently high blood pressure is known as _____.
 - hypertonus
 - hyperkalemia
 - hypertension
 - atony
- Diuretics are used to remove _____ fluid.
 - intracellular
 - extracellular
- Antidiuretic hormone (ADH) is normally secreted by the _____ pituitary gland.
 - anterior
 - posterior

15. What supplement may be administered in conjunction with loop diuretics?
 - a. Calcium
 - b. Phosphorus
 - c. Aluminum hydrochloride
 - d. Potassium
16. Urinary acidifiers are used to produce acid urine, which assists in dissolving and preventing the formation of _____.
 - a. calcium
 - b. uroliths
 - c. urinary casts
 - d. bacteria
17. _____ is a medical term for bloody urine.
 - a. Hematuria
 - b. Hemolysis
 - c. Hematopoiesis
 - d. Uremia
18. What part of the kidney is responsible for the reabsorption, or the secretion, of certain substances?
 - a. Nephrons
 - b. Tubules
 - c. Glomerular filtrate
 - d. Extracellular fluid
19. Patients with renal failure are at a lesser anesthetic risk than patients with normal renal function.
 - a. True
 - b. False
20. Loop diuretics inhibit the tubular reabsorption of _____.
 - a. calcium
 - b. phosphorus
 - c. sodium
 - d. potassium

Categories of Cardiovascular Drugs

Categories of Cardiovascular Drugs

POSITIVE INOTROPIC DRUGS

Cardiac Glycosides (Digitalis)

Catecholamines

Epinephrine

Isoproterenol

Dopamine

Dobutamine

Bipyridine Derivatives

Inotropic, Mixed Dilator

Pimobendan

ANTIARRHYTHMIC DRUGS

Class IA

Quinidine

Procainamide

Class IB

Lidocaine

Tocainide and Mexiletine

Class IC

Class II

Propranolol

Atenolol

Other Beta Blockers

Class III

Class IV

Verapamil Hydrochloride

Diltiazem

Other Class IV Antiarrhythmics

VASODILATOR DRUGS

Hydralazine

Nitroglycerin Ointment

Prazosin

Angiotensin-Converting Enzyme

Inhibitors

DIURETICS

Furosemide

Thiazides

Spironolactone

Dietary Management of Heart

Disease

Ancillary Treatment of Heart Failure

Bronchodilators

Oxygen Therapy

Sedation

Aspirin

Thoracentesis and Abdominocentesis

CHAPTER 7

**Drugs Used
in Cardiovascular
System Disorders**

LEARNING OBJECTIVES

After studying this chapter, you should be able to:

1. Describe the basic anatomy and physiology of the cardiovascular system.
2. List four compensatory mechanisms of the cardiovascular system.
3. List five basic objectives of the treatment of cardiovascular disease.
4. Differentiate between an inotropic and a chronotropic drug.
5. List and describe the indications, physiologic effects, and toxic side effects of the cardiac glycosides.
6. List the four categories of antiarrhythmic drugs and give an example from each category.
7. List potential adverse side effects of the antiarrhythmic drugs.
8. Describe the actions and potential side effects of the vasodilator drugs.
9. Describe the actions and potential side effects of the angiotensin-converting enzyme (ACE) inhibitors.
10. Describe the actions and potential side effects of the diuretics used to treat cardiovascular disease.
11. Describe the purpose of dietary sodium restriction in the therapy of cardiovascular disease.
12. List ancillary drugs or procedures that may be used in the treatment of cardiovascular disease.



KEY TERMS

AFTERLOAD The resistance (pressure) in arteries that must be overcome to empty blood from the ventricle.

ARRHYTHMIA (DYSRHYTHMIA) A variation from the normal rhythm.

AUTOMATICITY The ability of cardiac muscle to generate impulses.

BRADYARRHYTHMIA Bradycardia associated with an irregularity of heart rhythm.

BRADYCARDIA A slower-than-normal heart rate.

CHRONOTROPIC Affecting the heart rate.

DEPOLARIZATION Neutralizing of the polarity of a cardiac cell by an inflow of sodium ions. Depolarization results in contraction of the cardiac cell and renders it incapable of further contraction until repolarization occurs.

INOTROPIC Affecting the force of cardiac muscle contraction.

PRELOAD The volume of blood in the ventricles at the end of diastole.

PREMATURE VENTRICULAR CONTRACTION (PVC) Contraction of the ventricles without a corresponding contraction of the atria. PVCs arise from an irritable focus or foci in the ventricles.

REPOLARIZATION The return of the cell membrane to its resting polarity after depolarization.

STROKE VOLUME The amount of blood ejected by the left ventricle with each beat.

TACHYARRHYTHMIA Tachycardia associated with an irregularity in normal heart rhythm.

TACHYCARDIA A faster-than-normal heart rate.

INTRODUCTION

Heart disease has a relatively high incidence in veterinary medicine. Studies have found that approximately 11% of all dogs presented to veterinary clinics exhibited some degree of heart disease (Roudebush et al, 2000). Heart disease may be congenital or acquired. However, the acquired form accounts for most cases. The incidence and cause may vary from location to location. Heartworm disease accounts for a large percentage of heart disease in some parts of the country, whereas acquired disease of the atrioventricular valves or myocardium has a more uniform distribution. Acquired disease is encountered more often in older animals, and congenital disease is more prevalent in younger ones.

Whatever the cause, treatment of heart disease is often individualized to the particular patient according to cause, degree of progression, and owner cooperation. The response to treatment must be monitored carefully and adjusted while the disease progresses, causing poor liver or kidney function, or while toxic side effects develop. Some cardiovascular drugs have a narrow margin of safety (i.e., they are potentially toxic at low doses), and failing liver and kidney function may reduce the body's ability to metabolize or eliminate these drugs.

Because veterinary technicians are often the persons who monitor the progress of hospitalized patients, they must be aware of the signs of cardiovascular disease and of normal and abnormal responses to drugs used to treat this disease.

ANATOMY AND PHYSIOLOGY OF THE HEART

The heart is a four-chambered pump that is responsible for moving blood through the vascular system. The two dorsal chambers are called *atria*, and the two ventral chambers are called *ventricles* (Figure 7-1). Each of the chambers is composed primarily of strong muscle tissue called *myocardium*, which contracts to eject the blood. Even though the heart is considered one organ, it functions as two pumps (Spinelli and Enos, 1978).

The right atrium and ventricle constitute the "right-side pump," and the left atrium and ventricle make up the "left-side pump." Blood from the general circulation returns by way of the vena cava to the right atrium, enters the right ventricle through the right atrioventricular valve (tricuspid valve), and is pumped through the pulmonary artery to the lungs. In the lungs, the blood gives up carbon dioxide and

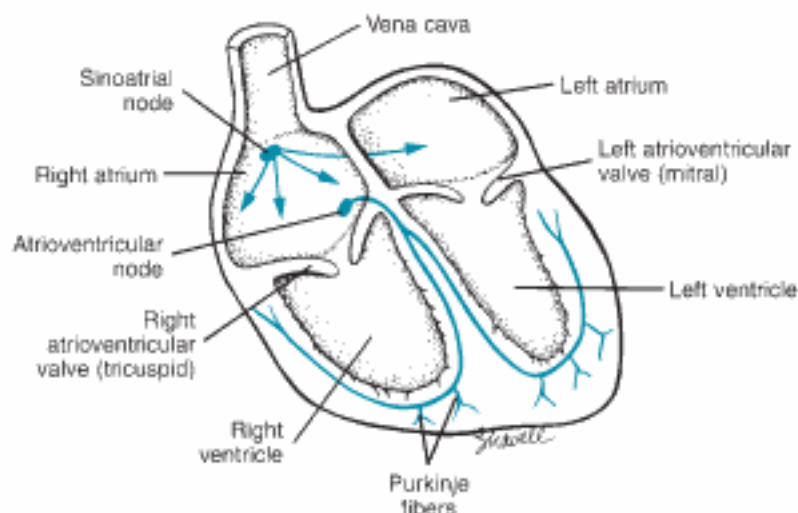

FIGURE 7-1
Schematic of the heart and its conduction system.

picks up oxygen. The oxygenated blood returns to the heart via the pulmonary veins, where it fills the left atrium, passes through the left atrioventricular valve (mitral valve), and enters the left ventricle. The mitral and tricuspid valves swing open when the atria contract and snap shut when the ventricles contract. The closing of the valves as the ventricles contract prevents blood from flowing back into the atria. The left ventricle then contracts and ejects the oxygenated blood through the aorta out into the branching arteries. These arteries divide into arterioles and end in the thin-walled capillaries throughout the body, where carbon dioxide is loaded to the blood and oxygen is unloaded to the tissue. Because the left ventricle must work harder to pump blood throughout the body than the right ventricle must work to pump blood to the lungs, the left ventricular wall is thicker than the right ventricular wall.

The pumping action of the heart is divided into two phases—systole and diastole. Systole is the period of contraction of the chambers, and diastole represents the relaxation phase when the chambers are filling with blood. Because each cell in the heart is capable of contracting spontaneously, the interaction of these two phases must be carefully coordinated to create an efficient pumping action. Diastolic time must be adequate to allow the atria to fill completely, and atrial systole must occur shortly

before ventricular systole to allow the ventricles to fill maximally. Coordination of these two phases is achieved primarily through a wave of electric activity that arises in a specialized group of cells in the right atrium and then is conducted throughout the myocardium by a special conduction system.

The structures that make up the cardiac conduction system (see Figure 7-1) include the sinoatrial node, the atrioventricular node, the bundle of His and its branches, and the Purkinje system. Under abnormal conditions, parts of the myocardium and conduction system are capable of spontaneous discharge. Normally, however, the sinoatrial node discharges most rapidly and spreads a wave of depolarization over remaining areas of the heart before they can depolarize spontaneously. The rate of discharge of this node therefore controls the heart rate and is called the *cardiac pacemaker*. Impulses generated by the sinoatrial node travel over the atria to the atrioventricular node, face a brief delay (about 0.1 second) in the atrioventricular node, travel down the bundle of His to its left and right branches, and pass into the ventricular muscle via the Purkinje fibers. Myocardial cells are joined together by structures called *intercalated disks* and by fusing of cell membranes into an interconnected mass of cells called a *syncytium*. The syncytium of cells in the atria is separate and is insulated from the

syncytium in the ventricles (Ganong, 2003). An electric stimulus from the sinoatrial node is transmitted over the entire atrial mass by the syncytial arrangement of cells. The impulse is not, however, transmitted directly into the ventricular syncytium. The impulse first must be picked up and transmitted by the atrioventricular node through its conduction system to the ventricular syncytium. Stimulation of a single atrial or ventricular muscle fiber causes the entire atrial or ventricular muscle mass to contract as a unit. When situations cause spontaneous depolarization of cardiac muscle or abnormalities of the conduction system, **arrhythmias** may occur.

When a cardiac cell is stimulated by electric activity that arises in the sinoatrial node, it undergoes depolarization and contracts. **Depolarization** is characterized by the rapid influx of sodium ions into the cell through channels or “gates,” the slower influx of calcium ions, and the outflow of potassium ions (Figure 7-2). Until the sodium, potassium, and calcium ions have returned to the positions they had before depolarization, the cell is in a refractory period (Figure 7-3). A cell in an absolute refractory state cannot normally depolarize. In a relative refractory period, however, a cardiac cell can depolarize again, but the stimulus must be stronger than normal (Bill, 2006). A refractory period is essential for a cardiac cell to prevent it from remaining in a constant state of contraction as the result of stimulation by recycling impulses. The return of the ions to their original positions is brought about in part by the sodium-potassium pump and is an essential part of the **repolarization** process. Summed electric activity arising from the contraction of all heart cells represents the electrocardiogram (Figure 7-4), with each of its waves signifying activity in a particular area.

Even though the heart establishes its own inherent rate of beating, this rate is subject to outside influences through the autonomic nervous system. The sympathetic portion of the autonomic nervous system, through beta-1 receptors, produces positive **chronotropic** and **inotropic** effects on the heart. The parasympathetic branch of the autonomic nervous system causes negative chronotropic effects through cholinergic receptors.

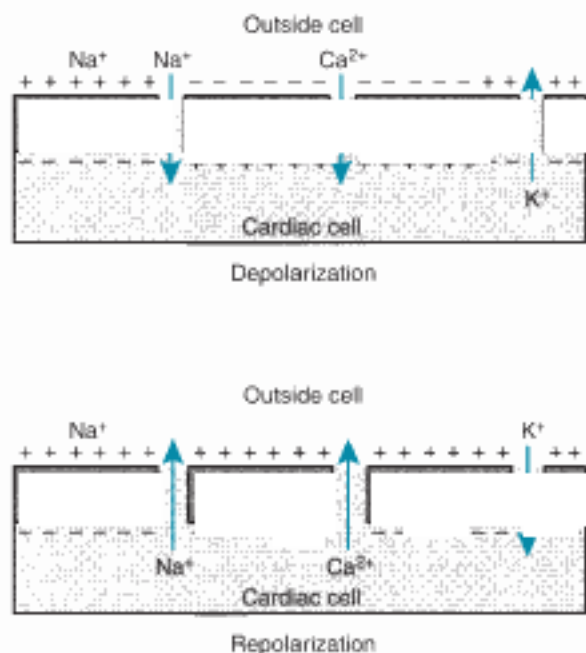

FIGURE 7-2

Depolarization and repolarization of a cardiac cell. Repolarization: The sodium-potassium-ATPase pump restores electrolytes to their resting sites.

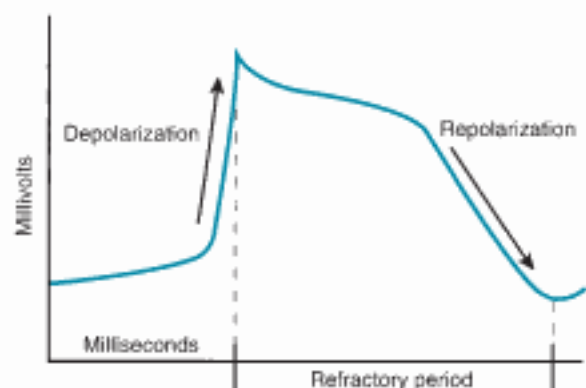

FIGURE 7-3

Schematic of the refractory period of a cardiac cell. After depolarization (contraction), cardiac muscle cells are unable to contract again until they have undergone repolarization. The time during which they are unable to contract is the refractory period.

The heart pumps blood through a series of arteries (arterial tree) to deliver it to the tissues. The larger of these arteries have elastic properties, which

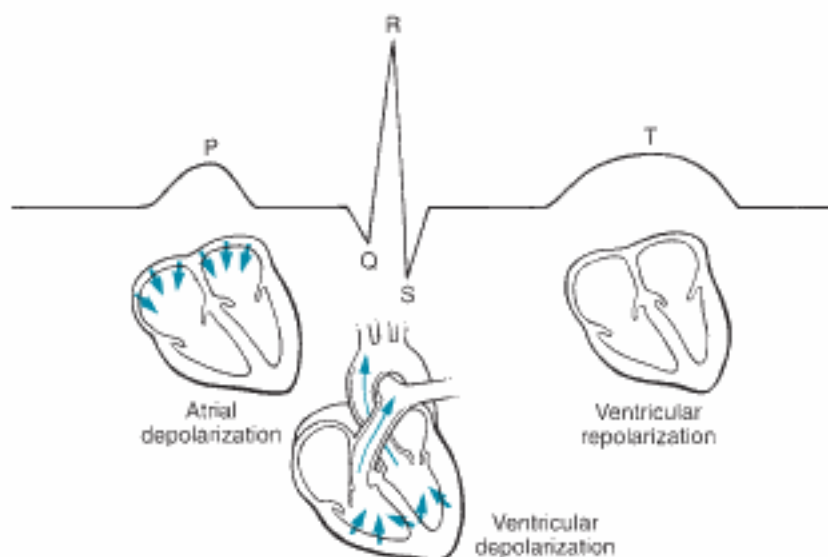

FIGURE 7-4
Cardiac events as depicted on an electrocardiogram.

allow them to stretch and recover when blood is pumped into them—thereby serving as a second pump (Upton, 1988). The smaller arteries are capable of changing their diameter (constricting or dilating) through the action of smooth muscle in their walls to increase or decrease the resistance that the heart must pump against. Stimulation of alpha-1 receptors causes vessels to constrict, and stimulation of beta-2 receptors causes vessels to dilate.

The amount of blood that the heart is capable of pumping per minute is called *cardiac output*; this value is calculated by multiplying the heart rate by the stroke volume. The **stroke volume** is determined in part by the amount of blood that fills the ventricle during diastole, called the **preload**, and the arterial resistance that the ventricle must pump against, called the **afterload**.

COMPENSATORY MECHANISMS OF THE CARDIOVASCULAR SYSTEM

The cardiovascular system has a built-in reserve capacity, which allows it to increase its output during times of need (e.g., athletic performance) and

to compensate for cardiac disease. The four basic factors of cardiac reserve or compensation are described in the following (Bill, 1994):

1. Increasing heart rate. Increasing the rate of contraction increases cardiac output up to the point at which the rate is so fast that there is inadequate time for ventricular filling.
2. Increasing the stroke volume. Up to a point, an increased force of contraction results in an increase in the amount of blood that is pumped.
3. Increasing the efficiency of the heart muscle.
4. Physiologic heart enlargement. The heart is composed of muscle that responds to work by increasing its size and becoming stronger.

Many disorders can result in cardiac disease. However, most that respond to pharmacologic therapy fall into one of the following categories:

1. Valvular disease. Valvular insufficiency, a backflow or leakage of blood backward through the valve, is a relatively common acquired heart disorder of dogs. If the tricuspid valve is affected, ascites may occur. If the mitral valve

is involved, pulmonary edema may result. Valvular disease may result from progressive bacterial endocarditis. Inadequate opening of valves may also occur and cause disease. Insufficiency or stenosis may be accompanied by a murmur.

2. Cardiac arrhythmias. If a focus of cardiac tissue depolarizes out of sequence with the sinoatrial node, an arrhythmia may result. Various types of arrhythmias, including **tachyarrhythmias** (arrhythmias with a rapid rate) and **bradyarrhythmias** (arrhythmias with a slow rate), may occur. Arrhythmias may occur in the atria (supraventricular) or in the ventricles (ventricular). Several categories of drugs (catecholamines, thiobarbiturates, xylazine, digoxin, and others) predispose the heart to arrhythmias.
3. Myocardial disease. Cardiomyopathy, a disease of the myocardium, primarily affects dogs and cats. It may be classified as congestive (the

myocardium becomes thin and ineffective in its pumping action) or hypertrophic (the myocardium becomes thickened and restricts ventricular filling). Each type is often accompanied by various arrhythmias.

4. Other potential causes of cardiac disease include congenital defects (right-to-left shunts), abnormalities of cardiac innervation, vascular disease (hypertension), and heartworm disease.

Cardiovascular diseases with the greatest prevalence include mitral disease in dogs, hypertrophic cardiomyopathy in cats, dilated cardiomyopathy in dogs, "Boxer" cardiomyopathy, and heartworms (Hamlin, 2003).

Congestive heart failure (CHF) (Figure 7-5) occurs when the pumping ability of the heart is impaired to the extent that sodium and water are retained in an effort to compensate for inadequate cardiac output. It is associated with exercise

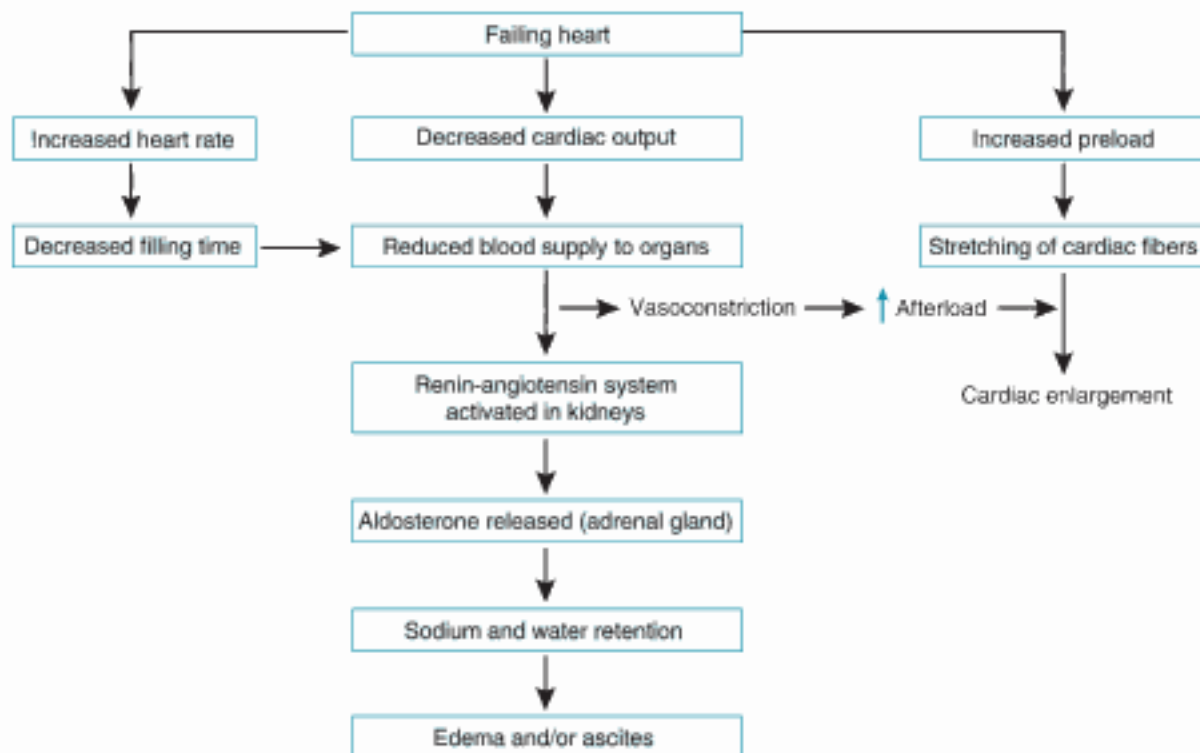

FIGURE 7-5

Pathophysiology of congestive heart failure.

Table 7-1 Stages and Treatment of Cardiac Disease

Stage	Signs	Treatment
I	None/murmur	None
II	Cough	Restricted sodium diet Diuretic Bronchodilator
III	Cough Reduced exercise tolerance	Sodium restriction Digitalis Diuretic Vasodilators
IV	Dyspnea at rest	Oxygen Diuretics Sedatives Vasodilators Others

intolerance, pulmonary edema, and ascites. The heart usually becomes enlarged in this condition.

Cardiac disease has been divided into four phases according to degree of severity. Table 7-1 lists these phases with corresponding clinical signs and treatments.

BASIC OBJECTIVES IN THE TREATMENT OF CARDIOVASCULAR DISEASE

Basic objectives in the treatment of cardiovascular disease include the following (Ettinger, 2000):

- Control rhythm disturbances
- Maintain or increase cardiac output
 - Increase the strength of contraction
 - Decrease the afterload
 - Arteriolar dilator
 - Decrease the preload
 - Venodilator
- Relieve fluid accumulations
 - Diuretics
 - Dietary salt restriction
- Increase the oxygenation of the blood
 - Bronchodilation

- Ancillary treatment
 - Narcotics/sedatives
 - Oxygen

CATEGORIES OF CARDIOVASCULAR DRUGS



Positive Inotropic Drugs

The general principle involved in the use of drugs that improve the strength of contraction is that the heart, even in the presence of disease, has reserve capacity for contraction that can be called on to improve cardiac output. Some clinicians advise cautious use of positive inotropic drugs because these can increase the oxygen demand of cardiac muscle, can potentially damage the contractile apparatus, and can increase the tendency for arrhythmias. Proof of clinical efficacy of positive inotropic drugs is lacking, and their use is controversial (Boothe, 2001). Their popularity has waxed and waned through the years as newer, more effective products have come into use.

Cardiac Glycosides (Digitalis)

The digitalis compounds (digoxin and digitoxin) are obtained from the dried leaves of the plant *Digitalis purpurea*. The beneficial effects of these compounds have been known for hundreds of years and include (1) improved cardiac contractility, (2) decreased heart rate, (3) antiarrhythmic effects, and (4) decreased signs of dyspnea.

Digitalis increases the strength of contraction by increasing the level of calcium ions available in the contractile filaments within cardiac muscle cells. This action occurs as a result of inhibition of sodium-potassium-adenosine triphosphatase (Figure 7-6). The heart rate is slowed by prolonging atrioventricular conduction time and by increasing parasympathetic, autonomic stimulation. The primary actions of the digitalis drugs are to (1) increase the force of contraction, (2) decrease the rate of contraction, and (3) improve baroreceptor function (Hamlin, 2003).

Digitalis use is indicated in patients with cardiac disease that results from impaired cardiac contraction or atrial arrhythmias as suggested by clinical

**FIGURE 7-6**

Effect of digitalis on the sodium-potassium-ATPase pump. Digitalis compounds block the sodium-potassium-ATPase enzyme, reduce the amount of Ca^{2+} pumped out of the cell during repolarization, and increase the amount of Ca^{2+} available for depolarization.

signs such as exercise intolerance, weak peripheral pulses, pulmonary edema, and coughing—or by electrocardiographic diagnosis.

Clinical Uses

Clinical uses of the digitalis compounds include the treatment of CHF, atrial fibrillation, and supraventricular tachycardia.

Dosage Forms

Dosage forms include tablets and elixirs. Veterinary and human label products are available for digoxin, but digitoxin is no longer marketed.

1. Veterinary approved
 - a. Digoxin elixir (Cardoxin LS, 0.05 mg/ml; Cardoxin, 0.15 mg/ml)
 - b. Digitoxin—not available
2. Human approved
 - a. Digoxin for injection (Lanoxin, 0.25 mg/ml or 0.1 mg/ml in ampules and vials)
 - b. Digoxin tablets (Lanoxin, 0.125, 0.25, and 0.5 mg)
 - c. Digoxin capsules (Lanoxicaps, 0.05, 0.1, and 0.2 mg)
 - d. Digoxin elixir (Lanoxin, 0.05 mg/ml, 60-ml bottle)

Adverse Side Effects

Adverse side effects from the use of digitalis compounds are often associated with high or toxic serum levels of drugs and can include anorexia, vomiting, diarrhea, and various arrhythmias. Cats are relatively more sensitive than dogs to toxic effects (Plumb, 2005). Digitalis compounds are

adversely affected when given concurrently with many drugs (cimetidine, metoclopramide, diazepam, anticholinergics, and others). Consult appropriate references for suitability.

Technician's Notes

1. The bioavailability of digoxin varies from 60% in tablet form to 75% in elixir form, and adjustments are probably needed if the dosage form is changed.
2. Clients should be advised to monitor their pets carefully for signs of toxicity and to advise the veterinarian if any arise.

Catecholamines

Catecholamines include a group of sympathomimetic (adrenergic) compounds that (1) increase the force and rate of muscular contraction of the heart (increase in cardiac output), (2) constrict peripheral blood vessels (increase blood pressure), and (3) elevate blood glucose levels. Catecholamines increase cardiac contractility primarily by stimulating beta-1 receptors. Because of their short serum half-lives, catecholamines are used mainly for short-term management of severe heart failure.

EPINEPHRINE

Epinephrine is the preferred drug for providing stimulation for contraction of the heart and for supporting the circulatory system after cardiac arrest. It may be administered by the intracardiac, intratracheal, or intravenous route, and a 1:10,000 solution is preferred. Most products provide a 1:1000 solution. Because epinephrine greatly increases the workload of the heart and increases the tendency for arrhythmias, it is not used for therapy of chronic heart failure.

Clinical Uses

Epinephrine is used in veterinary medicine for cardiac resuscitation and for the treatment of anaphylaxis.

Dosage Forms

Human label forms of epinephrine are used.

1. Epinephrine HCl for injection, 0.1 mg/ml (1:10,000) in 10-ml syringes
2. Epinephrine HCl for injection (Adrenalin Chloride, 1 mg/ml [1:1000] in ampules and vials)

Adverse Side Effects

These include hypertension, arrhythmias, anxiety, and excitability.

Technician's Notes

1. A 1:10,000 solution can be prepared from a 1:1000 solution by mixing 1 ml of the drug with 9 ml of sterile water for injection. Alternatively, 0.5 ml of drug can be mixed with 4.5 ml of sterile water for injection.
2. Epinephrine is stored under refrigeration.

ISOPROTERENOL

Isoproterenol is seldom used in the treatment of cardiac disease. It is indicated in atropine-resistant bradycardia.

DOPAMINE

Dopamine is a biosynthetic precursor of norepinephrine. It stimulates dopaminergic receptors in coronary, mesenteric, renal, and cerebral vascular beds. It also is capable of stimulating alpha- and beta-adrenergic receptors to increase heart contractility, heart rate, and blood pressure. Dopamine use in cardiac cases is mainly limited to heart failure associated with anesthetic emergencies or after cardiac resuscitation.

Clinical Uses

Dopamine is used for adjunctive treatment of acute heart failure and oliguric renal failure and for the supportive treatment of shock.

Dosage Forms

1. Intropin
2. Dopamine HCl
3. Dopamine HCl in 5% dextrose

Adverse Side Effects

These include vomiting, tachycardia, dyspnea, and blood pressure variations (hypotension or hypertension).

DOBUTAMINE

Dobutamine is a synthetic inotropic agent related structurally to dopamine. It causes increased cardiac contractility, as does dopamine, but does not produce dilation of selected vascular beds. Dobutamine is a direct beta-1-adrenergic agent. It produces increased cardiac output with little tendency to cause arrhythmias or increased heart rate. It is available only as a human label product (Dobutrex solution) and is administered in diluted form by intravenous infusion. Consult the *Veterinary Drug Handbook* (Plumb, 2005) for directions on preparation of the solution for infusion.

Bipyridine Derivatives

Amrinone and milrinone are representatives of a new class of positive inotropic drugs that appear to work by inhibiting enzymes that ultimately lead to an increase in cellular calcium. Amrinone (Inocor) is given intravenously and is limited to short-term inpatient use, whereas milrinone is given orally and has potential for long-term use.

Inotropic, Mixed Dilator

PIMOBENDAN

Pimobendan was approved for use in veterinary medicine in April, 2007. It is a positive inotropic drug that increases the calcium sensitivity of cardiac myofilaments and inhibits the enzyme phosphodiesterase.

Clinical Uses

Pimobendan is labeled for the treatment of atrioventricular insufficiency or dilated cardiomyopathy in dogs.

Dosage Form

Vetmedin Chewable Tablets in 1.25, 2.5, or 5 mg sizes

Adverse Side Effects

Side effects may include anorexia, lethargy, diarrhea, and others.

Contraindication

Pimobendan is contraindicated in cases of hypertrophic cardiomyopathy, aortic stenosis, or any other condition when cardiac augmentation is inappropriate for anatomical reasons.



Antiarrhythmic Drugs

An arrhythmia is a variation from the normal rhythm of the heart. Such a variation may result from an abnormality of impulse generation (increased **automaticity**) or from abnormalities of impulse conduction. Many arrhythmias arise when a local group of cells begins to depolarize faster than the sinoatrial node (pacemaker), causing disruption of the normal depolarization pattern of the heart. The location of this group of cells is called an *ectopic focus* (foci if more than one location is involved). Arrhythmias usually result in reduced cardiac output caused by poorly coordinated pumping activity. Some arrhythmias may be auscultated by an experienced ear, but arrhythmias more often are diagnosed through their production of abnormal waveforms seen on an electrocardiogram.

Factors that may cause or predispose the heart to arrhythmias include the following:

1. Conditions that cause hypoxemia
2. Electrolyte imbalances
3. Increased levels of or increased sensitivity to catecholamines
4. Drugs such as digitalis compounds, thiobarbiturates, inhalant anesthetics (halothane), xylazine, and others
5. Cardiac trauma or disease that results in altered cardiac cells

Arrhythmias are classified in relation to heart rate as tachyarrhythmias or bradyarrhythmias. Tachyarrhythmias are further classified into ventricular or atrial, depending on their location, and can lead to rapid contraction rates in corresponding chambers. At these rapid rates, pumping efficiency is greatly reduced because of decreased filling time. Rapid, uncoordinated activity called *flutter* or *fibrillation* may also result.

Pharmacologists classify antiarrhythmic drugs into the following four basic categories (Boothe, 2001):

1. Class IA includes quinidine, procainamide, and others.
Class IB includes lidocaine, tocainide, and mexiletine.
Class IC includes flecainide and encainide.

2. Class II includes the beta-adrenergic blockers (propranolol).
3. Class III includes bretylium and amiodarone.
4. Class IV includes the calcium channel blockers (verapamil, nifedipine, amlodipine, and diltiazem).

Class IA

Drugs in Class IA depress myocardial excitability, prolong the refractory period, decrease automaticity, and increase conduction times. Class IA drugs are used to treat atrial and ventricular arrhythmias and may be given orally on a long-term basis.

QUINIDINE

Quinidine is an alkaloid that is obtained from cinchona plants or is prepared from quinine (Plumb, 2002).

Clinical Uses

Quinidine is used to treat ventricular arrhythmias, ventricular tachycardia, and atrial fibrillation.

Dosage Forms

Human label forms are used.

1. Quinidine sulfate
 - a. Tablets, 200 and 300 mg (Quinora)
 - b. Sustained-release tablets, 300 mg (Quinidex Extentabs)
2. Quinidine gluconate
 - a. Sustained-release tablets (Quinaglute Dura-Tabs [324 mg])
 - b. Injection, 80 mg/ml
3. Quinidine polygalacturonate
 - a. Tablets, 275 mg (Cardioquin)

Adverse Side Effects

These include anorexia, vomiting, diarrhea, weakness, and laminitis (horses).

Technician's Notes

Quinidine doses must be reduced in animals who are being treated concurrently with digoxin.

PROCAINAMIDE

Procainamide is an antiarrhythmic that is chemically related to procaine.

Clinical Uses

Procainamide is used to treat **premature ventricular contractions (PVCs)**, ventricular tachycardia, and some forms of atrial tachycardia.

Dosage Forms

Human label procainamide hydrochloride is used.

1. Injection, 100 mg/ml in 10-ml vials and 500 mg/ml in 2-ml vials (Pronestyl)
2. Tablets or capsules, 250, 375, and 500 mg (Pronestyl)

Adverse Side Effects

These include anorexia, vomiting, diarrhea, hypotension, and others. However, these effects are generally dose related.

Class IB

Drugs in this category exert their influence by stabilizing myocardial cell membranes. By blocking the influx of sodium into the cell, these drugs prevent depolarization and decrease cell automaticity (Figure 7-7). They are used to treat ventricular arrhythmias, but they have not been approved for this use by the U.S. Food and Drug Administration (FDA).

LIDOCAINE

Lidocaine is a local anesthetic and antiarrhythmic. It is prepared only in injectable form and is

administered intravenously. It is used frequently in emergency medicine and acute care.

Clinical Uses

Lidocaine is primarily used for the control of PVCs and for the treatment of ventricular tachycardia.

Dosage Forms

Various veterinary brand name forms are available in 1% and 2% solutions.

Adverse Side Effects

These are rare but may include drowsiness, depression, ataxia, and muscle tremors. Cats are potentially sensitive to the central nervous system effects of lidocaine. These should be monitored carefully when a patient is receiving this drug.

Technician's Notes

When administering lidocaine for an arrhythmia, make certain that it is lidocaine without epinephrine. Epinephrine (a catecholamine) predisposes the heart to arrhythmia.

TOCAINIDE AND MEXILETINE

Tocainide and mexiletine are other class IB agents that may be given orally.

Class IC

Class IC agents are seldom used in veterinary medicine.

Class II

Class II antiarrhythmics are the beta-adrenergic blockers. Propranolol has been the most widely used agent in this class for veterinary therapeutics, although atenolol and other agents are now used as well. Beta blockers may block only beta-1 receptors or only beta-2 receptors (selective), or they may block both types (nonselective). They also are thought to "upregulate" or increase adrenergic receptors to improve cardiac efficiency (Hamlin, 2003). These drugs may be used to treat atrial or ventricular arrhythmias, decrease cardiac conduction, reduce cardiac output, and decrease blood pressure.

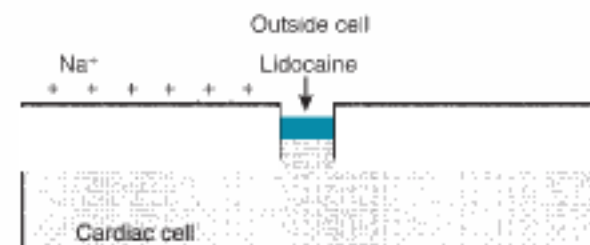
**FIGURE 7-7**

Effect of lidocaine on sodium channels. Lidocaine blocks sodium channels and reduces the automaticity of cardiac cells.

PROPRANOLOL

Propranolol reduces automaticity of cardiac conduction cells by blocking beta-1 and beta-2 receptor sites. Myocardial oxygen demand is reduced by propranolol. Reducing myocardial oxygen demand reduces the tendency for ischemia, in turn reducing automaticity (Williams and Baer, 1990). Propranolol reduces heart rate, cardiac output, and blood pressure. It also may improve cardiac performance in animals with hypertrophic cardiomyopathy.

Clinical Uses

In veterinary medicine, propranolol is used to treat hypertrophic cardiomyopathy and various atrial and ventricular arrhythmias. It is used in cats to treat systemic hypertension and hyperthyroidism (Plumb, 2005).

Dosage Forms

1. Propranolol HCl tablets, 10, 20, 40, 60, 80, and 90 mg (Inderal)
2. Propranolol HCl extended-release capsules, 60, 80, 120, and 160 mg (Inderal LA)
3. Propranolol for injection, 1 mg/ml in 1-ml ampules or vials (Inderal)
4. Propranolol oral solution, 4, 8, and 80 mg/ml concentrate (Intensol)

Adverse Side Effects

These include bradycardia, hypotension, worsening of heart failure, lethargy, bronchospasm, and depression.

Technician's Notes

1. Propranolol is contraindicated in patients with overt heart failure, greater than first-degree heart block, and sinus bradycardia (Plumb, 2005).
2. Do not discontinue therapy abruptly because tachycardia or hypertension may occur.

ATENOLOL

Atenolol is a selective beta-1 blocker (Papich, 2002). Atenolol decreases heart rate, slows cardiac conduction, decreases myocardial oxygen demand,

reduces blood pressure, and diminishes cardiac output. Because of its selective beta-1 effect, atenolol may be safer to use in animals prone to bronchospasm.

Clinical Uses

Atenolol is used in the treatment of supraventricular tachyarrhythmias, premature ventricular contractions, hypertension, and cardiomyopathy.

Dosage Forms

1. Atenolol tablets, 25, 50, and 100 mg (Tenormin)
2. Atenolol injection, 5 mg/ml (Tenormin)
3. Atenolol (Tenormin)
4. Atenolol (Anselol)

Adverse Side Effects

Bradycardia, lethargy and depression, hypotension, syncope, or heart failure is most commonly reported in older animals.

OTHER BETA BLOCKERS

1. Carvedilol (Dilatrend)
2. Sotalol (Betapace, Cardol). Nonselective with action similar to propranolol. This drug is replacing quinidine as the antiarrhythmic drug of choice by some clinicians.
3. Esmolol (Brevibloc). Selective beta-1 blocker for short-term use.
4. Metoprolol (Lopressor, Betaloc). Beta-1 blocker otherwise similar to propranolol.
5. Pindolol (Barbloc)

Class III

The Class III antiarrhythmics bretylium (Bretylol) and amiodarone (Cordarone) are not in common use in veterinary medicine. Some clinicians have reported that Bretylol has promise for treating ventricular fibrillation in the absence of a defibrillation unit. These drugs are used in human medicine to treat ventricular arrhythmias.

Class IV

Class IV antiarrhythmic drugs work by blocking the channels that permit entry of calcium ions through the cardiac cell membrane. This effect causes depression of the contractile mechanism in myocardial and

smooth muscle cells and depresses automaticity and impulse transmission (Williams and Baer, 1990).

VERAPAMIL HYDROCHLORIDE

Verapamil is a channel-blocking agent and is available in oral and injectable forms. It has had limited use in veterinary medicine.

Clinical Uses

Verapamil is used to treat supraventricular tachycardia, atrial flutter, and atrial fibrillation.

Dosage Forms

Human label products are used.

1. Verapamil HCl tablets, 40, 80, and 120 mg (Calan, Isoptin)
2. Verapamil HCl sustained-release tablets, 120, 180, 240, and 360 mg (Calan SR, Isoptin SR)
3. Verapamil HCl for injection, 5 mg/2ml in ampules, vials, and syringes (Isoptin)

Adverse Side Effects

These include hypotension, bradycardia, tachycardia, pulmonary edema, and worsening of CHF.

DILTIAZEM

Diltiazem is a channel-blocking agent that is similar in action to verapamil.

Clinical Uses

Diltiazem is used for supraventricular tachyarrhythmias in dogs and cats and for hypertrophic cardiomyopathy in cats.

Dosage Forms

1. Diltiazem tablets, 30, 60, 90, and 120 mg (Cardizem)
2. Diltiazem oral capsules extended/sustained release, 60, 90, 120, 180, 240, 300, 360, and 420 mg (Cardizem SR, Cardizem CD, Dilacor XR)

Other Class IV Antiarrhythmics

Other channel blockers include nifedipine (Adalat) and amlodipine (Norvasc). These agents are used primarily for the treatment of hypertension rather than as antiarrhythmics.



Vasodilator Drugs

When heart failure occurs, cardiac output is reduced, resulting in hypotension and poor perfusion of tissue. As a reaction to this poor perfusion of tissue, the body activates compensatory mechanisms to increase blood pressure and improve blood supply to tissue. The first compensatory activity is stimulation of the sympathetic nervous system to increase heart rate and to cause constriction of small arteries, which in turn raises blood pressure. Next, the renin-angiotensin system is activated by the release of renin from poorly perfused kidneys (Figure 7-8). Renin causes angiotensinogen to be converted to angiotensin I. Angiotensin I then is converted by angiotensin-converting enzyme (ACE) inhibition to angiotensin II. Angiotensin II causes further vasoconstriction and stimulates the adrenal glands to release aldosterone. Aldosterone acts on the kidney tubules to cause reabsorption of sodium ions and osmotic retention of water. The water that is retained helps to expand the circulating blood volume to improve tissue perfusion.

In the short term, these compensatory mechanisms are beneficial. In the long term, however, they become harmful because the heart must work harder to pump blood through vessels constricted by sympathetic nervous stimulation and by the effects of angiotensin II (increased afterload). The ever-increasing blood volume (increased preload) caused by aldosterone release and water retention also necessitates more strenuous activity by the heart, which in a weakened state initiates the preceding chain of events.

Vasodilator drugs act by dilating arteries (arteriolar dilator), veins (venodilator), or both (combined vasodilator). Dilatory activity may be brought about by direct action on vessel smooth muscle, through blockage of sympathetic stimulation, or by preventing conversion of angiotensin I to angiotensin II. Dilation of constricted arteries tends to decrease afterload and improve cardiac output. Preload is also reduced because of pooling of blood in dilated veins.

Many forms of CHF are improved by the use of vasodilators, which can be used in conjunction with other heart medications.

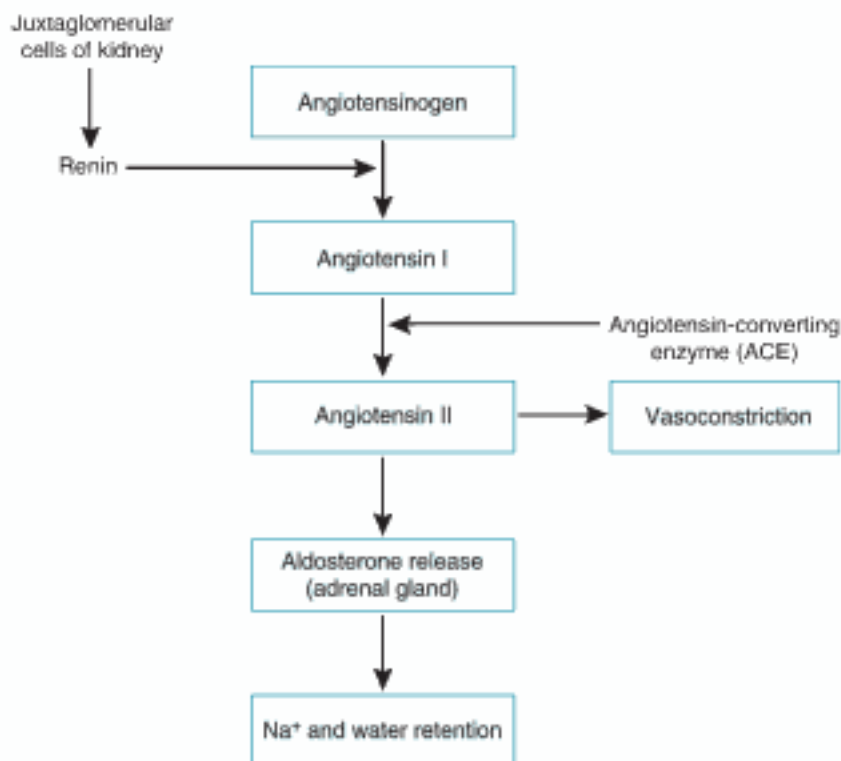

FIGURE 7-8
The renin-angiotensin scheme.

Hydralazine

Hydralazine is primarily an arteriolar dilator. It acts directly on smooth muscle in the arterial wall by interfering with calcium movement and inhibiting the contractile state (Plumb, 2002). The net result is that peripheral resistance is reduced and cardiac output is often greatly improved in animals with CHF. Some clinicians recommend that hydralazine be used with a diuretic because it may activate the renin-angiotensin system and cause water retention (Bill, 2006).

Clinical Uses

Hydralazine is used for afterload reduction associated with CHF, especially CHF caused by mitral valve insufficiency.

Dosage Forms

Human forms are used.

1. Hydralazine HCl tablets, 10, 25, 50, and 100 mg (Apresoline)
2. Hydralazine for injection, 20 mg/ml in ampules or vials (Apresoline)

Adverse Side Effects

Adverse side effects in small animals include hypotension, vomiting, diarrhea, sodium and water retention, and tachycardia.

Nitroglycerin Ointment

Nitroglycerin is primarily a venodilator that reduces preload as the result of pooling of blood in peripheral vessels and decreased venous return to the heart. Some arteriolar dilation may occur at higher doses. Nitroglycerin is applied topically in hairless areas of small animal patients. The medical vehicle of nitroglycerin causes it not to be explosive.

Clinical Uses

In small-animal medicine, nitroglycerin is used as a vasodilator to improve cardiac output and reduce associated pulmonary edema. In equine medicine, nitroglycerin is used as a leg sweat to reduce swelling and to treat laminitis.

Dosage Forms

Human forms, such as nitroglycerin topical ointment, 2% in 20-, 30-, and 60-g tubes (Nitro-Bid, Nitrol), are used.

Adverse Side Effects

Adverse side effects are minimal and may include rashes at the application site and hypotension.

Technician's Notes

1. Gloves should be worn when nitroglycerin is applied.
2. Rotate application sites.
3. Do not pet animals at application sites.
4. The dose is measured in inches by application of a strip of ointment to measuring paper that is supplied with the product.
5. The veterinarian should be contacted if a rash appears at the application site.

Prazosin

Prazosin is a combined vasodilator. It reduces blood pressure and peripheral vasoconstriction by blocking alpha-1-adrenergic receptor sites. Prazosin apparently does not activate the renin-angiotensin system.

Clinical Uses

Prazosin is used for adjunctive treatment of CHF, dilated cardiomyopathy in dogs, systemic hypertension, and pulmonary hypertension.

Dosage Forms

Human forms are used; prazosin capsules, 1, 2, and 5 mg (Minipress).

Adverse Side Effects

These include hypotension, syncope, vomiting, and diarrhea.

Angiotensin-Converting Enzyme Inhibitors

Captopril and enalapril are combined vasodilators that exert their effects on blood vessels by preventing formation of the potent vasoconstrictor angiotensin II. They prevent the conversion of angiotensin I to angiotensin II by inhibiting ACEs. Drugs in this category are sometimes called ACE inhibitors. Both products may be administered with cardiac glycosides and furosemide.

Clinical Uses

ACE inhibitors act as vasodilators in the treatment of Class II, III, and IV heart failure (see Table 7-1).

Dosage Forms

1. Veterinary approved: enalapril tablets, 1, 2.5, 5, 10, and 20 mg (Enacard)
2. Human approved: captopril tablets, 12.5, 25, 50, and 100 mg (Capoten)
3. Human approved: Vasotec tablets, 2.5, 5, 10, and 20 mg
4. Human approved: Vasotec injection for IV use, 1.25 mg/ml

Adverse Side Effects

These include hypotension, azotemia, vomiting, diarrhea, hyperkalemia, and others. The safety of enalapril in breeding dogs has not been established.

Technician's Notes

1. Care should be taken when captopril or enalapril is administered with other vasodilators and certain diuretics because of potential hypotension.
2. Concurrent use of nonsteroidal antiinflammatory drugs may reduce the effectiveness of captopril.
3. Captopril may cause a false-positive urine acetone finding.

**Diuretics**

Diuretics have been some of the most commonly used drugs in the treatment of heart failure because of their ability to promote the reduction of preload

through diuresis. Diuretics reduce the harmful effects of CHF (pulmonary edema, ascites, and increased cardiac work) by reducing plasma volume through various mechanisms.

Many different diuretics are available, and most work by inhibiting reabsorption of sodium and water in the loop of Henle or the distal tubules. If sodium ions remain in the tubules, they exert an increased osmotic “pull” on water molecules to cause them to remain in the tubules and be excreted as urine. The diuretics used most in veterinary medicine include furosemide, the thiazides, and spironolactone.

Furosemide

Furosemide is very powerful and is the most important and efficacious diuretic for removing edema from animals with heart failure (Hamlin, 2003). Furosemide may be administered intravenously, intramuscularly, subcutaneously, or orally and works rapidly to reduce pulmonary edema and other signs of CHF. It causes diuresis by reducing reabsorption of sodium and other electrolytes in the kidney tubules. Because much of the reabsorption occurs in the loop of Henle, furosemide is sometimes called a *loop diuretic*.

Clinical Uses

Furosemide is used for diuretic therapy (in CHF and other conditions) in all species.

Dosage Forms

Injectable and oral (solution, tablet, and bolus) human label products are used.

1. Lasix
 - a. Tablets, 12.5 and 50 mg
 - b. Bolus, 2 g
 - c. Oral solution, 10 mg/ml
 - d. Injection, 5% (50 mg/ml)
2. Furosemide injection, generic 5%
3. Furosemide tablets, generic, 12.5 and 50 mg

Adverse Side Effects

These include low blood potassium (hypokalemia), dehydration, low blood sodium (hyponatremia), ototoxicity (cats), weakness, and shock.

Technician's Notes

1. Furosemide should be administered carefully to animals that are dehydrated or in shock.
2. Furosemide can cause hypokalemia that can increase the chances of digitalis toxicity (anorexia increases the chances of hypokalemia). Potassium supplementation may be required.
3. Animals who are receiving diuretics such as furosemide should always have free access to water.
4. Administer the dose at convenient times for the client because urination follows within 20 to 30 minutes.

Thiazides

Thiazide diuretics such as (chlorothiazide) Diuril act on the loop of Henle and distal tubules to inhibit reabsorption of sodium. Thiazides are seldom used in veterinary medicine.

Spironolactone

Spironolactone is a potassium-sparing diuretic (it does not normally cause hypokalemia) and an antagonist of aldosterone. By inhibiting aldosterone, it reduces the amount of sodium reabsorbed from the kidney tubules. Spironolactone (Aldactone) usually is not used alone but is combined with a loop diuretic or a thiazide (Plumb, 2005). Similar to the thiazides, it has limited use in veterinary medicine.

DIETARY MANAGEMENT OF HEART DISEASE

Dietary management is an important part of the overall treatment of patients with heart disease. Dietary measures often are instituted early in the pathogenesis of heart disease (before clinical signs are observed or drug therapy is begun). Two of the primary goals of dietary management of heart disease are sodium restriction and maintenance of good body weight and condition (reduction of obesity or cachexia). Specific nutrient deficiencies (taurine or carnitine), concurrent disease (chronic renal failure), and electrolyte disorders also may have to be addressed (Roudebush et al, 2000).

Sodium restriction has long been recognized as an important part of the management of CHF. As was previously mentioned, increased sodium levels in the body lead to water retention, increased plasma volume, and exacerbation of the clinical signs of heart failure. The primary source of sodium is food. However, water and treats also must be considered when dietary intake is limited. Prescription diets (Hill's and Purina) provide sodium-restricted nutrition for dogs and cats. These diets may also be restricted in chloride and phosphorus. They may have added taurine and/or carnitine, B-complex vitamins, and normal or added levels of potassium. Sometimes it is difficult to get an animal to accept a sodium-reduced diet because of palatability issues. These foods may be made more palatable by adding flavor enhancers or warming the food.

Because heart failure may impair other internal organs, such as the kidneys, gastrointestinal tract, and liver, cardiac diets should be highly digestible and easily metabolized. They are balanced with adequate (but not excessive) levels of high-biologic-value protein to address potential renal failure. The energy level may need to decrease or increase on the basis of individual animal type and the cardiac condition of the animal. Improvements in cachexia in dogs with congestive failure have been seen with dietary supplementation of fish oils, which are high in omega-3 fatty acids (Ware, 2002).

Technician's Notes

Clients should be instructed not to supplement their pet's diet with treats, human foods, or vitamin-mineral supplements when the animal is receiving a prescription sodium-restricted diet.

ANCILLARY TREATMENT OF HEART FAILURE

Various ancillary drugs and procedures are used in the treatment of heart failure. The following section provides a partial list of these therapies.

Bronchodilators

Bronchodilators such as aminophylline and theophylline are sometimes used in the treatment of heart failure. These agents increase the size of lung passageways to allow more efficient oxygenation of blood, to exert a mild positive inotropic effect on heart muscle, and to obtain a mild diuretic effect.

Oxygen Therapy

Oxygen therapy can be crucial in treating animals in the advanced stages of CHF. Animals with pulmonary edema benefit greatly from the administration of 40% to 50% oxygen via cage, mask, or nasal cannula.

Sedation

Animals with pulmonary edema caused by heart failure often experience a great deal of anxiety because of the dyspnea that they encounter. This anxiety often leads to hyperventilation and even greater oxygen demand and anxiety. To break the cycle and calm the animal, sedative drugs are often administered. The clinician may choose morphine, meperidine, diazepam, or other drugs.

Aspirin

Aspirin is known for its ability to reduce pain and inflammation, fever, and platelet aggregation. It is sometimes used in heart disease when clot formation may be a potential problem. It is used by some veterinarians to reduce the tendency for clot formation in heartworm treatment and for the same purpose in congestive cardiomyopathy in cats.

Thoracocentesis and Abdominocentesis

When heart failure is accompanied by excessive fluid (effusion) in the thoracic cavity, drawing fluid from the cavity may be lifesaving. Removal of ascitic fluid is controversial but may relieve pressure on the diaphragm and improve ventilation.

REFERENCES

- Bill R: Drugs affecting the cardiovascular system. In Barragry TB: Cardiac disease: veterinary drug therapy, Philadelphia, 1994, Lea and Febiger.

- Bill R, editor: Pharmacology for veterinary technicians, ed 3, St. Louis, 2006, Mosby.
- Boorhe DM: Therapy of cardiovascular diseases: small animal clinical pharmacology and therapeutics, Philadelphia, 2001, WB Saunders.
- Ertinger S: Therapy of heart failure. In Ertinger S, editor: Textbook of veterinary internal medicine, ed 5, Philadelphia, 2000, WB Saunders.
- Ganong W: Origin of the heartbeat and the electrical activity of the heart. In Ganong W, editor: Review of medical physiology, ed 21, New York, 2003, McGraw-Hill.
- Hamlin RL: Cardiovascular system, introduction, Proceedings of Music City Veterinary Conference, Nashville, Tenn, 2003.
- Papich MG: Handbook of veterinary drugs, Philadelphia, 2002, WB Saunders.
- Plumb DC: Veterinary drug handbook, ed 5, Ames, Iowa, 2005, Iowa State University Press.
- Roudebush P, Keene BW, Mizelle HL: Cardiovascular disease. In Hand MS, Thatcher CD, Remillard RL, Roudebush PR, editors: Small animal clinical nutrition, ed 4, Topeka, Kan, 2000, Mark Morris Institute.
- Spinelli JS, Enos LR: Drugs for treatment of cardiovascular disorders. In Spinelli JS, Enos LR, editors: Drugs in veterinary practice, St. Louis, 1978, Mosby.
- Upton DW: Cardiovascular system. In Upton DW, editor: Handbook of clinical veterinary pharmacology, ed 3, Manhattan, Kan, 1988, Dan Upton Enterprises.
- Ware WA: Problems in chronic heart failure management, Proceedings of AVMA Annual Conference, Nashville, Tenn, 2002.
- Williams BR, Baer C: Antiarrhythmic agents. In Williams BR, Baer C, editors: Essentials of clinical pharmacology in nursing, Springhouse, Pa, 1990, Springhouse Publishing Co.



REVIEW QUESTIONS

- Why is the heart considered to be two pumps functionally? _____
- Cardiac cells are connected by intercalated disks and a fusion of cell membranes to form a _____.
- Depolarization of cardiac cells is characterized by a rapid influx of _____ ions, a slower influx of _____ ions, and the outflow of _____ ions.
- A relatively long _____ is important to cardiac cells to prevent a constant state of contraction from recycling impulses.
- Define chronotropic and inotropic effects in relation to the heart.

- Define preload and afterload in relation to the pumping mechanism of the heart.

- List the four basic compensatory mechanisms of the cardiovascular system.

- List five objectives of treatment for heart failure.

- List four beneficial effects and one potential toxic effect of the use of the cardiac glycosides.

- Catecholamines such as epinephrine are used in veterinary cardiology primarily for _____.
- List five factors that may predispose the heart to arrhythmias.

- List six categories of antiarrhythmic drugs and give an example of each.

- List four vasodilator drugs and classify each as arteriodilator, venodilator, or mixed.

- Why is Lasix sometimes called a loop diuretic?

- The use of many diuretics can lead to a dangerous loss of what electrolyte?

16. List five ancillary methods of treatment for cardiovascular disease.

17. _____ is characterized by the rapid influx of sodium ions into the cell through channels, the slower influx of calcium ions, and the outflow of potassium ions.
18. The amount of blood that the heart is capable of pumping per minute is called _____.
19. _____ results when the pumping ability of the heart is impaired to the extent that sodium and water are retained in an effort to compensate for inadequate cardiac output.
20. ACE causes the conversion of _____ to _____.
21. Nitroglycerin is supplied as an ointment. List the precautions that should be taken when applying. _____
22. What diuretic is used most commonly in the treatment of heart failure?

23. What is hypokalemia?

24. What are the primary goals of the dietary management of heart disease?

25. List three effects of administration of catecholamines.
1. _____
2. _____
3. _____
26. The heart is a _____-chambered pump that is responsible for moving blood through the vascular system.
a. two
b. four
c. three
d. five
27. _____ is a faster-than-normal heart rate.
a. Bradycardia
b. Arrhythmia
c. Tachycardia
d. Automaticity
28. When situations cause spontaneous depolarization of cardiac muscle or abnormalities of the conduction system, _____ may occur.
a. bradycardia
b. arrhythmia
c. tachycardia
d. automaticity
29. All of the following (except one) are ways by which the cardiovascular system may increase its output during times of need, such as during athletic performance or to compensate for cardiac disease. _____
a. decreasing heart rate to such an extent that the myocardium is protected from damage caused by the increased workload
b. increasing the stroke volume
c. increasing the efficiency of the heart muscle
d. physiologic heart enlargement; the heart is composed of muscle that responds to work by increasing its size and becoming stronger
30. CHF (congestive heart failure) results when the pumping ability of the heart is impaired to the extent that Na and H₂O are retained in an effort to compensate for inadequate cardiac output. It is associated with all of the following, except _____.
a. exercise intolerance
b. pulmonary edema
c. ascites
d. diaphragmatic hernia
31. Digitalis is a (an) _____. It is obtained from the dried leaves of the plant *Digitalis purpurea*.
a. catecholamine drug
b. bipyridine derivative
c. cardiac glycoside
d. antiarrhythmic drug
32. Quinidine is an alkaloid that is obtained from cinchona plants or is prepared from quinine. It is used to treat ventricular arrhythmias, ventricular tachycardia, and atrial fibrillation. Quinidine doses must be _____ in patients who are being treated concurrently with digoxin.
a. decreased
b. increased

33. Gloves do not have to be worn when applying nitroglycerin.
- True
 - False
34. Concurrent use of nonsteroidal antiinflammatory drugs may ____ the effectiveness of captopril.
- increase
 - decrease
35. Furosemide may cause ____ in patients.
- hypoadrenocorticism
 - hypokalemia
 - hypocalcemia
 - hypothyroidism

Locally Acting Emetics

Syrup of Ipecac

ANTIEMETICS

Phenothiazine Derivatives

Chlorpromazine

Prochlorperazine

Procainamide Derivatives: Metoclopramide

Antihistamines

Anticholinergics

Aminopentamide Hydrogen Sulfate

Propantheline

Butyrophenones

Serotonin Receptor Antagonists

NK-1 Receptor Antagonists

ANTIULCER MEDICATIONS

H₂ Receptor Antagonists

Cimetidine

Ranitidine

Famotidine

Nizatidine

Proton Pump Inhibitors

Antacids

Gastrointestinal Protectants

Prostaglandin E-1 Analogs

Diarrhea

ANTIDIARRHEAL MEDICATIONS

Narcotic Analgesics

Anticholinergics/Antispasmodics

Protectants/Absorbents

LAXATIVES

Saline/Hyperosmotic Agents

Bulk-Producing Agents

Lubricants

Surfactants/Stool Softeners

Irritants

GASTROINTESTINAL PROKINETICS/

STIMULANTS

Dopaminergic Antagonists

Serotonergic Drugs

Motilin-like Drugs

Direct Cholinergics

Acetylcholinesterase Inhibitors

DIGESTIVE ENZYMES

MISCELLANEOUS GASTROINTESTINAL

DRUGS

Antibiotics

Metronidazole

Antiinflammatory Agents

Antifoaming Agents

Weight-Loss Products

Duloxetine

Probiotics

Appetite Stimulants

ORAL PRODUCTS

Dentifrice and Cleansing Products

Fluoride Products

Perioceutic Agents

Doxinabe

Bioactive Ceramic Agent

Polishing Paste

Disclosing Solution

CHAPTER 8

Drugs Used in Gastrointestinal System Disorders

LEARNING OBJECTIVES

After studying this chapter, you should be able to:

1. Exhibit a basic understanding of the anatomy and physiology of the gastrointestinal (GI) system.
2. Describe the various mechanisms of control of the GI system.
3. Explain the difference between vomiting and diarrhea.
4. Exhibit a working knowledge of drugs that induce vomiting and those that inhibit it.
5. List and describe antiulcer medications used in veterinary medicine.
6. Explain the pathophysiology of diarrhea and list the medications used to control this condition.
7. List the different categories of laxatives and explain their respective mechanisms of action.
8. List the two basic categories of GI prokinetics and stimulants.
9. Explain why digestive enzymes are used.
10. Discuss the use of antibiotics and antiinflammatory agents in GI disease.
11. List the categories of oral products and give an example from each category.



KEY TERMS

ADSORBENT A drug that inhibits GI absorption of drugs, toxins, or chemicals by attracting and holding them to its surface.

ANTICHOLINERGIC Blocking nerve impulse transmission through the parasympathetic nervous system; also called *parasympatholytic*. Anticholinergic drugs may be used for the treatment of diarrhea or vomiting.

CHEMORECEPTOR TRIGGER ZONE (CRTZ) An area in the brain that activates the vomiting center when stimulated by toxic substances in the blood.

CHOLINERGIC Activated by or transmitted through acetylcholine; also called *parasympathomimetic*. Cholinergic drugs increase activity in the GI tract.

DENTIFRICE A preparation for cleansing teeth that is available in a powder, paste, or liquid.

EMESIS The act of vomiting.

HEMATEMESIS Vomiting of blood (the vomitus often resembles coffee grounds).

MELENA Dark or black stools that result from blood staining. Bleeding has occurred in the anterior part of the GI tract.

MOTILIN A hormone secreted by cells in the duodenal mucosa that causes contraction of intestinal smooth muscle.

PARIETAL CELL A cell located in the gastric mucosa that secretes hydrochloric acid.

PERISTALSIS A wave of smooth muscle contraction that passes along a tubular structure (GI or other) and moves the contents of that structure forward.

REGURGITATION Casting up of undigested or semidigested (ruminant) foodstuff from the esophagus or rumen.

SEGMENTATION Periodic constriction of segments of the intestine without movement backward or forward; a mixing rather than a propulsive movement.

VOMITING CENTER An area in the medulla that may be stimulated by the CRTZ, the cerebrum, or peripheral receptors to induce vomiting.

INTRODUCTION

Problems of the gastrointestinal (GI) system are common reasons for visits to a veterinary practice. These problems include **regurgitation**, vomiting, diarrhea, weight loss, colic, bloat, flatulence, abnormal stools, and constipation. Because veterinary technicians are expected to answer clients' questions about the GI tract, administer therapeutic GI medications, and monitor the response to GI medications, they must be knowledgeable about this system. They should have a basic knowledge of GI anatomy, physiology, pathophysiology, therapeutic principles, and medications.

ANATOMY AND PHYSIOLOGY

Anatomic and physiologic differences between the GI systems of different animal species are greater than for any other organ system (Bill, 2006). Despite these differences, the functions are basically the same in each species: (1) intake of food and

fluid into the body, (2) absorption of nutrients and fluid, and (3) excretion of waste products. A discussion of the anatomy and physiology of the GI tract with an emphasis on similarities and differences between species follows.

The basic structures of the GI tract include (depending on the species) the mouth, teeth, tongue, salivary glands, esophagus, outpocketings of the esophagus (crop, reticulum, rumen, and omasum), stomach, liver, pancreas, duodenum, jejunum, ileum, cecum, colon, rectum, and anus.

Carnivorous or omnivorous species (cats, dogs, and primates) often are described as monogastric or simple-stomach animals because they have no outpocketings or forestomachs arising from the basic configuration (Figure 8-1). The function of the stomach in these monogastric animals is primarily to store ingested material and to begin some enzymatic breakdown of protein. The salivary glands begin enzymatic digestion by producing enzymes that break down starch into simpler carbohydrates. Pancreatic enzymes delivered to the duodenum break down fats, carbohydrates, and proteins, and

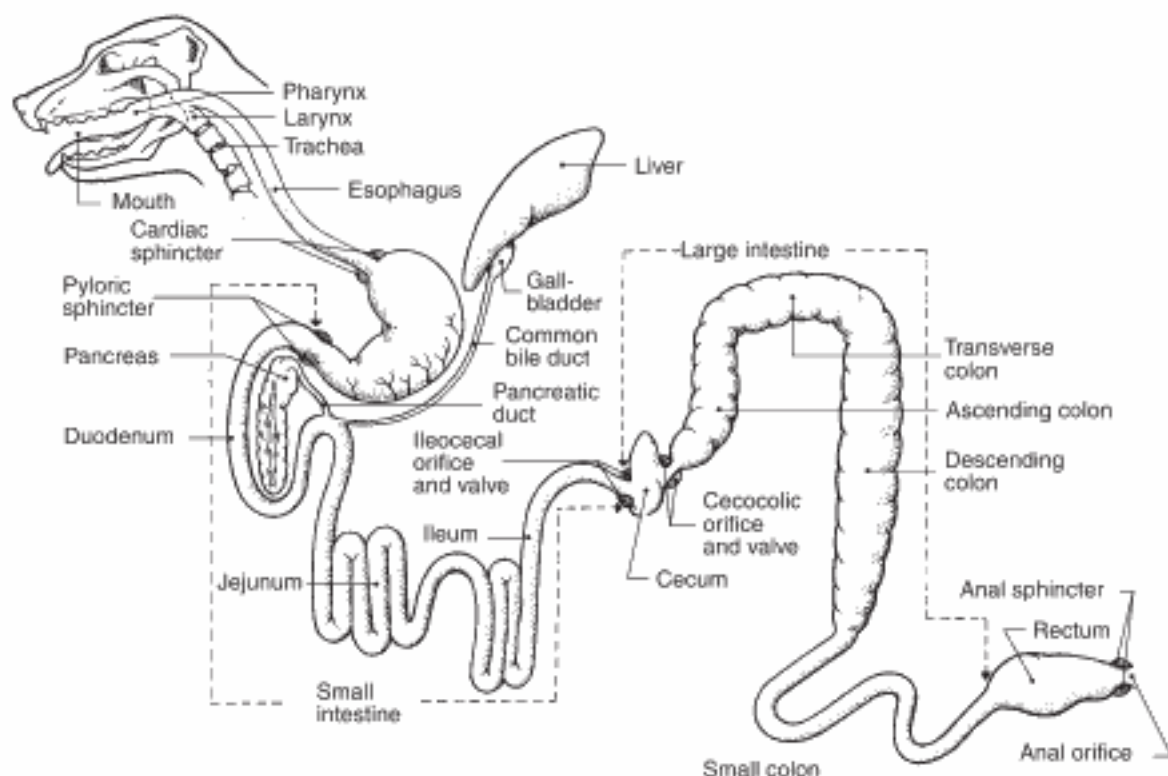

FIGURE 8-1
The monogastric gastrointestinal system.

sodium bicarbonate from the pancreas neutralizes hydrochloric acid from the stomach. Bile salts, produced in the liver and delivered to the duodenum, aid in digestion by emulsifying fats. Bile is stored in the gallbladder, which is absent in some animals (horses and rats). Digestion and its control mechanisms are complex, and students should consult an appropriate text for further information.

Ruminant animals are herbivorous and have a GI system characterized by three forestomachs, the reticulum, rumen, omasum, and a “true” stomach—the abomasum (Figure 8-2). The reticulum receives ingested material and passes it to the rumen, where it is mixed and acted on by microorganisms to digest cellulose and other coarse plant material (roughage). Some refer to the rumen as a “fermentation vat,” where microorganisms break down coarse feeds into forms that can be used by the simple stomach portion of the GI system in ruminants. Partially digested material (cud) in the

rumen is regurgitated and remasticated to further facilitate digestion. In an immature ruminant, an esophageal groove allows milk to bypass the rumen and flow directly into the abomasum, and the rumen gains full function only after several months.

Equines, rabbits, and some rodents are chiefly herbivorous animals that have a monogastric GI configuration. They possess, however, a large cecum, which is capable of limited roughage digestion (hindgut fermentation) (Figure 8-3).

Birds have an outpocketing of the esophagus called the *crop*, which is used for food storage. They also have a ventriculus, or gizzard, which serves to grind coarse food material (Figure 8-4).

The small intestine comprises three sections: the duodenum, which has a sharp bend and in which the pancreas is located; the long and highly coiled jejunum; and the short ileum, which connects to the large intestine. In the small intestine, contents

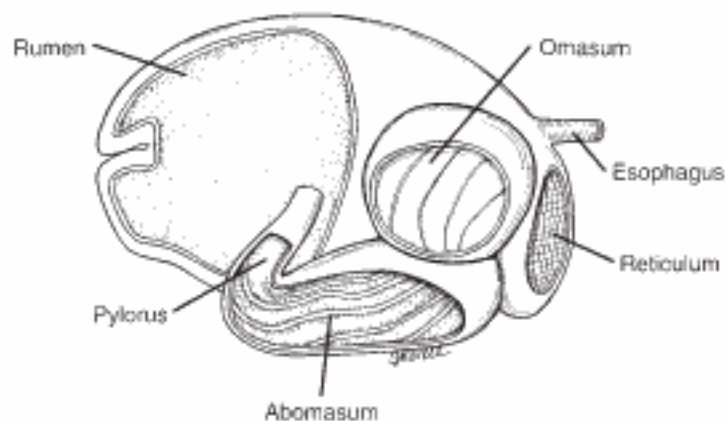

FIGURE 8-2
Compartments of the ruminant forestomach.

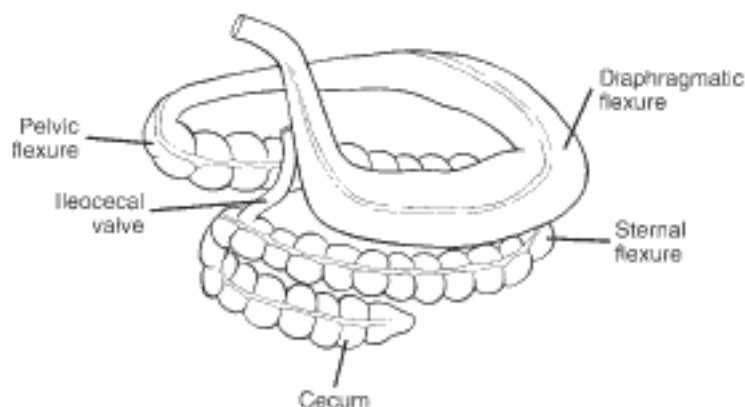

FIGURE 8-3
The large intestine of a horse.

passing from the stomach are mixed with intestinal secretions, pancreatic juice, and bile. The digestive process that began in the mouth and stomach is completed in the small intestine. Products of this process are absorbed together with most of the vitamins and a great deal of fluid. Villi and microvilli protrude from the mucosal surface into the lumen of the small intestine and greatly enhance the absorptive process.

Movements of the small intestine mix the intestinal contents, called *chyme*, and move them toward the large intestine. Normal intestinal motility includes two different patterns—peristalsis and segmentation (Figure 8-5). **Peristalsis** is a wave of

contractions that propels contents along the digestive tract. **Segmentation** is a periodic, repeating pattern of intestinal constrictions that serves to mix and churn the contents.

The colon has a considerably larger diameter than the small intestine. The colon is connected to the ileum and the cecum through the ileocecal valve. The surface of the colon may exhibit one or more longitudinal bands (depending on the species) called *teniae*. The wall of the colon may also form outpocketings, called *haustra*. The colon of monogastric animals has an ascending portion, a transverse portion, and a descending portion that leads into the rectum. Functions of the colon

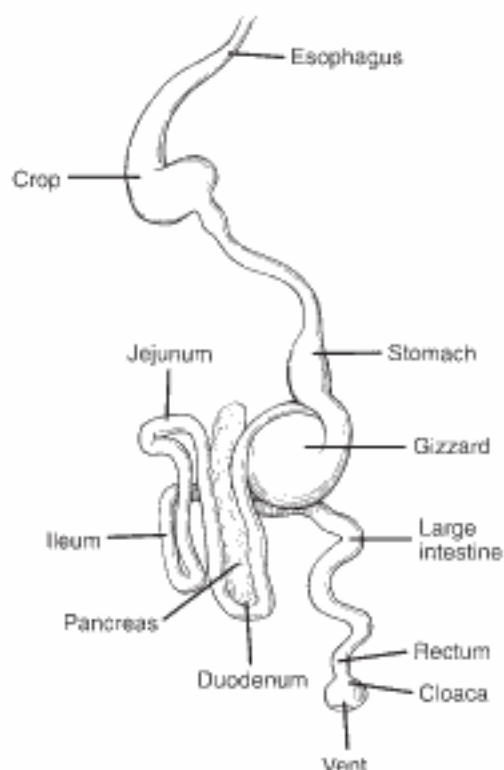

FIGURE 8-4
The digestive system of a bird.



1. A section of intestine exhibiting no activity



2. Segmental contractions



3. Peristaltic

FIGURE 8-5
Peristalsis and segmentation.

include absorption of water, synthesis of certain vitamins, and storage of waste material.

Movements of the colon include peristalsis and segmentation (as in the small intestine), as well as a third type called *mass action contraction* (Ganong, 2003). Mass action contraction is a result of simultaneous contraction of smooth muscle over a large area and serves to move fecal material from one portion of the colon to another and from the colon into the rectum.

REGULATION OF THE GASTROINTESTINAL SYSTEM

Regulation of GI system activity is complex but can be said to be under the influence of the following three basic control systems:

1. The autonomic nervous system (ANS).
 - a. Stimulation of the parasympathetic portion of the ANS increases intestinal motility and tone, increases intestinal secretions, and stimulates relaxation of sphincters. Drugs that mimic parasympathetic stimulation (cholinergic or parasympathomimetic) cause similar results. Anticholinergic, or parasympatholytic, drugs inhibit these ANS actions.
 - b. Stimulation of the sympathetic branch of the ANS decreases intestinal motility and tone, decreases intestinal secretions, and inhibits sphincters.
 - c. Stimulation of various intrinsic receptors in the GI tract, such as the myenteric plexus (stretch receptor), also may increase peristaltic activity. Some physiologists consider the intrinsic receptors (myenteric plexus and Meissner's plexus) to be a third portion of the ANS called the *enteric nervous system* (Ganong, 2003).
2. GI hormones such as gastrin, secretin, and cholecystokinin, when released from intestinal cells, exert control over many functions such as gastric secretion, emptying of the gallbladder, and gastric emptying.

3. Substances such as histamine, serotonin, and prostaglandin are released from specialized cells of the GI tract. Histamine attaches to H_2 receptors in gastric parietal cells to cause increased release of hydrochloric acid in the stomach. The influences of serotonin and prostaglandin are not as well defined.

Another factor that can have a major influence on GI activity is the presence of bacterial endotoxins. Endotoxins are components of the bacterial cell wall of certain bacteria (often gram-negative bacteria) that may increase the permeability of intestinal blood vessels and cause increased fluid loss and fever.

VOMITING

Vomiting is forceful ejection of the contents of the stomach, and sometimes the contents of the proximal small intestine, through the mouth. Vomiting is initiated by activation of the vomiting (emetic) center in the medulla of the brain. The **vomiting center** is connected by nerve pathways to the **chemoreceptor trigger zone (CRTZ)**, the cerebral cortex, and peripheral receptors in the pharynx, GI tract, urinary system, and heart. Impulses from any of these areas activate the vomiting reflex; this requires a coordinated effort of the GI, musculoskeletal, respiratory, and nervous systems (Figure 8-6). Impulses may be generated by (1) pain, excitement, or fear (cortex); (2) disturbances of the inner ear (CRTZ); (3) drugs such as apomorphine and digoxin (CRTZ); (4) metabolic conditions such as uremia, ketonemia, or endotoxemia (CRTZ); and (5) irritation of peripheral receptors.

Occasional vomiting by a dog or cat is considered normal. However, persistent vomiting is not normal. Horses and rats do not normally vomit. Persistent vomiting can cause serious problems such as resultant dehydration, electrolyte disturbances, and acid-base imbalances. Sizable quantities of sodium, potassium, and chloride are lost in vomit. However, potassium loss is usually the most significant abnormality.

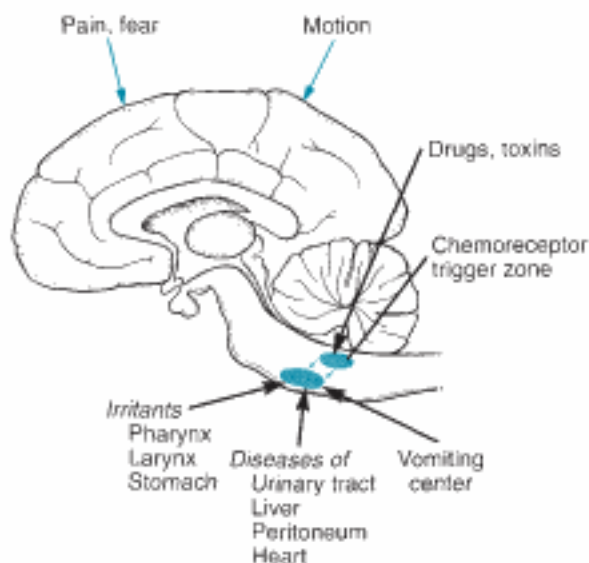

FIGURE 8-6

The vomiting center/chemoreceptor trigger zone.

Emetics

Emetics are drugs that induce vomiting. Emetics are administered to animals that have ingested toxins, but they must be used carefully to avoid serious complications. Emetics should not be used in animals that (1) are comatose or are having a seizure; (2) have depressed pharyngeal reflexes; (3) are in shock or dyspnea; or (4) have ingested strong acid, alkali, or other caustic substances. Obviously, emetics should not be given to animals that do not normally vomit, such as rabbits, some rodents, and horses. Emetics usually remove about 80% of the stomach contents. Therefore, the animal should be closely monitored for signs of toxicity after induced vomiting (Plumb, 2005).

Emetics are classified according to their site of action. Those acting on the CRTZ are categorized as centrally acting, and those that act on peripheral receptors are locally acting.

Centrally Acting Emetics

APOMORPHINE

Apomorphine is a morphine derivative that stimulates dopamine receptors in the CRTZ, which then activates the vomiting center. This drug

is poorly absorbed after oral administration and is therefore usually administered topically in the conjunctival sac or parenterally. Vomiting follows rapidly after intravenous administration, 5 to 10 minutes after intramuscular injection, and variably (10 to 20 minutes) after conjunctival administration.

Clinical Uses

Apomorphine is used primarily for induction of vomiting in dogs. It is considered by many to be the emetic of choice for dogs. Its use in cats is controversial and possibly is contraindicated. Xylazine, which is safer than apomorphine, is effective as an emetic in most cats.

Dosage Form

Apomorphine HCl soluble tablets, 6 mg (human label), are commonly used. Apomorphine is a Class II controlled substance.

Adverse Side Effects

These include protracted vomiting, restlessness, and depression.

Technician's Notes

1. Whole or divided apomorphine tablets may be placed in the conjunctival sac of the eye. These tablets or portions can also be crushed or dissolved in saline and placed in the conjunctiva. Once vomiting has occurred, the remaining apomorphine should be rinsed out of the conjunctiva to prevent protracted vomiting.
2. Naloxone may be used to treat an overdose or toxicity.
3. Intravenous cephalozin may cause vomiting.

XYLAZINE

Although xylazine is not classified as an emetic, the label indicates that it induces vomiting within 3 to 5 minutes in cats and occasionally in dogs. Some clinicians consider xylazine to be the agent of choice for inducing vomiting in cats. Normal precautions should be followed regarding administration of this product.

Locally Acting Emetics

Syrup of ipecac is the primary agent. Other locally acting emetics that have been used with various degrees of effectiveness include mustard and water, hydrogen peroxide, and warm salt water.

SYRUP OF IPECAC

Ipecac, which is obtained from plant roots, contains alkaloids that irritate the gastric mucosa and induce vomiting within 10 to 30 minutes. Stimulation of the CRTZ is also thought to occur. This agent may be used in dogs and cats. Some veterinarians question the efficacy of this emetic.

Clinical Uses

Ipecac is used to induce emesis in dogs and cats.

Dosage Form

Ipecac oral syrup in 15- and 30-ml, pint, and gallon bottles (generic) is an over-the-counter product.

Adverse Side Effects

These include cardiotoxicity (high doses), lacrimation, and salivation.

Technician's Notes

1. Ipecac should be administered with caution to animals with an existing heart condition. It is a cardiotoxic drug when given in high doses.
2. Extract of ipecac should never be substituted for syrup of ipecac because it is several times more potent than the syrup.



Antiemetics

Antiemetics are drugs that are used to prevent or control vomiting. The use of antiemetics is a form of symptomatic treatment because these drugs do not necessarily correct the underlying cause of the vomiting. Many cases of vomiting in small animals are self-limiting or can be controlled by withholding food and water for 24 to 48 hours. Other cases are more difficult to control and necessitate the use of antiemetic agents and careful attention to determining the underlying

cause. Antiemetics usually are given parenterally because vomiting precludes use of the oral route.

Phenothiazine Derivatives

Phenothiazine derivative antiemetics act centrally by blocking dopamine receptors in the CRTZ and possibly by direct inhibition of the vomiting center. These agents are in widespread use. They are very useful in preventing motion sickness in dogs and cats but may be less effective against irritant emetics (Upson, 1988). Common side effects include hypotension and sedation.

CHLORPROMAZINE

Chlorpromazine is a phenothiazine derivative tranquilizer that has little popularity as a tranquilizer in veterinary medicine and is more often used as an antiemetic.

Clinical Uses

Chlorpromazine is used as an antiemetic in dogs and cats. It is more effective in dogs than in cats.

Dosage Forms

1. Chlorpromazine tablets (Thorazine), various sizes
2. Chlorpromazine extended-release capsules (Thorazine Spansule), various sizes
3. Chlorpromazine oral solution (Thorazine), 2 mg/ml, 30 mg/ml, and 100 mg/ml
4. Rectal suppositories (Thorazine), 25 mg and 100 mg
5. Chlorpromazine injection (Thorazine), 25 mg/ml in ampules and vials

Adverse Side Effects

These are primarily limited to sedation, ataxia, and hypotension.

Technician's Notes

1. Chlorpromazine is incompatible when mixed with several other injectable agents. Check the label before administering.
2. Chlorpromazine may interact adversely when given concurrently with several other drugs. Read the label before administering to determine whether the combination is compatible.

PROCHLORPERAZINE

Prochlorperazine is a phenothiazine derivative agent with moderate sedative effects and strong antiemetic effects. The approved form of this drug is a combination product that contains an **anticholinergic** agent (Darbazine). Prochlorperazine is available singly as Compazine (human label).

Clinical Uses

These include control of vomiting (prochlorperazine alone) in dogs and cats and treatment of vomiting, gastroenteritis, diarrhea, spastic colitis, and motion sickness (combination product).

Dosage Forms

1. Prochlorperazine—injection, oral syrup, sustained-release capsules, and suppositories (Compazine)
2. Prochlorperazine/isopropamide—injectable and capsule (Darbazine)

Adverse Side Effects

These are similar to those of chlorpromazine but may also include dry mucous membranes, dilated pupils, and urinary retention caused by the effects of the anticholinergic in the combination product.

Procainamide Derivatives: Metoclopramide

Metoclopramide is a derivative of procainamide that has central and peripheral antiemetic activities. Centrally, it blocks dopamine receptors in the CRTZ, whereas peripherally, it increases gastric contraction, speeds gastric emptying, and strengthens cardiac sphincter tone. Metoclopramide has a limited influence on GI secretions. This drug has a short half-life and may have to be administered often or in a continuous drip in severe cases of vomiting (Plumb, 2005).

Clinical Uses

1. As an antiemetic (especially for parvoviral enteritis, uremic vomiting, and vomiting associated with chemotherapy)
2. For the treatment of gastric motility disorders

Dosage Forms

1. Metoclopramide HCl tablets (Reglan), 5 and 10 mg

2. Metoclopramide HCl oral solution (Reglan),
1 mg/ml in containers of various sizes
3. Metoclopramide HCl injection (Reglan),
5 mg/ml

Adverse Side Effects

The most common side effects in horses, dogs, and cats are behavioral or other disorders associated with the central nervous system (CNS). Constipation also may occur.

Technician's Notes

1. Reglan is contraindicated if GI obstruction is suspected.
2. Atropine and the opioid analgesics may antagonize the actions of metoclopramide.

Antihistamines

Antihistamines are most effective as antiemetics in dogs and cats when vomiting is a result of motion sickness or inner ear abnormalities. Antihistamines block vomiting at the level of the CRTZ. All antihistamines may cause sedation.

Dosage Forms

1. Trimethobenzamide HCl (Tigan). Trimethobenzamide is an antiemetic for use in dogs only.
2. Dimenhydrinate (Dramamine). Dimenhydrinate is an antihistamine labeled for treatment of motion sickness in dogs and cats. It is available in tablet, liquid, and injectable forms.
3. Diphenhydramine (Benadryl). Diphenhydramine is used in veterinary medicine as an antiemetic and for the treatment of motion sickness, pruritus, and allergic reactions. It is available in tablet, capsule, oral elixir, and injectable forms.
4. Meclizine (Antivert). Meclizine is used mainly in small animals for the treatment of motion sickness.
5. Promethazine (Phenergan)

Anticholinergics

Anticholinergic or parasympatholytic drugs block the effects of acetylcholine at parasympathetic nerve endings. The result is reduced GI spasms,

intestinal motility, and intestinal secretions. These drugs act peripherally—except for atropine sulfate and aminopentamide, which have some capacity to cross the blood-brain barrier and block the CRTZ. Many clinicians believe that these drugs have a limited ability to reduce vomiting. Gastric emptying is slowed by anticholinergics, which may actually increase the tendency for vomiting.

AMINOPENTAMIDE HYDROGEN SULFATE

Aminopentamide is an anticholinergic, antispasmodic agent for use in dogs and cats.

Clinical Uses

These include the treatment of acute abdominal spasm and associated nausea, vomiting, and diarrhea.

Dosage Forms

1. Aminopentamide hydrogen sulfate tablets (Centrine), 0.2 mg
2. Aminopentamide hydrogen sulfate injection (Centrine), 0.5 mg/ml, 10-ml vials

Adverse Side Effects

These include dry mucous membranes and urinary retention.

PROPANTHELINE

Propantheline is a quaternary ammonium compound with anticholinergic activity similar to that of atropine.

Clinical Uses

The antispasmodic and antisecretory activities of propantheline are useful in the treatment of vomiting and diarrhea.

Dosage Form

Propantheline bromide tablets, 7.5 and 15 mg (Pro-Banthine)

Adverse Side Effects

These are similar to those of atropine and include dry mucous membranes, tachycardia, urinary retention, and constipation.

Butyrophenones

The butyrophenones are a group of tranquilizers that are capable of blocking the CRTZ and the vomiting center. These drugs are relatively effective antiemetics but are seldom used for this purpose in veterinary medicine. Domperidone has been used in Europe but has seldom been used as an antiemetic in the United States.

Dosage Forms

1. Droperidol/fentanyl (Innovar-Vet)
2. Haloperidol (Haldol)
3. Pimozide (Orap)

Serotonin Receptor Antagonists

Serotonin receptors are found on vagal nerve terminals and in the CRTZ (Plumb, 2005). Blockade of these receptors consists of antiemetic activity.

Dosage Form

Ondansetron (Zofran). Zofran is used mainly as an antiemetic during chemotherapy and is noted for its special effectiveness during this application.

NK-1 Receptor Antagonists

NK-1 antagonists block the binding of substance P (a neurotransmitter involved in vomiting) to NK-1 receptors in the CRTZ.

Clinical Uses

Uses include the prevention and treatment of vomiting in dogs caused by motion sickness or other causes.

Dosage Form

Maropitant citrate (CERENIA) tablets in 16, 24, 60, or 160 mg. Injection in 10 mg/ml.

Adverse Side Effects

Side effects noted in a field study included diarrhea, bloody stool, anorexia, endotoxic shock, and otitis.



Ant ulcer Medications

Gastric ulcers may occur in animals for various reasons, including stress, metabolic disease, gastric hyperacidity, and drug therapy (corticosteroids or

nonsteroidal antiinflammatory agents) (Hall, 2001). Anorexia, **hematemesis**, pain, and **melena** are common signs of gastric ulcer. Most cases of gastric ulceration involve increased gastric acid production and require treatment of the underlying cause and symptomatic therapy. Five classes of drugs are most commonly used to treat gastric ulcers: (1) H₂ receptor antagonists, (2) proton pump inhibitors, (3) antacids, (4) gastromucosal protectants, and (5) prostaglandin E-1 analogs.

H₂ Receptor Antagonists

One of the primary stimuli for secretion of hydrochloric acid by gastric **parietal cells** is activation of H₂ receptors by histamine. By blocking H₂ receptors, H₂ receptor antagonists reduce the release of hydrochloric acid, thus decreasing irritation of the eroded mucosa and promoting healing (Figure 8-7). H₂ blockers in current use include cimetidine, ranitidine, famotidine, and nizatidine. These are all available as over-the-counter products.

CIMETIDINE

Cimetidine competitively inhibits histamine at H₂ receptors of gastric parietal cells, thereby reducing hydrochloric acid secretion by these cells. Cimetidine, the least potent of the H₂ receptors, must be given 3 to 4 times daily to be effective (DeNovo, 2002).

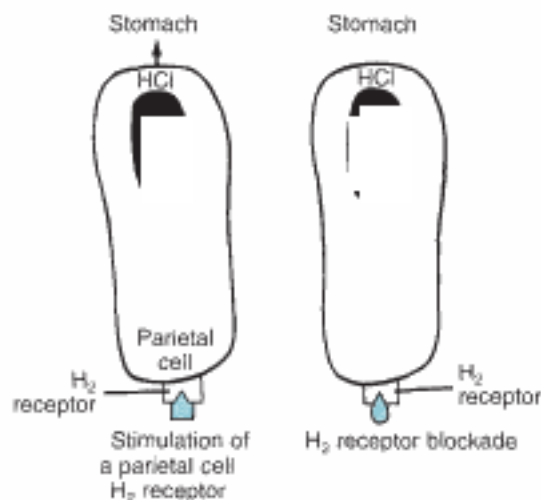

FIGURE 8-7 H₂ receptor blockade (parietal cell). HCl, Hydrochloric acid.

Clinical Uses

Cimetidine is used for the treatment or prevention of gastric, abomasal, or duodenal ulcers; hypersecretory conditions of the stomach; esophagitis; gastric reflux; and experimentally as an immunomodulator.

Dosage Forms

Products approved for use in humans are also used in animals.

1. Cimetidine tablets (Tagamet), 100, 200, 300, 400, and 800 mg
2. Cimetidine oral solution (Tagamet), 60 mg/ml
3. Cimetidine HCl for injection (Tagamet)

Adverse Side Effects

These are rare in animals; however, cimetidine does inhibit microsomal enzymes in the liver and thus may alter the rate of metabolism of other drugs.

Technician's Notes

1. Because of its inhibition of liver microsomal enzymes, cimetidine may prolong the effects of drugs that are highly metabolized by the liver (lidocaine, propranolol, metronidazole, diazepam, and others). References should be checked before cimetidine is used in combination with other drugs.
2. If cimetidine is used with antacids, metoclopramide, digoxin, sucralfate, or ketoconazole, doses should be separated by at least 2 hours.

RANITIDINE

Ranitidine is also an H₂ receptor antagonist that competitively inhibits histamine at parietal cell receptors and reduces hydrochloric acid secretion. Ranitidine has little effect on hepatic microenzymes and is unlikely to cause drug interactions. Ranitidine is the H₂ receptor antagonist that is preferred by many clinicians because of its greater potency (five times that of cimetidine) and duration of action. Ranitidine also has prokinetic activity in that it promotes gastric emptying (DeNovo, 2002).

Clinical Uses

Clinical uses are identical to those of cimetidine.

Dosage Forms

1. Ranitidine HCl tablets (Zantac), 75, 150, and 300 mg
2. Ranitidine HCl oral syrup (Zantac), 15 mg/ml
3. Ranitidine injection (Zantac), 25 mg/ml

Adverse Side Effects

Adverse side effects are rare in animals.

Technician's Notes

A practical advantage of ranitidine over cimetidine is its reduced frequency of dosing (twice a day rather than three or four times daily).

FAMOTIDINE

Famotidine is an H₂ receptor antagonist that is considerably more potent than cimetidine. It is administered once a day and may have fewer drug interactions than cimetidine or ranitidine.

Clinical Uses

Clinical uses are similar to those of cimetidine and ranitidine.

Dosage Forms

1. Famotidine film-coated tablets (Pepcid or Pepcid AC), 10, 20, and 40 mg
2. Famotidine oral powder (Pepcid)
3. Famotidine injection (Pepcid IV)

Adverse Side Effects

Because of limited use, side effects have not been determined.

NIZATIDINE

Nizatidine is an H₂ receptor antagonist that also has prokinetic activity, similar to ranitidine.

Clinical Uses

Even though nizatidine is an H₂ receptor blocker, it is used primarily in small-animal medicine as a prokinetic agent for the treatment of constipation and delayed gastric emptying (Plumb, 2002).

Dosage Forms

1. Axid tablets
2. Axid capsules

Proton Pump Inhibitors

Omeprazole and lansoprazole are benzimidazoles that act as proton pump inhibitors. These agents bind irreversibly at the secretory surface of the parietal cell to the enzyme Na-K-ATPase. This enzyme is responsible for “pumping” hydrogen ions into the stomach against a concentration gradient. When bound in this way, the enzyme is inactivated and the cell is unable to secrete acid until a new enzyme is synthesized.

Clinical Uses

These agents are used to treat gastric or duodenal ulcer and esophagitis and may be useful in treating parietal hypersecretion associated with gastrinoma and mastocytosis (DeNovo, 2002). Omeprazole has a veterinary-approved label for the treatment and prevention of recurrence of gastric ulcers in horses and foals (Foushee, 2000).

Dosage Forms

1. Omeprazole oral sustained-release capsules (Prilosec), 10 and 20 mg
2. Omeprazole (Losec) (Canada)
3. Omeprazole Oral Paste
4. Gastrogard (Equine product)
5. Lansoprazole (Prevacid)

Adverse Side Effects

These include constipation, sedation, ileus, pancreatitis, and CNS effects.

Antacids

Antacids used in veterinary medicine are (relatively) nonabsorbable salts of aluminium, calcium, or magnesium. Antacids are used to decrease hydrochloric acid levels in the stomach as an aid in the treatment of gastric ulcers. In ruminants, antacids such as magnesium hydroxide are used to treat rumen acidosis (rumen overload syndrome) and are used as a laxative. Antacids also may be used in patients with renal failure to bind with (chelate) intestinal phosphorus and reduce hyperphosphatemia.

Clinical Uses

These include treatment of gastric ulcer, gastritis, esophagitis, and hyperphosphatemia in small animals. In ruminants, they are used to treat rumen overload.

Dosage Forms

1. Human label
 - a. Aluminum/magnesium hydroxide (Maalox, Mylanta, WinGel)
 - b. Aluminum carbonate (Basaljel)
 - c. Aluminum hydroxide (Amphojel)
 - d. Magnesium hydroxide (milk of magnesia)
2. Veterinary label: magnesium hydroxide (Magnalax, Rulax II)

Adverse Side Effects

Adverse side effects in monogastric animals include constipation (with aluminium- and calcium-containing products) and diarrhea (with magnesium-containing products).

Technician's Notes

1. Generally, do not give oral antacids within 1 to 2 hours of other oral medications because of their ability to decrease the absorption of drugs such as tetracycline, cimetidine, ranitidine, digoxin, captopril, corticosteroids, and ketoconazole.
2. Magnesium-containing antacids are contraindicated in animals with renal disease.

Gastromucosal Protectants

Sucralfate is the only gastromucosal protectant in common use in veterinary medicine. This drug is a disaccharide that, when administered orally, forms a paste-like substance in the stomach that binds to the surfaces of gastric ulcers. This paste-like material forms a barrier over the ulcer to protect it from further damage and to promote healing. Because sucralfate binds better to ulcers in an acidic environment, it should be administered 30 minutes to 1 hour before H₂ receptor antagonists are given. It also may reduce the availability of some other drugs.

Clinical Uses

Sucralfate is used in the treatment of oral, esophageal, gastric, and duodenal ulcers.

Dosage Form

Sucralfate (Carafate), 1-g tablets

Adverse Side Effects

These usually are limited to constipation. However, drug interactions may be notable.

Technician's Notes

1. Sucralfate should be given 2 hours before cimetidine, tetracycline, phenytoin, fluoroquinolones, or digoxin is administered.
2. Sucralfate should be given a half hour before H₂ receptor antagonists or antacids are given because it requires an acid environment to be effective.

Prostaglandin E-1 Analogs

Misoprostol is a prostaglandin E-1 analog that directly inhibits the parietal cell from secreting hydrogen ions into the stomach. It also protects the gastric mucosa by increasing the production of mucus and bicarbonate.

Clinical Uses

Prostaglandin E-1 analogs are used primarily to prevent or treat gastric ulcers associated with the use of nonsteroidal antiinflammatory drugs (NSAIDs).

Dosage Form

Misoprostol oral tablets (Cytotec), 100 and 200 g

Adverse Side Effects

Side effects include diarrhea, vomiting, flatulence, and abdominal pain.

Technician's Notes

Misoprostol causes abortion and should not be used in pregnant animals.

DIARRHEA

Diarrhea is the passage of loose or liquid stools, often with increased frequency. Diarrhea can result from primary disease of the intestinal tract or may accompany non-GI disease. Explanation of the pathophysiology of diarrhea is beyond the scope of this text. However, categories of mechanisms described

in veterinary references include hypersecretion, increased permeability, osmotic overload, and altered intestinal motility. Parasitism is a common cause of diarrhea in all domestic animal species; it results in diarrhea through a combination of previously described mechanisms. Parasitism always should be ruled out when a diagnosis is determined.

Increased secretion of fluid from the intestine may result from the actions of bacterial endotoxins from microorganisms such as *Escherichia coli*, *Clostridium perfringens*, *Clostridium difficile*, *Campylobacter jejuni*, and *Helicobacter*. Intestinal epithelium damaged by viruses or other organisms may lose fluid as the result of increased permeability. Osmotic overload may occur because of poorly digestible foods, a rapid change in diet, or maldigestion or malabsorption. Although diarrhea has often been associated with hypermotility of the GI tract, the current belief is that most patients with diarrhea actually have hypomotility.

Decreased segmental contractions (hypomotility) increase the diameter of the lumen and allow rapid passage of contents, resulting in diarrhea. Normal segmental constrictions narrow the diameter of the intestinal lumen and actually slow the passage of contents. Diarrhea, if not controlled, can result in substantial fluid and electrolyte (sodium, chloride, potassium, and bicarbonate) losses. Dehydration, acidosis, weakness, and anorexia may follow.

Acute diarrhea, similar to acute vomiting, in dogs and cats often responds to dietary management and conservative treatment. In cases that do not respond to conservative management, symptomatic and specific treatments are essential. A discussion of the medications used in the treatment of diarrhea follows.

Antidiarrheal Medications**Narcotic Analgesics**

Narcotic analgesics (opiates) are effective agents in the control of diarrhea because of their ability to (1) increase segmental contractions, (2) decrease intestinal secretions, and (3) enhance intestinal absorption. Many clinicians consider opiates to be the drugs of choice for the control of diarrhea in dogs. They also are used for the treatment of

diarrhea in calves, but their use in cats and horses is controversial because of their tendency to cause CNS stimulation. Narcotic agents are sometimes prepared as combination products with other classes of antidiarrheals.

Clinical Uses

The opiates are used in GI therapy for the control of diarrhea.

Dosage Forms

1. Diphenoxylate (Lomotil). Diphenoxylate is a synthetic narcotic agent (Class V) that is structurally similar to meperidine. Atropine sulfate is added to commercial preparations to discourage substance abuse.
2. Loperamide (Imodium). Loperamide is a synthetic narcotic that is available in a nonprescription preparation. Loperamide poorly penetrates the CNS in cats and is acceptable in this species (Willard, 1998).
3. Paregoric/kaolin/pectin (Parepectolin)
4. Opium/kaolin/pectin/anticholinergics (Donnagel)

Adverse Side Effects

Adverse side effects of all the opiates include constipation, ileus, sedation, and CNS excitement (cats and horses).

Anticholinergics/Antispasmodics

Anticholinergics and antispasmodics have been widely used in veterinary medicine for the treatment of diarrhea. Because hypomotility rather than hypermotility is now considered to be associated with most cases of diarrhea, anticholinergics and antispasmodics should be used with caution for the treatment of diarrhea. A few commercial antidiarrheal preparations contain an anticholinergic plus a CNS depressant.

Clinical Uses

Anticholinergics/antispasmodics are used for the treatment of diarrhea.

Dosage Forms

1. Aminopentamide (Centrine)
2. Methscopolamine (Pamine)

3. Hyoscyamine (Levsin)
4. Propantheline (Pro-Banthine)
5. Clidinium/chlordiazepoxide (Librax)
6. Hyoscyamine/phenobarbital (Donnatal)

Adverse Side Effects

Adverse side effects are addressed in the section on antiemetics.

Protectants/Adsorbents

Products in this category may have protectant or adsorbent qualities in the GI tract. The coating action of these drugs protects inflamed mucosa from further irritation. Their adsorbent activity binds bacteria or their toxins to protect against the harmful effects of these organisms. Kaolin and pectin are two ingredients often used in protectant compounds. The ability of protectants to control diarrhea has been questioned by some clinicians.

Bismuth subsalicylate is a compound found in products such as Corrective Suspension and Pepto-Bismol. Bismuth subsalicylate is converted to bismuth carbonate and salicylate in the small intestine. The bismuth has a coating and antibacterial effect, and the salicylate (an aspirin-like compound) has an antiinflammatory effect and reduces secretion by inhibiting prostaglandins (Boothe, 2001).

Activated charcoal is an adsorbent that is used primarily to treat poisoning.

Clinical Uses

These agents are used to control diarrhea and act as an adsorbent.

Dosage Forms

1. Bismuth subsalicylate
 - a. Corrective Mixture (veterinary approved)
 - b. Pepto-Bismol (human label)
2. Kaolin/pectin
 - a. Kaopectolin
 - b. Kao-Forte
 - c. K-Pek
3. Activated charcoal
 - a. Toxiban Suspension and Granules
 - b. SuperChar-Vet Powder and Liquid
4. Di-Tri-Octahedral Smectite
 - a. Bio-Sponge

Adverse Side Effects

Adverse side effects are rare and usually are limited to constipation.

Technician's Notes

1. Bismuth subsalicylate compounds should be used with caution in cats because of the conversion to aspirin.
2. Bismuth may appear opaque on radiographs.
3. Administration of bismuth subsalicylate can result in black stools that resemble melena.

**Laxatives**

Laxatives are substances that loosen bowel contents and encourage their evacuation. Laxatives with a strong or harsh effect are called cathartics, or purgatives. Categories of laxatives include saline/hyperosmotic agents, bulk-producing agents, lubricants, surfactants/stool softeners, irritants, and miscellaneous agents.

Saline/Hyperosmotic Agents

Saline or hyperosmotic laxatives contain magnesium or phosphate anions that are very poorly absorbed from the GI tract. It generally is believed that these anions hold water in the tract osmotically. Increased water in the GI tract then softens the stool and stimulates stretch receptors in the gut wall to enhance peristalsis.

Clinical Uses

These agents are used for the relief of constipation.

Dosage Forms

Dosage forms include suspensions, crystals, powders, and boluses.

1. Lactulose (Cephulac, Constulose, or Enulose).
Lactulose also reduces blood ammonia levels in some hepatic diseases.
2. Magnesium hydroxide
 - a. Milk of magnesia is a suspension for use in dogs and cats.

- b. Carmilax Powder and Bolets is for use in cattle (laxative/antacid).
- c. Magnalax Bolus and Powder is for use in cattle.
- d. Poly Ox II Bolus is for use in cattle.

3. Magnesium sulfate

- a. Epsom Salts has been used in horses and birds.

4. Sodium phosphate salts

- a. Fleet Enema is for use in dogs and foals.
- b. Gent-L-Tip Enema is for dog and foal use.

Adverse Side Effects

These are rare but may include cramping or nausea. Overdose or overuse may result in hyperphosphatemia or hypocalcemia. Cats are especially susceptible to these electrolyte imbalances.

Technician's Notes

Phosphate enemas should not be used in cats because cats are especially sensitive to electrolyte imbalances that may occur.

Bulk-Producing Agents

Bulk-producing agents are often indigestible plant materials (cellulose or hemicellulose) that act by absorbing water and swelling to increase the bulk of intestinal contents, thereby stimulating peristalsis.

Clinical Uses

Bulk-producing agents are used for relief of constipation and for relief of some types of impaction (sand primarily) in horses.

Dosage Forms

Dosage forms primarily consist of psyllium preparations. Psyllium is obtained from the ripe seed of a species of *Plantago* (Plumb, 2005).

1. Metamucil
2. Equine Psyllium
3. Equi-Phar Sweet Psyllium
4. Equine Laxative
5. Bran—a bulk-producing agent often used in horses (bran mash)

Adverse Side Effects

Adverse side effects are rare.

Lubricants

Lubricants are typically oils or other hydrocarbon derivatives (petrolatum) that soften the fecal mass and make it easier to move through the GI tract.

Clinical Uses

These include treatment of constipation and fecal impaction.

Dosage Forms

Dosage forms include liquids (mineral oil) and a jelly-like mass (petrolatum).

1. Mineral oil. Mineral oil is used in horses for the treatment of constipation, colic, and impaction. This substance is also used as a laxative in other species. Heavy mineral oil is preferred over light mineral oil.
2. Petrolatum. This is a jelly-like mass that is insoluble in water and is only slightly soluble in alcohol. Petrolatum is the principal ingredient in many of the oral laxatives for hairball treatment in cats.
 - a. Laxatone
 - b. Felaxin
 - c. Kat-A-Lax

Adverse Side Effects

These are minimal when used appropriately.

Technician's Notes

When mineral oil is administered orally to a patient, care should be taken to avoid aspiration. Mineral oil is very bland and may not readily stimulate a swallowing reflex.

Surfactants/Stool Softeners

Surfactants reduce surface tension and allow water to penetrate GI contents, thus softening the stool. They also may increase intestinal secretions.

Clinical Uses

Clinical uses include the treatment of hard, dry feces in small animals; impaction in horses; and occasionally digestive upset in cattle.

Dosage Forms

These products are available in liquid, syrup, capsule, tablet, and enema forms. Docusate sodium, also called dioctyl sodium sulfo-succinate, is the main ingredient.

1. Docusate Sodium (Colase)
2. Docusate Calcium (Surfak)
3. Disposable Enema

Adverse Side Effects

Adverse side effects are rare.

Technician's Notes

Docusate sodium given with mineral oil may result in some absorption of mineral oil.

Irritants

Irritants act by irritating the gut wall, causing stimulation of GI smooth muscle and increased peristalsis. These drugs are seldom used in veterinary medicine. This category includes several agents that are sometimes used in the treatment of constipation in humans.

1. Bisacodyl (Dulcolax)
2. Castor oil
3. Emodin

**Gastrointestinal Prokinetics/Stimulants**

Prokinetic/stimulant drugs increase the motility of a part or parts of the gastrointestinal tract and by doing this enhance the transit of material through the tract. Several classes of drugs, including dopaminergic antagonists, serotonergic drugs, **motilin**-like drugs, direct **cholinergics**, and acetylcholinesterase

inhibitors, have the ability to enhance gastrointestinal motility. As was previously noted, some H₂ receptor antagonists exhibit prokinetic activity (see ranitidine earlier).

Dopaminergic Antagonists

Dopaminergic antagonists used as prokinetics in veterinary medicine include metoclopramide and domperidone (Hall and Washabau, 1997). These agents stimulate motility of the gastroesophageal sphincter, stomach, and small intestine. Domperidone has had limited use as a prokinetic in the United States but is approved in Europe for the treatment of nausea, vomiting, and gastric reflux in humans (Parker, 2001).

Clinical Uses

Metoclopramide is used to treat gastroesophageal reflux and delayed gastric emptying, to stimulate the gastrointestinal tract in foals, and for gastrointestinal motility disorders in dogs and cats. Metoclopramide has been shown to enhance gastric emptying. The use of metoclopramide as an antiemetic is discussed in a previous section.

Dosage Forms

1. Metoclopramide (Reglan) tablets, syrup, and injection
2. Domperidone (Motilium, Equidone). Domperidone may have use in regulating gastrointestinal motility in horses, cats, and dogs.

Adverse Side Effects

Side effects include behavioral changes in dogs, cats, and adult horses. Cats have shown frenzied behavior (Plumb, 2005), and adult horses have exhibited alternating periods of sedation and excitement.

Serotonergic Drugs

Cisapride is the serotonergic prokinetic that is used frequently in veterinary medicine. Cisapride stimulates motility of the proximal and distal gastrointestinal tract, including the gastroesophageal sphincter, stomach, small intestine, and colon (Boothe, 2001). Cisapride is not effective as an antiemetic but may be better than metoclopramide

in treating some motility disorders and in promoting gastric emptying of solid material. Cisapride is not currently commercially available. However, compounding pharmacies may be able to make the product available.

Clinical Uses

Uses include the treatment of constipation (along with dietary and/or surgical considerations) in cats and gastroesophageal reflux and gastrointestinal stasis in dogs, cats, and horses.

Dosage Form

Cisapride (Propulsid), 10- and 20-mg tablets or 1-mg/ml suspension

Adverse Side Effects

Side effects may include diarrhea and abdominal pain.

Motilin-like Drugs

Erythromycin has been used by veterinarians to treat bacterial and mycoplasmal infections for many years. This drug has been shown to stimulate gastrointestinal motility by mimicking the effect of the hormone motilin (Hall and Washabau, 2000). Erythromycin stimulates motility in the esophageal sphincter, stomach, and small intestine at microbially ineffective doses.

Clinical Uses

Uses may include increasing lower esophageal sphincter pressure, accelerating gastric emptying, and facilitating intestinal transit time.

Dosage Form

Erythromycin (Erythro)

Adverse Side Effects

Side effects may include anorexia, vomiting, diarrhea, and abdominal pain.

Direct Cholinergics

Clinical Uses

These include postoperative treatment of ileus—or retention of flatus or feces—and equine colic (without obstruction).

Dosage Forms

1. Veterinary approved: dexpanthenol (d-Panthenol Injectable, d-Panthenol Injection)
2. Human approved: dexpanthenol (Ilopan injection)

Adverse Side Effects

Adverse side effects are rare but may include cramping and diarrhea.

Technician's Notes

Dexpanthenol should not be used within 12 hours of the use of neostigmine, parasympathomimetic agents, or succinylcholine.

Acetylcholinesterase Inhibitors

These drugs increase the amount of acetylcholine available to bind smooth muscle receptors.

Clinical Uses

These agents are used to treat rumen atony, to enhance gastric emptying (ranitidine), to stimulate peristalsis, to empty the bladder of large animals, and to aid in the diagnosis of myasthenia gravis (neostigmine) in dogs. They also may be used to treat curare overdose.

Dosage Forms

1. Neostigmine methylsulfate (Stiglyn injection)
2. Ranitidine (Zantac)

Adverse Side Effects

Adverse side effects are cholinergic and may include nausea, vomiting, diarrhea, drooling, sweating, lacrimation, bradycardia, and various others.

Technician's Notes

Ranitidine and nizatidine, H_2 receptor antagonists, increase acetylcholine by inhibiting acetylcholinesterase. The increase in acetylcholine stimulates smooth muscle in the stomach and promotes gastric emptying to reduce vomiting in patients with gastritis and related disorders.

**Digestive Enzymes**

Pancrelipase is a product that contains pancreatic enzymes that aid in the digestion of fats, proteins, and carbohydrates. The powder that contains the enzymes is mixed with the animal's food, which is allowed to stand for 15 to 20 minutes before feeding.

Clinical Uses

This product is used to treat pancreatic exocrine insufficiency.

Dosage Form

Pancrelipase (Viokase-V powder, Pancrezyme powder). Both are approved for use in dogs and cats.

Adverse Side Effects

Adverse side effects of high doses include cramping, nausea, and diarrhea.

Technician's Notes

1. Powder spilled onto the skin should be washed off to prevent irritation.
2. Inhaled powder can cause nasal irritation or can precipitate an asthma attack.

**Miscellaneous Gastrointestinal Drugs**

Drugs discussed in this section include antibiotics, antiinflammatory agents, and antifoaming agents.

Antibiotics

Antibiotics are not routinely used in the treatment of GI tract disease in small animals because these agents may destroy normal inhabitants of the GI tract and allow pathogenic bacteria (*Salmonella* species, *C. jejuni*, *C. perfringens*, *C. difficile*, *Helicobacter*, and others) to grow on the mucosal surface. Bloody diarrhea or signs of sepsis may indicate the need for antibiotic therapy. Antibiotics that are often used for treating bacterial overgrowth and other GI conditions include metronidazole, amoxicillin, clavamox, and tylosin.

METRONIDAZOLE

Metronidazole is a synthetic antibacterial and anti-protozoal agent.

Clinical Uses

1. Treatment of giardiasis, trichomoniasis, balantidiasis, plasmacytic/lymphocytic enteritis, ulcerative colitis, hepatic encephalopathy, and anaerobic infection in dogs
2. Treatment of giardiasis and anaerobic infection in cats
3. Treatment of anaerobic infection in horses

Dosage Form

Metronidazole (Flagyl tablets, Flagyl IV powder for reconstitution, and Flagyl IV RTU injection)

Adverse Side Effects

These include anorexia, hepatotoxicity, neutropenia, vomiting, and diarrhea.

Technician's Notes

1. Metronidazole should not be given to debilitated, pregnant, or nursing animals.
2. Tylosin is a macrolide antibiotic that is sometimes used to treat chronic colitis in animals.

Antiinflammatory Agents

Antiinflammatory agents are used in the treatment of idiopathic inflammatory bowel disease in animals. Increased numbers of lymphocytes, macrophages, plasma cells, or eosinophils in the intestinal wall characterize these diseases. Treatment often involves the use of hypoallergenic diets and antiinflammatory agents.

Dosage Forms

Antiinflammatory agents used in the treatment of inflammatory bowel disease include prednisone, azathioprine, sulfasalazine, and olsalazine.

1. Prednisone—Many generic and trade name products are available.
2. Azathioprine (Imuran)—A purine antagonist antimetabolite that may be used in the treatment of

inflammatory bowel disease because of its immunosuppressive effects.

3. Sulfasalazine (Azulfidine)—A drug that is converted by intestinal bacteria to a sulfa drug (sulfapyridine) and aspirin (salicylic acid). Aspirin is the active component that has an antiinflammatory effect and is useful in many cases of colitis in dogs and cats. It should be used with care in cats because of their poor ability to metabolize aspirin.
4. Olsalazine (Dipentum)—Olsalazine is used for the treatment of dogs with chronic colitis that cannot tolerate sulfasalazine or respond poorly to the product.

Antifoaming Agents

Antifoaming agents are used to treat frothy bloat in ruminants. In this condition, gas bubbles form and become trapped in the rumen fluid as a result of consumption of wheat pasture or legumes, such as alfalfa or clover. The trapped bubbles cause a form of bloat that cannot be relieved by usual means.

Antifoaming agents act as surfactants (reduce surface tension) and cause bubbles to break down so that gas can be relieved by eructation or by the stomach tube. These products are given orally.

Clinical Uses

Antifoaming agents are used for the treatment of frothy bloat in ruminants.

Dosage Forms

1. Bloat Guard
2. Bloat Treatment
3. Bloat-Pac
4. Therabloat

Adverse Side Effects

These are rare if the products are given as directed.

Weight-Loss Products**DIRLOTAPIDE**

Dirilotapide is a selective microsomal triglyceride transfer protein inhibitor that blocks the assembly and release of lipoprotein particles into the bloodstream in dogs.

Clinical Uses

Dirlotapide is indicated for the management of obesity in dogs.

Dosage Form

SELENTROL solution containing 5 mg/ml for oral administration.

Adverse Side Effects

Side effects include vomiting, diarrhea, lethargy, anorexia, constipation, and dehydration.

Probiotics

Probiotics are substances that competitively inhibit enteropathogens. They are used to treat diarrhea, inflammatory bowel disease, and food allergy, as well as for long-term antibiotic use. Controversy regarding the effectiveness of these substances is ongoing.

Dosage Forms

1. FortiFlora
2. Culturelle
3. G.I. Conditioner
4. Propanion
5. ProLacsis Paste
6. T.D.N. Mini Rockets
7. T.D.N. Rockets
8. Advance Power Freshen
9. Others

Appetite Stimulants

Stimulating an animal to eat can be an important component of a therapy regimen. Proper nutrition is essential for optimal functioning of the immune system as well as for proper organ function. Cats who do not eat adequately for a period of time may develop a “fatty liver” syndrome that can be life threatening. The following is a partial list of appetite stimulants:

1. Diazepam—Medication that produces a transient appetite stimulation when given intravenously
2. Alprazolam—Medication given orally as an appetite stimulant in cats

3. Cyproheptadine—Antihistamine used as an appetite stimulant primarily in cats

**Oral Products**

An increased emphasis on dentistry in veterinary practice in recent years has fueled a demand for products that promote and maintain oral health. Many of these products help to remove food particles and plaque and assist in the maintenance of pleasant-smelling breath. Some are labeled as a **dentifrice**, and others may be applied as an oral rinse or with a toothbrush. They are prepared as solutions, gels, and premoistened gauze sponges. Various flavors are available, as are products with fluoride. These products should not be considered a substitute for veterinary dental treatment.

Other oral products include grit impregnated in paste for polishing teeth and smoothing rough surfaces left by scaling, as well as disclosing solution used to help identify plaque.

Dentifrice and Cleansing Products

1. C.E.T. Enzymatic Toothpaste.
2. Nolvadent oral cleansing solution. Chlorhexidine acetate is the active ingredient; also contains a peppermint flavor; may be used with a toothbrush or as a rinse
3. OraVet Plaque Prevention Gel
4. OraVet Barrier Sealant
5. C.E.T. Oral Hygiene Rinse
6. C.E.T. HEXtra Premium Chews for Dogs
7. Friskies Cheweez Beefhide treats
8. C.E.T. Oral Hygiene Chews for Cats
9. Hills t/d Diets
10. Hartz Flavor Infused Oral Chews
11. Friskies Feline Dental Diet
12. C.E.T. Dental Reward
13. Royal Canin Veterinary Diet
14. Purina Veterinary Diets DH
15. CHX Guard

Fluoride Products

1. SF04 Stannous Fluoride Gel
2. Fluorofoam
3. C.E.T. Oral Hygiene Spray with Fluoride

Perioceutic Agents

DOXIROBE

Doxirobe is placed in the periodontal pocket after dental cleansing with the use of a cannula. Upon contact with the aqueous environment, the product coagulates and releases doxycycline for several weeks.

BIOACTIVE CERAMIC AGENT

Consil Dental is a substance used to promote the regeneration of bone lost as the result of periodontal disease or tooth extraction.

Polishing Paste

C.E.T. prophypaste
Human Products

Disclosing Solution

Duo 128 Disclosing Solution

REFERENCES

Bill R: Drugs affecting the gastrointestinal system. In Bill R, editor: *Pharmacology for veterinary technicians*, ed 3, St. Louis, 2006, Mosby.

Boothe DM: Gastrointestinal pharmacology. In *Small animal clinical pharmacology and therapeutics*, Philadelphia, 2001, WB Saunders.

DeNovo RC: Chronic vomiting in the cat and dog. *Proceedings of the Annual Meeting of the American Veterinary Medical Association*, Nashville, Tenn, 2002.

Foushee LL: Omeprazole. *Compend Contin Educ Pract Vet* 22(8):746-749, 2000.

Ganong W: Regulation of gastrointestinal function. In Ganong W, editor: *Review of medical physiology*, ed 21, New York, 2003, McGraw-Hill.

Hall JA: Diseases of the stomach. In Ettinger SJ, editor: *Pocket companion to textbook of veterinary internal medicine*, Philadelphia, 2001, WB Saunders.

Hall JA, Washabau RJ: Gastrointestinal prokinetic therapy: dopaminergic antagonist drugs. *Compend Contin Pract Vet* 19(2):214-219, 1997.

Hall JA, Washabau RJ: Gastrointestinal prokinetic agents. In *Kirk's current veterinary therapy XIII: small animal practice*, Philadelphia, 2000, WB Saunders.

Parker AR: Domperidone. *Compend Contin Educ Pract Vet* 23(10):906-908, 2001.

Plumb DC: Apomorphine. In Plumb DC, editor: *Veterinary drug handbook*, ed 5, Ames, Iowa, 2005, Iowa State University Press.

Upton DW: Gastrointestinal system. In Upton DW, editor: *Handbook of clinical veterinary pharmacology*, ed 3, Manhattan, Kan, 1988, Dan Upton Enterprises.

Willard MD: Gastrointestinal drugs. In Boothe DM, editor: *The veterinary clinics of North America, small animal practice*, Philadelphia, 1998, WB Saunders.



REVIEW QUESTIONS

- List three general functions of the GI tract.

- List three examples of monogastric animals.

- What is the GI configuration of ruminant animals? _____
- What is the difference between vomiting and regurgitation? _____
- Ruminants are animals that use _____ to digest coarse plant material.
- What are the three basic control mechanisms of the GI tract? _____
- What is the significance of the presence of bacterial endotoxins in the GI tract?

- The CRTZ stimulates vomiting when activated by _____.
- List two examples of centrally acting emetics and two examples of peripherally acting emetics.

- Drugs that inhibit vomiting are called _____.
- H₂ receptor antagonists promote the healing of GI ulcers by _____.
- List two H₂ receptor antagonists.

- What are the two types of intestinal motility patterns? _____
- Acute vomiting and diarrhea in dogs and cats often respond to conservative management such as _____.
- List two species that do not vomit.

- What is the mechanism of action of saline/hyperosmotic laxatives?

- What is the active ingredient of Metamucil?

- Direct cholinergic drugs stimulate the GI tract by what mechanism?

- A synthetic antibiotic/antiinflammatory agent used to treat giardiasis and anaerobic bacterial infection in animals is called _____.
- List four products used as dentifrice/oral cleansing agents.

- What is the difference between peristalsis and segmentation?

- Stimulation of the parasympathetic portion of the ANS decreases intestinal motility.

 - True
 - False
- About what percent of the stomach's contents do emetics usually remove?

- How does sucralfate work to treat/prevent gastric ulcers?

- Bismuth subsalicylate compounds should be used with caution in what species?

- All the following are basic functions of the GI system, except _____
 - intake of food and fluid into the body
 - absorption of nutrients and fluid
 - excretion of waste products
 - excretion of urine
- Which of the following species has no gallbladder?
 - canines
 - equines
 - felines
 - ovines

28. Ruminants remasticate food to facilitate the digestion process.
- True
 - False
29. The crop in birds is used for _____.
- a stomach
 - food storage
 - feces storage
 - a place where food goes to mix with hydrochloric acid to aid in the breakdown of foodstuffs
30. All of the following are parts of the small intestine, except the _____.
- ilium
 - duodenum
 - jejunum
 - ileum
31. _____ is an emetic.
- Tigan
 - Meclizine
 - Promethazine
 - Apomorphine
32. Cimetidine is _____.
- a proton pump inhibitor
 - an antacid
 - a gastromucosal protectant
 - an H_2 receptor antagonist
33. _____ are substances that loosen bowel contents and encourage their evacuation.
- Protectants
 - Adsorbents
 - Antispasmodics
 - Laxatives
34. Mg sulfate is found in _____.
- Magnalax boluses
 - Fleet Enemas
 - Epsom Salts
 - milk of magnesia
35. Viokase-V powder is _____.
- an anticholinergic substance
 - a digestive enzyme
 - approved for use in dogs and cats
 - both b and c

CHAPTER 9

Drugs Used in Hormonal, Endocrine, and Reproductive Disorders

LEARNING OBJECTIVES

After studying this chapter, you should be able to:

1. Discuss the control mechanisms (physiology) of the endocrine system.
2. List the endocrine glands.
3. List the reasons why hormones are clinically used.
4. Describe the difference between an endogenous and an exogenous hormone.
5. Describe the location and functions of the pituitary gland.
6. Differentiate between a positive and a negative feedback control mechanism.
7. Describe a neurohormonal reflex.
8. Discuss the uses and classes of gonadotropins, gonadal hormones, progestins, and prostaglandins used in veterinary medicine.
9. Describe the uses and classes of drugs that affect uterine contractility.
10. Define pheromone and give an example.
11. Describe the location, function, and hormonal products of the thyroid gland.
12. Describe the hormonal treatment of hypothyroidism and hyperthyroidism.
13. List the endogenous source of insulin and its metabolic effects.
14. List the classes of insulin products and their general characteristics.
15. Describe the method of action of the growth promoters.
16. List the clinical uses for the anabolic steroids.

CONTENTS AND TOPICS

HORMONES

Gonadotropins

Gonadorelin
Chorionic Gonadotropin
Follicle-Stimulating Hormone–Pituitary

Estrogens

Androgens

Testosterone Cypionate, Testosterone Enanthate,
and Testosterone Propionate
Mibolerone

Progestins

Megestrol Acetate
Mecroxyprogesterone Acetate
Altrenogest
Norgestrel
Melenigestral Acetate

PROSTAGLANDINS

Dinoprost Tromethamine

Ferprostenal

Fluprostenol

Cloprostenol Sodium

DRUGS THAT AFFECT UTERINE

CONTRACTILITY

Oxytocin

Ergot

Prostaglandins

Corticosteroids

MISCELLANEOUS REPRODUCTIVE DRUGS

Bromocriptine

Leuprolide

Melatonin

Neutersol

PHEROMONES

Thyroid Hormones

DRUGS USED TO TREAT HYPOTHYROIDISM

Levothyroxine Sodium (T₄)

Liothyronine Sodium

Thyroid-Stimulating Hormone

DRUGS USED TO TREAT HYPERTHYROIDISM

Methimazole

Carbimazole

Iodate

Propylthiouracil

Radioactive Iodine

Propranolol

AGENTS FOR THE TREATMENT

OF DIABETES MELLITUS

Insulin

Insulin Classifications
Short-Acting Insulin
Intermediate-Acting Insulin
Long-Acting Insulin
Use of Insulin Products

Oral Hypoglycemic Agents

HYPERGLYCEMIC AGENTS

Hormones That Act as Growth Promoters

SEX STEROIDS, SYNTHETIC STEROID

ANALOGS, AND NONSTEROIDAL ANALOGS

GROWTH HORMONE: BOVINE

SOMATOTROPIN, BOVINE GROWTH

HORMONE

Anabolic Steroids

Stanozolol

Boldenone Undecylenate

Nandrolone Decanoate



KEY TERMS

ANABOLISM The constructive phase of metabolism in which body cells repair and replace tissue.

ANALOG A chemical compound having a structure similar to another but differing from it in some way.

DYSTOCIA Difficult birth.

ENDOMETRIUM The mucous membrane lining of the uterus.

EUTHYROID A normal thyroid gland.

FEED EFFICIENCY The rate at which animals convert feed into tissue. It is expressed as the number of pounds or kilograms of feed needed to produce 1 lb or 1 kg of animal.

FEEDBACK The return of some of the output product of a process as input in a way that controls the process.

GONADOTROPIN A hormone that stimulates the ovaries or testes.

HYPOPHYSAL PORTAL SYSTEM This is the portal system of the pituitary gland in which venules from the hypothalamus connect with capillaries of the anterior pituitary.

INVOLUTION The return of a reproductive organ to normal size after delivery.

LEVO ISOMER Left-sided arrangement of a molecule that may exist in a left- or a right-sided configuration. Levo and dextro isomers have the same molecular formula.

MYOFIBRIL A muscle fibril composed of numerous myofilaments.

NITROGEN BALANCE The condition of the body as it relates to protein intake and use. Positive nitrogen balance implies a net gain in body protein.

PRIMARY HYPOTHYROIDISM Hypothyroidism resulting from a pathologic condition in the thyroid.

RELEASING FACTOR (RELEASING HORMONE) A hormone produced by the hypothalamus and transported to the anterior pituitary to stimulate the release of trophic hormones.

TROPHIC HORMONE A hormone that results in production of a second hormone in a target gland.

INTRODUCTION

The traditional definition of the endocrine system states that it is composed of organs (glands) or groups of cells that secrete regulatory substances (hormones) directly into the bloodstream. This definition has now been extended to include regulatory substances that are distributed by diffusion across cell membranes.

The endocrine system and the nervous system constitute the two major control mechanisms of the body. These two control mechanisms are linked together through the complex integrating action of the hypothalamus (Figure 9-1). Coordination of these two systems allows an individual to adapt its reproductive and survival strategies to changes in the environment.

Endocrine glands include the pituitary, adrenals, thyroid, ovaries, testicles, pancreas, and kidneys. These glands produce hormones that are carried to

target organs, where they influence the physiologic activity of these structures.

Hormones generally are administered to animals for one of two reasons: (1) to correct a deficiency of that hormone, or (2) to obtain a desired effect (e.g., to postpone estrus). Hormones that are administered to an animal are called *exogenous* hormones, whereas those produced naturally in the body are *endogenous* hormones.

ANATOMY AND PHYSIOLOGY

Pituitary Gland

The pituitary gland has been called the master gland of the endocrine system because of the control it exerts over the regulation of this system. It is located at the base of the brain just ventral to the hypothalamus and is connected to the brain by a stalk. It is divided into two main lobes—an anterior lobe (adenohypophysis), which arises from the embryologic pharynx, and a posterior

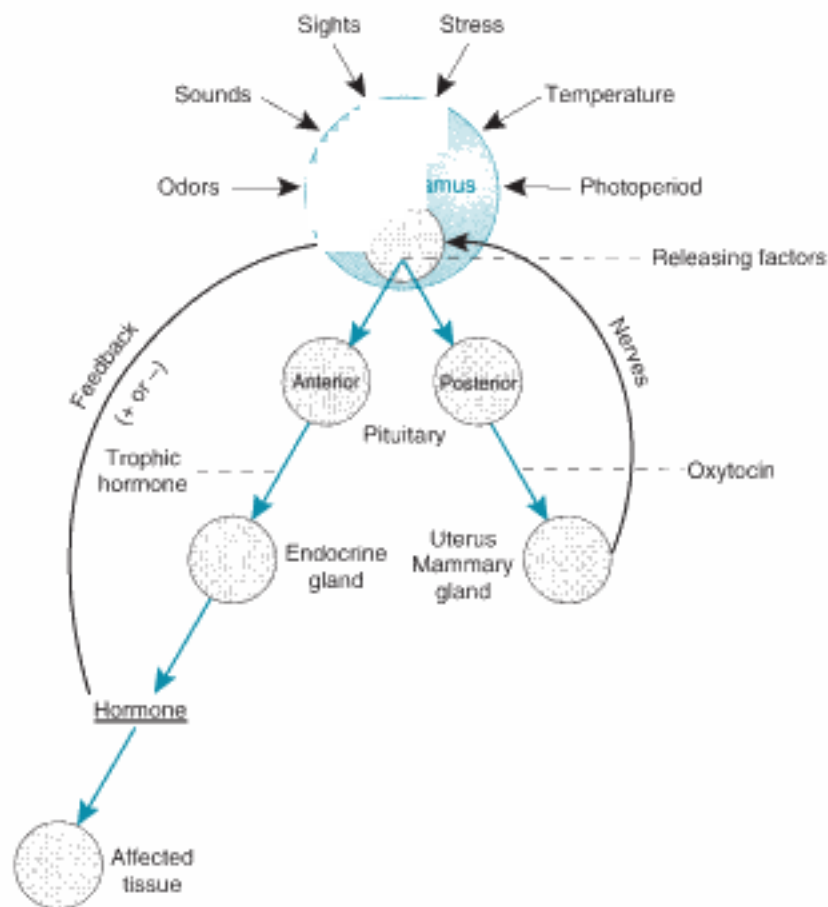

FIGURE 9-1

Hypothalamic integration of endocrine and nervous systems.

lobe (neurohypophysis), which arises from the brain (Figure 9-2).

The hypothalamus exerts control over the anterior pituitary through the transport of **releasing hormones, or factors, down the hypophyseal portal system.** In the anterior pituitary, these releasing factors cause the secretion of **trophic hormones** into the circulation. Trophic hormones produced by the anterior pituitary include thyroid-stimulating hormone (TSH), adrenocorticotrophic hormone (ACTH), luteinizing hormone (LH), follicle-stimulating hormone (FSH), prolactin (LTH), and growth hormone (GH or somatotropin). These trophic hormones are sometimes called *indirect-acting hormones* because they cause their target organ to produce a second hormone, which in turn influences a second target organ or tissue (Table 9-1). For example, TSH stimulates

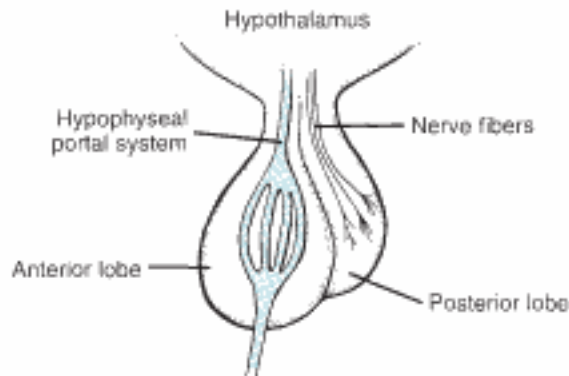

FIGURE 9-2

Lobes of the pituitary gland.

Table 9-1 Pituitary Hormones

Source and Name	Target and Actions
Anterior Lobe	
Thyroid-stimulating hormone (TSH)	Stimulates the thyroid to produce T_3/T_4
Follicle-stimulating (FSH)	Stimulates ovarian follicle growth (female) and spermatogenesis (male)
Luteinizing hormone (LH)	Stimulates ovulation (female) and testosterone production (male)
Growth hormone (somatotropin)	Accelerates body growth and increases milk production
Adrenocorticotropic hormone (ACTH)	Stimulates production of corticosteroids by adrenal cortex
Posterior Lobe	
Oxytocin	Stimulates uterine contraction and milk letdown
Vasopressin (antidiuretic hormone, ADH)	Stimulates water retention

the thyroid gland to produce triiodothyronine (T_3) and tetraiodothyronine (T_4), which are hormones that in turn influence the metabolic rate of all tissues in the body.

The two hormones of the posterior pituitary are vasopressin (antidiuretic hormone) and oxytocin. These hormones are produced in the hypothalamus and subsequently travel down nerve fibers to the posterior pituitary, where they are stored for release into the circulation. The hormones of the posterior pituitary are called *direct-acting hormones* because they produce the desired activity (e.g., contraction of the uterus) directly in the target organ.

Control of the Endocrine System

FEEDBACK MECHANISM

The nervous system is sensitive to levels of hormones through a mechanism called the **feedback mechanism**. By this mechanism, the plasma level of a particular hormone controls the activity of the gland that produces it. The feedback may be negative or positive (Figure 9-3).

With negative feedback, high plasma levels of a hormone are sensed by the hypothalamus, which then reduces the amount of the appropriate releasing factor (or hormone). A decreased amount of releasing factor reduces the amount of trophic hormone released from the pituitary, causing less activity in the organ that is producing the hormone in question. The overall effect is to lower the amount of the hormone in the plasma.

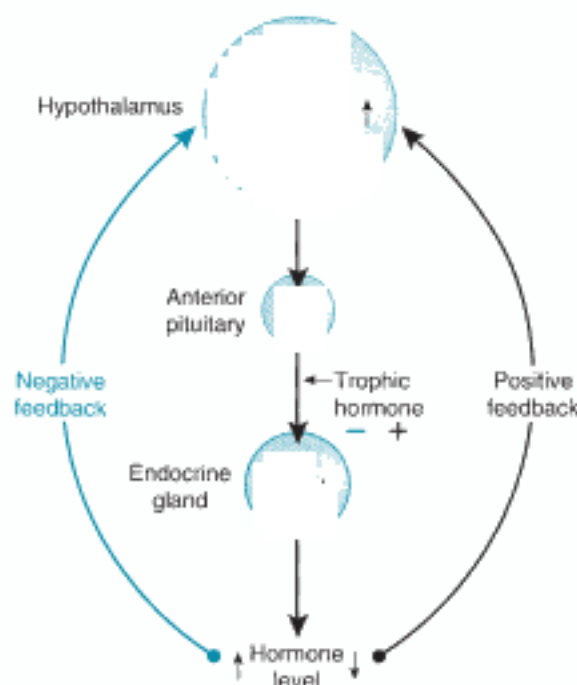

FIGURE 9-3 Feedback control mechanisms. Positive and negative feedback mechanisms control the quantity of a particular hormone.

In the positive feedback scheme, low levels of a hormone are sensed by the hypothalamus, and release of the appropriate releasing factor increases. Increased amounts of the corresponding trophic hormone are then secreted, causing increased

activity in the target organ and a corresponding rise in the plasma levels of the hormone.

NEUROHORMONAL REFLEX

The neurohormonal reflex applies to the release of oxytocin by the posterior pituitary. The first step in this reflex can be initiated by (1) stimulation of the udder by a nursing calf or by preparation of the udder for milking, (2) stimulation of the uterus and vagina in parturition, or (3) stimulation of the cerebral cortex by sensory stimuli associated with nursing or milking.

CONTROL OF THE REPRODUCTIVE SYSTEM

The reproductive (estrus) cycle in animals traditionally has been divided into four stages called proestrus, estrus, diestrus, and anestrus. The cycle also may be divided into a follicular phase and a luteal phase. In the follicular phase, the cycle is under the influence of estrogen produced by a

developing follicle, and in the luteal phase, it is under the influence of progesterone made by the corpus luteum.

Control of the reproductive system is coordinated in the hypothalamus, where the gonadotropin-releasing hormone (GnRH) is produced in response to various stimuli (Figure 9-4). These stimuli can include day-night length (photoperiod), pheromones, and positive and negative internal feedback mechanisms. GnRH causes the release of FSH and LH from the anterior pituitary.

FSH causes the growth and maturation of a follicle, which begins to produce increasing amounts of estrogen as it matures. Estrogen causes the changes that occur in proestrus and estrus, including the behavioral characteristics associated with estrus (e.g., standing to be mounted). The follicle also produces inhibin, which—along with estrogen—serves as negative feedback to the hypothalamus to inhibit the release of GnRH.

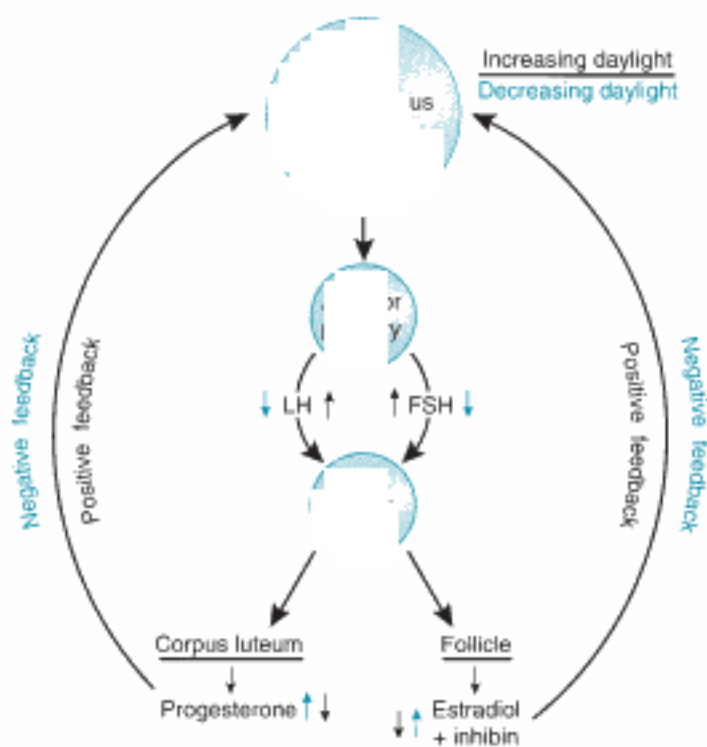

FIGURE 9-4

Control of the reproductive system is achieved primarily through feedback mechanisms and the photoperiod. FSH, Follicle-stimulating hormone; GnRH, gonadotropin-releasing hormone; LH, luteinizing hormone.

LH release causes ovulation of the mature follicle and the formation of a corpus luteum in its place. This event signals the beginning of diestrus and the beginning of the luteal phase of the cycle. The corpus luteum produces progesterone, which prepares the uterus for pregnancy. Once pregnancy occurs, the corpus luteum maintains a uterine environment conducive to normal progression of the pregnancy. Progesterone levels in the blood serve as negative feedback to prevent the release of GnRH and the development of new follicles during pregnancy.

When the gestation period nears its end, the fetus begins to produce increasing amounts of ACTH. ACTH causes increased amounts of cortisol to be produced by the adrenal glands. The increased cortisol levels result in increased production of estrogen and prostaglandin by the uterus. These two substances sensitize the uterus to the contraction-producing effects of oxytocin and allow parturition to begin. Prostaglandin also causes the breakdown (lysis) of the corpus luteum at the end of pregnancy and at the end of diestrus if pregnancy does not occur.

HORMONAL DRUGS ASSOCIATED WITH REPRODUCTION

Gonadotropins and Gonadal Hormones

Products in this category are used in veterinary medicine for various reasons. Some of these include synchronization of estrus, suppression of estrus, induction of estrus, treatment of cystic ovaries, and termination of pregnancy.

Gonadotropins

Gonadotropins are drugs that act similarly to GnRH, LH, or FSH. Gonadotropins cause the release of LH and FSH or cause activity like that of LH or FSH. LH may be prepared from the pituitary glands of slaughtered animals or obtained from the urine of pregnant women in the form of human chorionic gonadotropin (hCG). FSH may be obtained from pituitary glands (FSH-P) and from the serum of pregnant mares (PMS) between the 40th

and 140th days of pregnancy. GnRH is prepared synthetically.

FSH that is released endogenously by the anterior pituitary causes growth and maturation of the ovarian follicle in females and spermatogenesis in males. LH, also released by the anterior pituitary, causes ovulation in females and production of testosterone in males.

GONADORELIN

Gonadorelin (GnRH) is produced endogenously by the hypothalamus. Gonadorelin causes the release of FSH and LH by the anterior pituitary.

Clinical Uses

Gonadorelin is used to treat cystic (follicular) ovaries in dairy cattle. It has also been used in cats and horses (with limited success) to induce estrus.

Dosage Forms

1. Cystorelin. Gonadorelin for injection
2. Factrel. Gonadorelin for injection
3. Fertagyl. Gonadorelin for injection

Adverse Side Effects

These are minimal with the use of this product.

CHORIONIC GONADOTROPIN

Chorionic gonadotropin (hCG) is a hormone secreted by the uterus and obtained from the urine of pregnant women. It mimics the effects of LH, although it has limited FSH activity. In males, it stimulates the production of male hormones by the testicles and may facilitate descent of the testicles.

Clinical Uses

Chorionic gonadotropin is used to treat cystic ovaries (nymphomania) in dairy cattle. In males, it has been used to treat cryptorchidism and infertility caused by low testosterone levels.

Dosage Forms

1. Follutein. hCG injection
2. P.G. 600. Combination of hCG and PMS; contains both LH and FSH activity
3. Chorulon. hCG injection

4. Chorionic gonadotropin injection (generic)
5. APL. Human label

Adverse Side Effects

These are limited but may include hypersensitivity reaction and abortion in mares if given before the 35th day of pregnancy.

FOLLICLE-STIMULATING HORMONE—PITUITARY

FSH-P is obtained from the pituitary glands of slaughtered animals. FSH causes growth and maturation of the ovarian follicle.

Clinical Uses

FSH-P is used in veterinary medicine to induce superovulation and for out-of-season breeding.

Dosage Form

FSH-P

Adverse Side Effects

These include endometrial hyperplasia, superovulation, and follicular cysts.

Estrogens

Estrogens are a group of hormones synthesized by the ovaries and—to a lesser extent—by the testicles, adrenal cortex, and placenta. Estrogens are classified as sex steroids and are synthesized from a cholesterol precursor. Estrogens are necessary for normal growth and development of the female gonads. They cause secondary female characteristics and are responsible for female sex drive. These hormones inhibit ovulation, increase uterine tone, and cause proliferation of the **endometrium**.

Clinical Uses

In cattle, estrogens are used to treat persistent corpus luteum, to expel purulent material from the uterus, to expel retained placentas and mummified fetuses, and to promote weight gain. In dogs, estrogens are used to induce abortion and to control urinary incontinence. In horses, they may be used for induction of estrus in the nonbreeding season.

Dosage Forms

1. Estradiol cypionate (ECP) injection
2. Estradiol cypionate (generic)

3. Diethylstilbestrol (DES) compounded capsules and tablets
4. Implants to promote weight gain (discussed in a later section)

Adverse Side Effects

These include severe anemia, prolonged estrus, genital irritation, and follicular cysts.

Technician's Notes

1. Estrogens should not be given during pregnancy.
2. Estrogen administration can cause severe anemia.
3. Synthetic DES has been banned from use in food-producing animals because of its possible link with cervical cancer in women.

Androgens

Androgens are male sex hormones produced in the testicles, the ovaries, and the adrenal cortex. Similar to the other gonadal hormones, they have a steroidal parent molecule. These hormones are necessary for growth and development of the male sex organs. They cause secondary male sex characteristics and produce male libido. The androgens promote tissue **anabolism**, weight gain, and red blood cell formation.

TESTOSTERONE CYPIONATE, TESTOSTERONE ENANTHATE, AND TESTOSTERONE PROPIONATE

These injectable testosterone products are available under a human label.

Clinical Uses

These androgens are used to treat urinary incontinence in male dogs and to increase libido and fertility in domestic animals (with generally poor results).

Dosage Forms

1. Danocrine (Danazol—synthetic derivative of ethinyl testosterone) (human label)
2. Testosterone cypionate injection (generic)
3. Testosterone enanthate (generic)
4. Testosterone propionate injection (generic)
5. Depo-Testosterone
6. Combination products with estradiol as growth-promoting implants

Adverse Side Effects

These are uncommon when used as directed.

Technician's Notes

Testosterone products are now C-III controlled substances.

MIBOLERONE

Mibolerone is an androgen used for prevention of estrus in dogs. Mibolerone blocks the release of LH by the pituitary and prevents complete development of the follicle. Ovulation does not occur.

Clinical Uses

This product is used for prevention of estrus in adult female dogs and for treatment of pseudocyesis.

Dosage Forms

1. Cheque Drops. Oral liquid preparation
2. Implants to promote weight gain (discussed later)

Adverse Side Effects

Adverse side effects reported in the product insert include premature epiphyseal closure and vaginitis in immature females. In mature females, vulvovaginitis, clitoral hypertrophy, riding behavior, increased body odor, and various other side effects have been reported. It is further reported that side effects usually resolve with discontinuation of therapy.

Technician's Notes

Mibolerone should not be used in cats because of a very low margin of safety in this species.

Progestins

Progestins are a group of compounds that are similar in effect to progesterone. Endogenous progestins are produced by the corpus luteum. They cause increased secretions by the endometrium, decreased motility in the uterus, and increased secretory development in the mammary glands. They also inhibit the release of gonadotropins by the pituitary to produce an inactive ovary. In some situations, they can cause elevated blood glucose

levels (antiinsulin effect) or serious suppression of the adrenal glands. These hormones are used clinically to suppress estrus and to treat false pregnancy, behavioral disorders, and progestin-responsive dermatitis. The root "gest" often allows name recognition of the progestins.

MEGESTROL ACETATE

Megestrol acetate is a synthetic progestin labeled for use in dogs. It is used, however, in cats for some behavioral and dermatologic conditions.

Clinical Uses

Megestrol acetate is labeled for use in dogs to control estrus, treat false pregnancy, prevent vaginal hyperplasia, treat severe galactorrhea, and control unacceptable male behavior. Megestrol acetate has been used in cats for various dermatologic and behavioral problems, and for suppression of estrus.

Dosage Forms

1. Ovaban. Megestrol acetate tablets in bottles or foil strips
2. Megace. Oral tablet preparation of megestrol acetate approved for use in humans

Adverse Side Effects

These can include hyperglycemia, adrenal suppression, endometrial hyperplasia, and increased appetite.

Technician's Notes

Clients should be made aware of the potential dangers associated with the use of this drug and should be asked to report any changes in their pet's health status that occur after initiation of therapy.

MEDROXYPROGESTERONE ACETATE

Medroxyprogesterone acetate (MPA) is a human label progestin that has been used to treat certain behavioral and dermatologic problems and to suppress estrus in dogs and cats.

Clinical Uses

MPA is used for (1) treatment of behavioral problems, such as aggression, roaming, spraying, or

mounting in males, and (2) treatment of certain dermatologic conditions.

Dosage Forms

1. Depo-Provera. MPA for injection (human label)
2. Provera tablets (human label)
3. Cyrcin tablets (human label)

Adverse Side Effects

These are potentially numerous and include pyometra, personality changes, depression, lethargy, mammary changes, and increased appetite.

Technician's Notes

Progestins should be administered with strict adherence to accepted protocol to minimize side effects such as pyometra.

ALTRENOGEST

Altrenogest is an oral progestin labeled for use in horses. This drug is used to suppress estrus in mares. (Mares stop cycling within 3 days of treatment and begin cycling again 4 to 5 days after treatment is stopped.) It is also used to manage other reproductive conditions that are listed later.

Clinical Uses

1. To suppress estrus for synchronization
2. To suppress estrus for long periods
3. To maintain pregnancy in mares with low levels of progesterone

Dosage Form

Regu-Mate. Altrenogest in oil oral solution

Adverse Side Effects

These have been reported as minimal when used correctly.

Technician's Notes

Altrenogest can be absorbed through the skin and should be used with great caution by pregnant women or anyone with vascular disorders. Read the label carefully before using.

NORGESTOMET

Norgestomet is a synthetic progestin that is used in combination with an estrogen (estradiol valerate) for synchronization of estrus in beef cows and nonlactating dairy cows. A treatment consists of one implant and an injection at the time of implantation.

Clinical Uses

Norgestomet is used for synchronization of estrus in cattle.

Dosage Form

Syncro-Mate-B

Adverse Side Effects

Adverse side effects are not reported in the insert.

MELENGESTROL ACETATE

Melengestrol acetate is a progestin used in implants that promotes weight gain (discussed in a separate section).



Prostaglandins

Prostaglandins consist of a group of naturally occurring, long-chain fatty acids that mediate various physiologic events in the body. The primary use of prostaglandins in veterinary medicine is for regulation of activity in and treatment of conditions of the female reproductive tract. Of the six classes (A, B, C, D, E, and F), only prostaglandin $F_{2\alpha}$ has significant clinical application in the reproductive system.

Prostaglandin $F_{2\alpha}$ causes lysis of the corpus luteum, contraction of uterine muscle, and relaxation of the cervix. Lysis of the corpus luteum results in a decline in plasma levels of progesterone and, through the negative feedback mechanism, initiation of a new estrus cycle. Contraction of uterine muscle can facilitate evacuation of uterine contents (pus or a mummified fetus) or produce an abortion.

Bronchoconstriction, increased blood pressure, and smooth muscle contraction have been reported in other species, including humans. For these reasons, pregnant women and asthmatic individuals should handle prostaglandin products with extreme caution; exposure (through injection or skin contact) can cause abortion or an asthma attack.

Name recognition of the prostaglandins is made easier by looking for “prost” in the drug name.

Dinoprost Tromethamine

Dinoprost tromethamine is a salt of the naturally occurring prostaglandin $F_{2\alpha}$ and is labeled for use in cattle, horses, and swine. It also has accepted clinical uses in dogs, cats, sheep, and goats. It is effective only in animals with a corpus luteum.

Clinical Uses

Labeled clinical uses are as follows:

1. For estrus synchronization, treatment of silent estrus and pyometra in cattle
2. For abortion of feedlot and other nonlactating cattle
3. For induction of parturition in swine
4. For controlling the timing of estrus in cycling mares and in anestrus mares that have a corpus luteum
5. For treatment of pyometra and endometrial hyperplasia and as an abortion-producing agent in dogs and cats
6. In sheep and goats, basically has the same uses as in cattle

Dosage Forms

1. Lutalyse. Dinoprost tromethamine for injection
2. AmTech ProstaMate
3. In Synch
4. ProstaMate

Adverse Side Effects

These can include sweating (horses), abdominal pain (horses, dogs, cats, and swine), urination/defecation (dogs, cats, and swine), dyspnea and panting (dogs and cats), tachycardia (dogs), and increased vocalization (cats and swine). Most of the side effects are self-limiting and disappear within a short time.

Technician's Notes

1. Pregnant women, asthmatic persons, and people with bronchial disease should handle Lutalyse with extreme care.
2. Skin that is accidentally exposed should be washed off immediately.

Fenprostalene

Fenprostalene is a synthetic analog of prostaglandin $F_{2\alpha}$. Fenprostalene produces effects similar to those of dinoprost and the other class F prostaglandins. It is labeled for synchronization of estrus and as an agent to induce abortion (at 150 days or fewer of gestation) in cattle.

Clinical Uses

Fenprostalene is used for induction of abortion in feedlot heifers and for synchronization of estrus in beef and nonlactating dairy cows. It should be administered subcutaneously.

Dosage Form

Bovilene. Fenprostalene for injection

Adverse Side Effects

These can include infection at the injection site and abortion (when not an indication for use).

Technician's Notes

1. Do not administer by intravenous injection.
2. Skin that is exposed should be washed off immediately.
3. Pregnant women, asthmatic individuals, and those with bronchial disease should handle this product with great caution.

Fluprostenol

Fluprostenol is a synthetic analog of prostaglandin $F_{2\alpha}$ for use in mares.

Clinical Uses

1. Estrus synchronization in cycling mares
2. To establish estrus cycles in anestrus mares
3. To induce parturition in mares
4. To treat lactational anestrus
5. For facilitation of postpartum (after foal-heat) breeding

Dosage Form

Equimate. Fluprostenol for injection

Adverse Side Effects

These can include sweating, increased respiration, abdominal discomfort, and defecation.

Technician's Notes

See the sections on dinoprost and fenprostalene.

Cloprostenol Sodium

Cloprostenol sodium is an analog of prostaglandin $F_{2\alpha}$ for use in cattle. This product is chemically very similar to dinoprost and fenprostalene and is labeled for uses in cattle that are very similar to those of dinoprost and fenprostalene. The same precautions should be taken when this drug is used as are taken with the other prostaglandins.

Clinical Uses

This drug is used for treatment of luteal cysts and mummified fetuses, termination of pregnancy, and estrus synchronization.

Dosage Form

1. Estrumate. Cloprostenol for injection

Adverse Side Effects

At high doses, adverse side effects may include uneasiness, frothing at the mouth, and milk letdown.



Drugs That Affect Uterine Contractility

Several drugs have the ability to increase the contractility of uterine muscle. Some are used during pregnancy to cause abortion, and others are used at term to induce parturition, to aid in delivery of the fetus or the placenta, and to cause **involution** of the uterus after delivery. Great care should be taken to ensure that the cervix is dilated before these drugs are administered.

One of these drugs, oxytocin, also causes contraction of the myoepithelial cells in the mammary glands to facilitate milk letdown.

Oxytocin

Oxytocin is a polypeptide made in the hypothalamus and stored in the posterior pituitary for release in response to appropriate stimuli from the reproductive tract or mammary glands. This hormone

causes stronger uterine contractions by increasing the contractility of uterine **myofibrils**. The uterus must be primed for a period by progesterone and estrogen before oxytocin is effective in stimulating the uterus.

Oxytocin is used clinically to cause more forceful uterine contractions as an aid in delivery of a fetus. It is also used to assist delivery of the placenta, to cause uterine involution, and to reduce bleeding of the uterus after delivery. It should be used only when the cervix is sufficiently dilated and when it can be determined that the fetus can be delivered normally through the pelvic canal.

This hormone is responsible for milk letdown from the mammary glands through its stimulation of myoepithelial cells in the alveolar wall of the glands. It is released endogenously after stimulation of the udder or in response to environmental stimuli, such as the sound of milking machines or other sights, sounds, or smells associated with nursing/milking.

Clinical Uses

1. To augment the force of uterine contractions during delivery
2. To aid in delivery of the placenta
3. To facilitate involution of the uterus (to reduce bleeding or to facilitate replacement of a prolapse)
4. To induce milk letdown
5. To assist in the treatment of agalactia in sows

Dosage Form

Oxytocin injection is available in generic form from many sources.

Adverse Side Effects

These are minimal when used according to recommendations.

Technician's Notes

1. Oxytocin should be used in **dystocia** only when the reproductive tract has been adequately examined. Inappropriate use can result in uterine torsion or rupture, and can lead to death.
2. A single dose of oxytocin lasts approximately 15 minutes.
3. Oxytocin is stored under refrigeration.

Ergot

Ergot is a fungus that grows on rye grass and possibly on some pasture grasses. It causes smooth muscle contraction and can cause intense vasoconstriction. If the vasoconstriction is severe enough, gangrene and sloughing may occur.

Ergonovine maleate has been used in veterinary medicine because it produces uterine contractions similarly to oxytocin. It results in very little vasoconstrictive action, however. This product is not commonly used.

Prostaglandins

Prostaglandins, as mentioned in a previous section, stimulate uterine smooth muscle and can be used to induce parturition or abortion.

Corticosteroids

Corticosteroids comprise a group of hormones produced by the adrenal cortex that are used primarily for their antiinflammatory effect but can cause induction of parturition in the last trimester of pregnancy. This effect occurs because exogenous administration of the drug mimics the natural rise in production of corticosteroids by the fetus as the time for delivery draws near. Induction of parturition or abortion is not a labeled use for the corticosteroids, but they have been applied clinically for this purpose.



Miscellaneous Reproductive Drugs

Bromocriptine

Bromocriptine is a dopamine agonist and prolactin inhibitor that has been used mainly in dogs for pregnancy termination after mismating or for the treatment of pseudopregnancy.

Leuprolide

Leuprolide is a synthetic analog of gonadotropin-releasing hormone that is used for the treatment of adrenal endocrinopathy in ferrets and for the treatment of inappropriate egg laying in cockatiels.

Melatonin

Melatonin is a naturally occurring hormone that is produced in the pineal gland. In addition to its use in the treatment of alopecia in dogs and sleep

disorders in cats and dogs, melatonin has been used to improve early breeding and ovulation in sheep and goats.

Neutersol

Neutersol is a U.S. Food and Drug Administration (FDA)-approved product that contains the amino acid L-arginine and a zinc salt; it is administered directly into the testicles of puppies to cause permanent sterility. It reportedly does not eliminate testosterone production and its associated behavioral characteristics, however.



Pheromones

Pheromones are odors released by animals that influence the behavior of other animals of the same species. Although pheromones do not fit exactly into the endocrine category, they are considered in this section.

The first pheromone made commercially available was a boar odor aerosol called SOA/Sex. This product is a synthetic version of the natural pheromone that causes the typical boar odor and is used for heat detection in sows and gilts. Label instructions call for spraying the pheromone directly at the nostrils of the sow or gilt for 2 seconds. If the sow or gilt is in heat, she will demonstrate mating reflexes—such as rigid posture, deviations of the tail, and erect ears.

Another pheromone product is Feliway. Feliway is an analog of the feline facial pheromone. It is labeled for use in stopping or preventing urinary marking by the cat and to comfort the cat in an unknown or stressful environment. Cats deposit facial pheromones by rubbing an object with the side of the face. The manufacturer recommends spraying this product directly onto the places soiled by the cat and also on prominent objects that could be attractive to the cat. The product should be applied daily at a height of 8 inches from the floor until the cat is seen rubbing the area with its head. Feliway can also be used to familiarize cats with new environments, such as carriers and cages. It may be dispensed over a large area with the use of a plug-in diffuser.

Another pheromone available in the veterinary market is called D.A.P. (dog-appeasing hormone). The manufacturer indicates that this product mimics the appeasement pheromones, which female dogs secrete to comfort and reassure their nursing puppies. Label indications for use include calming dogs during stressful situations, such as thunderstorms, fireworks, visits by strangers, or moving the dog to a new environment. It is dispensed via a plug-in diffuser.

THYROID HORMONES

The thyroid gland is made up of two lobes (one on each side of the trachea) and is located near the thyroid cartilage of the larynx. Microscopically, the thyroid is composed of follicles that, on stimulation by TSH from the anterior pituitary, produce two metabolically active hormones. The thyroid synthesizes these hormones by first trapping iodide from the blood and then oxidizing the iodide to iodine. The iodine is combined with the amino acid tyrosine to form (through several intermediary steps) T_3 and T_4 . T_3 is considered to be the active form at the cellular level. Although both T_3 and T_4 are released from the thyroid gland, some of the T_4 is converted to T_3 after release. T_4 , also called *thyroxine*, is found in higher levels than T_3 in **euthyroid** animals.

Thyroid hormones control many events in the body, including metabolic rate, growth and development, body temperature, heart rate, metabolism of nutrients, skin condition, resistance to infection, and others. Two abnormalities of thyroid function that are encountered in veterinary medicine are hypothyroidism and hyperthyroidism.

Hypothyroidism is noted most often in dogs and is characterized by lethargy, cold intolerance, dry haircoat, and bradycardia. Hyperthyroidism is encountered more often in older cats and is accompanied by weight loss, increased appetite, restlessness, hyperexcitability, and tachycardia. Diagnosis of thyroid conditions is made by observing clinical signs and by measuring serum levels of T_3 and T_4 before and after TSH administration.

Goiter is a condition that is caused by inadequate levels of iodide in the diet. Lack of iodide causes the thyroid to be unable to produce T_3 or T_4 .

The thyroid attempts to increase its output by enlarging, often to a size that can be palpated and visualized. Goiter is almost nonexistent in animals receiving a commercial diet.



Drugs Used to Treat Hypothyroidism

Treatment of hypothyroidism consists of supplementation of thyroid hormones on a daily basis. Clinical signs usually resolve within a short time of treatment initiation, but lifelong therapy is required.

Thyroid hormones can be extracted from thyroid glands or can be prepared synthetically. Purification of the animal source hormones is difficult and has led to the common use of synthetic products. Synthetic thyroxine (T_4) is considered to be the compound of choice in the treatment of hypothyroidism. T_3 products are recommended only when a poor response to T_4 occurs.

Levothyroxine Sodium (T_4)

Levothyroxine is a synthetic **levo isomer** of T_4 . It is the compound of choice for the treatment of hypothyroidism in all species.

Clinical Uses

Levothyroxine is used for the treatment of hypothyroid conditions.

Dosage Forms

1. Soloxine. Levothyroxine tablets, approved for dogs
2. Thyro-Form. Levothyroxine chewable tablets, approved for dogs
3. Thyro-L. Levothyroxine powder, approved for horses
4. NutriVed T-4 Chewables. Levothyroxine chewable tablets, approved for dogs
5. Thyro-Tab. Levothyroxine tablets for dogs
6. Equine Thyroid Supplement
7. Thyrozine Tablets. Levothyroxine tablets for dogs
8. Synthroid. Levothyroxine tablets approved for humans
9. Leventa. Levothyroxine in a small-volume liquid form

Adverse Side Effects

These are rare when used according to recommendations.

Liothyronine Sodium

Liothyronine sodium (T_3) is a synthetic salt of endogenous T_3 . T_3 is not the compound of choice for the treatment of hypothyroidism. It may be useful, however, in cases that do not respond well to T_4 .

Clinical Uses

T_3 is used for the treatment of hypothyroidism in cases that respond poorly to T_4 .

Dosage Forms

1. Cytobin Tablets. Liothyronine sodium tablets, approved for dogs
2. Cytomel. Human label

Adverse Side Effects

These are probably minimal with careful use.

Thyroid-Stimulating Hormone

Thyrotropin is a purified form of TSH obtained from the anterior pituitary in cattle. It is used as an aid in the diagnosis of hypothyroidism.

Clinical Uses

In veterinary medicine, thyrotropin is used for diagnosis of **primary hypothyroidism** in the TSH stimulation test.

Dosage Forms

1. Dermathycin. TSH approved for use in dogs
2. Thytropar. TSH approved for use in humans

Adverse Side Effects

Allergic reactions may occur in animals sensitive to bovine protein.

Drugs Used to Treat Hyperthyroidism

Treatment of hyperthyroidism is directed at lowering blood levels of T_3 and T_4 . This can be accomplished by destruction or removal of the

overproducing thyroid or by blocking of hormone production. The thyroid can be removed surgically or destroyed with radioactive iodine. Drug therapy to block hormone production can be effective but is continuous and is not curative.

The two antithyroid drugs used most often are methimazole and carbimazole. These compounds are used for long-term therapy and for presurgical preparation of patients. Hyperthyroid cats are often high surgical risks, primarily because of tachycardia and other potential cardiac abnormalities.

Methimazole

Methimazole is a compound that interferes with incorporation of iodine into the precursor molecules of T_3 and T_4 . It does not alter thyroid hormones already released into the bloodstream.

Clinical Uses

Methimazole is used for the treatment of feline hyperthyroidism.

Dosage Form

Tapazole. Methimazole tablets (human approved)

Adverse Side Effects

These include anorexia, vomiting, and skin eruptions. Kittens should be placed on a milk replacement after receiving colostrum from mothers on methimazole.

Carbimazole

Carbimazole is a product similar to methimazole that is used in Canada and other countries. Most of this drug is converted to methimazole after administration to the cat. It inhibits the synthesis of thyroid hormones.

Clinical Uses

Carbimazole is used for the treatment of feline hyperthyroidism.

Dosage Forms

1. Carbazole. Human label
2. Neo-Carbazole. Human label

Adverse Side Effects

Side effects are similar to those of methimazole.

Iodate

Iodate is an orally administered, radiopaque, organic iodine compound that is thought to inhibit the conversion of T_4 to T_3 .

Clinical Uses

Iodate may be helpful in the treatment of hyperthyroidism in cats that are not tolerant of methimazole or carbimazole.

Dosage Form

Oragrafin. Human label

Propylthiouracil

Propylthiouracil has been used as an antithyroid drug but is considered dangerous for use in cats because of potential hematologic complications.

Radioactive Iodine

Radioactive iodine (I-131) may be given intravenously to destroy overproductive thyroid tissue. I-131 concentrates in the thyroid, where it remains and destroys thyroid tissue. This method has appeal because it is performed only once and is not especially stressful to patients. However, it must be done at facilities that can handle radioactive materials.

Propranolol

Propranolol (Inderal) may be used preoperatively to treat the tachycardia associated with hyperthyroidism in cats.



Agents for the Treatment of Diabetes Mellitus

Insulin

The pancreas produces two principal hormones in special cells of the islets of Langerhans: insulin and glucagon. Insulin is produced by beta cells, and glucagon is produced by alpha cells. Insulin causes a decrease in blood glucose levels, and glucagon promotes an increase. Only insulin is used clinically.

Insulin facilitates cellular uptake of glucose and its storage in the form of glycogen and fat. It inhibits the breakdown of fat, protein, and glycogen into forms that may be used as energy sources. Further, it

promotes synthesis of protein, fatty acids, and glycogen. In the absence of insulin, the body cannot use glucose and must break down its own fat and protein that can be used for energy.

Diabetes mellitus is a complex disease that results from inability of the beta cells of the pancreas to produce enough insulin or from altered insulin action within cells. Diabetes mellitus that results from inadequate secretion of insulin is called *type I*, or *insulin-dependent, diabetes mellitus*. This is the most common type of diabetes mellitus in dogs and cats. Diabetes mellitus that results from resistance of tissue to the action of insulin is called *type II*, or *noninsulin-dependent, diabetes mellitus (NIDDM)*. NIDDM is rare in dogs but is occasionally encountered in cats.

Both forms of diabetes mellitus eventually cause polydipsia, polyuria, polyphagia, and weight loss. Untreated diabetes mellitus proceeds to the condition called *diabetic ketoacidosis*, in which body fat is metabolized as a substitute energy source. Metabolism of body fat results in accumulation of byproducts of this process called *ketone bodies*, which promote a metabolic acidosis that can lead to death.

Because blood glucose levels can be increased by corticosteroids, epinephrine, and progesterone, these drugs should be given with caution to diabetic animals. Sudden changes in diet and exercise level should also be avoided because they can alter blood glucose levels and cause an imbalance in the ratio of insulin to glucose.

Insulin is not effective when given orally because the digestive tract breaks down the protein molecule before it can be absorbed. Insulin usually is administered by subcutaneous injection. However, some forms may be given intravenously or intramuscularly.

Sources of insulin have traditionally included beef or pork pancreas and preparations consisting of a purified (pure beef source or pure pork source) form or a combination beef/pork form. The beef/pork form is best suited to the treatment of diabetes mellitus in dogs and cats. Pork insulin is very close in structure to dog and human insulins, whereas beef insulin is very similar to cat insulin.

Most human insulin products are now prepared through recombinant DNA or synthetic processes.

Only one animal labeled product is currently approved for use in the United States. The availability of insulin products is subject to change, and technicians should always consult current information when dealing with diabetic patients.

Insulin concentration is measured in units of insulin per milliliter. It is available in concentrations of 40 (U-40), 100 (U-100), and 500 (U-500) U/ml. All products for human use are U-100 concentrations.

A U-40 concentration makes administering the small amounts of insulin needed for cats and small dogs much easier. When insulin is drawn into the syringe, each mark on the syringe barrel denotes 1 U of insulin. Drawing up 5 U on a scale of 40, for example, is easier than drawing up 5 U on a scale of 100. Small-volume U-100 syringes are available, however, to facilitate administration of small doses of U-100 insulin.

U-40 syringes must be used with U-40 insulin, and U-100 syringes must be used with U-100 insulin. Table 9-2 lists the available insulin syringes.

INSULIN CLASSIFICATIONS

Insulin is usually classified according to its duration of action as short acting, intermediate acting, or long acting. Short-acting insulins include regular, lispro, and aspart. NPH, PZI, and Lente are intermediate-acting insulins. Glargine and detemir are long-acting products (Hess, 2006). Two different forms are sometimes combined in the same preparation. See Table 9-3 for a partial listing of insulin products in each category. Because insulin products and classifications tend to change periodically, the technician involved in treating diabetic animals should keep up with current literature on the topic.

The onset of effect and route of administration are other important characteristics of insulin

Table 9-2 Insulin Syringes

Name and Manufacturer	Insulin	Needle Gauge	Needle Size	Packaging
1-ml Syringes				
B-D Microfine IV	U-100	28	½ inch	100 (10 packs of 10)
B-D Microfine	U-100	27	⅝ inch	100 (10 packs of 10)
B-D Microfine IV	U-40	28	½ inch	100 (10 packs of 10)
Can-Am E-Z Ject	U-100	27	½ inch	100 (individually wrapped)
Can-Am E-Z Ject	U-100	28	½ inch	100 (individually wrapped)
Monoject Ultra Comfort 28	U-100	28	½ inch	100 or 30 (individually wrapped)
Pharma-Plast	U-100	28	½ inch	100 (10 packs of 10)
Terumo	U-100	29	½ inch	100 (individually wrapped)
Terumo	U-100	27	½ inch	100 (individually wrapped)
0.25-ml Syringes				
Terumo	U-100	29	½ inch	100 (individually wrapped)
0.5-ml Syringes				
B-D Microfine IV	U-100	28	½ inch	100 (10 packs of 10)
Can-Am E-Z Ject	U-150	28	½ inch	100 (individually wrapped)
Monoject Ultra Comfort 28	U-100	28	½ inch	100 or 30 (individually wrapped)
Pharma-Plast	U-100	28	½ inch	100 (10 packs of 10)
Terumo	U-100	29	½ inch	100 (individually wrapped)
Terumo	U-100	27	½ inch	100 (individually wrapped)
0.3-ml Syringes				
B-D Microfine IV	U-100	28	½ inch	100 (10 packs of 10)

From Peterson ME: Insulin and insulin syringes. In Kirk RW, Bonagura JD, editors: Current veterinary therapy XI: small animal practice, Philadelphia, 1992, WB Saunders Co, p. 358.

Table 9-3 Insulin Products Commonly Used in Dogs and Cats

Brand Name	Generic Name	Source	Duration	Manufacturer	Concentration
Humulin R Novolin R	Regular insulin	Human recombinant	Short	Eli Lilly Novo Nordisk	U-100
Humulin N Novolin N	NPH	Human recombinant	Intermediate	Eli Lilly Novo Nordisk	U-100
Vetsulin	Lente	Pork	Intermediate	Intervet	U-40
PZI Vet	PZI	Beef 90%, pork 10%	Intermediate	IDEXX	U-40
Lantus	Glargine	Human recombinant	Intermediate to long	Aventis	U-100

preparations to be considered. For an in-depth discussion of insulin forms and characteristics, other references should be consulted.

SHORT-ACTING INSULIN

Regular insulin/lispro/aspart. Regular insulin is a fast-acting insulin that is made from zinc insulin crystals; it is a clear solution that may be administered intravenously, intramuscularly, or subcutaneously. It is used mainly to treat diabetic ketoacidosis until blood glucose levels are reduced and the animal is metabolically stable. At that time, the animal is usually switched to a longer-acting form. Lispro and aspart insulins are not used in dogs and cats at this time.

Clinical Uses

Regular, lispro, and aspart insulins are used primarily for the treatment of diabetic ketoacidosis.

Dosage Forms

Many products approved for humans are available. Following is a partial listing:

1. Humulin R
2. Novolin R
3. Humalog
4. NovoLog
5. Apidra

Adverse Side Effects

These usually are related to overdose and may include weakness, ataxia, shaking, and seizures.

Technician's Notes

1. Although not required by label on the newer products, refrigeration probably enhances storage life. Do not freeze.
2. Do not use regular insulin preparations if discoloration or precipitates are present.

INTERMEDIATE-ACTING INSULIN

NPH (Neutral Protamine Hagedorn) Insulin/PZI (Protamine Zinc Insulin)/Lente. NPH insulin is a cloudy suspension of zinc insulin crystals and protamine zinc. Protamine (a fish protein) and zinc prolong the absorption and activity of the product. These insulins are longer acting than regular insulin. They are commonly used for the control of uncomplicated diabetes in dogs and cats. Lente insulin is similar in activity to NPH insulin but is made without the use of protamine.

Clinical Uses

NPH insulin is used in the treatment of uncomplicated diabetes mellitus.

Dosage Forms

A partial listing follows:

1. Humulin N
2. Novolin N
3. Vetsulin
4. PZI Vet

Adverse Side Effects

These are similar to those of regular insulin.

Technician's Notes

1. Resuspension, by gently rolling the bottle, is required before the product is withdrawn from the bottle.
2. Store in the manner of regular insulin. Do not freeze.
3. NPH insulin is usually administered once a day.

LONG-ACTING INSULIN

Glargine (Lantus) and detemir (Levemir) insulin are long-acting insulins with a human label. Lantus is marketed as a peakless insulin. Care should be taken to avoid confusing Lantus and Levemir with other clear insulins.

Clinical Uses

Glargine is used for the treatment of uncomplicated diabetes mellitus.

Dosage Forms

Lantus. Clear, long-acting glargine insulin
Levemir. Clear, detemir insulin.

Adverse Side Effects

These are similar to those of regular and intermediate-acting insulins.

Technician's Notes

Humulin L, Humulin U, Iletin II regular pork insulin, and Iletin II NPH pork insulin were discontinued by Eli Lilly in 2005.

USE OF INSULIN PRODUCTS

Technicians who are counseling clients about the use of insulin products should take great care to become thoroughly familiar with the products they are using. The onset of action of various insulin products can vary from a few minutes to a few hours. Peak activity time and duration of activity can also vary greatly between products. Exercise

levels and eating patterns may influence insulin activity. An overdose of insulin can lead to various degrees of hypoglycemia that produce clinical signs ranging from mild weakness to coma. Clients should be shown how to give subcutaneous injections of insulin, and they should be given written instructions about monitoring insulin response and making appropriate adjustments. Tips regarding the use of insulin products follow as Technician's Notes.

Technician's Notes

1. It is usually best to feed the animal 30 minutes before giving the insulin injection.
2. Roll "cloudy" insulins between your palms; do not shake.
3. NPH insulin should not be mixed with any Lente insulin.
4. It is the opinion of some people that insulin should be disposed of after 30 days or 100 injections.
5. Injection sites should be rotated.
6. Clients should be advised to use insulin syringes only once.
7. Mild to moderate hypoglycemia resulting from an overdose can be treated by feeding the animal or administering Karo syrup.

Oral Hypoglycemic Agents

Oral hypoglycemic agents such as the sulfonylureas are extensively used in human diabetic patients to control type II diabetes mellitus (NIDDM). They have little apparent effectiveness in diabetic dogs but may be useful in some cats with type II diabetes. Drugs in this category include glipizide (Glucotrol) and metformin (Glucophage XR).

**Hyperglycemic Agents**

Several drugs such as corticosteroids, epinephrine, and progesterone incidentally elevate blood glucose levels. Two products that are marketed for this purpose, however, are diazoxide (Proglycem) and octreotide (Sandostatin). These are used to treat the low blood glucose levels associated with hypersecretion of insulin that occurs in tumors of the beta cells

of the pancreas (insulinoma) in dogs and ferrets (Plumb, 2005). These products act by inhibiting the release of insulin from beta cells of the pancreas.

HORMONES THAT ACT AS GROWTH PROMOTERS

Sex Steroids, Synthetic Steroid Analogs, and Nonsteroidal Analogs

The factors that control growth, feed efficiency, and carcass composition in animals involve a complex interrelationship between genetic, metabolic, and hormonal mechanisms that are not always totally understood. It is possible, however, to increase growth (weight gain) in ruminants by administering sex steroid hormones (estrogen, testosterone, or progesterone), synthetic steroid hormone analogs (trenbolone), or certain nonsteroidal hormone analogs (zeranol).

The primary sex steroid used to promote weight gain is estrogen (estradiol). The mechanisms by which estradiol promotes weight gain include (1) increased water retention, (2) increased protein synthesis, (3) increased fat deposition, and (4) possible increased release of growth hormone (bovine somatotropin).

Testosterone is used as an adjunct to estradiol in some growth-promotion products because it is an anabolic agent in itself, and because a second component in the compound slows down the release of estradiol and prolongs its effective life span.

Progesterone is also added to growth promoters to slow the release of estradiol. It apparently has little anabolic effect of its own.

Trenbolone is a synthetic anabolic agent that improves feed efficiency and promotes weight gain in steers. It is used as the sole agent in some growth-promoting preparations.

Zeranol is an analog of a naturally occurring plant estrogen that increases feed efficiency, protein synthesis, and growth rate.

All of the growth-promoting products for use in cattle and sheep are prepared as compressed pellets that are implanted in the subcutaneous tissue of the dorsal, middle third of the ear (Figure 9-5). These

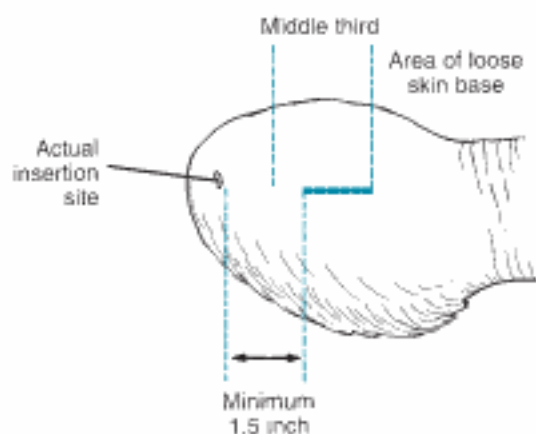

FIGURE 9-5 Implantation site for growth-promoting pellets (posterior view of the ear).

pellets are designed for use with corresponding needle devices and should be implanted with close adherence to product instructions (failure to do so is a violation of federal law in some cases).

The growth-promotion products are considered here as a group, and minimal information is provided about each product.

Clinical Uses

These drugs are used to promote feed efficiency and weight gain in calves, steers, heifers, or sheep (depending on the product).

Dosage Forms

1. Synovex C. Estradiol/progesterone implant for use in calves older than 45 days
2. Synovex H. Estradiol/testosterone implant for use in heifers
3. Synovex S. Estradiol/testosterone implant for use in steers
4. Compudose. Estradiol implant for use in steers
5. Implus-H. Estradiol/testosterone implant for use in heifers
6. Implus-S. Estradiol/progesterone for use in steers
7. CALF-oid Implant. Progesterone/estradiol implant for calves older than 45 days
8. Finaplix-H. Trenbolone implant for use in feedlot heifers
9. Finaplix-S. Trenbolone implant for steers

10. Revalor-S. Trenbolone and estradiol implant for use in feedlot steers
11. Ralgro beef cattle implant. Zeranol implant for use in growing cattle, feedlot heifers, feedlot steers, and suckling and weaned calves
12. Ralgro feedlot lamb implant. Zeranol implant for feedlot lambs

Adverse Side Effects

These may include mounting, elevated tail heads, rectal prolapse, and udder development.

Technician's Notes

1. Most growth-promoting implants should not be given to animals intended for breeding purposes or to dairy cattle.
2. Product insert instructions for these products should be read and followed carefully.

Growth Hormone: Bovine Somatotropin, Bovine Growth Hormone

Growth hormone, also called *somatotropin*, is a hormone produced by the anterior pituitary. Its function before the onset of puberty is to stimulate growth. It is released throughout life to promote anabolic activity (e.g., to increase protein synthesis). It has been shown to increase growth rate and feed efficiency in farm animals. Many of the growth-promoting agents listed in the previous section may work by stimulating the release of somatotropin. Somatotropin is a potent stimulator of milk production as well. Claims of a 20% boost in milk production in dairy cows have been made after administration of somatotropin.

The FDA approved a recombinant (genetically engineered) bovine somatotropin (BST) for commercial production in 1993. This product, Posilac, is manufactured by the Monsanto Co. Its market availability has sparked intense debate among certain groups. Some dairy producers have opposed its use because of their fear that increased production would drive milk prices down and reduce their overall income. Other groups have resisted the use of BST because of their concerns about residues of the hormone

in milk products, even though the FDA has stated that milk from cows receiving BST is completely safe. People who advocate the use of "organic" food products may oppose the use of this product.

ANABOLIC STEROIDS

Anabolic steroids are steroids that produce a tissue-building (anabolic) effect. Testosterone is a naturally occurring anabolic steroid that produces masculinization in addition to its anabolic effects. Synthetic anabolic steroids are designed to prevent most masculinizing effects.

Anabolic steroid administration causes positive **nitrogen balance** and reverses processes that break down tissue. An increase in appetite, weight gain, improved overall condition, and recovery are promoted. These products are labeled for clinical use in dogs, cats, and horses for anorexia, weight loss, and debilitation. In working animals, they may be used in cases of overwork or overtraining. Anabolic steroids also promote red blood cell formation and are used to treat some forms of anemia. The product insert for a commonly used product states that "anabolic therapy is intended primarily as an adjunct to other specific and supportive therapy, including nutritional therapy."

Because of the potential for abuse by bodybuilders and other athletes, the FDA has now classified anabolic steroids as C-III controlled substances.

Stanozolol

Stanozolol is an anabolic steroid that has been found to have an unusual pattern of biologic activity in that its anabolic effect far outweighs its weak androgenic influence.

Clinical Uses

Stanozolol is used for the treatment of anorexia, debilitation, weight loss, overwork, and anemia.

Dosage Forms

1. Winstrol-V. Stanozolol sterile suspension for injection in dogs, cats, and horses
2. Winstrol-V. Stanozolol tablets for use in dogs and cats

Adverse Side Effects

These may include mild androgenic effects after prolonged use or overdose.

Technician's Notes

1. Winstrol-V should not be used in pregnant dogs, mares, or stallions.
2. Winstrol-V should not be given to horses intended for food uses.

Boldenone Undecylenate

Boldenone undecylenate is a steroid ester that possesses marked anabolic activity and a minimal amount of androgenic activity. It is labeled for use in horses.

Clinical Uses

Boldenone undecylenate acts as an aid in the treatment of debilitated horses.

Dosage Form

Equipoise. Boldenone injection for horses

Adverse Side Effects

These include androgenic effects such as overaggressiveness.

Technician's Notes

1. Boldenone should not be used in horses intended as food.
2. Boldenone should not be used in stallions or in pregnant mares.

Nandrolone Decanoate

Nandrolone decanoate is an injectable anabolic steroid sold under the human label Deca-Durabolin. It exhibits activity similar to that of the other anabolic agents.

REFERENCES

- Boothe DM: Drug therapy for endocrinopathies. In Boothe DM, editor: Small animal clinical pharmacology, Philadelphia, 2001, WB Saunders.
- Plumb DC: Veterinary drug handbook, ed 5, Ames, 2005, Iowa State University Press.
- Hess RS: New and old insulin products, International Veterinary Emergency and Critical Care Symposium (IVECCS) Proceedings, San Antonio, September 17-21, 2006.



REVIEW QUESTIONS

- Describe the relationship between hormonal releasing factors, trophic hormones, and the hormones produced by specific tissues or glands.

- List the major endocrine glands.

- What are the reasons for using hormonal therapy in veterinary medicine?

- Endogenous hormones are those that are produced _____, whereas exogenous hormones come from _____ sources.
- Where is the pituitary gland located, and what is its function? _____
- Describe the difference between a negative and a positive feedback control mechanism in the endocrine system.

- The release of oxytocin by the posterior pituitary is controlled through the _____ mechanism.
- GnRH is classified as a/an _____.
- Hormonal products with “gest” in their name are classified as _____.
- List three potential uses of the prostaglandins in veterinary medicine.

- Human skin contact or injection with prostaglandins can be a serious health risk to _____ women and _____.
- Before oxytocin can exert its effects on the uterus, the uterus must first be primed by _____ and _____.
- What precautions should be taken before oxytocin is administered?

- What two active hormones are produced by the thyroid gland?

- List two drugs used in the treatment of hypothyroidism. _____
- List the three major classes of insulin.

- Which form of insulin is used in the treatment of diabetic ketoacidosis?

- Which form(s) of insulin must be resuspended before administration?

- What are some signs of insulin overdose?

- Growth promoters generally should not be used in animals intended for _____.
- Why are anabolic steroids classified as controlled substances? _____
- _____ are odors released by animals that influence the behavior of other animals of the same species.
- What precautions should be taken by pregnant women when Regu-Mate is administered?

- Why was synthetic DES banned from use in food-producing animals?

- Prostaglandin causes lysis of the _____ at the end of pregnancy or at the end of diestrus if pregnancy does not occur.
- Endometrium lines the _____.
a. kidney
b. stomach
c. intestines
d. uterus

27. A _____ hormone is one that results in the production of a second hormone within a target gland.
- gonadotropin
 - euthyroid
 - trophic
 - myofibril
28. GnRH is produced in the _____.
- pancreas
 - thymus
 - thyroid gland
 - hypothalamus
29. All the following drugs are gonadotropins, except _____.
- estradiol cypionate
 - Cystorelin
 - Factrel
 - Fertagyl
30. Androgens are female sex hormones produced in the ovaries, adrenal cortex, and testicles.
- True
 - False
31. Prostaglandins are a group of naturally occurring, long-chain fatty acids that mediate various physiologic events in the body.
- True
 - False
32. _____ causes uterine contractions.
- Regu-Mate
 - Bovilene
 - Oxytocin
 - Cystorelin
33. Corticosteroids are produced by _____.
- the thyroid gland
 - the adrenal cortex
 - the kidneys
 - the hypothalamus
34. Pheromones are _____ released by an animal that influence the behavior of other animals of the same species.
- hormones
 - gonadotropins
 - steroids
 - odors
35. Levothyroxine is used in the treatment of _____ in all species.
- hypoglycemia
 - hypothyroidism
 - hypokalemia
 - hypocalcemia

MySpharm

MIOTICS

Pilocarpine
Demecarium Bromide

**OTHER AGENTS THAT REDUCE
INTRAOCULAR PRESSURE**

Carbonic Anhydrase Inhibitors
Beta-Adrenergic Antagonists

Timolol Maleate
Betaxolol
Carteolol
Levobunolol
Nephranolol

Sympathomimetics

Apraclonidine
Brimonidine

Topical Prostaglandins

Osmotic Diuretics

Mannitol
Glycerol

TOPICAL ANESTHETICS

Proparacaine Hydrochloride
Tetracaine and Tetracaine Hydrochloride

OPHTHALMIC STAINS

COLLAGEN SHIELDS

**TOPICAL OPHTHALMIC
ANTIINFECTIVES**

Antiviral Agents
Antifungal Agents
Antibacterial Agents

**TOPICAL OPHTHALMIC
ANTIINFLAMMATORY AGENTS**

Nonsteroidal Agents
Topical Corticosteroid Agents

**AGENTS FOR THE TREATMENT OF
KERATOCONJUNCTIVITIS SICCA**

Cyclosporine
Artificial Tear Products and Ocular Lubricants

**MISCELLANEOUS OPHTHALMIC
AGENTS**

Anticollagenase Agents
Viscoelastic Substances

Otic Drugs

**TOPICAL OTIC ANTIINFECTIVE
AGENTS**

Gentamicin Sulfate
Chloramphenicol
Neomycin Sulfate
Ertromycin

ANTIPARASITICS

Pyrethrins
Rotenone
Ivermectin/Milbemycin

DRYING AGENTS

CLEANING AGENTS

MISCELLANEOUS OTIC AGENTS

Tris-EDTA
Silver Sulfadiazine

CHAPTER 10

Drugs Used in Ophthalmic and Otic Disorders

LEARNING OBJECTIVES

After studying this chapter, you should be able to:

1. Describe the clinical indications for common ophthalmic and otic agents.
2. Identify the different classes of ophthalmic and otic agents.
3. Identify the possible adverse reactions and contraindications of many commonly used agents.



KEY TERMS

CLOSED-ANGLE GLAUCOMA A type of primary glaucoma of the eye that is characterized by a shallow anterior chamber and a narrow angle that compromises filtration because the iris is blocking the angle and is causing an increase in intraocular pressure.

CONJUNCTIVITIS Inflammation of the conjunctiva.

CYCLOPLEGIA Paralysis of the ciliary muscle.

ECTROPION A rolling outward (i.e., away from the eye) or sagging of the eyelid. Many times, the conjunctiva is plainly visible.

ENTROPION A rolling inward (i.e., toward the cornea) of the eyelid.

GLAUCOMA A group of eye diseases characterized by increased intraocular pressure that results in damage to the retina and the optic nerve.

KERATITIS Inflammation of the cornea.

MYDRIASIS Dilation of the pupil.

OPEN-ANGLE GLAUCOMA A type of primary glaucoma of the eye in which the angle of the anterior chamber remains open, but filtration of the aqueous humor is gradually reduced, causing an increase in intraocular pressure.

UVEA The vascular layer of the eye that comprises the iris, ciliary body, and choroid.

UVEITIS Inflammation of the uvea.

OPHTHALMIC AGENTS

Although the sense of smell is highly developed in many animals, the sense of sight plays an important role in an animal's health and well-being. Cats rely on excellent eyesight because they are animals of prey. This prey trait provides many cat owners with amusement and laughter when a string or a feather toy is pulled around the house with a cat running behind in rapid pursuit. Horses rely on good eyesight to perform their best for human companions. Police dogs, hunting dogs, seeing-eye dogs, and herd-working dogs rely on their eyesight to interpret owners' hand signals when working in the field.

A good ocular examination includes an examination of the external ocular features (eyelids, sclera, cornea, third eyelid [nictitating membrane]) and the internal ocular features (anterior chamber, iris, lens), all of which can be seen without highly specialized equipment (McCurnin, 2006). Some dog breeds (Shar-Pei, cocker spaniels, English bulldogs, and others) are genetically predisposed to conditions that may require surgery. Two of these conditions are known as **entropion** and **ectropion**.

Topical administration of eye drops or ointment is the most common method of treatment involving disorders of the eye. It is the veterinary technician's

duty to educate the client by demonstrating the proper way to administer eye medication. Products for ocular treatment are usually available as solutions or ointments. Drug penetration is one factor that veterinarians must consider when choosing a topical ophthalmic agent. Topical agents are more readily absorbed into the anterior chamber than the posterior chamber. For this reason, these agents have limited use in posterior eye disorders. Systemic agents may be more effective. Lipid-soluble agents readily penetrate the corneal epithelium and endothelium layers. Water-soluble agents readily penetrate the corneal stroma layer (Figure 10-1). Most topical ophthalmic medications require several applications per day because the eye continuously secretes tears that wash away the medication. Ointments tend to necessitate less frequent applications than do drops. However, ointments may blur an animal's vision for a short period after application. Client education is invaluable during treatment of an eye disorder.

Clients placing telephone calls to the veterinary hospital to discuss a potential eye problem in a patient should be made to realize that these situations may be considered an emergency. Unfortunately, some clients tend to let an ocular problem progress to severe stages before treatment is sought. Veterinary technicians should remind clients that animals

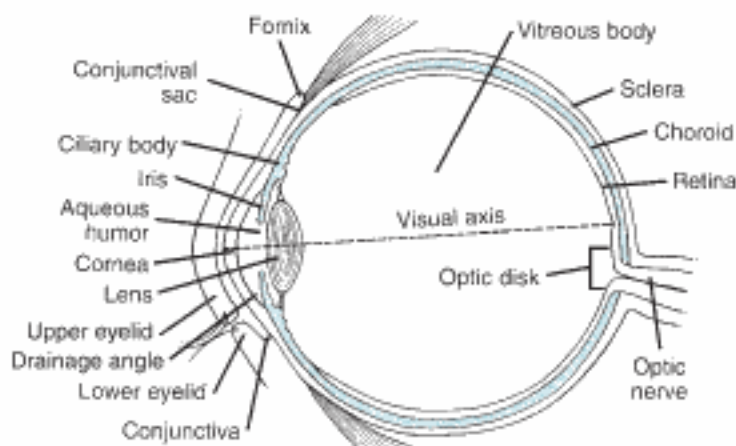

FIGURE 10-1
Internal structures of the eyeball.

have only two eyes, and the importance of vision should not be minimized.

Mydriatics and Cycloplegics

Mydriatic agents are used to dilate the pupils (Figure 10-2). This action facilitates examination of the posterior segment and the fundus of the eye. Cycloplegic agents paralyze the accommodative muscle of the ciliary body. In some cases, this action can minimize pain associated with ciliary spasms. These agents often are used before and after ophthalmic surgery.

Phenylephrine Hydrochloride

Phenylephrine hydrochloride is used to produce **mydriasis** but does not produce **cycloplegia**.

Clinical Uses

Phenylephrine HCl is used in the evaluation of uveitis, glaucoma, or scleritis. It also may be used before conjunctival surgery to reduce hemorrhage or may be used in combination with atropine before cataract or intraocular surgery. It can be used to detect the presence of Horner's syndrome.

Dosage Forms

1. Mydrin (human label)
2. Neo-Synephrine

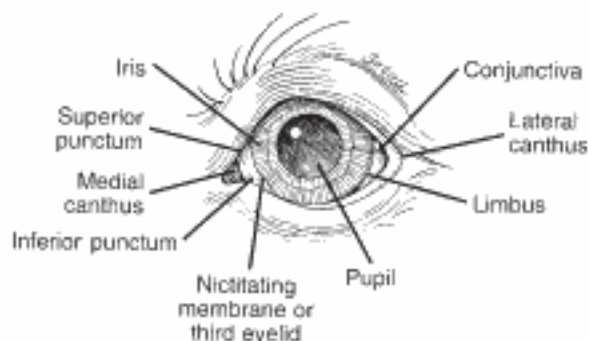

FIGURE 10-2
External structures of the eye.

Adverse Side Effects

These include local discomfort after application. Frequent use may lead to inflammation.

Technician's Notes

Phenylephrine HCl is also used in cough preparations but at a higher concentration.

Atropine Sulfate

Atropine sulfate is one of the ophthalmic agents that is most commonly used to produce mydriasis and cycloplegia.

Clinical Uses

Atropine sulfate is used for refraction or for the treatment of acute inflammatory conditions of the anterior uveal tract.

Dosage Forms

1. Atrophate
2. Atropine sulfate

Adverse Side Effects

These include salivation. Atropine is contraindicated in **glaucoma** and keratoconjunctivitis sicca (KCS or dry eye).

Homatropine Hydrobromide

Homatropine hydrobromide produces mydriasis and cycloplegia but is less potent than atropine.

Clinical Uses

Homatropine hydrobromide is used for refraction and for the treatment of **uveitis**.

Dosage Forms

1. Homatrocil Ophthalmic (human label)
2. Isopto Homatropine (human label)

Adverse Side Effects

These are the same as for atropine.

Cyclopentolate Hydrochloride

Cyclopentolate hydrochloride produces mydriasis and cycloplegia.

Clinical Uses

Cyclopentolate hydrochloride is used for refraction.

Dosage Forms

1. Cyclogyl (human label)
2. Pentolair

Adverse Side Effects

These are the same as for atropine.

Tropicamide

Tropicamide is a rapid-acting mydriatic that has less cycloplegic effect than the previously mentioned drugs.

Clinical Uses

Tropicamide is used for ocular fundus examination.

Dosage Forms

1. Mydriacyl (human label)
2. Opticyl
3. Tropicacyl

Adverse Side Effects

These include local discomfort after application and salivation. Contraindications are the same as for atropine.

Epinephrine

Epinephrine is administered topically and is available as epinephrine and dipivalyl epinephrine. Dipivalyl epinephrine readily penetrates the corneal barrier and is converted to epinephrine in the cornea.

Clinical Uses

Epinephrine is used to reduce intraocular pressure, produce mydriasis, or aid in the diagnosis of Horner's syndrome.

Dosage Forms

1. Epifrin (human label)
2. Epinal
3. Glaucon

Adverse Side Effects

These include local irritation. Epinephrine is contraindicated in **closed-angle glaucoma**.

**Miotics**

Miotics produce pupillary constriction. These drugs are commonly used in the treatment of chronic **open-angle glaucoma**, acute and chronic closed-angle glaucoma, and some cases of secondary glaucoma. Miotics reduce intraocular pressure by increasing the outflow of aqueous humor.

Pilocarpine

Pilocarpine is a cholinergic drug that is commonly used to treat chronic open-angle glaucoma.

Clinical Uses

These include stimulation of tear production in some cases of keratoconjunctivitis sicca, as well as the treatment of glaucoma.

Dosage Forms

1. Piloptic
2. Isopto Carpine
3. PiloStat

Adverse Side Effects

These include local irritation and discomfort. Repeated use may cause vomiting, diarrhea, and salivation.

Demecarium Bromide

Demecarium bromide is a potent carbamate inhibitor that can reduce intraocular pressure in dogs for up to 48 hours.

Clinical Uses

Preventive management of the contralateral eye after diagnosis of acute glaucoma in the other eye.

Dosage Form

Humorsol

Adverse Side Effects

Local irritation of the eye and/or salivation, vomiting, and diarrhea.

Other Agents That Reduce Intraocular Pressure
Carbonic Anhydrase Inhibitors

Carbonic anhydrase inhibitors reduce intraocular pressure by decreasing the production of aqueous humor. These products, similarly to those previously mentioned, are used to control glaucoma. However, some are administered orally or intravenously rather than topically.

Dosage Forms

1. Dichlorophenamide (Daranide—human label)
2. Acetazolamide (Diamox—human label)—available in injectable and oral forms

3. Methazolamide (Neptazane—human label)
4. Dorzolamide (Trusopt—human label)
5. Brinzolamide (Azopt)—topical agent
6. Dorzolamide (Trusopt)—topical agent

Adverse Side Effects

These include vomiting, diarrhea, panting, and weakness.

Beta-Adrenergic Antagonists

The beta-adrenergic blocking agents used to treat glaucoma include timolol, betaxolol, carteolol, levobunolol, and metipranolol.

TIMOLOL MALEATE

Timolol maleate is an ophthalmic beta blocker with action that results in decreased production of aqueous humor.

Clinical Uses

Timolol maleate is used in the contralateral eye of a dog with primary glaucoma to prevent the development of bilateral disease. It reduces intraocular pressure to some extent, but it is not as effective in the treatment of glaucoma.

Dosage Forms

1. Timoptic (human label)
2. Cosopt

Adverse Side Effects

Adverse side effects are uncommon. See the Technician's Notes below.

Technician's Notes

Timolol may be contraindicated in some patients with cardiovascular disease or bronchoconstrictive disease.

BETAXOLOL

Betaxolol is a specific beta-1 adrenergic blocking agent that reduces aqueous humor production by decreasing cyclic adenosine monophosphate (cAMP) production in the ciliary body.

Clinical Uses

It is used for the treatment of glaucoma, especially in animals with respiratory disease or asthma.

Dosage Form

Betopic

Adverse Side Effects

Similar to those of timolol.

CARTEOLOL

Cartelol is a nonspecific adrenergic blocking agent that reduces aqueous humor production similarly to betaxolol.

Clinical Uses

This drug is primarily used for the control of primary glaucoma in cats.

Dosage Form

Ocupress

Adverse Side Effects

Similar to those of timolol.

LEVOBUNOLOL

Levobunolol is a beta-1 and beta-2 blocker similar to timolol but without the potential for myocardial depression or airway constriction.

Clinical Uses

This drug may be used to treat glaucoma in feline patients with asthma.

Dosage Form

Betagan

METIPRANOLOL

Metipranolol is a nonselective beta blocking agent.

Clinical Uses

This drug has been used for the management of primary open-angle glaucoma in cats.

Dosage Form

OptiPranolol

Sympathomimetics

The sympathomimetics used to control glaucoma include apraclonidine and brimonidine.

APRACLONIDINE

Apraclonidine is a alpha-2 adrenergic agonist that is used to reduce aqueous humor production.

Clinical Uses

This drug is used for the treatment of glaucoma.

Dosage Form

Lopidine

Adverse Side Effects

May cause vomiting and diarrhea in dogs and cats.

BRIMONIDINE

Brimonidine is an alpha-adrenergic agonist that reduces aqueous humor production and increases aqueous humor outflow.

Clinical Uses

It is used for the treatment of glaucoma.

Dosage Form

Alphagan

Topical Prostaglandins

Prostaglandin analogs decrease intraocular pressure by increasing the outflow of aqueous humor through the uveal and scleral pathways.

Dosage Forms

1. Latanoprost-Xalatan
2. Bimatoprost-Lumigan
3. Travoprost-Travatan

Osmotic Diuretics**MANNITOL**

Mannitol is an osmotic diuretic that is administered intravenously in emergency situations to reduce intraocular pressure.

Dosage Form

Mannitol injection

Adverse Side Effects

These include fluid and electrolyte imbalance, nausea, vomiting, pulmonary edema, congestive heart failure, and tachycardia.

GLYCEROL

Glycerol (glycerin) is an osmotic diuretic that is administered orally to reduce intraocular pressure in emergency situations.

Dosage Form

Osmoglyn (human label)

Adverse Side Effects

Vomiting may occur after administration.

Technician's Notes

Glycerol acts more slowly than mannitol.

**Topical Anesthetics**

Topical anesthetics anesthetize the corneal surface and are commonly used to facilitate removal of a foreign body or sutures, to allow the use of instruments to measure intraocular pressure, or to aid in the application of a hydrophilic contact lens.

Proparacaine Hydrochloride

Proparacaine hydrochloride is a commonly used topical anesthetic. Anesthesia lasts 5 to 10 minutes.

Dosage Form

Ophthaine

Adverse Side Effects

These are very uncommon.

Technician's Notes

Unopened bottles may be stored at room temperature, but opened bottles should be refrigerated. Any discolored solutions should be discarded.

Ophthalmic solutions should be warmed (i.e., those stored in the refrigerator) to room temperature before administration into the patient's eye. This can be facilitated by rolling the bottle between the palms of the hands or by placing the bottle under the arm, until the desired temperature is achieved.

Tetracaine and Tetracaine Hydrochloride

Tetracaine and tetracaine hydrochloride are also used for anesthetizing the cornea.

Dosage Forms

1. Pontocaine (human label)
2. Pontocaine hydrochloride (human label)

Adverse Side Effects

These include irritation, which usually is resolved within a short period after administration.

Technician's Notes

Different from proparacaine, tetracaine inhibits the growth of microorganisms, and cultures should be obtained before its administration.

**Ophthalmic Stains**

Ophthalmic stains are used as diagnostic aids for detecting disease in the anterior and posterior segments and in the nasolacrimal system. Fluorescein stain (i.e., strips) is the most commonly used dye for the detection of corneal epithelial defects. Through wetting of the strip with sterile water or saline, the stain is allowed to cover the eye. The strip should not be allowed to touch the cornea. Excess dye is rinsed from the eye with sterile eye wash. Fluorescein stain is a water-soluble agent. The outer (epithelial) layer of the cornea is a fat-soluble layer, and the stroma just beneath the epithelium is a water-soluble layer. If the epithelium is intact, the stain does not adhere because of differences in solubility. If the epithelium is eroded, as in the case of a corneal ulcer, the stain gains access to the water-soluble stroma, where it adheres and remains after the eye is rinsed. Appearance of fluorescein stain at the nostril

opening indicates functional patency of the nasolacrimal drainage system.

Phenol red is another stain used in the eye. The Phenol Red Thread (PRT) test is used to measure tear production in the eye. The PRT test makes use of a 75-mm-long, yellow thread that is impregnated with phenol red. The thread is inserted into the conjunctival sac for 15 seconds. Tears traveling up the thread turn the thread red. The distance at which the color change occurs is measured and is compared with normal values, as in the Schirmer Tear test.

Rose bengal is another stain that is used in the eye. It is used to detect dead epithelial cells and mucus. It has been found by some clinicians to be useful for detecting dendritic lesions associated with viral keratitis in cats.

Technician's Notes

1. Do not allow the fluorescein strip to touch the cornea because this could potentially produce a paper cut on the cornea.
2. A good idea is to obtain a sterile 6-cc syringe and place the fluorescein strip into the syringe barrel. Fill the syringe with sterile water and replace the plunger. Invert the syringe several times until the water turns yellow. Simply administer this solution into the eye for the staining procedure.
3. Horses have strong palpebral muscles. If stain is to be used in this species, it may be necessary to have another person keep the eyelids spread apart while the stain is introduced into the eye.
4. Fluorescein stains the hair if allowed to drain onto the face. Use cotton to wipe away excess fluorescein stain because it is softer than a paper towel.

Collagen Shields

Collagen shields are biodegradable contact lens-shaped films made from porcine or bovine collagen. They dissolve in 12 to 72 hours because of the naturally occurring enzymes found in tears.

Clinical Uses

A collagen shield may be used in the treatment of superficial corneal ulcers.

Dosage Form

Vet-Shield 72

Technician's Notes

A topical ophthalmic anesthetic should be used before the shield is placed onto the eye. It may be necessary to sedate the animal with a short-acting general anesthetic.



Topical Ophthalmic Antiinfectives

Antiviral Agents

Antiviral agents may be used to treat viral infections of the eye, such as herpes simplex keratitis (e.g., feline ocular herpes).

Dosage Forms

1. Idoxuridine (Stoxil—human label)
2. Trifluridine (Viroptic ophthalmic solution—human label)
3. Acyclovir (Acyclovir ophthalmic ointment available in the United States as a compounded product)

Antifungal Agents

Antifungal agents are used to treat ophthalmic fungal infections such as mycotic keratitis, mycotic endophthalmitis, and blepharodermatomycesis. Mycotic keratitis occurs most commonly in horses.

Dosage Forms

1. Natamycin (Natascyn—human label)
2. Itraconazole—may be compounded with dimethyl sulfoxide (DMSO)
3. Povidone iodine—compounded to a 0.5% to 1.0% solution
4. Miconazole—1% solution compounded without alcohol

Antibacterial Agents

Antibacterial agents are used to treat superficial ocular infections resulting from bacterial organisms.

These drugs are often used in combination with each other to provide broad-spectrum activity.

1. Bacitracin is used topically to treat superficial ocular infections that result primarily from gram-positive bacteria; it is often combined with other antibacterial agents such as neomycin and polymyxin B.
2. Chloramphenicol is available for topical ophthalmic administration and provides broad-spectrum activity. This agent is antagonistic with aminoglycosides.
3. Gentamicin is used topically to treat conjunctivitis caused by susceptible bacterial agents.
4. Polymyxin B sulfate is effective against gram-negative organisms and may be combined with other antibacterial agents to provide broad-spectrum activity.
5. Oxytetracycline is used to treat superficial ocular infections and provides broad-spectrum activity. It may be used in combination with other agents such as polymyxin B.
6. Neomycin provides broad-spectrum activity and is often used in combination with other topical ophthalmic antibacterials.
7. Fluoroquinolone ophthalmic antibiotics are used to treat established gram-negative corneal infections.
8. Tobramycin is used for conditions for which gentamicin is used.
9. Sulfacetamide
10. Ciprofloxacin, norfloxacin, moxifloxacin, and ofloxacin are available as human products.

Topical Ophthalmic Antiinflammatory Agents

Nonsteroidal Agents

Nonsteroidal antiinflammatory drugs (NSAIDs) are used in the treatment of uveitis. They are commonly used for postsurgical inflammation following cataract surgery.

Dosage Forms

1. Flurbiprofen sodium (Ocufen—human label)
2. Ketorolac tromethamine (Acular—human label)

3. Diclofenac sodium (Voltaren—human label)
4. Suprofen (Profenal—human label)

Adverse Side Effects

These are uncommon, but flurbiprofen can cause immunosuppression.

Topical Corticosteroid Agents

Corticosteroid agents are used to treat inflammatory conditions of the cornea, iris, conjunctiva, sclera, and anterior uvea. Topical corticosteroids have poor penetration into the eyelid and the posterior segment of the eye (Plumb, 2005). They may be combined with antibacterial agents to manage ocular infections. They are prepared as ointments or solutions. Common corticosteroid agents for ophthalmic use include prednisolone, hydrocortisone, dexamethasone, betamethasone, fluorometholone, and flumethasone.

Dosage Forms (Partial List)

1. Prednisolone acetate drops—human label
2. Prednisolone sodium phosphate drops—human label
3. Gentocin Durafilm solution (combination)
4. Anaprime ophthalmic solution
5. Neo-Predef (combination)
6. Pred Forte prednisolone
7. Vetropolycin (combination)
8. Chlorasone (combination)
9. Maxitrol (combination)

Adverse Side Effects

Topical corticosteroids can cause problems similar to those caused by systemic corticosteroids. These include delayed healing, steroid dependency, and corneal complications such as ulcerative keratitis.

Technician's Notes

Ophthalmic products that contain corticosteroids are contraindicated in the treatment of deep corneal ulcers, fungal infections, and viral infections.

Agents for the Treatment of Keratoconjunctivitis Sicca

Keratoconjunctivitis sicca (KCS) is a common ocular disorder in dogs. With this disorder, secretion of the lacrimal glands is reduced, resulting in corneal dryness. If left untreated, corneal ulceration and eventual perforation may occur (Tizard, 2000).

Cyclosporine

Cyclosporine is used for the management of KCS and chronic superficial keratitis (CSK, or German Shepherd pannus). It stimulates increased tear production, although its mechanism of action is not fully understood.

Dosage Forms

1. Optimmune Ophthalmic Ointment
2. Cyclosporin A
3. Neoral
4. Sandimmune

Adverse Side Effects

Adverse side effects are uncommon.

Technician's Notes

It may take several days to a few weeks before the effects of cyclosporine therapy are evident.

Artificial Tear Products and Ocular Lubricants

Before the availability of cyclosporine, artificial tears were used in the treatment of KCS and CSK. These products serve as lubricants for dry eyes and are commonly used in conjunction with cyclosporine therapy. Ocular lubricants are petroleum-based products that are used to lubricate and protect the eyes. They are commonly used during anesthetic procedures in which the eyes may remain open and become dry. Many human label products are available.

Dosage Forms (Limited)

1. Bion Tears
2. Liquifilm Tears

3. Comfort Tear
4. Dry Eye Therapy
5. Lacti-Lube

Adverse Side Effects

These are uncommon.

Miscellaneous Ophthalmic Agents

Anticollagenase Agents

Anticollagenase agents are used to protect against the melting effects of collagenase and protease enzymes on the cornea.

Dosage Forms

1. Acetylcysteine ophthalmic
2. Edetate disodium ophthalmic

Viscoelastic Substances

Viscoelastic substances are used in ophthalmic surgery to minimize the loss of fluid from the anterior chamber and to maintain ocular space during surgery (Plumb, 2005). Hyaluronic acid and other viscoelastic substances are used as an aid in cataract extraction, ocular implantation surgery, retinal attachment surgery, and others. Ophthalmic texts should be consulted for detailed explanations of the use of these agents.

OTIC DRUGS

When a client obtains a new puppy, the veterinary technician should educate the client regarding the proper way to clean the pup's ears. Performance of the ear cleaning process at an early age will allow the puppy to submit more readily to the task as an adult dog. Unfortunately, those breeds with pendulous ears may tend to have otic problems. Long ear flaps (i.e., pinnae) tend to keep air from circulating into the ear canal; consequently, the ear canal remains moist, creating a perfect environment for yeast formation. Yeast is not the only problem that veterinarians encounter in dogs and cats. External parasites such as *Otodectes cynotis* and *Otodectes procyonis* (i.e., ear mites) can cause extreme

discomfort in animals that are parasitized by these creatures. Patients whose ears remain untreated often experience aural hematoma caused by extreme shaking of the head.

Generally, ear problems are treated with topical medications. Sometimes, ear infections must be treated with systemic medications as well. Topical preparations used to treat ear infections are often a combination of different types of drugs, such as antibacterial, antifungal, antipruritic, and antiinflammatory agents. Still other preparations are cleansers, drying agents, and parasiticides. When a ruptured eardrum is suspected or confirmed, oil-based or irritating external ear preparations (e.g., chlorhexidine) and aminoglycosides should be avoided.

When educating clients about cleaning ears and using otic medications, the veterinary technician should demonstrate how to clean the ear canal. Assure the client that because of the anatomy of the ear, the eardrum is difficult to reach. Emphasize that it is much easier to provide preventive care than to treat infections continually, especially in those dog breeds that are predisposed to ear problems (Figure 10-3).



Topical Otic Antiinfective Agents

Many topical otic preparations with antibacterial or antifungal properties are manufactured and available for placement in inventory. Topical otic preparations often contain antiinflammatory agents that reduce inflammation and decrease pruritus. A good idea involves clipping the hair on the inside of the pinna along with any hair that may block the external ear canal. It is also a good idea to use a cleanser before medicating the ear. By cleansing the ear first, the technician removes cerumen and debris from the external canal and allows medicine to work effectively. After the ear is cleaned, it should be dried before treatment is provided.

Gentamicin Sulfate

Gentamicin sulfate is an antibacterial agent found in otic preparations. It is commonly combined with a corticosteroid such as betamethasone valerate. Some products also have antifungal properties because of the addition of clotrimazole.

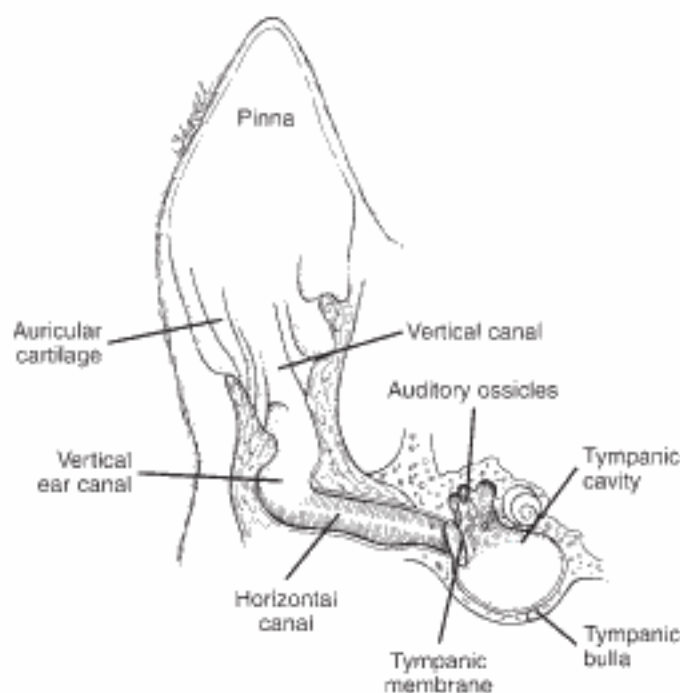

FIGURE 10-3
Structures of the ear.

Clinical Uses

These include the treatment of acute and chronic otitis in dogs. In cats, it may be used to treat superficial infected lesions caused by bacteria susceptible to gentamicin.

Dosage Forms

1. GentaVed Otic Solution
2. Gentocin Otic Solution
3. Otomax (twice-daily treatment)
4. Mometamax (once-a-day treatment)
5. Tri-Otic

Adverse Side Effects

These include possible ototoxicity because gentamicin is an aminoglycoside.

Technician's Notes

1. Patients should be carefully monitored for signs of ototoxicity. Products that lower the pH or produce an acidic environment in the ear can reduce the efficacy of gentamicin.
2. Do not use these products with other agents that may cause ototoxicity.
3. Do not use in the presence of a ruptured eardrum.

Chloramphenicol

Chloramphenicol is an antibacterial agent that is often combined with a corticosteroid such as prednisolone. Products may also contain an anesthetic (tetracaine) and squalane (Cerumene). Squalane enhances the product by speeding up percutaneous penetration of the active ingredients.

Clinical Uses

These include treatment for acute otitis externa and pyoderma in dogs and cats.

Dosage Forms

1. Liquichlor
2. Chlora-Otic

Technician's Notes

Products that contain chloramphenicol cannot be used in animals raised for food production.

Neomycin Sulfate

Neomycin sulfate is an antibacterial agent that is often combined with drugs such as corticosteroids, antifungals, and/or anesthetics.

Clinical Uses

Clinical uses of this antibacterial, antifungal/antiparasitic, and antiinflammatory combination include the treatment of otitis externa and certain bacterial, fungal, and inflammatory skin disorders.

Dosage Forms

1. Tresaderm
2. Tritop
3. Panalog

Adverse Side Effects

These include sensitivity resulting from the use of neomycin. If such signs (e.g., erythema) develop after treatment, the medication should be discontinued. Ototoxicity is also a potential side effect.

Technician's Notes

1. Do not use in the presence of a ruptured tympanic membrane (i.e., eardrum).
2. Observe the patient for signs of ototoxicity.

Enrofloxacin

Enrofloxacin is available in a combination otic product with silver sulfadiazine (Baytril Otic) and in a combination product with ketoconazole and triamcinolone (BNT).

Dosage Forms

1. Baytril Otic
2. BNT

**Antiparasitics**

Ear mites are ubiquitous in the environment. They are the most common parasite affecting the ears of dogs, cats, and rabbits. These mites are macroscopic, white, and freely motile. Although they occur primarily in the external ear canal, ear mites may be found on any area of the body

(Hendrix, 1998). Ear mites can be identified with an otoscope and appear as white, motile creatures within the external ear canal. Ear mites also can be observed microscopically by placing exudate, which can be removed from the ear canal with a cotton-tipped applicator stick, into mineral oil on a microscope slide.

The spinose ear tick (*Otobius megnini*) affects the external ear canal of cattle and horses, and occasionally of dogs and cats. These immature ticks pack the ear canal, which causes discomfort, and should be removed. Periodic treatment of the animal with an insecticide, such as a flea and tick spray, prevents reinfection. Cattle and horses can be treated with topical sprays such as Catron IV. This product should not be used in lactating dairy animals or in household pets.

Technician's Notes

Ticks should not be removed with bare hands. Technicians should educate clients not to remove ticks without wearing gloves. Donning a pair of exam gloves (or Playtex gloves for clients at home) and then extracting ticks is better. A pair of thumb forceps can also be employed.

Pyrethrins

Some products containing pyrethrins are indicated for the treatment of ticks and mites in the ears of dogs and cats.

Dosage Forms

1. Cerumite
2. Aurimite
3. Mita-Clear
4. Tresaderm
5. Nolvamite

Rotenone

Rotenone is an effective agent for the treatment of ear mites in dogs, cats, and rabbits.

Dosage Forms

1. Ear miticide
2. Mitaplex-R

Ivermectin/Milbemycin

Ivermectin has been indicated as an effective treatment for ear mites in dogs and cats. This is an extralabel use of the bovine injectable product Ivomec. The dose is most often given by subcutaneous injection, although some practitioners place it directly into the external ear canal. In recent years, a product that contains .01% Ivomec (Acarexx) has been developed for the treatment of ear mites. Milbemycin is available in a 0.1 % solution for the treatment of ear mites in cats.

Dosage Forms

1. ACarexx (0.01% Ivermectin)
2. MilbeMite (0.1% Milbemycin)



Drying Agents

Drying agents are used to reduce moisture in the ears. Excess moisture provides a warm, moist environment that is ideal for the growth of certain bacterial and yeast agents, which can cause infection or inflammation. These preparations may also contain an antimicrobial or a corticosteroid. Tannic acid, salicylic acid, acetic acid, and boric acid are commonly used in drying solutions.

Dosage Forms

1. Dermal Dry
2. Ace-Otic Cleanser
3. CleaRx

Technician's Notes

1. It is recommended that the ears be cleaned before a drying agent or other medication is applied.
2. Some ear-cleansing products also contain drying agents.



Cleaning Agents

Ear cleansers are used to clean the ears and provide odor control. In the presence of otitis externa, they help to remove necrotic tissue, debris, and wax. Many breeds, as mentioned before, are predisposed to ear

problems, and routine cleaning can often reduce or prevent these problems. These cleansers may also contain an antimicrobial agent, an anesthetic, or a drying agent. Many cleansers contain an agent such as squalane (Cerumene), which helps to break up and soften wax and debris and facilitates cleaning. If wax and debris are impacted in the horizontal canal, it may be necessary to flush the ear canal to remove the wax and debris before starting routine cleaning. The ears may be too painful for the patient to undergo this type of cleaning without general anesthesia. A common solution for flushing the ear canal is a mixture of warm water and chlorhexidine surgical solution diluted 1:100. Flushing may be accomplished with the use of a bulb syringe, a soft rubber feeding tube, or a regular-tipped syringe. It is very important to use gentle pressure when flushing the ear canal to reduce the possibility of damaging the eardrum. Thorough drying of the canal after flushing provides better visualization of the eardrum.

Dosage Forms (Partial Listing)

1. Epi-Otic ear cleanser
2. Fresh-Ear
3. Oti-Clens
4. AloCeric
5. Cerumene
6. Oti-Calm
7. Cerulytic
8. Oti-Clear
9. Xenodyne



Miscellaneous Otic Agents

Tris-EDTA

Tris-EDTA (ethylenediaminetetraacetic acid) is a topically applied buffer that contains a chelating agent (EDTA); this agent removes calcium and

magnesium ions from the lipopolysaccharide covering of gram-negative organisms and the cell walls of gram-negative and gram-positive organisms (Boothe, 2001), and this action facilitates the penetration of antiinfectives. Treatment with tris-EDTA should be carried out before treatment with antibacterials is provided.

Silver Sulfadiazine

Silver sulfadiazine is a broad-spectrum agent that is effective against gram-positive and gram-negative bacteria and fungi. It has been used extensively in treating people with skin burns. It is available in one veterinary labeled product (Baytril Otic) and is used off-label in formulated products by some clinicians.

Dosage Forms

1. Baytril Otic
2. Silvadene

REFERENCES

- Boothe DM: Treatment of bacterial infections. In Boothe DM, editor: Small animal clinical pharmacology and therapeutics, Philadelphia, 2001, WB Saunders.
- Hendrix CM, et al, editors: Diagnostic veterinary parasitology, ed 2, St. Louis, 1998, Mosby.
- McCurnin DM, Bassett JM, editors: Clinical textbook for veterinary technicians, ed 6, Philadelphia, 2006, WB Saunders.
- Plumb DC: Veterinary drug handbook, ed 5, Ames, 2005, Iowa State University Press.
- Tizard I: Veterinary immunology: an introduction, ed 6, Philadelphia, 2000, WB Saunders.



REVIEW QUESTIONS

1. Mydriatic agents are used to ____ the pupils.
2. Atropine is contraindicated in ____ and ____.
3. Miotic agents produce ____ constriction.
4. Why are ophthalmic stains used?
5. ____ stain is the most commonly used dye for the detection of corneal epithelial defects.
6. Patients with ear mites, whose ears are left untreated, often experience ____ hematomas caused by excessive shaking of the head.
7. What type of administration is the most common method of treating disorders of the eye?

8. Why do most topical ophthalmic medications require several applications per day?

9. What is Ophthaine used for?

10. The appearance of fluorescein stain at the nostril opening is an abnormal finding when a fluorescein stain test is performed.
 - a. True
 - b. False
11. The nictitating membrane is also known as _____.
 - a. sclera
 - b. cornea
 - c. third eyelid
 - d. ciliary body
12. Mydriatic agents are used to ____ the pupils.
 - a. dilate
 - b. constrict
 - c. hydrate
 - d. reach
13. Atropine ophthalmic agents are used to produce _____.
 - a. miosis
 - b. mydriasis
14. Epinephrine is contraindicated in ____-angle glaucoma.
 - a. closed
 - b. open
15. Mannitol is a loop diuretic.
 - a. True
 - b. False
16. The local anesthesia provided by proparacaine HCl usually lasts ____ to ____ minutes.
 - a. 5; 10
 - b. 30; 60
 - c. 60; 90
 - d. 90; 120
17. Fluorescein stain is used commonly to diagnose _____.
 - a. glaucoma
 - b. corneal ulcers
 - c. entropion
 - d. ectropion
18. _____ have very strong palpebral muscles, and it may be necessary to have another person assist when one is applying ophthalmic drugs.
 - a. Canines
 - b. Felines
 - c. Equines
 - d. Caprines
19. It is acceptable to use corticosteroid-type ointments in patients with corneal ulcers.
 - a. True
 - b. False
20. ____ has been developed for the treatment of *Otodectes* spp.
 - a. Chloramphenicol
 - b. Enrofloxacin
 - c. Optimmune
 - d. Acarexx

Benzoyl Peroxide

Selenium Sulfide

TOPICAL MEDICATIONS MIXED WITH WATER

Aluminum Acetate

Magnesium Sulfate

Bath Oils

TOPICAL ANTIPRURITICS

Nonsteroidal Antipruritics

Topical Corticosteroids

ASTRINGENTS

ANTISEPTICS FOR THE SKIN

Alcohols

Propylene Glycol

Chlorhexidine

Acetic Acid

Iodine

Benzalkonium Chloride

Wound Healing

TOPICAL WOUND DRESSINGS

Healing Stimulators

Wound Cleansers

Protectants

OTHER DRUGS USED IN DERMATOLOGIC THERAPY

Systemic Corticosteroids

Topical Antibacterial Agents

Topical Antifungal Agents

Fatty Acid Supplements

COUNTERIRRITANTS

Vesication

CAUSTICS

MISCELLANEOUS DRUGS

SELECTIVE IMMUNOSUPPRESSORS

CHAPTER 11

Drugs Used in Skin Disorders

LEARNING OBJECTIVES

After studying this chapter, you should be able to:

1. Exhibit a basic understanding of the anatomy and physiology of the skin.
2. List the common ingredients of topical antiseborrheics.
3. Describe the use of topical antipruritics.
4. Explain the use of fatty acid supplements.
5. Explain the use of astringents.
6. Explain the use of skin antiseptics.
7. Exhibit a basic understanding of wound healing.
8. Describe the use of topical wound dressings.
9. Discuss the use of irritants.



KEY TERMS

ANGIOGENESIS The development of blood vessels.

ASTRINGENT An agent that causes contraction after application to tissue.

CALLUS Hypertrophy of the horny layer of the epidermis in a localized area as a result of pressure or friction.

COLLAGEN A fibrous substance found in skin, tendon, bone, cartilage, and all other connective tissues.

COMEDO (PL. COMEDONES) A plug of keratin and sebum within a hair follicle of the skin.

DERMATITIS Inflammation of the skin.

ERYTHEMA Redness of the skin caused by congestion of the capillaries.

EXUDATION Leakage of fluid, cells, or cellular debris from blood vessels and their deposition in or on the tissue.

GRANULATION TISSUE New tissue formed in the healing of wounds of the soft tissue, consisting of connective tissue cells and ingrown young vessels; it ultimately forms a scar.

INTEGUMENTARY SYSTEM Pertaining to, or composed of, skin.

KERATOLYTIC An agent that promotes loosening or separation of the horny layer of the epidermis.

KERATOPLASTIC An agent that promotes normalization of the development of keratin.

PRURITUS Itching.

PYODERMA Any skin disease characterized by the presence or formation of pus.

SEBORRHEA An increase in scaling of the skin; sebum production may or may not be increased.

SEBORRHEA OLEOSA Condition characterized by scaling and excess lipid production that forms brownish yellow clumps, which adhere to the hair and skin.

SEBORRHEA SICCA Characterized by dry skin and white to gray scales that do not adhere to the hair or skin.

SEBORRHEIC DERMATITIS An inflammatory type of seborrhea characterized by scaling and greasiness.

INTRODUCTION

Dermatologic conditions are frequently seen in veterinary practice. From ectoparasitic problems to allergies, veterinarians are continually combating companion animal skin problems. As a veterinary technician, this is one area in which your expertise will be used because clients will ask many questions about shampoos, dips, conditioners, soaks, lotions, creams, ointments, sprays, and powders. Each of these products may be used to treat a full spectrum of dermatologic problems from parasites to **pyoderma**. Patients are often presented for examination of a skin disease when in reality they have an underlying systemic illness. Veterinarians use various diagnostic procedures (e.g., skin scrapings, allergy testing, dermatophyte tests) to determine the cause of skin disease. Technicians play a vital role by obtaining a complete history, knowing how to perform the diagnostic procedures used in a dermatologic workup, and providing client education.

Client education is essential when skin disease is treated because clients must understand the purpose of medications and how they are properly used.

ANATOMY AND PHYSIOLOGY

The skin is a part of the **integumentary system** and constitutes the largest organ in the body. It is made up of three layers (Figure 11-1) and serves multiple functions. It provides a barrier against the outside world by preventing entry of pathogenic microorganisms and by protecting against physical and chemical insults. It senses heat, cold, pain, touch, pressure, and other sensations like **pruritus** and helps to regulate body temperature through mechanisms related to cutaneous blood flow, sweating, and the haircoat. The skin plays a role in immunologic defense through the actions of Langerhans (dendritic or antigen-presenting) cells and keratinocytes, produces vitamin D₃ from

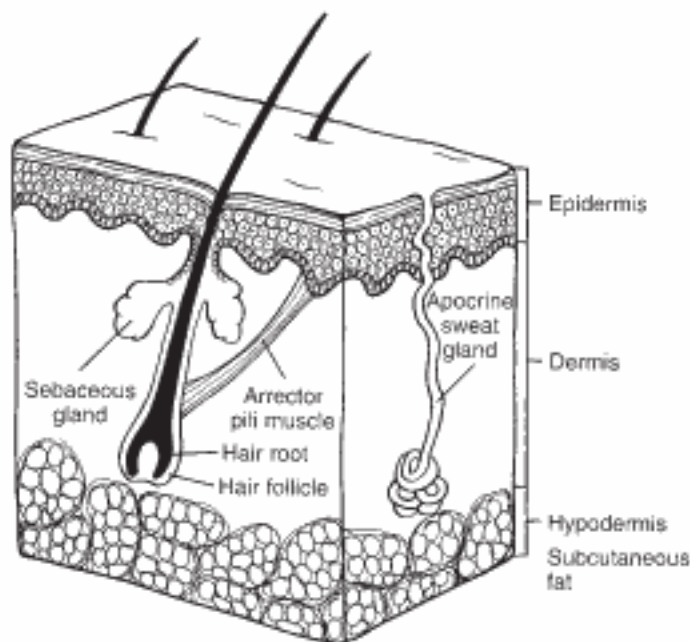

FIGURE 11-1

Schematic representation of the skin layers of normal canine skin.

precursors in the skin, and acts as a reservoir for electrolytes and other substances. This organ may also play a limited role in the excretion of some substances from the body.

The three primary layers of the skin are the epidermis, the dermis or corium, and the hypodermis or subcutis (also called the *panniculus*). The dermis provides most of the thickness of the skin. The epidermis is made up of keratinocytes, melanocytes, Langerhans cells, and Merkel cells (Yaphe, 2004). The epidermis is comprised of five distinct layers. These layers are the basal (deepest), spinous, granular, clear, and horny/cornified (superficial) layers. Epidermal cells are replenished in the basal layer and are pushed outward by newly forming layers. As these cells reach the surface, they are flattened and hardened to form a protective barrier. It normally takes 21 to 22 days for cells to reach the outer layer; this process is called the *epidermal turnover rate*. The epidermal turnover rate may be speeded up in some disease processes. Continual shedding of these cells is called *desquamation*. When the process becomes excessive, scale or dandruff is seen. The epidermis

includes a population of normal microorganisms that help to prevent overgrowth of pathogenic microorganisms.

The dermis or corium is located directly beneath the epidermis and is separated from and attached to it by the basement membrane. The dermis is a thick layer that comprises collagen fibers, blood vessels, nerves, lymphatics, and other structures such as hair follicles, sebaceous glands, and sweat glands. Sebaceous glands are found throughout haired skin, and their ducts empty into hair shafts. One type of sweat gland (eccrine) is found only in footpads and may play a role in body temperature regulation. The dermis gives stability and flexibility to the skin and acts to maintain and repair the skin.

The hypodermis is the deepest layer of the skin. It is made up of fat and connective tissue. Its functions are to provide padding and insulation and to serve as an energy store.

The skin produces hair and other keratinized structures like nail, horn, nasal pads, and footpads. Hair grows from follicles found in the dermis. In contrast to humans, who have one hair per follicle,

dogs and cats have multiple hairs per follicle. Individual hair follicles have associated glandular structures (see earlier) and arrector pili muscles that are responsible for piloerection (hair standing on end). The hair follicle is frequently involved in bacterial, fungal, and demodectic infections. If a hair follicle loses the hair and becomes plugged with sebaceous secretions and keratin, a **comedo** (blackhead) results. There are three stages or phases of hair growth called *anagen* (growth), *telogen* (rest), and *catagen* (intermediate). Hair grows until it reaches a predetermined length, enters a resting phase, and then is shed. The hair cycle is controlled by day-night length (photoperiod), environmental temperature, hormones, and nutritional status. General illness, skin disorders, poor nutrition, overbathing, and stress are conditions that may result in excessive shedding.

Topical Antiseborrheics

Keratolytics and **keratoplastics** are known as antiseborrheic drugs. These drugs are most often found in medicated shampoos and are available in combinations. Table 11-1 compares products and their uses.

Sulfur

Sulfur is commonly found in shampoos and is also available in ointments. It is nonirritating, nonstaining, and safe for cats. Primarily, it is keratolytic and keratoplastic. It is also antipruritic, antibacterial, antifungal, and antiparasitic. It is a mild follicular flusher but is not degreasing.

Client education consists of making sure the client understands the importance of lathering the shampoo well and letting it (the lather) stay on the pet's body for at least 5 to 10 minutes before rinsing. In this manner, the medication in these shampoos has a greater therapeutic effect. Technicians can bring this to the client's attention most notably by advising the use of a timer set for a 5- to 10-minute time span.

Clinical Uses

Sulfur is used to treat **seborrhea sicca**.

Dosage Forms

1. SebaLyt Shampoo
2. NuSal-T Shampoo
3. Sebolux Shampoo
4. Allerseb-T Shampoo

Adverse Side Effects

These include local irritation, which results from excessive and prolonged treatment. Sulfur is not recommended for routine bathing.

Technician's Notes

1. Products that contain sulfur are not recommended for routine bathing.
2. Manufacturers of most products recommend allowing the shampoo to remain on the coat for 5 to 10 minutes before rinsing. Before using this or any other therapeutic shampoo on very dirty pets, it is best to bathe them first in a good cleansing type of shampoo and rinse well. Then, the therapeutic shampoo (sulfur or other) is applied. In this manner, the sulfur does not need to compete with dirt, grease, or parasites to penetrate to the skin to do its job.

Salicylic Acid

Salicylic acid is a common ingredient that is found in many antiseborrheic products. It is nonirritating, nonstaining, and safe for cats. It is primarily keratoplastic, but it also has keratolytic, antipruritic, and antibacterial properties.

Clinical Uses

These include its combination with sulfur to treat **seborrhea sicca**. It also may be used to treat hyperkeratotic skin disorders, such as **calluses**, thickened footpads, and **planum nasale**. It is an ingredient in many otic preparations.

Dosage Forms

1. SebaLyt Shampoo
2. Micro Pearls Advantage Seba-Moist Shampoo
3. KeraSolv Gel

Adverse Side Effects

Adverse side effects are uncommon.

Table 11-1 Common Skin Disorders With Suggested Treatments and Various Products Available

Disease	Sulfur	Salicylic Acid	Coal Tar	Benzoyl Peroxide	Chlorhexidine	Hydrocortisone	Therapeutic Products
Seborrhea sicca	✓	✓					SebaLyt Shampoo Sebolux Shampoo Allerseb-T Shampoo
Seborrhea oleosa	✓	✓	✓	✓			LyTar Shampoo Pyoben Shampoo Sulf/OxyDex Shampoo
Hot spots				✓	✓	✓	ChlorHex Shampoo Pyoben Gel Gentocin Topical Spray
Skinfold dermatitis				✓			OxyDex Gel Pyoben Gel
Deep pyoderma				✓			Pyoben Shampoo Sulf/OxyDex Shampoo Systemic antibiotics
Superficial pustular dermatitis				✓			Pyoben Shampoo OxyDex Shampoo Sulf/OxyDex Shampoo
Superficial folliculitis				✓	✓		ChlorHex Shampoo Pyoben Shampoo Sulf/OxyDex Shampoo
Atopy/allergic contact dermatitis	✓	✓	✓			✓	Micro Pearls Advantage Seba-Moist Moisturizing Shampoo DermaCool-HC Spray
Schnauzer comedo syndrome				✓			Micro Pearls Advantage Benzoyl Plus Shampoo OxyDex Shampoo

Technician's Notes

Products that contain salicylic acid as an active ingredient are not recommended for routine bathing.

Coal Tar

Coal tar is potentially irritating and may stain some light-colored haircoats. It is primarily keratolytic and keratoplastic and is mildly degreasing. The refining process used to produce coal tar solutions helps to decrease the staining effect, strong odor, and potential carcinogenic effect.

Clinical Uses

Coal tar is used to treat seborrhea sicca.

Dosage Forms

1. LyTar Shampoo
2. LyTar Therapeutic Spray
3. Mycodex Tar and Sulfur Shampoo

Adverse Side Effects

These include toxicity in cats.

Technician's Notes

1. Products that contain coal tar should not be used on cats.
2. Manufacturers of most products recommend allowing the shampoo to remain on the haircoat for 5 to 10 minutes before rinsing.

Benzoyl Peroxide

Benzoyl peroxide is primarily keratolytic, antipruritic, follicular flushing, and degreasing. It is also antibacterial.

Clinical Uses

Benzoyl peroxide is used to treat seborrhea oleosa, hot spots, skinfold dermatitis, deep pyoderma, superficial pustular dermatitis, superficial folliculitis, schnauzer comedo syndrome, tail gland hyperplasia, and stud tail.

Dosage Forms

1. OxyDex Gel and Shampoo
2. Micro Pearls Benzoyl Plus Shampoo

3. Pyoben Gel and Shampoo
4. Sulf/OxyDex Shampoo

Adverse Side Effects

These include hypersensitivity in some humans.

Technician's Notes

1. Manufacturers of most products recommend allowing the shampoo to remain on the haircoat for 5 to 10 minutes before rinsing.
2. Benzoyl peroxide is safe for cats.
3. Benzoyl peroxide may bleach colored fabrics.

Selenium Sulfide

Selenium sulfide is primarily keratolytic, keratoplastic, and degreasing. It is also antifungal.

Clinical Uses

Selenium sulfide is used to treat dry eczema and seborrhea.

Dosage Forms

1. Selen Plus Medicated Shampoo
2. Selsun Blue Shampoo (human label)
3. Selsun Shampoo (human label)

Adverse Side Effects

These include possible rash or irritation after use.

Technician's Notes

1. Selenium sulfide can be irritating and may stain.
2. Do not use selenium sulfide on cats.
3. Manufacturers of most products recommend allowing the shampoo to remain on the haircoat for 5 to 10 minutes before rinsing.
4. Human label products tend to be less irritating and tend to stain less.

Topical Medications Mixed With Water

These products may be used in baths or applied with compresses. They possess a number of uses in veterinary medicines.

Aluminum Acetate

Aluminum acetate (Burow's solution [USP]) is drying, **astringent**, and mildly antiseptic.

Clinical Uses

Aluminum acetate is used in cool water soaks to prevent **exudation** that may result from inflammation and to relieve itching.

Dosage Forms

1. Domeboro powder
2. Domeboro tablets

Adverse Side Effects

Adverse side effects are uncommon.

Technician's Notes

One pack of powder or one tablet is mixed with $\frac{1}{2}$ to 1 L of water.

Magnesium Sulfate

Magnesium sulfate is mixed with water to produce a mildly hypertonic solution for wet dressings.

Clinical Uses

Wet dressings that contain magnesium sulfate are used to dehydrate or "draw" water from tissues.

Dosage Form

Epsom Salts

Adverse Side Effects

Adverse side effects are uncommon.

Technician's Notes

To produce a 1:65 solution, mix 1 tbsp of magnesium sulfate with 1 L of water.

Bath Oils

Bath oils may be used to manage seborrhea sicca by normalizing keratinization. These may be applied as sprays or diluted and used as a bath rinse. They

contain ingredients such as sodium lactate, lanolin, and mineral oil.

Clinical Uses

Bath oils are used in the treatment of dry skin and haircoat.

Dosage Forms

1. HyLyt efa Bath Oil/Coat Conditioner
2. Alpha Keri Therapeutic Bath Oil (human label)
3. Humilac

Adverse Side Effects

Adverse side effects are uncommon.

Technician's Notes

1. Excessive use makes the haircoat greasy and causes it to collect dirt.
2. Humilac is an oil-free humectant that does not cause the haircoat to become greasy.



Topical Antipruritics

Nonsteroidal Antipruritics

Topical antipruritics provide only temporary relief of itching. They are often used in conjunction with systemic or topical corticosteroids or systemic antihistamines. Colloidal oatmeal provides a soothing effect and may be beneficial for a few hours to days. Pramoxine HCl is also used topically as a palliative treatment for itching. These products provide safe and often effective alternatives to corticosteroids.

Clinical Uses

Topical antipruritics are used to provide relief of itching discomfort.

Dosage Forms

1. Epi-Soothe Shampoo
2. Epi-Soothe Bath Treatment
3. Relief Shampoo
4. Relief Spray
5. Relief Lotion
6. ResiSOOTHE
7. Histacalm

8. ResiHIST
9. ResiPROX

Adverse Side Effects

Adverse side effects are uncommon.

Topical Corticosteroids

Topical corticosteroids provide relief from itching, burning, and inflammation. They are often combined with other ingredients, such as antimicrobial agents and astringents. Hydrocortisone, triamcinolone, fluocinolone, and betamethasone are corticosteroids that are commonly used in topical preparations. These steroids differ in their potency and duration of action.

Clinical Uses

They are used in the treatment of inflammation and pruritus associated with conditions such as moist dermatosis (hot spots) and allergic dermatitis.

Dosage Forms

1. Gentocin Topical Spray
2. DermaCool-HC
3. Vetalog Cream
4. Betamethasone dipropionate (Diprosone, Diprolene)
5. Fluocinolone acetonide cream
6. Genesis

Adverse Side Effects

Adverse side effects are uncommon.



Astringents

Astringents have very little penetration and act to precipitate proteins. They may be used alone or combined with other ingredients. Tannic acid, iodine, alcohol, and phenol are common astringents used in veterinary medicine.

Clinical Uses

These include the treatment of moist dermatitis in dogs and cats and weeping skin wounds in large animals. They also are used to toughen the footpads of dogs.

Dosage Forms

1. Tanisol
2. Tanni-Gel
3. Stanisol

Adverse Side Effects

Astringents may cause irritation.



Antiseptics for the Skin

Antiseptics inhibit the growth of bacteria and are found in many dermatologic preparations. They are used in the cleansing and treatment of wounds and may be found in products such as surgical scrubs and shampoos.

Alcohols

Alcohols are bactericidal, astringent, cooling, and rubefacient.

Dosage Forms

1. 70% ethyl alcohol
2. 70% to 90% isopropyl alcohol

Adverse Side Effects

Alcohols may cause irritation of denuded skin surfaces.

Propylene Glycol

Propylene glycol is antibacterial and antifungal. Concentrations greater than 50% are keratolytic. Propylene glycol is primarily used as a solvent and a vehicle for other drugs.

Dosage Forms

1. Propylene glycol
2. Topical preparations

Adverse Side Effects

Erythema can result when propylene glycol concentrations greater than 50% are used.

Chlorhexidine

Chlorhexidine is bactericidal, fungicidal, and effective against many viruses. It is nonirritating, is not affected by organic debris, and is safe for cats.

Concentrations of 0.5% to 2% may be found in forms such as shampoos, ointments, surgical scrubs, and solutions.

Dosage Forms

1. ChlorhexiDerm Maximum Shampoo
2. Nolvasan Antiseptic Ointment
3. ResiCHLOR
4. KetoChlor

Adverse Side Effects

Adverse side effects are uncommon.

Acetic Acid

Acetic acid may be found in many otic preparations. It is effective against superficial *Pseudomonas* spp infections of the skin and ears.

Dosage Forms

1. Fresh-Ear
2. Clear_x Ear Cleansing Solution and Drying Solution

Adverse Side Effects

Adverse side effects are uncommon.

Iodine

Iodine is bactericidal, fungicidal, virucidal, and sporicidal. It may be found in shampoos, surgical scrubs, surgical preparations, ointments, and sprays.

Dosage Forms

1. Iodine Tincture
2. Lugol's Solution
3. Betadine
4. Xenodine Spray

Adverse Side Effects

Iodine can be irritating and sensitizing, especially in cats. Most products stain.

Technician's Notes

1. Povidone-iodine is nonstaining.
2. Xenodine is not as irritating as other iodines.

Benzalkonium Chloride

Benzalkonium chloride is antifungal and antibacterial but is not effective against *Pseudomonas* spp. Soap and other anionic compounds inactivate it.

Dosage Forms

1. Topical wound spray
2. Myosan Cream
3. Dermacide

Adverse Side Effects

Toxicity can occur in cats.

Technician's Notes

This product is not approved for use in food-producing animals or in animals intended for food.

WOUND HEALING

A wound is created when an insult—either purposeful, such as surgery, or incidental, such as trauma—disrupts the normal integrity of the tissue (McCurnin and Bassett, 2002). Normal wound healing can be divided into four stages: inflammation, debridement, repair, and maturation. However, more than one phase of wound healing usually is occurring at any time (McCurnin and Bassett, 2006). The inflammatory phase usually begins with hemorrhage and is limited by vessel contraction and constriction. Serum leakage into the wound deposits fibrinogen and other clotting elements. Later, this serum provides enzymes, proteins, antibodies, and complement. The debridement phase begins about 6 hours after injury and is facilitated by the appearance of neutrophils and monocytes that migrate to the wound. Neutrophils phagocytize bacteria and then die. Monocytes become macrophages and phagocytize necrotic debris. The repair phase is marked by the formation of a blood clot and is usually active by 3 to 5 days post-injury. During the repair phase, fibroblasts produce **collagen** and other connective tissue proteins. Capillaries infiltrate the wound to provide blood supply and oxygen. This process forms **granulation tissue**. Epithelial cells proliferate beneath the scab, and the

wound begins to contract. The maturation phase is the end of wound healing and is a period of remodeling. During this time, the wound consolidates and strengthens. Many factors contribute to proper wound healing. These include patient factors (e.g., the age of the patient, nutritional status, rest, environment, and general health); wound factors—including wound characteristics (i.e., contaminated wounds versus noncontaminated wounds); external factors (e.g., temperature regulation [i.e., bandage]); whether or not lavage is performed; and how the wound is closed (e.g., primary, secondary). A veterinarian must consider all these factors when determining how to treat a wound and anticipating how well it will heal.



Topical Wound Dressings

The treatment of wounds may involve systemic therapy, bandages, topical medications, or a combination of treatments. Topical dressings are commonly used in the treatment of wounds. These wound dressings are available as ointments, solutions, gels, creams, lotions, sprays, powders, and dressing sheets. The type of dressing and the length of therapy are dependent on the previously mentioned factors that affect wound healing. For example, a degloving injury will take weeks to months for complete healing to occur, whereas a small abrasion may heal in a few days.

Healing Stimulators

Some dressings stimulate the activities of wound healing. These products may be used on simple wounds or may be most helpful during the later stages of large wound healing, when less exudate is produced. Some products may be used alone or in combination with other products. Depending on the wound, a bandage may be applied. Many times, a bandage is applied to keep a wound warm because warmth advances the healing process. Advances in products that stimulate healing include the addition of products that contain acemannan or bovine collagen. Acemannan promotes fibroblast proliferation, collagen deposition, **angiogenesis**, and epithelialization. Products that contain bovine collagen also promote fibroblast

proliferation and collagen deposition (Swaim and Gillette, 1998).

Dosage Forms

1. Scarlet Oil
2. Zinc Oxide
3. Carravet Wound Dressing
4. BioDres
5. Collamend

Adverse Side Effects

Adverse side effects are uncommon.

Technician's Notes

1. It is very important to follow manufacturer recommendations regarding application frequency.
2. Keep bandages dry and clean.
3. Some products may not be suitable for deep or puncture wounds.

Wound Cleansers

Wound cleansers are used during the lavage of wounds in an effort to remove necrotic tissue, debris, and bacteria. Some products also act as healing stimulants. These products may be used in the initial cleansing of a wound before a wound dressing is applied. (It should be noted that great benefit is given to the healing process when warm water lavage lasting 15 minutes or longer is performed on the wound.) More extensive wounds will require cleansing at every treatment because of the large amounts of exudate that may be produced during the early stages of healing. It is important that necrotic tissue and purulent debris be removed during cleansing. Some products are applied directly to the wound after cleansing or removal of necrotic tissue. A nonadherent bandage may be applied, and these products will absorb exudate and stimulate the healing process.

Dosage Forms

1. Oti-Clens
2. C-Stat
3. Intracell
4. Dakin's solution—a 0.5% solution of sodium hypochlorite (bleach)
5. Granulex-V

Adverse Side Effects

These are uncommon, but some products may cause temporary stinging after application.

Technician's Notes

1. These products should not be used on fresh arterial clots.
2. Keep bandages dry and clean.
3. Some products may not be suitable for deep or puncture wounds.

Protectants

Protectants provide a protective environment to assist the healing of noninfected wounds. Some products protect the skin from irritation caused by urine, feces, and tape. They act as a barrier to prevent irritation and allow healing of previously irritated intact skin.

Dosage Forms

1. Dermal Wound Gel
2. Thuja-Zinc Oxide Ointment
3. Nexaband
4. Tissuemend
5. No Sting Barrier Film

Technician's Notes

1. These products should be applied to clean, dry skin.
2. These products are not suitable for deep or puncture wounds.
3. Products that contain zinc oxide may cause zinc toxicity if ingested.

Other Drugs Used in Dermatologic Therapy**Systemic Corticosteroids**

Sometimes it may be necessary to use systemic corticosteroids in the treatment of some dermatosis and dermatitis conditions. These drugs affect immunologic and inflammatory activity. Systemic steroids

are available for oral and parenteral administration. The effects of systemic steroids may last from a few hours up to several weeks depending on the type of steroid used. Chapter 9 provides an in-depth discussion of systemic corticosteroids and their effects on the body.

Clinical Uses

In the treatment of dermatologic conditions, systemic corticosteroids are indicated for allergic reactions (e.g., flea bite hypersensitivity, atopy), moist dermatosis (hot spot), **seborrheic dermatitis**, and acral lick dermatitis.

Dosage Forms

1. Dexamethasone injection
2. Depo-Medrol injection
3. Prednisone generic tablets
4. Medrol tablets
5. Vetalog

Adverse Side Effects

Adverse side effects are numerous. Many occur with misuse and long-term use. Side effects most commonly seen with doses used in the treatment of skin inflammation and pruritus include polyuria, polydipsia, and polyphagia, which may result in weight gain.

Technician's Notes

The technician should alert clients to the side effects seen with systemic corticosteroids. Polyuria and polydipsia may be problematic for some household pets. Technicians should always consult the veterinarian when refilling each prescription of systemic corticosteroids and should note the doctor's approval of the refill on the medical record.

Topical Antibacterial Agents

Topical antibacterial agents are used in the treatment and prevention of superficial bacterial infections of wounds. These products may contain corticosteroids and antifungal agents. They may require frequent application (i.e., 2 to 3 times daily) and can be used under bandages.

Dosage Forms

1. Bactoderm
2. Nitrofurazone dressing
3. Forte-Topical
4. Prodine solution
5. Furazolidone spray
6. Gentamicin sulfate/betamethasone valerate ointment and spray
7. Gentamicin sulfate/betamethasone valerate/clotrimazole ointment

Technician's Notes

To achieve good contact with the skin surface, clipping the hair before application is often necessary.

Topical Antifungal Agents

Topical antifungal agents are used in the treatment of superficial fungal infections. They are effective in the treatment of ringworm and for thrush in equines. They are often found in combination with antibacterial agents and corticosteroids. They may necessitate frequent application (i.e., 2 to 3 times daily) and can be used under bandages. Local treatment of fungal infections is not always effective, and the use of systemic antifungal agents may be necessary.

Dosage Forms

1. Conofite
2. Kopertox
3. Miconazole
3. Panalog
4. Iodine Shampoo
5. Clotrimazole cream
6. Cuprimyxin cream
7. Tolnaftate cream

Technician's Notes

1. To achieve good contact with the skin surface, clipping the hair before application is often necessary.
2. Kopertox and products that contain iodine will stain clothes and light-colored hair.

Fatty Acid Supplements

Fatty acids consist of long chains of carbon atoms with a methyl group ($-CH_3$) at one end. Polyunsaturated fatty acids have varying numbers of double bonds that connect the carbon atoms. Formulas used to identify fatty acids give the number of carbon atoms, followed by the number of double bonds, and finally the distance of the first double bond from the methyl group. The formula for arachidonic acid, (20:4N-6), indicates that this fatty acid has 20 carbon atoms and four double bonds and that the first double bond is six carbon atoms from the methyl group.

Fatty acids that have the first double-bond six-carbon atoms away from the methyl group are called *omega-6 (N-6) fatty acids*. Those that have the first double-bond three-carbon atoms away are called the *omega-3 (N-3) fatty acids* (Scott, Miller, and Griffin, 1995). Linoleic acid (18:2N-6) and linolenic acid (18:3N-3) cannot be synthesized by the dog and must be supplied in the diet. For this reason, linoleic and linolenic acids are called *essential fatty acids*. Arachidonic acid is an essential fatty acid in the cat.

Fatty acids are responsible for the shine of the haircoat and the smooth texture of the skin. It has also been well documented that fatty acid supplementation can play an important role in managing the itching dog or cat. The exact mechanism by which fatty acids help to control itching is not known, but it has been proposed that fatty acids may tie up cyclooxygenase and/or phospholipase (see Chapter 14), thereby inhibiting prostaglandin formation in the skin. A synergistic effect may be achieved by combining fatty acid therapy with the administration of antihistamines or glucocorticosteroids.

Fatty acid supplements are usually derived from fish oil or vegetable oil and may be combined with antioxidant vitamins such as A and E.

Clinical Uses

Fatty acid supplements are used to control itching (pruritus) associated with certain dermatologic conditions of dogs and cats. They also may be used to improve the luster of the skin (Boothe, 2001).

Dosage Forms

1. Dermcaps
2. Dermcaps ES
3. Dermcaps ES liquid
4. EFA-Caps
5. Pet Tabs FA liquid

Adverse Side Effects

Side effects may include vomiting, diarrhea, or increased bleeding times.

**Counterirritants**

Counterirritants are substances that are applied to the skin of horses to produce local irritation and inflammation. These compounds are sometimes used to treat chronic inflammatory conditions of bone, joints, ligaments, tendons, or other tissues below the surface. The rationale for their use is that creating an acute inflammatory condition promotes blood supply to the inflamed area and adjacent tissue. This increased blood supply brings with it more oxygen, white blood cells, antibodies, complement, and other factors to promote healing. The proper use of counterirritants is complicated because underuse may have little effect and overuse may cause severe tissue damage. The beneficial effects of using counterirritants are controversial, and many clinicians claim that the period of enforced rest (1 to 3 months) for treated animals is actually responsible for the healing effect.

When counterirritants are applied to the skin, three stages of irritation result, depending on the agent applied, the quantity applied, and the way in which it is applied. The three stages are listed below.

1. Rubefaction
2. Vesication
3. Blistering

Rubefaction (reddening) indicates mild irritation accompanied by an increase in blood congestion in the skin. Liniments and "braces" are alcohol-based products that produce a rubefacient effect when massaged into the skin. Liniments and braces usually have alcohol as the primary ingredient and may include oil of wintergreen, camphor, turpentine, thymol, menthol, or ammonia. The major benefits

of these products may result from the massage used in their application rather than the medicinal effect. A *tightener* is a rubefacient compound, similar to a liniment or a brace, that is applied under a cotton leg wrap in an effort to reduce edema around tendons or joints. A *sweat* usually contains alcohol and glycerin and is applied under a moisture-proof bandage to reduce edema.

Clinical Uses

Counterirritants are used for reducing "filling" (edema) around joints or tendons and associated soreness.

Dosage Forms

1. White Liniment
2. Isopropyl alcohol
3. Lin-O-Gel
4. Shin-O-Gel
5. Absorbine Veterinary Liniment
6. Equ-Lin
7. BIGEOIL
8. SU-PER Sweat
9. Antiphlogistine Poultice
10. SU-PER Poultice

Adverse Side Effects

Tissue irritation may be caused by counterirritants.

Vesication

Vesication, the second stage of counterirritation, is achieved by applying irritating substances under a bandage. Severe irritation accompanied by capillary damage results in vesication or blister formation. Mercuric oxide and cantharide ointments are commonly used as blistering agents. Since the application of vesicants is a painful process that can lead to self-mutilation, they should be applied only under the supervision of a veterinarian.

Clinical Uses

Vesication is used in the treatment of chronic inflammatory musculoskeletal conditions in horses.

Dosage Forms

1. Mercuric oxide
2. Cantharide

Adverse Side Effects

These may include severe tissue damage, worsening of the original condition, and self-mutilation.

Technician's Notes

Petroleum jelly should not be applied around the site where a vesicant is applied. To do so may damage adjacent tissue.

Caustics

Caustics are substances that destroy tissue at the application site. They are used to destroy excessive granulation tissue (proud flesh), superficial tumors (warts), or horn buds. They should be applied by knowledgeable persons because they can cause damage to adjacent tissue.

Clinical Uses

Caustics are used for the control of proud flesh, the removal of warts, and the removal of horn buds in calves.

Dosage Forms

1. Copper sulfate
2. Silver nitrate
3. Proudsoff
4. Wartsoff
5. Caustic Powder
6. Acidified Copper Sulfate
7. Caustic Dressing Powder
8. Equi-Phar Proud Blue Liquid
9. Dehorning Paste

Adverse Side Effects

These may include damage to adjacent tissue, especially the eye when used on the horn buds.

Miscellaneous Drugs

Some drugs used for behavior modification in cats and dogs can be used in dermatologic conditions such as feline psychogenic alopecia and canine

acral lick dermatitis (Merck, CD-ROM, ed. 8). These conditions occur because of excessive self-licking. Tricyclic antidepressants are potent H₁ blockers that also inhibit the uptake of serotonin and norepinephrine.

Clinical Uses

These drugs are used to modify behavior in such a way that excessive self-licking may be decreased. They may be used in the treatment of feline psychogenic alopecia and canine acral lick dermatitis.

Dosage Forms

1. Phenobarbital
2. Diazepam (Valium)
3. Amitriptyline
4. Fluoxetine
5. Naloxone
6. Naltrexone

Adverse Side Effects

Side effects include sedation, idiosyncratic fatal hepatic necrosis in cats, dry mouth, hypersalivation, vomiting, constipation, urinary retention, ataxia, disorientation, depression, and anorexia.

Selective Immunosuppressors

Cyclosporine A (ATCvet code QL04A A01) is used as a selective immunosuppressor in the treatment of atopic dermatitis. It is a cyclic polypeptide that acts specifically and reversibly on T-lymphocytes. It has antiinflammatory and antipruritic activities that aid in the treatment of atopic dermatitis. Cyclosporine inhibits the antigen-triggered release of lymphokines by activated T-lymphocytes and by activated T-cells. It also inhibits activation of eosinophils, keratinocyte cytokine production, Langerhans cell function, and degranulation of mastocytes. Cyclosporine does not interrupt hemopoiesis and does not interfere with the function of phagocytic cells (Novartis, 2007).

Dosage Forms

Cyclosporine (Atopica)

Adverse Side Effects

The most frequently observed undesirable effects are gastrointestinal disturbances such as vomiting, mucoid or soft stools, and diarrhea. These effects are usually mild and generally do not require cessation of treatment with Atopica (Novartis Animal Health Inc., New London, Connecticut, USA). Sometimes (very rarely), muscle cramps, muscle weakness, anorexia, gingival hypertrophy, verruciform lesions, or changes in haircoat have been observed (Novartis, 2007).

REFERENCES

- Boothe DM: Dermatologic therapy. In Boothe DM: Small animal clinical pharmacology and therapeutics, Philadelphia, 2001, WB Saunders.
- McCurnin DM, Bassett JM, editors: Clinical textbook for veterinary technicians, ed. 5, Philadelphia, 2002, WB Saunders.
- McCurnin DM, Bassett JM, editors: Clinical textbook for veterinary technicians, ed. 6, Philadelphia, 2006, WB Saunders.
- Merck veterinary manual, CD-ROM, ed 8, Whitehouse Station, NJ, 2000, Merck & Co.
- Novartis (2007): www.ah.novartis.com/products/en/cab/atopica.shtml
- Pasquini C, Spurgeon T, Pasquini S, editors: Anatomy of domestic animals, ed 7, Pilot Point, Tex, 1995, Sudz Publishing.
- Scott DW, Miller WH, Griffin CE: Dermatologic therapy. In Small animal dermatology, ed 5, Philadelphia, 1995, WB Saunders.
- Swaim SF, Gillette RL: An update on wound medications and dressings, *Compend Cont Educ Prac Vet* 20(10):1133-1145, 1998.



REVIEW QUESTIONS

- The skin consists of _____ layers and is part of the _____ system.
- _____ is essential for healthy skin.
- Name seven functions of the skin.

- Shampoos are more effective if left on the skin about _____ to _____ minutes before rinsing.
- Keratolytics and keratoplastics are known as _____ agents.
- Name the four stages of wound healing.

- What does an astringent do to the skin?

- Tissue irritation may be caused by counterirritants.
 - True
 - False
- Patients are commonly presented for skin problems when in reality they may have a _____ illness.
- Why are behavioral-type drugs used in treating skin illness? _____
- All patients presented for dermatologic problems have an underlying systemic illness.
 - True
 - False
- The _____ is the largest organ in the body.
 - liver
 - spleen
 - skin
 - stomach
 - intestinal tract
- Increased skin irritation may result in hyperpigmentation of the skin.
 - True
 - False
- Humans have multiple hairs per follicle, but animals have one hair per follicle.
 - True
 - False
- Shampoos should be left on the animal's skin for 5 to 10 minutes before rinsing.
 - True
 - False
- The debridement stage of wound healing usually begins to occur about ____ hour(s) after injury.
 - 2
 - 3
 - 1
 - 6
- During the repair phase of wound healing, fibroblasts produce _____ and other connective tissue proteins.
 - angiogenesis
 - collagen
 - comedones
 - hyperpigmentation
- The maturation phase marks the beginning of wound healing.
 - True
 - False
- _____ tissue is formed during healing of wounds of the soft tissue that consists of connective tissue cells and ingrown young vessels, which ultimately form a scar.
 - Collagen
 - Keratolytic
 - Callus
 - Granulation
- _____ is a product that is used in horses to treat thrush.
 - Conofite
 - Miconazole
 - Kopertox
 - Panalogs

Pharmacokinetics
Pharmacodynamics

TETRACYCLINES

Pharmacokinetics
Pharmacodynamics

AMINOGLYCOSIDES

Pharmacokinetics
Pharmacodynamics

FLUOROQUINOLONES

Pharmacokinetics
Pharmacodynamics

OTHER ANTIINFECTIVES

Chloramphenicol

Florfenicol

Macrolides and Lincosamides

Macrolides

Lincosamides

Vancomycin

Spectinomycin

Polymyxin B and Bacitracin

Sulfonamides

Nitrofurans

Rifampin

ANTIFUNGAL DRUGS

Polyene Antifungal Agents

Amphotericin B

Nystatin

Imidazole Antifungal Agents

Ketoconazole and Miconazole

Itraconazole

Antimetabolic Antifungal Agents

Flucytosine

Superficial Antifungal Agents

Griseofulvin

Other Antifungal Agents

ANTIVIRAL DRUGS

Acyclovir

Interferon Alfa-2A, Human Recombinant

DISINFECTANTS/ANTISEPTICS

Alcohols

Ethylene Oxide

Formaldehyde

Chlorines and Iodines

Phenolics: Saponated Cresol, Semisynthetic

Phenols

Quaternary Ammonium Compounds:

Cationic Detergents

Biguanide Compounds

Other Disinfectants

Soaps

Organic Mercury Compounds

Alkalis

Hydrogen Peroxide

Glutaraldehyde

CHAPTER 12

Antiinfective Drugs

LEARNING OBJECTIVES

After studying this chapter, you should be able to:

1. Identify the classes of antiinfective drugs.
2. Describe the adverse side effects of antiinfective drugs.
3. Explain the clinical uses of antiinfective drugs.
4. Discuss antiviral drugs.
5. Explain how disinfectants and antiseptics are used.



KEY TERMS

ANTIBACTERIAL An agent that inhibits bacterial growth, impedes replication of bacteria, or kills bacteria.

ANTIBIOTIC An agent produced by a microorganism or semisynthetically that has the ability to inhibit the growth of or kill microorganisms.

ANTIMICROBIAL An agent that kills microorganisms or suppresses their multiplication or growth.

BACTERIA Single-celled microorganisms that usually have a rigid cell wall and a round, rod-like, or spiral shape.

BACTERICIDAL An agent with the capability to kill bacteria.

BACTERIOSTATIC An agent that inhibits the growth or reproduction of bacteria.

BETA-LACTAMASE Enzymes that reduce the effectiveness of certain antibiotics; beta-lactamase I is penicillinase; beta-lactamase II is cephalosporinase.

DERMATOPHYTOSIS A fungal skin infection.

DETERGENT An agent that cleanses.

DISINFECT To make free of pathogens or make them inactive.

FUNGICIDAL An agent that kills fungi.

FUNGISTATIC An agent that inhibits the growth of fungi.

IN VITRO Within an artificial environment.

IN VIVO Within the living body.

IODOPHOR An iodine compound with a longer activity period that results from the combination of iodine and a carrier molecule that releases iodine over time.

MICROORGANISM An organism that is microscopic (e.g., bacterium, protozoan, *Rickettsia*, virus, and fungus).

SPORICIDAL An agent capable of killing spores.

INTRODUCTION

Microorganisms are ubiquitous in the environment. Some microorganisms have pathogenic potential, but others do not. Animals usually make initial contact with an infectious agent somewhere on the body's surface (e.g., mucous membranes, skin, respiratory tract, digestive tract). In the fight against infection, several hundred **antimicrobial** drugs have been developed since the early 1900s. These drugs have been used to fight disease in both humans and animals.

Not all antimicrobials have the same degree of effectiveness against **microorganisms**. A determination can be made to distinguish different types of bacteria with the use of a Gram stain. The Gram stain is a laboratory procedure in which dyes are used to stain **bacteria** (Figure 12-1). Gram-positive bacteria stain dark blue to purple. Gram-negative bacteria stain pink to red. However, some bacteria cannot be identified through the Gram stain technique. To differentiate acid-fast bacilli, carbol fuchsin stain can be used and then decolorized with ethyl alcohol and hydrochloric acid. Other bacteria must be identified by special techniques such as dark-field examination or Gimenez stain. Giemsa

and Wright stains may be used to identify parasites and intracellular microorganisms. Bacteria with similar staining properties tend to respond to the same antimicrobial therapy. Still other bacteria are classified by their ability to survive with or without oxygen. Aerobes are bacteria that must have oxygen to live and replicate. Other bacteria are able to live and multiply without oxygen; these are known as anaerobes. Anaerobes may be hardy and difficult to eradicate.

MECHANISM OF ACTION

Through analysis of the effects that a drug's action has on bacteria, antimicrobial drugs can be divided into two categories: **bactericidal** and **bacteriostatic**. However, some strains of mutant bacteria have greater resistance to some antimicrobials. Resistant strains of bacteria can make antimicrobial therapy difficult. Therefore, to prevent mutant strains from developing, antimicrobial drugs must not be used indiscriminately. Sometimes, it may be necessary to use two different types of antimicrobial drugs to treat patients with infections caused by two or more different organisms.

**FIGURE 12-1**

The Gram stain is a laboratory test that is commonly used to distinguish different types of bacteria. The procedure is as follows: (1) After preparing the slide and heat fixing, flood smear with crystal violet solution and let stand 1 minute. (2) Rinse gently with tap water. (3) Flood smear with Gram's iodine and let stand 1 minute. (4) Rinse gently with tap water and flood with Gram's decolorizer for 5 to 10 seconds. (5) Wash gently with tap water. (6) Flood smear with safranin counterstain for 30 to 60 seconds. (7) Wash gently with tap water, blot dry, and examine under oil immersion (i.e., using the microscope's 100 \times objective). The staining solutions are shown here in the order in which they are used.

After a laboratory has identified the type of organism that is causing an infection, a sensitivity test may be performed. Several tests are available for testing the susceptibility of an organism to a specific antimicrobial drug. Most commonly, the disk susceptibility test is used in small laboratories (Figure 12-2). With this test, an agar plate with a standard amount of cultured organism is used. With the use of a dispenser, paper disks impregnated with various antimicrobial drugs are placed within the agar plate. Incubation is carried out, along with measurement of the zones of inhibition. These zones show which antimicrobial agents are susceptible or resistant to each particular antimicrobial, and how effectively they may perform *in vitro*. The Kirby-Bauer procedure is commonly used in many laboratories.

The broth dilution susceptibility test is used in many laboratories (Figure 12-3). An organism is inoculated into a series of tubes or wells in a microculture plate. These tubes or wells contain different concentrations of antimicrobials. The lowest concentration that macroscopically inhibits the growth of an organism is the minimum inhibitory concentration (MIC). The MIC represents the degree of susceptibility of an organism to a specific concentration of a

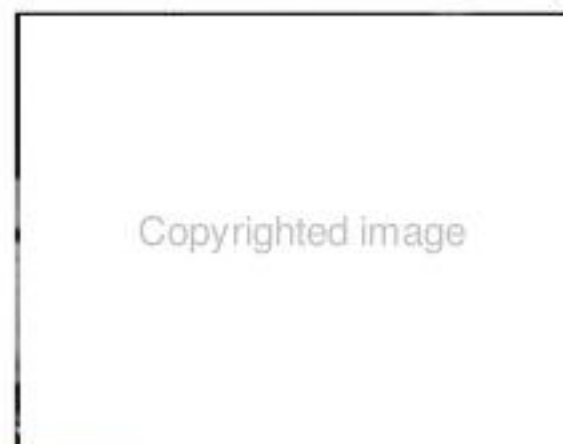
**FIGURE 12-2**

The agar diffusion test measures the *in vitro* susceptibility of a microorganism to specific antibiotics. Note the zones of inhibition surrounding the antibiotic disks.

particular antimicrobial drug. The antimicrobials that are effective *in vitro* may not always be the best choice for use *in vivo*. A clinician chooses which agent to use by considering the diagnosis and assessing each agent's pharmacodynamics and pharmacokinetics. This process allows a clinician to choose the most efficient and efficacious drug to treat a specific condition.

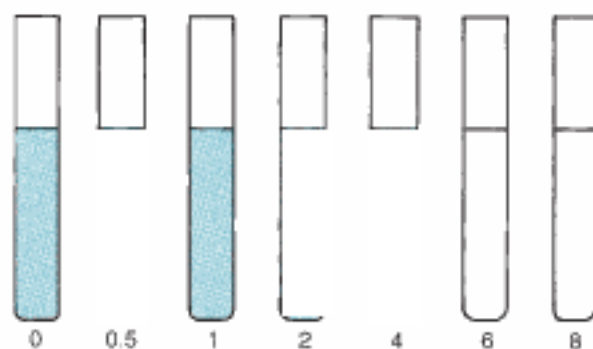

FIGURE 12-3

The broth dilution susceptibility test. Note that the organism grew in broth containing 0, 0.5, 1, 2, and 4 mg/ml of antibiotic. The organism was inhibited in the tube that contained 6 mg/ml. The minimum inhibitory concentration is 6 mg/ml.

Technician's Notes

Special Considerations When Antimicrobial Drugs Are Used

1. Do not use antimicrobial drugs for mild infection.
2. Antimicrobials should be used only for individuals at risk of severe infection.
3. Do not dismiss the principles of asepsis just because there are many antibiotics from which to choose.
4. The use of antimicrobials should be based on a definitive diagnosis.
5. Do not use a broad-spectrum antibiotic if the infecting organism is sensitive to a specific antibiotic.
6. Antimicrobial drugs should be administered in full therapeutic doses.
7. If an antimicrobial can be used topically or locally, do so. This reserves the use of systemic drugs for serious disease.
8. Be careful regarding antibiotic withdrawal times in animals to be slaughtered for human consumption and antibiotic withdrawal times in dairy cows.
 - a. Penicillin G benzathine is long-acting (48 hours) and is not approved for use in dairy animals.



Penicillins

Penicillin was developed during the 1940s and remains very important as an antimicrobial drug, even though many other antimicrobials are available in

today's arsenal of drugs. Researchers have developed natural and semisynthetic compounds that display varied antimicrobial spectra (Table 12-1).

Many penicillin formulations may “settle out” (i.e., precipitate) during nonuse and must be shaken well before use. Additionally, when oral preparations are reconstituted, it is important to add appropriate amounts of water so that dilution does not occur (e.g., when amoxicillin oral preparations are mixed). Many oral preparations are stable for only 7 to 14 days. Most penicillin formulations must be stored in the refrigerator, and the veterinary technician must tell clients that oral prescriptions for pets should be administered until the entire therapeutic time frame has been completed.

Pharmacokinetics

Absorption of most orally administered penicillins takes place in the stomach and small intestine (i.e., the duodenum). Most injected penicillins are absorbed rapidly at the injection site and are distributed rapidly through most tissue. The kidneys are the primary organs for excretion of penicillins, although the liver metabolizes other penicillins. Withdrawal times for dairy cows must be adhered to because penicillins are excreted through the milk. Veterinary technicians should be aware of the withdrawal rates of penicillin and should ensure that proper directions are included on the prescription label, especially for clients who are beef and dairy producers.

Pharmacodynamics

Research has shown that penicillins bind reversibly with enzymes outside the bacterial cytoplasmic membrane. These enzymes, called *penicillin-binding proteins* (PBPs), are involved in cell wall synthesis and cell division; when this binding occurs, it increases internal osmotic pressure and ruptures the cell. Some bacteria produce **beta-lactamase** (penicillinase), which increases the resistance of bacteria by converting penicillin to inactive penicillic acid. Some penicillins are more resistant to beta-lactamase hydrolysis and are referred to as *beta-lactamase-resistant* or *penicillinase-resistant penicillins*. Penicillins are usually very effective against gram-positive bacteria, but gram-negative bacteria have an outer membrane

Table 12-1 Penicillin Preparations, Indications, and Antagonistic Drugs

Drug	Indications	Antagonist	Comments
Narrow-Spectrum Penicillins			
Penicillin G sodium	Infections caused by penicillin-sensitive organisms; bacterial pneumonia, upper respiratory tract infections, equine strangles, blackleg, infected wounds, urinary tract infections (at high doses)	Tetracyclines, chloramphenicol, and paromomycin	May add to sodium load
Penicillin G potassium	Same as for penicillin G sodium	Same as for penicillin G sodium	May produce hyperkalemia (IV); delayed absorption in horses (IM); unreliable absorption
Penicillin G procaine	Same as for penicillin G sodium	Same as for penicillin G sodium	Never give IV; contraindicated in some exotics and horses that race; pre-slaughter withdrawal and milk withholding periods
Penicillin G benzathine	Same as for penicillin G sodium	Same as for penicillin G sodium	Never give IV; preslaughter withdrawal required, and may persist in dairy cattle milk for 2 weeks
Narrow-Spectrum, Acid-Resistant Penicillins			
Penicillin V	Mild infections already controlled by parenteral therapy	Same as for penicillin G sodium	Should not be administered with food; less active against gram-negative bacteria than penicillin G
Beta-Lactamase-Resistant Penicillins			
Methicillin	Pyodermitis, otitis externa, and other conditions caused by <i>Staphylococcus aureus</i>	Same as for penicillin G sodium	Not stable in solution; many incompatibilities in vitro
Cloxacillin	Same as for methicillin	Same as for penicillin G sodium	Frequently used in dry-cow intramammary preparations
Dicloxacillin and floxacillin	Same as for methicillin	Same as for penicillin G sodium	Absorbed from GI tract better than cloxacillin
Oxacillin	Same as for methicillin	Sulfonamides	Not absorbed as well as cloxacillin
Broad-Spectrum Penicillins			
Ampicillin and hetacillin	Infection of organs and tissues caused by ampicillin-sensitive bacteria	Chloramphenicol, erythromycin, tetracyclines, cephaloridine	Incompatible with many drugs and solutions; food impairs absorption; milk withholding and pre-slaughter withdrawal times
Amoxicillin	Same as for ampicillin	Same as for ampicillin	Absorbed from GI tract better than ampicillin

Table 12-1 Penicillin Preparations, Indications, and Antagonistic Drugs—cont'd

Drug	Indications	Antagonist	Comments
Piperacillin	Same as for ampicillin	Aminoglycosides	
Carbenicillin sodium	Same as for ampicillin, but especially <i>Pseudomonas</i> infections	Same as for ampicillin	Freshly mixed solutions should be used
Broad-Spectrum Penicillins			
Carbenicillin indanyl sodium	Same as for carbenicillin sodium	Same as for ampicillin	Absorbed rapidly from the GI tract
Ticarcillin	Same as for carbenicillin sodium	Same as for ampicillin	Used as an intrauterine infusion in mares
Potentiated Penicillins			
Amoxicillin-potassium clavulanate (4:1)	Wide range of infections when used in combination	Same as for ampicillin	Capsules/tablets that are not kept in air-tight containers lose activity; do not give to patients allergic to penicillins or cephalosporins
Inhibitor of Tubular Secretion of Penicillins			
Probenecid	Prolongs blood levels of penicillins that have very short plasma half-lives or that are extremely costly	Same as for ampicillin	

around the cell wall that limits PBP permeability. Some penicillins have an increased ability to penetrate this outer membrane and may be more effective against gram-negative bacteria.

Clinical Uses

Penicillins are used to treat individuals with bacterial infections resulting from penicillin-susceptible microorganisms.

Dosage Forms

1. Amoxicillin (tablets and oral liquids for dogs and cats)
 - a. Amoxicillin
 - b. Amoxi-Tabs
 - c. Amoxi-Drops
 - d. Amoxi-Inject
 - e. Robamox
 - f. Biomox
 - g. Amoxicillin trihydrate
 - i. Many brands are available

- h. Withdrawal times (cattle only)
 - i. Meat = 25 days
 - ii. Milk = 96 hours
2. Ampicillin (Veterinary)
 - a. Amp-Equine
 - b. Ampicillin trihydrate (Polyflex)
 - c. Withdrawal times (at 6 mg/kg)
 - i. Meat = 6 days
 - ii. Milk = 48 hours
3. Carbenicillin
 - a. Geopen
 - b. Pyopen
4. Cloxacillin
 - a. Cloxapen
 - b. Orbenin
 - c. Tegopen
5. Dicloxacillin
 - a. Dynapen
6. Penicillin G
 - a. Many brands available
 - b. Penicillin G, potassium or sodium

- c. Penicillin G, benzathine: Benza-Pen, Benzylpenicillin (many brands available)
 - d. Penicillin G, procaine
 - i. Many brands available
 - e. Penicillin V: Pen-Vee
 - f. Amoxicillin trihydrate
 - i. Many brands available
 - g. Withdrawal time (cattle)
 - i. Meat = 4 days
 - ii. Milk = 48 hours
 - iii. Calves = 7 days
 - h. Withdrawal time (sheep)
 - i. 8 days
 - i. Withdrawal time (swine)
 - i. 6 days
 - j. Withdrawal time at higher doses (i.e., off-label doses)
 - i. Meat = 21 days
7. Ticarcillin
- a. Ticar
 - b. Ticillin

Adverse Side Effects

Allergic reactions, vomiting and diarrhea, or enteritis may occur in cattle and horses when treatment is administered orally. Hives or respiratory distress also may occur because of possible sensitivity reactions to penicillin. Epinephrine should be administered STAT if respiratory distress is severe.

Technician's Notes

1. Subcutaneous (SC) administration of penicillin G or benzathine penicillin should be avoided because of potential tissue injury and residue potential in food animals.
2. Penicillin should not be used in horses intended for food.
3. Carefully read labels concerning milk withholding times and the treatment of animals to be slaughtered for food.
4. Penicillin G benzathine is long-acting (48 hours) and is not approved for use in dairy cattle.

AMOXICILLIN + CLAVULANATE POTASSIUM

Known as Augmentin in human medicine, Clavamox (veterinary) is a beta-lactam antibiotic + beta-lactamase inhibitor. Clavamox is a broad-

spectrum antibiotic that is used to treat skin infection, urinary tract infection, wound infection, and respiratory infection. Clavamox is supplied in tablet and liquid forms for oral administration.

Dosage Form

1. Amoxicillin + clavulanate potassium
 - a. Clavamox tablets
 - b. Clavamox liquid

Adverse Side Effects

Although allergic reactions may occur, this drug usually is well tolerated. Vomiting and diarrhea may occur in some animals when this drug is administered orally.

Technician's Notes

Use with caution in animals with allergies to penicillin.



Cephalosporins

Cephalosporins are used primarily in small-animal medicine. However, a few have been developed for use in large-animal medicine. This group of drugs is classified into generations according to spectrum of activity (Table 12-2).

Pharmacokinetics

Most cephalosporins are administered parenterally because they lack the ability to be well absorbed by the gastrointestinal (GI) tract. Once absorbed, cephalosporins are distributed to tissues and fluids, with the exception of the central nervous system (CNS). Some cephalosporins are absorbed into the cerebrospinal fluid, but this absorption is limited. Metabolism occurs in the liver, with elimination occurring in the kidneys by glomerular filtration and tubular secretion into the urine. Therefore, doses must be modified for patients in renal failure. With a few exceptions, cephalosporins are excreted through the feces via the biliary system.

Table 12-2 Cephalosporin Preparations, Indications, and Antagonistic Drugs

Drug	Indications	Antagonist	Comments
Cefadroxil	Infections caused by sensitive organisms in the respiratory tract, skin, urinary tract, soft tissue, bones, joints, etc.	All cephalosporins: gentamicin	Ingestion of food does not impair absorption
Cephalexin	Urinary tract infections		Ingestion of food may delay absorption
Cephalothin	Infections caused by sensitive organisms in the respiratory tract, skin, urinary tract, soft tissue, bones, joints, etc.		IM injection painful; inactivated in liver
Cefazolin	Same as for cephalothin		Highly protein bound; very rarely nephrotoxic
Cephapirin	Same as for cephalothin		Intramammary infusion for mastitis
Cefamandole	Life-threatening, gram-negative infections		Dose should be reduced in patients with renal failure
Cefoxitin (a cephamycin)	Treatment of susceptible infections		Local reaction may occur at injection site
Ceftiofur HCl	Treatment of respiratory disease in cattle and swine; broad spectrum against gram-positive and gram-negative bacteria including beta-lactamase-producing strains		May be used in lactating dairy animals
Ceftiofur sodium	Treatment of respiratory disease in cattle, sheep, horses, and swine; urinary tract infections in dogs; and for control of early mortality associated with <i>E. coli</i> organisms in day-old chicks and day-old turkey poults; broad spectrum against gram-positive and gram-negative bacteria including beta-lactamase-producing strains		May be used in lactating dairy animals

Pharmacodynamics

Similar to penicillins, cephalosporins interfere with cell wall synthesis by binding to the bacterial enzymes (PBP's). The spectrum of activity of a cephalosporin is revealed by the drug's ability to penetrate the bacterial cell wall and bind with proteins within the cytoplasmic membrane. Another similarity between cephalosporins and penicillins is the susceptibility of cephalosporins to beta-lactamases (cephalosporinases), which can be produced by certain bacteria. Some cephalosporins are more

effective in treating individuals with infection caused by bacteria that produce beta-lactamase II.

Technician's Notes

1. Naxcel is approved for use in lactating dairy animals.
2. Remember to read package inserts regarding milk withholding time and withholding time in animals to be slaughtered.

Clinical Uses

Cephalosporins are used to treat cystitis, skin and soft tissue infections in dogs and cats, bovine mastitis, shipping fever, and other respiratory infections in cattle, horses, sheep, and swine. Ceftiofur sodium (Naxcel) also is approved for use in day-old chicks and day-old turkey poults for control of early mortality associated with *Escherichia coli* organisms.

Dosage Forms

1. Cefaclor (second-generation cephalosporin antibiotic)
 - a. Ceclor
2. Cefadroxil (first-generation cephalosporin antibiotic)
 - a. Cefa-Tabs
 - b. Cefa-Drops
3. Cefazolin (first-generation cephalosporin antibiotic)
 - a. Ancef
 - b. Kefzol
 - c. Many other brands available
4. Cefepime (fourth-generation cephalosporin antibiotic)
 - a. Maxipime
5. Cefotaxime (third-generation cephalosporin antibiotic)
 - a. Claforan
6. Cefotetan (second-generation cephalosporin antibiotic)
 - a. Cefotan
7. Cefoxitin (second-generation cephalosporin antibiotic)
 - a. Mefoxin
8. Ceftazidime (third-generation cephalosporin antibiotic)
 - a. Fortaz
 - b. Ceptaz
 - c. Tazicef
 - d. Tazidime
9. Ceftiofur (third-generation cephalosporin antibiotic)
 - a. Naxcel
 - b. Excenel
10. Cephalexin (first-generation cephalosporin antibiotic)
 - a. Keflex and generic forms

11. Cephalothin (first-generation cephalosporin antibiotic)
 - a. Keflin
12. Cephadrine (first-generation cephalosporin antibiotic)
 - a. Velosef
13. Cefpodoxime (third-generation cephalosporin)
 - a. Simplice, administered once daily

Adverse Side Effects

Cephalosporins are usually safe for use in animals. However, allergic reactions can occur. Rare bleeding disorders have been reported with some cephalosporins. Others have caused seizures, although this occurrence is rare. Vomiting and diarrhea have been reported in some individuals.

Technician's Notes

1. Carefully read labels regarding milk withholding time after mastitis treatment and use in animals to be slaughtered.
2. Naxcel is approved for use in lactating dairy animals.

**Tetracyclines**

Tetracyclines can be administered parenterally or orally. The tetracyclines most commonly used in clinical practice are tetracycline, oxytetracycline, doxycycline, and minocycline (Table 12-3).

Pharmacokinetics

When tetracyclines are administered, they are distributed quickly throughout the tissue and sometimes penetrate into the CNS. Decreased metabolism occurs with most tetracyclines; thus, they are eliminated from the body in active form. Elimination occurs most often by glomerular filtration but sometimes may be achieved through biliary excretion routes.

Pharmacodynamics

Tetracyclines work by inhibiting protein synthesis, thereby impeding bacterial cell division. They offer a broad spectrum of activity against gram-positive

Table 12-3 Tetracycline Preparations, Indications, and Antagonistic Drugs

Drug	Indications	Antagonist	Comments
Oxytetracycline	Infections of organs or tissues caused by tetracycline-sensitive strains; anaplasmosis; often ineffective for endocarditis, empyema, meningitis, septic arthritis, and osteomyelitis	Antacids, milk, diuretics, methoxyflurane, penicillins, ferrous sulfate	Long withdrawal times in cattle; shock reaction may occur when given intravenously in horses; diarrhea also common in horses
Chlortetracycline	Same as for oxytetracycline	Antacids, milk, diuretics, methoxyflurane, penicillins	
Tetracycline Doxycycline, minocycline	Same as for oxytetracycline Same as for oxytetracycline, but much better tissue penetration; doxycycline is especially useful for canine ehrlichiosis	Same as for oxytetracycline Minocycline—same as for chlortetracycline; doxycycline—same as for oxytetracycline, barbiturates, and carbamazepine	These drugs are potent broad-spectrum tetracyclines

and gram-negative bacteria. They are bacteriostatic, although at high dose concentrations they may become bactericidal.

Clinical Uses

Tetracyclines are used to treat respiratory tract infection, bacterial enteritis, and urinary tract infection caused by tetracycline-susceptible microorganisms. Tetracyclines also are used to treat rickettsial diseases (e.g., borreliosis [i.e., Lyme disease], Rocky Mountain spotted-tick fever).

Dosage Forms

- Chlortetracycline
 - Anaplasmosis block
 - Aureomycin soluble powder
 - Aureomycin tablets
 - Aureomycin soluble calf oblets
 - Calf scour bolus
 - Fermycin
- Doxycycline
 - Vibramycin
 - Monodox
 - Doxy caps
 - Many other brands available

- Minocycline
 - Minocin
- Oxytetracycline
 - Biomycin
 - Oxybiotic
 - Oxy-Tet
 - Terramycin
 - Terramycin scour tablets
 - Terramycin soluble powder
 - Long-acting formulations include the following:
 - Liquamycin-LA 200
 - Biomycin 200
- Tetracycline
 - Panmycin
 - Duramycin powder

Adverse Side Effects

Tetracyclines may cause renal problems when administered at high doses, can affect formation of bones and teeth (cause staining of teeth) in young animals, should never be given to horses intravenously, and may cause drug fever in cats; some hepatotoxicity may occur at increased doses, especially in susceptible individuals.

Hidden page

high concentrations in renal cortical tissue, adequate renal function is necessary for their use. Ettinger (2001) recommends monitoring nephrotoxicity by obtaining a pretreatment serum creatinine level and comparing that with values from samples taken during treatment. Any significant change in the serum creatinine level could indicate the need for termination of treatment. Another area of concentration is the inner ear, in which concentration levels do not diminish until treatment has been completed. The ototoxicity that occurs may be vestibular or auditory.

Pharmacodynamics

Aminoglycosides work similarly to tetracyclines by inhibiting protein synthesis and impeding bacterial cell division. Aminoglycosides have a broad spectrum of activity but should be used only in specific cases of gram-negative infection. Streptococcal bacteria species do not show much sensitivity to aminoglycosides (Ettinger, 2001). They are most often effective against anaerobic bacteria.

Clinical Uses

Aminoglycosides are used to treat patients with pneumonia, endometritis, urinary tract infection, bacterial enteritis, conjunctivitis, and skin and soft tissue infections caused by aminoglycoside-susceptible microorganisms.

Dosage Forms

1. Amikacin
 - a. Amiglyde-V
2. Gentamicin
 - a. Gentocin
3. Kanamycin
 - a. Kantrim
4. Neomycin
 - a. Biosol

Adverse Side Effects

Because intestinal bacterial flora may be disrupted during therapy with this drug, diarrhea may occur. Other side effects include neuromuscular blockage (when used with anesthetic agents), nephrotoxicity, and ototoxicity.

Technician's Notes

1. Because aminoglycosides enhance the effects of neuromuscular blocking drugs, it is best to refrain from using these drugs at the same time. Aminoglycoside blood levels can be determined before neuromuscular blocking drugs are used, to prevent muscular collapse.
2. Aminoglycosides are contraindicated in animals with renal insufficiency.
3. Aminoglycosides are not approved for use in food-producing animals.
4. Do not mix vials or syringes with other antibiotics.
5. Aminoglycosides may cause problems such as ototoxicity or nephrotoxicity in animals, especially if the patient is on furosemide therapy when they are administered.



Fluoroquinolones

Fluoroquinolones are relatively new to veterinary medicine and have been approved for use in dogs, cats, turkeys, chickens, and cattle. Their use in horses continues to be controversial and is not approved (Plumb, 2005). Fluoroquinolones approved for use in veterinary medicine include enrofloxacin, difloxacin hydrochloride, orbifloxacin, sarafloxacin, and marbofloxacin. Fluoroquinolones exhibit broad-spectrum activity against gram-positive and gram-negative bacteria.

Pharmacokinetics

Fluoroquinolones are available for oral and parenteral administration. After administration, they are readily absorbed into tissue and body fluids. Metabolism occurs in the liver, and elimination occurs via the kidneys into urine or through bile into the intestines.

Pharmacodynamics

The broad spectrum of activity offered by the fluoroquinolones is bactericidal against many different pathogens. The effect of fluoroquinolones is achieved through inhibition of or interference with the bacterial enzyme DNA-gyrase.

Hidden page

body and can reach therapeutic levels in the cerebrospinal fluid (Plumb, 2005).

Clinical Uses

Florfenicol is approved for the treatment of patients with bovine respiratory disease associated with *Pasteurella haemolytica*, *P. multocida*, and *Haemophilus somnus*.

Dosage Form

Nuflor injectable solution

Adverse Side Effects

Adverse side effects include transient inappetence, decreased water consumption, and diarrhea.

Technician's Notes

1. Florfenicol is not approved for use in female dairy cattle 20 months of age or older and should not be used in veal calves, calves younger than 1 month old, or calves receiving an all-milk diet.
2. Florfenicol is for intramuscular injection only. Injections should be administered into the neck with no more than 10 ml given per site.

Macrolides and Lincosamides

Macrolides and lincosamides are primarily effective against gram-positive organisms. The macrolides most commonly used in veterinary medicine include tilmicosin phosphate, erythromycin, and tylosin. The lincosamides include lincomycin, clindamycin, and pirlimycin. Clindamycin is also effective in treating anaerobic infection and is used to treat patients with deep pyodermas, wounds, abscesses, and osteomyelitis.

MACROLIDES

Clinical Uses

Macrolides are used to treat patients with upper respiratory tract infection, mastitis, metritis, and foot rot caused by microorganisms susceptible to macrolides.

Dosage Forms

1. Erythro
2. Gallimycin

3. Illotycin (many brands available)
4. Micotil
5. Tylan
6. Tylocine
7. Tylosin
8. Zithromax (azithromycin)
9. Draxxin (tulathromycin)

Adverse Side Effects

These include diarrhea, vomiting, and anorexia in small animals after oral administration of erythromycin and tylosin. Severe diarrhea may result from oral administration of erythromycin and tylosin to ruminants and horses. Intramuscular injection of erythromycin and tylosin is very painful. Adverse side effects are uncommon in cattle after subcutaneous injection of tilmicosin phosphate (Micotil).

Technician's Notes

1. Micotil is not approved for use in lactating dairy animals.
2. Carefully read labels about use in animals to be slaughtered.
3. Micotil is potentially lethal to humans, swine, and horses.

LINCOSAMIDES

Clinical Uses

Lincosamides are used to treat upper respiratory tract infection and skin infection in dogs, cats, and swine, as well as mastitis in cattle. Lincomycin may be found in combination with other agents for use in chickens. Clindamycin is approved for use in dogs and cats to treat deep pyoderma, wound infection, abscess, dental infection, and osteomyelitis.

Dosage Forms

1. Clindamycin
 - a. Antirobe (capsules, oral liquid)
2. Lincomycin
 - a. Lincocin (capsules, oral liquid)
 - b. Lincocin Sterile Solution (swine)
 - c. Lincomix
 - d. Pirsue Aqueous Gel

Adverse Side Effects

These include occasional vomiting and diarrhea.

Technician's Notes

1. Lincomycin is not for use in avians used for egg laying, breeders, or turkeys.
2. Carefully read label about use in animals for slaughter.
3. Lincosamides should not be administered to rabbits, hamsters, guinea pigs, or horses.

Vancomycin

Vancomycin is not commonly used in veterinary medicine. It is very effective against gram-positive pathogens, particularly coccus organisms. It is administered intravenously or orally. Vancomycin is administered orally (not absorbed) only to control *Clostridium difficile*.

Clinical Uses

Vancomycin is used to treat resistant staphylococcal and streptococcal infections.

Dosage Forms

1. Vancocin Powder
2. Vancocin Injection

Adverse Side Effects

These include possible thrombophlebitis and febrile reactions (Beech et al, 1987). Ototoxicity, nephrotoxicity, and hypersensitivity are other possible side effects.

Spectinomycin

Spectinomycin is an aminocyclitol antibiotic that is primarily effective against gram-negative bacteria, some mycoplasma, and some gram-positive bacteria. Its action inhibits protein synthesis in susceptible bacteria. It is not generally effective against anaerobic bacteria.

Clinical Uses

These include control of air sacculitis and chronic respiratory disease in turkey poults and chicks caused by organisms sensitive to spectinomycin. In

baby pigs, it is used to control and treat infectious diarrhea caused by *E. coli*. In cattle, it is indicated for the treatment of bovine respiratory disease associated with *P. haemolytica*, *P. multocida*, and *H. somnus*.

Dosage Forms

1. Spectam Injectable (turkey poults and chicks)
2. Spectam Scour-Halt (swine)
3. Adspec Sterile Solution (cattle)

Adverse Side Effects

These are uncommon. In cattle, mild swelling may be noted at the injection site.

Technician's Notes

1. Do not use in female dairy cattle 20 months of age or older.
2. Do not use in veal calves.
3. Carefully read labels about use in animals for slaughter.
4. Approved only for use in swine younger than 4 weeks of age or weighing less than 15 lb.

Polymyxin B and Bacitracin

Polymyxin B and bacitracin are restricted to topical skin and ophthalmic applications. These drugs often are combined with other drugs (e.g., neomycin) in topical skin and ophthalmic ointments.

Clinical Uses

These include treatment of superficial bacterial infections of the eye, conjunctiva, and skin.

Dosage Forms

1. Mycitracin Sterile Ointment
2. Forte Topical
3. Neobacimyx Ophthalmic Solution

Adverse Side Effects

Adverse side effects of polymyxin B include nephrotoxicity and neurotoxicity if administered parenterally (Beech et al, 1987). Bacitracin is limited to topical application because it causes nephrotoxicity.

Technician's Notes

Care should be taken to avoid contaminating the applicator tip when ophthalmic preparations are administered.

Sulfonamides

Sulfonamides, or sulfa drugs, are **antibacterials** that offer a relatively broad spectrum of activity against gram-positive and gram-negative bacteria. The most common sulfonamides used in veterinary medicine are sulfadiazine, sulfisoxazole, and sulfadimethoxine. Trimethoprim, pyrimethamine, and ormetoprim are commonly combined with sulfonamides to enhance their effect.

Clinical Uses

Sulfonamides are used to treat patients with acute urinary tract infection, respiratory tract infection, wound infection, coccidiosis, and foot rot.

Dosage Forms

1. Tribissen 48% Injection
2. Primor Tablets
3. Albon Boluses
4. Albon Oral Suspension 5%
5. Sustain III Cattle Bolus

Adverse Side Effects

These include urticaria (hives), vomiting, diarrhea, anorexia, fever, and crystal formation within the kidneys, which can result in hematuria, proteinuria, and renal tubular damage. Keratoconjunctivitis sicca has been reported in dogs. The use of these drugs has been limited in food-producing animals because of residues of the drug in meat, milk, and eggs.

Technician's Notes

Maintaining normal hydration can decrease the risk of crystal formation in the kidneys.

Nitrofurans

Nitrofurans consist of a group of antibacterials with broad-spectrum activity. The most common nitrofurans used in clinical practice are nitrofurazone, nitrofurantoin, and furazolidone.

Clinical Uses

These include treatment of superficial bacterial infections of wounds, necrotic enteritis in swine, coccidiosis in chickens, and bacterial enteritis in pigs younger than 4 weeks old. Nitrofurazone also may be used to treat pinkeye in cattle, sheep, and goats, as well as eye and ear infections in dogs and cats.

Dosage Forms

1. NFZ Puffer
2. Nitrofurazone Soluble Dressing
3. Nitrofurazone 0.2% Solution

Adverse Side Effects

Adverse side effects are uncommon.

Technician's Notes

1. Except for approved topical use, nitrofurans have been prohibited in food-producing animals.
2. Nitrofurans should not be used in veal calves.

Rifampin

Rifampin is a large complex antimicrobial that is derived from rifamycin B and produced by *Nocardia mediterranea*; it usually is used in combination with other antibiotics to avoid the development of resistant strains of bacteria.

Clinical Uses

This drug is used primarily to treat young horses with *Rhodococcus equi* infection.

Dosage Forms

1. Rifadin Powder for injection
2. Rifampin Capsules

Adverse Side Effects

May cause red-orange-colored urine.



Antifungal Drugs

Fungal infections (mycoses) are classified into two types: topical (superficial), which affect the skin and mucous membranes, and systemic, which affect

such areas as the blood, lungs, or CNS. A topical fungal infection may be diagnosed by direct microscopic examination for the presence of delicate hyphae in skin cells or the presence of spores on the surface of an infected hair. Dermatophyte test medium is available for topical fungal identification at in-hospital laboratories (Figure 12-4). Systemic mycosis usually is diagnosed in large laboratories through serologic testing. Patients with fungal infection are treated with oral, topical, or parenteral drugs that are suitable for these infections. The antifungal, or antimycotic, drugs are divided into four classes: (1) polyene, (2) imidazole, (3) antimetabolic, and (4) superficial agents.

Polyene Antifungal Agents

AMPHOTERICIN B

Amphotericin B is an antifungal drug that may be fungistatic or fungicidal.

Clinical Uses

These drugs are used to treat dogs and cats with systemic mycotic infection.

Dosage Form

Fungizone (human label)



FIGURE 12-4

Dermatophyte test medium may be used to culture topical fungal infections. This medium contains a phenol red indicator that turns red as a dermatophyte grows and produces alkaline metabolic products.

Adverse Side Effects

Numerous toxicities such as anorexia, vomiting, seizures, anemia, and cardiac arrest have been reported with the use of amphotericin B. Nephrotoxicity also occurs in most patients that are given this drug (Beech et al, 1987).

Technician's Notes

1. Amphotericin B is administered intravenously through dilution in 5% dextrose.
2. Renal function should be monitored closely during treatment.

NYSTATIN

Nystatin may be fungistatic or fungicidal. It often is combined with other drugs such as neomycin, thio-strepton, and triamcinolone acetonide.

Clinical Uses

Nystatin is used to treat dogs and cats with candidiasis infection of the skin, mucous membranes, and intestinal tract.

Dosage Forms

1. Animax Ointment
2. Dermalone Ointment
3. Panolog Cream

Adverse Side Effects

Adverse side effects are uncommon.

Imidazole Antifungal Agents

KETOCONAZOLE AND MICONAZOLE

Ketoconazole and miconazole are two of the most commonly used drugs in this class. Ketoconazole is available in oral and topical preparations, and miconazole is available in parenteral and topical preparations.

Clinical Uses

These include the treatment of some systemic mycotic infections and some dermatophytoses, as well as *Candida* infection in dogs and cats.

Dosage Forms

1. Nizoral Tablets (human label)—ketoconazole
2. Nizoral Cream (human label)—ketoconazole

3. Monistat (human label)—miconazole
4. Conofite Lotion or Spray—miconazole

Adverse Side Effects

Adverse side effects are not as severe as those of amphotericin B and are uncommon. Ketoconazole may produce hepatotoxicity. Miconazole may produce tachycardia, arrhythmia, fever, nausea, and thrombophlebitis after intravenous administration.

Technician's Notes

Ketoconazole may cause infertility in male dogs.

ITRACONAZOLE

Itraconazole is the most recently available imidazole for use in veterinary medicine.

Clinical Uses

Itraconazole is used to treat dogs and cats with systemic mycotic infection.

Dosage Form

Sporanox Capsules (human label)

Adverse Side Effects

These include anorexia associated with hepatotoxicity, ulcerative dermatitis resulting from vasculitis, and possible cardiotoxicity. Severe adverse reactions are uncommon.

Antimetabolic Antifungal Agents

FLUCYTOSINE

Flucytosine is a fungistatic oral antifungal agent. This drug may be used in combination with other antifungal agents for the treatment of some yeast infections.

Clinical Uses

Flucytosine is used to treat cryptococcal infection, but it inhibits the growth of other fungi as well.

Dosage Form

Ancobon (human label)

Adverse Side Effects

These include bone marrow depression, anemia, leukopenia, and thrombocytopenia. Severe reactions may occur in patients with renal insufficiency.

Superficial Antifungal Agents

GRISEOFULVIN

Griseofulvin is used primarily in dogs, cats, and horses as an antifungal. It is administered orally in the form of a tablet or powder.

Clinical Uses

Griseofulvin is used to treat dermatophytosis.

Dosage Forms

1. Fulvicin-U/F Tablets
2. Fulvicin-U/F Powder

Adverse Side Effects

Adverse side effects are uncommon.

Technician's Notes

1. Griseofulvin should not be administered to pregnant or breeding animals.
2. Absorption of griseofulvin is enhanced by administration with a fatty meal.

Other Antifungal Agents

Several agents that have other uses are also effective as topical antifungal drugs. A topical preparation often is used in conjunction with systemic antifungal drugs. Commonly used topical preparations include chlorhexidine, iodine, tolnaftate, benzoic acid, salicylic acid, and thiabendazole.



Antiviral Drugs

Antiviral drugs are used to treat patients with viral infection. Their use in veterinary medicine is still limited, but research is increasing the use of these drugs for treatment of animals with viral infection. Because no antiviral agents are veterinary-approved, human-approved antiviral agents are used. Antivirals may be used for the treatment

of optic viral infection and nonneoplastic feline leukemia virus (FeLV)-associated disease. Antiviral drugs are available for topical and systemic use. Other antiviral drugs that may be beneficial in veterinary medicine include amantadine, ganciclovir, idoxuridine, and azidothymidine.

Acyclovir

Clinical Uses

In veterinary medicine, acyclovir may be used in birds for the treatment of Pacheco's disease and in cats for confirmed feline herpes virus infection of the conjunctiva or cornea, when other treatments have failed (Plumb, 2005).

Dosage Forms

1. Zovirax tablets and capsules (human label)
2. Zovirax Suspension (human label)
3. Zovirax Injectable (human label)
4. Valacyclovir (human label)

Adverse Side Effects

Adverse side effects include leukopenia and anemia in treated cats. In birds, tissue necrosis can occur at the injection site if this agent is used parenterally for longer than 72 hours (Oglesbee and Bishop, 2000).

Interferon Alfa-2A, Human Recombinant

Clinical Uses

In veterinary medicine, interferon alfa-2A is administered orally to treat cats with nonneoplastic FeLV disease.

Dosage Form

Roferon-A

Adverse Side Effects

No adverse side effects have been noted (Plumb, 2005).



Disinfectants/Antiseptics

The use of disinfectants in a veterinary hospital ranges from table sprays to premise cleaners (Figure 12-5). A disinfectant destroys disease-producing microorganisms or inactivates viruses.



FIGURE 12-5

The concentrations of disinfectants vary from dilutions that are used for disinfecting kennels, floors, and so forth, to dilutions that are used as table sprays.

It is used primarily on inanimate objects. Disinfection time is the time required for a particular agent to produce its maximum effect. This time varies with different agents but can be affected by a range of factors such as the type of material that is being disinfected, the amount of soil and microbial contamination involved, and the concentration of the disinfectant and its germicidal potency. Antiseptics are used on live tissue to destroy microorganisms. The terms *disinfectant* and *antiseptic* commonly are used interchangeably, although disinfectants should be used on inanimate surfaces (e.g., countertops, feed bowls), whereas antiseptics are used on living tissue (e.g., skin). Table 12-5 lists common products and their uses.

Alcohols

Alcohols such as ethyl and isopropyl work through protein coagulation and dissociation of membrane lipids. They are bactericidal, tuberculocidal, and active against some viruses, but they are not **sporicidal** or active against fungi. Alcohols do not penetrate organic material.

Table 12-5 Disinfectant Preparations and Their Activity

Disinfectant Group	Proprietary Products	Recommendations	Bactericidal	General Virucide	Fungicidal	Sporicidal at Room Temperature
Quaternary ammonium compounds	Q-Cide Roccal-D Plus D-128	Instruments, dairy equipment, rubber goods	M	M	M	N
Phenolics	Pantek Cleanser Lysol I.C. Disinfectant Spray Beaucoup	Laundry rinse, floors, walls, equipment	M	M	H	N
Halogens	<i>Chlorines:</i> Clorox Purex	Floors, spot disinfection	M	H	H	S
	<i>Iodophors:</i> Betadine Povidine Iosan	Presurgical skin preparation, thermometers, dairy operation	H	H	M	S
Glutaraldehyde	Cidex	Instruments	H	H	H	M
Chlorhexidine	Nolvasan Virosan	Instruments, surgical scrub, dairy operation	M	M	M	N
Alcohols	Isopropyl alcohol 70%	Instruments, thermometers, skin preparation	H	N	S	N

M, Moderate activity; N, no activity; H, high activity; S, slight activity.

Clinical Uses

These include disinfection of thermometers and instruments for skin preparation and for spot disinfection.

Adverse Side Effects

Alcohols can corrode metal and may be drying to the skin.

Technician's Notes

- Iodine (1% to 2%) can be added to alcohol for thermometer disinfection to increase its activity against spores and viruses.
- Alcohols should not be applied to open wounds.
- Never use alcohol during (i.e., as a step in) the surgical scrubbing procedure if electrocautery will be employed during the surgical procedure.

Ethylene Oxide

Ethylene oxide works via substitution of cell alkyl groups for labile hydrogen atoms. It sterilizes against bacteria, fungi, and viruses. This gas, which should be handled carefully when used by veterinary personnel, may irritate the lungs and cause chemical burns if skin contact occurs. The gas is flammable and is considered to be a human carcinogen. When inanimate objects are sterilized, this gas must be used with proper ventilation and according to proper Occupational Safety and Health Administration (OSHA) standards.

Clinical Uses

Ethylene oxide is used to sterilize inanimate objects such as blankets, pillows, mattresses, instruments with lenses, rubber goods, thermolabile plastics, books, and papers.

Adverse Side Effects

Adverse side effects are uncommon if ethylene oxide is used according to proper OSHA standards and with good ventilation.

Technician's Notes

Special equipment is required when ethylene oxide is used as a sterilization gas.

1. After rubber boots are sterilized with this gas, it is best to let them "air" for several hours before donning them, to prevent chemical burns to the skin of the feet.
2. Proper ventilation (refer to OSHA standards) must be employed when this gas is used.

Formaldehyde

The mode of action for formaldehyde is the same as for ethylene oxide. It is noncorrosive and is effective against bacteria, fungi, spores, and viruses. It is considered to be carcinogenic to humans and must be used only in diluted amounts.

Clinical Uses

Formaldehyde is used as a disinfecting gas or solution. The gas can be used to **disinfect** large areas, such as a cabinet or incubator. The solution is appropriate for instrument disinfection. Delicate instruments may be vapor disinfected.

Technician's Notes

1. For adequate disinfection, formaldehyde requires long contact time.
2. Organic material inactivates its effectiveness.

Adverse Side Effects

These include toxicity to skin and mucous membranes because of its strong odor.

Chlorines and Iodines

Chlorines and iodines are halogens that inactivate pathogens by oxidizing free sulfhydryl groups on bacterial enzymes. Chlorines are bactericidal, exhibit high levels of activity against viruses, and are

fungicidal and tuberculocidal unless highly diluted. Iodines and **iodophors** are bactericidal, exhibit high levels of activity against viruses, are fungicidal and tuberculocidal, and are effective against bacterial spores.

Clinical Uses

Chlorines are recommended for floors, plumbing fixtures, spot disinfection, and fabrics not harmed by bleaching. Iodine tincture is used for skin preparations and thermometers. Iodophors are used to disinfect thermometers, utensils, rubber goods, and dishes, and for presurgical skin preparation.

Dosage Forms

1. Sodium hypochlorite
 - a. Clorox bleach
2. Iodine tincture (7%)
3. Betadine surgical scrub
4. Povidone solution

Adverse Side Effects

The strong vapor of chlorines may irritate the eyes and mucous membranes. Skin irritation may result from failure to rinse a chlorine-disinfected surface. Chlorine bleaches colored fabrics and is corrosive to most metals. Tinctures of iodine contain alcohol and are drying to the skin. They stain and may corrode metal. Iodophors may corrode metal; iodine solutions stain and may corrode metal, and high concentrations (3.5%) may irritate living tissue.

Technician's Notes

1. These compounds are inactivated by organic material.
2. Always check labels for dilution requirements (more is *not* better).
3. Iodophors are less staining and irritating than other iodine compounds.

Phenolics: Saponated Cresol, Semisynthetic Phenols

The mode of action of phenolics is protein coagulation. They destroy selective permeability of cell membranes; leakage of cell constituents results.

They are effective against bacteria, fungi, and some viruses, but they are not sporicidal and are only weakly effective against nonenveloped viruses (e.g., parvovirus). Cresol must be used in soft water and is slow-acting. Organic matter, soap, or hard water (except cresol) does not inactivate phenolics. They have high detergency and a residual effect if allowed to dry on surfaces.

Clinical Uses

These include use as a general disinfectant for laundry, floors, walls, and equipment.

Dosage Forms

1. Panteck Cleanser
2. Beaucoup
3. Lysol I.C. Disinfectant Spray

Adverse Side Effects

Adverse side effects are uncommon, but repeated and prolonged skin exposure may result in accumulation in tissue and eventual toxic effects such as neurotoxicity or teratogenicity.

Technician's Notes

Some phenolics have objectionable odors.

Quaternary Ammonium Compounds: Cationic Detergents

Cationic **detergents** concentrate at the cell membrane and are thought to act by dissolving lipids in cell walls and membranes. They are more active against gram-positive than against gram-negative organisms. They are bacteriostatic at high dilutions, but spores, viruses, mycobacteria, and *Pseudomonas aeruginosa* are relatively resistant. Organic debris, hard water, and anionic soaps and detergents inactivate quaternary ammonium compounds.

Clinical Uses

These include cleaning of instruments, utensils, inanimate objects, and rubber goods. They may be used for instrument soaks except for instruments with cemented lenses.

Dosage Forms

1. Roccal-D Plus
2. Q-Cide
3. D-128

Adverse Side Effects

Adverse side effects are uncommon.

Technician's Notes

Read labels carefully because some quaternary ammonium compounds do not effectively disinfect against some common viruses (e.g., parvovirus).

Biguanide Compounds

Chlorhexidine is the most common disinfectant in this group. In high dilutions, it is bactericidal, fungicidal, and active against enveloped viruses (e.g., feline infectious peritonitis virus, feline leukemia virus). Other viruses, spores, and mycobacteria are relatively resistant.

Clinical Uses

These include disinfecting surgical instruments, anesthetic equipment, and kennels. It is also available as a surgical scrub and a teat dip.

Dosage Forms

1. Nolvasan cap tabs
2. Nolvadent oral solution
3. Nolvalube (lubricating jelly)
4. Nolvasan solution
5. Nolvasan surgical scrub
6. Virosan solution

Adverse Side Effects

Adverse side effects are uncommon.

Other Disinfectants

SOAPS

Soaps, or anionic detergents, have only slight bactericidal activity but are effective in the mechanical removal of organisms. They are not sporicidal or tuberculocidal and have limited virucidal activity. They often contain germicides, such as triclosan, that decrease the number of resident flora after

Hidden page



REVIEW QUESTIONS

- Different types of bacteria can be distinguished with the use of a _____ stain.
- Gram-positive bacteria will stain what color?

- Gram-negative bacteria will stain what color?

- _____ is approved for use in lactating dairy animals.
- _____ can cause staining of teeth in young animals.
- _____ should never be given intravenously to horses.
- Some aminoglycosides may be _____-toxic and/or _____-toxic.
- Griseofulvin is used to treat _____.
- A drug's _____ of activity is the range of bacteria affected by its action.
- Aerobes are bacteria that require oxygen to live.
 - True
 - False
- A fungicidal agent inhibits the growth of fungi.
 - True
 - False
- A bacteriostatic agent inhibits the growth of bacteria.
 - True
 - False
- Dermatophytosis is a(n) _____ skin infection.
 - fungal
 - bacterial
 - parasitic
 - immune-mediated
- Penicillin-G benzathine is a long-acting antibiotic that is approved for use in dairy animals.
 - True
 - False
- All the following drugs are classified as penicillins, except _____.
 - cephalexin
 - amoxicillin
 - ampicillin
 - cloxacillin
- Naxcel is not approved for use in lactating dairy animals.
 - True
 - False
- Panmycin is classified as a(n) _____.
 - penicillin
 - cephalosporin
 - aminoglycoside
 - tetracycline
- Veterinarians commonly dispense aminoglycosides to patients with renal insufficiency.
 - True
 - False
- Entrofloxacin is a _____.
 - penicillin
 - cephalosporin
 - fluoroquinolone
 - tetracycline
- Amphotericin B may be used in the treatment of mycotic fungal infection.
 - True
 - False

Hidden page

Hidden page

rumen provides a warm, liquid environment in which to live. Commensalism is a type of symbiotic relationship in which one symbiont benefits, but the other symbiont is not harmed. An example of commensalism is mistletoe growing in the top of a tree. Lastly, parasitism occurs when one species lives at the expense of another. An example of parasitism is *Trichouris vulpis* that live in the cecum of the canine.

Sometimes, an animal may harbor a parasite on or within its body that is potentially pathogenic, but the animal does not exhibit any outward signs (i.e., clinical disease) of parasitism. This is known as **parasitiasis**. If, however, the animal harbors a parasite on or within its body, and injury occurs to the animal because of the parasite, this is known as **parasitosis**. Parasites living on the outside of an animal's body are known as **ectoparasites** (e.g., fleas, ticks), and parasites living on the inside of an animal's body are known as **endoparasites** (e.g., canine heartworms). An animal with ectoparasites is said to be infested, and an animal with endoparasites is said to be infected. Sometimes, a parasite may wander from its normal location in the host's body to another location where it does not normally live. These parasites are said to be aberrant (erratic). Although most veterinary personnel use the lay term given to parasites when speaking with a client, it is important for veterinary technicians to know the genus and species name of the most common parasites as well. The Linnaean classification scheme is fundamental in keeping parasites organized (i.e., kingdom, phylum, class, order, family, genus, and species).

Each parasite has its own individual life cycle, which may consist of several stages. Every parasite has at least a definitive host and, depending on the species, may have one or more intermediate hosts. The host that contains the adult (sexually mature) stage of the parasite is known as the definitive host, and the host that contains the immature (not sexually mature) stage of the parasite is known as the intermediate host. Knowing the life cycle of parasites helps veterinarians determine which drugs to use and how many doses will be needed to eradicate the parasite from the host animal's body.

Some parasites have zoonotic potential. This means they may be transmissible from animals to humans.

Veterinary technicians should be familiar with which parasites have this ability so they can properly educate clients. Examples of parasites with zoonotic potential include *Toxoplasma gondii*, *Trichinella spiralis*, *Ancylostoma caninum*, and *Toxocara canis* (Hendrix, 2006).

The Companion Animal Parasite Council recommends fecal centrifugation techniques to accurately diagnose endoparasitism. Additionally, the amount of feces collected for evaluation is important and should consist of at least 1 gram. The specific gravity of flotation solution is equally important, in that ideally it should be 1.18 to 1.20 (Companion Animal Parasite Council@capevet.org/default.asp?p=Home).

Technician's Notes

Educating clients about how to collect a freshly voided fecal sample from a pet will result in more accurate fecal evaluations. (Tell them to bring a sample in a zip-loc bag to each appointment their pet has.)

Ectoparasites represent an ongoing problem faced by companion animal and livestock owners. Numerous products are manufactured for the removal of fleas and ticks from an animal's body. Since so many products are available, veterinary technicians play an important role in educating clients about the effectiveness of each product. Client education is important in the area of ectoparasites because misuse of over-the-counter insecticides can be fatal. Clients should be taught to ask veterinary personnel about the correct use of shampoos, dips, sprays, powders, and topical parasiticides (e.g., fipronil, imidacloprid) before a purchase is made.

Parasitology is a fascinating subject. However, for most clients, it is not fascinating at all because they just want their pet to be free of worms and bugs. It is up to veterinary personnel to have knowledge about available products and to remember that—as technology evolves—lifelong learning must be pursued so that professionals can remain current with how each drug or parasiticide works. Veterinary personnel have a double responsibility because it is up to us to protect both pets and their owners from those parasites with

zoonotic potential, and to educate clients accordingly. Veterinary medicine truly has a twofold purpose: the medical treatment of animals and protection of the public from health risks associated with zoonotic diseases and parasites. In some ways, veterinary medicine is more important than human medicine when it is considered from this standpoint, because it represents the first defense in the protection of human health. Reading package inserts helps veterinary personnel to understand how a particular drug works. Tables 13-1 to 13-9 list products and their uses for various species.

ENDOPARASITES

Endoparasites found in the gastrointestinal (GI) tracts of animals benefit not only from the food-stuffs the animal ingests, but from body fluids (e.g., blood) as well. Horses with increased numbers of endoparasites in the GI tract may develop colic. Puppies and kittens with increased numbers of intestinal parasites may develop fatal anemia if not treated early. Adult heartworms can cause disruption to the normal movement of blood within the heart chambers, resulting in clinical signs similar to congestive heart failure. Without treatment, a dog with active heartworm infection will die.

In the following section, some of the most common **anthelmintics** used in veterinary practice today are discussed. As a veterinary technician, you may come into contact with products not mentioned in this section. The charts in this section list various products, their trade names, and their effectiveness. Since anthelmintics are so numerous, many veterinarians keep only a few products to meet their needs and to limit inventory. Some products are available under many different names. Experience will provide familiarity with various available brands.

Antinematoda

Benzimidazoles

Benzimidazoles interfere with the worm's energy level on a cellular basis. They bind to beta tubulin and prevent its entry into microtubules that are

needed for energy metabolism. Without energy, the worm dies.

Dosage Forms

This class includes the following products:

1. Thiabendazole (Equizole, TBZ, Omnizole)
2. Oxibendazole (Anthelcide EQ)
3. Mebendazole (Telmin, Telmintic)
4. Fenbendazole (Panacur, Safeguard)
5. Cambendazole (Camvet)
6. Oxfendazole (Benzelmin, Synanthic)
7. Albendazole (Valbazen)

Clinical Uses

Benzimidazoles are used in the following species:

1. **Horses.** Effective against strongyles, pinworms, and ascarids
2. **Cattle.** Ascarids, several species of strongyles and other stomach worms; albendazole is also effective against adult liver flukes and tapeworms; fenbendazole is also effective against lungworms
3. **Sheep and goats.** Ascarids, several species of strongyles and other stomach worms; Panacur is also effective against lungworms
4. **Dogs.** Hookworms, roundworms, and whipworms; some are effective against *Taenia pisiformis* but not *D. caninum*
5. **Swine.** *Strongyloides* and lungworms
6. Many of the benzimidazoles are used as anthelmintics for exotics such as snakes and birds.

Adverse Side Effects

These are uncommon but include vomiting and diarrhea. Mebendazole has clinically produced hepatotoxicity in dogs.

Technician's Notes

1. Read labels carefully regarding use in lactating dairy animals and animals to be slaughtered.
2. None of these products is approved for use in cats.

Text continued on p. 261

Table 13-1 Parasiticides Used for Treatment and Control of Internal Parasites in Dogs and Cats*

Drug	PARASITE									
	<i>Toxocara, Toxascaris</i>	<i>Ancylostoma, Uncinaria</i>	<i>Strongyloides</i>	<i>Trichuris</i>	<i>Dirofilaria Adults</i>	<i>Dirofilaria Microfilariae</i>	<i>Toenia</i>	<i>Dipylidium</i>	<i>Giardia</i>	<i>Coccidia</i>
Albendazole	+	+	-	+	-	-	+	-	+	-
Amprolium	-	-	-	-	-	-	-	-	-	+
Butamisol hydrochloride	-	+	-	+	-	-	-	-	-	-
Dichlorophen	-	-	-	-	-	-	+	+	-	-
Dichlorophen/ tolulene	+	+	-	-	-	-	+	+	-	-
Dichlorvos	+	+	-	+	-	-	-	-	-	-
Diethylcarbamazine	+	-	-	-	-	+	-	-	-	-
Epsiprantel	-	-	-	-	-	-	+	+	-	-
Febantel	+	+	-	-	-	-	+	-	-	-
Febantel/praziquantel	+	+	-	+	-	-	+	+	-	-
Fenbendazole	+	+	-	+	-	-	+	-	-	-
Furazolidone	-	-	-	-	-	-	-	-	+	-
Ivermectin	+	+	-	+	-	+	-	-	-	-
Mebendazole	+	+	-	+	-	-	+	-	-	-
Melarsomine dihydrochloride	-	-	-	-	+	-	-	-	-	-
Metronidazole	-	-	-	-	-	-	-	-	+	-
Milbemycin oxime	+	+	-	+	-	+	-	-	-	-
N-Butyl chloride	+	+	-	-	-	-	-	-	-	-
Nitroscanate	+	+	-	+	-	-	+	+	-	-
Oxibendazole/diethylcarbamazine	+	+	-	+	-	+	-	-	-	-
Piperazine salts	+	-	-	-	-	-	-	-	-	-
Praziquantel	-	-	-	-	-	-	+	+	-	-
Praziquantel/pyrantel pamoate	+	+	-	-	-	-	+	+	-	-
Praziquantel/pyrantel pamoate/febantel	+	+	-	+	-	-	+	+	-	-
Pyrantel pamoate	+	+	-	-	-	-	-	-	-	-
Quinacrine hydrochloride	-	-	-	-	-	-	-	-	+	-
Selamectin	+	+	-	-	-	+	-	-	-	-
Sulfadiazine/trimethoprim	-	-	-	-	-	-	-	-	-	+
Sulfadimethoxime	-	-	-	-	-	-	-	-	-	+
Thiabendazole	-	-	+	-	-	-	-	-	-	-

+, Indicated for use; -, not indicated for use.

* Fenamoxim, an antibiotic, is being used to manage *Cryptosporidium* infections and resistant *Giardia* infections in dogs and cats.

From McCurbin DM, Bassett JM: Clinical textbook for veterinary technicians, ed 5, Philadelphia 2002, WB Saunders.

Table 13-2 Parasiticides Used to Treat Internal Parasites in Horses

Drug	PARASITE						
	<i>Gasterophilus</i>	<i>Ascarids</i>	<i>Strongylus vulgaris</i>	<i>Strongylus edentatus</i>	Small Strongyles	Pinworms	<i>Strongyloides</i>
Cambendazole	–	+	+	+	+	+	+
Dichlorvos	+	+	+	+	+	+	–
Febantel	–	+	+	+	+	+	+
Fenbendazole	–	+	+	+	+	+	+
Ivermectin	+	+	+	+	+	+	+
Moxidectin	+	+	+	+	+	+	–
Oxibendazole	–	+	+	+	+	+	+
Oxitelndazole	–	+	+	+	+	+	+
Phenothiazine	–	–	+	+	+	–	–
Piperazine salts	–	+	–	–	+	+	–
Pyrantel salts	–	+	+	–	+	–	–
Thiabendazole	–	–	+	+	+	+	+
Thiabendazole/piperazine	–	+	+	+	+	+	+
Thiabendazole/trichlorfon	+	+	+	+	+	+	+
Trichlorfon	+	+	–	–	–	+	–
Trichlorfon/phenothiazine/ piperazine	+	+	+	–	+	+	–

+, Indicated for use; –, not indicated for use.

From McCumins DM, Bassett JM: Clinical textbook for veterinary technicians, ed 5, Philadelphia, 2002, WB Saunders.

Table 13-3 Parasiticides Used to Treat Internal Parasites in Cattle, Sheep, and Goats

Drug	PARASITE													
	<i>Haemonchus</i>	<i>Ostertagia</i>	<i>Trichostrongylus</i>	<i>Cooperia</i>	<i>Nematodirus</i>	<i>Strongyloides</i>	<i>Bunostomum</i>	<i>Trichuris</i>	<i>Oesophagostomum</i>	<i>Chabertia</i>	<i>Dictyocaulus</i>	<i>Monezia</i>	<i>Fasciola</i>	<i>Coccidia</i>
Albendazole	+	+	+	+	+	-	+	-	+	+	+	+	+	-
Amprolium	-	-	-	-	-	-	-	-	-	-	-	-	-	-
Chlorsulon	-	-	-	-	-	-	-	-	-	-	-	-	+	-
Decoquinat	-	-	-	-	-	-	-	-	-	-	-	-	-	+
Fenbendazole	+	+	+	+	+	+	+	+	+	+	+	-	-	-
Haloan	+	+	+	+	-	-	-	-	-	-	-	-	-	-
Ivermectin	+	+	+	+	+	+	+	-	+	+	+	-	-	-
Levamisole	-	-	-	-	-	-	-	-	-	-	-	-	-	+
Levamisole	+	+	+	+	+	+	+	+	+	+	+	-	-	-
Moxidectin	+	+	+	+	+	-	+	-	+	-	+	-	-	-
Monensin	-	-	-	-	-	-	-	-	-	-	-	-	-	+
Morantel tartrate	+	+	+	+	+	+	+	-	+	+	+	-	-	-
Phenothiazine	+	+	+	-	-	-	-	-	+	-	-	-	-	-
Sulfonamides	-	-	-	-	-	-	-	-	-	-	-	-	-	+
Thiabendazole	+	+	+	+	+	+	+	-	+	+	-	-	-	-

+, Indicated for use; -, not indicated for use.

From McCurnin DM, Bassett JM: Clinical textbook for veterinary technicians, ed 5, Philadelphia, 2002, WB Saunders.

Hidden page

Table 13-5 Drugs Used to Treat Internal Parasites in Reptiles

Drug	PARASITE						
	Ectoparasites	Nematodes	Trematodes	Cestodes	Cryptosporidia	Coccidia	Amoebae and Trichomonads
Metronidazole (Flagyl)	-	-	-	-	-	-	+
Humatin 400 (Paromomycin)	-	-	-	-	-	-	+
Praziquantel (Droncit)	-	-	+	+	-	-	-
Febantel plus Praziquantel (Vercom)	-	+	+	+	-	-	-
Dichlorvos (Task)	-	+	-	-	-	-	-
Lewamisole (Tramisol, Ripercol)	-	+	-	-	-	-	-
Thiabendazole (Thibenzole)	-	+	-	-	-	-	-
Fenbendazole (Panacur)	-	+	-	-	-	-	-
Mebendazole (Telmin)	-	+	-	-	-	-	-
Ivermectin* (Ivomec)	+	+	-	-	-	-	-
Othiazanine iodide (Dizan)	-	+	-	-	-	-	-
Vapona Strip	+	-	-	-	-	-	-
Sulfadiazine (many trade names)	-	-	-	-	-	+	-
Sulfamerazine (many trade names)	-	-	-	-	-	+	-
Sulfamethazine (many trade names)	-	-	-	-	-	+	-
Sulfadimethoxine (Albon)	-	-	-	-	-	+	-
Trimethoprim plus Sulfadiazine (Di-Trim, Tribissen)	-	-	-	-	+	+	-

+, Effective; -, not effective.

* Do not use in chelonians. Contraindicated in animals that have been given diazepam or will receive diazepam within 10 days of administration of ivermectin. Data from Frye FL: Reptile care, Neptune City, NJ, 1991, T.F.H. Publications.

Table 13-6 Parasiticides Used for Control of External Parasites on Dogs and Cats

Drug	PARASITE				Drug	PARASITE			
	Fleas	Lice	Mites	Ticks		Fleas	Lice	Mites	Ticks
Allethrin	+	-	-	-	Linalool	+	-	-	-
Amaitraz	-	-	+	-	Lufenuron	+	-	-	-
Carbaril	+	+	+	+	Malathion	+	+	-	+
Chlorpyrifos	+	+	+	+	Methylcarbamate	+	+	-	+
Cythioate	+	-	-	-	Permethrin	+	+	-	+
β -Limonene	+	+	-	-	Phosmet	+	+	+	+
Diazinon	+	+	-	+	Pyrethrins	+	+	-	+
Fenthion	+	-	-	-	Resmethrin	+	+	-	-
Fipronil	+	+	-	+	Rotenone	+	+	-	+
Imidacloprid	+	+	-	-	Selamectin	+	-	+	+
Lime-sulfur	-	-	+	-					
Lindane (not legal in United States)	+	+	+	+					

+, Indicated for use; -, not indicated for use.

From McCurnin DM, Bassett JM: Clinical textbook for veterinary technicians, ed 5, Philadelphia, 2002, WB Saunders.

Table 13-7 Parasiticides Used for Control of External Parasites on Horses

Drug	PARASITE				
	Lice	Flies	Mites	Ticks	Maggots
Coumaphos	+	+	-	+	+
Malathion	+	+	+	+	-
Permethrin	+	+	-	+	-
Pyrethrins	+	+	-	-	-

+, Indicated for use; -, not indicated for use.

From McCurnin DM, Bassett JM: Clinical textbook for veterinary technicians, ed 5, Philadelphia, 2002, WB Saunders.

Table 13-8 Parasiticides Used for Control of External Parasites on Cattle, Sheep, and Goats

Drug	PARASITE											
	Cattle Grub	Horn Fly	Face Fly	Other Flies	Maggots	Chewing Lice	Sucking Lice	Psoroptic Mite	Other Mites	Ear Ticks	Other Ticks	Sheep Ked
Carbaryl	-	+	+	+	-	+	+	-	-	+	+	-
Coumaphos	+	+	+	+	+	+	+	+	-	+	+	+
Chlorpyrifos	-	+	-	-	-	+	+	-	-	-	-	-
Dichlorvos	-	+	+	+	-	-	-	-	-	-	+	-
Famphur	+	-	-	-	-	+	+	-	-	+	+	-
Doramectin	-	-	-	-	-	+	+	-	-	-	-	-
Fenthion	+	-	-	-	-	+	+	-	-	+	+	-
Fenvalerate	-	+	+	-	-	-	-	-	-	+	-	-
Ivermectin	+	-	-	-	-	-	+	+	+	+	+	-
Methoxychlor	-	+	+	+	-	+	+	-	-	+	+	-
Moxidectin	+	+	-	-	-	+	+	+	+	-	-	-
Permethrin	-	+	+	-	-	-	-	-	-	-	+	-
Phosmet	+	+	-	-	-	+	+	+	+	+	+	-
Pyrethrins	-	+	+	+	-	-	-	-	-	-	-	-
Rotenone	-	-	-	-	-	+	+	-	-	-	-	+
Trichlorfon	+	+	-	-	+	+	+	-	-	+	+	-

+, Indicated for use. -, not indicated for use.

From McCurmin DM, Bassett JM: Clinical textbook for veterinary technicians, ed 5, Philadelphia, 2002, WB Saunders.

Table 13-9 Parasiticides Used for Control of External Parasites on Swine

Drug	PARASITE			
	Lice	Flies	Mites	Maggots
Coumaphos	+	+	-	+
Fenthion	+	-	-	-
Ivermectin	+	-	+	-
Malathion	+	-	+	-
Methoxychlor	+	-	-	-
Permethrin	+	+	+	-
Pyrethrins	-	+	-	-

+, Indicated for use; -, not indicated for use.

From McCurnin DM, Bassett JM: Clinical textbook for veterinary technicians, ed 5, Philadelphia, 2002, WB Saunders.

Organophosphates

Organophosphates consist of a group of insecticides that inactivate acetylcholinesterase. Without this enzyme, parasites (especially ectoparasites) are unable to move because these chemicals stop nerve transmission. Many of these pesticides tend to break down when exposed to light, air, soil, and other environmental factors. However, some traces have been known to be residual in drinking water and food. Although they may degrade rather quickly, these substances have a high level of toxicity and may cause problems in people and animals exposed to large doses. SLUDGE is a good mnemonic to use for remembering the effects of toxic doses of these drugs; salivation, lacrimation, urination, defecation, GI upset, and emesis. Atropine may be used as an antidote.

Dosage Forms

This class includes the following products:

1. Trichlorfon (Combot, Dyrex T.F, Equibot TC)
2. Coumaphos (Baymix, Dairy Dewormer BX Crumbles)
3. Haloxon (Loxon)
4. Dichlorvos (Task, Atgard)

Clinical Uses

Organophosphates are used in the following species:

1. *Horses*. Effective against **bots**, roundworms, strongyles, and pinworms but less effective against *Strongyloides*
2. *Cattle, sheep, and goats*. Strongyles
3. *Dogs and cats*. Hookworms, roundworms, whipworms
4. *Swine*. Ascarids, whipworms, nodule worms, strongyles

Adverse Side Effects

Adverse side effects include those expected with any organophosphate poisoning: excessive salivation, vomiting, diarrhea, muscle tremors, and miosis.

Technician's Notes

1. It is very important that these anthelmintics not be administered concurrently or within a few days of the use of other cholinesterase inhibitors, other organophosphates, succinylcholine, or phenothiazine derivative agents.
2. Atropine and pralidoxime (2-PAM) are antidotal.
3. Read labels carefully regarding use in lactating dairy animals and animals to be slaughtered.

Tetrahydropyrimidines

Dosage Forms

This class includes the following products:

1. Pyrantel pamoate (Nemex, Strongid-T, Anthelban)
2. Pyrantel tartrate (Banminth 48)
3. Morantel tartrate (Nematel, Rumatel)

Clinical Uses

Tetrahydropyrimidines are used in the following species:

1. *Horses*. Ascarids, strongyles, pinworms
2. *Cattle, sheep, and goats*. Strongyles
3. *Dogs and cats*. Hookworms, roundworms
4. *Swine*. Roundworms, strongyles

Hidden page

2. Swine. Gastrointestinal roundworms, lungworms, kidney worms, sucking lice, and mange mites

Adverse Side Effects

These are uncommon. Toxic signs include mydriasis, ataxia, tremors, and depression.

Technician's Notes

1. Although not approved, Ivomec is sometimes used for the treatment of ear mites in cats and scabies in dogs.
2. Because of the small amount of medication in heartworm preventives, crumbling or breaking of the tablets or use of a chewable version is not recommended.
3. Read labels carefully regarding use in lactating dairy animals and animals for slaughter. Moxidectin is approved for use in dairy cattle of all ages and at all stages of lactation, except for veal calves.

Other Agents

PIPERAZINE (PIPA-TABS, PIP-POP 320)

1. Dogs and cats. Roundworms
2. Used effectively in exotics such as birds and snakes
3. Commonly combined in large-animal dewormers to broaden its spectrum and enhance its efficacy

PRAZIQUANTEL/PYRANTEL PAMOATE/FEBANTEL (DRONTAL PLUS)

Dogs. It is effective for the removal of tapeworms, hookworms, roundworms, and whipworms.

Adverse Side Effects

These are uncommon.

Technician's Notes

1. Do not use in dogs weighing less than 2 lb or in puppies younger than 3 weeks of age.
2. Do not use in pregnant animals.



Anticestodal

Drugs used for treating tapeworms have greatly improved over the years. These newer agents are more effective and do not necessitate fasting before their administration.

Bunamidine (Scolaban)

1. Dogs. *T. pisiformis*, *D. caninum*, *Echinococcus granulosus*, and *Echinococcus multilocularis*
2. Cats. *D. caninum*, *Taenia taeniaeformis*

Adverse Side Effects

These are uncommon but include vomiting, anorexia, diarrhea, and lethargy.

Technician's Notes

1. No adverse reactions have been reported in pregnant or breeding animals.
2. This product is not for use in puppies younger than 4 weeks or kittens younger than 6 weeks of age.

Epsiprantel (Cestex)

1. Dogs. *T. pisiformis* and *D. caninum*
2. Cats. *T. taeniaeformis* and *D. caninum*

Adverse Side Effects

These are uncommon.

Technician's Notes

1. Safety in pregnant or breeding animals has not been established.
2. This product is not for use in puppies or kittens younger than 7 weeks of age.



Antitrematoda

Clorsulon (Curatrem)

1. Cattle. Liver flukes
2. Effective against immature and adult flukes

Adverse Side Effects

These are uncommon.

Technician's Notes

1. This product is not approved for use in female dairy cattle of breeding age.
2. Read label regarding use in animals to be slaughtered.

Albendazole (Valbazen)

1. Cattle. Liver flukes
2. Effective against adult flukes and many intestinal worms

Praziquantel (Droncit)

Praziquantel may be used for lung flukes in dogs and cats.

Topical Solutions**Emodepside/Praziquantel (Profender)**

1. A topical solution for the treatment and control of hookworms, roundworms, and tapeworms in cats 8 weeks of age or older
2. Emodepside is a cyclic depsipeptide.
3. Praziquantel is an isoquinoline cestocide.
4. To be applied every 30 days for preventive purposes
5. Some clients may elect to use this product instead of oral meds, which may be difficult for them to administer to their cat.

Antiprotozoal

Protozoa are single-celled organisms found at various body sites that have the ability to replicate rapidly. *Coccidia* and *Giardia* are the protozoa that are most commonly associated with diarrhea in many species of animals. Protozoa are most commonly transmitted via contaminated feed and/or water. Prevention of these parasites includes providing uncontaminated food and water and clean housing and avoiding overcrowding. A vaccine is

also available for the prevention of giardiasis in dogs. *Babesia* is a hematozoan (i.e., a protozoan) that is transmitted by ticks and affects many species of animals. An injectable treatment for babesiosis is available for dogs.

Drugs for Treating Coccidia and Other Protozoa

1. Monensin (Coban 60). Turkeys and chickens
2. Amprolium (Corid). Calves
3. Clopidol (Coyden 25). Chickens
4. Diclazuril (Clincox). Horses
5. Maduramicin ammonium (Cygro Type A Medicated Article). Chickens
6. Decoquinatate (Deccox). Cattle, calves, and goats
7. Narasin/nicarbazine (Maxiban 72). Chickens
8. Ponazuril (Marquis). Horses
9. Robenidine hydrochloride (Robenz Type A Medicated Article). Chickens
10. Sulfadimethoxine (Albon). Chickens, turkeys, dogs, and cats

Adverse Side Effects

These are uncommon.

Technician's Notes

Read labels carefully regarding use in food-producing animals and animals to be slaughtered.

Drugs for Treating Giardia

1. Metronidazole (Flagyl). Dogs and cats
2. Albendazole (Valbazen). Dogs and cats

Adverse Side Effects

These are uncommon, but vomiting and diarrhea may occur in some animals treated with metronidazole.

Technician's Notes

Metronidazole is not recommended for use in pregnant animals.

Drugs for Preventing *Giardia*

A vaccine for dogs is available as an aid in the prevention of *Giardia lamblia* infection and for a reduction in the duration of cyst shedding. This vaccine is administered subcutaneously, and a booster is given 2 to 4 weeks after the first vaccination. Annual revaccination is recommended.

Dosage Form

GiardiaVax

Adverse Side Effects

These are uncommon.

Technician's Notes

1. May be used in dogs 8 weeks of age or older
2. After exposure to *Giardia*, some vaccinates may shed cysts. Clients should be educated regarding proper hygiene and sanitation practices to prevent zoonotic disease.

Drugs for Treating *Babesia*

Imidocarb dipropionate is available for the treatment of clinical signs of babesiosis and/or evidence of *Babesia* organisms in the blood. This product is indicated for use in dogs, and treatment consists of two injections given over a 2-week interval.

Dosage Form

Imizol

Adverse Side Effects

These may include injection pain and mild cholinergic signs such as salivation, nasal drip, and vomiting. Other less common side effects include panting, restlessness, diarrhea, and mild injection site inflammation.

Technician's Notes

Severe cholinergic signs may be reversed with atropine sulfate.

HEARTWORM DISEASE

Heartworm disease is commonly found throughout the United States. This disease primarily affects dogs and wild Canidae, although cats and ferrets also may become infected. *D. immitis* is the filarial nematode that causes heartworm disease. *Acanthocheilonema reconditum* (formerly known as *Dipetalonema reconditum*) (Hendrix, 2006) is a subcutaneous filarial nematode that does not require treatment because it is non-pathogenic. Prevention is the key word for controlling heartworm disease. Dogs not on an approved heartworm disease prevention program should be tested for the presence of adult heartworms before preventive treatment is begun. Clients should be educated about the importance of treating an existing infection if one exists, preventing infection or reinfection, and ensuring periodic testing that may be necessary. (Many veterinarians will not prescribe heartworm prevention without an annual heartworm antigen test.) Over the past several years, the number of cats in which heartworm disease has been diagnosed has increased. The treatment and justification for prevention of heartworms in cats continue to be controversial (Smith, 1999). Products for the prevention of *D. immitis* infection in cats are available. No adulticide products have been approved for use in cats. Table 13-10 provides a comparison of several heartworm preventives that are on the market at this time.



Adulticides

Melarsomine Dihydrochloride (Immiticide)

1. An arsenic compound administered by deep intramuscular injection in the lumbar region
2. Administration schedule is based on classification of the severity of heartworm disease.
3. Melarsomine appears to be more efficacious than thiacetarsamide (Caparsolate) and less irritating to tissue and does not cause hepatic necrosis (Plumb, 2005).

Adverse Side Effects

Some dogs experience reactions such as pain, swelling, and tenderness at the injection site. Firm nodules may form at the injection site. Coughing, gagging,

Table 13-10 Comparison of Products Indicated for Heartworm Prevention

	What Is the Mode of Administration?	What Are the Age Parameters?	Is the Product Safe for Use in Pregnant Animals?	What Is the Effectiveness After Swimming?	What Action Should Be Taken if a Dose Is Late?	What Is the Safety of the Drug if Given Mistakenly to HW ⁺ Dogs?	Are Other Parasites Affected?	What Stage of the HW Life Cycle Is Acted Upon?
Heartgard Plus	Chewable tablet given PO on the same day every month	Puppies: 6 weeks Kittens: 6 weeks	Yes	N/A	15-day grace period (one dose protects against infection up to 45 days)	Not approved for such use; probably won't cause problems	Dogs: Roundworms Hookworms Cats: Hookworms Roundworms Whipworms	3 rd and 4 th stage microfilaria larvae
Interceptor	Flavored tablet given PO on the same day every month	Puppies: 8 weeks Cats: Not approved for use in cats	Yes	N/A	Can pick up next dose when mistake is noted but shouldn't wait longer than 2-3 weeks	Probably safe if microfilaria counts aren't too high; may be dangerous if microfilaria counts are high		Microfilaria larvae stages, 3 rd , 4 th and some 5 th larvae stages,
Revolution	Topical application on the same day every month	Puppies: 6 weeks Kittens: 6 weeks	Yes	No effect, but pet must be dry when product is applied	Up to 2 months is grace period	Is safe because product is FDA-approved for use in heartworm-positive dogs	Sarcoptic mange mites, ear mites, fleas, roundworms in cats, and hookworms in dogs	Microfilaria 4 th stage larvae
Sentinel*	Flavored tablet given PO on the same day every month	Puppies: 8 weeks Cats: Not approved for use in cats	Yes	N/A	Can pick up next dose when mistake is noted but shouldn't wait longer than 2-3 weeks	Probably safe if microfilaria counts aren't too high; may be dangerous if microfilaria counts are high	Hookworms Roundworms Whipworms	Microfilaria 4 th stage larvae
ProHeart	Tablet given PO on the same day every month; injection given by DVM, which lasts 6 months	Puppies: 8 weeks Cats: Not approved for use in cats	Yes	N/A	Up to 84-day grace period	Safe because product is approved by FDA for use HW ⁺ dogs	Tablets: Heartworms only Injectable: Heartworms and hookworms	Microfilaria 3 rd stage larvae

*Sentinel has lufenuron in it, which breaks down the chitin within the flea's shell, rendering it harmless.

depression, lethargy, anorexia, fever, lung congestion, and vomiting are common reactions.

Technician's Notes

1. The manufacturer recommends use of a 23-gauge, 1-inch needle for dogs equal to or less than 22 lb and a 22-gauge, 1½-inch needle for dogs larger than 22 lb.
2. Safety in breeding, lactating, or pregnant bitches has not been determined.
3. Melarsomine is contraindicated in dogs with severe heartworm disease (Class 4, according to manufacturer disease classification).
4. Clients must be informed of the potential of morbidity and mortality associated with heartworm treatment.
5. Exercise in dogs should be restricted after treatment has been provided.



Microfilaricides

1. Given 6 weeks after administration of the adulticide
2. Kill circulating **microfilaria**
3. Although not approved as microfilaricides, ivermectin and milbemycin oxime have been used.
4. Levamisole also has been used as a microfilaricide.



Preventives

Imidacloprid + Moxidectin (Advantage multi)

1. Advantage multi for dogs 7 weeks or older and weighing at least 3 lbs.
2. Advantage multi for cats 9 weeks or older and weighing at least 2 lbs.
3. To be applied topically on a monthly basis (Bayer website, April 2007).

Ivermectin (Heartgard, Heartgard Plus, Heartgard for Cats)

1. Dogs. Monthly preventive; the Plus formula contains pyrantel pamoate and is effective against hookworms and roundworms

2. Cats. Monthly preventive for *D. immitis* and for the removal of hookworms
3. Eliminates the tissue stage of heartworm larvae

Adverse Side Effects

These are uncommon. Toxic signs include mydriasis, depression, and ataxia.

Technician's Notes

1. If diethylcarbamazine citrate (DEC) is replaced, the first dose should be given within a month after cessation of DEC treatment.
2. This product is safe to use in pregnant and breeding animals.
3. Do not use in puppies or kittens younger than 6 weeks of age.

Milbemycin Oxime (Interceptor, Sentinel)

1. Dogs. Monthly preventive; also controls hookworms, roundworms, and whipworms
2. Eliminates the tissue stage of heartworm larvae
3. Sentinel product contains lufenuron for flea control.

Adverse Side Effects

These are uncommon.

Technician's Notes

1. If DEC is replaced, the first dose should be given within 1 month after cessation of DEC treatment.
2. This product is safe to use in pregnant and breeding animals.
3. Do not use in puppies younger than 4 weeks of age.

Moxidectin (ProHeart)

1. Dogs. Monthly preventive used for *D. immitis* (Fort Dodge website, 2007).
2. Eliminates the tissue stage of heartworm larvae
3. This drug has been taken off the market.

Adverse Side Effects

Adverse side effects may include lethargy, vomiting, ataxia, anorexia, diarrhea, nervousness, weakness, polydipsia, and itching.

Technician's Notes

1. If DEC is replaced, the first dose should be given within 1 month after cessation of DEC treatment.
2. This product is safe to use in pregnant and breeding animals.
3. Do not use in puppies younger than 8 weeks of age.

Selamectin (Revolution)

1. Dogs and cats. Used as a monthly preventive.
2. Available as a solution for topical administration.
3. Indications include prevention of heartworm disease caused by *D. immitis*, prevention and control of flea infestations, treatment and control of ear mites (*Otodectes cynotis*) infestation, treatment and control of sarcoptic (*Sarcoptes scabiei*) mange in dogs, and hookworm and roundworm treatment in cats.

Adverse Side Effects

These are uncommon but include transient, localized alopecia at the application site of some treated cats.

Technician's Notes

1. If DEC is replaced, the first dose should be given within 1 month after cessation of DEC treatment.
2. This product is safe to use in pregnant and breeding animals and in avermectin-sensitive collies.
3. Do not use in puppies or kittens younger than 6 weeks of age.
4. This product should not be applied if the haircoat is wet. Bathing the animal 2 or more hours after treatment will not reduce its effectiveness.

Diethylcarbamazine Citrate (Carbam, Filaribits, Filaribits Plus)

1. Daily preventive; also controls roundworms
2. Filaribits Plus also contains oxibendazole for the control of hookworms, whipworms, and roundworms.
3. Eliminates the tissue stage of heartworm larvae

Adverse Side Effects

These include occasional vomiting. Filaribits Plus has been linked with hepatic dysfunction.

Technician's Notes

1. Administering with food or directly after a meal reduces the possibility of vomiting.
2. This product is safe to use in pregnant and breeding animals.
3. Missing just 2 to 3 days can affect the efficacy of this product.
4. Do not use in puppies younger than 8 weeks of age.

ECTOPARASITES

Most ectoparasites are ubiquitous in the environment; therefore, control is often difficult. Environmental factors such as housing (indoor or outdoor) and geographic location may affect the incidence of many ectoparasites such as fleas and ticks. When trying to control ectoparasites, the veterinary technician must be familiar with the products used to eradicate these parasites and to educate clients about how to properly combat their pet's infestation. Not only do ectoparasites cause misery to their host, but many dermatologic problems arise from their infestation. Additionally, increased infestation of fleas may affect humans because fleas are not host specific. Table 13-11 provides a comparison of various topical products on the market at this time.

**Application Systems****Prediluted Sprays**

1. Consumers like the convenience of sprays.
2. Sprays are available for animal and environmental use.
3. These formulations are available only for the use specified on the label and should be used accordingly.
4. Sprays are available as water-based and alcohol-based formulations.
 - a. Water-based sprays do not penetrate oily coats or fabrics as well and do not dry as quickly as alcohol-based sprays.
 - b. Alcohol-based sprays may be irritating and drying to the skin. They usually kill ectoparasites quickly.

Hidden page

- Environmental sprays are usually residual. Most pet sprays require application daily or every 2 to 3 days for adequate parasite control.

Adverse Side Effects

These vary among products. Carefully read warning labels.

Technician's Notes

- Spray the pet from head to tail, including the legs and abdomen. Avoid only the eyes, mouth, and nose. For best results, spray against the natural lay of the hair.
- Educate clients about environmental control and how to treat the pet.
- Read labels before applying to young, sick, or pregnant animals. Some products are not safe for certain species (e.g., cats).
- Water-based flea sprays are best used on young animals because alcohol-based sprays tend to evaporate quickly and may cause loss of body heat. It is best to apply water-based sprays only to the dorsal area and then to spread the spray by combing through the haircoat. In this way, the young animal does not lose body heat.

Emulsifiable Concentrates

DIPS

- Concentrates have to be diluted with water.
- Dips usually are used after a shampoo.
- Dips generally are considered residual.

Adverse Side Effects

These vary among products. Read labels carefully for animal and user safety and precautions.

Technician's Notes

- Removal of excess water or drying of the coat before dipping is recommended to prevent further dilution of the product.
- For best results, do not rinse after applying the dip.
- Organophosphate dips should *never* be applied to cats.

YARD AND KENNEL SPRAYS

- These are designed for environmental use and should not be used on animals.
- These products are residual.

Adverse Side Effects

These vary among products. Directions for application should be followed carefully for the safety of the user and of animals.

SHAMPOOS

- These products may contain insecticides or medications, or they may be effective only for cleaning the coat.
- Some shampoos are available as concentrates and require dilution before use.
- Shampoos are not considered to be residual.
- Rinse shampoos well; water hardness/softness affects how quickly some shampoos rinse away.

Adverse Side Effects

These vary among products. Shampoos that contain carbamates or organophosphates should not be used with other products of the same origin.

Technician's Notes

- Read labels carefully. Shampoos may seem harmless, but they can be harmful if used improperly.
- It is recommended that most shampoos be left on the haircoat for 5 to 10 minutes before rinsing.
- If shampoo is not rinsed well, a hot spot may develop on the pet's skin.

DUSTS

- Popularity has decreased with the availability of effective sprays.
- Dusts do not provide a quick kill.

Adverse Side Effects

These include irritation to mucous membranes and drying of the skin and haircoat.

FOGGERS

- Foggers work best in large, open rooms.
- Remind clients that foggers do not go around corners, under couches, or into closets.

Hidden page

Hidden page

Hidden page

Hidden page

3. D-Limonene (VIP Flea Dip, VIP Flea Control Shampoo)
 - a. Extract of citrus peel
 - b. Found in sprays, shampoos, and dips
 - c. Provides a quick kill but is not residual
4. Benzyl benzoate. Effective against many ectoparasites and may be combined with other agents
5. Petroleum distillate. Usually added to products as the solvent for pyrethrin and pyrethroid products

REFERENCES

Bayer website (April 2007): www.bayerdvm.com/Resources/Docs/Profender-Label.pdf
Eli Lilly website (2007)

Fort Dodge website (2007): www.fortdodge.eu/products.asp?id=1=dogTopical
Hendrix CM, editor: *Diagnostic veterinary parasitology*, ed 2, St. Louis, 2006, Mosby.
Kirk RW: *Current veterinary IX: small animal practice*, Philadelphia, 1986, WB Saunders.
McCurnin DM, Bassett JM: *Clinical textbook for veterinary technicians*, ed 6, Philadelphia, 2006, Elsevier Saunders.
Novartis website (2007): www.novartis.com/products/en/cab/capstar.shtml
Plumb DC: *Veterinary drug handbook*, ed 5, Ames, Iowa, 2005, Iowa State University Press.
Smith P: New studies, products fuel heartworm debate, *Veterinary Product News* 11(4):34-36, 1999.



REVIEW QUESTIONS

- Name five types of symbiotic relationships.

- What is parasitiasis? _____
- What is parasitosis? _____
- What are ectoparasites?

- What are endoparasites?

- An animal with endoparasites is said to be _____, and an animal with ectoparasites is said to be _____.
- What is an anthelmintic?

- _____ dips should never be used on cats.
- IGR is an acronym for _____.
- Praziquantel is a drug that is used to rid the body of _____.
- An example of _____ is the bacterium *Moraxella bovis*, the etiologic agent of infectious bovine keratoconjunctivitis, or pinkeye, that is mechanically carried from the eyes of one cow to those of another on the sticky footpads of the face fly *Musca autumnalis*.
 - predator-prey
 - commensalism
 - mutualism
 - phoresis
- Ivermectin, moxidectin, and doramectin are in the _____ class.
 - avermectins
 - ivermectins
 - tetrahydropyrimidines
 - microfilaricides
- All the following are monthly heartworm preventives, except _____.
 - milbemycin oxime
 - selamectin
 - Heartgard Plus
 - diethylcarbamazine
- _____ is the most commonly used formamide in veterinary medicine.
 - Dichlorvos
 - Propoxur
 - Amitraz
 - Selamectin
- _____ is a topical solution that controls ascarids, hookworms, and tapeworms in felines.
 - Selamectin (Revolution)
 - Profender (emodepside/praziquantel)
 - Fipronil (Frontline)
 - Lufenuron (Program)
- An arsenic compound administered by deep IM injection in the lumbar region is _____.
 - caparsolate
 - clorsulon
 - melarsomine dihydrochloride
 - Ivomec
- Albendazole is the active ingredient found in _____.
 - Droncit
 - ProMeris
 - Synanthic
 - Valbazen
- An organophosphate is a substance that can interfere with the function of the nervous system by inhibiting the enzyme cholinesterase.
 - True
 - False
- Advantage has greater efficacy against _____, and Frontline has greater efficacy against _____.
 - ticks; fleas
 - fleas; ticks
- _____ are parasitic worms, including intestinal roundworms, filarial worms, lungworms, kidney worms, heartworms, and others.
 - Cestodes
 - Trematodes
 - Acanthocephalans
 - Nematodes

Hidden page

**KEY TERMS**

ADDISON'S DISEASE A disease or syndrome characterized by inadequate amounts of corticosteroid hormones.

ANALGESIA The absence of the sensation of pain.

CUSHING'S DISEASE A disease or syndrome characterized by an overabundance of corticosteroid hormones.

DEEP PAIN Pain arising from deep receptors in the periosteum, tendons, and joint structures.

HISTAMINE A chemical mediator of the inflammatory response released from mast cells. Histamine may cause dilation and increased permeability of small blood vessels, constriction of small airways, increased secretion of mucus in the airways, and pain.

IATROGENIC Caused by the physician (veterinarian).

MODULATION The modification of nociceptive transmission.

NERVE BLOCK A loss of feeling or sensation produced by injecting an anesthetic agent around a nerve to interfere with its ability to conduct impulses.

PROSTAGLANDIN A substance synthesized by cells from arachidonic acid that serves as a mediator of inflammation and has other physiologic functions.

REGIONAL ANESTHESIA Loss of feeling or sensation in a large area (region) of the body after injection of an anesthetic agent into the spinal canal or around peripheral nerves.

TRANSDERMAL APPLICATION The use of a patch applied to the skin to deliver a drug through an intact cutaneous surface to the systemic circulation.

TRANSDUCTION The process that involves translation of noxious stimuli into electrical activity at sensory nerve endings.

INTRODUCTION

Pain has been defined by the International Association for the Study of Pain as "an unpleasant sensory and emotional experience associated with actual or potential tissue damage." It may occur alone or in combination with inflammation. Pain sensation arises in free nerve endings called *nociceptors*, which are located in the skin, joints, blood vessel walls, periosteum, hollow organs (e.g., stomach, intestines, bladder), and parietal surfaces of the thorax and abdomen. These free nerve endings may be activated through mechanical, thermal, and chemical stimulation. Chemical stimulation may be derived from an exogenous source or from endogenous chemicals such as eicosanoids (prostaglandins), bradykinin, serotonin, and others released in response to tissue damage. Pain can have varying degrees of severity and may be acute or chronic.

Pain is sensed in terms of its intensity, duration, location, and quality. Pain that arises in subcutaneous tissue is called *superficial pain*. **Deep pain** is associated with skeletal muscles, tendons, and bones and joints. Visceral pain arises from hollow abdominal organs, peritoneum, heart, liver, and

lungs. Pain can be beneficial in that it can allow the animal to avoid damaging stimuli. It has an emotional content and activates sympathetic stimulation. It can be harmful because it can lead to stress and related problems such as gastrointestinal lesions, immunosuppression, delayed healing, hypertension, and potential dysrhythmias. Pain also has a motivational component and can be used to force behavior and compliance (Kamerling, 2001).

Assessment of pain in animals can be very difficult because of the dependence on nonverbal communication in veterinary medicine. Furthermore, animals differ from people in their pain response. It is important for wild animals to control the expression of pain to avoid predation or abandonment. Response to pain varies among individuals and may include increased heart rate, increased respiratory rate, mydriasis, salivation, vocalization, changes in facial expression, guarding of the painful site, restlessness, unresponsiveness, failure to groom, abnormal gait, abnormal stance, and rolling. A patient that is pain-free will be quiet and calm (Paddleford, 1999).

Drugs used to control pain (analgesics) include nonsteroidal antiinflammatory drugs (NSAIDs)

and narcotics (see Chapter 4). The body is able to produce its own opiate-like analgesic agents called *endorphins* and *enkephalins*. Efforts to synthesize these substances for commercial production have been unsuccessful.

Even though some people believe that masking pain with analgesics can interfere with the diagnosis or treatment course of a disease, animals in pain should be treated for humane reasons and to reduce the harmful side effects that accompany it. The treatment regimen may vary according to assessment of the severity and the origin of the pain. For best results, pain management intervention should be preemptive when possible.

Inflammation is a basic process that occurs in the body in response to tissue injury caused by physical, chemical, or biologic trauma. The objectives of this process are (1) to counteract the injury by removing or walling off the cause of the injury and (2) to repair or replace the damaged tissue. Clinical manifestations (cardinal signs) of inflammation include redness, heat, swelling, and pain. Although the process is designed to be protective, it can continue to become a source of further injury or damage (e.g., allergy, shock, "proud flesh").

Damage to cells from any source results in the release of several chemical mediators that may initiate or prolong the inflammatory response. These chemicals include **prostaglandins**, leukotrienes, **histamine**, cytokines, and other mediators. These substances cause helpful responses such as dilation and increased permeability of blood vessels that result in increased blood flow to the injured tissue. Enhanced blood flow brings plasma to dilute the offending agent, fibrin to immobilize it, and phagocytic cells to remove it. Redness, heat, swelling, and, to some extent, the pain of inflammation result from increased amounts of blood in the damaged tissue. The chemical mediators serve other beneficial functions such as attracting phagocytic cells to the area of concern (chemotaxis) and several potentially harmful functions such as initiation of bronchoconstriction (histamine), anaphylactic shock, pain (histamine), cell death, platelet aggregation, and intestinal spasm. The inflammatory process can be acute (anaphylaxis) or chronic (flea allergy and arthritis).

Drugs that are used to minimize the inflammatory process include NSAIDs, glucocorticosteroids, and several miscellaneous agents such as dimethyl sulfoxide (DMSO). Another process mediated by a chemical (or chemicals) released from damaged cells is fever. Fever is an increase in body temperature to above normal; it is an important clinical indicator of disease. The purpose of fever may include destruction of invading microorganisms by heat inactivation and facilitation of biochemical reactions in the body. (Most chemical reactions are speeded up by increased heat.)

Heat is generated by the metabolic activity of muscles and glands and is lost through radiation or conduction loss from the skin, sweat evaporation, and evaporation during panting. A "thermostat" in the hypothalamus regulates these mechanisms, which control body temperature.

A substance that can initiate a fever is called a *pyrogen*. An exogenous pyrogen is a foreign substance (e.g., bacteria, viruses) that when introduced into the body causes the release of an endogenous pyrogen (a chemical mediator such as prostaglandin) from white blood cells; this endogenous pyrogen causes resetting of the hypothalamic thermostat. The hypothalamus then activates processes to generate or conserve body heat: shivering to generate more heat, constriction of blood vessels in the skin to prevent radiation and conduction loss, and decreased sweating or panting to reduce evaporation loss. Damaged cells in some instances may release endogenous pyrogens in the absence of exogenous pyrogens. Drugs used to control fever are primarily NSAIDs.

ANATOMY AND PHYSIOLOGY

Pain sensation arises by a process called **transduction** in nociceptors—"naked" nerve endings found in almost every tissue of the body. Pain impulses are carried to the central nervous system (CNS) by two fiber systems: type C unmyelinated fibers are responsible for dull, poorly localized pain (in humans), and type A delta fibers are responsible for sharp, localized pain (Ganong, 2003). Type A and type C fibers carry impulses to the dorsal horn of

Hidden page

antidepressants, NSAIDs, anticonvulsants, and other drugs. Pain perception in the cortex can be inhibited by the use of anesthetics, opioids, benzodiazepines, and alpha-2 agonists.

Nonsteroidal Antiinflammatory Drugs

NSAIDs are thought to work by inhibiting an enzyme called *cyclooxygenase* (COX). Two forms (COX-1 and COX-2) of cyclooxygenase exist. COX-1 maintains physiologic functions such as modulation of renal blood flow and synthesis of gastric mucosa (Paddleford, 1999). COX-2 promotes the formation of prostaglandin from cell membrane arachidonic acid (Figure 14-2). NSAIDs that selectively inhibit COX-2 are thought to

produce fewer gastrointestinal side effects. Glucocorticoids exert their effects by blocking phospholipase, an enzyme necessary for the production of both prostaglandins and leukotrienes (intervention is provided earlier in the sequence of the formation of inflammatory mediators). Because the inflammatory reaction is blocked earlier by glucocorticoids, they are more effective antiinflammatory agents than are NSAIDs (Langston and Mercer, 1988). NSAIDs are often preferred, however, because they have fewer side effects and they promote **analgesia** and fever reduction. At this time, it is not known why glucocorticoids do not induce the analgesic and antipyretic effects of NSAIDs. It is also unknown why some NSAIDs provide relief of only mild pain (aspirin) and others provide relief of moderate to severe pain (flunixin). Some clinicians speculate that NSAIDs may act to varying degrees

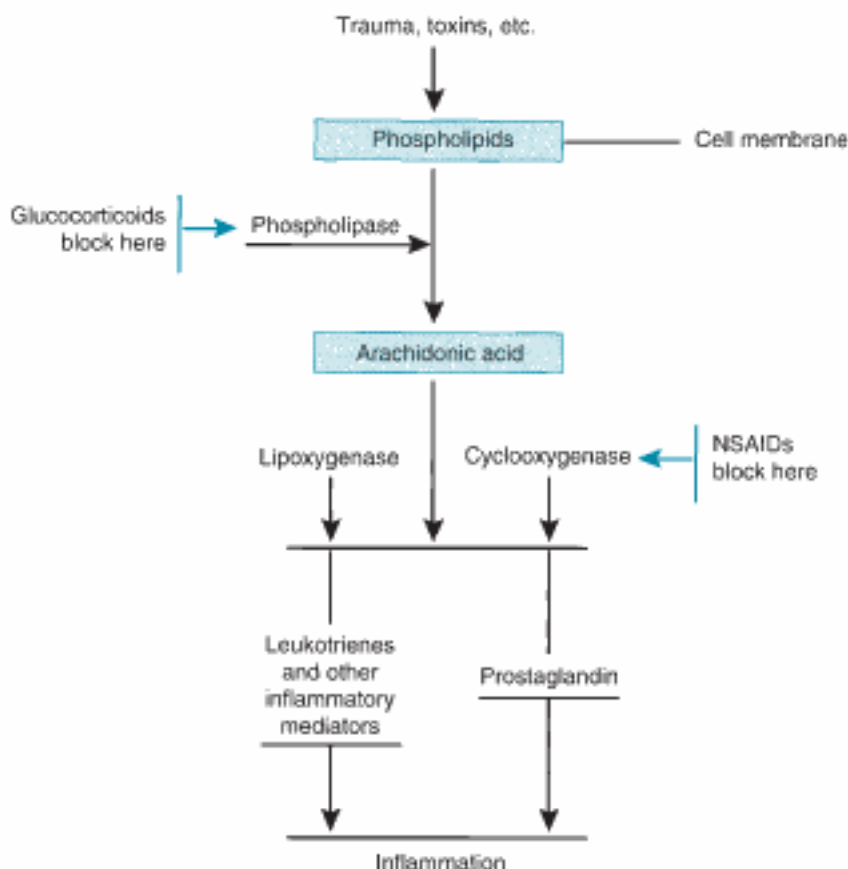

FIGURE 14-2

Actions of nonsteroidal antiinflammatory drugs and glucocorticoids to interrupt the inflammatory response.

centrally to modulate spinal transmission of pain impulses (Paddleford, 1999).

The most common side effects of the NSAIDs are gastrointestinal ulceration and bleeding, which probably result from interference with the normal mucous coating of the stomach. Other side effects may include hepatotoxicity, nephrotoxicity, inhibition of cartilage metabolism, bone marrow suppression, and bleeding tendencies (from reduced platelet aggregation).

All pets should undergo a thorough physical examination and history, as well as appropriate laboratory tests, before NSAIDs are initiated. Clients should be advised to stop the use of these drugs and to contact their veterinarian if they observe side effects in their pets that are receiving NSAIDs. Pets on long-term NSAID use should have periodic evaluations of liver and kidney function performed. Clients should be advised to watch their pets for anorexia, vomiting, changes in bowel movements, bloody or tarry stools, lethargy or other changes in behavior, seizures, jaundice, changes in urination (frequency, color, or smell), or changes in the condition of the skin.

Technician's Notes

1. NSAIDs should be used with caution in geriatric animals.
2. Combining NSAIDs or combining NSAIDs with corticosteroids should be done with great caution or avoided.

Salicylates

Aspirin, a salicylate, is also known as acetylsalicylic acid. Its actions include the following:

1. Relief of pain (analgesia)
2. Reduction in fever (antipyrexia)
3. Inhibition of inflammation (antiinflammatory)
4. Reduction in platelet aggregation

These effects are thought to occur as a result of the ability of aspirin to inhibit an enzyme (COX) that is responsible for the synthesis of prostaglandin. Prostaglandin is a chemical mediator of the processes that lead to pain, fever, inflammation, and platelet aggregation. Its inhibition results in diminishing of each process.

Clinical Uses

Clinical uses of aspirin exist for most animal species and may include the following:

1. Relief of mild to moderate pain caused by musculoskeletal conditions such as arthritis and hip dysplasia
2. Postadulticide treatment for heartworm disease
3. Analgesia/antipyrexia
4. Treatment of cats with cardiomyopathy
5. Treatment of endotoxic shock

Dosage Forms

These include plain uncoated tablets, buffered uncoated tablets, enteric-coated forms, and boluses (large-animal applications). Many generic or brand names are available in many different strengths, including the following:

1. Aspirin bolus
2. Aspirin tablets
3. Cortaba (a combination of aspirin and methylprednisolone)

Adverse Side Effects

Adverse side effects of aspirin include gastric irritation, which can lead to ulceration and bleeding. Cats are highly susceptible to aspirin overdose because of their inability to metabolize it rapidly; they should receive this drug only under the supervision of a veterinarian.

Technician's Notes

1. Enteric-coated aspirin, such as Ecotrin, may be used to prevent gastric irritation.
2. A 1-grain "baby" aspirin contains 65 mg; a 1.25-grain baby aspirin contains 81 mg.
3. Aspirin has no withdrawal time in food animals.

Pyrazolone Derivatives

PHENYLBUTAZONE

Phenylbutazone, a pyrazolone derivative, is an NSAID that is commonly used in veterinary medicine. Its actions include the following:

1. Analgesia for mild to moderate pain
2. Antiinflammatory action
3. Antipyrexia

Clinical Uses

These include relief of inflammatory conditions of the musculoskeletal system of horses and dogs. Phenylbutazone is used extensively in horses for the treatment of lameness and for the relief of pain associated with colic. It sometimes is used in dogs and cattle for its antiinflammatory, analgesic, and antipyretic effects.

Dosage Forms

Dosage forms of phenylbutazone include parenteral injection, tablets, boluses, an oral paste, an oral gel, and powder.

1. Butazolidin Tablets, Boluses, Paste, Injection
2. Phenylzone Paste
3. Equipalazone Powder
4. Equi-Phar Phenylbutazone Gel, Tablets
5. Phenylbutazone Tablets
6. Pro-Bute
7. Phenylbutazone Injection

Adverse Side Effects

These include gastrointestinal bleeding and bone marrow suppression.

Technician's Notes

1. Phenylbutazone injection should be administered by the intravenous route only. Subcutaneous and intramuscular injection may lead to sloughing of tissue.
2. Prolonged use or overdose can lead to bone marrow suppression in humans.
3. Prolonged use also may lead to ulcer formation.
4. Because of possible bone marrow suppression and potential ulcer formation, animals that are receiving long-term treatment with phenylbutazone should be monitored carefully.

Flunixin Meglumine (Banamine)

Flunixin is an NSAID that is labeled for use in horses and cattle. It has extralabel uses in other species. Its actions are related to its ability to inhibit COX and include the following:

1. Analgesia
2. Antipyrexia
3. Antiinflammatory

Clinical Uses

Clinical uses of flunixin in horses include alleviation of pain associated with musculoskeletal disorders and colic. (Flunixin apparently has great ability to inhibit visceral pain.) Other uses in horses and other species include treatment of the following:

1. Disk disease
2. Endotoxic shock
3. Calf diarrhea
4. Parvovirus disease
5. Heatstroke
6. Ophthalmic conditions
7. Postsurgical pain

Dosage Forms

Dosage forms of flunixin include injectable, oral paste, and oral granule formulations.

1. Banamine Injection
2. Banamine Oral Paste
3. Banamine Oral Granules
4. Finadyne

Adverse Side Effects

These are limited in horses but may include swelling at the injection site and sweating. In dogs, vomiting, diarrhea, nephrotoxicity, and gastric ulceration may occur with long-term use.

Technician's Notes

1. Flunixin is labeled for intravenous and intramuscular use in horses.
2. Some equine clinicians believe that flunixin relieves abdominal pain so well in horses that it may cause a sense of false security about the condition of an animal with colic.
3. Small-animal patients receiving flunixin should be well hydrated and should be given intravenous fluids and ulcer prophylaxis (Paddleford, 1999).

Dimethyl Sulfoxide

DMSO is a clear liquid that was originally developed as a commercial solvent. It is noted for its antiinflammatory action and its ability to act as a carrier of other agents through the skin. Its antiinflammatory actions may be related to its ability to trap products

associated with the inflammatory response. DMSO causes vasodilation when applied topically.

Clinical Uses

Clinical uses of DMSO are varied; however, the only labeled use for DMSO is for topical application to reduce acute swelling resulting from trauma in dogs and horses. DMSO has reportedly been used as the following:

1. An adjunct to intestinal surgery (intravenously)
2. A treatment for cerebral edema or spinal cord injury (intravenously)
3. A treatment for perivascular injection of chemotherapeutic agents or other irritating substances (topical)
4. A carrier of drugs across the skin

Dosage Forms

Dosage forms of DMSO include a solution (90%) and a gel (90%).

1. DMSO Gel and Solution (90%)
2. Synotic (DMSO and a steroid)

Buscopan Compositum

Buscopan Compositum is a product that contains butylscopolaminium bromide and metamizole sodium (dipyrone).

Clinical Uses

This product is used for the management of abdominal pain associated with equine colic.

Dosage Form

1. Buscopan Compositum

Adverse Side Effects

Adverse side effects of DMSO are probably minimal with limited use or exposure but may include the following:

1. Garlic taste, which occurs very shortly after the agent is applied to the skin
2. Skin irritation accompanied by a burning sensation
3. Induction of birth defects (teratogenic) in some species

Technician's Notes

1. Rubber gloves should be worn while applying DMSO.
2. Bandaging over an application of DMSO may cause skin irritation.
3. DMSO should be used carefully when cholinesterase inhibitors have been used.

Acetaminophen

Acetaminophen is an analgesic with limited antipyretic and antiinflammatory activities.

Clinical Uses

Clinical uses of acetaminophen are limited in veterinary medicine, and acetaminophen use should be discouraged because of the risk of potential toxicity and the availability of acceptable substitutes.

Dosage Forms

Dosage forms of acetaminophen include tablets, caplets, and liquid formulations. Following is a list of some of the human label brand names:

1. Tylenol
2. Dairil
3. Tempra

Technician's Notes

1. Acetaminophen should never be given to cats.
2. Over-the-counter products should be checked carefully for the presence of acetaminophen before they are used in cats.

Adverse Side Effects

Adverse side effects of acetaminophen use in cats include the formation of methemoglobinemia, cyanosis, anemia, and liver damage. *Cats have a limited ability to biotransform acetaminophen and may succumb to a single dose.*

Propionic Acid Derivatives

CARPROFEN

Carprofen is a propionic acid derivative NSAID that has been approved for oral use in dogs. Carprofen has been approved for oral and injectable use in dogs and cats in Europe. It has a half-life of 8 hours

and is thought to work by inhibiting COX. An injectable form is now available for use in the United States as well.

Clinical Uses

Uses include the relief of pain associated with degenerative joint disease and postoperative pain resulting from soft tissue or orthopedic repair.

Dosage Forms

1. Carprofen (Rimadyl). Available in tablets, caplets, injection, and chewable tablets.
2. Carprofen (Novox) Caplets

Adverse Side Effects

Side effects such as gastrointestinal ulceration and bleeding are apparently rare with this agent.

KETOPROFEN

Ketoprofen is a propionic acid derivative with analgesic, antipyretic, and antiinflammatory activities. It is labeled for use in horses in the United States but has been used a great deal in dogs and cats in Europe and Canada.

Clinical Uses

In horses, ketoprofen is used for treatment of pain and inflammation associated with musculoskeletal disorders. It has been used for postoperative and chronic pain in dogs and cats.

Dosage Forms

1. Ketofen (horses)
2. Orudis (human label)

Adverse Side Effects

Side effects may include gastrointestinal bleeding or ulceration, renal dysfunction, and generalized bleeding.

NAPROXEN

Naproxen is a propionic acid derivative that is similar to ketoprofen and ibuprofen. It is labeled for use in horses, although it has been used in dogs.

Clinical Uses

Naproxen is labeled for the "relief of pain, inflammation, and lameness associated with myositis and

other soft tissue diseases of the musculoskeletal system of horses."

Dosage Forms

1. Equiproxen (horses)
2. Naprosyn (human)

Adverse Side Effects

Few side effects are reported in horses. GI ulceration has been reported in dogs.

IBUPROFEN

Ibuprofen is reported to have the potential for serious side effects in dogs and cats and is not recommended for use in these species.

Other Nonsteroidal Antiinflammatory Drugs

Etodolac

Etodolac is an indole acetic acid derivative NSAID that has been labeled for use in dogs.

Clinical Use

This drug is labeled for the management of pain and inflammation associated with osteoarthritis in dogs.

Dosage Form

EtoGesic

Adverse Side Effects

Side effects include anorexia, vomiting, diarrhea, and lethargy.

Deracoxib

Deracoxib is an analgesic and a nonsteroidal anti-inflammatory agent of the coxib class.

Clinical Use

Deracoxib is labeled for the control of pain and inflammation associated with orthopedic surgery in dogs with 4 lb body weight or greater, and for the control of pain and inflammation associated with osteoarthritis in dogs weighing 14 lb or more.

Dosage Form

Deramaxx

Firocoxib

Firocoxib is an NSAID that belongs to the coxib class.

Clinical Uses

The labeled use is for the treatment of pain and inflammation associated with osteoarthritis in dogs.

Dosage Form

Previcox Chewable Tablets with once-daily dosing

Tepoxalin

Tepoxalin is a nonsteroidal antiinflammatory drug for oral use in dogs only. The manufacturer claims that this product is the only NSAID that blocks both arms of the arachidonic acid cascade (COX and lipooxygenase). It is manufactured as a “rapidly disintegrating” tablet that breaks down quickly upon contact with the moisture of the animal’s mouth and cannot be spit out. This dosage form is designed to improve owner/animal dosage compliance.

Clinical Use

Tepoxalin is labeled for the control of pain and inflammation associated with osteoarthritis in dogs.

Dosage Form

Zubrin

Meloxicam

Meloxicam is a COX-2 receptor NSAID. It has antiinflammatory, analgesic, and antipyretic properties.

Clinical Uses

Meloxicam is used to control pain associated with surgical procedures, arthritis, and other causes. Metacam use in cats is limited to one-time subcutaneous injection for surgical pain.

Dosage Forms

Metacam Oral Suspension, 1.5 mg/ml
Metacam Injection for Cats, 5 mg/ml
Metacam Injection for Dogs, 5 mg/ml

Adverse Side Effects

Similar to other NSAIDs; other agents that are classified as NSAIDs or that have similar activity include those discussed in the following paragraphs

Polysulfated Glycosaminoglycan (Adequan)

Adequan is a semisynthetic mixture of glycosaminoglycans derived from bovine cartilage. This drug reduces degenerative changes induced by noninfectious or traumatic joint disease and promotes activity in the synovial membrane. It is available in intraarticular and intramuscular forms and is labeled for use in horses and dogs.

Hyaluronate Sodium (Hyalovet)

Hyalovet is a glycosaminoglycan that is labeled for intraarticular injection. It has activities similar to that of Adequan.

Legend

A solution of hyaluronate that may be given by intravenous or intraarticular injection for synovitis associated with osteoarthritis

Meclofenamic Acid (Arquel Granules)

This NSAID is labeled for oral treatment of acute or chronic inflammatory disease in horses.

Selenium and Vitamin E (Seletoc)

Seletoc is labeled for relief of acute symptoms of arthritic conditions in dogs.

Ketorolac

Ketorolac is an NSAID with efficacy similar to that of morphine. It carries a human label and may cause serious side effects.

Orgotein (Palosein)

Palosein is labeled for acute and chronic inflammatory conditions in horses and dogs.



Opioid Analgesics

Opioids and opioid receptors are discussed in a general fashion in Chapter 4. This section addresses only use of opioids to control pain.

Opioids relieve pain by binding with specific receptor sites in the brain, spinal cord, and peripheral tissue. By altering neurotransmitter release, they alter nerve impulse formation and transmission at many levels within the CNS. The ultimate effect is that the opioids block or inhibit pain impulses to higher CNS centers responsible for the perception of pain.

Opioid Agonists

Opioid agonists remain one of the most effective drug classes for relieving moderate to severe pain (Paddleford, 1999). Opioid agonists are drugs that bind with all opioid receptor sites and produce opioid effects and respiratory depression, sedation, and addiction. Opioid agonists include alfentanil, carfentanil, codeine, etorphine, fentanyl, hydromorphone, meperidine, methadone, morphine, oxymorphone, and sufentanil. Even though some of these drugs are considered more potent than morphine, morphine is still considered to be one of the most effective of the opioids. All agonists are C-II controlled substances.

Clinical Uses

Opioid agonists are used to control moderate to severe pain in animals.

Selected Dosage Forms

1. Morphine sulfate (Infumorph, Astramorph PF) (human labels)
2. Oxymorphone (Numorphan)
3. Meperidine (Demerol)
4. Codeine (codeine phosphate, codeine sulfate, Tylenol with codeine)
5. Fentanyl transdermal (Duragesic)
6. Tramadol (Ultram)—synthetic Mu receptor opiate (noncontrolled)

Adverse Side Effects

Side effects can include respiratory depression, sedation, excitement, and addiction. Cats are more sensitive to the excitatory effects of opioid agonists than are other species, and they tolerate low doses well.

TRANSDERMAL FENTANYL USE

Transdermal application of fentanyl has been successfully used in humans for control of chronic pain. This use has recently been adapted for control

of postoperative and chronic pain in dogs and cats (extralabel).

Care must be taken when using transdermal patches to ensure that the animal does not eat or lick the patch (causing possible overdose), and that accidental exposure to humans (especially children) does not occur. To apply the patch, gloves should be worn; the skin over the dorsum of the neck should be clipped, cleansed, and allowed to dry well; good skin contact with the patch should be achieved; and a snug bandage should be applied to hold the patch in place. The patch should never be cut because this interferes with the rate of release of fentanyl. The patch should be carefully disposed of after use.

Opioid Agonists-Antagonists

The opioid agonist-antagonist drugs bind with opioid kappa receptors but antagonize opioid mu receptors. Opioid agonists-antagonists include butorphanol (C-IV), pentazocine (C-IV), and nalbuphine. These drugs are considered effective for mild to moderate pain and have few side effects.

Clinical Uses

The primary use is for the relief of mild to moderate pain.

Dosage Forms

1. Butorphanol (Torbugesic, Torbutrol, Stadol)
2. Pentazocine (Talwin-V)
3. Nalbuphine (Nubain)

Adverse Side Effects

Side effects include sedation, ataxia, and salivation (pentazocine).

Opioid Partial Agonists

The opioid partial agonists bind with the mu receptors but only partially activate them. Buprenorphine is the primary drug in this category. Recent studies have shown that buprenorphine may be effectively administered to cats by the sublingual/buccal route (Robertson, 2001).

Clinical Uses

Uses include relief of mild to moderate pain in dogs and horses.

Dosage Form

Buprenex (human label)

Adverse Side Effects

Side effects include sedation and respiratory depression.

Other Pain Control Agents

Ketamine, alpha-2-adrenergic agents, lidocaine, benzodiazepines, and tricyclic antidepressants (Elavil) are other agents that are used frequently to modulate pain (see Chapter 4). These agents may be used alone or in combination with others. Some agents are delivered as a constant rate infusion (CRI) for the sustained control of pain. A common CRI for pain control involves the combination of morphine and ketamine (MK) or morphine, lidocaine, and ketamine (MLK).

**Antihistamines**

Antihistamines are drugs that are used to inhibit the effects or spread of the inflammatory process. These drugs do not inhibit the formation of prostaglandins or other inflammatory mediators. They work by preventing histamine from combining with tissue receptors or by displacing histamine from receptor sites.

Because histamine is a major chemical mediator of the allergic response, antihistamines may be useful in controlling allergic responses.

Histamine is a chemical that is released from mast cells when they are adequately stimulated by immunoglobulin E (IgE) antibodies to allergens (Figure 14-3). Histamine then combines with tissue receptors and causes dilation of small blood vessels, increased permeability of capillaries, smooth muscle spasm, and increased secretion of glands. Two types of antihistamine receptors have been identified: H_1 and H_2 .

Antihistamines competitively block the binding of histamine to H_1 receptors, which may block progression of the allergic response. Some antihistamines also block H_2 receptors that may contribute to motion sickness or nausea. Some antihistamines have a high affinity for H_1 receptors in the brain and cause a sedative effect.

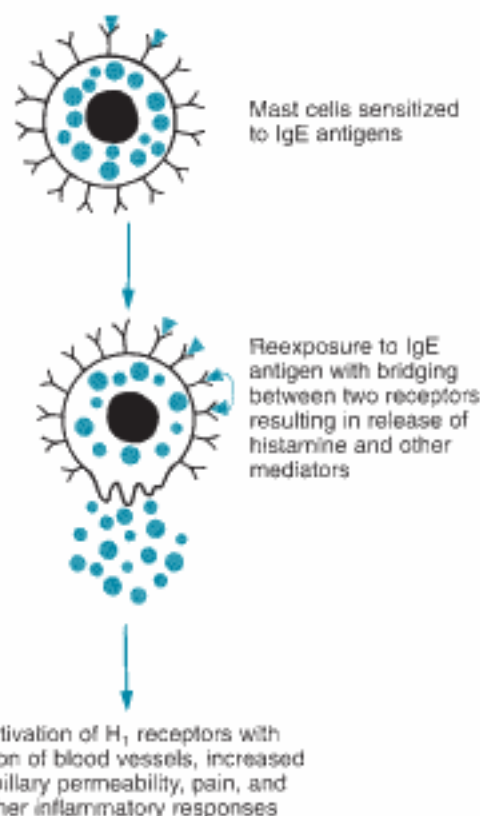
**FIGURE 14-3**

The release of histamine from mast cells when stimulated by immunoglobulin (IgE) antibodies.

Stimulation of H_2 receptors causes increased flow of hydrochloric acid by the gastric mucosa. H_2 blockers reduce the secretion of hydrochloric acid and may be used to treat gastrointestinal irritation and ulceration.

Clinical Uses

Antihistamines are used to treat the following:

1. Pruritus
2. Urticaria and angioedema associated with acute allergic reactions
3. Laminitis in horses and cattle
4. "Downer" cow syndrome
5. Motion sickness
6. "Reverse sneeze" syndrome
7. Anaphylactic shock
8. Upper respiratory tract conditions

Hidden page

Hidden page

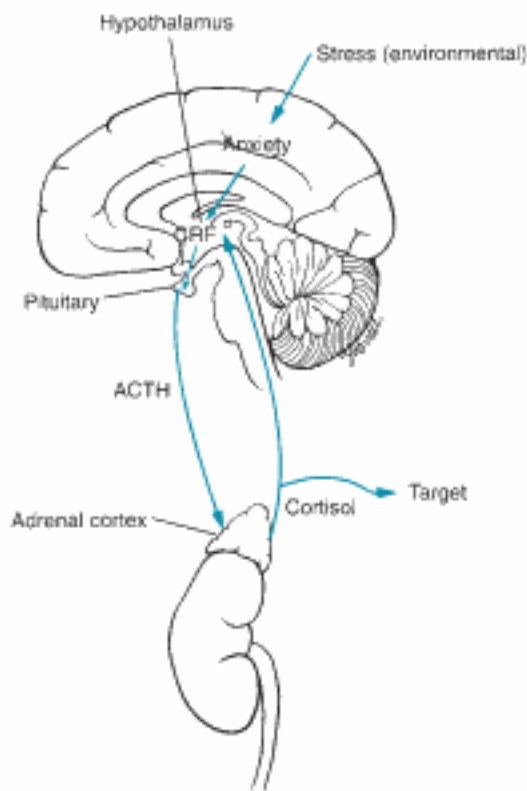

FIGURE 14-4

Release of corticosteroids is under the control of the hypothalamic-pituitary-adrenal (HPA) axis.

stimulate the hypothalamus—through impulses from higher brain centers—to release CRF. The control mechanism then proceeds in the fashion illustrated in Figure 14-4.

One of the major indications for the clinical use of corticosteroids is for their antiinflammatory effects. These effects are brought about by their ability to block the enzyme phospholipase, which promotes the reaction that results in the formation of prostaglandin—a primary mediator of the immune response. Corticosteroids also protect cells from inflammatory trauma by various mechanisms that include but are not limited to the following:

1. Stabilizing cell membranes to help prevent their breakdown
2. Stabilizing lysosomal membranes so they do not release their harmful enzymes
3. Disrupting histamine synthesis

4. Inhibiting interleukin synthesis
5. Reducing exudative processes

Corticosteroids are also used clinically for their immunosuppressive effects. They are used to suppress the immune system in allergic conditions such as flea allergy dermatitis, atopy, autoimmune hemolytic anemia, rheumatoid arthritis, and uveitis. The immunosuppressive effect comes from the ability of corticosteroids to do the following:

1. Inhibit antibody formation
2. Decrease the concentrations of lymphocytes and eosinophils
3. Suppress the migration of neutrophils
4. Inhibit phagocytosis

Although immunosuppressive qualities are very useful clinically, they can also mask the signs of serious infection that are simultaneously present.

Corticosteroids are useful in the treatment of lymphoid tumors because they cause a direct lymphotoxic effect (Barton, 2001).

All steroid compounds are synthesized from a basic parent compound that has been described as resembling three rooms and a bath (Figure 14-5). Steroids are formed in three regions of the adrenal gland. Those regions and their respective products include the following:

1. Zona glomerulosa—mineralocorticoids
2. Zona fasciculata—glucocorticoids
3. Zona reticularis—sex hormones (androgen and estrogen)

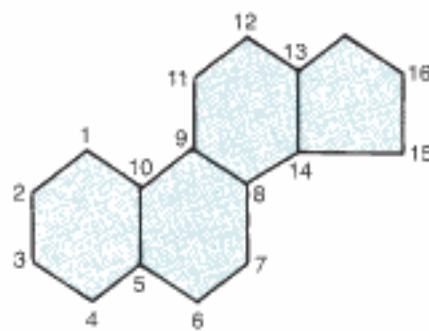

FIGURE 14-5

The configuration of the parent molecule of all steroid molecules, including corticosteroids.

Hidden page

Hidden page

Hidden page

4. Lidocaine hydrochloride injection
5. Other generic local anesthetics, including tetracaine and dibucaine

Topical

1. Ophthaine Solution Veterinary
2. Ophthetic

Adverse Side Effects

Local anesthetics can have adverse side effects if the total maximum dose for the species being treated is exceeded. Side effects may include restlessness, excitement, hypotension, and seizures.

Technician's Notes

1. Lidocaine with epinephrine should never be used if an antiarrhythmic is indicated.
2. Exceeding the total recommended dose of local analgesics may cause toxicity.

REFERENCES

- Barton CL: Chemotherapy. In Boothe DM, editor: Small animal clinical pharmacology and therapeutics, Philadelphia, 2001, WB Saunders.
- Boothe DM: Control of pain in small animals. In Small animal clinical pharmacology and therapeutics, Philadelphia, 2001, WB Saunders.
- Ganong WF: Cutaneous, deep, and visceral sensation. In Ganong WF, editor: Review of medical physiology, ed 21, New York, 2003, McGraw-Hill.
- Kamerling SG: Pain recognition and relief. In Proceedings of the Annual Meeting of the American Veterinary Medical Association, Boston, 2001.
- Langston VC, Mercer HD: Non-steroidal anti-inflammatory drugs. In Proceedings of the 17th Seminar for Veterinary Technicians, The Western Veterinary Conference, Las Vegas, 1988.
- Paddleford RR: Analgesia and pain management. In Manual of small animal anesthesia, Philadelphia, 1999, WB Saunders.
- Robertson SA: Systemic uptake of buprenorphine after buccal administration in cats. In Proceedings of the Annual Meeting of the College of Veterinary Anesthesiologists, New Orleans, 2001.



REVIEW QUESTIONS

1. Pain sensation arises in free nerve endings called _____.
2. List some signs associated with pain in animals.

3. NSAIDs that selectively inhibit _____ are thought to produce fewer gastrointestinal side effects.
4. What is the most common side effect of the NSAIDs? _____
5. Why are cats so susceptible to aspirin overdose? _____
6. Phenylbutazone should be administered parenterally by the SQ route only.
 - a. True
 - b. False
7. What C-II opioid is administered via transdermal patch? _____
8. Corticosteroid therapy involves treatment of the signs of disease and often cures the disease as well.
 - a. True
 - b. False
9. What function do mineralocorticoids serve in the body? _____
10. List some principles that should be followed concerning corticosteroid therapy.

11. What does the term *iatrogenic* mean? _____
12. Describe the side effects of short-term and long-term corticosteroid use.

13. What is the mechanism of action of local anesthetic agents? _____
14. What are some indications for the use of local anesthetics? _____
15. The body is able to produce its own opiate-like analgesic agents called _____.
 - a. histamine
 - b. endorphins
 - c. prostaglandins
 - d. cytokines
16. A substance that can initiate a fever is called a _____.
 - a. prostaglandin
 - b. endorphin
 - c. pyrogen
 - d. pyometra
17. _____ is also known as acetylsalicylic acid.
 - a. Phenylbutazone
 - b. Aspirin
 - c. DMSO
 - d. Acetaminophen
18. _____ is a pyrazolone derivative.
 - a. Phenylbutazone
 - b. Carprofen
 - c. Etodolac
 - d. Deramaxx
19. Flunixin meglumine is a(an) _____.
 - a. propionic acid derivative
 - b. antihistamine
 - c. muscle relaxant
 - d. NSAID
20. DMSO causes _____ when applied topically.
 - a. vasoconstriction
 - b. vasodilation
21. _____ is considered (even today) to be one of the most effective of the opioids.
 - a. Fentanyl
 - b. Morphine
 - c. Tepoxalin
 - d. Carprofen

22. _____ is(are) a major chemical mediator(s) of the allergic response.
- Histamine
 - Prostaglandins
 - Pyrogens
 - Hormones
23. All of the following are types of corticosteroids except _____.
- dexamethasone
 - Predef
 - Vetalog
 - ketoprofen
24. A local anesthetic such as lidocaine may be a drug of choice when an epidural is performed to replace a prolapsed uterus in a bovine.
- True
 - False

Principles of Fluid Therapy

Indications for Fluid Therapy

Fluid Balance

History, Physical Examination, and
Laboratory Findings

Determining the Amount of Fluid to
Administer

Routes of Fluid Administration

Rate of Administration

Monitoring Fluid Administration

Preparing Fluid Administration Equipment

**Types of Solutions Used in Fluid
Therapy**

CRYSTALLOID SOLUTIONS

Physiologic Saline

Lactated Ringer's Solution

Dextrose 5% in Water

Ringer's Solution

2.5% Dextrose in Half-Strength (0.45%)

Saline/Potassium Added

Multisol-R/Normosol-R

Normosol-M in 5% Dextrose

Plasma-Lyte/Plasma-Lyte M in 5%
Dextrose

COLLOID SOLUTIONS

HYPERTONIC SOLUTIONS

FLUID ADDITIVES

Sodium Bicarbonate

Potassium Chloride

Calcium Supplements

50% Dextrose

Vitamin Supplements

Oral Electrolyte Preparations

Parenteral Nutrition

Parenteral Vitamin/Mineral Products

WATER-SOLUBLE VITAMINS

Vitamin B Complex

Thiamine Hydrochloride (Vitamin B₁)

Vitamin B₁₂ (Cyanocobalamin)

FAT-SOLUBLE VITAMINS

Vitamin A

Vitamin D

Vitamin E

Vitamin K

CHAPTER **15**

**Therapeutic Nutritional,
Fluid, and Electrolyte
Replacements**

LEARNING OBJECTIVES

After studying this chapter, you should be able to:

1. Define terms related to fluid, electrolyte, and selected therapeutic nutritional preparations.
2. Describe the distribution of water in the body.
3. Describe the composition of body and therapeutic fluids.
4. Define osmotic pressure and tonicity as they apply to fluids.
5. Discuss the basic principles of fluid therapy.
6. Describe fluid equipment and its use.
7. Categorize and provide examples of the fluids used in fluid therapy.
8. List and describe selected fluid additives.
9. List and describe selected oral electrolyte preparations.
10. List and describe selected parenteral vitamin-mineral products.



KEY TERMS

BUFFER A substance that decreases the change in pH when an acid or base is added.

COLLOID A chemical system composed of a continuous medium throughout which small particles are distributed and do not settle out under the influence of gravity.

DISSOCIATION The act of separating into ionic components ($\text{NaCl} \rightarrow \text{Na}$ and Cl).

ELECTROLYTE A substance that dissociates into ions when placed in solution, becoming capable of conducting electricity.

EMPIRICAL Based on observation and personal experience.

HYPERKALEMIA An excess of potassium in the blood.

HYPERNATREMIA An excess of sodium in the blood.

HYPOKALEMIA A deficiency of potassium in the blood.

HYPONATREMIA A deficiency of sodium in the blood.

HYPVOLEMIA Decreased volume of circulating blood.

METABOLIC ACIDOSIS Decreased body pH caused by excess hydrogen ions in the extracellular fluid.

METABOLIC ALKALOSIS Increased body pH caused by excess bicarbonate in the extracellular fluid.

ONCOTIC PRESSURE The osmotic pressure generated by plasma proteins in the blood.

SOLUTE A substance dissolved in a solvent to form a solution.

TOTAL NUTRIENT ADMIXTURE A solution used for parenteral administration that contains amino acids, lipids, dextrose, vitamins, and minerals.

TRANSCELLULAR FLUID Cerebrospinal fluid, aqueous humor of the eye, synovial fluid, gastrointestinal fluid, lymph, bile, and glandular and respiratory secretions.

TURGOR Degree of fullness or congestion; describes the degree of elasticity of the skin.

INTRODUCTION

Veterinary technicians often have an important role in fluid, electrolyte, and therapeutic nutritional therapy. They administer parenteral or oral fluid or nutritional products and monitor patients' responses under the direction of a veterinarian. Because the use of these products can be critically important to the outcome of a case, technicians should have a thorough knowledge of the products and their use.

ANATOMY, PHYSIOLOGY, AND CHEMISTRY

Distribution of Body Water and Electrolytes

Measurements of total body water (TBW) have shown that water represents 50% to 70% of the total body weight in adult animals; 60% is often used as the average figure. As much as 80% of a neonatal animal's body weight may be water—a factor that makes fluid loss in young animals potentially very serious. An increase in body fat decreases the amount

of TBW and makes it important to estimate fluid needs on the basis of lean body mass to avoid overhydration.

TBW is distributed in several compartments within the body (Figure 15-1). Sixty percent of TBW is found within cells and is called *intracellular fluid (ICF)*. ICF makes up 40% of total body weight. The other 40% of TBW is found outside the cells and is called *extracellular fluid (ECF)*. ECF accounts for 20% of total body weight.

ECF (discounting the relatively small **transcellular fluid** component) distributes itself between the interstitial fluid (15% of body weight) and the intravascular fluid or plasma (5% of body weight).

Body fluid compartments should be thought of as volumes of fluid and electrolytes in dynamic equilibrium, with fluids and electrolytes moving back and forth across semipermeable cell membranes. Changes in the quantity of fluid or electrolytes in one compartment usually result in changes in these quantities in other compartments. Fluids administered intravenously to an animal first enter the intravascular

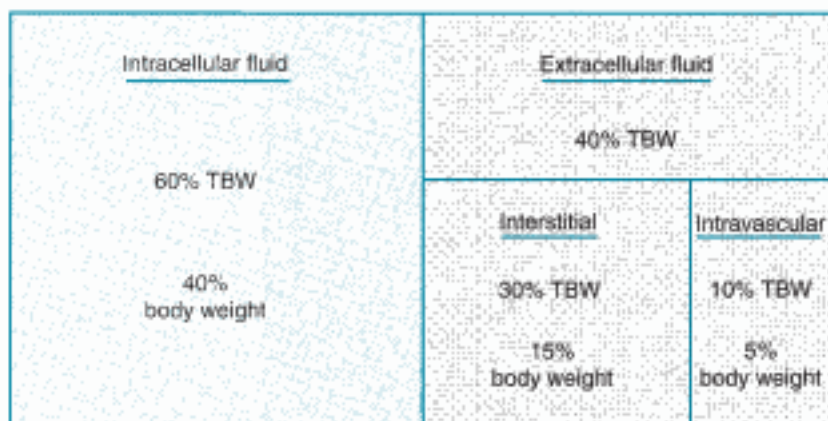

FIGURE 15-1

Body fluid compartments. TBW, Total body water.

space of the ECF, move into the interstitial space, and then enter the ICF (Figure 15-2). In most cases, loss of fluid occurs first from the ECF and then from other compartments.

Composition of Body and Therapeutic Fluids

Body water contains an array of **solute**s that vary in quantity from compartment to compartment. A solute is a substance that dissolves in a solvent; this solvent is usually water in biologic systems. The molecules of substances called **electrolytes** break down (dissociate) into charged particles called **ions**. Electrolytes are positively charged (cations) or

negatively charged (anions). The number of cations always equals the number of anions in normal animals (Table 15-1). In the ECF, the most abundant cation is sodium, and the most abundant anions are chloride and bicarbonate. In the ICF, the major cations are potassium and magnesium, and the major anions are phosphates and proteins. Therapeutic fluids are described as balanced if they resemble ECF in composition and unbalanced if they do not. Lactated Ringer's solution is an

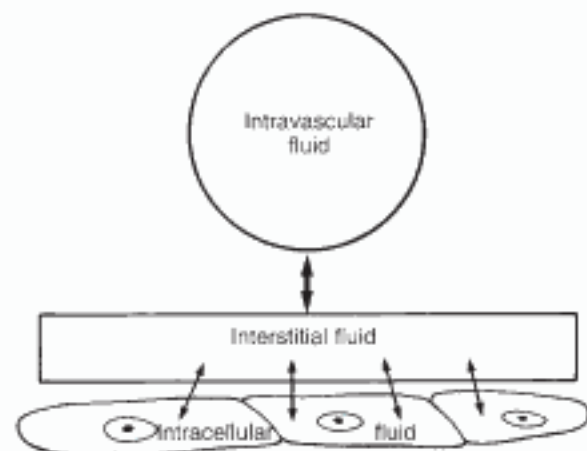

FIGURE 15-2

Schematic showing movement of fluid between compartments.

Table 15-1 Composition of Plasma and Interstitial Fluid

Ion	Plasma (mEq/L)	Interstitial Fluid (mEq/L)
Cations		
Na ⁺	142	145.1
K ⁺	4.3	4.4
Ca ²⁺	2.5	2.4
Mg ²⁺	1.1	1.1
Total	149.9	153.0
Anions		
Cl ⁻	104	117.4
HCO ₃ ⁻	24	27.1
H ₂ PO ₄	2	2.3
Protein	14	(none)
Other	5.9	6.2
Total	149.9	153.0

Hidden page

Table 15-2 Composition of Solutions Used in Fluid Therapy

	Glucose* (g/L)	Na ⁺ (mEq/L)	Cl ⁻ (mEq/L)	K ⁺ (mEq/L)
Dextrose Electrolyte Solution Composition				
5% dextrose	50	0	0	0
10% dextrose	100	0	0	0
2.5% dextrose in 0.45% NaCl	25	77	77	0
5% dextrose in 0.45% NaCl	50	77	77	0
5% dextrose and 0.9% NaCl	50	154	154	0
0.45% NaCl	0	77	77	0
0.85% NaCl (normal saline)	0	145	145	0
0.9% NaCl	0	154	154	0
3% NaCl	0	513	513	0
Ringer's solution	0	147.5	156	4
Lactated Ringer's solution	0	130	109	4
2.5% dextrose in lactated Ringer's solution	25	130	109	4
5% dextrose in lactated Ringer's solution	50	130	109	4
2.5% dextrose in half-strength lactated Ringer's solution	25	65.5	55	2
Normosol-M in 5% dextrose [†]	50	40	40	13
Normosol-R [†]	0	140	98	5
Plasma-Lyte [§]	0	140	103	10
Plasma-Lyte M in 5% dextrose [†]	50	40	40	16
Plasma	1	145	105	5
Additives and Solutions				
20% mannitol	200(M)	0	0	0
7.5% NaHCO ₃	0	893(B)	0	0
8.4% NaHCO ₃	0	1000(B)	0	0
10% CaCl ₂	0	0	2720	0
14.9% KCl	0	0	2000	2000
50% dextrose	500	0	0	0

* All glucose, with one exception: M, mannitol

† Buffers used: A, acetate; B, bicarbonate; G, gluconate; L, lactate.

‡ CEVA Laboratories.

§ Baxter Healthcare

From Chew DJ, DiBartola SP: Saunders manual of small animal nephrology and urology. Philadelphia, 1986, WB Saunders Co.

Ca ²⁺ (mEq/L)	Mg ²⁺ (mEq/L)	Buffer† (mEq/L)	Osmolarity (mOsm/L)	kcal/L	pH
0	0	0	252	170	4.0
0	0	0	505	340	4.0
0	0	0	280	85	4.5
0	0	0	406	170	4.0
0	0	0	560	170	4.0
0	0	0	154	0	5.0
0	0	0	290	0	5.0
0	0	0	308	0	5.0
0	0	0	1026	0	5.0
4.5	0	0	3.10	0	5.5
3	0	23(L)	272	9	6.5
3	0	28(L)	398	94	5.0
3	0	28(L)	524	179	5.0
1.5	0	14(L)	263	89	5.0
0	3	16(A)	364	175	5.5
0	3	27(A)	296	18	6.4
		23(G)			
5	3	47(A)	312	17	5.5
		8(L)			
5	3	12(A)	376	178	5.5
		12(L)			
5	3	24(B)	300	—	7.4
0	0	0	1099	—	
0	0	893(B)	1786	0	
0	0	1000(B)	2000	0	
1360	0	0	4080	0	
0	0	0	4000	0	
0	0	0	2780	1700	4.2

Hidden page

Fluid Balance

In normal animals, the intake of fluid and electrolytes is adjusted to offset losses that occur. Sources of water intake include (1) water that is drunk, (2) water that is ingested in food, and (3) water that results from the metabolism of food (metabolic water). Normal routes of water loss include (1) urine, (2) fecal water, (3) sweat (horses), and (4) respiration. Respiratory loss potentially can be important in dogs because of panting, and sweating can be important in horses. Fluid losses are frequently characterized as sensible—those that can be measured easily (e.g., urine), and insensible—those that cannot be measured easily (e.g., fecal and respiratory losses).

Decreased fluid intake often accompanies anorexia, and increased fluid loss occurs in disease states that cause polyuria, vomiting, and diarrhea. Third-space shifts of body water occasionally may cause quantities to be taken out of circulation as they are trapped in body cavities or lost through skin lesions (e.g., intestinal obstruction, body cavity effusions, hemorrhage). Extensive burns, which are uncommon in veterinary medicine, also can cause extensive fluid loss.

History, Physical Examination, and Laboratory Findings

A patient's history provides important information about the route and extent of water intake and loss. Knowing the route of loss can aid a clinician in determining the type of fluid to use to correct dehydration and electrolyte imbalances. Table 15-3 lists various causes of dehydration and the fluid indicated for treating each condition. For example, acute vomiting leads to loss of potassium and chloride ions, whereas acute diarrhea causes primarily a potassium loss.

The physical examination provides important information about the extent of fluid loss. The skin **turgor** test, along with other physical findings, is used to determine the percentage of body weight that has been lost via fluid (Table 15-4). The skin turgor test is performed by pinching up a fold of skin over the thoracic or lumbar area and then determining how long it takes to return to a normal position. If the neck area is used in small

animals, the extra skin may cause misleading results. The point of the shoulder should be used in horses because the skin of the neck area can again be misleading. The longer the skin takes to return to normal, the greater the degree of dehydration. Animals with little body fat may appear to be more dehydrated than they really are (slow return to normal skin position) because of low body fat levels, whereas obese animals may appear to be well hydrated when they are not because increased fat increases skin elasticity. The presence of dry mucous membranes; an increased heart rate; weak, thready pulses; reduced jugular distention (especially in horses); and a reduced capillary refill time all may be indicators of dehydration. Because most of the evaluations mentioned earlier are subjective, simple laboratory tests may be performed to aid in assessing hydration status.

Simple laboratory tests that can aid in evaluating hydration status are packed cell volume (PCV), total plasma protein (TPP) determination, and urine specific gravity. Dehydration generally results in an increase in PCV, TPP, and urine specific gravity. Because anemia can make a dehydrated patient appear to be normally hydrated, PCV always should be evaluated with TPP. Readers should consult more advanced references for interpretation of laboratory findings related to hydration status.

Determining the Amount of Fluid to Administer

Three values that are calculated to determine the volume of fluid to administer are (1) the hydration deficit, (2) the maintenance requirement, and (3) the contemporary (ongoing) losses.

The hydration deficit, which is the amount of fluid that must be replaced to bring the animal back to a normal hydration status, is calculated by multiplying the percentage of dehydration by the patient's normal body weight. The percentage of dehydration is estimated from the history, physical examination, and laboratory findings. The saying, "A pint is a pound the world around" can then be applied because a pint is roughly equivalent to 500 ml. For example, if a 22-lb beagle is determined

Table 15-3 Fluid and Electrolyte Disorders and Fluids Used in Their Correction

Abnormality	Type of Dehydration	Electrolyte Balance	Acid-Base Status	Fluid Therapy
Simple dehydration, stress, exercise	Hypertonic			Half-strength or balanced electrolyte solution; 5% dextrose solution
Heatstroke	Hypertonic	K ⁺ variable Na ⁺ variable	Metabolic acidosis	Health-strength electrolyte solution followed by balanced electrolyte solution
Anorexia	Isotonic	K ⁺ loss	Mild metabolic acidosis	Balanced electrolyte solutions; KCl
Starvation	Isotonic	K ⁺ loss	Mild metabolic acidosis	Half-strength or balanced electrolyte solutions; KCl; calories
Vomiting	Isotonic or hypertonic	Na ⁺ , K ⁺ , and Cl ⁻ loss	Metabolic alkalosis; metabolic acidosis chronically	Ringer's solution; 0.9% saline with KCl supplementation
Diarrhea	Isotonic or hypertonic	Na ⁺ loss K ⁺ loss chronically	Metabolic acidosis	Balanced electrolyte solution; HCO ₃ ⁻ ; KCl (if chronic)
Diabetes mellitus	Hypertonic	K ⁺ loss	Metabolic acidosis	Balanced electrolyte solution; KCl
Hyperadrenocorticism	Isotonic	K ⁺ loss	Occasionally mild metabolic alkalosis	Balanced electrolyte solutions; KCl
Hypoadrenocorticism	Isotonic or hypertonic	Na ⁺ loss K ⁺ retention	Metabolic acidosis	0.9% saline followed by balanced electrolyte solutions
Urethral obstruction	Isotonic or hypertonic	K ⁺ retention Na ⁺ , Cl ⁻ variable	Metabolic acidosis	0.9% saline followed by balanced electrolyte solutions; KCl post-obstruction
Acute renal failure	Isotonic or hypertonic (with vomiting)	K ⁺ retention Na ⁺ , Cl ⁻ variable	Metabolic acidosis	Balanced electrolyte solutions
Chronic renal failure	Isotonic or hypertonic (with vomiting)	Na ⁺ , K ⁺ , Cl ⁻ variable	Metabolic acidosis	Balanced electrolyte solutions
Congestive heart failure	Plethoric (Na ⁺ , H ₂ O retention early); hypotonic chronically	Na ⁺ retention (but dilutional hyponatremia)	Metabolic acidosis (chronically)	5% dextrose solution
Hemorrhagic shock	Isotonic		Metabolic acidosis	Balanced electrolyte solutions; blood
Endotoxic shock	Isotonic		Metabolic acidosis	Balanced electrolyte solutions; 0.9% saline

From Muir WW, DiBartola SP: Fluid therapy. In Kirk RW, ed.: Current veterinary therapy VIII: small animal practice, Philadelphia, 1983, WB Saunders Co.

Hidden page

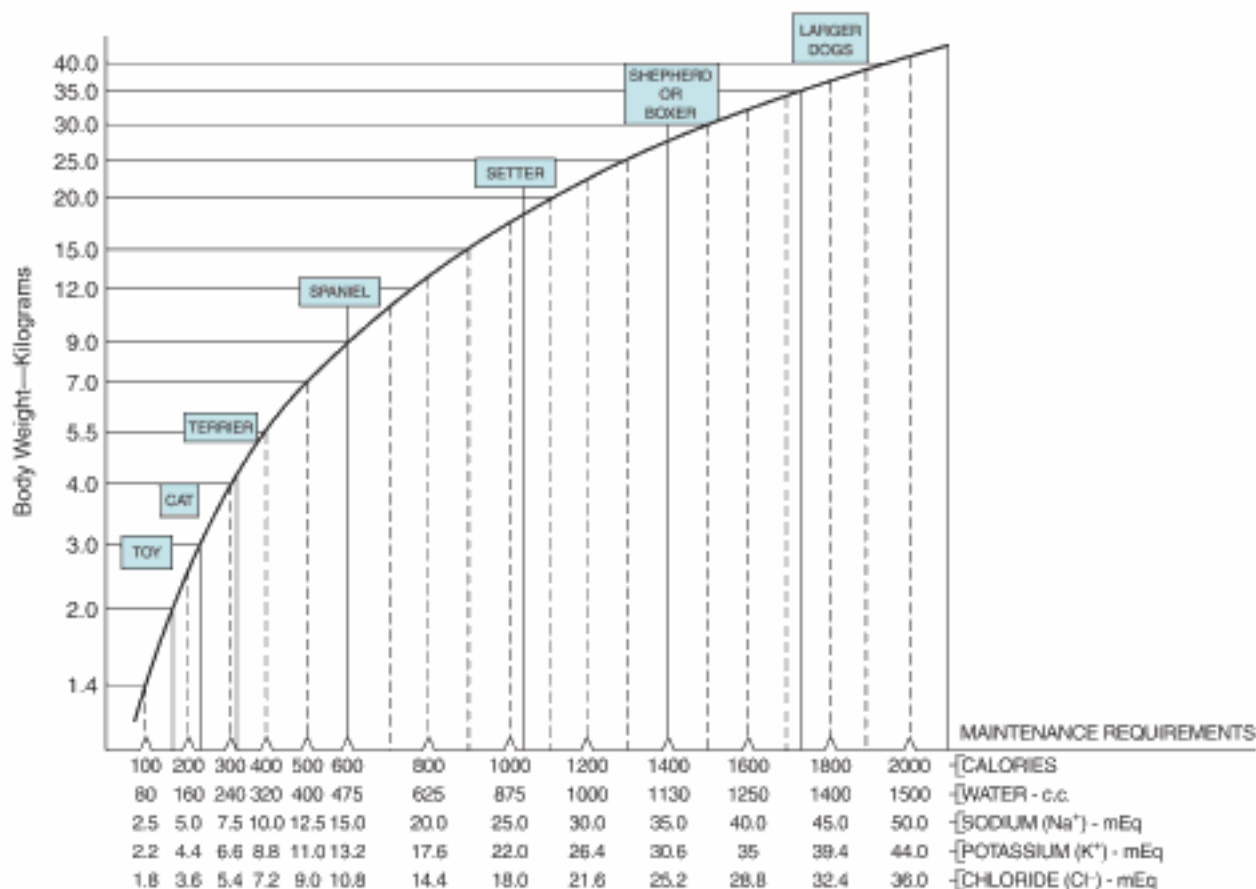

FIGURE 15-4

Daily fluid requirements. (From Harrison JB: Fluid and electrolyte therapy in small animals, JAVMA 137:637-645, 1960.)

that can be administered subcutaneously depends on the size of the animal and the amount of loose skin that it has. Between 50 and 200 ml generally can be infused at a subcutaneous site. Great care should be taken not to administer enough fluid to dissect the skin loose from its blood supply because this can cause sloughing of skin over the site. Hypertonic or irritating fluids should not be given by the subcutaneous route.

The oral route is a practical means of administering fluids as long as an animal has no severe disorders of the gastrointestinal system. This route allows normal physiologic processes to control the amount of fluid and the amount and type of electrolytes absorbed. This route is not satisfactory when large volumes of fluid must be given rapidly.

The intraperitoneal route allows for administration of large volumes of fluid, but absorption is slow. Peritonitis is a potential complication, and this route is not commonly used.

The intraosseous (femur, ilium, or humerus) route is sometimes used in very small animals or in those with poor access to veins. This route allows rapid delivery of fluids and blood but requires greater technical expertise for placing the delivery needle. Careful attention should be paid to sterile technique when this route is used, to avoid causing osteomyelitis.

Rate of Administration

Once the volume of fluid needed and the route of administration have been decided, the time frame must be established for delivering the fluids. Rapid

losses of fluid usually call for rapid replacement. In veterinary practice, fluid flow rates often are determined empirically. However, some generalizations are helpful.

For treating patients with shock, fluids should be administered rapidly (40 ml/lb/hr in dogs and 20 to 30 ml/lb/hr in cats). The use of a pressure administration cuff may allow more rapid infusion in these cases (Figure 15-5).

Fluids ideally should be infused continuously during a 24-hour period. One method of determining fluid flow rate is to calculate the hydration deficit, add maintenance and ongoing losses, and set the drip rate to administer the total during a 24-hour period. Some clinicians prefer to administer the hydration deficit during the first few hours and then to give the remainder over a longer period. Some divide the total calculated volume into three equal parts and administer each in an 8-hour period. In many practices, fluid administration can be monitored for a part of the day only. In this case, the total 24-hour fluid volume can be administered during the period that the patient can be monitored. (Common sense and medical judgment, however, must be exercised.) Portions of the total volume may be administered subcutaneously when appropriate.

Fluids are administered from plastic bags or bottles or from glass bottles through intravenous administration sets (Figures 15-6 and 15-7). Two sizes of administration sets that are commonly used in veterinary medicine are the standard macrodrip set

(15 drops/ml) and the minidrip/microdrip set (60 drops/ml). Other sizes (10 drops/ml and 20 drops/ml) are also available. Microdrip sets are suited for use in administering fluids to cats and small dogs. The size of the administration set must be known to calculate the drip or flow rate.

To calculate the drip rate, first divide the total number of milliliters to be administered by the total number of minutes for administration to determine the number of milliliters per minute to deliver. Then, multiply the milliliters per minute by the drops per milliliter of the administration set you have chosen to use, to arrive at the number of drops (gtt) per minute (gtt/min). For example, if we wish to give our beagle 1200 ml of fluid during a 24-hour period using a standard (15 gtt/ml) administration set:

$$\begin{aligned} & \frac{\text{Volume of infusion (ml)}}{\text{Time of infusion (min)}} \times \text{drop factor (gtt/ml)} \\ & = \text{gtt/min} \\ & \frac{1200 \text{ ml}}{24 \text{ hours} \times 60 \text{ min/hour}} = \frac{1200 \text{ ml}}{1440 \text{ min}} \\ & = 0.83 \text{ ml/min} \times 15 \text{ gtt/ml} = 12.5 \text{ gtt/min} \end{aligned}$$

A rate of 12.5 gtt/min can be thought of as 1 drop approximately every 5 seconds $\left(\frac{60}{12} = 5\right)$.

When standard gravity flow bags or bottles are used, drip rates are controlled by devices that are placed on the administration sets to adjust the diameter of the line (e.g., roller clamps, slide clamps, screw clamps) (Figure 15-8). The flow rate is simply dialed in on the machine when fluid infusion pumps (ml/hour) or controllers (ml/min) are used.

Monitoring Fluid Administration

Fluids administered too rapidly or in too great a volume can be life threatening. Careful monitoring of the physical status of the animal is essential. Lung sounds, skin turgor, and the overall status of the animal should be monitored regularly, along with the PCV and the TPP. When a large volume of fluids is administered rapidly, it is prudent to insert a urinary catheter to monitor urine output and establish that the kidneys are functioning normally. Some clinicians also choose to insert a jugular

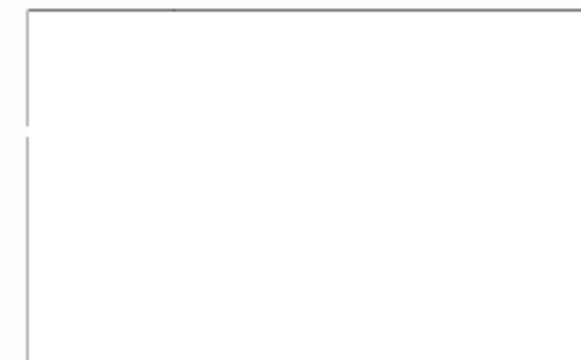
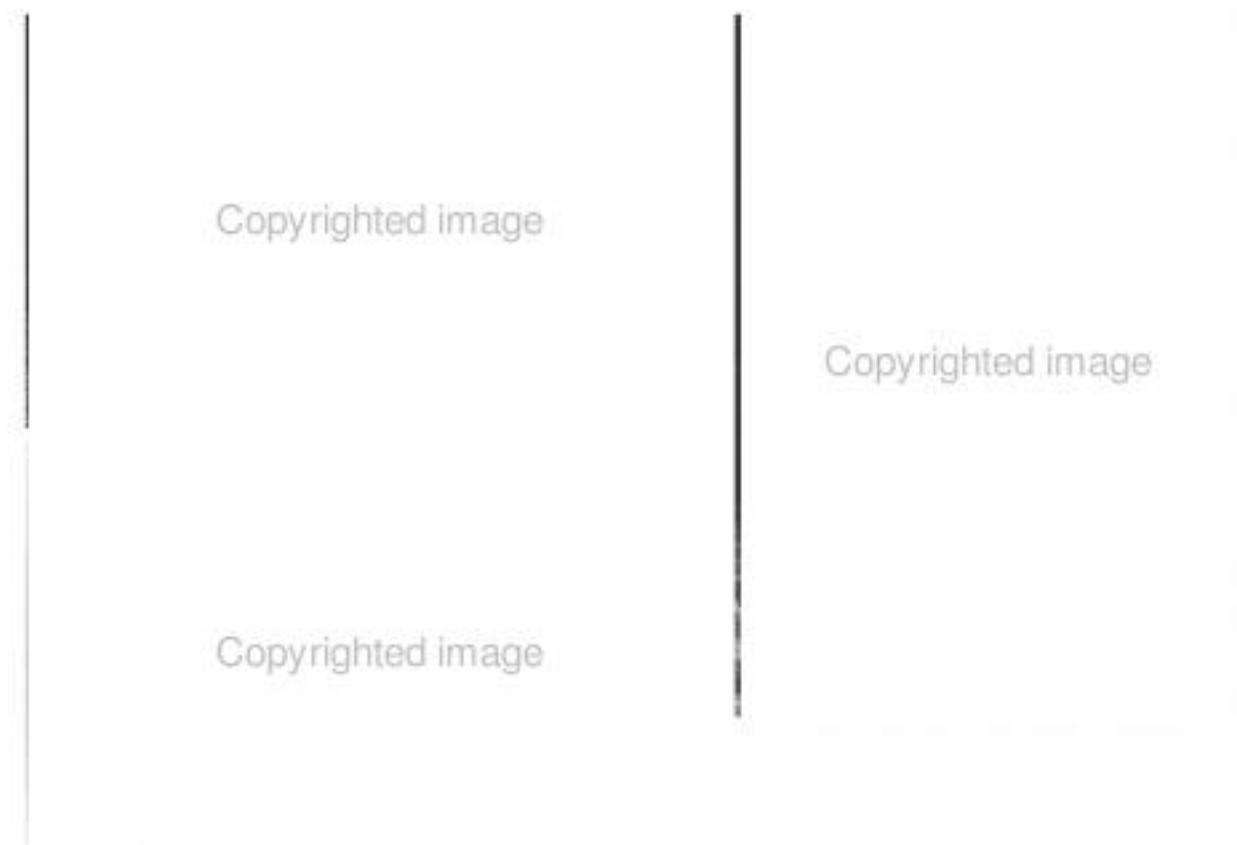

FIGURE 15-5

Pressure administration cuff (Infusible Pressure Infuser is a registered trademark of Biomedical Dynamics. Sold by Sanofi Animal Health, Inc., Overland Park, Kan.)

**FIGURE 15-6**

Types of fluid containers. **A**, RigiCare rigid plastic bottles. **B**, Glass bottles. **C**, LIFECARE flexible plastic bags. (Photo courtesy Sanofi Animal Health, Inc., Overland Park, Kan; RigiCare is a registered trademark of Sanofi Animal Health, Inc., Overland Park, Kan; LIFECARE is a registered trademark of Abbott Laboratories, Abbott Park, Ill.)

catheter to monitor central venous pressure as a way of preventing fluid volume overload.

Signs of overhydration may include restlessness, serous nasal discharge, increased lung sounds (crackles), tachycardia, dyspnea, pitting subcutaneous edema, and an increased “Jello-like” feel in the subcutaneous tissue (Haskins, 2000). Fluid infusion should be slowed or stopped and the veterinarian contacted at the first appearance of these signs.

Labeled adhesive tape should be placed vertically on fluid bottles or bags to allow monitoring of the volume delivered (Figure 15-9). Bottles or bags also should be labeled with all pertinent information, including the presence of any additives. It may be helpful to place a horizontal piece of tape across the

fluid container to indicate when fluid delivery is to be stopped.

A volume control system or Buretrol device may be used for administering small volumes of fluid (Figure 15-10). A clamp allows the volume control chamber to be filled with a predetermined amount of fluid from the bag or bottle. The line then is clamped off to prevent entry of additional fluid from the bag. The chamber can be refilled if desired.

Preparing Fluid Administration Equipment

When preparing to administer intravenous fluids, you should follow a standard protocol. After gathering your supplies and preparing the injection site,

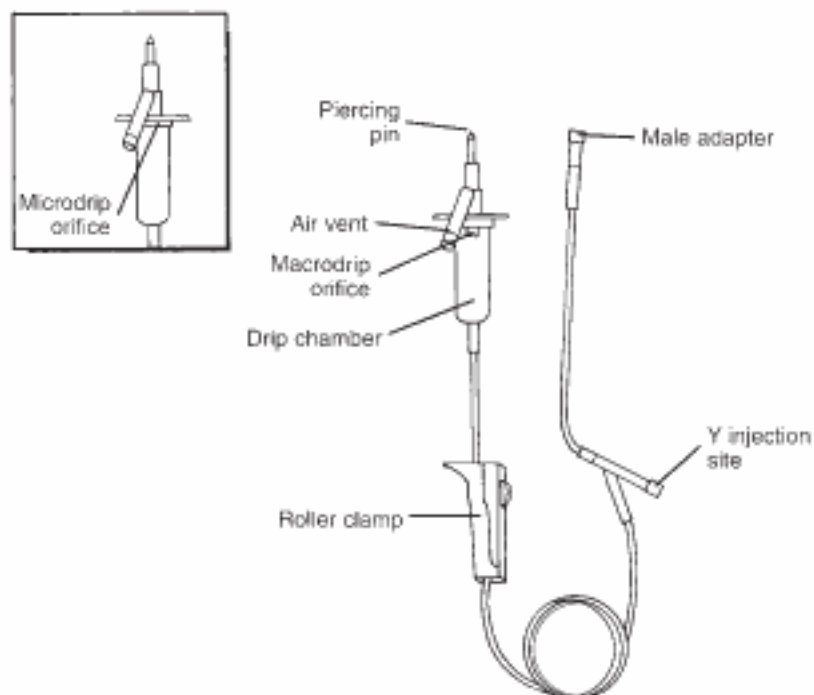

FIGURE 15-7
Intravenous administration set.

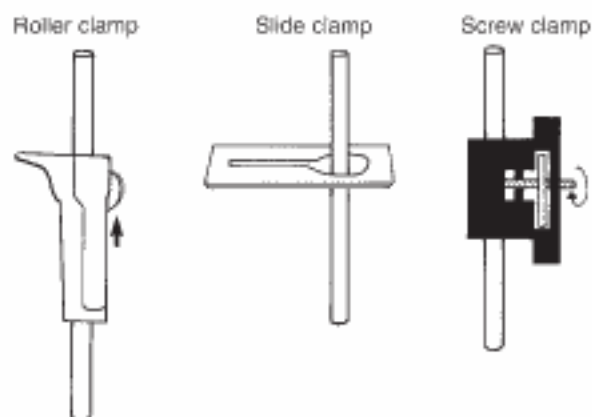

FIGURE 15-8
Clamps for controlling fluid flow.

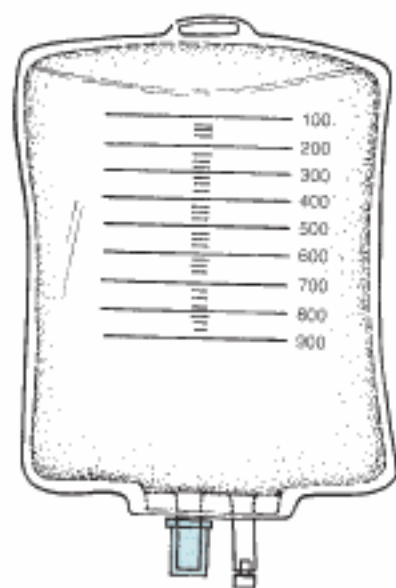

FIGURE 15-9
Labeling (vertical) of fluid bag.

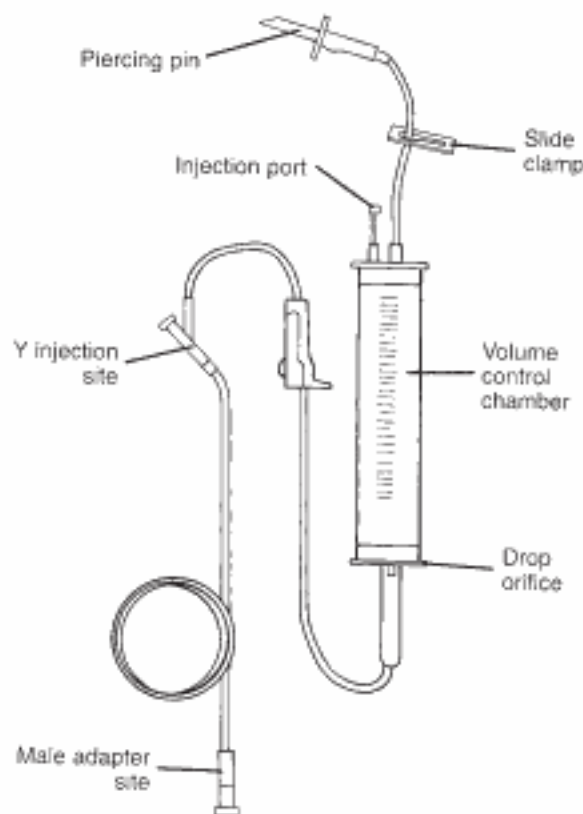

FIGURE 15-10
Volume control administration set.

check to see that you have the correct fluid type and that it is not out of date. Then, determine that the container is not cracked or chipped and that the solution is clear. Fluids should never contain precipitates or appear cloudy. After inspecting the container's cap to make sure that it is intact, remove the metal cap (bottle) or insertion port cover (bag), while taking care not to contaminate the port. Close the flow clamp on the administration set, and remove the cover from the administration set spike. Wipe the port with an alcohol swab, and insert the administration set spike into the rubber stopper (bottle) or insertion port (bag). Hang the bottle or bag, and fill the administration set line by opening the flow clamp and allowing fluid to run through the line until all bubbles are cleared. Close the flow clamp and attach the adapter to the intravenous catheter using sterile technique. After the flow clamp is opened to determine that the catheter

and the line are patent, the drip rate may be adjusted as required.

If at any time the flow rate slows or stops, check the following: (1) the catheter for correct placement and patency, (2) the position of the patient to determine whether limb position or flexion has occluded the flow, (3) the flow clamp to see whether it is in the open position, (4) the tubing to determine whether it is kinked or crimped, and (5) the fluid level in the bottle.

Two fluid solutions may be administered simultaneously with the use of a piggyback setup of the containers (Figure 15-11). The secondary bag is hung higher than the primary bag, and the secondary administration set line is connected to the Y port of the primary administration set.

It is useful for a technician to understand the use of a three-way valve. The three-way valve permits three-way connections to be made. Flow of fluid through the valve depends on the position at which the control handle is placed. The handle points toward the line that is closed. Figure 15-12 illustrates the operation of a three-way valve.

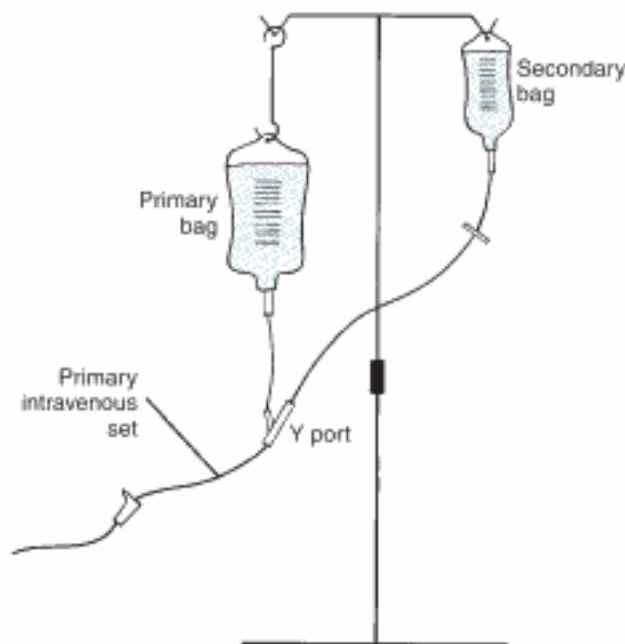

FIGURE 15-11
Piggyback setup of fluids.

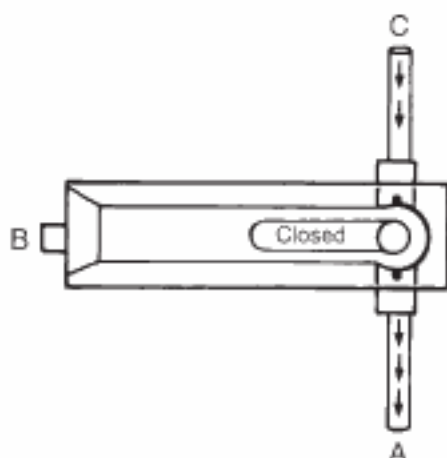

FIGURE 15-12
Operation of a three-way valve.

TYPES OF SOLUTIONS USED IN FLUID THERAPY

Crystalloid Solutions

Crystalloids are solutions that contain electrolyte and nonelectrolyte substances capable of passing through cell membranes and therefore entering all body fluid compartments. Administration of crystalloid solutions results in rapid equilibration of fluid between the intravascular and interstitial spaces. Crystalloid solutions are used routinely in veterinary medicine because of their versatility and relatively low cost. Crystalloid solutions can be classified further as replacement or maintenance solutions. Replacement solutions resemble ECF in content, whereas maintenance solutions contain less sodium and more potassium than are found in replacement fluids.

Clinical Uses

Fluids are administered for correction of dehydration, treatment of shock, maintenance of normal hydration, and replacement of electrolytes and nutrients, and as a vehicle for administration of intravenous drugs.

Dosage Forms

Dosage forms are numerous. Fluids are available in glass bottles, plastic bottles, and plastic bags that hold 250, 500, and 1000 ml. Containers that

hold 3000 and 6000 ml are available for some solutions (see manufacturer product guides). The following section briefly describes the commonly used crystalloid solutions. See Table 15-3 for a listing of the composition and other characteristics of each.

Adverse Side Effects

Adverse side effects of fluid administration are primarily associated with overhydration. Signs of overhydration may include restlessness, shivering, serous nasal discharge, coughing, and pulmonary edema.

Physiologic Saline

Physiologic saline is a 0.9% solution of NaCl and is also called *normal saline*. It also may be called *isotonic saline* because it has an osmolarity of 308 mOsm/L. Saline is used to increase plasma volume or to correct a sodium deficiency (**hyponatremia**). It also may be used to bathe tissues during surgery to prevent them from drying out. Because of its high sodium content, saline should not be used in animals with known heart disease.

Lactated Ringer's Solution

Lactated Ringer's solution is one of the most versatile and commonly used fluids in veterinary medicine. It is a balanced electrolyte replacement solution that can be administered by any route that is available. It contains 28 mEq/L of lactate, which is converted by the liver to bicarbonate to act as a **buffer** against acidosis. Theoretically, lactated Ringer's solution should not be administered with blood because the calcium contents could cause clotting to occur. Lactated Ringer's solution is not currently considered appropriate for use in critical patients (Crowe, 2007).

Dextrose 5% in Water

Dextrose 5% in water (D₅W) is a nonbalanced solution that contains only dextrose (50 g/L) and water. Administering dextrose 5% is equivalent to administering pure water because the dextrose is metabolized to carbon dioxide and water. Dextrose 5% provides approximately 170 kcal/L (a quantity that cannot be relied on to meet the daily caloric

Hidden page

plasma volume longer and has fewer side effects than the dextrans. It is prepared as a 6% solution in 0.9% saline. The primary disadvantage of hetastarch is its expense.

3. **Oxypolygelatin (Vetaplasma).** Gelatins are modified animal collagens. These molecules are denser than the dextrans and therefore produce greater osmotic action. Coagulopathy is a potential side effect.

Adverse Side Effects

Adverse side effects of colloid administration usually are related to clotting deficiencies or allergic reactions.

Technician's Notes

1. Colloids are not intended for maintenance or long-term use.
2. References should be checked in determining the appropriate flow rate for colloid solutions.

Hypertonic Solutions

This discussion is confined to the use of hypertonic saline solutions. These solutions have been advocated by some clinicians for the treatment of hemorrhagic and endotoxic shock, and for patients undergoing major surgical procedures (e.g., gastric dilation, volvulus). Similar to the colloids, hypertonic saline solutions may be useful when brain or pulmonary edema is present or is a potential complication.

Clinical Uses

Hypertonic saline solutions are used for the treatment of shock associated with trauma, endotoxemia, burns, pancreatitis, and major surgical procedures.

Dosage Forms

Hypertonic saline solutions are available from commercial sources in 3%, 4%, 5%, 7%, and 23.4% preparations.

Adverse Side Effects

These may include phlebitis, tissue irritation, re-hemorrhage in traumatic shock, electrolyte imbalances, and—when the administration rate is too fast—hypotension, bronchoconstriction, and bradycardia.

Technician's Notes

1. The rate of administration of hypertonic saline solutions is a very important consideration because exceeding this rate may cause serious side effects.
2. These solutions should be infused through a well-secured intravenous catheter to prevent extravasation of irritating fluids.

Fluid Additives

In some instances, special substances may be added to intravenous fluid solutions to enhance the solutions' therapeutic effects. These substances may be added to correct acid-base abnormalities and electrolyte imbalances, to supplement calories, and to provide supplemental vitamins to replace those washed out by fluid therapy.

Sodium Bicarbonate

Sodium bicarbonate (baking soda) is an alkalinizing agent that may be added to correct **metabolic acidosis** and certain other conditions. Because lactate or acetate in fluid preparations often cannot correct severe metabolic acidosis, supplementation becomes necessary. Normal serum bicarbonate is 24 mEq/L. Required amounts for supplementation are calculated by measuring a patient's bicarbonate (or carbon dioxide) level and subtracting that value from 24 (normal). The difference is called the *bicarbonate deficit*. The bicarbonate deficit is multiplied by 0.6 and then by the animal's weight in kilograms to determine the number of milliequivalents of sodium bicarbonate to administer:

$$\text{Bicarbonate supplementation (mEq)} = \text{Bicarbonate deficit} \times 0.6 \times \text{weight (kg)}$$

When access to laboratory measurement of bicarbonate or carbon dioxide is not available, **empirical** estimations of supplementation levels are made on the basis of clinical judgment.

Bicarbonate concentration in commercial products is measured in milliequivalents per milliliter.

Clinical Uses

These include the treatment of metabolic acidosis and as an adjunctive therapy for the treatment of hypercalcemia or **hyperkalemia**.

Dosage Forms

Veterinary-approved forms include the following:

1. An 8% (1 mEq/ml) solution for injection, which is available in 50-, 100-, and 500-ml vials
2. A 5% (0.6 mEq/ml) solution for injection

Adverse Side Effects

These may include metabolic alkalosis, hypokalemia, hypocalcemia, and **hypernatremia**.

Technician's Notes

1. Sodium bicarbonate is incompatible with several solutions and should be mixed only after consulting product inserts or appropriate references.
2. Some references indicate that sodium bicarbonate should not be added to solutions that contain calcium because of the potential for precipitates to form.
3. Replacement of the total number of milliequivalents should be made over several hours.

Potassium Chloride

Potassium chloride is a solution that is used to supplement potassium deficits (**hypokalemia**). Anorexia, diuresis, and diarrhea are some of the common causes of hypokalemia. Normal serum potassium levels are between 3.5 and 5.5 mEq/L. Table 15-5 provides a guide for potassium supplementation that is based on the measured serum level of potassium.

Clinical Uses

Potassium chloride is used for the treatment or prevention of potassium deficits.

Dosage Forms

Dosage forms for intravenous use include the following:

1. Potassium chloride for injection (2 mEq/ml) in 10- and 20-ml vials (veterinary approved)
2. Potassium chloride for injection (2 mEq/ml) in 5-, 10-, 20-, 30-, 100-, 200-, and 500-ml vials (human approved)

Adverse Side Effects

These may include hyperkalemia, which is manifested by muscle weakness, and cardiac conduction disturbances, which can be life threatening.

Technician's Notes

1. Potassium chloride solutions must be diluted before administration.
2. The rate of infusion of potassium is critical. Consult product inserts or other references for appropriate rates.

Calcium Supplements

Calcium gluconate and calcium chloride may be diluted (1:1 with saline) and given as an infusion to correct hypocalcemia. This is not a common procedure in practice, however. It is more common to inject the supplement, without diluting, for the treatment of emergency conditions such as eclampsia or milk fever.

Clinical Uses

Calcium supplements are used for the treatment of hypocalcemia that may result from various conditions, which may include parathyroid gland disorders, milk fever, eclampsia, and excessive sweating in horses. Calcium in combination with phosphorus, magnesium, potassium, and dextrose is used to treat cattle with conditions such as grass tetany, milk fever, and downer cow syndrome.

Dosage Forms

1. Calcium gluconate injection (generic and proprietary) 10%, in ampules, syringes, vials, and bottles (veterinary label)

Hidden page

Hidden page

Technician's Notes

Some of the oral electrolyte products for farm animals also contain antibiotics.

FIGURE 15-13
Esophageal feeder.

Clinical Uses

These include electrolyte and water replenishment.

Dosage Forms

Dosage forms are numerous, and the following is only a partial listing:

1. Avian Bluelite (powder)
2. Biolyte (powder)
3. Elpak-G Electrolyte Gel
4. Equine Bluelite (powder)
5. Entrolyte (powder)
6. Formula 911 (powder)
7. Ora-Lyte (powder)
8. Re-Sorb (powder)
9. Tumil-K (powder, gel, and tablets for dogs and cats)
10. Vedalyte 8X (powder)
11. Ritrol

Adverse Side Effects

These are rare if care is taken not to cause inadvertent administration into the respiratory system.

PARENTERAL NUTRITION

The term *parenteral* indicates the administration of nutrients by a route other than the gastrointestinal tract. Parenteral nutrition (PN) is described in human medicine as total or partial in reference to whether all nutrient requirements are supplied. Diseased and debilitated patients require a daily intake of adequate calories and protein to maintain good immune function, tissue synthesis, and normal metabolic activities. Those patients that are unable or have no desire to eat normally may need PN.

The term *total parenteral nutrition (TPN)* does not apply to veterinary patients because there is no need to meet the needs for all essential fatty and amino acids, fat- and water-soluble vitamins, and macro and trace minerals, as there is in people (Remillard, Armstrong, and Davenport, 2000). In veterinary medicine, an attempt is made to meet the animal patient's resting energy requirement and most of the requirements for amino and fatty acids, and to provide some of the required vitamins and minerals.

PN solutions must be compounded for the individual patient. A mixture of all required nutrients, called a **total nutrient admixture (TNA)**, can be prepared for the veterinary patient in one fluid bag for convenience. The preparation of these solutions is beyond the scope of most veterinary clinics, but they may be available through human hospitals, veterinary schools, or specialty practices. For a list of products used in the formulation of the TNA, consult an article entitled "Parenteral Nutrition Products" by Miller and Bartges in *Kirk's Current Veterinary Therapy, XIII*.

PARENTERAL VITAMIN/MINERAL PRODUCTS

Parenteral vitamin/mineral products are used to prevent or treat various conditions in veterinary medicine. They are used as therapeutic

agents in large-animal medicine more often than in small-animal medicine. White muscle disease, "tying up," polyneuritis, pinkeye, reproductive problems, bracken fern poisoning, and polioencephalomalacia are only a few of the conditions prevented or treated with vitamin products in large-animal practice. In small-animal practice, routine vitamin and mineral supplementation is not considered necessary if the animal receives a balanced diet. Many small-animal clinicians regard overuse of vitamin/mineral products as a bigger problem than vitamin/mineral deficiencies. Warfarin poisoning (vitamin K) and certain dermatologic conditions (zinc) are exceptions.

Oral multiple-vitamin/mineral products are numerous and are not listed here.



Water-Soluble Vitamins

Vitamin B Complex

B-complex vitamins consist of a group of water-soluble vitamins that include thiamine, riboflavin, niacinamide (niacin), d-panthenol (pantothenic acid), pyridoxine, cyanocobalamin (B_{12}), biotin, choline, and folic acid. B vitamins serve as coenzymes for many metabolic reactions in the body. B complex often is added to intravenous fluids (discussed earlier) and may be given parenterally in an attempt to enhance the biochemical response of stressed or debilitated animals.

Clinical Uses

These vitamins are administered to replace or supplement a deficiency of B-complex vitamins.

Dosage Forms

1. Compound 150
2. Vitamin B Complex
3. Vitamin B Complex Fortified
4. Vitamin B Complex Injectable

Adverse Side Effects

These can include allergic reactions and pain at the injection site.

Technician's Notes

1. Check the label before giving B complex intravenously.
2. Observe the animal for allergic reactions.
3. B-complex injections may cause pain at the injection site.

Thiamine Hydrochloride (Vitamin B_1)

Thiamine is a water-soluble B-complex vitamin that acts as a coenzyme for biochemical reactions involved in carbohydrate metabolism. Deficiency of thiamine may occur as a consequence of decreased intake or synthesis, or from increased destruction, which may result from bracken fern poisoning, thiamine-destroying factors in the rumen, or thiaminase in raw fish. Polioencephalomalacia of ruminants also has been associated with thiamine deficiency.

Clinical Uses

Thiamine is administered for the treatment of thiamine deficiency in all domestic species and as an aid in the treatment of lead poisoning in cattle.

Dosage Forms

1. Vita-Jec Thiamine HCl
2. Thiamine hydrochloride (generic)
3. Vitamin B_1 Powder

Adverse Side Effects

These may include hypersensitivity reactions and muscle soreness at intramuscular injection sites.

Vitamin B_{12} (Cyanocobalamin)

Vitamin B_{12} is a B-complex vitamin that contains cobalt and is thought to act as a coenzyme in protein synthesis. Pernicious anemia is a condition that occurs in humans as the result of a failure to absorb B_{12} adequately. A deficiency in any case results in anemia because red blood cells fail to mature properly in the absence of B_{12} . B_{12} deficiencies are rare in veterinary medicine.

Clinical Uses

Vitamin B_{12} is administered for the management of B_{12} deficiencies.

Hidden page

REFERENCES

- Blankenship J, Campbell JB: Solutions. In Blankenship J, Campbell JB, editors: *Laboratory mathematics: medical and biological applications*, St. Louis, 1976, Mosby.
- Chew DJ: Fluid therapy for dogs and cats. In Birchard S, Sherding R, editors: *Saunders manual of small animal practice*, ed 2, Philadelphia, 2000, WB Saunders.
- Crowe DT: Emergency medicine, *Proceedings of the Tennessee Veterinary Medical Association Annual Conference*, Brentwood, Tenn, 2007.
- DiBartola SP: Applied physiology of body fluids in dogs and cats. In DiBartola SP, editor: *Fluid, electrolyte and acid-base disorders in small animal practice*, ed 3, Philadelphia, 2006, Saunders Elsevier.
- Haskins SC: Fluid overload: how to identify and manage, *Proceedings of the International Veterinary Emergency and Critical Care Symposium*, Orlando, Fla, 2000.
- Remillard RL, Armstrong PJ, Davenport DJ: Assisted feeding in hospitalized patients: enteral and parenteral nutrition. In Hand MS, et al, editors: *Small animal clinical nutrition*, Marceline, Mo, 2000, Walsworth Publishing Co.



REVIEW QUESTIONS

1. Define hyperkalemia.

2. Intravascular fluid makes up approximately _____ of body weight.
 - a. 2%
 - b. 5%
 - c. 15%
 - d. 40%
3. Explain the concept of a balanced solution for fluid therapy. _____
4. What are three units of measurement used for quantifying electrolytes in fluids?

5. Therapeutic fluids with an osmolarity of approximately _____ mOsm/L are isotonic.
 - a. 100
 - b. 200
 - c. 300
 - d. 500
6. Give examples of sensible and insensible fluid losses. _____
7. Underestimation of the degree of dehydration is sometimes a problem in _____ animals.
8. One pound of fluid is equivalent to _____ milliliters, and 1 kg is equivalent to _____ milliliters.
9. The three volumes that are calculated to arrive at the total fluid volume are _____.
10. Calculate the fluid needed for a 44-lb dog that is 6% dehydrated and is losing 100 ml of fluid daily through vomiting.

11. What drip rate should be used to deliver (over a 24-hour period) the fluid for the dog in question 10 (using a standard administration set)?

12. Describe how you would set up the first bag of fluids for the dog in question 10.

13. Tell how you would prepare 500 ml of 5% dextrose from a 50% stock solution.

14. What is the purpose of the lactate in lactated Ringer's solution?

15. Describe the use of an esophageal feeder.

16. What type of fluid (tonicity) should not be given subcutaneously?

17. Give an example of a balanced solution and an example of an unbalanced solution.

18. _____ is a determination of the osmotic pressure of a solution based on the relative number of solute particles in 1 kg of the solution.
19. The osmolarity of dog and cat serum is approximately _____ mOsm/L.
20. Commercial fluids with an osmolarity of 300 mOsm/L are _____.
21. How often should intravenous catheters be flushed? _____
22. What is the longest time an IV catheter should remain in place before it is replaced?

23. What precaution should be observed when fluids are administered subcutaneously?

24. What fluid can be used to bathe tissues during surgery to prevent them from drying out?

25. Any product that contains the electrolyte _____ should be given by slow IV administration to prevent cardiac complications.

Hidden page

Hidden page

Hidden page

Hidden page

Hidden page

Clinical Uses

This product is labeled for the treatment of anemia in dogs regardless of the cause. It has been used in cats but is not labeled for such use.

Dosage Form

Oxyglobin (hemoglobin glutamer-200)

Adverse Side Effects

Potential side effects include pulmonary edema, discolored urine, discolored membranes, ventricular arrhythmias, fever, and coagulopathy.

Technician's Notes

1. The recommended administration rate should not be exceeded.
2. Do not administer with other fluids or drugs through the same intravenous set.
3. Do not combine with other fluids in the same bag.



Anticoagulants

Blood coagulation is an obviously essential process that is designed to inhibit the loss of vital blood constituents from the circulatory system. Two separate systems or pathways may initiate the clotting mechanism—the intrinsic (intravascular) and extrinsic (extravascular) systems.

The intrinsic pathway is activated by injury to the **endothelial layer** of a blood vessel, which disrupts blood flow and causes a chain of chemical reactions leading to a **thrombus**, or clot. This process helps to repair damage to blood vessel walls that occurs from routine wear and from pathologic processes.

The extrinsic pathway is activated by injury to tissue and vessels, which releases tissue thromboplastin. Thromboplastin stimulates the clotting mechanism. Vasoconstriction occurs in damaged blood vessels, causing a slowing of blood flow and facilitating clot formation. Platelet aggregation and adherence are also important steps in the clotting process.

The intrinsic and extrinsic pathways converge into a common pathway in the final steps of clot formation

(Figure 16-3). At least 13 clotting factors participate in this series of reactions (called a **cascade**) in which the product of the preceding reaction promotes the next reaction (Table 16-1). The final step in the process is the conversion of fibrinogen to fibrin by thrombin. If any of the clotting factors in the cascade are deficient or missing, clotting does not occur.

A balance must be maintained in the body between clot formation and clot breakdown. Destruction of clots—**fibrinolysis**—occurs through the action of an enzyme called **plasmin**. Plasmin digests fibrin threads and other clotting products to cause clot lysis and the release of fibrin degradation products into the circulation.

Anticoagulants inhibit clot formation by tying up or inactivating one of the clotting factors to interrupt the cascade reaction. They are used clinically to prevent coagulation of blood (or other body fluid) samples that are collected for testing, to preserve blood for transfusions, to inhibit clotting in intravenous catheters, and to prevent or treat thromboembolic disorders (e.g., thromboembolic cardiomyopathy in cats).

Heparin is used paradoxically to treat the bleeding disorder **disseminated intravascular coagulation (DIC)**.

Heparin

Heparin is an anticoagulant that is found in many tissues of the body and is thought to be stored in mast cells. It is obtained from pig intestinal mucosa, and its strength is expressed in terms of heparin units. Heparin acts as an anticoagulant by preventing the conversion of prothrombin (factor II) to thrombin. Without thrombin, fibrinogen is not converted to fibrin and a clot does not form. Heparin does not break down clots but can prevent clots from increasing in size. It is administered therapeutically by intravenous or subcutaneous injection.

Heparin has various uses in veterinary medicine. It is used *in vitro* as an anticoagulant to preserve blood samples for testing by heparinizing (drawing heparin into the syringe and then forcing all visible quantities out) a syringe before the blood sample is drawn. It also is diluted in saline or sterile water for injection to form a flush solution for

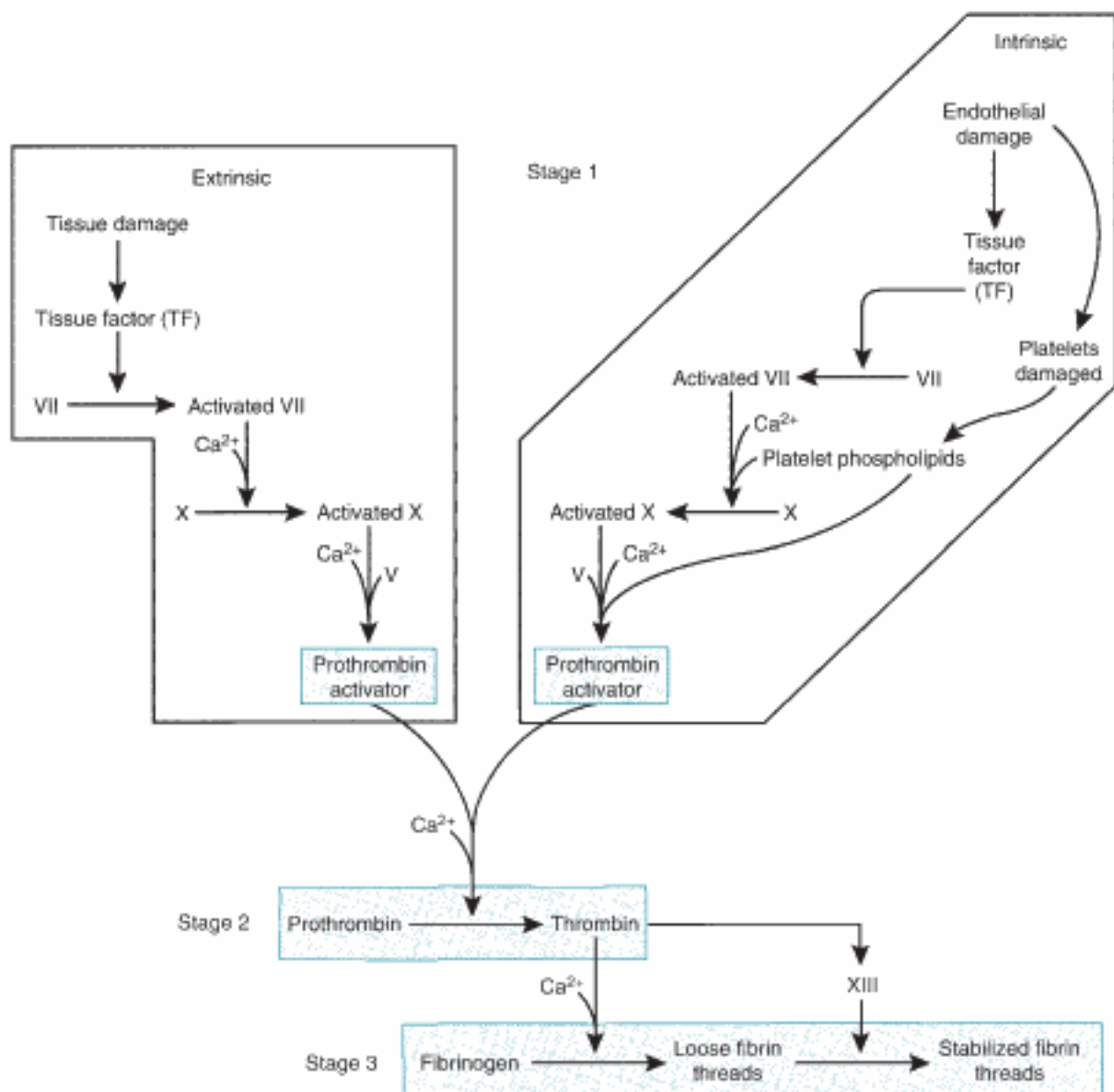

FIGURE 16-3
The clotting pathways.

preventing clots in intravenous catheters. Heparin is sometimes used to preserve donated blood for transfusions when small quantities are needed (e.g., for cats, small dogs). It is used *in vivo* to aid in the treatment of DIC and **thromboembolism** and has been advocated for the treatment of laminitis in horses.

Clinical Uses

Clinical uses are listed in the previous paragraph.

Dosage Forms

Forms approved for use in humans are used in veterinary medicine:

1. Heparin sodium injection, 1000 U/ml
2. HepLock flush solution (10 or 100 U/ml)

Adverse Side Effects

These usually manifest as bleeding or **thrombocytopenia**.

Table 16-1 The Clotting Factors

Coagulation Factor	Synonym
I	Fibrinogen
II	Prothrombin
III	Tissue factor (thromboplastin)
IV	Calcium ions
V	Proaccelerin, labile factor, or accelerator globulin
VI	Activated factor V
VII	Serum prothrombin conversion-accelerator (SPCA), stable factor, or proconvertin
VIII	Antihemophilic factor (AHF), antihemophilic factor A, or antihemophilic globulin factor B
IX	Christmas factor, plasma thromboplastin component (PTC), or antihemophilic factor B
X	Stuart-Prower factor, thrombokinese
XI	Plasma thromboplastin antecedent (PTA) or antihemophilic factor C
XII	Hageman factor, glass factor, or contact factor
XIII	Fibrin-stabilizing factor (FSF) or fibrinase

Technician's Notes

- Heparin should not be used as an anticoagulant when blood is collected for performing a differential count because white blood cell morphology may be adversely affected.
- A heparin flush solution may be prepared by diluting heparin in saline at a concentration of 5 U/ml (Crow and Walshaw, 1987).
- Approximately 750 U of heparin should be drawn into a 60-ml syringe to act as an anticoagulant when blood is collected for transfusion (Norsworthy, 1992).
- Heparin blood collection tubes have a green top.
- Protamine sulfate is the antidote for heparin overdose.

Ethylenediaminetetraacetic Acid (EDTA)

EDTA is an anticoagulant that prevents clotting by chelation of calcium (factor IV). With calcium ions tied up by EDTA, clotting cannot occur. It is used in

vitro to preserve blood samples and is the anticoagulant of choice when a differential count is needed (it preserves white cell morphology well). EDTA is prepared in lavender-topped collection tubes.

The calcium salt of EDTA (calcium disodium versenate) is also used in vivo as a chelating agent to treat lead poisoning. This function does not involve the clotting mechanism (see Chapter 18).

Coumarin Derivatives

Coumarin derivatives such as dicumarol and warfarin are oral anticoagulants that bind vitamin K and therefore inhibit the synthesis of prothrombin (factor II) and factors VII, IX, and X. These compounds are indicated for long-term treatment of thromboembolic conditions. They are used clinically to a greater extent in human medicine than in veterinary medicine.

Dicumarol may be found in moldy sweet clover and has been associated with fatal hemorrhagic disease in cattle. Warfarin and related compounds are used in many rat poisoning products.

Clinical Uses

Coumarin derivatives are used for the long-term management of thromboembolic conditions.

Dosage Form

Coumadin tablets or injection

Adverse Side Effects

Adverse side effects are related to hemorrhage.

Technician's Notes

Vitamin K₁ is the antidote for warfarin or dicumarol toxicity.

Acid Citrate Dextrose (ACD) Solution and Citrate Phosphate Dextrose Adenine (CPDA-1)

ACD solution contains dextrose, sodium citrate, and citric acid and prevents clotting by chelating calcium. It is prepared in bottles or plastic bags for blood collection under both veterinary and human labels. Bottles are available for collecting 250 and 500 ml of blood. ACD solution preserves blood for 3 to 4 weeks.

CPDA-1 solution is available in plastic bags for collection of 450 ml of blood. CPDA-1 also prevents clotting by chelating calcium and preserves blood for as long as 6 weeks.

Eight milliliters of ACD or CPDA-1 can be drawn into a syringe to collect 50 ml of blood when small quantities are needed (Norsworthy, 1992).

Antiplatelet Drugs

Antiplatelet drugs such as aspirin appear to impair clotting through inhibition of platelet stickiness and clumping. This activity is thought to be mediated through inhibition of the proaggregatory prostaglandin called *thromboxane* (Pugh, 1991).

Aspirin has been used to prevent thromboembolism associated with heartworm treatment in dogs and to treat cardiomyopathy in cats.

Hemostatics/Anticoagulant Antagonists

Substances that promote blood clotting—hemostatics—may be divided into two categories: (1) those applied topically and (2) those given parenterally.

Topical Agents

Topical agents act by providing a framework in which a clot may form or by coagulating blood protein to initiate clot formation. Framework substances used in topical hemostatics include gelatins and collagens, whereas styptics, hemostatic powders, and solutions are substances that initiate clotting through coagulation. The framework substances are absorbed after clot formation. Topical hemostatics are used to control capillary bleeding or bleeding from other small vessels.

Clinical Uses

These include the control of capillary bleeding at surgical sites or in superficial wounds.

Dosage Forms

1. Gelfoam absorbable gelatin sponge
2. Hemopad Absorbable Collagen Hemostat

3. Surgical Absorbable Hemostat
4. Hemostat Powder (ferrous sulfate powder)
5. Clotisol (ferric sulfate)
6. Silver nitrate sticks
7. Thrombogen topical thrombin solution
8. Celox. Celox granules represent a new generation of hemostatic agent that is being used in military and other trauma situations to control both venous and arterial bleeding in superficial and deep wounds. Celox granules are reported to control bleeding in hyperthermic conditions and in heparinized blood.

Adverse Side Effects

These are usually minimal but may include delayed wound healing.

Parenteral Agents

Parenterally administered hemostatic agents act as anticoagulant antagonists because they do not directly activate clotting. These substances promote the synthesis of clotting factors that have been depleted through poisoning or disease or tie up (inactivate) anticoagulants that have been overdosed. These drugs are not used to control surgical or traumatic bleeding.

PROTAMINE SULFATE

Protamine sulfate is a protein that is produced from the sperm or testes of salmon or related species (Plumb, 2005). Protamine has a strongly basic pH, and heparin has a strongly acidic pH. Protamine combines with heparin to form inactive complexes (salt).

Clinical Uses

Protamine sulfate is used for the treatment of heparin overdose. Slow intravenous administration is recommended.

Dosage Form

Protamine sulfate injection, USP

Adverse Side Effects

Hypotension and bradycardia can occur if given too rapidly.

VITAMIN K₁ (PHYTONADIONE)

Phytonadione is a synthetic substance that is identical to naturally occurring vitamin K₁. Vitamin K is necessary for the production (in the liver) of active prothrombin (factor II), proconvertin factor (factor VII), plasma thromboplastin component (factor IX), and Stuart factor (factor X). It is used clinically for treating cases in which vitamin K has been tied up or destroyed and in bleeding disorders associated with poor formation of vitamin K-dependent clotting factors. Immediate coagulant effect should not be expected after administration of vitamin K because several hours may pass before synthesis of new clotting factors occurs.

Clinical Uses

In veterinary medicine, vitamin K₁ is used for the treatment of rodenticide toxicity, for bleeding disorders related to faulty synthesis of vitamin K-dependent clotting factors, and for unknown anticoagulant toxicity.

Dosage Forms

Human forms of vitamin K₁ are used:

1. AquaMEPHYTON, phytonadione injection
2. Konakion, phytonadione injection
3. Mephyton, phytonadione tablets

Adverse Side Effects

These include anaphylactoid reactions (intravenous use) and bleeding at the injection site.

Technician's Notes

Because of the possibility of anaphylactoid reactions, many consider intravenous administration of phytonadione to be contraindicated.

**Fibrinolytic (Thrombolytic) Drugs**

Thrombolytic drugs are used to break down or dissolve thrombi. Occlusion of an artery by a thromboembolus can cause necrosis of tissue distal to the blockage if the obstruction is not removed quickly.

In humans, damage to heart muscle that occurs when a coronary artery is occluded in a heart attack is a classic example of this process. Pulmonary thromboemboli sometimes occur in dogs after heartworm treatment and may accompany cardiomyopathy in cats.

Thrombolytic agents may help to remove or reduce the size of the occluding thromboembolus and minimize tissue damage. This action is brought about by stimulating conversion of plasminogen to the enzyme plasmin, which lyses the clots. The sooner the therapy is initiated after thromboembolism has occurred, the better the chances of success. Thrombolytic activity of one of the products (alteplase) is activated by the presence of fibrin so that recent clots are targeted.

The expense of these drugs often precludes their use in veterinary medicine.

Clinical Uses

1. Treatment of pulmonary embolism
2. Treatment of arterial thrombosis and emboli
3. Treatment of coronary thrombosis
4. Intravenous catheter clearance

Dosage Forms

1. Streptase, streptokinase
2. Abbokinase, urokinase
3. Activase, alteplase

Adverse Side Effects

These are related to bleeding episodes, especially if anticoagulants have also been used.

ANTINEOPLASTIC DRUGS

Antineoplastic drugs are administered to animals in an attempt to cure or lessen the effect of neoplasms. Neoplasia is the abnormal growth of tissue into a mass that is not responsive to normal cellular control mechanisms. The term *tumor* by definition indicates any tissue mass or swelling that may or may not be neoplastic. *Tumor* is often used broadly in common discussion to indicate a neoplasm. A neoplasm may be benign or malignant. In general, benign tumors (neoplasms) do not cause high mortality because

they grow locally and do not invade adjacent tissue. These tumors may cause morbidity, however, by compressing or occluding organs. The term *cancer* is used to indicate a malignant neoplasm that is capable of causing destruction of the tissue of origin and is also capable of **metastasis** to other tissue. Malignant tumors are very damaging to tissue and often lead to the death of the patient if treatment is not provided. A third type of neoplasm is an *in situ* tumor, which is a small tumor in epithelial tissue that appears to contain cancer cells but does not cross the basement membrane and invade adjacent tissue. Treatment of neoplasia involves several methods, including the use of drugs (chemotherapy), surgery, radiation, and immune modulation. Regardless of the method used, the goals of treatment are to keep the neoplasia under control, increase survival time, and improve the quality of life of the patient.

If one is to understand the use of chemotherapy drugs, a basic understanding of cancer formation is in order. Cancer has been called a "complex mutagenic disease" (Withrow and Vail, 2007) in which genetic mutations give a cell or cells the ability to replicate in an unlimited way (Initiation), form a mass of cells (Promotion), and invade adjacent tissue (Progression). Oncologists speculate that five to six genetic mutations are the minimum number that must occur to give a cell the six fundamental characteristics of cancer. These six characteristics

are (1) self-sufficiency in the production of cell growth signals, (2) insensitivity to antigrowth signals, (3) the ability to evade programmed cell death (apoptosis), (4) unlimited potential to replicate, (5) sustained ability to promote angiogenesis (blood vessel formation for the cancer mass), and (6) the capacity to invade tissue and metastasize.

Several mechanisms are thought to be involved in the production of the six hallmarks of cancer. Proto-oncogenes are genetic elements in all normal cells that are capable of causing cancer if they are enhanced through abnormal regulation. The ability of the cancer cell to replicate in an unlimited way may be facilitated by activation or upregulation of an enzyme called *telomerase*. Defects in suppressor oncogenes or anti-oncogenes like the *p53* gene may take away the ability to control the normal cell cycle. Factors that may promote the mechanisms leading to cancer include viruses, as well as chemical, physical, and hormonal influences.

PRINCIPLES OF CHEMOTHERAPY

Proliferating cells, whether they are found in normal tissue or in neoplasms, contain resting and dividing cells that are involved in phases of the cell cycle (Figure 16-4). These phases of the cell cycle include the S-phase (DNA synthesis), the M-phase

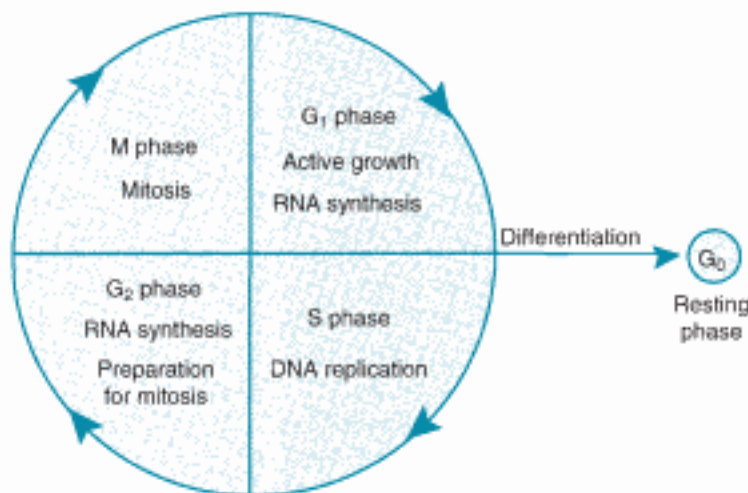

FIGURE 16-4
The cell cycle.

Hidden page

soon after treatment is started because of effects on the chemoreceptor trigger zone (CRTZ), or 3 to 5 days later because of injury to gastrointestinal epithelium. Bone marrow depression (**myelosuppression**) also may occur, resulting in a moderate to severe reduction in circulating neutrophils and/or platelets. Dogs with continuously growing hair like poodles, terriers, and Old English Sheepdogs may lose their hair as a result of chemotherapy. Cats may lose their whiskers and guard hairs as well. Other side effects may include cystitis, cardiomyopathy, anaphylactic reactions, and tissue damage due to extravasation of the drug/s. Many chemotherapy drugs are **vesicants** that cause inflammation and potential sloughing of tissue if leakage outside the vein occurs when the agents are administered. Some protocols call for pretreatment of the patient with drugs like antihistamines, steroids, antiemetics, and/or analgesics to reduce the severity of side effects.

Great care should be taken to prevent accidental exposure to chemotherapy drugs by technicians, veterinarians, and other employees because of the ability of these drugs to be teratogenic, mutagenic, and carcinogenic at therapeutic doses (Dickenson and Ogilvie, 1995). Box 16-1 provides a list of recommendations for the safe use of antineoplastic agents.

Antineoplastic drugs have been categorized into the following major classes: alkylating agents, anthracyclines, antimetabolites, antitubulin agents, corticosteroids, and miscellaneous agents. Table 16-3 provides a list of the commonly used antineoplastic agents, as well as their indications, toxicities, and dosages.

Cancer chemotherapy can be a long, emotional, costly, and complicated process. Patients may experience periods of relapse and remission, harmful drug reactions can occur, and treatments can fail. Technicians should be prepared to counsel owners about the potential risks and the high level of commitment they will need to see the process through to completion. They should be able to make the animal owner aware that successful treatment can mean a longer and/or a better quality of life for their pet and a strengthening of the human-companion animal bond.



Alkylating Agents

Alkylating agents are **cell cycle–nonspecific** drugs that are able to cross-link strands of DNA to change its structure and inhibit its replication. This brings protein synthesis and cell division to a halt; cell death often follows.

Clinical Uses

1. Treatment of various neoplastic disorders, including lymphoproliferative neoplasms, osteosarcoma, hemangiosarcoma, and squamous cell carcinoma
2. Treatment of certain immune-mediated diseases (immunosuppression)

Dosage Forms

1. Cytoxan, cyclophosphamide injection
2. Leukeran, chlorambucil tablets
3. Alkeran, melphalan tablets
4. Nitrosoureas, lomustine, and carmustine
5. Dacarbazine
6. Ifex, ifosfamide

Adverse Side Effects

Adverse side effects of the alkylating agents may include neutropenia, nephrotoxicity, thrombocytopenia, vomiting, and hemorrhagic cystitis.

Technician's Notes

Cyclophosphamide is also used as an immunosuppressant.



Anthracyclines

Many of the anthracycline antineoplastic agents are derived from soil fungi of the *Streptomyces* genus. They are cell cycle nonspecific and exert their effects by binding with DNA and interfering with RNA and protein synthesis. Doxorubicin is the most commonly used drug in this class in veterinary medicine. It is widely used for various neoplastic conditions.

BOX 16-1 Chemotherapy Safety Recommendations**Safety Issue**

To minimize the risk of topical contamination

To avoid the oral route of contamination

Chemotherapy waste disposal

Precautions for patient care and clean-up (although the amount of active drug eliminated from the patient is minimal, it is prudent to take precautions)

Recommendations

1. Wear approved chemotherapy administration gloves. Latex examination gloves are not impermeable to chemotherapeutic agents. If chemotherapy administration gloves are not available, double-glove with latex exam gloves.
2. Wear a nonabsorbent chemotherapy administration gown or, at minimum, wear a buttoned-up lab coat.
3. Do not push air bubbles out of the syringe.
4. The use of commercially available chemotherapy dispensing systems (e.g., PhaSeal) can decrease the risk of exposure.
5. Use safety goggles or other protective eyewear.
1. Never eat or drink in the chemotherapy administration room.
2. Never smoke or apply makeup in the chemotherapy administration room.
3. Never store chemotherapeutic drugs with food or other drugs.
4. Caution clients (and veterinary staff) always to wear gloves when administering chemotherapeutic drugs by the oral route.
1. Separate chemotherapy waste from other sharps and biohazards, including needles, syringes, catheters, gloves, and masks.
2. Contact a local human hospital for aid in disposal of all chemotherapy-associated waste.
1. Chemotherapeutic drugs are excreted in feces and urine; wear chemotherapy gloves when cleaning up after patients for 48 hours after drug administration.
2. No guidelines have been established for the disposal of pet waste; however, caution clients about cleaning up after their pets. If the patient urinates or defecates inside the home within 48 hours of receiving chemotherapy, owners should wear gloves to clean up waste and should double-bag all waste.

From Withrow SJ, Vail DM: Withrow & MacEwan's small animal clinical oncology, ed 4, St. Louis, 2007, Saunders.

Clinical Uses

These agents are used for the treatment of lymphoproliferative neoplasms and various carcinomas and sarcomas.

Dosage Forms

1. Adriamycin, doxorubicin hydrochloride for injection
2. Bleomycin

3. Dactinomycin

4. Mitoxantrone

5. Idarubicin

Adverse Side Effects

These include bone marrow suppression, cardiotoxicity (cardiomyopathy), gastroenteritis, and anaphylaxis.

Table 16-3 Commonly Used Chemotherapeutic Drugs

Drug	Main Indications	Toxicities	Dosage
Alkylating Agents			
Cyclophosphamide	Lymphoma, carcinoma, sarcoma	Marrow, gastrointestinal (GI) tract, sterile hemorrhagic cystitis	Given orally (PO) or intravenously (IV); many dosing regimens can be used, depending on concurrent anticancer drugs.
Chlorambucil	Lymphoma, chronic lymphocytic leukemia, mast cell tumor, IgM myeloma Substitute for cyclophosphamide if hemorrhagic cystitis occurs.	Mild marrow toxicity	Given PO only; many dosing regimens can be used, depending on concurrent anticancer drugs.
CCNU (lomustine)	Relapsed lymphoma or mast cell tumor, brain tumor	Myelosuppression and idiosyncratic, potentially fatal hepatotoxicity	Dogs: 60-90 mg/m ² PO every 3 weeks Cats: 50-60 mg/m ² PO every 3-6 weeks
Dacarbazine	Lymphoma	Myelosuppression, vomiting during administration, perivascular irritation upon extravasation	Dogs: 200 mg/m ² IV daily for 5 days every 3 weeks or 1000 mg/m ² IV every 3 weeks
Ifosfamide	Lymphoma	Hemorrhagic cystitis, myelosuppression	Dogs: 275-350 mg/m ² IV with saline diuresis and mesna, every 3 weeks
Melphalan	Multiple myeloma, anal sac adenocarcinoma	Myelosuppression, potential cumulative thrombocytopenia	Dogs: 0.1 mg/kg every 24 hours for 10 days, then 0.05 mg/kg daily or 7 mg/m ² PO daily for 5 days every 3 weeks Cats: 0.1 mg/kg every 24 hours
Anthracyclines			
Dactinomycin	Lymphoma	Myelosuppression, GI upset, perivascular damage with extravasation	0.75-0.8 mg/m ² IV every 3 weeks
Doxorubicin	Lymphoma, carcinoma, sarcoma	Myelosuppression, GI upset, hypersensitivity during administration, perivascular damage with extravasation, cumulative (180 mg/m ²) myocardial toxicity, nephrotoxicity (cats)	Dogs: ≥ 10 kg: 30 mg/m ² IV every 2-3 weeks Dogs < 10 kg: 1 mg/kg IV every 2-3 weeks Cats: 1 mg/kg IV every 3 weeks
Doxorubicin HCl liposome injection	Lymphoma, carcinoma, sarcoma	Mild myelosuppression and/or GI upset, hypersensitivity during administration, perivascular damage with extravasation, palmar plantar erythro-dysesthesia (PPES) nephrotoxicity (cats)	Dogs and cats: 1 mg/kg IV every 3 weeks

From Withrow SJ, Vail DM: Withrow & MacEwan's small animal clinical oncology, ed 4, St. Louis, 2007, Saunders.

Copyrighted material

Table 16-3 Commonly Used Chemotherapeutic Drugs—cont'd

Drug	Main Indications	Toxicities	Dosage
Idarubicin	Unclear	Mild myelosuppression and/or GI upset, perivascular damage with extravasation	Idarubicin: 2 mg/cat/day for 3 days q 3 wk
Mitoxantrone	Lymphoma, transitional cell carcinoma	Myelosuppression, GI upset, perivascular damage with extravasation	Dogs: 5-5.5 mg/m ² IV every 3 weeks Cats: 6 mg/m ² IV every 3 weeks
Antimetabolites			
Methotrexate	Lymphoma	Mild myelosuppression and/or GI upset	Given PO or IV Dogs and cats: 0.8 mg/kg in combination with other chemotherapeutic drugs
Cytosine arabinoside	Lymphoma (myeloproliferative)	Mild myelosuppression and/or GI upset	Given subcutaneously (SQ), intramuscularly (IM), or IV; several different regimens can be used, depending on concurrent anticancer drugs.
Antitubulin Agents			
Paclitaxel	Under investigation	Hypersensitivity during administration	Dogs: 132 mg/m ² IV every 3 weeks; must premedicate to minimize hypersensitivity
Vinblastine	Mast cell tumor	Myelosuppression, perivascular vesicant	Dogs: 2 mg/m ² IV every 1-2 weeks
Vincristine	Lymphoma, mast cell tumor, transmissible venereal tumor, immune-mediated thrombocytopenia	Myelosuppression, perivascular vesicant, peripheral neuropathy, constipation in cats	Dogs and cats: 0.5-0.7 mg/m ² IV weekly or as dictated by concurrent anticancer drugs.
Vinorelbine	Primary lung tumor	Myelosuppression, perivascular vesicant	Dogs: 15-18 mg/m ² IV every 1-2 weeks
Corticosteroids			
Prednisone	Lymphoma, mast cell tumor, myeloma, chronic lymphocytic leukemia Noncytotoxic indications: brain tumor, insulinoma, appetite stimulant	Polyuria, polyphagia, polydipsia, muscle wasting, behavioral changes	Dogs and cats cytotoxic dose: 2 mg/kg/day, taper according to protocol Dogs and cats noncytotoxic dose: 0.5 mg/kg/day
Miscellaneous Drugs			
Asparaginase	Lymphoma	Hypersensitivity reaction after administration	Dogs and cats: 400 IU/kg SQ or IM, maximum dose of 10,000 IU
Carboplatin	Osteosarcoma, carcinoma, sarcoma	Myelosuppression; potentially severe (small dogs) GI effects	Dogs: 300 mg/m ² IV every 3 weeks Cats: 240-260 mg/m ² IV every 3 weeks
Cisplatin	Osteosarcoma, carcinoma, sarcoma	Nephrotoxic—must be given with saline-induced diuresis; highly emetogenic; fatal to cats	Dogs: 70 mg/m ² IV every 3 weeks Cats: Do not use.

Continued

Copyrighted material

Table 16-3 Commonly Used Chemotherapeutic Drugs—cont'd

Drug	Main Indications	Toxicities	Dosage
Hydroxyurea	Polycythemia vera, myeloproliferative diseases	Myelosuppression	Dogs: 50 mg/kg/day, tapering to every other day with remission Cats: 10 mg/kg/day, tapering to every other day with remission
Procarbazine	Lymphoma	GI upset, myelosuppression	Dogs: 50 mg/m ² daily for 14 days on and 14 days off as part of mechlorethamine, Oncovin (vincristine), procarbazine, and prednisone (MOPP) protocol

Technician's Notes

1. Some clinicians use antihistamines to premedicate animals to be treated with doxorubicin to suppress allergic reactions.
2. Doxorubicin is a strong vesicant. Tissue sloughing can follow extravasation, and skin irritation can result from contact with the drug.
3. Doxorubicin is commonly used in combination with other antineoplastic agents.
4. Dexrazoxane is a drug that may be used to block doxorubicin-induced cardiac toxicity.

Antimetabolites

The antimetabolites are **cell cycle-specific** drugs that affect the S-phase (DNA synthesis) of the cycle. These drugs are analogs of purines and pyrimidines—naturally occurring bases in DNA—that may be incorporated into the DNA molecule to inhibit protein and enzyme synthesis. Cellular functions needed for normal activity are thus blocked.

Clinical Uses

1. Treatment of lymphoproliferative neoplasms
2. Treatment of gastrointestinal and hepatic neoplasms
3. Treatment of central nervous system lymphoma

Dosage Forms

1. Methotrexate, oral tablet or injection
2. Cytosar-U, cytosine arabinoside injection
3. 5-Fluorouracil cream or solution

Adverse Side Effects

These may include anorexia, nausea, vomiting, diarrhea, bone marrow suppression, hepatotoxicity, and neurotoxicity.

Technician's Notes

Fluorouracil is contraindicated in cats because of adverse side effects.

Antitubulin Agents

The plant alkaloids are cell cycle specific for the M-phase, inhibiting mitosis and causing cell death. They are thought to bind microtubular proteins and inhibit formation of the mitotic spindle, thus suspending mitosis in metaphase.

The two drugs in this category—vincristine and vinblastine—are natural alkaloids derived from the periwinkle plant (*Vinca rosea*, Linn). Protective clothing should be worn when these drugs are administered, to prevent possible skin contact irritation.

Hidden page

Hydroxyurea and procarbazine are two other agents in the miscellaneous category. See Table 16-3 for information about these two agents.

Biologic Response Modifiers

Biologic response modifiers (BRMs) are agents that alter the relationship between the tumor and the host animal in a way that improves the host's ability to mount an antitumor response (Grant and Shelton, 1989). BRMs are used as an adjunct to conventional chemotherapy protocols, not as the sole agent of treatment.

Cancer develops in many animals because of an immunosuppressed state, and chemotherapy

exacerbates the immunosuppression. BRMs may be used to stimulate or restore the compromised immune response of the host.

Examples of BRMs include bacterial agents, chemical agents, interferons, thymosins, cytokines/lymphokines, and monoclonal antibodies.

Monoclonal Antibodies

Monoclonal antibodies are identical immunoglobulin molecules formed by a single clone of plasma cells. They are produced by a **hybridoma**, a fusion of a specific antibody-producing B cell with **myeloma** cells (Figure 16-5). Hybridomas secrete large quantities of a very specific (for the tumor) antibody. Monoclonal antibodies may have direct cytotoxic effects on tumor cells, or they may be

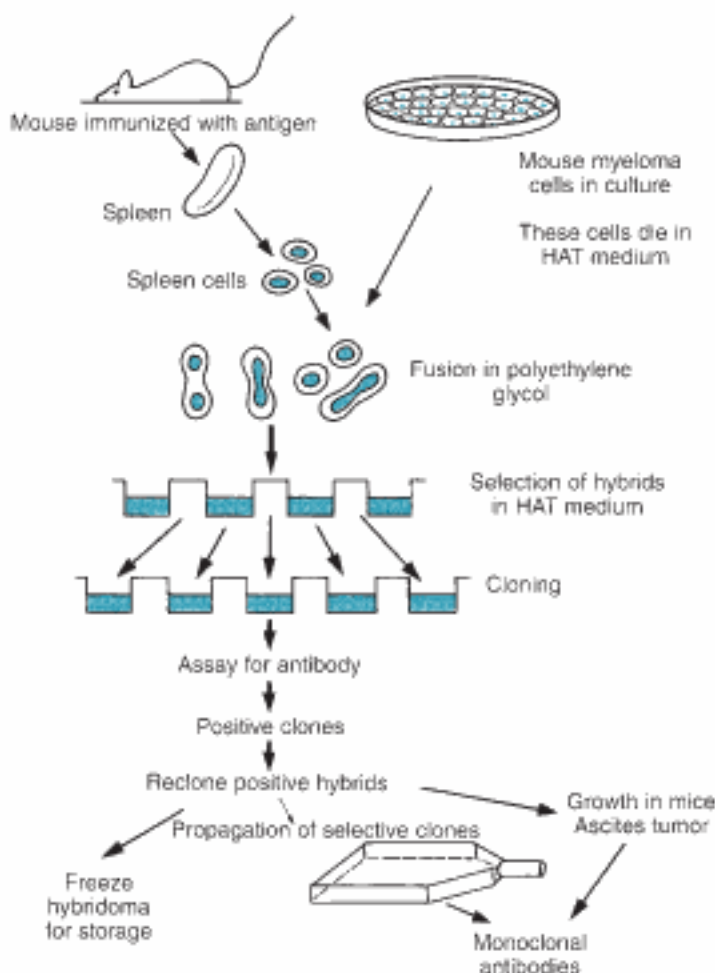

FIGURE 16-5

Production of monoclonal antibodies. HAT, Hypoxanthine-aminopterin-thymidine. (From Tizard I: Veterinary immunology: an introduction, ed 3, Philadelphia, 1987, WB Saunders.)

Hidden page

Hidden page

Hidden page

Hidden page

Hidden page

RECOMBINANT

TOXOID

Common Vaccine Types That Produce
Passive Immunity

ANTITOXIN

ANTISERUM

Other Types of Vaccines

AUTOGENOUS VACCINE

MIXED VACCINE

Administration of Vaccines

Biologic Care and Vaccine Failure

Adverse Vaccination Responses

Vaccinations for Preventive Health
Programs

Canine

Canine Vaccines

Equine

Equine Vaccines

Feline

Feline Vaccines

Bovine

Bovine Vaccines

Others

Swine Vaccines

Small Ruminant Vaccines

Immunotherapeutic Drugs

IMMUNOSTIMULANTS

Complex Carbohydrates

Acemannan

Immunomodulatory Bacterins

Staphylococcus Phage Lysate (SPL)

Propionibacterium Acnes Bacterin

Mycobacterial Cell Wall Fraction

CHAPTER 17

Immunologic Drugs

LEARNING OBJECTIVES

After studying this chapter, you should be able to:

1. Explain the principles associated with vaccination.
2. Describe the differences between vaccine types.
3. Discuss the advantages and disadvantages of the different types of vaccines.
4. List common diseases that have available vaccines.
5. Describe the different routes of administration of vaccines.
6. List drugs used in immunotherapy.

 **KEY TERMS**

ACTIVE IMMUNITY Immunity that occurs by an animal's own immune response after exposure to foreign antigen.

ADJUVANT A substance given with an antigen to enhance the immune response to the antigen. Adjuvants may form a localized granuloma at the injection site or may produce systemic hypersensitivity. Adjuvants have received much attention as a result of a possible (but not proven) link with the increased incidence of fibrosarcomas in vaccinated cats. Examples of adjuvants are aluminum hydroxide, aluminum phosphate, aluminum potassium sulfate, water in oil, saponin, and diethylaminoethyl (DEAE) dextran.

ANAPHYLAXIS A systemic, severe allergic reaction.

ANTIBODY An immunoglobulin molecule that combines with the specific antigen that induced its formation.

ANTIGEN Any substance that can induce a specific immune response, such as toxins, foreign proteins, bacteria, and viruses.

AVIRULENT The inability of an infectious agent to produce pathologic effects.

BACTERIN A killed bacterial vaccine.

MONOVALENT A vaccine, antiserum, or antitoxin developed specifically for a single antigen or organism.

PASSIVE IMMUNITY Immunity that occurs by administration of antibody produced in another individual.

POLYVALENT A vaccine, antiserum, or antitoxin active against multiple antigens or organisms; mixed vaccine.

PRESERVATIVE A substance, such as an antibiotic, antiinfective, or fungistat, that is added to a product to destroy or inhibit multiplication of microorganisms.

RECOMBINANT DNA TECHNOLOGY A process that removes a gene from one organism or pathogen and inserts it into the DNA of another. This also may be referred to as *gene splicing*.

VIRULENCE The ability of an infectious agent to produce pathologic effects.

PRINCIPLES OF VACCINATION

Keeping animals healthy through the proper use of immunization programs is an important aspect of veterinary medicine. Veterinary technicians must have knowledge concerning vaccine types and the diseases animals are vaccinated against. Clients ask many questions regarding this area of their pet's care. It should be remembered that immunization should never take the place of regularly scheduled, routine veterinary checkups (McCurnin and Bassett, 2006). As animals age into their geriatric years, regular laboratory profiles should be done to determine the health of major organ systems. Preventive medicine also includes a good physical examination along with obtaining a complete history on the animal. Therefore, immunization programs are only one aspect of the overall health care that should be afforded companion animals. Livestock should be properly immunized to achieve a healthy herd.

Vaccinations are an important part of the preventive health care program for companion animals and food animals alike. Vaccines are given to lessen

the chance for a particular disease to occur. A patient's response is determined by several factors such as (1) the health and age of the patient, (2) the type of vaccine given, (3) the route of administration, (4) concurrent incubation of infectious disease, (5) exposure to an infectious disease before complete immunity is reached, and (6) drug therapy. The ideal vaccine is safe and effective on challenge and has no undesirable side effects. Immunology is a very complex field of study. This chapter outlines only the basics of common vaccines and immunostimulants. Reference to an immunology textbook may be helpful if further information is desired.

In properly vaccinated females, antibodies are passed to their offspring in the form of maternal antibodies found in colostrum. It is important not to vaccinate very young animals when maternal antibodies are still present. The neonate's immune system is not capable of producing an immune response when maternal antibodies are blocking this mechanism. (See the charts within this chapter for specific times that various species should be vaccinated.)

Hidden page

COMMON VACCINE TYPES THAT PRODUCE ACTIVE IMMUNITY



Inactivated

In the manufacture of inactivated vaccines, organisms are treated most commonly by chemicals that kill the organisms, but very little change occurs in the **antigens**, which stimulate protective immunity. Inactivated vaccines are also referred to as *killed*, or *dead*, vaccines.

Advantages

1. Inactivated vaccines are usually very safe.
2. They are stable in storage.
3. They are unlikely to cause disease through residual virulence.

Disadvantages

1. Inactivated vaccines require repeated doses to achieve adequate protection.
2. Adjuvants may cause severe local reactions.
3. If repeated doses are required, costs may be higher.
4. Inactivated vaccines contain **preservatives** such as penicillin, streptomycin, and fungistats.

Examples

Leukocell 2: Feline leukemia virus

Duramune Cv-K: Rabies virus

Vibo-5/Somnugen: *Campylobacter fetus*, leptospirosis, *Haemophilus somnus*, **bacterin**

See vaccine charts within this chapter for a more comprehensive listing of the various vaccine types associated with each disease.



Live

A live vaccine is prepared from live microorganisms or viruses. These organisms may be fully **virulent** or **avirulent**. Few vaccines of this origin are in use, with the exception of several poultry vaccines.

Advantages

1. Live vaccines necessitate fewer doses to achieve an immune response.
2. Adjuvants are unnecessary, but the vaccine may contain preservatives.
3. Live vaccines pose less risk of allergic response.
4. They are inexpensive.

Disadvantages

1. Live vaccines may be contaminated with unwanted organisms.
2. They require careful handling. For example, accidental injection, ingestion, or exposure through a cut or the mucous membranes of brucellosis vaccine can cause undulant fever in humans.
3. They do not store as well as inactivated vaccines.
4. They may possess residual virulence.

Examples

Brucella abortus vaccine: *Brucella abortus* strain RB-51

Ovine ecthyma vaccine: Ovine ecthyma virus or sore mouth infection

Chick Ark Bronc: Infectious bronchitis (Massachusetts and Arkansas types)

Protex-Bb: *Bordetella bronchiseptica*

See vaccine charts within this chapter for a more comprehensive listing of the various vaccine types associated with each disease.



Modified Live

In modified live vaccines, organisms undergo a process (attenuation) to lose their virulence so that when introduced to the body via inoculation, they cause an immune response instead of disease.

Advantages

1. Effective vaccines for many viruses can be developed through attenuation of the causative virus.
2. Immunity is comparable in response and longevity to killed products.

Disadvantages

1. Modified live vaccines may cause abortion when given to pregnant animals.
2. Some vaccines can cause mild immunosuppression.
3. Residual virulence can cause a mild form of the disease.
4. These vaccines contain preservatives such as penicillin, gentamicin, thimerosal, or a fungistat.

Examples

Eclipse 3: Feline rhinotracheitis, calicivirus, and panleukopenia

BoviShield 4: Infectious bovine rhinotracheitis (IBR) virus, bovine virus diarrhea (BVD), parainfluenza 3 (PI3) virus, bovine respiratory syncytial virus

See vaccine charts within this chapter for a more comprehensive listing of the various vaccine types associated with each disease.

**Recombinant**

In recent years, vaccines produced by **recombinant DNA technology** have become available for veterinary medicine. These vaccines are recognized as being safe, highly specific, potent, pure, and efficacious. These attributes may be the reason why recombinant vaccines are more desirable than any other vaccine type. Recombinant vaccines are divided into three categories:

Type I recombinant (subunit) vaccines—These vaccines are derived by inserting a foreign gene from a specific pathogen into a recombinant organism (e.g., yeast, bacterium, a virus). The recombinant organism multiplies, and the product of the gene is extracted, purified, and prepared for administration as a vaccine.

Type II recombinant (gene-deleted) vaccines—The manufacturing of these vaccines involves deletion of specific genes from a pathogenic organism. This manipulation produces a vaccine that has a low risk of producing disease but can still stimulate a protective immune response.

Type III recombinant (vectored) vaccines—These vaccines are derived from the insertion of specific pathogenic genetic material into a nonpathogenic or gene-deleted organism (e.g., poxvirus). This altered organism then is propagated in vitro and is used to manufacture the vaccine (Van Kampen, 1998).

Advantages

1. These vaccines produce fewer adverse effects.
2. They provide effective immunity.
3. Type I and Type III vaccines cannot revert to virulence because of the way they are manufactured.
4. Some of these vaccines can be administered orally.

Disadvantages

1. Currently, few recombinant vaccines are available.
2. New technology often brings with it a higher cost.

Examples

Type I

RM Recombitek Lyme: *Borrelia burgdorferi*

Type III

RM Recombitek C4: Canine distemper, adenovirus type 2, parainfluenza, and parvovirus

Raboral V-RG: Oral vaccine for rabies virus (used in baiting devices for wildlife)

Newcastle disease—fowl pox vaccine (recombinant): Newcastle disease and fowl pox

Trovac-AIV H5: Avian influenza subtype H5 and fowl pox

See vaccine charts within this chapter for a more comprehensive listing of the various vaccine types associated with each disease.

**Toxoid**

A **toxoid** is a vaccine that is used to produce immunity to a toxin rather than a bacterium or a virus. The toxin is treated with heat or chemicals to destroy its damaging properties without eliminating its ability to stimulate **antibody** production.

An anaculture combines toxoid and killed bacteria in a single dose prepared from highly toxigenic cultures and culture filtrates.

Characteristics

1. Toxoids and anacultures provide protection for up to 1 year.
2. Toxoids may contain adjuvants.
3. Many toxoids contain preservatives such as phenol, thimerosal, and formaldehyde solution.

Examples

Tetanus toxoid: *Clostridium tetani*

Tetnogen: *C. tetani*

Fermicon CD/T: *Clostridium perfringens* types C and D, and *C. tetani*

COMMON VACCINE TYPES THAT PRODUCE PASSIVE IMMUNITY



Antitoxin

An antitoxin is a specific antiserum aimed at a toxin that contains a concentration of antibodies extracted from the blood serum or plasma of a hyperimmunized, healthy animal (usually a horse).

Characteristics

1. An antitoxin neutralizes toxins produced by microorganisms.
2. It may contain preservatives such as thimerosal, phenol, or oxytetracycline.
3. Antitoxins produce immediate **passive immunity**.
4. Immunity is short lived (about 7 to 14 days).
5. Biologic products of equine origin may be associated with the development of equine serum hepatitis (Theiler's disease). This link has not been proved, but clients should be made aware of the possible risk before these products are administered.

Examples

Clostratox BCD: *C. perfringens* types C and D

Tetanus antitoxin: *C. tetani*



Antiserum

An antiserum is a serum that contains specific antibodies extracted from a hyperimmunized animal (usually a horse) or an animal that has been infected with microorganisms that contain antigen.

Characteristics

1. An antiserum kills living, infectious antigens.
2. It may contain preservatives such as phenol, thimerosal, or oxytetracycline.
3. An antiserum produces immediate passive immunity.
4. Do not vaccinate within 21 days after antiserum is given. For example, if a calf is treated with a *Corynebacterium*–*Escherichia coli*–*Pasteurella*–*Salmonella* antiserum, then that calf should not be vaccinated with BVD, IBR, PI3, *H. somnus*, or *Pasteurella haemolytica* within 21 days of receiving the antiserum.
5. Immunity is short lived.

Examples

Erysipelothrix rhusiopathiae serum antibodies:

E. rhusiopathiae

Escherichia-Colicin-B: *E. coli*

Septi-Serum: *Salmonella typhimurium*

OTHER TYPES OF VACCINES



Autogenous Vaccine

An autogenous vaccine contains organisms isolated from an infected animal on a farm where a disease problem is occurring. This carefully prepared vaccine contains antigens needed for protection at that particular location.



Mixed Vaccine

A mixed vaccine contains a mixture of different antigens. It is also referred to as a **polyvalent** vaccine. Each component of a mixed vaccine is required to achieve an immune response comparable

with that of a vaccine containing a single antigen (**monovalent** vaccine).

ADMINISTRATION OF VACCINES

The intramuscular and subcutaneous routes are by far the most common methods for vaccine administration. These routes are easily accessible and provide systemic immunity, which is important in many diseases. Some diseases also respond well to local immunity. Vaccines against feline rhinotracheitis and calicivirus, canine infectious tracheobronchitis, and infectious bovine rhinotracheitis may be administered intranasally or, in some cases, intraocular administration may be used to provide local immunity. After administration of these vaccines, the animal may experience a slight bout of watery eyes and occasional sneezing for a few days.

All of the previously mentioned routes of vaccine administration necessitate that each animal be handled individually. When a large number of animals require vaccination, these routes may not be feasible. Some vaccines may be mixed with drinking water or feed. Others can be aerosolized and inhaled by the animal. For example, on mink ranches, vaccine for canine distemper and mink enteritis may be administered in this manner, or poultry houses may vaccinate for Newcastle disease by aerosolization. The margin for incomplete vaccination is greater when aerosolization or mixing with feed or water is used. Some animals may not drink or eat enough to acquire adequate protection, or the aerosolized vaccine may not distribute equally throughout the room. Vaccine failure may be implicated if these animals contract the disease, whereas in reality, the animal did not receive enough vaccine to gain adequate immunity.

When conventional measures are used for vaccination, it is very important to carefully read the insert provided with the vaccine. Some vaccines may be administered intramuscularly or subcutaneously, but others may be administered by only one route. For example, some rabies vaccines require administration by an intramuscular route to be

most effective. Subcutaneous injections should be given according to the manufacturer's instructions. Care should be used when one is vaccinating a cat to prevent vaccine-induced tumors.

If a vaccine requires reconstitution, this should be done with the diluent provided by the manufacturer. The vaccine should not be reconstituted until just before it is administered (see Chapter 2 for the proper reconstitution procedure). The full recommended dose should be given. Splitting a vaccine dose may cause an animal to fail to develop an adequate immune response and may lower its protection.

Mixing different vaccines to minimize the number of injections the animal receives is not recommended. This procedure can cause antigen blocking, resulting in one component's interfering with the action of another, so that the animal does not receive adequate antigen to attain an effective immune response. Mixing of different vaccines may cause an increased chance of an allergic response. When different types of vaccines are administered, each vaccine should be administered at a separate site. It is also advisable to note the locations of administration and vaccine lot numbers on the patient's medical record. If a reaction or a problem develops later, a reference will be available to aid in evaluation of the problem.

When food animals are vaccinated, several things must be considered. Almost all vaccine labels contain information advising not to vaccinate within 21 days of slaughter. Vaccines such as those for *B. abortus* are subject to federal limitations and regulations, and complete records are maintained on administration of these vaccines. Brucellosis vaccines are restricted to use by or under the direction of a licensed veterinarian. Carcass destruction is also a factor that involves food animal producers. Injection site lesions may cause damage to muscle tissue, requiring that area to be trimmed and discarded. If a vaccine may be administered intramuscularly or subcutaneously, the subcutaneous route would produce less tissue reaction and would eliminate muscle damage. This is important when one is dealing with animals used for meat consumption. Most vaccines on the market today can be given subcutaneously.

BIOLOGIC CARE AND VACCINE FAILURE

Biologics (especially modified live and live vaccines) are sensitive to inactivation by heat or sunlight. Clients purchasing vaccines should be provided with a cold pack if needed and should be warned against leaving such biologics in vehicles or in sunlight, where they may become warm and inactivated. Even the performance of killed products can be altered if proper handling and storage measures are not practiced. When these vaccines are shipped from the manufacturer, cold packs are put in the box to provide some refrigeration during shipment. In some areas, it may be advisable to anticipate how much vaccine may be needed during the hot summer months and to stock up on that amount during early spring to prevent shipments from overheating during summer transportation. Once a shipment is received, it should be quickly unpacked and placed under refrigeration. Vaccines should never be frozen because cells may rupture when the vaccine thaws, releasing toxins that can damage tissue or cause tissue death.

Inappropriate care of vaccines may lead to inactivation of the vaccine and may be perceived as a vaccine failure. Actual vaccine failure is relatively uncommon. If vaccines are purchased from a reputable manufacturer, one can be fairly sure that the vaccine provided is good. Failure usually occurs because of improper handling, storage, or administration.

Live vaccines are especially affected by concurrent antibiotic therapy. Live and modified live vaccines can be inactivated by chemicals used to clean or sterilize syringes and by the use of excessive alcohol or other disinfectants to swab the skin before injection. As was mentioned earlier, the route of administration may affect the ability of an animal to achieve an adequate immune response. Immunosuppressed, parasitized, stressed, or malnourished animals and those incubating disease are not able to mount an adequate immune response to prevent disease. Clients should always be advised that such problems can occur. In most cases, an adequate immune response is not achieved before 10 to 14 days. An 8-week-old puppy may not develop a strong immune response to protect

against an infectious disease if challenged by maternal antibodies because it is not feasible to check immune titers to determine the presence of maternal antibodies. Therefore, it is recommended that puppies receive boosters every few weeks until they are about 4 to 5 months of age. Boosters allow vaccines to produce an optimum immune response. Clients often find it difficult to understand why they need to bring their pet in for boosters. If the reasons are explained and if clients are advised about why they should isolate their pet from animals with questionable vaccination histories, many cases of infectious disease would be prevented among young animals. Clients often perceive one vaccine to be enough or do not understand that their animal is not protected immediately after an injection has been received. Technicians should include this information when educating clients on animal and pet care.

ADVERSE VACCINATION RESPONSES

The most notable risks involving vaccination include residual virulence and toxicity, allergic reactions resulting from hypersensitivity, disease in immunosuppressed animals, possible effects on a fetus, and abortion. The veterinarian assesses these risks before a vaccine is administered. In most cases, the benefits of vaccination far outweigh the risks, but it may occasionally be necessary to omit or delay vaccination because of some of the factors just mentioned.

One of the most common reactions noted with vaccine administration is the sting felt by the animal after injection. This is most often caused by inactivating agents used in manufacturing the vaccine. Manufacturers are constantly researching ways to decrease these undesirable effects while still producing a quality product. This stinging reaction is short lived and does not usually cause a problem unless the animal reacts violently. Other common but not usually serious reactions include a slight fever, lethargy, and soreness at the injection site. These usually subside within 1 day. Hypersensitivity may be caused by several factors, including

Hidden page

BOX 17-1 General Outline of a Preventive Health Program for Dogs

- I. First office visit for health program—usually at 6 wk of age
 - A. Conduct a general physical examination and record body weight
 - B. Check for external parasites and dermatophytes, and initiate appropriate therapy
 1. Fleas, ticks, ear mites (*Otodectes cynotis*)
 2. Mange mites, especially *Demodex canis* and *Sarcoptes scabiei*
 3. Dermatophytes, particularly *Microsporum* spp. and *Trichophyton mentagrophytes*
 - C. Conduct fecal examination including both direct smear and flotation
 - D. Initiate administration of heartworm preventive management
 - E. Administer an anthelmintic for hookworms and roundworms and, if tapeworms are present, administer praziquantel or epsiprantel
 - F. Vaccinate with DA₂PL-PC* and, possibly, with kennel cough vaccine,[†] canine Lyme borreliosis vaccine, and *Giardia* vaccine
 - G. Advise on nutrition and routine grooming
 - H. Provide owner with client education pamphlets on topics such as the following:
 1. Identification, treatment, and control of fleas, ticks, and ear mites
 2. Benefits of preventive management for canine heartworm disease
 3. Dental, skin, nail, and ear care
 4. "How to" on grooming and nutrition
 5. Management of normal and abnormal puppy behaviors
 6. Exercise and its importance
 - I. Fill in the puppy's health record for the owner
- II. Second office visit for health program—usually at 9 wk of age
 - A. Conduct a general physical examination and record body weight
 - B. Check for external parasites and dermatophytes, and initiate appropriate therapy
 1. Fleas, ticks, ear mites (*O. cynotis*)
 2. Mange mites, especially *D. canis* and *S. scabiei*
 3. Dermatophytes, particularly *Microsporum* spp. and *T. mentagrophytes*
 - C. Conduct fecal examination including both direct smear and flotation
 - D. Adjust dosage of heartworm preventive according to body weight
 - E. Administer an anthelmintic for hookworms and roundworms and, if tapeworms are present, administer praziquantel or epsiprantel
 - F. Vaccinate with DA₂PL-PC* and, possibly, with kennel cough vaccine,[†] canine Lyme borreliosis vaccine, and *Giardia* vaccine
 - G. Adjust nutrition according to health needs and, if needed, change grooming procedures
 - H. Provide owner with client education pamphlets on topics such as the following:
 1. Identification, treatment, and control of fleas, ticks, and ear mites
 2. Dental, skin, nail, and ear care
- III. Third office visit for health program—usually at 12 wk of age
 - A. Conduct a general physical examination and record body weight
 - B. Check for external parasites and dermatophytes, and initiate appropriate therapy
 1. Fleas, ticks, ear mites (*O. cynotis*)
 2. Mange mites, especially *D. canis* and *S. scabiei*
 3. Dermatophytes, particularly *Microsporum* spp. and *T. mentagrophytes*
 - C. Conduct fecal examination including both direct smear and flotation
 - D. Adjust dosage of heartworm preventive according to body weight
 - E. Administer an anthelmintic for hookworms and roundworms and, if tapeworms are present, administer praziquantel or epsiprantel
 - F. Vaccinate with DA₂PL-PC* and, possibly, with kennel cough vaccine,[†] canine Lyme borreliosis vaccine, and *Giardia* vaccine
 - G. Adjust nutrition according to health needs and, if needed, change grooming procedures
 - H. Provide owner with client education pamphlets on topics such as the following:
 1. Identification, treatment, and control of fleas, ticks, and ear mites
 2. Dental, skin, nail, and ear care

Continued

Hidden page

BOX 17-2 General Outline of a Preventive Health Program for Horses**First Quarter: January-March***All Horses*

Deworm at least every 8 wk. Exercise care in choice of anthelmintics for mares in the third trimester. Begin deworming foals at 2 mo of age. Trim feet every 6 wk; more frequently in foals requiring limb correction.

Dentistry: check twice yearly and float teeth as needed. Remove wolf teeth in 2-yr-olds and retained caps in 2-, 3-, and 4-yr-olds.

Immunize for respiratory disease: influenza, strangles, and rhinopneumonitis.

In southeastern United States immunize for equine encephalitis.

Stallions

Perform complete breeding examination. Maintain stallions under lights if being used for early breeding.

Pregnant Mares

Immunize with tetanus toxoid, and open sutured mares 30 days prepartum. Develop a colostrum bank. Ninth-day breeding only for mares with normal foaling history and normal reproductive tract. Wash udders of foaling mares.

Open Mares

Maintain under lights if being used for early breeding. Perform daily teasing. Perform reproductive tract examination during estrus. Mares should not be too fat but in gaining condition during breeding season.

Newborn Foals

Dip navel in disinfectant.

Carefully, give a cleansing enema at birth.

Administer tetanus prophylaxis if indicated by history.

Perform immunoglobulin test at 12-24 hr.

Second Quarter: April-June*All Horses*

Deworm at least every 8 wk.

Trim feet every 6 wk. Do not forget the foals and yearlings.

Dentistry: check teeth and remove or float teeth as needed.

Immunize for equine encephalomyelitis. Administer appropriate vaccine boosters.

Stallions

Maintain an exercise program.

Monitor the semen quality.

Broodmares

Palpate at 21, 42, and 60 days after successful breeding.

Foals

Creep-feed the foals and provide free-choice minerals. Immunize at 3 mo of age.

Group foals by gender and size when weaned.

Third Quarter: July-September*All Horses*

Deworm at least every 8 wk. Clip and sweep the pastures.

Trim feet every 6 wk. Continue corrective trimming on foals.

Dentistry: check teeth and remove or float teeth as needed.

Stallions

Maintain an exercise program.

Broodmares

Administer rhinopneumonitis boosters to pregnant mares according to manufacturer's labeled directions. Administer appropriate vaccine boosters to foals and yearlings.

Check condition of mare's udder at weaning, and reduce amount of feed given until milk flow is reduced.

Foals

Administer all appropriate immunizations. Provide free-choice minerals. Maintain a protein supplement in creep feeders.

Fourth Quarter: October-December*All Horses*

Deworm at least every 8 wk. Select anthelmintic appropriate for season.

Trim feet every 6 wk. Continue corrective trimming on foals.

Dentistry: check teeth and remove or float teeth as needed.

Stallions

Continue exercise program.

Check immunizations.

Perform breeding examination.

Broodmares

Confirm pregnancy.

Begin treating open mares.

Check immunizations.

BOX 17-3 General Outline of a Preventive Health Program for Cat

- I. First office visit for health program (usually at 8-10 wk of age)
 - A. Perform a general physical examination and record body weight
 - B. Check for external parasites and dermatophytes, and initiate appropriate therapy for the following:
 1. Fleas and ear mites (*Otodectes cynotis*)
 2. Mange mites, especially *Notoedres cati*, *Demodex* spp., and *Cheyletiella* spp.
 3. Dermatophytes, particularly *Microsporum* spp. and *Trichophyton mentagrophytes*
 - C. Perform fecal examination, including both direct smear and flotation
 - D. Administer anthelmintics, such as pyrantel pamoate for roundworms and hookworms and praziquantel or epsiprantel for tapeworms (if present)
 - E. Vaccinate with FVRC-P,* *Chlamydia*,[†] FeLV,[‡] rabies, FIP,[§] *Bordetella*, and *Giardia* vaccines
 - F. Advise on nutrition and routine grooming
 - G. Provide owner with client education pamphlets on topics such as the following:
 1. Identification, treatment, and control of fleas, ticks, and ear mites
 2. Benefits of vaccination for FeLV infection
 3. Dental, skin, nail, and ear care
 4. Management of normal and abnormal cat behaviors
 5. Exercise and its importance
 6. Recommendations for spaying, castration, and declawing
 - H. Fill in the kitten's health record for owner
- II. Second office visit for health program (usually at 12-14 wk of age)
 - A. Perform a general physical examination and record body weight
 - B. Check for external parasites and dermatophytes, and initiate appropriate therapy for the following:
 1. Fleas and ear mites (*O. cynotis*)
 2. Mange mites, especially *N. cati*, *Demodex* spp., and *Cheyletiella* spp.
 3. Dermatophytes, particularly *Microsporum* spp. and *T. mentagrophytes*
 - C. Perform fecal examination (fecal flotation)
 - D. Administer an anthelmintic, according to fecal examination findings
 - E. Vaccinate with FVRC-P,* *Chlamydia*,[†] FeLV,[‡] rabies, FIP,[§] *Bordetella*, and *Giardia* vaccines
 - F. Adjust nutrition and grooming procedures
- III. Subsequent visits for health program (usually annual visits)
 - A. Perform a general physical examination and record body weight
 - B. Check for external parasites and dermatophytes, and initiate appropriate therapy for the following:
 1. Fleas and ear mites (*O. cynotis*)
 2. Mange mites, especially *N. cati*, *Demodex* spp., and *Cheyletiella* spp.
 3. Dermatophytes, particularly *Microsporum* spp. and *T. mentagrophytes*
 - C. Perform fecal examination (fecal flotation)
 - D. Administer an anthelmintic, according to fecal examination findings
 - E. Vaccinate with FVRC-P,* *Chlamydia*,[†] FeLV,[‡] rabies, FIP,[§] *Bordetella*, and *Giardia* vaccines
 - F. Adjust nutrition and grooming procedures

BOX 17-3 General Outline of a Preventive Health Program for Cat

- | | |
|--|---|
| <p>G. Provide owner with client education pamphlets on topics such as the following:</p> <ol style="list-style-type: none"> 1. Identification, treatment, and control of fleas, ticks, and ear mites 2. Benefits of vaccination for FeLV infection 3. Dental, skin, nails, and ear care | <ol style="list-style-type: none"> 4. Management of normal and abnormal cat behaviors 5. Exercise and its importance 6. Recommendations for spaying, castration, and declawing <p>H. Fill in the cat's health record for owner</p> |
|--|---|

FeLV, Feline leukemia virus; FIV, feline immunodeficiency virus; FIP, feline infectious peritonitis.

* FVRCP refers to the use of a vaccine to protect against feline viral rhinotracheitis (FVR); feline calicivirus infection (C); and feline panleukopenia (P).

† Cats being prepared for shipment or entering a boarding kennel, veterinary hospital, or clinic should be vaccinated at least 1-2 wk before admission or shipment.

‡ The vaccine currently available apparently produces effective protection only against *Chlamydia psittaci* infections. As with other vaccines for respiratory ailments, complete protection is not afforded; however, clinical signs of conjunctivitis or upper respiratory tract disease, if they do occur, can be restricted to short courses and are mild.

§ Refers to the use of a vaccine to protect against FeLV infection. FeLV and FIV vaccines are administered subcutaneously in healthy kittens or older cats as two doses, with the second dose given 3 or 4 wk after the first. Annual revaccination with a single dose is recommended.

|| The Primucell-FIP Vaccine (Pfizer Animal Health) is administered intranasally to healthy cats. Primary vaccination with two doses should be given with the second dose administered 3-4 wk after the first, and single-dose annual revaccination is recommended.

From McCurnin DM, Bassett JM: Clinical textbook for veterinary technicians, eds, Philadelphia, 2002, WB Saunders.

BOX 17-4 General Outline of a Preventive Health Program for Beef Cattle**Cow-Calf Herd Recommendations****At Birth*

Ingestion of colostrum within the first few hours after birth is an important factor in baby calf survival. Immunize with oral bovine rotavirus and coronavirus enteric disease vaccine if a calf diarrhea problem exists in the herd.

1- to 3-Mo-Old Calves

Immunize with a seven-way clostridial disease product. Deworm with commercial product that is safe for calves.

Prewaning Calves

Deworm with broad-spectrum commercial dewormer, and immunize as follows:

Immunizing Vaccine	Age for Vaccine Administration
<i>Brucella abortus</i> , strain RB-51 (calfhood vaccination—replacement heifers only)	4-12 mo
Clostridial diseases: <i>Clostridium perfringens</i> types C and D, <i>C. chauvoei</i> , <i>C. novyi</i> , <i>C. septicum</i> , <i>C. sordellii</i>	5-6 mo
IBR and P1-3 respiratory diseases (inactivated vaccines only)	5-6 mo, booster at 12-13 mo
BVD (inactivated vaccines only)	5-6 mo, booster at 12-13 mo
BRSV	5-6 mo, booster at 12-13 mo

Continued

BOX 17-4 General Outline of a Preventive Health Program for Beef Cattle **cont'd****Weaning Calves**

Deworm with broad-spectrum commercial dewormer, and treat for lice and grubs. Castrate the bull calves.
Immunize with *Pasteurella* and *Haemophilus* (optional) vaccines.

Prebreeding Replacement Heifers

Deworm with broad-spectrum commercial dewormer and treat for lice. Immunize as follows:

Immunizing Vaccine	Time of Vaccine Administration
IBR and P1-3 respiratory diseases	10-12 mo
Clostridial diseases:	10-12 mo
<i>C. perfringens</i> types C and D, <i>C. novyi</i> , <i>C. septicum</i> , <i>C. sordellii</i> , <i>C. chauvoei</i>	
BVD	10-12 mo
BRSV	10-12 mo
Leptospirosis	10-12 mo
Campylobacteriosis	10-12 mo

Prebreeding Cows

Deworm with broad-spectrum dewormer and treat for lice. Immunize for leptospirosis and campylobacteriosis.

Precalving Cows

Immunize as follows:

Immunizing Vaccine	Time of Vaccine Administration
IBR and P1-3 respiratory diseases (inactivated vaccines only)	Before calving
BVD (inactivated vaccine only)	Before calving
BRSV	Before calving
Bovine rotavirus and coronavirus enteric diseases	Before calving
<i>Escherichia coli</i> enteric diseases	Before calving
Clostridial diseases:	Before calving
<i>C. perfringens</i> types C and D, <i>C. chauvoei</i> , <i>C. novyi</i> , <i>C. septicum</i> , <i>C. sordellii</i>	

Bulls

Deworm annually with broad-spectrum dewormer, and treat for lice and grubs. Immunize as recommended for prebreeding replacement heifers annually (see the above section).

Feedlot Recommendations***On Arrival into the Feedlot**

Deworm with a broad-spectrum dewormer and immunize for IBR, P1-3, BVD, BRSV, and clostridial diseases (use seven-way vaccine). Inactivated IBR, P1-3, and BVD vaccines are the safest.

3-4 Wk After Arrival into the Feedlot

Implant a commercial implant product. Treat for lice and grubs. Administer booster immunizations if necessary. Abort the heifers if necessary. Castrate and dehorn if necessary.

BRSV, Bovine respiratory syncytial virus; BVD, bovine virus diarrhea; IBR, infectious bovine rhinotracheitis; P1-3, parainfluenza-3.

* Other optional vaccines that may be incorporated into the immunization program, depending on individual herd needs and diseases endemic to the area, include anthrax and anaplasmosis.

† Other optional vaccines that may be incorporated into the immunization program, depending on individual herd needs and diseases endemic to the area, include *Haemophilus somnus*, *Pasteurella* spp., leptospirosis, and anthrax.

From McCurnin DM, Bassett JM: Clinical textbook for veterinary technicians, eds, Philadelphia, 2002, WB Saunders.

BOX 17-5 General Outline Preventive Health Program for Dairy Cattle

Calves

At Birth

Immunize with bovine rotavirus and coronavirus enteric disease vaccine,[†] and administer *Escherichia coli* enteric disease vaccine orally.

Weaning Age (about 2 mo) to Breeding Age (about 15 mo)

Immunizing Vaccine

Brucella abortus, strain RB-51 (calfhood vaccination—replacement heifers only)

Age for Vaccine Administration

4-12 mo

Clostridial diseases:

Clostridium perfringens types C and D,
C. chauvoei, *C. novyi*, *C. septicum*, *C. sordellii*

2-4 mo, booster in 2 wk

IBR and P1-3 respiratory diseases

4-6 mo, booster at 12-13 mo

BVD

6-8 mo, booster at 12-13 mo

BRSV

6-8 mo, booster at 12-13 mo

Leptospirosis

4-6 mo, booster in 2 wk

Campylobacteriosis

4-6 mo, booster at 12-13 mo

Fresh Cows and Heifers

Immunizing Vaccine

Time of Vaccine Administration

IBR and P1-3 respiratory diseases (inactivated vaccines only)

30 days postpartum

BVD (inactivated vaccines only)

30 days postpartum

BRSV

30 days postpartum

Leptospirosis

30 days postpartum

Campylobacteriosis

30 days postpartum

Dry Cows and Bred Heifers

The goal of dry cow immunization is to provide optimal protection for the newborn calf.

Immunizing Vaccine

Time of Vaccine Administration

Leptospirosis

At time of dry-off

Bovine rotavirus and coronavirus enteric diseases[†]

At time of dry-off, booster in 2-3 wk

Escherichia coli enteric disease[†]

At time of dry-off, booster in 2-3 wk

Clostridial diseases:

At time of dry-off, booster in 2-3 wk

C. perfringens types C and D, *C. chauvoei*,

C. novyi, *C. septicum*, *C. sordellii*

BRSV, Bovine respiratory syncytial virus; BVD, bovine virus diarrhea; IBR, infectious bovine rhinotracheitis; P1-3, parainfluenza-3.

* Other vaccines that may be incorporated into the vaccination program, depending on individual herd needs and diseases endemic to the area, include *Haemophilus somnus*, *Pasteurella* spp., *Salmonella* spp., *Clostridium haemolyticum*, anthrax, and anaplasmosis.

[†] Use if problem of neonatal calf diarrhea exists on the farm.

From McCurnin DM, Bassett JM: Clinical textbook for veterinary technicians, eds, Philadelphia, 2002, WB Saunders.

BOVINE VACCINES

Bovine respiratory disease complex vaccines

P13

IBR (infectious bovine rhinotracheitis)

BVD (bovine viral diarrhea)

Bovine respiratory syncytial virus

Mannheimia haemolytica (formerly known as

Pasteurella multocida)

H. somnus

Clostridial vaccines

Leptospirosis

Campylobacteriosis (vibriosis)

BOX 17-6 General Outline of a Preventive Health Program for Swine**Prebreeding Recommendations for Boars**

Purchase boars 60 days before intended use. Quarantine new boars for 30 days, then allow fence line contact with gilts and sows for 30 days before breeding. Immunize boars for leptospirosis and erysipelas. Treat for external and internal parasites before breeding.

Prebreeding Recommendations for Sows and Gilts

Immunize for leptospirosis, porcine parvovirus infection,* and pseudorabies* 2-4 wk before breeding. Flush gilts by increasing ovulations. Treat for external and internal parasites before breeding.

Prefarrowing Recommendations for Sows and Gilts

Limit feed intake to about 4 lb per head per day or feed according to condition to avoid overweight sows or gilts at farrowing. Immunize for colibacillosis,* atrophic rhinitis, erysipelas, transmissible gastroenteritis (TGE), porcine rotavirus infection,* and *Clostridium perfringens* type C* according to manufacturer's labeled instructions. Treat for external and internal parasites before farrowing with approved products.

Farrowing Recommendations

Gradually increase feed intake so lactating swine are receiving full feed at peak milk production. (Rule of thumb: Feed daily 1 lb of feed for every pig being nursed [e.g., a lactating sow with a litter of 12 pigs should receive at least 12 lb of feed daily].)

General Recommendations for Pigs**At Birth**

Perform newborn pig procedures (e.g., clip needle teeth, dock tails, castrate, ear-notch, and inject iron dextran).

1 Wk of Age

Immunize for TGE,* rotavirus,* and atrophic rhinitis.

4-5 Wk of Age

Weaning occurs at this time. Immunize for atrophic rhinitis, erysipelas, and *Actinobacillus* infection.*

6-8 Wk of Age

Treat for external and internal parasites with approved products.

Older Than 8 Wk of Age

Repeated treatments for external and internal parasites with approved products may need to be done during the growing-finishing period.

* Dependent on problems in the individual swine herd.

From McCurnin DM, Bassett JM: Clinical textbook for veterinary technicians, eds, Philadelphia, 2002 WB Saunders.

Brucellosis
Trichomoniasis
Anthrax
Anaplasmosis
Enteric diseases
 Bovine rotavirus
 Bovine coronavirus
 E. coli
 Moraxella bovis (pinkeye)

Others

Vaccines are also available for sheep, poultry, and swine (Box 17-6). These animals may be raised in large numbers on farms, and as for cattle-raising operations, vaccination schedules may vary according to the type of conditions and location. Ferrets have become common household pets and should be vaccinated for canine distemper according to the schedule used for dogs. Some rabies

vaccines are approved for use in ferrets. Public health authorities can require a rabies-vaccinated ferret that bites a human to be euthanized and tested for rabies virus.

SWINE VACCINES

Erysipelas
Leptospirosis
TGE (transmissible gastroenteritis)
Porcine rotavirus
C. perfringens (type C)
Neonatal porcine colibacillosis
Porcine proliferative enteritis vaccine
Bordetella
Pasteurella
Actinobacillus
Mycoplasma
Porcine reproductive and respiratory syndrome vaccine (PRRS)

Hidden page



Immunostimulants

Complex Carbohydrates

ACEMANNAN

This is a complex carbohydrate derived from aloe vera.

Clinical Uses

Acemannan is used as an aid in the treatment of fibrosarcoma in cats and dogs. It has also been used for stimulating wound healing and in the treatment of FeLV- and FIV-infected cats.

Dosage Form

Acemannan immunostimulant

Adverse Side Effects

None

Immunomodulatory Bacterins

STAPHYLOCOCCUS PHAGE LYSATE (SPL)

This is prepared by lysing *Staphylococcus aureus* with a polyvalent bacteriophage.

Clinical Uses

SPL is used in the treatment of canine pyoderma and related skin infections with a staphylococcal component.

Dosage Form

Staphage Lysate (SPL)

Adverse Side Effects

These include malaise, fever, chills, and injection site irritation.

PROPIONIBACTERIUM ACNES BACTERIN

This is prepared from killed *Propionibacterium acnes*.

Clinical Uses

P. acnes is used in the treatment of chronic recurrent pyoderma and as an adjunct therapy in the treatment for equine respiratory disease complex. It

also has been used as an adjunctive therapy in the treatment of feline retrovirus infection.

Dosage Forms

1. Immunoregulin
2. Eqstim

Adverse Side Effects

These include malaise, fever, and chills.

MYCOBACTERIAL CELL WALL FRACTION

This is an emulsion of cell wall fractions that are modified to reduce their toxicity and allergic effects.

Clinical Uses

These include the treatment of equine sarcoids and bovine ocular squamous cell carcinoma. It is also used in the treatment of mixed mammary tumors and mammary adenocarcinoma in dogs.

Dosage Forms

1. Regressin-V
2. Nomagen

Adverse Side Effects

These include malaise, fever, and decreased appetite.

Technician's Notes

The effects of immunotherapy may be decreased with the administration of immunosuppressive drugs.

REFERENCES

- Ford RB: Vaccines and vaccinations: issues for the 21st century, *Suppl Compend Contin Educ Pract Vet* 20(8C):19-24, 1998.
- McCurin DM, Bassett J, editors: *Clinical textbook for veterinary technicians*, ed 6, Philadelphia, 2006, WB Saunders.
- Meril website, 2007.
- Van Kampen KR: Recombinant technology, *Suppl Compend Contin Educ Pract Vet* 20(8):28-32, 1998.

Hidden page

Hidden page

Hidden page



KEY TERMS

CHELATING AGENT An agent used in chemotherapy for metal poisoning.

METHEMOGLOBINEMIA The presence of methemoglobin in the blood caused by injury or toxic agents that convert a larger-than-normal proportion of

hemoglobin into methemoglobin, which does not function as an oxygen carrier.

NUTRACEUTICAL Any nontoxic food component that has scientifically proven health benefits.

ALTERNATIVE MEDICINES



Chondroprotectives

Chondroprotectives are substances that are able to decrease the progression of osteoarthritis by providing support to cartilage and promoting its repair.

Polysulfated Glycosaminoglycans

Polysulfated glycosaminoglycan (PSGAG) consists of a repeating chain of hexosamine and hexuronic acid (Boothe, 2001). The complex nature of the molecule allows water to be trapped in hyaline cartilage to provide resistance to compression and resiliency to the proteoglycan and collagen matrix. PSGAGs are extracted for commercial use from the tracheal tissue of the bovine. After intramuscular (IM) injection, PSGAG is deposited in articular cartilage and is preferentially taken up by osteoarthritic cartilage (Plumb, 2005). When used to treat degenerative joint conditions, these PSGAGs increase synovial fluid viscosity and inhibit enzymes that damage cartilage matrix within joints. PSGAGs also reduce inflammation by inhibiting prostaglandin released in joint injury.

Clinical Uses

PSGAG is used in the treatment of noninfectious degenerative or traumatic joint dysfunction and associated lameness of the carpal joints in horses. It also has been used to treat degenerative joint disorders in dogs and lameness in swine.

Dosage Forms

1. Adequan I.A., for intraarticular injection
2. Adequan I.M., for intramuscular injection
3. Adequan Canine
4. Legend

Adverse Side Effects

Adverse side effects are minimal with use of this product.

Technician's Notes

1. Amikacin may be used concurrently with intra-articular use to prevent infection resulting from possible contamination.
2. PSGAG should not be used in horses intended for food.
3. Safety in breeding animals is undetermined.



Nutraceuticals

The American Veterinary Medical Association defines **nutraceutical** medicine as “the use of micronutrients, macronutrients, and other nutritional supplements as therapeutic agents.” In veterinary medicine, the term is generally used to refer to endogenous substances (not botanicals) that have been prepared or synthesized to support bodily functions. The popularity of these products, which may have characteristics of nutrients and pharmaceuticals, has seen tremendous growth in use by people in recent years. The medical community has acknowledged that some of them may have treatment or preventive effects (Boothe, 1997).

As people have become more aware of alternative medical options for themselves, they have come to expect similar options for their pets. Veterinarians and their clients can be expected to use nutraceuticals as treatment options to complement traditional medicine or when traditional treatment options have been exhausted.

Hidden page

Clients should be urged to make use of information regarding nutraceutical quality by making use of the ConsumerLab (www.consumerlab.com) and USP (www.usp.org) websites.

The following is a partial list of the substances marketed as nutraceuticals. Some of these products may not be "endogenous substances" as defined earlier.

Glucosamine and Chondroitin Sulfate

Glucosamine is an amino sugar manufactured by animal cells from glucose and used by the body in the synthesis of glycoproteins and polysulfated glycosaminoglycans. Chondroitin sulfate is a glycosaminoglycan that combines with hyaluronic acid, proteins, and other glycosaminoglycans to form the basic cartilage matrix. Glucosamine and chondroitin sulfate are believed to act synergistically (Davidson, 2000) to exert a positive effect on cartilage metabolism and an inhibition of cartilage breakdown. They have been used extensively in the treatment of osteoarthritis in dogs and horses. Four to six weeks of administration may be necessary for a therapeutic effect to be seen. A common veterinary product that contains these substances is called Cosequin; it is composed of glycosaminoglycan derived from the chitin of crab shell and chondroitin sulfate from bovine trachea. Dasuquin and Dasuquin for Cats are products that contain glucosamine and chondroitin sulfate with avocado/soybean unsaponifiables and decaffeinated tea with claims of enhanced chondroprotection. Glyco-Flex and Syno-Flex derive their glycosaminoglycan from the *Perna canaliculus* mussel.

Fatty Acids

The omega-6 and omega-3 fatty acids are the ones most often found in commercial veterinary fatty acid supplements. Omega-6 fatty acids have double-bond 6 carbons from the methyl end, whereas omega-3 fatty acids have double-bond 3 carbons from the methyl end. Fatty acid supplementation has been shown to be useful in treating certain dermatologic conditions in dogs and cats because of their antiinflammatory effects. Omega-3 fatty acids are normally found in low concentrations in the cellular plasma membrane compared with omega-6

fatty acids, but the omega-3 level can be increased by a food or supplement that is enriched in this substance (Roudebush and Freeman, 2000). The breakdown products of the omega-3 acids are apparently less powerful mediators of the inflammatory response than those derived from the omega-6 fatty acids. The omega-3 and omega-6 fatty acids also may be helpful in treating heart disease, cancer, autoimmune disease, and rheumatoid arthritis. The proper ratio of omega-6 to omega-3 fatty acids in a product has apparently not been determined and is often debated. Fish oil and plant oils are common sources of these fatty acids. Side effects may include increased bleeding times and possible decreased immune function.

S-Adenosylmethionine (SAME)

The SAME SD4 is a molecule produced in the body from methionine and adenosine triphosphate (ATP) by the enzyme SAME synthetase (Davidson, 2002). It is recommended for veterinary use as a dietary supplement to support normal structure and function of the liver. Some studies have shown that this substance increases levels of glutathione in the liver. Glutathione is an antioxidant that may protect liver cells from injury. Denosyl is a SAME product manufactured by Nutramax Laboratories.

Superoxide Dismutase

Superoxide dismutase from protein sources is an oxygen radical scavenger that has been used as an anti-inflammatory agent for musculoskeletal problems.

Coenzyme Q

This substance is an enzyme cofactor of mitochondrial membranes that is important in electron transport and ATP formation. It is used in the treatment of cardiovascular problems.



Herbal Medicines

The use of plants to treat veterinary patients is classified by the American Veterinary Medical Association (AVMA) as a modality in the category of complementary and alternative veterinary medicine (CAVM). The AVMA in its policy guidelines states

Hidden page

Table 18-1 Potential Herb-Drug Interactions

Herb	Interacting Drugs	Result	
St. John's wort	Cyclosporine	Decreased plasma drug concentrations	
	Fexofenadine		
	Midazolam		
	Digoxin		
	Tacrolimus		
	Amitriptyline		
	Warfarin		
	Theophylline		
	Sertraline		Serotonin syndrome
	Buspirone		
	Ginkgo		Warfarin
Heparin			
NSAIDs			
Ginseng	Ormeprazole	Decreased plasma concentrations	
	Warfarin	Bleeding	
	Heparin	Falsely elevated serum digoxin levels (laboratory test interaction with ginseng)	
	NSAIDs	Decreased analgesic effect	
	Opioids	Falsely elevated serum digoxin levels (laboratory test interaction with ginseng)	
Garlic	Warfarin	Bleeding	
Chamomile	Heparin		
Ginger	NSAIDs		

Dried extracts: The plant is simmered in water, strained of residue, and sprayed into a vacuum chamber, which produces a powder or granules. A common extract is a 5:1 extract that allows the use of less product because of the concentrated form. Water extracts may exclude plant substances that are alcohol soluble.

Liquid extracts: The ingredients are extracted in alcohol and the residue discarded. Advantages of alcohol extraction are thought to include concentration of the ingredient and improved absorption from the intestinal tract. Alcohol extractions usually taste bad to pets and must be added to another ingredient to improve palatability.

Most of the current dosing of botanicals for animals is extrapolated from human dosage

information because few herbal products are produced specifically for animals. Dosage recommendations vary between forms and between extract dilutions (e.g., a 1:1 extract will be dosed differently than a 5:1 extract).

Summary of Herbal Medicines

Herbal medicine has added another dimension outside of conventional therapy to the treatment of veterinary patients. Its practice provides a holistic approach to veterinary health care for those veterinarians and clients who wish to use it as an ancillary method, or when conventional methods have been exhausted. Until strict regulation of the botanical industry is achieved, however, veterinary technicians should counsel clients with judicious information about their use. The following factors

may be useful when one is advising clients about herbal use:

- The use of herbal medicine should not be started without discussion of the process with the attending veterinarian.
- Clients should purchase products from reputable manufacturers approved by the National Animal Supplement Council (NASC).
- Clients can find product evaluation information at the ConsumerLab website.
- Recommended dosage should be followed closely.
- Herbs may cause harmful interactions with conventional drugs.
- Herb use may cause bleeding tendencies during surgical procedures.
- Adverse side effects of herbs should be reported to the Veterinary Botanical Medicine Association and to the manufacturer.

Box 18-1 includes a list of useful herbal references.

Technician's Notes

The American Society of Anesthesiology recommends that patients should discontinue all herbal medicines 2 to 3 weeks before elective surgery procedures are performed.

ALOE

Aloe vera is a plant native to Africa that was used as early as 1500 B.C. for the treatment of various conditions and as a cathartic (Wynn and Fougere,

2007). Today, it is used primarily for the treatment of burns and skin inflammation. Some herbalists believe that aloe stimulates wound healing.

BLOODROOT

The rhizome of *Sanguinaria canadensis* has traditionally been used as an expectorant and to treat respiratory conditions like bronchitis, asthma, and laryngitis. It is also reported to have antiinflammatory and antimicrobial effects.

ECHINACEA

Echinacea purpurea is a commonly used remedy for colds and flu in people in the United States and Europe, where research has been done to show that it is an immunostimulant. It is derived primarily from the American coneflower. No major side effects have been reported other than the occasional allergic reaction (Fascetti, 1998).

GARLIC

Garlic is a perennial bulb in the lily family (*Allium sativum*) that is related to the onion. This plant has been used for centuries for its reported medicinal value. People have claimed that it produces disinfectant, diuretic, and/or expectorant effects. Evidence suggests that it does lower cholesterol values in people. No evidence, however, shows that garlic has any value in the treatment of parasites in animals. Garlic can produce Heinz body anemia in cats and possibly in dogs at high dosages.

BOX 18-1 Useful Herbal References

1. National Animal Supplement Council
2. Veterinary Botanical Medicine Association
3. Drug Digest
4. PubMed
5. ConsumerLab
6. Cochrane Collaboration
7. HerbMed
8. American Association of Feed Control Officials
9. American Herbal Products Association

www.nasc.cc
 www.vbma.org
 www.drugdigest.org
 www.pubmed.gov
 www.consumerlab.com
 www.cochrane.org
 www.herbmed.org
 www.aafco.org
 www.ahpa.org

Hidden page

disodium ethylenediaminetetraacetate, and sodium calcium edetate.

Clinical Uses

In veterinary medicine, calcium EDTA is used for the treatment of lead poisoning.

Dosage Forms

1. Calcium Disodium Versenate injection (human label)
2. Meta-Dote

Adverse Side Effects

These include renal toxicity, depression (dogs), and vomiting/diarrhea (dogs). Zinc deficiency may occur from long-term therapy.

Technician's Notes

1. Calcium EDTA should not be used in anuric patients, and caution should be exercised when it is used in patients with renal insufficiency.
2. Calcium EDTA should not be administered orally.
3. Do not confuse with edetate disodium, which may cause severe hypocalcemia.
4. Magnesium sulfate (Epsom salt) or sodium sulfate may be used orally to prevent further intestinal absorption of lead.

Methylene Blue

Methylene blue is a thiazine dye that appears as dark green crystals or crystalline powder with a bronze-like luster. It is an oxidating agent that helps to convert methemoglobin (a compound formed from hemoglobin by oxidation of the iron atom) from the ferrous (Fe^{2+}) to the ferric (Fe^{3+}) state. It does not function as an oxygen carrier to hemoglobin.

Clinical Uses

Methylene blue is used for the treatment of **methemoglobinemia** caused by oxidative agents (e.g., nitrites, nitrates, chlorates) in ruminants. It may be used for cyanide toxicity in ruminants. It can be used in dogs to intraoperatively stain pancreatic islet cell tumors preferentially and for treatment of acetaminophen poisoning.

Dosage Forms

1. Methylene blue injection (generic) (human label)
2. Methylene blue tablets (generic)
3. Methylene blue powder (generic)

Adverse Side Effects

These include the development of Heinz body anemia or morphologic changes in red blood cells and decreased red blood cell life span. Methemoglobinemia may occur but is usually dose and species dependent. Tissue necrosis may occur with subcutaneous administration or extravasation during intravenous injection.

Technician's Notes

1. Methylene blue usually is contraindicated in cats.
2. Dogs and horses may show a greater occurrence of side effects than ruminants.
3. Methylene blue should not be used in patients with renal insufficiency.
4. Safety during pregnancy is unknown.

Acetylcysteine

Acetylcysteine is a white crystalline powder that is soluble in water or alcohol. It also may be referred to as *N*-acetylcysteine or *N*-acetyl-L-cysteine.

Clinical Uses

These include oral therapy for acetaminophen poisoning in dogs and cats. It also may be used as a mucolytic agent for pulmonary (via nebulization) or ophthalmic (via topical application) conditions.

Dosage Forms

1. Mucomyst (human label)
2. Mucosil (human label)
3. Acetylcysteine (human label)

Adverse Side Effects

These include nausea, vomiting, and occasionally urticaria (hives) when administered orally. Chest tightness, bronchoconstriction, bronchial or tracheal irritation, and acetylcysteine hypersensitivity are rare but possible side effects when administered

into the pulmonary tract. Acetylcysteine may cause bronchospasm in some patients receiving treatment via the pulmonary tract.

Technician's Notes

1. Acetylcysteine is incompatible with amphotericin B, chlortetracycline hydrochloride, erythromycin lactobionate, oxytetracycline hydrochloride, ampicillin sodium, tetracycline hydrochloride, iodized oil, hydrogen peroxide, chymotrypsin, and trypsin.
2. Activated charcoal may adsorb acetylcysteine, reducing its effectiveness in treating acetaminophen toxicity.
3. Carefully monitor patients that have bronchospastic diseases and that receive pulmonary treatment.
4. Oral solution has a bad taste, and a masking agent (e.g., colas, juices) may be used.
5. Open vials should be refrigerated and discarded after 96 hours.

Dimercaprol

Dimercaprol is a dithiol chelating agent that occurs as a colorless or nearly colorless viscous liquid with a disagreeable odor. The commercial solution may be cloudy or may contain small amounts of flaky material or sediment. This is normal and does not indicate deterioration of the product. It also may be referred to as BAL, British antilewisite, dimercaptopropanol, or dithioglycerol.

Clinical Uses

Dimercaprol is used primarily for the treatment of toxicity resulting from arsenic compounds but may be used for lead, mercury, or gold toxicity.

Dosage Forms

1. Dimercaprol injection 100 mg/ml (human label)
2. BAL in oil (human label)

Adverse Side Effects

Intramuscular injections are painful. Vomiting and seizures may occur with high doses. It is potentially nephrotoxic. Most side effects subside quickly because of rapid elimination of the drug.

Pralidoxime Chloride

Pralidoxime chloride is a quaternary ammonium oxime cholinesterase reactivator. It reverses the action of cholinesterase inhibitors such as certain organophosphates. It also may be referred to as a 2-PAM chloride or 2-pyridine aldoxime methyl chloride.

Clinical Uses

Pralidoxime chloride is used for oral treatment of organophosphate poisoning. It may be used in conjunction with atropine and supportive therapy.

Dosage Form

Protopam injection (human label)

Adverse Side Effects

These are uncommon, but rapid intravenous injection may cause tachycardia, muscle rigidity, transient neuromuscular blockade, and laryngospasm.

Technician's Notes

1. Pralidoxime, similar to other anticholinesterases, may potentiate the action of barbiturates.
2. Patients with impaired renal function require a lower dose and careful monitoring.

Penicillamine

Penicillamine is a chelating agent of metals such as copper, lead, iron, and mercury. It is a degradation product of penicillins but does not have antimicrobial activity. It also may be referred to as D-penicillamine, B, B-dimethylcysteine, or D,3-mercaptovaline.

Clinical Uses

Penicillamine is used for copper-associated hepatopathy and for long-term oral treatment of lead poisoning and cystine urolithiasis.

Dosage Forms

1. Depen Titratabs, tablets (human label)
2. Cuprimine capsules (human label)

Adverse Side Effects

These include nausea and vomiting. Other rare side effects include fever, lymphadenopathy, skin hypersensitivity reactions, and immune complex glomerulonephropathy.

Technician's Notes

Absorption of penicillamine may be reduced by concurrent administration of food, antacids, or iron salts.

Sodium Thiosulfate

Sodium thiosulfate uses the enzyme rhodanese to convert cyanide to a nontoxic thiocyanate ion, which is excreted in urine.

Clinical Uses

Sodium thiosulfate is used in the treatment of cyanide poisoning in horses and ruminants. It may be used in combination with sodium molybdate for the treatment of copper poisoning in ruminants. It also has been used for the treatment of arsenic poisoning. When applied topically, sodium thiosulfate has antifungal properties.

Dosage Forms

1. Cya-dote Injection
2. Sodium Thiosulfate for Injection 25% (human label)

Adverse Side Effects

These are uncommon.

Technician's Notes

When sodium thiosulfate is administered intravenously, it should be given slowly.

Ethanol

Ethanol is an alcohol that is a competitive inhibitor of ethylene glycol metabolism. It also may be referred to as pure grain alcohol, grain alcohol, or ethyl alcohol.

Clinical Uses

Ethanol is used to treat ethylene glycol (antifreeze) poisoning.

Dosage Form

Ethanol

Adverse Side Effects

Ethanol reduces body temperature and overdose can be fatal.

Technician's Notes

1. A 20% to 50% solution of pure ethanol is administered intravenously until the animal is comatose and does not respond to a toe pinch. Administration is repeated as needed to maintain a comatose state for 3 days.
2. Sodium bicarbonate is usually administered to control metabolic acidosis.

Fomepizole

Fomepizole is a competitive inhibitor of alcohol dehydrogenase. Its action prevents the conversion of ethylene glycol into glycoaldehyde and other toxic metabolites. This allows ethylene glycol to be excreted primarily unchanged. It also may be referred to as 4-methylpyrazole (4-MP).

Clinical Uses

Fomepizole is used to treat ethylene glycol (antifreeze) poisoning in dogs.

Dosage Form

Antizol-Vet

Adverse Side Effects

Clinical signs of possible anaphylaxis include tachypnea, gagging, excessive salivation, and trembling.

Technician's Notes

1. Fomepizole must be diluted with 0.9% NaCl before intravenous injection.
2. Dogs treated within 8 hours of ingestion have a better prognosis than those treated 10 to 12 hours after ingestion (Plumb, 2005).

Hidden page

Hidden page

Hidden page



REVIEW QUESTIONS

- A 2-year-old beagle has clinical signs of lead toxicity and a history to support the diagnosis. Which agent would be the drug of choice for treating this condition?
 - Yohimbine HCl
 - 2-PAM
 - Calcium EDTA
 - Methylene blue
- A client calls and says that she has been giving her cat Tylenol for a limp. Now the cat is breathing fast, its face is swollen, and it is not active. You should tell the client to _____.
 - give the cat hydrogen peroxide orally
 - see whether she can get the cat to eat
 - bring the cat to the hospital to start treatment with hydrogen peroxide
 - bring the cat to the hospital to start treatment with acetylcysteine
- Yohimbine HCl is a reversal agent for _____.
 - rompun
 - acepromazine
 - pentothal
 - oxymorphone
- Penicillamine should be administered _____.
 - with food
 - on an empty stomach
 - with antacids
 - with copper
- Name four drugs that naloxone effectively reverses. _____

- BAL has been administered to a 4-year-old mixed-breed dog for arsenic poisoning. Results of which of the following laboratory tests should be monitored closely?
 - Packed cell volume (PCV)
 - Blood urea nitrogen (BUN)
 - White blood cell count (WBC)
 - Alanine aminotransferase (ALT)
- Glycosaminoglycans occur naturally in what part(s) of the body?
 _____.
- What role do glycosaminoglycans (GAGs) provide in the treatment of degenerative joint conditions?
 _____.
- Define nutraceutical. Give an example.
 _____.
- A product usually is determined to be a drug if its label has a claim that indicates a therapeutic or preventive intent.
 - True
 - False
- What Act made dietary supplements as vitamins, minerals, amino acids, herbal products, and substances that supplement the diet by increasing total dietary intake "food" and excluded them from FDA regulation?
- _____ supplementation has been shown to be useful in treating certain dermatology conditions in dogs and cats.
- What are two possible side effects for using fatty acids as a dietary supplement?
 _____.
- What is activated charcoal used for?
 _____.
- In veterinary medicine, calcium EDTA is used primarily for the treatment of
 _____.
- Petroleum jelly is not recommended as a lubricant because it is not
 _____.
- _____ is a narcotic antagonist used for the treatment, prevention, or control of narcotic depression.
- Flumazenil is used to reverse the effects of
 _____.
- A dietary supplement for support of normal structure and function of the liver is
 _____.

Hidden page

PROACTIVE INVENTORY CONTROL SYSTEM

**KEEPING ACCURATE RECORDS
INVENTORY RECORDS**

Reorder Quantity
Rabies Vaccine

ORGANIZING INVENTORY

Pharmacy and ICM Office
Organizing Inventory in the Veterinary Hospital
Staff Memos
Special Conditions

PHYSICAL INVENTORY

Monthly Inventory Versus Rotating Inventory

PURCHASING INFORMATION

Incoming Freight
FOB Rules and Shipment Contracts
Receiving Freight
Stocking Shelves
Vendors
Communicating With Sales Representatives
DEA Forms
Special Orders
Human Pharmacy

**COMPUTERS AND INVENTORY
THE JOB OF ICM**

CHAPTER 19

Inventory: The Veterinary Technician's Role

LEARNING OBJECTIVES

After studying this chapter, you should be able to:

1. Explain why having an inventory control system is important.
2. Describe ways in which inventory control benefits a business.
3. Explain why inventory turnover is important.
4. Discuss ways of becoming an efficient inventory control manager.
5. Describe various inventory record-keeping systems.
6. Describe the differences in vendor types.
7. Describe good communication techniques that can be used with sales representatives.
8. Discuss ways that veterinary management computer software aids in pharmaceutical inventory.

**KEY TERMS**

AVERAGE COST OF INVENTORY ON HAND Average cost of inventory on hand is determined by adding the year's beginning inventory to the year's ending inventory and dividing by 2.

DEA FORM An official federal government carbon form used for ordering controlled substances.

DELAYED BILLING A benefit that some companies offer the buyer who is purchasing increased amounts of merchandise. The date the statement must be paid is usually longer than 30 to 60 days away.

FIFO First in, first out.

FOB Acronym for "free on board."

FOB DESTINATION Title of possession passes from the pharmaceutical company to the buyer (i.e., the purchaser) when the shipment is delivered to the buyer's business destination (i.e., the veterinary facility).

FOB SHIPPING POINT Title passes from the pharmaceutical company to the purchaser when the vendor places the goods in the possession of the carrier (e.g., United Parcel Service, Federal Express, Averitt Express).

FULL-SERVICE COMPANY A pharmaceutical company that offers full service (e.g., the company employs sales representatives [reps] who visit veterinary facilities), usually with a limited number of products.

INVENTORY The quantity of goods or assets that a veterinary facility possesses, requiring proactive control to keep supplies stable and current.

ICM (INVENTORY CONTROL MANAGER) A person (many times a licensed veterinary medical technician [LVMT]) responsible for monitoring, ordering, and maintaining inventory in a veterinary facility.

INVOICE A form generated by a company that documents the quantity and price of each item ordered by the inventory control manager.

MAIL ORDER DISCOUNT HOUSE A company that accepts orders from the buyer by telephone; a good source for ordering items such as gauze, cotton, isopropyl alcohol, or paper towels.

MARKUP The amount of money over cost that a product sells for. Markup percentages vary from practice to practice, but all markups reflect a retail value over wholesale value.

PACKING SLIP A document supplied by the vendor that accompanies a purchase. A packing slip generally reflects quantities ordered, not prices.

STATEMENT A document generated by the vendor that details the quantity and pricing of all goods purchased (usually in 1 month) by the buyer. The total balance is generally expected to be paid in full within 30 days.

TURNOVER The number of times a product is sold or used up in a veterinary facility. The minimum turnover rate should be established at four times a year.

VETERINARY SUPPLY DISTRIBUTOR An intermediate company (i.e., not full service, not mail order) that generally stocks a large inventory and employs sales representatives who visit veterinary facilities.

INTRODUCTION

Control of **inventory** is an important concern for companies both large and small, and veterinary businesses are no exception. Proactively maintaining pharmaceutical inventory is an ongoing endeavor for veterinary hospitals (Figure 19-1). Deciding how much trade or generic name product to buy, keeping expired items off the shelves, and performing a physical inventory are all integral parts of keeping a veterinary facility functioning as a healthy business. When a product is depleted before the next order arrives, it is frustrating for both veterinary staff and the clientele. When a product

is not available, it cannot be sold and no profit can be made. Deciding which employee to entrust with this responsibility is an important decision for veterinary practice owners that should be made with careful consideration. Therefore, the employee chosen for this job should treat the position with respect and make every effort to be frugal with the employer's money.

The veterinary technician often is the employee chosen to perform this job. Therefore, knowledge of pharmaceuticals and the ability to observe quantities of product used within a month are important talents that the veterinary technician must possess.

at the veterinary facility, and learning about new products. These are only a few of the responsibilities the ICM will meet daily. Inventory should be handled as an ongoing process. Each day, inventory must be visually counted and physical inventory must be done at least once a month for good results.

INVENTORY

Technician's Notes

The value of all assets owned by the veterinary facility has important tax and insurance implications.

FIGURE 19-1

A veterinary technician taking inventory.

Technician's Notes

Along with knowledge of nursing skills, accepting the role of **ICM (inventory control manager)** boosts the veterinary technician's value as an employee.

In our technologically advanced society, pharmaceuticals change rapidly, in that new products are constantly being developed. The veterinary technician who is charged with being the ICM must be willing to learn about new products and to pass this information on to the whole veterinary staff. Communication and good people skills are useful when one is dealing with pharmaceutical sales representatives. Sales reps are invaluable to veterinary practices because they are armed with all available information about drugs, both old and new.

The ICM has many responsibilities. These responsibilities include keeping the staff informed regarding discontinued items, knowing the dates on which back-ordered items will be released from the vendor, packing up goods awaiting return to the vendor (e.g., expired items), rotating stock correctly, maintaining current prices on all products, organizing inventory for easy location and counting, receiving and inspecting orders upon arrival

Accounting of inventory items is very important when one is filing income taxes or in the event of a fire or natural disaster. Veterinary practices providing an accurate inventory of their business assets are assured that their insurance companies will reimburse the business accurately should a disaster occur. The primary goal of inventory is to have sufficient quantities of inventory available to serve clients' needs, while at the same time minimizing the cost of carrying that inventory. Purchasing too many units of a slow-selling item can cost the practice money, and not purchasing enough of a high-selling item can cause stockouts and frustration (Libby, Libby, and Short, 2004) for the veterinary team.

An accounting system plays three roles in the inventory management process:

1. The system must provide accurate information for preparation of periodic financial statements and tax returns.
2. It must provide up-to-date information on inventory quantities and costs, to facilitate ordering decisions.
3. Since inventories are subject to theft and other forms of misuse, the system also must provide the information needed to protect assets.

So what exactly is the definition of inventory? It is tangible property that is sold in the normal course of a business day. In veterinary medicine, this would include such items as antibiotics, anthelmintics,

shampoos, topical medications, prescription feeds, and even the dispensing bottles used to dispense liquid medication, as well as the syringes sold to clients that they must use to orally medicate their pets at home. Dispensing bottles, syringes, needles, ointment tins, and so forth could be classified as raw materials because they are carriers for the actual medicine that is being prescribed and dispensed. However, raw materials cost the practice money, just as pharmaceuticals do. It is just as frustrating to run out of these items as it is to run out of a broad-spectrum antibiotic.

Most veterinary practices use the first in, first out (FIFO) method of inventory. This is not necessarily done by choice, but rather because of the expiration dates on merchandise that the practice sells. Generally speaking, the expiration date that is the earliest should be sold first. A perpetual inventory control system, which is a detailed record for each type of merchandise stocked, shows the following:

- Units and costs of the beginning inventory
- Units and costs of each purchase
- Units and costs of the goods for each sale
- Units and costs of the goods on hand at any point in time

Luckily, most veterinary computer management software programs do the above listed items automatically. In today's business world, inventory is much easier to keep up with than it was in the days of periodic inventory, when businesses did not have computers (Libby, Libby, and Short, 2004). However, it is better to use a balance between a perpetual inventory control system and a periodic inventory because sometimes the amount of each item listed within the computer system may not be a true reflection of what is actually on hand. Nothing can ever take the place of a periodic inventory and physically counting the amount of each item on hand. The primary disadvantage of a periodic inventory system is the lack of inventory information that is available to the practice owner; that is, veterinary management software makes inventory easier because it shows up-to-date amounts of each item sold, along with trends during the summer or winter months that can help staff in deciding how much inventory needs to be purchased in the coming years.

Inventory is an ongoing process, and trends within the practice must be observed daily. The ICM must be able to recognize the products that each veterinarian in the practice uses and dispenses, to ensure that items are on hand when needed. Nothing is more frustrating than needing a drug or other inventory item to treat a patient with, only to find it is not in stock. Computer software designed for the veterinary business can help tremendously with tracking trends within the practice. Most software has the ability to provide printouts of day-by-day, week-by-week, month-by-month, and yearly sales trends (Figure 19-2).

Through establishment of a workable inventory control system within a realistic budget, expenses can be kept at a minimum.

Technician's Notes

For many veterinary practices, inventory represents the second-highest expense. Payroll is usually the highest overhead item.

After determination and implementation of a realistic budget that might be based on the mission statement of the facility and practice needs, followed by implementation of that budget, there will be no danger of running out of inventory items because there always will be sufficient quantities of product on hand. An annual inventory evaluation is beneficial when a vision for the practice and its potential growth has been developed.



The Time Equation

When one is dealing with inventory, no equation is more important than the following:

$$\text{Time} = \text{Money}$$

Although it is important to have merchandise on hand for retail sale, a fine balance is needed to keep products from sitting too long on pharmacy shelves. Products that stay on the shelf for too long will not make money for the veterinary practice. Instead, this is similar to placing money in a jar and burying

INVENTORY REPORT

Code	Description	U/M	Price	On hand	Avg cost	Stock value	Unit cost	Pkg. cost	Codes	Cls	Last sold	Document
May	Jun	Jul	Aug	Sep	Oct	Nov	Dec	Jan	Feb	Mar	Apr	May
ANTHELMINTICS						0.00						
CANINE VACCINES												
100F	Bordetella (Injection)	Ds	0.00	14	0.000	0.00	0.000	0.000			1	
<u>Qty sold Last 12 Months</u>			Aug	Sep	Oct	Nov	Dec	Jan	Feb	Mar	Apr	May
May	Jun	Jul										
100B	Bordetella (Intra-nasal)	Ds	0.00	1	0.000	0.00	0.000	0.000			0	09-28-01
<u>Qty sold Last 12 Months</u>			Aug	Sep	Oct	Nov	Dec	Jan	Feb	Mar	Apr	May
May	Jun	Jul										
9010	DA2PP2CV	Ds	0.00	15	0.000	0.00	0.000	0.000			0	
<u>Qty sold Last 12 Months</u>			Aug	Sep	Oct	Nov	Dec	Jan	Feb	Mar	Apr	May
May	Jun	Jul										
9052	Rabies Vaccine	Ds	0.00	21	0.000	0.00	0.000	0.000			1	
<u>Qty sold Last 12 Months</u>			Aug	Sep	Oct	Nov	Dec	Jan	Feb	Mar	Apr	May
May	Jun	Jul										
CANINE VACCINES						0.00						
MISCELLANEOUS ITEMS												
1007	Large Garbage Sacks	Box	0.00	0	0.000	0.00	0.000	0.000			1	
<u>Qty sold Last 12 Months</u>			Aug	Sep	Oct	Nov	Dec	Jan	Feb	Mar	Apr	May
May	Jun	Jul										
7022	Small Garbage Sacks	Box	0.00	0	0.000	0.00	0.000	0.000			1	
<u>Qty sold Last 12 Months</u>			Aug	Sep	Oct	Nov	Dec	Jan	Feb	Mar	Apr	May
May	Jun	Jul										
7023	Computer Printer Paper	PACK	0.00	0	0.000	0.00	0.000	0.000			1	
<u>Qty sold Last 12 Months</u>			Aug	Sep	Oct	Nov	Dec	Jan	Feb	Mar	Apr	May
May	Jun	Jul										

FIGURE 19-2

AVI-Mark Veterinary Software Management System.

it in the backyard; the money is there, but it is not earning interest and it is not working for you. So it is with inventory products. A fine inventory balance is crucial to the financial health of a business. Besides, clients do not like to buy products that have been sitting on pharmacy shelves for a long time because the labels become smudged and dusty.

A periodic evaluation of inventory is crucial toward keeping the balance in fine adjustment. Items that are not selling well or are used infrequently within the practice should be deleted from the inventory master list and should not be ordered in the future. This is where turnover becomes an important issue.



Turnover

Technician's Notes

Turnover is the number of times a product is sold or used in-house on an annual basis.

Because there are 12 months in a year, the ideal situation is to use all inventory each month and reorder in time to begin the next month. However, in the real world, this simply does not happen.

Technician's Notes

Four turnovers is a workable goal, and 12 turnovers may be set as the ideal goal. A mean turnover rate of eight turns per year is acceptable for most veterinary practices.

Calculating Turnover Rate

The following equation is used to determine turnover rate:

$$\text{Turnover Rate} = \frac{\text{Yearly inventory expense}}{\text{Average cost of inventory on hand}}$$

Example:

$$\frac{\$100,000}{\$20,000} = 5$$

The following equation determines the **average cost of inventory on hand**:

$$\text{Average cost of inventory on hand} = \frac{\text{Year's beginning inventory} + \text{Year's ending inventory}}{2}$$

Example:

$$\frac{\$150,000 + \$35,000}{2} = \$92,500$$

CONTROLLING INVENTORY

Establishing effective inventory control in a veterinary practice necessitates placing a person in charge of ordering and stocking supplies. An additional person trained as a backup is a must because when the ICM goes on vacation or is sick, someone else must be knowledgeable about the system. These two people can work effectively as a team to keep product supplies on hand.

The duties of the ICM are intense. This person is responsible for keeping an adequate supply of all products used, dispensed, and sold; organizing inventory items for easy location; identifying when products should be reordered; keeping accurate inventory records; ordering, receiving, and inspecting shipments; and maintaining price and price updates for all items. The ICM also is responsible for rotating stock, keeping expired items off the shelves, learning about new products, and keeping the practice owner apprised of the specials that suppliers may offer. This responsibility must be acted upon every day. The veterinary technician who accepts the role of ICM must be able to perform clinical and nursing skills and keep an eye on inventory levels.

Technician's Notes

The objectives of an inventory control system are twofold:

1. To make certain that items are on hand when needed
2. To be able to purchase needed items while staying within a budgeted amount

Proactive Inventory Control System

For an inventory control system to be workable, it must be easy to use and have a turnover rate of at least four turns per year. It is the inventory control manager's job to make sure that all supplies are on hand when needed. Expenses can be reduced when inventory amounts are ordered properly.

Proper handling of Drug Enforcement Administration (DEA) substances is an important concern.

Technician's Notes

Controlled substances (e.g., Sleepaway, diazepam) must be kept in a locked cabinet that has been bolted to the floor, and all amounts used must be correctly recorded in the controlled substance log.

DEA forms (Figure 19-3) must be filled out properly by including the correct spelling of the substance to be ordered, documenting the exact amount and milligrams, and obtaining the signature of the veterinarian. No liquid paper may be used on these forms, and no strikeouts are allowed. In addition, these forms must be filled out with an ink pen or a typewriter.

Each **invoice** (Figure 19-4) that arrives at the veterinary hospital should be checked to verify amounts ordered and prices the practice is charged. A packing slip (Figure 19-5), an invoice, and a statement (Figure 19-6) are three different forms. Mistakes can be made on these forms unintentionally by the product vendor, but it may fall to the ICM to audit these mistakes and notify the vendor so the account can be adjusted to receive proper credit.

Back-ordered items can present problems. Back-ordered items are those items not on hand at the vendor for any number of reasons. Sometimes, the product may be on back order for manufacturing reasons; another reason may be that the manufacturer is redesigning the product's label. Buyouts of large pharmaceutical corporations also can cause product to be on back order until all minor details are worked out concerning the merger.

Identification of expired items may be one of the most frustrating experiences an ICM may face.

Technician's Notes

Most products have an expiration date on the label, and these must be checked frequently so they can be removed from the pharmacy when they are out of date.

Veterinary practice management systems software can be an invaluable aid in tracking expired items. When products are received, the *earliest* expiration date should be the one that is recorded in the computer system. Therefore, at the beginning of each month, the computer will reflect those products that expire first, and the ICM can print a list of the old drugs and quickly remove them from the pharmacy. As soon as the old products have been removed from the pharmacy shelves, the next earliest expiration date is recorded in the computer. Some pharmaceutical companies have policies that entitle the practice to free replacement of expired items. However, other vendors do not concur with this arrangement; therefore, the ICM must be able to distinguish which expired product will produce a free product refund and which will not. Some pharmaceutical companies prefer to credit the facility's account instead of sending replacement merchandise; others offer no reimbursement whatsoever for expired items.

It is hoped that pilferage will not occur in the veterinary facility. However, an effective inventory control system will deter employees who may elect to steal because they know that inventory is counted on a regular basis. Likewise, merchandise displayed (e.g., leashes, collars, shampoo, grooming brushes) in the reception area of a veterinary facility can be enticing to some clients who may decide to "pick up" an item instead of paying for it. This is another reason why proper inventory control plays an important role.

Keeping Accurate Records

An orderly way of keeping track of data regarding inventory should be employed. Most veterinary facilities in this age of computer technology use software designed especially for the veterinary business. Remember, when dealing with computers, the old adage—"garbage in, garbage out" ("GIGO")—can detract from the quality of information that a computer contains.

See Reverse of PURCHASER'S Copy for Instructions		No order form may be issued for Schedules I and II substances unless a completed application form has been received. (21 CFR 1305.04)			OMB APPROVAL No. 1117-0010	
TO: (Name of Supplier)				STREET ADDRESS		
CITY and STATE				TO BE FILLED IN BY SUPPLIER		
				SUPPLIER'S DEA REGISTRATION No.		
TO BE FILLED IN BY PURCHASER						
LINE No.	No. of Packages	Size of Package	Name of Item	National Drug Code	Packages Shipped	Date Shipped
1						
2						
3						
4						
5						
6						
7						
8						
9						
10						
NO. OF LINES COMPLETED		SIGNATURE OF PURCHASER OR HIS ATTORNEY OR AGENT				
Date issued	DEA Registration No.	Name and Address of Registrant				
Schedules 2, 2N, 3, 3N, 4, 5						
Registered as a PRACTITIONER	No. of this Order Form					
DEA Form 1 (Jan. 1981) —222		U.S. OFFICIAL ORDER FORMS - SCHEDULES I & II				
		DRUG ENFORCEMENT ADMINISTRATION				
		SUPPLIER'S COPY 1				

FIGURE 19-3

An example of a U.S. Drug Enforcement Agency (DEA) form.

Hidden page

The Pharmaceutical Warehouse

PACKING LIST

Ship To:

All Pets Veterinary Hospital
1785 Lawrenceville Road
Lawrenceville, Georgia 37965

Bill To:

All Pets Veterinary Hospital
1785 Lawrenceville Road
Lawrenceville, Georgia 37965

Customer Account Number	Ship To
198531	Lawrenceville, Georgia

Item Code	Unit/Size	Description/ Strength	Quantity Ordered	Quantity Shipped	Item Status	Unit Price	Extension	Box No.	REM
15637	18/box	Vetrap	3	3	Sent	\$54.95	\$164.85	1	
15937	9/pack	Gauze bandage rolls	5	5	Sent	\$25.65	\$128.25	1	
13465	Each	Roll Cotton	12	12	Sent	\$ 3.50	\$ 42.00	1	

FIGURE 19-5

A sample packing slip. (Some vendors do not record prices on their packing slips.)



Inventory Records

Many types of inventory records may be used in a veterinary facility. At least some of the following should be used, although some practices may elect to use them all.

A reorder log, sometimes called a “want book” (Figure 19-7), is an effective way to track products to be ordered. Each member of the veterinary staff can use this log to record items that should be ordered.

Technician's Notes

All veterinary personnel should know the importance of maintaining inventory and should make every effort to record in the reorder log any product that has been depleted.

In a busy practice, this habit is of utmost importance because once supplies have been exhausted, obtaining interim product from the neighboring veterinary facility becomes an “emergency.” Afterward, the amounts borrowed must be replaced or paid for.

Technician's Notes

The reorder point is the level reached that necessitates a product reorder.

It is the responsibility of the ICM to set the reorder point. If orders are placed each week, then a minimum of a 3-week supply should be kept in stock. Larger veterinary hospitals, emergency clinics, and colleges of veterinary medicine may require that inventory be ordered via a purchase order. A

Hidden page

Hidden page

An inventory master list provides endless quantities of information. Each veterinary practice should strive to keep a current list of all products in stock. An inventory master list provides information such as name of the product, item number code, usage, order status, and price. Some veterinary management software includes information regarding the seasonal use of products. One category in which this may be important is the area of flea and tick products. Today's computer software designed for veterinary business has the ability to reflect the months during which the greatest amount of product was sold. For instance, it may be that flea and tick shampoo is purchased more frequently during the months of March through September as compared with other times of the year. By using this information, the ICM can better predict how much merchandise should be ordered. The master list also reflects trade names, generic names, unit size, strength, name of the product's manufacturer, phone numbers, addresses, practice account numbers, order information, unit price, and a formula for calculating markup. (Some of these items are optional.)

Technician's Notes

Markup is the amount of money (usually a percentage) over cost that an item is sold for.

There is a difference between cost and retail value. Cost is what the practice pays for an item. *Total cost* is the amount the item costs plus tax. The retail price is the amount the practice charges a client for an item. Retail price usually includes a profit margin (i.e., markup). Each practice has a way of figuring markup, and the percentages used may vary. A common way to figure total cost is to multiply the product's cost by the appropriate tax. When the total cost of an item is obtained and is multiplied by two, a 100% markup (i.e., retail price) is the result. This is illustrated below.

Equation to Figure Total Cost:

$$\text{Cost} + \text{Tax} = \text{Total cost}$$

Example:

$$\begin{aligned} \text{Amoxicillin (100 mg, 100-count bottle) cost} &= \$26.75 \\ \text{Tax (@ 10\%)} &= .100 \\ \$26.75 \times .100 &= \$2.675 \\ \$26.75 + \$2.675 &= \$29.425 \end{aligned}$$

To Find Retail Price @ 100% Markup:

$$\begin{aligned} \text{Total cost of the item} \times 2 &= \text{Retail Price @ 100\%} \\ &\text{markup} \\ \$29.43 \times 2 &= \$58.86 \end{aligned}$$

$$\begin{aligned} \text{Then: } \$58.86 \text{ divided by 100 tablets in the bottle} &= \\ &= .5886 \text{ or } \$0.59 \text{ each} \end{aligned}$$

So, each tablet can be retailed for \$0.59 (or \$0.60 to make accounting easier).

Reorder Quantity

When the reorder quantity is determined, a good idea is to set the amount equal to a 1-month supply. By ordering a 1-month supply of product, the ICM will not have to micromanage inventory. The reorder quantity can be posted on the computer's master inventory list.

Rabies Vaccine

Records regarding rabies vaccine are very important. Each rabies certificate reflects the vaccine's expiration date and serial number (Figure 19-8). Therefore, the ICM must ensure that the certificates reflect those numbers by checking that the serial number and expiration date are posted correctly in the computer. This is not optional; it must be done.



Organizing Inventory

Pharmacy and ICM Office

Technician's Notes

A room in the veterinary facility that is set up to serve as the pharmacy office and the ICM office provides a place to organize catalogs, journals, magazines, and sales lists.

Date of rabies vaccination	29 APR 03
Next rabies vaccination on	29 APR 04
Certificate number	N/A
Previous rabies vaccination	N/A
Best Veterinary Hospital	
Taylor Lane, DVM	
621 Banner Street	
Camden, Arkansas 71701	
501-836-8390	
Owner's name	Best Veterinary Client
Owner's address	1313 Schnauzer Lane Camden, Arkansas 71701
County of owner's residence	Ouachita

This is to certify...

That I have vaccinated against rabies the animal described below:

Patient Information & Signalment	
Patient's name	Tangent
Species	Canine
Breed	Mix
Gender	Male/Neutered
Color and markings	Brindle/White on chest
Tag number	N/A
Weight	101.4 lbs.
Age	2 years

Signed: _____
Taylor Lane, DVM

Vaccinations administered:

Vaccines administered

RV/DA2PP/CV/*Bordetella*

Rabies Vaccine Information	
Manufactured by	Pfizer Animal Health
Serial number	A232705A
Lot expiration date	26 AUG 03
Administration of vaccine	SC on right side

FIGURE 19-8

A sample rabies certificate.

Other items, such as DEA order records, Occupational Safety and Health Administration (OSHA) manuals, material safety data sheets (MSDSs), and suppliers' catalogs, also can be stored in the pharmacy office.

Organizing Inventory in the Veterinary Hospital

The ideal situation for organizing inventory in the veterinary hospital is to establish a centrally located pharmacy area. In this manner, all pharmaceuticals can be counted easily.

Technician's Notes

Inventory within the pharmacy area can be arranged in a variety of ways. The most common ways to arrange products are alphabetically, by therapeutic use, or by classification of the drug.

An easy way to organize inventory is to print the master inventory list and then stock products on the shelf in the same way that they are listed on the master list. In this way, when it is time to perform inventory, products are arranged on the pharmacy shelves in the same order they appear on the master inventory list—thereby enabling inventory to be carried out in a timely fashion.

Staff Memos

Technician's Notes

The ICM should designate a bulletin board for memos to the veterinary staff.

Memos attached to a bulletin board can alert all hospital staff of company buyouts, discontinued items, and back-ordered items. Use of a bulletin board provides the ICM with freedom from frustrating interruptions by office staff concerning inventory questions. Additionally, this bulletin board is a good location for the reorder log (i.e., "want book").

Special Conditions

Some special conditions must be recognized when one is arranging inventory. Products that require refrigeration have only a limited amount of

storage space in the refrigerator. Care should be taken to avoid ordering too large a quantity of these items because the available amount of refrigeration may not be able to contain the order amount. DEA substances should be kept in a locked cabinet that has been bolted to the floor. The space within the cabinet should be considered before increased amounts of merchandise are ordered.



Physical Inventory

Monthly Inventory versus Rotating Inventory

Deciding when and how often to perform this necessary function is the question. One effective method is to perform a rotating inventory. A rotating inventory necessitates the division of like products into categories. These categories are given a number of one through four. For example, each category designated as one is counted during the month of January. Each category designated as two is counted during the month of February; three is counted in March, and four in April. During the month of May, the inventory begins again, starting with those categories designated with number one. Thus, each category is counted three times a year (Figure 19-9). Although this may not be acceptable to all veterinary practice owners, it certainly can be an efficient way to perform a physical inventory. Many times, only one person is responsible for inventory control within the veterinary facility, and counting every item stocked in a practice may take a single person 1 to 2 days to complete. If inventory is done on a monthly basis (i.e., all items counted each month), the ICM cannot perform other nursing or technical skills on the day inventory is taken. When a rotating method is used, a smaller amount of inventory is counted each month, thus enabling the ICM to have time available to perform other job duties.

Technician's Notes

Nothing is as effective as performing a physical inventory.

Hidden page

Some practice owners may require a monthly inventory count. However, performing inventory on a rotational 3- to 4-month cycle makes the ICM's job easier. A veterinary technician may perform many functions in a veterinary practice; use of a rotating inventory ensures an accurate count and good use of the veterinary technician's nursing skills.



Purchasing Information

In a busy veterinary facility, an ideal situation is to deal with as few suppliers as possible. The ICM will constantly be involved in an appointment with sales representatives if various vendors are used. Dealing with as few suppliers as possible releases the ICM to perform regular nursing and technical duties required by the facility. If sales reps are asked to make an appointment, the ICM will know when to expect a visit and can better prepare the normal work schedule around this visit. The ICM should ensure that sales representatives are aware of lunch breaks and quitting time; otherwise, they may just "pop in" to make a sale without considering the ICM's schedule.

In dealing with pharmaceutical and supplier sales representatives, it is advantageous to be aware of several things. (Knowledge of the following information will make the ICM more effective in the responsibility of inventory maintenance.) Quantity and assortment discounts are ways that pharmaceutical companies can offer increased quantities of goods. Usually, the company will offer a discount for buying larger amounts, but several conditions must be considered by the ICM. First, how fast can amounts of the product sold in the practice be increased? Remember, time is money, and product left sitting in the pharmacy for extended periods will end up costing the practice money, even though the merchandise may have been bought at a discounted rate. Also, where will the overstock be stored? Does the practice have sufficient room to store increased quantities of product? Sometimes, quantity discounts are not what they appear to be.

Delayed billing is another feature that some pharmaceutical and supplier companies may offer.

When discounts for quantity buying are offered to the veterinary practice, the statement often will reflect a delayed billing option (i.e., the statement does not have to be paid within the usual 30-day span). Instead, the option of paying within a 60- to 90-day period will extend the discount. Usually, no interest is charged the buyer, and the practice owner may be able to purchase increased amounts of stock at a reduced rate without the trial of coming up with funds to pay for it all within a 30-day limit. Consideration must still be given to whether or not there is sufficient room for storage of overstock and how soon the product can be sold.

When an order is placed, many companies waive the shipping fee if the veterinary practice orders a minimum amount of product. For example, if the minimum order amount is \$250 per order, the ICM can save the practice shipping fees by ordering the minimum amount. Keep in mind that a shipping fee of \$10 when multiplied over 10 orders adds up to \$100. Shipping costs multiplied by 12 months could be used to buy other products instead of being spent on shipping fees.

Some pharmaceutical and supplier companies offer discounts for early payment. Veterinary practices can save money by paying the **statement** early. This too is a way to save the practice money. On the flip side, penalties may be imposed for statements paid after the 30-day time limit. The amount paid in penalties can also buy product instead of being spent on late fees. Every practice should endeavor to pay within 30 days.

The ICM should be familiar with each vendor's return policy. Items that are expired may have to be returned, along with any item that is not selling well. Some vendors will allow product to be returned and will credit the practice's account accordingly. Items that have expired may be picked up by a sales representative and replaced. It should be noted that expired controlled substances cannot be picked up by the sales representative for return to the pharmaceutical company.

Incoming Freight

The inventory control manager must be alert to possible damage incurred to freight during shipping.

Technician's Notes

At the time freight is being unloaded at the veterinary facility, the ICM should visually check for damage by noting any boxes that are not intact. Wetness to the cardboard container may indicate breakage of the contents, and boxes should be counted and the number compared with the number of containers listed on the **packing slip**.

As soon as freight arrives, it should be opened and any damage should be noted. Evidence of damage should be reported to the vendor as soon as possible so that credit can be received and/or damaged items replaced. Some companies have a 24-hour reporting period (i.e., all damaged items must be reported within 24 hours of arrival time). Damaged goods should be returned to the vendor from which they were ordered, in the original shipping carton with the damaged goods inside. In this way, the vendor can assess the damage and correctly apply credit to the veterinary facility's account.

FOB Rules and Shipment Contracts

A vendor delivers freight to the purchaser. The veterinary facility may make an order with a telephone representative, send or fax a purchase order, or make an order with the sales representative during his or her appointment at the veterinary facility. A shipment contract is one in which the seller turns the goods over to a carrier for delivery to the buyer. The seller has no responsibility for seeing that the goods reach their destination. In a shipment contract, both title and risk of loss pass to the buyer when the goods are given to the carrier. Shipment contracts are often designated by the term *FOB Place of Shipment* (such as FOB Camden, Arkansas). When goods are sent **FOB** (free on board) followed by place of shipment, they will be delivered free to the place of shipment. The buyer must pay all shipping charges from there to the place of destination. The terms indicate that title to the goods and risk of loss pass at the point of origin. Delivery to the carrier by the seller and acceptance by the carrier complete the transfer of both title and risk of loss. Therefore, the buyer accepts full responsibility during the transit of goods (Brown and Sukys, 2006).

A vendor uses a form of transportation to send required items to the veterinary hospital (e.g., UPS [United Parcel Service], Averitt Express, Federal Express, U.S. Postal Service). Once the vendor releases freight to the carrier, the freight becomes subject to two FOB rules: FOB destination and FOB shipping point.

Technician's Notes

Vendors place different terms of delivery on freight that is leaving a pharmaceutical facility. Basically, FOB rules state which business (vendor or buyer) has the title to freight and who will be responsible in cases of loss of freight when the vendor uses outside transportation companies to deliver goods. **FOB destination** means that the title of ownership (freight) is being passed from the vendor to the purchaser, and said freight becomes the property of the purchaser when the shipment is delivered to the veterinary hospital. **FOB shipping point** means that the title of ownership (freight) passes from the vendor to the purchaser when the vendor places the goods in possession of a carrier. FOB shipping point requires the purchaser to determine what responsibility the carrier will take if damage or loss occurs to freight. The ICM should realize that shipments can be refused (not signed for) upon delivery. In such cases, if the ICM deems that damage has or may have occurred because of the condition of the shipping container, the shipment may be refused, in which case the carrier will send the goods back to the vendor.

Receiving Freight

Technician's Notes

It is best to allow the person who placed the order to unpack the freight once the order has been received.

If the order is incorrect, the person who placed the order will know it immediately, whereas a person unpacking freight who did not place the order will not know what is correct. Several important

questions should be asked when one is unpacking an order, such as "Did I get exactly what I ordered?"; "Did I get the right drug form (i.e., capsules, tablets, or powder)?"; "Did I receive the correct size and/or strength?"; "Is the product's expiration date a long way into the future?"; "Does the invoice list the price I was quoted by the phone rep, or sales rep?"; "Does this order cost more than the last order of the same items?"; "Is anything back-ordered, and if so, when will that item be shipped?"; "Is any freight damaged or missing?"; and "Is the order correct, and if so, can the bill be paid?" (Lukens and Landon, 1993). By asking all these questions, the ICM is assured that the veterinary facility will be treated fairly by the vendor.

Stocking Shelves

Technician's Notes

It should be remembered when shelves are stocked that newly received items should be placed behind older items, so that the old is used and/or sold first.

When stock is rotated in this manner, the facility is assured that the product is sold or used by the hospital before the expiration date. When stocking shelves, it is good to record expiration dates. The earliest date should be the one recorded in the computer so the software will present an accurate list of expired items when the command is given to print an expired items list. Stocking shelves also presents a convenient time to dust and wipe off labels and lids on products that have been sitting on the shelf for extended periods. It should be noted that after cleaning, products should be replaced in specific locations to facilitate accurate inventory.

Vendors

Several different types of vendors may be used. The ICM must have adequate knowledge of these types to correctly place an order. Some vendors allow ordering by phone; others require that the order be given to a sales rep. Still others require a faxed order or an order sent through the mail.

Full-service companies are those that send a sales rep to visit the veterinary facility and offer full

service. A technical staff, usually made up of veterinarians, is employed. Full-service companies usually carry a limited product line. Some products may be newly developed products that still retain a patent with the federal government and cannot be ordered through a distributorship. A full-service company has sales reps who call on the veterinary hospital and take orders. Most full-service companies will replace outdated product with new or will credit the hospital's account accordingly.

Technician's Notes

The sales rep may not pick up expired controlled substances; these must be mailed back to the company.

A full-service company may have several "deals" that the ICM must decide to accept or decline. Examples of full-service companies include Pfizer Animal Health, Pharmacia-Upjohn, Schering Animal Health, and Fort Dodge Animal Health. These companies employ veterinarians as technical support staff, and their product lines are often limited as compared with distributorships. However, full-service companies are forerunners in the development of new drugs protected under U.S. patent laws, in which case they may not be sold under a generic name until the patent expires.

Mail order discount houses provide a good source for ordering items such as gauze, syringes, needles, paper towels, paper drapes, and even isopropyl alcohol. Ordering from this type of vendor occurs over the telephone because most do not employ sales reps to visit the hospital, although catalogs may be supplied and mailed to the buyer.

Veterinary supply distributors provide the most common way of acquiring supplies for the veterinary facility. A distributor is an intermediate between a full-service company and the mail order discount house. If a full-service company gives its approval and a contract is signed between two companies, some products normally sold only through a full-service company may be obtained from a distributor. Many times, products sold by the full-service company to the distributor are those with a patent about to expire

Hidden page

added to amounts already posted in the computer. Bar coding is available on most pharmaceutical products. Using a device capable of reading bar codes greatly enhances the counting and maintaining of inventory.

Additionally, most software can be used to produce automatic expiration lists from computer files each month. The total amount of money spent on inventory in a day, week, month, or year can be obtained when computer software systems are used.



The Job of ICM

It cannot be overemphasized how important inventory control is to the veterinary facility. The veterinary technician who is willing to take on this added responsibility will find himself or herself an invaluable member of the staff. Keeping in mind that inventory is the second-highest expense for the veterinary hospital will enable the ICM to use care when considering sales offers. Understanding the practice's mission is crucial in inventory control. Remember, time is money, and product left sitting on the shelf for extended periods does not benefit the facility. Keeping a turnover of at least four turns per year is a minimum goal. Training a backup person to monitor inventory during times of vacation or sickness experienced by the ICM is crucial. Reminding employees during staff meetings of the importance of "GIGO" and documenting outages on the reorder log will enable the facility to never run out of needed product. DEA products must be controlled by effective documentation of their use in a

log book kept solely for this purpose (e.g., controlled substance log book).

Establishing a formula for markup is critical. The way inventory is arranged within the pharmacy has a great deal to do with the ease of counting it. No better method of counting inventory can replace doing a physical inventory. Keep sales reps abreast of lunch breaks and leaving times. Carefully observe all freight for damage, and report claims as soon as possible after receiving the product. Always rotate product on shelves so that the oldest product is sold first. Be knowledgeable about the different types of vendors. Decide which method of inventory counting is most advantageous to your particular situation by deciding whether to count all inventory monthly or on a rotating basis. Keep a good relationship with a local pharmacy because these businesses serve as a good source of knowledge and enable the veterinarian to order human products not normally sold through veterinary vendors. Decide whether a manual or a computerized system is best for your facility. In this age of technology, it is best to use a computer system to facilitate efficient work flow.

REFERENCES

- Brown GW, Sukys PA: Business law with UCC applications, ed 11, New York, NY, 2006, McGraw-Hill Irwin.
- Libby R, Libby P, Short DG: Financial accounting, ed 4, New York, NY, 2004, McGraw-Hill Irwin.
- Lukens RL, Landon RM: A guide to inventory management for veterinary practices: effective inventory control, Westchester, Pa, 1993, SmithKline Beecham Animal Health.
- McAllister Software Systems: AVI-Mark Veterinary Software System, Piedmont, Mo: avimark@semo.net



REVIEW QUESTIONS

- What is inventory? _____
- Name the five principles used to control expenses:
 - _____
 - _____
 - _____
 - _____
 - _____
- When dealing with inventory, it is crucial to remember that time is _____.
- What is turnover? _____
- Calculate the turnover rate by using the following information: Yearly inventory expense = \$125,000; average cost of inventory on hand = \$31,250.

- Calculate the average cost of inventory on hand by using the following information: Year's beginning inventory = \$75,000; year's ending inventory = \$130,000.

- Name two objectives of an inventory control system.
 - _____
 - _____
- What is a packing slip?

- What is an invoice?

- What is a statement?

- What is the reorder point?

- Why is recording the expiration date and serial number for rabies vaccine so important?

- Once the reorder point is reached, a basic rule of thumb is to order a _____-month supply.
- Name some materials that may be kept in the pharmacy library. _____
- List some rules for filling out a DEA form.
 - _____
 - _____
 - _____
 - _____
 - _____
 - _____
- Time = Money.
 - True
 - False
- A mean turnover rate of _____ is acceptable for most veterinary practices.
 - 12
 - 4
 - 2
 - 8
- Inventory should be placed on pharmacy shelves in such a way so as to ensure _____.
 - LIFO
 - FIFO
 - FOB
 - ICM
- DEA forms are issued by _____.
 - state governments
 - county governments
 - city governments
 - the federal government
- An item may be placed on back order just because the pharmaceutical company is changing the color of the drug's label.
 - True
 - False
- The price a veterinary hospital pays for an item is known as _____, and the amount the hospital sells the item to a client for is known as _____ price.
 - retail; cost
 - cost; retail

22. The expiration date and the serial number of rabies vaccine administered must be recorded on each pet's rabies certificate.
 - a. True
 - b. False
23. Delayed billing has no perks for a veterinary practice owner.
 - a. True
 - b. False
24. When a shipment arrives at a veterinary hospital, if the delivery carton appears to be damaged, the ICM does not have to accept the shipment from the carrier.
 - a. True
 - b. False
25. When a DEA form is used to order a controlled substance, it is acceptable to draw a line through a misspelled word and then write it correctly beside the mistake.
 - a. True
 - b. False

Hidden page

Hidden page

Hidden page

APPENDIX **B**

Weights and Measures

Hidden page

Copyrighted image

APPENDIX **C**

Resource Information

Drug Information Resources

Subject	Phone Number	Website
Adverse drug reactions	888-FDA-VETS	www.fda.gov/cvm
Associations		
American Academy of Veterinary Consultants		tpvec.unl.edu/public/avc.avc.htm
American Academy of Veterinary Pharmacology and Therapeutics		www.aavpt.org
American Animal Hospital Association		www.aahanet.org
American College of Veterinary Clinical Pharmacology		www.acvcp.org/
American Veterinary Medical Association	800-248-2862	www.avma.org
Governmental agencies		
Drug Enforcement Agency Office of Diversion Control, Registration Section	800-238-7332	www.usdoj.gov/dea
Food and Drug Administration		www.fda.cvm
Center for Veterinary Medicine	301-594-1755	www.fda.gov/cvm
Office of Management and Communications	301-594-1752	
Office of New Animal Drug Evaluation	301-594-1620	
Office of Surveillance and Compliance	301-827-6644	
Office of Research	301-827-8010	
Communications Staff	301-827-6514	
United States Department of Agriculture		
Animal and Plant Health Inspection Service		www.aphis.usda.gov
Centers for Disease Control and Prevention		www.cdc.gov
Center for Epidemiology and Animal Health	800-545-8732 (voice response only)	www.aphis.usda.gov/vs/ceah
Center for Health Monitoring		www.cdc.gov/cdc.htm
Interstate Shipping		www.aphis.usda.gov/vs/sregs
Center for Animal Health Monitoring		www.aphis.usda.gov/vs/ceah/cahm
Occupational Safety and Health Administration		www.osha.gov
Veterinary Information Network (subscriptions)	800-700-4636	www.vin.com
Compounding and compounding pharmacies		
Professional Compounding Centers of America	800-331-2498	www.pccarx.com/
Formularies and drug databases		
Antibiotics: Medical College of Wisconsin Antibiotic Guide		www.intmed.mcw.edu/AntibioticGuide.html
Internet Drug Index RxList		www.rxlist.com/
Formulary Medical College of Wisconsin		
Physicians GenRx (by subscription only)		www.mosby.com/Mosby/phyGenRx/
DoseCalcu Online (dose calculations)		www.meds.com/Dchome.html
Health sciences of information gateway sites		
Animal Health Institute		www.ahi.org
WWW Virtual Library: Pharmacy		www.pharmacy.org/
National Library of Medicine		www.nlm.nih.gov
Poisoning antidotes (\$50 consultation fee)	888-426-4435	www.aspca.org/apcc
Research information		
Morris Animal Foundation		www.MorrisAnimalFoundation.org

From Booth DM: Small animal clinical pharmacology and therapeutics, Philadelphia, 2001, WB Saunders.

Veterinary Pharmaceutic Companies, Distributors, and Other Important Numbers

Company Name	Telephone	Website
Abbott Laboratories	888-299-7416	www.abbott.com
AgriPharm/Dealer Distribution of America	901-366-4442	
Alpharma, Inc. Animal Health Division	201-228-5074	www.alpharma.com
Animal Blood Bank	800-243-5759	
Aspen Veterinary Resources, Ltd.	816-413-1444	
Bayer Corp. Agriculture Division, Animal Health	800-633-3796	www.bayerus.com/ah
Biopure Corp.	617-234-6500	www.biopure.com
Boehringer Ingelheim Vetmedica, Inc.	800-821-7467	www.bi-vetmedica.com
Bowie Cattle City Calf Jack	800-831-0960	
The Butler Co.	614-761-9095	www.wabutler.com
C.E. Kord Animal Disease Laboratory Nashville, Tenn.	615-360-0125	
Columbus Serum Co.	800-848-1090	
Durvet, Inc.	816-229-9101	www.durvet.com
DVM Pharmaceuticals, Inc.	800-367-4902	www.DVMPharmaceuticals.com
Elanco Animal Health	800-428-4441	www.elanco.com
EVSCO Pharmaceuticals	856-691-2411	www.evscopharm.com
Fort Dodge Animal Health	800-533-8536	www.ahp.com/fortdodge.htm
G.C. Hanford Manufacturing Co.	800-234-4263	www.hanford.com
Halocarbon Laboratories	800-338-5803	www.halocarbon.com
Heska Corp.	800-GO-HESKA	www.heska.com
Hills Pet Nutrition, Inc.	800-354-4557	
IDEXX Laboratories, Inc.	800-248-2483	
Intervet Inc.	800-247-4838	
Lloyd Laboratories, Inc.	800-831-0004	www.lloydinc.com
Luitpold Pharmaceuticals, Inc.	800-458-0163	www.luitpold.com
Meril, Ltd.	888-637-4251	www.merial.com
Merritt Veterinary Supplies, Inc.	800-972-4744	
Nasco West	800-558-9595	
Neogen Corp.	800-525-2022	www.neogen.com
Novartis Animal Health US, Inc.	800-332-2761	www.ah.novartis.com
Orthopedic Foundation for Animals (OFA)	573-442-0418	www.offa.org
Pet-Ag, Inc.	800-323-6878	www.petag.com
Pfizer Inc., North American Region, Animal Health Group	800-733-5500	www.pfizer.com/ah
Pfizer Animal Health	800-793-0596	www.pfizer.com/ah/
Phoenix Pharmaceutical, Inc.	800-759-3644	www.phoenixpharmaceutical.com
Phoenix Scientific, Inc.	816-364-3777	
PRN Pharnacal	800-874-9764	
Schering-Plough Animal Health Corp.	800-648-2118	www.sp-animalhealth.com
Sunbelt Veterinary Supply	800-476-4343	
Vedco, Inc.	816-238-8840	www.vedco.com/dvmonly/
Vet-A-Mix, a division of Lloyd, Inc.	800-831-0004	www.lloydinc.com
Veterinary Products Laboratories	800-720-0032 ext. 2158, 2283, or 2284	www.vpl.com
Vetus Animal Health	800-92-BURNS	www.burnsvet.com
Vortech Pharmaceuticals, Ltd.	800-521-4686	
Webster Veterinary Supply	800-225-7911	
Wildlife Pharmaceuticals, Inc.	970-484-6267	www.wildpharm.com
Zinpro Corp.	800-445-6145	www.zinpro.com

Hidden page

APPENDIX **D**

**Controlled Substances
Information Summary**

Drugs that have been determined to have potential for abuse by people are classified as controlled substances. Controlled substances are regulated through the efforts of the U.S. Drug Enforcement Agency (DEA), which enforces the regulations of the Controlled Substances Act (CSA) and the DEA regulations of Title 21, Code of Federal Regulations (CFR), Parts 1300 to 1316. Much valuable information related to the CSA and the CFR is available online at www.dea diversion.usdoj.gov.

Information that may be found at the DEA Diversion website includes but is not limited to the following:

- Applications and online forms, including Form 106, Report of Theft and Loss of Controlled Substances
- A complete list of controlled substances and the schedule of each
- A list of Drugs and Chemicals of Concern that includes both controlled and noncontrolled drugs (e.g., Tramadol) whose abuse potential concerns the DEA
- Information about proposed or new regulations under the CFR
- Offices and Directories, including a list of DEA offices and officials throughout the United States
- A *Practitioner's Manual* that summarizes much of the CSA and CFR

SCHEDULES OF CONTROLLED SUBSTANCES

Drugs that are under the control of the Controlled Substances Act are placed into five schedules, or classes, according to their potential for abuse. This schedule is designated by a "C" with a Roman numeral (I, II, III, IV, or V) inside the C.

Schedule I substances have no (or controversial) accepted medical use and a high potential for abuse. LSD (lysergic acid diethylamide), heroin, crack cocaine, marijuana, and peyote are substances in this class. The use of medicinal marijuana in human medicine is controversial but may be permitted in some states.

Schedule II drugs have accepted medical uses but have a high potential for abuse. A partial list of schedule II drugs includes morphine, meperidine, codeine, cocaine, oxycodone, amphetamines, and pentobarbital. Orders for schedule II drugs must be made on DEA Form 222 (see Figure 19-3).

Schedule III substances have less potential for abuse than those in schedule II and include Hydoran, paregoric, barbiturates such as thiamylal or thiopental, and anabolic steroids.

Schedule IV drugs have lower abuse potential than those in schedule III. Included in this class are phenobarbital, diazepam, and pentazocine.

Schedule V drugs are the lowest on the scale of abuse potential and include mostly antidiarrheal and anticough medications. Lomotil and Robitussin with codeine are in this schedule.

REGISTRATION REQUIREMENTS

Every person or entity that handles controlled substances must be registered with the DEA or be exempt under the regulations. DEA registration gives practitioners the authority to handle controlled substances. The DEA-registered practitioner may engage only in those activities that are allowed under state law in the state in which the practice is located. In some cases, state law is more stringent than federal law. In all cases, the most stringent regulation takes precedence. To obtain DEA registration, a practitioner must apply using DEA Form 224, which can be submitted as hard copy or online.

A practitioner must be registered with the DEA in each state where controlled substances are prescribed, administered, or dispensed. Also, a separate registration is required for each place of business or practice where controlled substances are stored or dispensed. An exemption is made that allows affiliated (employee) veterinarians to act on behalf of registered veterinarians to administer or dispense controlled substances. The affiliated practitioner cannot write prescriptions under this exemption and may need state registration.

The person who holds the registration must keep the information on the registration certificate current. A letter of request must be made to alter the

name or address, or to approve a change in schedule on the certificate. A DEA modification must be issued before applications related to the request may be carried out by the registrant. Registrations must be renewed every 3 years.

SECURITY REQUIREMENTS

CFR regulations require that all registrants provide effective measures and procedures to guard against theft or diversion of controlled substances. The *DEA Practitioner's Manual* lists several factors that may be used to determine the adequacy of security measures. Those factors include the following:

- Location of the premises
- Type of building and its construction
- Type and quantity of controlled substances kept on the premises
- Type of storage container
- Control of public access to the facility
- Adequacy of premise monitoring systems
- Availability of police protection

Regulations require that schedule II through V controlled substances be stored in a "securely locked, substantially constructed cabinet." If the registrant stores carfentanil, etorphine, and/or diprenorphine, a safe or steel cabinet equivalent to a U.S. Government Class V security container (General Services Administration specifications) must be used.

Regulations state that a registrant should limit access to controlled substances according to the following guidelines. Access should be denied to the following:

- Any person convicted of a felony related to a controlled substance
- Any person denied a DEA registration
- Any person who has had a DEA registration revoked
- Any person who has surrendered a DEA license for cause

Registrants must notify the DEA of any theft or "significant loss" of controlled substances using DEA Form 106 as soon as the theft or loss is discovered.

RECORD-KEEPING REQUIREMENTS

Registrants under the CSA must maintain specific records. The *Practitioner's Manual* states that records, inventories, and records of substances in schedules I and II must be maintained separately from all other records. It further states that records of substances in schedules III, IV, and V must be maintained separately or on a form that is readily retrievable from ordinary business records of the practitioner. So, the registrant must have two separate sets of records for controlled substances. The records for schedules III, IV, and V can be kept with records for noncontrolled substances if they can be easily retrieved. Schedule II records are usually kept in a controlled substances log, and schedule III, IV, and V drugs are kept in a controlled substances log and/or in a computer inventory system. The American Animal Hospital Association publishes a controlled substances log for purchase that may avoid pitfalls of hospital/clinic-constructed logs. Entries in the log should be made in ink with great care, and mistakes should be marked through, corrected, and initialed.

Each registrant must maintain a "complete and accurate record of the controlled substances on hand and date the inventory was conducted." This record must be in written, typewritten, or printed form and maintained at the registration location for 2 years. After the first inventory is taken, a new inventory must be carried out every 2 years. Regulations state that each inventory must contain the following information:

- Whether the inventory was taken at the beginning or the end of the business day
- Names of the controlled substances
- Each form of the controlled substances (e.g., 50-mg tablet)
- Number of dosage units in each container (e.g., 100-tablet bottles)
- Number of commercial containers of each form (e.g., two 100-tablet bottles)
- Disposition of the controlled substances
- Name, address, and DEA registration number of the registrant
- Signature of the person performing the inventory

Hidden page

Hidden page

Hidden page

- Kamerling SG: Pain recognition and relief, Proceedings of the Annual Meeting of the American Veterinary Medical Association, Boston, 2001.
- Kirk RW, editor: Current veterinary therapy VIII: small animal practice, Philadelphia, 1983, WB Saunders.
- Kirk RW, Bonagura JD, editors: Current veterinary therapy X: small animal practice, Philadelphia, 1989, WB Saunders.
- Kirk RW, Bonagura JD, editors: Current veterinary therapy XII: small animal practice, Philadelphia, 1995, WB Saunders.
- Lane DR, Cooper BC, editors: Veterinary nursing, ed 2, Oxford, England, 1999, Butterworth-Heinemann.
- Lane DR, Cooper VN, editors: Veterinary nursing, ed 3, Oxford, 2003, Butterworth-Heinemann.
- Langston VC, Mercer HD: Nonsteroidal antiinflammatory drugs, Proceedings of the 17th Seminar for Veterinary Technicians, The Western Veterinary Conference, Las Vegas, 1988.
- Lavoie JP: Inhalation therapy for equine heaves, *Comp Contin Educ Prac Vet* 23(5):475-477, 2001.
- Locklar CF Jr, Locklar MS: Personal interview, March 12, 2003.
- Lukens RL and Landon RM: A guide to inventory management for veterinary practices: effective inventory control, Westchester, Pa, 1993, SmithKline Beecham Animal Health.
- MacEwen EG, Rosenthal RC: Approach to treatment of cancer patients. In Ettinger SJ, editor: Textbook of veterinary internal medicine, ed 5, Philadelphia, 2000, WB Saunders.
- McAllister P: McAllister Software Systems: AVI-Mark Veterinary Software System, Piedmont, Mo, avimark@semo.net.
- McCurmin DM, Bassett JM, editors: Clinical textbook for veterinary technicians, ed 5, Philadelphia, 2002, WB Saunders.
- McKiernan B: Respiratory therapeutics, Proceedings of the 17th Seminar for Veterinary Technicians, The Western Veterinary Conference, Las Vegas, 1988.
- Mealey KL: Clinically significant drug interactions, *Compend Contin Educ Proc Pract Vet* 24(1):10-22, 2002.
- Muir WW, DiBartola SP: Fluid therapy. In Kirk RW, editor: Current veterinary therapy VIII: small animal practice, Philadelphia, 1983, WB Saunders.
- Muir WW, Hubbell JA: Handbook of veterinary anesthesia, ed 3, St. Louis, 2000, Mosby.
- Muller GH, Kirk RW, Scott DW: Small animal dermatology, ed 4, Philadelphia, 1989, WB Saunders.
- Norsworthy GD: Clinical aspects of feline blood transfusions, *Comp Contin Educ Prac Vet* 14:470, 1992.
- Paddleford RR: Manual of small animal anesthesia, Philadelphia, 1999, WB Saunders.
- Papich MG: Handbook of veterinary drugs, Philadelphia, 2002, WB Saunders.
- Parker AR: Domperidone, *Compend Contin Educ Prac Vet* 23(10):906-908, 2001.
- Pasquini C, Spurgeon T, Pasquini S, editors: Anatomy of domestic animals, ed 7, Pilot Point, Texas, 1995, Suds Publishing.
- Plumb DC: Veterinary drug handbook, ed 4, Ames, Iowa, 2002, Iowa State University Press.
- Quinn PJ, Donnelly ME, Carter BK, et al, editors: Microbial and parasitic diseases of the dog and cat, London, 1997, Saunders.
- Robertson SA: Systemic uptake of buprenorphine after buccal administration in cats, Proceedings of the Annual Meeting of the American College of Veterinary Anesthesiologists, New Orleans, 2001.
- Scott DW, Miller WH, Griffin CE: Dermatologic therapy. In Small animal dermatology, ed 5, Philadelphia, 1995, WB Saunders.
- Scott DW, Miller WT, Griffin CE: Small animal dermatology, ed 6, Philadelphia, 2001, WB Saunders.
- Shull EA: Psychopharmacology in veterinary behavioral medicine, Annual Conference for Veterinarians and Technicians, Knoxville, Tenn, 1998, UT-CVM.
- Simpson BS, Simpson DM: Behavioral pharmacotherapy: part I: antipsychotics and antidepressants, *Compend Contin Educ Prac Vet* 18(10):1067-1081, 1996.
- Simpson BS, Simpson DM: Behavioral pharmacotherapy: part II: anxiolytics and mood stabilizers, *Compend Contin Educ Proc Vet* 18(11):1203-1210, 1996.
- Smith P: New studies, products fuel heartworm debate, *Veterinary Product News* 11(4):34-36, 1999.
- Snyder S, editor: Drugs and the brain, New York, 1986, Scientific American Library.
- Spinelli JS, Encos LR, editors: Drugs in veterinary practice, St. Louis, 1978, Mosby.
- Swaim SE, Gillette RL: An update on wound medications and dressings, *Compend Contin Educ Prac Vet* 20(10):1133-1145, 1998.
- Tilley LP, Smith WK: The 5-minute veterinary consult canine and feline, ed 2, Baltimore, 2000, Lippincott Williams & Wilkins.
- Tizard I: Veterinary immunology: an introduction, ed 4, Philadelphia, 1992, WB Saunders.
- Tizard I: Veterinary immunology: an introduction, ed 6, Philadelphia, 2000, WB Saunders.
- Upson DW: Handbook of clinical veterinary pharmacology, ed 4, Manhattan, Kan, 1988, Dan Upson Enterprises.
- Ware WA: Problems in chronic heart failure management, Proceedings of the American Veterinary Medical Association Annual Conference, Nashville, Tenn, 2002.
- Webb AI, Aeschbacher G: Animal drug container labels: a guide to the reader, *JAVMA* 202:1591-1599, 1993.
- Williams BR, Baer C, editors: Essentials of clinical pharmacology in nursing, Springhouse, Pa, 1990, Springhouse Corp.

This page intentionally left blank

Hidden page

ANSWERS TO CHAPTER 1

1.
 - a. An agonist is a drug that has affinity for a receptor and stimulates the receptor to action.
 - b. A contraindication is a reason not to use a drug in a particular situation.
 - c. Efficacy is the degree to which a drug produces its desired effects in a patient.
 - d. An over-the-counter drug is one that may be purchased and used without a prescription from a veterinarian.
 - e. A prescription drug is one that must be used under the supervision of a veterinarian.
 - f. A receptor is a group of specialized molecules on or in a cell that bind with a drug to produce an effect.
 - g. The therapeutic index expresses the relationship between a drug's therapeutic and harmful effects.
 - h. The withdrawal time is the amount of time that must elapse between the end of drug therapy and the elimination of that drug from the patient's tissues or products.
 - i. The veterinarian-client-patient relationship is the relationship that must exist between the veterinarian, his or her patient, and the patient's owner before prescription drugs may be dispensed.
2. Four sources for veterinary drugs are animal products, plant materials, minerals, and synthetic products.
3. A drug regimen includes the dose, the route of administration, the frequency of administration, and the duration of administration.
4. For a valid veterinarian-client-patient relationship to exist, (1) the veterinarian must assume responsibility for making clinical judgments in relation to the health of the animal, (2) the veterinarian must have recently seen the animal and be acquainted with its care, and (3) the veterinarian must be available for follow-up care of the animal.
5. It is a technician's responsibility to carry out the veterinarian's orders correctly. The technician should read the drug label three times to ensure that the proper drug is being administered and should take care to administer the correct dose by the correct route. The technician should also be aware of the expected effects and the potential adverse side effects to be able to monitor the patient in a responsible way. In a large animal practice, the technician should be aware of withdrawal times and potential residue problems.
6. A drug is first absorbed (or directly placed) into the bloodstream. In the blood, the drug may bind with a plasma protein or may exist in the free state. The circulating blood distributes the drug to the capillary level, where the drug leaves the circulation and enters the interstitial fluid. The interstitial fluid bathes the cell and allows the drug to enter the cell or bind with surface receptors. The drug then exits the cell (or its surface), moves back into the interstitial fluid, reenters the circulation, and is transported to the liver for metabolism. After it is metabolized, the metabolite is transported to the kidneys for excretion.
7.
 - (1) The oral route provides a simple route of administration. Many factors may influence the rate of absorption, and the oral route may not be appropriate if the animal is vomiting.
 - (2) Subcutaneous administration of drugs is usually a simple procedure. Absorption from subcutaneous sites may be slow, and hypertonic solutions should not be given by this route.
 - (3) The intramuscular route produces faster absorption than the subcutaneous route, but care must be taken with many drugs not to inject them into blood vessels.
 - (4) The intravenous route allows immediate access to the bloodstream and the dilution of irritating drugs. A toxic or allergic reaction can be a side effect.
 - (5) The intraperitoneal route may be used to administer fluids and some other solutions when other routes are not available. Absorption from the peritoneal cavity is slow, however.
 - (6) The intraarterial route is a seldom used route that may produce seizures or death.

- (7) The intracardiac route is used primarily for administering emergency drugs or for euthanasia.
 - (8) The intramedullary route may be used to administer fluids or blood to small animals or those with damaged veins.
 - (9) The inhalation route is used to administer drugs to the respiratory system. Special equipment may be required.
 - (10) The topical route may be used to place drugs on skin or mucous membranes and may be facilitated by the use of carrier substances in some instances.
 - (11) The intradermal route is used primarily for allergy testing and for diagnosing tuberculosis.
8. The absorption of a drug may be influenced by (1) the method of absorption, (2) the pH of the drug and its ionization status, (3) the absorptive surface area, (4) the blood supply to the area, (5) the solubility of the drug, (6) the dosage form, (7) the status of the gastrointestinal tract, and (8) interactions with other drugs.
 9. b. Liver
 10. a. Kidneys
 11. Receptors
 12. Proprietary/trade
 13. The six items that must be on a drug label are the drug names (generic and trade), the drug concentration and quantity, the name and address of the manufacturer, the controlled substance status, the manufacturer's control or lot number, and the drug's expiration date.
 14. The government agencies that regulate the development, approval, and use of animal health products are the FDA, EPA, and USDA.
 15. Many veterinary clinics dispense rather than prescribe drugs because of the profit earned from selling the products.
 16. Veterinary pharmaceuticals may be purchased directly from the manufacturer, from distributors, or from generic mail order companies. In some instances, drugs may be sold under one label to graduate veterinarians and under another as an over-the-counter product.
 17. *The Green Book*
 18. FARAD provides resources concerning the avoidance of drug residues in animals.
 19. AMDUCA (Animal Medicinal Drug Use Clarification Act)
 20. *Compounding* refers to the diluting or combining of existing drugs.
 21. Drug residues in animal products may cause allergic reactions or neoplasia in people, and they may cause the development of antibiotic-resistant strains of bacteria.
 22. Pharmacodynamic, pharmacokinetic, and pharmaceutical
 23. Liver
 24. An "ethical" product is one sold only through veterinarians as a policy of the manufacturer rather than by FDA requirement.
 25. Metabolite
 26. b. indication
 27. a. practical experience
 28. b. using a drug in a way not specified by the label
 29. a. The veterinarian has seen and treated all the client's pets except a dog for which the owner would like to buy heartworm preventive.
 30. c. pharmacokinetics
 31. b. by injection
 32. b. metabolism (biotransformation)
 33. c. efficacy
 34. b. false
 35. c. AVMA

ANSWERS TO CHAPTER 2

1. Drugs for oral administration, drugs for parenteral administration, drugs for inhalation, drugs for topical administration
2. Large; balling gun
3. Injections, implants
4. Single-, multi-
5. Sharps container
6. Right patient, right drug, right dose, right route, right time and frequency
7. Vomiting
8. Rapid

9. 72
10. Large
11. Date, owner's name, patient's name, drug name, amount dispensed or administered, name(s) of personnel administering the drug to the patient
12. The plastic syringe may absorb the drug, which may cause it to be less effective.
13. Luer-lok, slip-tip, eccentric, catheter-tip
14. 1
15. Insulin syringe
16. d. counterirritant
17. c. suspension
18. d. Luer-lok tip
19. b. carotid artery
20. d. 72
21. c. 8; 12
22. b. ear
23. b 15; 30
24. d. 24; 48
25. d. both b and c

ANSWERS TO CHAPTER 3

Ratios

1. 1:4; 0.25
2. 75:100; $\frac{75}{100}$
3. 4:1000; $\frac{4}{1000}$
4. $\frac{1}{80}$; 0.0125
5. 9:1000; 0.009
6. $\frac{1}{32}$; 0.031

Proportions

1. 50
2. 8
3. 2.5
4. 5
5. 200 mg
6. 37.5 mg
7. 31.25 mg
8. 118.25 ml
9. 5 ml
10. 1.25 tablets

Problems Using the Metric System

1. 0.15 g
2. 2000 ml
3. 2.25 g
4. 5000 mg
5. 3 L
6. 2000 g
7. 500 g
8. 0.005 kg
9. 0.00125 g
10. 4 mg
11. 2.05 mg
12. 0.01 g
13. 500 ml
14. 0.75 L
15. 0.3 mg
16. 2500 μg

Problems Using the Apothecary and Household Systems

1. 3 pt
2. 1.5 gal
3. 1 Tbsp
4. 12 cups
5. 6 pints
6. 4 Tbsp
7. 128 oz
8. 16 oz
9. 3 qt

Problems Combining Both Systems

1. 480 ml
2. 30 ml
3. 15 cc
4. 16 oz
5. 0.013 pt
6. 25 tsp
7. 45 ml
8. 33 lb
9. 0.52 pt
10. 150 ml
11. 15.9 kg

Problems Measuring Oral Medications

1. 2 tablets
2. 1.5 tablets
3. 4 tablets

4. 7 tablets
5. 1.5 tablets; 7.5 tablets
6. 20 tablets
7. 200 mg; 100 mg; 50 mg/ml; 4 ml; 2 ml; 44 ml
8. 0.5 tablet each morning and afternoon
9. 60 tablets
10. 0.5 tablet; 4.5 tablets
11. 6.8 kg; 68 mg; 0.75 tablet; 31.5 tablets
12. 4 tubes
13. 100 oz or 3.125 qt (containing 3 oz powder per quart of water)
14. 0.5 tablet; 7 tablets
15. 1.0 ml

Problems Measuring Parenteral Medications

1. 0.4 ml
2. 0.80 ml
3. 17 ml
4. 1.5 ml
5. 2.1 ml
6. 1.95 ml
7. 15 mg
8. 0.74 m²; 0.37 mg; 0.37 ml
9. 2500 mg; 25 ml; 2.5 bottles
10. 54 mg; 0.54 ml
11. 3.5 ml
12. 0.1 ml
13. 47.5 mg; 1.9 ml
14. 30 ml
15. 1.5 ml
16. 0.18 ml
17. 0.36 ml
18. 1.5 ml
19. 0.35 ml
20. 1.2 ml

Injection Problems

1. 2 ml
2. 5 ml
3. 1.5 ml
4. 3.75 ml
5. 0.25 ml
6. 2 ml
7. 0.75 ml
8. 7.5 ml
9. 0.6 ml
10. 0.22 ml

Preparing Solutions

1. $V_1 \times C_1 = V_2 \times C_2$
 $V_1 \times 100 = 100 \times 10$
 $V_1 \times 100 = 1000$
 $V_1 = 10$
 10 ml 37% formaldehyde + 90 ml water
2. $V_1 \times C_1 = V_2 \times C_2$
 $V_1 \times 50 = 1000 \times 5$
 $V_1 \times 50 = 5000$
 $V_1 = 100$
 100 ml 50% dextrose + 900 ml 0.9% NaCl
3. $V_1 \times C_1 = V_2 \times C_2$
 $V_1 \times 50 = 100 \times 5$
 $V_1 \times 50 = 500$
 $V_1 = 10$
 10 ml 50% dextrose + 90 ml water
4. $V_1 \times C_1 = V_2 \times C_2$
 $V_1 \times 0.9 = 500 \times 0.45$
 $V_1 \times 0.9 = 225$
 $V_1 = 250$
 250 ml 0.9% NaCl + 250 ml 5% dextrose
5. $V_1 \times C_1 = V_2 \times C_2$
 $V_1 \times 50 = 2000 \times 2.5$
 $V_1 \times 50 = 5000$
 $V_1 = 100$
 100 ml 50% dextrose + 1900 ml lactated Ringer's solution
6. $V_1 \times C_1 = V_2 \times C_2$
 $V_1 \times 50 = 50 \times 5$
 $V_1 \times 50 = 250$
 $V_1 = 5$
 5 ml 50% dextrose + 45 ml water
7. $V_1 \times C_1 = V_2 \times C_2$
 $V_1 \times 50 = 500 \times 2.5$
 $V_1 \times 50 = 1250$
 $V_1 = 25$
 25 ml 50% dextrose + 475 ml 0.45% NaCl
8. Remember: 10% solution = 100 mg/ml packets containing 50 g = 50,000 mg
 $V_1 \times C_1 = V_2 \times C_2$
 $V_1 \times 50,000 = 1000 \times 100$
 $V_1 \times 50,000 = 100,000$
 $V_1 = 2$
 2 packets of 50 g GG powder + 1000 ml water
9. Remember: 8% solution = 80 mg/ml
 One 5-g vial contains 5000 mg
 $V_1 \times C_1 = V_2 \times C_2$

$$1 \times 5000 = V_2 \times 80$$

$$5000 = V_2 \times 80$$

$$62.5 = V_2$$

62.5 ml needs to be added to one 50-g vial to prepare an 8% solution

10. Remember: 2% solution = 20 mg/ml

$$V_1 \times C_1 = V_2 \times C_2$$

$$V_1 \times 100 = 5 \times 20$$

$$V_1 \times 100 = 100$$

$$V_1 = 1$$

1 ml of Sandimmune (cyclosporine) + 4 ml virgin olive oil

11. Remember: 37% formaldehyde = 100% formalin

$$V_1 \times C_1 = V_2 \times C_2$$

$$V_1 \times 100 = 50 \times 2$$

$$V_1 \times 100 = 100$$

$$V_1 = 1$$

1 ml 37% formaldehyde + 49 ml water

Problems Calculating IV Drop Rates

- 42 gtt/min or approximately 0.69 gtt/sec
- 60 gtt/min or 1 gtt/sec
- 30 gtt/min or 1 gtt/2sec
- 0.15 ml/min or 9 gtt/min
- 0.5 ml/min or 30 gtt/min
- 1.52 ml
- 18 ml/hr
- 20 ml
- 1.5 ml
- 3.3 ml

ANSWERS TO CHAPTER 4

- An agonist is a drug that combines with a receptor to bring about an action, whereas an antagonist combines with a receptor and blocks the action.
- A neurotransmitter is a chemical substance released by a nerve ending at the synapse. It acts on the adjacent neuron to stimulate, inhibit, or change its activity.
- b. Thalamus
- Interrupting the generation or conduction of nerve impulses; interfering with
- Epinephrine or norepinephrine
- Mimicking neurotransmitters, interfering with neurotransmitter release, blocking the attachment of neurotransmitters to receptors, and interfering with the breakdown of neurotransmitters
- To control vomiting, to treat urinary retention, to stimulate gastrointestinal activity, to treat glaucoma, and to aid in the diagnosis of myasthenia gravis
- Cholinergic blocking agents (anticholinergic)
- Adrenergic (sympathomimetic)
- d. Beta blocker
- Bradycardia and hypotension may be antagonized by using atropine; respiratory depression or excessive CNS depression may be antagonized by using yohimbine.
- Thiobarbiturates are very soluble in fat, which acts like a sponge to take the barbiturate out of the circulation and away from the CNS. Thin animals have reduced fat levels, which means that more of the thiobarbiturate remains in the bloodstream and may cause excessive depression of the CNS.
- Analgesia, increased muscle tone, maintenance of pharyngeal/laryngeal reflexes, muscle tremors, and loss of the blink reflex
- Respiratory depression, cardiac depression, agitation, excitement, or seizures
- Naloxone and nalorphine
- Because of its tendency to precipitate out of solution when stored
- Doxapram (Dopram) may be administered on or under the tongue, into the umbilical vein, or by intramuscular injection.
- Some pentobarbital euthanasia agents have a red dye added to distinguish them from pentobarbital agents that may be used for anesthesia. Because these agents are easily identified as euthanasia agents, they have less potential for abuse.
- Neurotransmitter
- Burning
- Propofol
- GABA
- Diazepam
- Clomicalm
- Anipryl

26. b. endocrine
27. a. somatic
28. d. neuron
29. a. away; toward
30. b. false
31. b. unconscious
32. d. acetylcholine
33. c. communication with stem cells in the bone marrow
34. d. yohimbine
35. a. yohimbine

ANSWERS TO CHAPTER 5

1. Nostrils, nasal cavity, pharynx, larynx, trachea, bronchi, and bronchioles
2. The four functions of the respiratory system are oxygen-carbon dioxide exchange, regulation of acid-base balance, body temperature regulation, and voice production.
3. Structures in the nasal passages filter, warm, and humidify inspired air. The cough, sneeze, and reverse sneeze attempt to remove foreign material that has entered the respiratory system. The mucociliary mechanism also removes foreign material from the respiratory system. Macrophages and immunoglobulins inactivate or destroy invasive organisms.
4. The three important principles of respiratory therapeutics are control of secretions, control of reflexes, and maintenance of normal airflow.
5. Productive
6. Through the breakdown of disulfide chemical bonds
7. Acetylcysteine is administered by nebulization.
8. Through depression of the cough center in the brain
9. Schedule V
10. Release of acetylcholine, release of histamine, and blockade of beta-2-adrenergic receptors
11. Epinephrine and albuterol
12. Phosphodiesterase
13. Treatment of insect bites and treatment of heaves in horses
14. -amine
15. Treatment of respiratory depression associated with anesthesia and stimulation of respiration in newborn animals
16. $22.7 \text{ kg} \times 0.22 \text{ mg/kg} = 4.9 \text{ mg}$; 5-mg tablets are available. Dispense 14 tablets.
17. 1. As a mucolytic agent. 2. As an antidote for acetaminophen toxicity.
18. E
19. 1 to 5 microns
20. Albuterol
21. c. production of sodium bicarbonate to aid in regulation of the acid-base balance
22. d. expectorants
23. a. antitussives
24. b. butorphanol tartrate
25. d. Class II
26. a. prednisolone
27. c. methylxanthine
28. b. decongestants
29. a. antihistamines
30. c. prednisolone Na succinate

ANSWERS TO CHAPTER 6

1. Kidneys, ureters, bladder, urethra
2. Rompun and Ketaset
3. Prerenal, renal, postrenal
4. Diuretics work by removing excess extracellular fluid, by increasing urine volume and sodium excretion, and by decreasing hypertension
5. Potassium (K)
6. Angiotensin II
7. Struvite
8. Erythropoietin, decrease
9. Loop diuretics inhibit the tubular reabsorption of sodium.
10. Posterior pituitary gland
11. b. originate from the kidneys and connect to the urinary bladder
12. c. hypertension
13. b. extracellular
14. b. posterior
15. d. potassium
16. b. uroliths
17. a. hematuria

18. b. tubules
19. b. false
20. c. sodium

ANSWERS TO CHAPTER 7

1. The right atrium and right ventricle serve functionally as one pump for ejecting blood to the lungs, and the left atrium and left ventricle pump blood to the systemic circulation.
2. Syncytium (interconnected mass)
3. Sodium (Na^+), calcium (Ca^{2+}), potassium (K^+)
4. Refractory period
5. Chronotropic refers to the rate of contraction, whereas inotropic refers to the force or strength of contraction.
6. Preload is the volume of blood in the ventricles at the end of diastole (the amount of blood that must be pumped out). Afterload is the resistance in the arteries that the ventricle must overcome to pump blood.
7. Increasing the heart rate, increasing the stroke volume, increasing the efficiency of the heart muscle, and heart enlargement
8. Control rhythm disturbances, maintain or increase cardiac output, relieve fluid accumulations, increase the oxygenation of blood, and provide oxygen/sedatives
9. Beneficial effects include improved cardiac contractility, decreased heart rate, antiarrhythmic effect, and decreased signs of dyspnea. A toxic effect is vomiting.
10. Stimulation of cardiac contraction in cardiac arrest
11. Conditions that cause hypoxia; electrolyte imbalances; increased levels or sensitivity to catecholamines; certain drugs such as digitalis, barbiturates, and others; and cardiac trauma or disease
12. Class IA—quinidine; class IB—lidocaine; class IC—flecainide; class II—propranolol; class III—bretylum; class IV—diltiazem
13. Hydralazine—arteriolar dilator; nitroglycerin—venodilator; prazosin—combined; enalapril—combined
14. Lasix is called a loop diuretic because it inhibits reabsorption of sodium in the loops of Henle.
15. Potassium
16. Bronchodilation, oxygen therapy, sedation, aspiration, and centesis
17. Depolarization
18. Cardiac output
19. Congestive heart failure
20. Angiotensin I to angiotensin II
21. Wear gloves; rotate application sites; do not pet the animal at the application site; measure the dosage in inches; and contact the veterinarian if a rash appears at the application site.
22. Lasix
23. An abnormally low potassium level in the blood
24. The primary goals are (1) sodium restriction and (2) maintenance of good body weight and condition (reduction of obesity or cachexia). In some instances, specific nutrient deficiencies, concurrent disease, and/or electrolyte disorders may need to be addressed.
25. (1) Increased force of contraction; (2) an increase in blood pressure; (3) elevated blood glucose levels
26. b. Four
27. c. tachycardia
28. b. arrhythmia
29. a. decreasing heart rate to such an extent that the myocardium is protected from damage caused by the increased workload
30. d. diaphragmatic hernia
31. c. cardiac glycoside
32. a. decreased
33. b. false
34. b. decrease
35. b. hypokalemia

ANSWERS TO CHAPTER 8

1. Entry of food and fluid into the body, absorption of nutrients, and excretion of waste products
2. Dogs, cats, and primates
3. Ruminants have a system of forestomachs, including the reticulum, rumen, and omasum, which allows them to digest coarse plant material, as well as a true stomach (abomasum).

4. Regurgitation is a normal process of ruminants that permits them to bring up partially digested foodstuff for rechewing. Vomiting is the forcible expulsion of gastric contents and is generally considered to be pathologic.
5. Microorganisms in the rumen
6. The autonomic nervous system, hormonal control, and chemical (histamine, prostaglandin, and others) control
7. Bacterial endotoxins may increase the permeability of intestinal blood vessels, resulting in increased fluid loss. They also may induce fever and initiate shock.
8. Chemical substances (digitalis compounds, urea, ketone bodies, and others) and impulses from the inner ear
9. Centrally acting—apomorphine and xylazine; peripherally acting—syrup of ipecac and mustard
10. Antiemetics
11. Reducing the secretion of hydrochloric acid by gastric mucosal cells
12. Cimetidine and ranitidine
13. Peristalsis (a wave of contraction) and segmentation (a mixing action)
14. Withholding of food for 12 to 24 hours
15. Rats and horses
16. By retaining water osmotically in the gut, these agents cause softening of the stool.
17. Psyllium
18. By mimicking the effect of acetylcholine
19. Metronidazole
20. C.E.T., Nolvadent, Oral Dent, and Oxydent
21. Peristalsis refers to a wave of contraction that moves contents along, and segmentation refers to intestinal constrictions that mix contents.
22. False
23. 80%
24. By forming a paste-like barrier over the surface of gastric ulcers
25. Felines
26. d. excretion of urine
27. b. equines
28. a. true
29. b. food storage
30. a. ilium
31. d. apomorphine

32. H₂ receptor antagonist
33. d. laxatives
34. c. Epsom salts
35. d. both b and c

ANSWERS TO CHAPTER 9

1. Releasing factors (RFs) are messengers made by the hypothalamus in response to its detection of hormone levels in the blood. RFs send messages to the pituitary to stimulate this gland to manufacture trophic hormones. Trophic hormones, in turn, stimulate a specific tissue or gland to produce the hormone in question.
2. The major endocrine glands are the pituitary, the thyroid, the ovaries, the testicles, the adrenals, and the pancreas.
3. To correct a deficiency and to obtain a desired effect
4. In the body; external
5. The pituitary gland is located at the base of the brain ventral to the hypothalamus, and its primary function is to control the activity of the other endocrine glands.
6. A negative feedback mechanism occurs when the hypothalamus senses a high level of a specific hormone in the blood and in response reduces the amount of releasing factor (RF) for this hormone. A reduced amount of RF causes a decreased amount of trophic hormone to be produced by the pituitary; this results in decreased production of the hormone by the target organ.
A positive feedback mechanism occurs when the hypothalamus senses a low level of the hormone in question and increases its production of RF. Increased RF causes an increase in trophic hormone and a resultant increase in activity of the target organ.
7. Neurohormonal reflex
8. Gonadotropin
9. Progestins
10. Estrus synchronization, to induce abortion, and to induce estrus
11. Pregnant; asthmatics
12. Estrogen and progesterone

13. The reproductive tract has been examined for blockage or torsion, and that the cervix has dilated.
14. Triiodothyronine (T_3) and tetraiodothyronine (T_4)
15. Soloxine and Synthroid
16. Short-acting (regular/lispro/aspart), intermediate-acting (NPH/PZI/Lente), long-acting (Glargine/detemir)
17. Regular
18. NPH/PZI/Lente
19. Weakness, ataxia, shaking, and seizures
20. Breeding purposes
21. Because of the potential for abuse by human athletes
22. Pheromones
23. Wear gloves and/or avoid getting the drug on the skin
24. Residues of DES were shown to have a likely link to cervical cancer in women.
25. Corpus luteum
26. d. uterus
27. c. trophic
28. d. hypothalamus
29. a. estradiol cypionate
30. b. false
31. a. true
32. c. oxytocin
33. b. the adrenal cortex
34. d. odors
35. b. hypothyroidism

ANSWERS TO CHAPTER 10

1. Dilate
2. Glaucoma, keratoconjunctivitis sicca
3. Pupillary
4. Ophthalmic stains are used as diagnostic aids for detecting disease in both the anterior and posterior segments and in the nasolacrimal system.
5. Fluorescein
6. Aural
7. Topical ophthalmics (e.g., ointments, drops)
8. Because the eye secretes tears, the medication may be quickly diluted; thus reapplication becomes necessary.

9. To provide local anesthesia to the eye
10. False
11. c. third eyelid
12. a. dilate
13. b. mydriasis
14. a. closed
15. b. false
16. a. 5; 10
17. b. corneal ulcers
18. c. equines
19. b. false
20. d. Acaress

ANSWERS TO CHAPTER 11

1. Three, integumentary
2. Proper nutrition
3. Protection, temperature regulation, storage, immunoregulation, secretion, vitamin D production, and sensory perception
4. Five to ten
5. Antiseborrheic
6. Inflammatory, debridement, repair, maturation
7. Has drying and cleansing properties
8. True
9. Systemic
10. To keep the animal from excessive self-licking and/or mutilation
11. b. false
12. c. skin
13. a. true
14. b. false
15. a. true
16. d. 6
17. b. collagen
18. b. false
19. d. granulation
20. c. Kopertox

ANSWERS TO CHAPTER 12

1. Gram
2. Blue
3. Red

4. Naxcel
5. Tetracyclines
6. Tetracycline
7. Oto-, nephro-
8. Dermatophytosis
9. Spectrum
10. True
11. b. false
12. a. true
13. a. fungal
14. b. false
15. a. cephalexin
16. b. false
17. d. a tetracycline
18. b. false
19. c. fluoroquinolone
20. a. true

ANSWERS TO CHAPTER 13

1. Predator-prey, commensalism, mutualism, phoresis, parasitism
2. Parasitiasis occurs when an animal is infected with parasites, but no clinical signs can be observed.
3. Parasitosis occurs when an animal is infected with parasites, and clinical signs can be observed.
4. Ectoparasites infest the outside of the body.
5. Endoparasites infect the inside of the body.
6. Infected; infested
7. An anthelmintic is administered to rid the body of endoparasites.
8. Organophosphate
9. Insect growth regulators
10. Tapeworms
11. d. phoresis
12. a. avermectins
13. d. diethylcarbamazine
14. c. amitraz
15. b. Profender (emodepside/praziquantel)
16. c. melarsomine dihydrochloride
17. d. Valbazen
18. a. true
19. b. fleas; ticks
20. d. nematodes

ANSWERS TO CHAPTER 14

1. Nociceptors
2. Increased heart rate, increased respiratory rate, vocalization, guarding the painful site, restlessness, salivation, failure to groom, unresponsiveness, abnormal gait, abnormal stance, and rolling
3. COX-2
4. Gastrointestinal ulceration and/or bleeding
5. Cats metabolize aspirin very slowly.
6. False
7. Fentanyl
8. False
9. These substances regulate electrolyte and water balance in the body.
10. Alternate day dosing may help prevent iatrogenic hypoadrenocorticism; administration should be tapered off gradually; very large doses may be used in certain emergency situations; corticosteroids should be avoided when corneal ulcers are treated; use aseptic technique when injecting into joints.
11. Caused by the doctor
12. Short-term effects of corticosteroid use include polyuria, polydipsia, polyphagia, and delayed healing. Long-term effects include thinning of the skin, gastric ulcers, osteoporosis, and iatrogenic Cushing's disease.
13. Local anesthetics prevent generation and conduction of nerve impulses by peripheral nerves.
14. Local anesthetics are used for infiltrating into local areas for suturing wounds, for nerve blocks (lameness examination), for antiarrhythmic effects, for topical use, and others.
15. b. endorphins
16. c. pyrogen
17. b. aspirin
18. a. phenylbutazone
19. d. NSAID
20. b. vasodilation
21. b. morphine
22. a. histamine
23. d. ketoprofen
24. a. true

Hidden page

12. Treatment of autoimmune hemolytic anemia, treatment of lymphocytic-plasmacytic enteritis, treatment of rheumatoid arthritis, and treatment of lupus erythematosus
 13. Because most antineoplastic drugs are very irritating to tissue and may cause sloughing
 14. Designate a specific location for handling. Wear nonpermeable latex gloves when handling. Cover work surfaces with a disposable, plastic-backed sheet. Wear an appropriate laboratory coat and mask. Reconstitute all materials carefully to avoid aerosolization. Clean reconstituted material of any contamination, and properly mark and date it. Dispose of contaminated material in leak-proof, puncture-resistant containers. Wash hands thoroughly.
 15. In the kidney
 16. Epogen (erythropoietin)
 17. Plasmin
 18. Heparin
 19. It may distort the white blood cells, making identification difficult.
 20. It chelates (binds with) calcium.
 21. Anaphylactic reactions, immunosuppression, vomiting, diarrhea, hair loss, cystitis, pain associated with administration, and tissue damage from extravasation
 22. Body surface area
 23. Lymphoid neoplasia
 24. Interferon
 25. Doxorubicin
 26. b. bone marrow
 27. d. to carry O₂ to the tissues
 28. c. Hematinics
 29. d. Regu-Mare
 30. b. false
 31. c. 5 U/ml
 32. d. green
 33. d. K₁
 34. d. EDTA
 35. d. felines
- infectious disease, exposure to an infectious disease before immunity is reached, drug therapy
 3. An inactivated vaccine has organisms commonly treated by chemicals to kill the organism, but very little change occurs in the antigens that stimulate protective immunity.
 4. A live vaccine is prepared from live microorganisms or viruses.
 5. Modified live vaccine has organisms that have undergone a process (attenuation) to lose their virulence, so that when inoculated into the body, they cause an immune response instead of disease.
 6. A toxoid is a vaccine used in producing immunity to a toxin rather than bacterium or virus.
 7. An antitoxin is a specific antiserum aimed against a toxin that contains a concentration of antibodies extracted from blood plasma of a hyperimmunized, healthy animal (usually a horse).
 8. The contents should be unpacked and placed in the refrigerator.
 9. Using drugs to stimulate the body's immune response to disease
 10. Acemannan
 11. b. false
 12. d. administering a medicated bath prior to vaccination to clean the skin's surface
 13. c. inactivated (dead)
 14. a. live
 15. b. modified live
 16. b. antitoxin
 17. c. both a and b
 18. b. blepharospasm
 19. e. both b and c
 20. c. recombinant

ANSWERS TO CHAPTER 17

1. Routine checkups
2. Health/age, type of vaccine administered, route of administration, concurrent incubation of

ANSWERS TO CHAPTER 18

1. c. calcium EDTA
2. d. Bring the cat to the hospital to start treatment with acetylcysteine.
3. a. Rompun
4. b. on an empty stomach
5. Oxymorphone, Torbugesic, Talwin-V, and Nubain
6. b. blood urea nitrogen (BUN)

7. Articular cartilage and connective tissue
8. GAGs act as chondroprotective agents.
9. A nutraceutical is any nontoxic food component that has scientifically proven health benefits, including disease treatment and prevention. Glucosamine/chondroitin sulfate
10. True
11. The Dietary Supplement Health and Education Act of 1994
12. Omega-6 and omega-3 fatty acids
13. Increased bleeding time and possible decreased immune function
14. To prevent or reduce the systemic absorption of ingested drugs or toxins
15. Lead poisoning
16. Water-soluble
17. Naloxone
18. Benzodiazepines
19. S-adenosylmethionine
20. Ethylene glycol (antifreeze)
21. b. false
22. b. false
23. a. true
24. b. false
25. b. false
26. a. true
27. a. true
28. b. false
29. a. true
30. b. false
5. 4 turns
6. \$102,500
7. Make sure items are on hand when needed, and minimize the expense of keeping items in stock.
8. A packing slip is found in the carton in which freight is shipped. It documents how many of each item is shipped. It may or may not include the prices of the item(s), although most commonly it does not.
9. An invoice is documentation of an order shipped to the veterinary hospital. It may or may not accompany the packing slip in the shipping carton.
10. A statement is most commonly mailed to the veterinary practice. It documents the items received by the hospital and the amount due on account. Commonly, it must be paid within 30 days so that no late fees are incurred by the business.
11. The point at which a product is allowed to be sold or used in-house before new product is ordered
12. This number is included on the rabies certificate given to the client; also, rabies is a zoonotic disease, and the veterinarian must account for the expiration date of the vaccine and the serial number.
13. I
14. DEA inventory and usage, OSHA manuals, MSDS sheet, supplier's catalogs
15. All information on the form must be correct, no markouts are allowed, no liquid paper can be used, must have correct spelling, must have correct strength, and the veterinarian must sign the form.
16. a. true
17. d. 8
18. b. FIFO
19. d. the federal government
20. a. true
21. b. cost; retail
22. a. true
23. b. false
24. a. true
25. b. false

ANSWERS TO CHAPTER 19

1. Inventory is the quantity of goods present in the veterinary facility.
2. Develop a budget; keep abreast of expenses on a regular basis; once a system has been put in place, keep it active; budget analysis should mirror the practice's philosophy; analyzing expenses provides a comprehensive view of the condition of the practice and helps shape its future endeavors.
3. Money
4. The number of times a product is used and replenished each year
5. a. true
6. b. false
7. a. true
8. b. false
9. a. true
10. b. false
11. a. true
12. b. false
13. a. true
14. b. false
15. a. true
16. b. false
17. a. true
18. b. false
19. a. true
20. b. false
21. a. true
22. b. false
23. a. true
24. b. false
25. a. true
26. b. false
27. a. true
28. b. false
29. a. true
30. b. false

Copyrighted image

Glossary

- acetylcholine** A neurotransmitter that allows a nerve impulse to cross the synaptic junction (gap) between two nerve fibers or between a nerve fiber and an organ (e.g., muscle, gland).
- acetylcholinesterase** An enzyme that brings about the breakdown of acetylcholine in the synaptic gap.
- active immunity** Immunity that occurs by an animal's own immune response after exposure to foreign antigen.
- Addison's disease** A disease or syndrome characterized by inadequate amounts of corticosteroid hormones.
- adjuvant** A substance given with an antigen to enhance the immune response to the antigen. Adjuvants may form a localized granuloma at the injection site or may produce systemic hypersensitivity. Adjuvants have received much attention as a result of a possible (but not proven) link with the increased incidence of fibrosarcomas in vaccinated cats. Examples of adjuvants are aluminum hydroxide, aluminum phosphate, aluminum potassium sulfate, water in oil, saponin, and diethylaminoethyl (DEAE) dextran.
- adrenergic** A term used to describe an action or a receptor that is activated by epinephrine or norepinephrine.
- adsorbent** A drug that inhibits GI absorption of drugs, toxins, or chemicals by attracting and holding them to its surface.
- adverse drug reaction** An undesirable response to a drug by a patient. It may vary in severity from mild to fatal.
- aerosolization** The conversion of a liquid into a fine mist or colloidal suspension in air.
- afterload** The resistance (pressure) in arteries that must be overcome to empty blood from the ventricle.
- agonist** A drug that brings about a specific action by binding with the appropriate receptor.
- alkylation** Formation of a linkage between a substance and DNA that causes irreversible inhibition of the DNA molecule. Alkylating drugs are used in chemotherapy treatment of cancer.
- anabolism** The constructive phase of metabolism in which body cells repair and replace tissue.
- analgesia** The absence of the sensation of pain.
- analog** A chemical compound having a structure similar to another but differing from it in some way.
- anaphylaxis** A systemic, severe allergic reaction.
- anesthesia** The loss of all sensation. May be described as local (affecting a small area), regional, or surgical (accompanied by unconsciousness).
- angiogenesis** The development of blood vessels.
- antagonist** A drug that inhibits a specific action by binding with a particular receptor.
- anthelmintic** Drug used to eliminate helminth parasites (e.g., roundworms) from a host.
- antibacterial** An agent that inhibits bacterial growth, impedes replication of bacteria, or kills bacteria.
- antibiotic** An agent produced by a microorganism or semisynthetically that has the ability to inhibit the growth of or kill microorganisms.
- antibody** An immunoglobulin molecule that combines with the specific antigen that induced its formation.
- anticholinergic** Blocking nerve impulse transmission through the parasympathetic nervous system; also called *parasympatholytic*. Anticholinergic drugs may be used for the treatment of diarrhea or vomiting.
- antigen** Any substance that can induce a specific immune response, such as toxins, foreign proteins, bacteria, and viruses.
- antimicrobial** An agent that kills microorganisms or suppresses their multiplication or growth.
- antitussive** A drug that inhibits or suppresses the cough reflex.
- arrhythmia (dysrhythmia)** A variation from the normal rhythm.
- astringent** An agent that causes contraction after application to tissue.
- atony** The absence or lack of normal tone or strength.
- automaticity** The ability of cardiac muscle to generate impulses.
- autonomic nervous system** That portion of the nervous system that controls involuntary activities.
- average cost of inventory on hand** Average cost of inventory on hand is determined by adding the year's beginning inventory to the year's ending inventory and dividing by 2.
- avirulent** The inability of an infectious agent to produce pathologic effects.
- bacteria** Single-celled microorganisms that usually have a rigid cell wall and a round, rod-like, or spiral shape.
- bactericidal** An agent with the capability to kill bacteria.
- bacterin** A killed bacterial vaccine.
- bacteriostatic** An agent that inhibits the growth or reproduction of bacteria.
- beta-lactamase** Enzymes that reduce the effectiveness of certain antibiotics; beta-lactamase I is penicillinase; beta-lactamase II is cephalosporinase.
- bots** Larvae of several fly species (e.g., *Gastrophilus*, horse bot).
- bradyarrhythmia** Bradycardia associated with an irregularity of heart rhythm.
- bradycardia** A slower-than-normal heart rate.

Hidden page

- effector** A gland, organ, or tissue that responds to nerve stimulation with a specific action.
- efficacy** The extent to which a drug causes the intended effects in a patient.
- electrolyte** A substance that dissociates into ions when placed in solution, becoming capable of conducting electricity.
- elixir** A hydroalcoholic liquid that contains sweeteners, flavoring, and a medicinal agent.
- emesis** The act of vomiting.
- empirical** Based on observation and personal experience.
- emulsion** A medicinal agent that consists of oily substances dispersed in an aqueous medium with an additive to stabilize the dispersion.
- endometrium** The mucous membrane lining of the uterus.
- endoparasite** A parasite that lives inside the body of its host.
- endothelial layer** The smooth layer of epithelial cells that line blood vessels.
- entropion** A rolling inward (i.e., toward the cornea) of the eyelid.
- equivalent weight** 1 g molecular weight (from periodic chart) divided by the total positive valence of the material.
- erythema** Redness of the skin caused by congestion of the capillaries.
- erythropoiesis** The formation of erythrocytes.
- erythropoietin** A glycoprotein hormone secreted mainly by the kidney; it acts on stem cells of the bone marrow to stimulate red blood cell production.
- euthyroid** A normal thyroid gland.
- expectorant** A drug that enhances the expulsion of secretions from the respiratory tract.
- extralabel use** The use of a drug that is not specifically listed on the U.S. Food and Drug Administration (FDA)-approved label.
- exudation** Leakage of fluid, cells, or cellular debris from blood vessels and their deposition in or on the tissue.
- feedback** The return of some of the output product of a process as input in a way that controls the process.
- feed efficiency** The rate at which animals convert feed into tissue. It is expressed as the number of pounds or kilograms of feed needed to produce 1 lb or 1 kg of animal.
- fibrinolysis** Fibrin (clot) breakdown through the action of the enzyme plasmin.
- FIFO** First in, first out.
- FOB** Acronym for "free on board."
- FOB destination** Title of possession passes from the pharmaceutical company to the buyer (i.e., the purchaser) when the shipment is delivered to the buyer's business destination (i.e., the veterinary facility).
- FOB shipping point** Title passes from the pharmaceutical company to the purchaser when the vendor places the goods in the possession of the carrier (e.g., United Parcel Service, Federal Express, Averitt Express).
- full-service company** A pharmaceutical company that offers full service (e.g., the company employs sales representatives [reps] who visit veterinary facilities), usually with a limited number of products.
- fungicidal** An agent that kills fungi.
- fungistatic** An agent that inhibits the growth of fungi.
- ganglionic synapse** The site of the synapse between neuron one and neuron two of the autonomic nervous system.
- glaucoma** A group of eye diseases characterized by increased intraocular pressure that results in damage to the retina and the optic nerve.
- gonadotropin** A hormone that stimulates the ovaries or testes.
- granulation tissue** New tissue formed in the healing of wounds of the soft tissue, consisting of connective tissue cells and ingrown young vessels; it ultimately forms a scar.
- half-life** The amount of time (usually expressed in hours) that it takes for the quantity of a drug in the body to be reduced by 50%.
- helminths** Parasite worms, including nematodes, cestodes, and trematodes.
- hematemesis** Vomiting of blood (the vomitus often resembles coffee grounds).
- hematuria** Blood in the urine.
- histamine** A chemical mediator of the inflammatory response released from mast cells. Histamine may cause dilation and increased permeability of small blood vessels, constriction of small airways, increased secretion of mucus in the airways, and pain.
- humidification** Addition of moisture to the air.
- hybridoma** A cell culture that consists of a clone of a hybrid cell formed by fusing cells of different types, such as stimulated mouse plasma cells and myeloma cells.
- hyperkalemia** An excess of potassium in the blood.
- hyponatremia** An excess of sodium in the blood.
- hypertension** Persistently high blood pressure.
- hypertonus** The state characterized by an increased tonicity or tension.
- hypokalemia** Abnormally low potassium concentration in the blood.

- hyponatremia** A deficiency of sodium in the blood.
- hypophyseal portal system** This is the portal system of the pituitary gland in which venules from the hypothalamus connect with capillaries of the anterior pituitary.
- hypovolemia** Decreased volume of circulating blood.
- iatrogenic** Caused by the physician (veterinarian).
- ICM (inventory control manager)** A person (many times a licensed veterinary medical technician [LVMT]) responsible for monitoring, ordering, and maintaining inventory in a veterinary facility.
- IgA** Class of antibody produced on mucous membrane surfaces, such as those of the respiratory tract.
- inotropic** Affecting the force of cardiac muscle contraction.
- inspissated** Thickened or dried out.
- integumentary system** Pertaining to, or composed of, skin.
- inventory** The quantity of goods or assets that a veterinary facility possesses, requiring proactive control to keep supplies stable and current.
- in vitro** Within an artificial environment.
- in vivo** Within the living body.
- invoice** A form generated by a company that documents the quantity and price of each item ordered by the inventory control manager.
- involution** The return of a reproductive organ to normal size after delivery.
- iodophor** An iodine compound with a longer activity period that results from the combination of iodine and a carrier molecule that releases iodine over time.
- keratitis** Inflammation of the cornea.
- keratolytic** An agent that promotes loosening or separation of the horny layer of the epidermis.
- keratoplastic** An agent that promotes normalization of the development of keratin.
- levo isomer** Left-sided arrangement of a molecule that may exist in a left- or a right-sided configuration. Levo and dextro isomers have the same molecular formula.
- liniment** A medicine in an oily, soapy, or alcoholic vehicle to be rubbed on the skin to relieve pain or to act as a counterirritant.
- lower motor neurons** Peripheral neurons whose cell bodies lie in the central gray columns of the spinal cord and whose terminations lie in skeletal muscle. A sufficient number of lesions of lower motor neurons cause muscles supplied by the nerve to atrophy, resulting in weak reflexes and flaccid paralysis.
- mail order discount house** A company that accepts orders from the buyer by telephone; a good source for ordering items such as gauze, cotton, isopropyl alcohol, or paper towels.
- manufacturing** The bulk production of drugs for resale outside of the veterinarian-client-patient relationship.
- markup** The amount of money over cost that a product sells for. Markup percentages vary from practice to practice, but all markups reflect a retail value over wholesale value.
- melena** Dark or black stools that result from blood staining. Bleeding has occurred in the anterior part of the GI tract.
- metabolic acidosis** Decreased body pH caused by excess hydrogen ions in the extracellular fluid.
- metabolic alkalosis** Increased body pH caused by excess bicarbonate in the extracellular fluid.
- metabolism (biotransformation)** The biochemical process that alters a drug from an active form to a form that is inactive or that can be eliminated from the body.
- metastasis** Generally refers to the transfer of cancer cells from one site to another.
- methemoglobinemia** The presence of methemoglobin in the blood caused by injury or toxic agents that convert a larger-than-normal proportion of hemoglobin into methemoglobin, which does not function as an oxygen carrier.
- microfilaria** A prelarval stage of a filarial worm transmitted to the biting insect from the principal host (e.g., filarial stage of *Dirofilaria immitis*).
- microorganism** An organism that is microscopic (e.g., bacterium, protozoan, Rickettsia, virus, and fungus).
- milliequivalent** 1/1000 of an equivalent weight. A term used to express the concentration of electrolytes in a solution.
- miosis** Contraction of the pupil.
- modulation** The modification of nociceptive transmission.
- monovalent** A vaccine, antiserum, or antitoxin developed specifically for a single antigen or organism.
- motilin** A hormone secreted by cells in the duodenal mucosa that causes contraction of intestinal smooth muscle.
- mucolytic** Having the ability to break down mucus.
- muscarinic receptors** Receptors activated by acetylcholine and muscarine that are found in glands, the heart, and smooth muscle. An acronym for remembering muscarinic effects is "SLUD": S = salivation; L = lacrimation; U = urination; D = defecation.
- mydriasis** Dilation of the pupil.
- myeloma** A malignant neoplasm of plasma cells (B-lymphocytes).

- myelosuppression** Inhibiting bone marrow activity that results in decreased production of blood cells and platelets.
- myofibril** A muscle fibril composed of numerous myofilaments.
- nebulization** The process of converting liquid medications into a spray that can be carried into the respiratory system by inhaled air.
- nematodes** Parasitic worms, including intestinal roundworms, filarial worms, lungworms, kidney worms, heartworms, and others.
- nephrology** The study of the urinary (renal) system.
- nephron** The basic functional unit of the kidney.
- nerve block** A loss of feeling or sensation produced by injecting an anesthetic agent around a nerve to interfere with its ability to conduct impulses.
- nicotinic receptors** Receptors activated by acetylcholine and nicotine found at the neuromuscular junction of the skeletal muscle and at the ganglionic synapses.
- nitrogen balance** The condition of the body as it relates to protein intake and use. Positive nitrogen balance implies a net gain in body protein.
- nonproductive cough** A cough that does not result in coughing up of mucus, secretions, or debris (a dry cough).
- nutraceutical** Any nontoxic food component that has scientifically proven health benefits.
- ointment** A semisolid preparation that contains medicinal agents for application to the skin or eyes.
- oncotic pressure** The osmotic pressure generated by plasma proteins in the blood.
- open-angle glaucoma** A type of primary glaucoma of the eye in which the angle of the anterior chamber remains open, but filtration of the aqueous humor is gradually reduced, causing an increase in intraocular pressure.
- organophosphate** A substance that can interfere with the function of the nervous system by inhibiting the enzyme cholinesterase.
- packing slip** A document supplied by the vendor that accompanies a purchase. A packing slip generally reflects quantities ordered, not prices.
- parasitiasis** A condition in which an animal harbors an endoparasite or an ectoparasite, but no clinical signs of infection or infestation are evident.
- parasitosis** A condition in which an animal harbors an endoparasite or an ectoparasite, and clinical signs of infection or infestation are evident.
- parasympathetic nervous system** That portion of the autonomic nervous system that arises from the craniosacral portion of the spinal cord, is mediated by the neurotransmitter acetylcholine, and is concerned primarily with conserving and restoring a steady state in the body.
- parasympathomimetic** A drug that mimics the effects of stimulating the parasympathetic nervous system.
- parenteral** The route of administration of injectable drugs.
- parietal cell** A cell located in the gastric mucosa that secretes hydrochloric acid.
- partition coefficient** The ratio of the solubility of substances (e.g., gas anesthetics) between two states in which they may be found (e.g., blood and gas, gas and rubber goods).
- passive immunity** Immunity that occurs by administration of antibody produced in another individual.
- peristalsis** A wave of smooth muscle contraction that passes along a tubular structure (GI or other) and moves the contents of that structure forward.
- polydipsia** Excessive thirst manifested by increased water consumption.
- polyuria** Excessive urination.
- polyvalent** A vaccine, antiserum, or antitoxin active against multiple antigens or organisms; mixed vaccine.
- preload** The volume of blood in the ventricles at the end of diastole.
- premature ventricular contraction (PVC)** Contraction of the ventricles without a corresponding contraction of the atria. PVCs arise from an irritable focus or foci in the ventricles.
- prescription (legend) drug** A drug that is limited to use under the supervision of a veterinarian because of potential danger, difficulty of administration, or other considerations. The legend that designates a prescription drug states the following: "Caution: Federal law restricts this drug to use by or on the order of a licensed veterinarian."
- preservative** A substance, such as an antibiotic, anti-infective, or fungistat, that is added to a product to destroy or inhibit multiplication of microorganisms.
- primary hypothyroidism** Hypothyroidism resulting from a pathologic condition in the thyroid.
- productive cough** A cough that results in coughing up of mucus, secretions, or debris.
- prostaglandin** A substance synthesized by cells from arachidonic acid that serves as a mediator of inflammation and has other physiologic functions.
- pruritus** Itching.
- pyoderma** Any skin disease characterized by the presence or formation of pus.
- recombinant DNA technology** A process that removes a gene from one organism or pathogen and inserts it

Hidden page

Hidden page

INDEX

- 2-PAM (pralidoxime), 79, 378
2.5X Flea and Tick Powder, 273
50% dextrose solution, 317-318
 concentration of dextrose in, 318TN
- A**
- A fibers, 73, 279-280
A-H (doxylamine), 110
Abbokinase (urokinase), 333
Abbreviations, medical and
 pharmacologic, 48, 410
Abdominocentesis, 145
Absorbine Veterinary Liniment, 222
Absorption, drug, 8-10
 and administration route, 7-8, 9
 factors affecting, 8-10
 and lipid solubility of drug, 9-10
Acarexx (0.01% ivermectin), 207
ACE (angiotensin-converting
 enzyme) inhibitors, 123, 143
Ace-Otic Cleanser, 207
Acemannan, 343, 366
Acemannan Immunostimulant, 365r
Acepromazine, 81, 89
Acepromazine maleate, 82
Acetaminophen, 284
 acetylcysteine antidote to, 106,
 377-378, 378TN
 contraindications to, for cats,
 108TN, 284TN
Acetazolamide, 121
 for treatment of glaucoma, 199
Acetic acid, as topical antiseptic, 218
Acetylcholine, 70, 75
 action of, 77, 78, 108
 and behavioral pharmacotherapy, 95
Acetylcholinesterase, 70, 78
Acetylcholinesterase inhibitors, as
 gastrointestinal prokinetics, 166
Acetylcysteine
 as antidote to acetaminophen
 poisoning, 377-378, 378TN
 as mucolytic, 106, 377
Acetylcysteine ophthalmic, 204
Acid-base balance, regulation of, 104
Acid citrate dextrose (ACD) solution,
 331-332
Acidified Copper Sulfate, 223
Acidifying diets, client education
 about, 124TN
- Acral lick dermatitis, canine, 220, 223
ACTH. See Adrenocorticotropic
 hormone.
Actimmune injection (recombinant
 interferon), 343
Activase (alteplase), 333
Activated charcoal, 162-163, 376,
 376TN
Active immunity, 349
 vaccines that produce, 351-353
Acular (ketorolac tromethamine), 203
Acyclovir, 202, 244
Acyclovir ophthalmic solution, 202
Adalat (nifedipine), 141
Adams Flea and Tick preparations, 273
Addison's disease, 278, 292, 293
Additives, 3, 4t, 10, 35. See also
 Inactive (inert) ingredients;
 Preservatives.
 in fluids for therapy, 315-318
Adequan preparations (polysulfated
 glycosaminoglycans), 286, 370
Adjuvant, immunologic, 349
 responses to, 356
Administration of drug. See Drug
 administration.
Adrenalin (epinephrine), 80
Adrenalin Chloride (epinephrine
 HCl), 137
Adrenergic, definition of, 70
Adrenergic agonists, 70, 80. See also
 Catecholamine(s);
 Noncatecholamines.
 for cardiovascular disorders, 136-137
 for glaucoma, 200
 inhibition of, by beta adrenergic
 antagonists, 122
 for pain treatment, 288
Adrenergic antagonists (adrenergic
 blocking agents), 80-81, 122
Adrenergic nervous system. See
 Sympathetic (adrenergic)
 nervous system.
Adrenergic receptor(s), 75, 77f
 responses of, 77, 78f
Adrenocorticotropic hormone
 (ACTH), 174, 290
 fetal production of, 177
 target and actions of, 175t
- Adriamycin, 337
Adsorbent agent(s), 150
 gastrointestinal, 162-163
Advance Power Freshen, 168
Advantage preparations (imidacloprid),
 267, 269t, 271, 271TN
Adverse reaction(s), to drug, 2, 14-15
 information resources on, 414t
 reporting, to veterinarian, 5
Aero-Chamber, 105
Aero-Mask, 105
Aerosol formulation, 35
Aerosol therapy, 105
Aerosolization, 102
Affinity, of drug and receptor, 13, 15f
Afrin (oxymetazoline), 110
Afterload, 130, 133
 increased, in heart failure, 141
Agonist, 14, 121
 combination of, with receptor, 15f
 definition of, 2, 115
Akarpine (pilocarpine), 78
Albendazole, 253
 for treating *Giardia* infection, 264
Albon (sulfadimethoxine)
 preparations, 241, 264
Albuterol, 80
 as bronchodilator, 109
Alcohol(s)
 as disinfecting agent, 244-245, 245t
 increasing sporicidal and antiviral
 activity of, 245TN
 precautions in using, on skin,
 245TN
 as topical antiseptic, 217
Aldactone (spironolactone), 121, 144
Aldosterone, 141
Aldosterone antagonists, 121
Alferon N (leukocyte derived
 interferon), 343
Alkaban-AQ (vinblastine), 341
Alkalis, as disinfectants, 248
Alkylating agents, 336
 commonly used, 338t
Alkylation, 326
Alkylphenol derivative, 92-93
Allergic conditions
 antihistamines for treatment of,
 288-289

- Allergic conditions (*Continued*)
 corticosteroids for treatment of, 289, 291
- Allergic dermatitis, 211
 systemic corticosteroids for, 220, 291
 topical corticosteroids for, 217
- Allergic reaction, after parenteral drug injection, 40
- Allerseb-T Shampoo, 213
- Allopurinol, for dissolution of uroliths, 124
- AloCetic, 208
- Alpha-1 receptors, and alpha-2 receptors, 75, 77, 80
 responses of, 78t
- Alpha adrenergic agonists, 80. *See also* Adrenergic agonists.
 for pain treatment, 288
- Alpha adrenergic antagonists, 81, 381, 381TN
 clinical indications for, 122, 143
 unnecessary dosage modification, 122TN
- Alpha blockers. *See* Alpha adrenergic antagonists.
- Alpha Keri Therapeutic Bath Oil, 216
- Alpha tocopherol (vitamin E), 321
- Alphagan (brimonidine), 200
- Alprazolam, 82-83
 as appetite stimulant, 83TN, 168
 in behavioral pharmacotherapy, 95-96
- Alteplase, 333
- Alternative medicines, 370
 chondroprotectives, 370
 herbs, 372-376
 nutraceuticals, 370-372
 references on, 382
- Altrenogest, 180
 precautions for technicians, 180TN
- Aluminum acetate, as astringent, 216
- Aluminum carbonate, 160
- Aluminum hydroxide, 160
- Aluminum/magnesium hydroxide, 160
- Alupent (metoprolol), 109
- Alveoli, 103-104, 103f
 maintaining normal airflow to, 105
- Amantadine, 244
- American Veterinary Medical Association (AVMA), 22, 372-373
- Amiglyde-V (amikacin), 237
- Amikacin, 237
- Aminoglycosides, 236-237
 avoiding nephrotoxic effects of, 236
 contraindications to use of, 237TN
- Aminoglycosides (*Continued*)
 precautions in use of, with other drug therapies, 237TN
 preparations of (including indications and antagonists), 236t
- Aminopentamide, 79
 as antiemetic, 157
 as bronchodilator, 109
 for treatment of diarrhea, 162
- Aminophylline (generic), 109
- Aminopropazine, action of, and indications, 126t
- Amiodarone, for arrhythmias, 140
- Amitraz, 274
- Amitriptyline, 96
 for behavior modification in self-licking, 223
 for idiopathic feline lower urinary tract disease, 126
- Amlodipine
 for arrhythmias, 141
 for hypertension in renal insufficiency, 123
- Ammonium chloride, 123-124
- Amoxicillin, 230t
 dosage forms of, 231
 and potassium calvulanate, 231t, 232
- Amphetamines, 94
- Anphojel, 160
- Amphotericin B, 242, 242TN
- Ampicillin, 231
 and hetacillin, 230t
- Amprolium, 264
- Anpale(s), 29, 30f
 proper breakage technique for, 29TN
- Amrinone, 137
- AmTech ProstaMate (dinoprost tromethamine), 181
- Anabolic steroids, 191-192
- Anabolism, 173
- Anafranil (clomipramine), 96
- Analgesia, 70, 82, 278. *See also* Pain, drugs for treatment of.
 definition of, 278
- Analgesics, 278-279
- Analog compound, 173, 181
- Anaphylaxis (anaphylactic shock), 349
 clinical signs of, 356
 treatment of, 288
 adrenergic agents in, 80
 epinephrine in, 109
- Anaplasmosis block, 235
- Anaprime Ophthalmic Solution, 203
- AnaSed (xylazine hydrochloride), 83
- Ancef (cefazolin), 234
- Ancobon (flucytosine), 243
- Androgens, 178-179
 as hematinic agents, 124, 328
- Anectine (succinylcholine chloride), 94
- Anemia, 327
- Anesthesia, 70, 81
 adrenergic agents in prolonging, 80
 drugs for. *See* Anesthetics.
 epidural, 293
 local and regional, 278, 293, 294f
 neuromuscular blocking agents as adjunct to, 94, 293
 premedications in, 79, 84, 87-88
- Anesthetic mask, small animal, 47f
- Anesthetics, 81, 293-294
 administration of, 46, 47f, 293
 adverse effects of, 295
 barbiturates, 84-85
 benzodiazepine derivatives, 82
 dissociative agents, 86
 dosage forms of, 294-295
 inhaled, 90-92. *See also* Inhalant anesthetics.
 injectable, 294-295
 local, 293
 onset and duration of, 293
 topical, 295
 topical ophthalmic, 201, 295
 xylazine hydrochloride, in combination with other drugs, 83
- Anestrus, 176
- Angioedema, with acute allergic reactions, 288
- Angiogenesis, in wound healing, 211, 219
- Angiotensin-converting enzyme (ACE), 141
- Angiotensin-converting enzyme (ACE) inhibitors, 123, 143
- Animal blood banking, information resources on, 414t
- Animal drug amendment, 22t
- Animal Drug Availability Act (1996), 23
- Animal health sciences, information resources, 415t
- Animal Medicinal Use Clarification Act (AMDUCA), 22
- Animax Ointment, 242
- Anipryl (selegiline), 97

- Anorexia
 anabolic steroids for, 191-192
 fluid therapy for, 306t
- ANS. See Autonomic nervous system.
- Anselol (atenolol), 140
- Antracids, 160
 magnesium in, contraindication to, 160TN
 oral, precautions in use of, 160TN
- Antagonil (yohimbine), 381
- Antagonist(s), 14, 122
 blocking action of, 15f
 definition of, 2, 115
- Antheclide EQ (oxibendazole), 253
- Anthelban (pyrantel pamoate), 261-262
- Anthocaine Injection (lidocaine), 294
- Anthracyclines, 336-337
 commonly used, 338e-339t
- Antiarrhythmics. See Arrhythmia(s), drugs for treatment of.
- Antibacterial drugs, 227
 aminoglycosides, 236-237
 cephalosporins, 232-234
 chloramphenicol, 238
 florfenicol, 238-239
 fluoroquinolones, 237-238
 lincosamides, 239-240
 macrolides, 239
 nitrofurans, 241
 penicillins, 229-232
 polymyxin B and bacitracin, 240-241
 rifampin, 241
 spectinomycin, 240
 sulfonamides, 241
 tetracyclines, 234-236
 topical
 for ophthalmic disorders, 202-203
 for otic disorders, 205-206
 for preventing and treating skin disorders, 220-221, 221TN
 vancomycin, 240
- Antibiotic agent, 227
- Antibody, 349
- Anticholinergic, definition of, 150
- Anticholinergic agents. See Cholinergic antagonists.
- Anticholinesterase agents. See Indirect-acting cholinergics.
- Anticoagulants, 329-332
 antagonists to, 332-333
- Anticollagenase agents, 204
- Anticonvulsant. See Seizure prevention, and control.
- Antidepressants, in behavioral pharmacotherapy, 96-97
- Antidiarrheal agents. See Diarrhea, drugs for.
- Antidiuretic hormone (ADH). See also Vasopressin.
 for polyuria an polydipsia in diabetes insipidus, 123
- Antidotes, 376-380
 acetylcysteine, 377-378, 378TN
 activated charcoal, 376, 376TN
 antivenins, 380
 calcium EDTA, 376-377, 377TN
 dimercaprol, 378
 ethanol, 379, 379TN
 fomepizole, 379, 379TN
 methylene blue, 377, 377TN
 penicillamine, 378-379
 sodium thiosulfate, 379
 thiamine hydrochloride, 380
 vitamin K1 (phytonadione), 380
- Antiemetic effects, of antihistamines, 110
- Antiemetics, 155-158. See also Vomiting, treatment of.
- Antifoaming drugs, 167
- Antifreeze poisoning, antidotes for, 379
- Antifungal drugs, 221, 241-243
- Antigen(s), 349, 351
- Anthelmintic(s), 252, 253
- Antihistamine Injection, 110
- Antihistamines, 110
 action of, 288, 288f
 as antiemetics, 157
 injectable, 110
- Antiinfective agents, 226-229. See also Antifungal drugs;
 Antimicrobial drugs;
 Antiseptic agents; Antiviral drugs;
 Disinfectant(s).
- Antiinflammatory drugs. See Inflammation, drugs for treatment of.
- Antilirium (physostigmine), 79
- Antimetabolites, 340, 340TN
 commonly used, 339t
- Antimicrobial drugs, 227-229
 aminoglycosides, 236-237
 cephalosporins, 232-234
 chloramphenicol, 238
 florfenicol, 238-239
 fluoroquinolones, 237-238
 lincosamides, 239-240
 macrolides, 239
 nitrofurans, 241
 penicillins, 229-232
 polymyxin B and bacitracin, 240-241
- Antimicrobial drugs (Continued)
 reference questions on, 249
 references on, 248
 rifampin, 241
 special considerations in using, 229TN
 spectinomycin, 240
 sulfonamides, 241
 tetracyclines, 234-236
 vancomycin, 240
- Antineoplastic drugs, 333-344
 alkylating agents, 336
 anthracyclines, 336-340
 antimetabolites, 340
 antitubulin agents, 340-341
 biologic response modifiers, 342-343
 categories of, 336
 combinations of, and side effects, 335-336
 effectiveness of, 335
 immunosuppressive, 344-345
 miscellaneous, 341-342
 patient education about, and chemotherapy, 336
 references on, 345
 review questions on, 346-347
- Antiparasitic drugs, 250
 client education about, 252-253
 for ectoparasites, 268-275. See also Ectoparasites, drugs for;
 Insecticides.
 for endoparasites, 253-268. See also Endoparasites, drugs for.
 references on, 275
 review questions on, 276
- Antiphlogistine Poulitice, 222
- Antiplatelet drugs, 332
- Antipruritic medications, topical, 216-217
- Antirobe preparations, 239
- Antiseborrheic medications, topical, 213-215
 suggested, for common skin disorders, 214t
- Antisedan (atipamezole), 81, 380
- Antiseptic agents, 244
 and disinfectants, difference between, 244
 for skin, 217-218
- Antiserum, 353
- Antispasmodic agents, for treatment of diarrhea, 162
- Antitoxin vaccines, 353
- Antitubulin agents, 340-341, 341TN
 commonly used, 339t

- Antitussive(s), 102, 106-108
centrally acting, 106-108, 107f
peripherally acting, 107f
therapeutic action of, 105
- Antitussive effects, of opioid agonists, 87-88
- Antitussive syrup, 105
- Antiulcer medications. *See* Gastric ulcers, drugs for treatment of.
- Antivenin (*Microtus fulvus*) coral snake, 380
- Antivenin polyvalent (*Crotalidae*), 380
- Antivert (meclizine), 157
- Antiviral drugs, 243-244
topical ophthalmic, 202
- Antizol-Vet, 379, 379TN
- Anxiety, benzodiazepine derivatives for, 82-83
- Apidra, 188
- APL (chorionic gonadotropin), 178
- Apomorphine, 88
administration of, 155TN
antidote for toxicity of, 155TN
as emetic, 154-155
- Apothecaries' weight, table of, 412t
- Apothecary/household system, 57-58
problems involving, 64
volume and weight equivalents in, 58b, 412t
- Appetite stimulants, 168
benzodiazepine derivatives as, 82-83
- Application submission, for new drug, 21
- Approval, of new drugs, 19-22
- Apraclonidine, for glaucoma, 200
- Apresoline (hydralazine), 123, 142
- AquaMEPHYTON, 333
- Aristocort (triamcinolone), 111
- Arquel Granules (meclofenamic acid), 286
- Arrhythmia(s), 130, 132, 134, 138
drugs for treatment of, 138-141
atenolol, 140
beta adrenergic antagonists, 81, 139-140
calcium channel blockers, 140-141
Class IA, 138-139
Class IB, 139
Class II, 139-140
Class III, 140
Class IV, 140-141
diltiazem, 141
lidocaine, 139
mexiletine, 139
- Arrhythmia(s) (*Continued*)
procainamide, 139
propranolol, 140
quinidine, 138
tocainide, 139
verapamil, 141
- Arsenic and heavy metal poisoning
dimercaprol for, 378
sodium thiosulfate for, 379
- Artificial tear products, 204
- Asparaginase, for chemotherapy, 339t, 341
- Aspart insulin, 188
- Aspirin, 282, 282TN
in ancillary treatment of heart failure, 145
as antiplatelet drug, 332
- Associations, veterinary, 414t
- Astramorph PF (morphine sulfate), 287
- Astringent(s), 211, 217
- Atapryl (selegiline), 97
- Atarax (hydroxyzine), 110, 289
- Atenolol, for arrhythmias, 81, 140
- Atgard (dichlorvos), 261
- Atipamezole, 81
as reversal agent for medetomidine, 81, 84, 380
- Ativan (lorazepam), 95-96
- Atonic neuropathic bladder, 125
- Atony, 115
- Atopic dermatitis
antiseborrheic agents for, 214t
corticosteroid action in, 291
selective immunosuppressants for, 223-224
- Atopica (cyclosporine), 223
- Atracurium, 95
- Atrophate (atropine sulfate), 198
- Atropine
actions of, 79TN
as antidote in cholinergic toxicity, 121TN
as antidote to organophosphate toxicity, 261TN
as bronchodilator, 109
contraindications to use of, 198
as mydriatic and cycloplegic agent, 197-198
parenteral or ophthalmic administration of, 79
separate preparations of, for large and small animals, 79TN
- Attenuation, of virulence, 351
- Aural hematoma, 205
- Aureomycin preparations, 235
- Aurimite, 207
- Autogenous vaccine, 353
- Autoimmune hemolytic anemia, corticosteroid action in, 291, 292
- Automaticity, of heart muscle, 130, 138
drugs suppressing, 138-141
- Autonomic nervous system (ANS), 70, 71-72, 71f, 75-81
control and regulation of, by hypothalamus, 74
and effects on heart rate, 132
functions of, 75
ganglia of, 75, 76f
and gastrointestinal regulation, 153-154
neurons carrying impulses to target structures in, 75, 76f
preganglionic and postganglionic fibers of, 75, 77, 77f
schematic diagram of, 76f
subdivisions of, 71f, 72, 75-78. *See also* Parasympathetic nervous system; Sympathetic nervous system.
therapeutic drugs and effects on, 78
adrenergic agents, 80
adrenergic antagonists, 80-81
cholinergic agents, 78-79
cholinergic antagonists, 79
- Avermectins, 262-263
- Avian BlueLite, 319
- Avirulent agent, 349, 351
- AVMA (American Veterinary Medical Association), 22, 372-373
- Avoidupois weight, table of, 412t
- Axid (nizatidine), 159
- Axon(s), 72, 72f
- Azapirones, for behavioral pharmacotherapy, 96
- Azathioprine, for immune-mediated disease, 167, 344
- Azidothymidine, 244
- Azithromycin, 239
- Azium (dexamethasone), 111, 292
- Azium Powder, 292
- Azodyl, 127
- Azopt (brinzolamide), 199
- Azulfidine (sulfasalazine), 167
- B**
- B fibers, 73
- Babesia infection, 264
drugs for treating, 265, 265TN
- Bacillus Calmette-Guérin (BCG), 344
- Bacitracin
antibacterial action of, 240-241
for superficial ocular infections, 203

- Bacteria, 227
 stains that differentiate, 227, 228f
- Bacterial endotoxins, effects of, on gastrointestinal system, 154
- Bacterial infections, drugs for
 aminoglycosides, 237
 cephalosporins, 234
 chloramphenicol, 238
 florfenicol, 238-239
 fluoroquinolones, 238
 lincosamides, 239
 macrolides, 239
 penicillins, 231
 polymyxin B and bacitracin, 240
 spectinomycin, 240
 tetracyclines, 235
 vancomycin, 240
- Bacterial overgrowth, gastrointestinal, antimicrobial drugs for, 166-167
- Bactericidal agents, 227-228
- Bacterin(s), 349, 351
 immunomodulatory, 366
- Bacteriostatic agents, 227-228
- Bactoderm, 221
- BAL in oil, 378
- Balling gun, 29
 use of, 37, 37f
- Banamine preparations (flunixin meglumine), 283
- Banminth 48 (pyrantel tartrate), 261-262
- Barbiturates, 84
 classification of, 84, 85t
 long-acting, 84-85
- Barbloc (pindolol), 140
- Barriers, to drug distribution (in body), 11
- Basaljel, 160
- Batch number, on drug labeling, 18
- Bath oils, for seborrhea sicca, 216
- Baymix (coumaphos), 261
- Baytril (enrofloxacin), 238
- Baytril Otic, 206, 208
- BCG (Bacillus Calmette-Guérin), 344
- Beaucoup, 247
- Beclomethasone dipropionate, 111
- Behavioral pharmacotherapy, 95-97
 antidepressants in, 96-97
 benzodiazepine derivatives in, 82-83, 95-96
- Belladonna alkaloids, 79
- Benadryl (diphenhydramine), 110, 157, 289
- Benazepril, for hypertension in renal insufficiency, 123
- Benazepril Lotensin, 123
- Bendiocarb, 273
- Benzalkonium chloride, as topical antiseptic, 218
- Benzelmin (oxfendazole), 253
- Benzimidazoles, 253, 253TN
- Benzodiazepine derivatives, 82-83, 288
 extralabel use of, for behavioral therapy, 95-96
 reversal agent for, 380-381
- Benzoyl peroxide, as antiseborrheic medication, 215, 215TN
- Benzyl alcohol, contraindications to, for cats, 314TN
- Benzyl benzoate, 275
- Beta-1 receptors, and beta-2 receptors, 75, 77, 80
 responses of, 78t
- Beta-2 adrenergic agonists, as bronchodilators, 109
- Beta adrenergic agonists, 80. *See also* Adrenergic agonists.
- Beta adrenergic antagonists, 81
 action of, on smooth muscle, 108
 for arrhythmias, 139-140
 combination of, with diuretics, 122TN
 for hypertension in renal insufficiency, 122
 for treatment of glaucoma, 199-201
- Beta adrenergic blocking agents. *See* Beta adrenergic antagonists.
- Beta blockers. *See* Beta adrenergic antagonists.
- Beta-lactamase(s), 227, 229, 231
- Betabloc (metoprolol), 140
- Betadine, 218
 as disinfectant, 246
- Betagan (levobunolol), 200
- Betamethasone dipropionate, 217
- Betapace (sotalol), 140
- Betasone, 292
- Betaxolol, 199-200
- Bethanechol, 78
 action of, and indications, 126t
 in promoting voiding of urinary bladder, 121
- Betopic (betaxolol), 200
- Beuthanasia-D (pentobarbital sodium), 97
- Bicarbonate, buffering action of, 313.
See also Sodium bicarbonate.
- Bicarbonate deficit, 315
- BJGEOL, 222
- Biguanide compounds, as disinfectants, 247
- Bimatoprost, 200
- Binder, 4t
- Binding agent(s), 10
- Bio-Sponge, 162
- Bioactive ceramic agent, 169
- Bioavailability, 8
- BioDres, 219
- Biologic response modifiers, 342-344.
See also Immunotherapeutic drugs.
- Biologics, care of, and vaccine failure, 355
- Biolyte, 319
- Biomox (amoxicillin), 231
- Biomycin (oxytetracycline), 235
- Bion Tears, 204
- Biopsy needle, 34b, 34f
- Biosol preparations, 79, 237
- Biotransformation, of drugs, 11-13
 factors influencing, 11
- Bipyridine derivatives, 137
- Bisacodyl, 164
- Bismuth subsalicylate, 162-163, 163TN
- Bladder. *See* Urinary bladder.
- Bleeding needle, 34b, 34f
- Bleeding reduction, adrenergic agents for, 80
- Bleomycin, 337
- Bloat Guard, 167
- Bloat-Pac, 167
- Bloat Treatment, 167
- Blockers. *See* Antagonist(s).
- Blood-brain barrier, permeability of, 11
- Blood glucose, insulin and effect on, 186
- Blood level, of drugs, over time, 8-9, 9f
- Blood modifying drugs, 325-333
 anticoagulants, 329-333
 fibrinolytics, 333
 hematinics, 326-329
 hemostatic agents, 332-333
 references on, 345
 review questions on, 346-347
- Blood substitutes, 328-329
- BNT, 206
- Body fluid compartments, 299-300, 300f
 drug distribution in, 10-11
 fluid movement between, 300f
 osmotic pressure and tonicity of fluids in, 301, 304
- Body fluid requirements, daily, 308f
- Body fluids
 balance of, 305
 composition of, 300-301, 301t

- Body fluids (*Continued*)
 determining status of, 305
 disorders causing imbalance of, 305
 therapeutic fluid administration for, 305-313. *See also* Fluid therapy.
- Body surface area conversion chart, 335t
- Body temperature regulation, 104
- Body water, total, 299-300
- Boldenone undecylenate, 192, 192TN
- Bolus(es), 29
 intravenous administration, with indwelling catheter, 43
 intravenous direct, procedure for, 42
 oral administration procedure, for large animals, 37, 37f
- Bonine (meclizine), 289
- Botanicals. *See* Herbs.
- Bots, 251
- Boviline (fenprostalene), 181
- Bovine somatotropin (BST), 191
- BoviShield 4 vaccine, 352
- Bradycardia, 130
 atropine resistant, isoproterenol for, 137
- Brain. *See also* Central nervous system.
 pharmacologically important areas of, 74, 74f
- Bran mash, 163
- Brethine (terbutaline), 80, 109
- Bretylol (bretylum), 140
- Brevane (methohexital), 85
- Brevibloc (esmolol), 140
- Brimonidine, 200
- Brinzolamide, 199
- Bromide, for seizure prevention, and control, 89
- Bromocriptine, for pregnancy termination in dogs, 183
- Bronchiole(s), 103-104, 103f
- Bronchoconstriction, 102, 103, 104f
 mechanisms of, 108, 108f
- Bronchodilation, 102, 103
 drugs causing, 108-110. *See also* Bronchodilator(s).
- Bronchodilator(s), 108
 in ancillary treatment of heart failure, 145
 beta-2 adrenergic agonists, 109
 cholinergic antagonists, 109
 histamines, 109
 methylxanthines, 109-110
 therapeutic action of, 105
- Bronchospasms, control of, 105. *See also* Bronchodilator(s); Corticosteroids.
- Broth dilution susceptibility test, 228, 229f
- Brucella abortus vaccine, 351
- Buffer, 299, 313
- Bulk producing agents, 163-164
- Bunamidine, 263, 263TN
- Bupivacaine, 294
- Buprenex (buprenorphine), 88, 288
- Buretrol device, 310
- Burow's solution (USP), 216
- Buscopan (butyl hyoscine), 122
- Buscopan compositum, 284, 284TN
- BuSpar (buspirone), 96
- Butazolidin preparations (phenylbutazone), 283
- Butorphanol, 87-88, 287
 as antitussive, 106
- Butoxypolypropylene glycol, 274
- Butterfly catheter, 42f
 procedure for use of, 42
- Butyl hyoscine, 126f
 in promoting urine retention, 122
- Butyrophenones, as antiemetics, 158
- C**
- C fibers, 73, 279-280
- C-Stat, 219
- Caffeine, 94
- Cair clamp, 45f
- Calan preparations, 141
- Calcium channel blockers
 for arrhythmias, 140-141
 for hypertension in renal insufficiency, 123
- Calcium Disodium Versenate, 377
- Calcium EDTA, 331, 377, 377TN
- Calcium gluconate, preparations of, 316-317
- Calcium supplements, in fluid therapy solutions, 316-317
 precautions in administration of, 317TN
- Calculation(s), 53-54
 dosage, 58-59
 percentage, 54
 proportion, 54
 ratio, 54
 references on, 63
 review questions on, 63-68
 for solution preparation, 59
 IV fluid administration, 61-62
 milliequivalents, 61
 percent concentration, 59-60
- Calculation(s) (*Continued*)
 and systems of measurement, 55-58
 unknown quantity in, 55
- CalDextro, 317
- CALF-oid Implant, 190
- Calf scour bolus, 235
- Calf scours, 318
- Callus, 211, 213
- Calves, growth hormone implants for, 190-191
- Cambendazole, 253
- Camphorated tincture of opium, 87
- Camvet (cambendazole), 253
- Cancer, 334
 chemotherapeutic drugs for, 334-344
- Canine acral lick dermatitis
 behavior modifying drugs for, 223
 systemic corticosteroids for, 220
- Canine lymphoma monoclonal antibody 231 (CL/Mab 231), 343, 365t
- Canine Melanoma Vaccine, 344
- Cantharide, as vesicant, 222-223
- Capoten (captopril), 123, 143
- Capstar (nitentpyram), 274
- Capsule(s), 28-29, 29f
 coating, with palatable substances, 37TN
 oral administration of, 36-37, 36f, 37f
- Captopril, 123, 143, 143TN
- Carafate (sucralfate), 160
- Carbam (diethylcarbamazine citrate), 268
- Carbamates, for flea and tick control, 273, 273TN
- Carbamylcholine, 78
- Carbaryl, 273, 273TN
- Carbazole (carbimazole), 185
- Carbenicillin indanyl sodium, 231t
- Carbenicillin preparations, 231
- Carbenicillin sodium, 231t
- Carbimazole, for hyperthyroidism, 185
- Carbonic anhydrase inhibitors
 as diuretics, 121, 121TN
 for glaucoma, 199
- Carboplatin, 339t, 341
- Cardiac arrest, treatment of
 adrenergic agents for, 80
 preparation of epinephrine for, 80TN
- Cardiac disease. *See* Cardiovascular system disorders.
- Cardiac glycosides, 135-136
- Cardiac output, 133
 calculation of, 133
 in heart failure, 141

- Cardioquin (quinidine polygalacturonate), 138
 Cardiovascular system
 anatomy and physiology of, 130-133
 compensatory mechanisms of, 133-135, 141
 Cardiovascular system disorders, 130, 133-135
 ancillary treatment of, 145
 dietary management of, 144-145
 drugs used in, 129-130
 for arrhythmias, 138-141
 diuretic, 143-144
 inotropic, 135-138
 references on, 145-146
 review questions on, 146-148
 for vasodilation, 141-143
 objectives in treatment of, 135
 prevalence of, 134
 stages of, and treatment, 135t
 Cardizem preparations (diltiazem), 123, 141
 Cardol (sotalol), 140
 Cardoxin (digoxin elixir), 136
 Carfentanil, 88
 Carlytene (moxisylyte), 122
 Carmilax Powder, and Bolets, 163
 Carprofen, 284-285
 Carprofen (Novox) Caplets, 285
 Carravet Wound Dressing, 219
 Carrier (vehicle), 10
 Carteolol, 200
 Carvedilol, 140
 Castor oil, 164
 Catalepsy, 70, 86
 Catecholamine(s), 70, 80, 115
 for cardiovascular disorders, 136-137
 inhibition of, by beta adrenergic antagonists, 122
 Catheter replacement, in intravenous drug administration, 40TN
 Catheter tip syringe, 32f
 Cationic detergents, as disinfectants, 245t, 247
 Cats
 acetaminophen for, contraindication to, 108TN
 hyperthyroidism in, 184
 internal parasites in, drugs for, 254t
 intramuscular or subcutaneous injection of, 41
 intravenous bolus administration to, 42, 43, 45
 intravenous fluid administration to, 44
 ketamine and morphine infusion for pain control in, 62
 Ketaset injection of, proper procedure, 46
 metabolic limitations in, 11
 oral administration of liquids to, 37, 37f, 38f
 oral administration of tablets or capsules, 36-37, 36f
 vaccinations and preventive health program for, 356, 358, 360b-361b
 Cattle
 beef, preventive health program for, 361b-362b
 dairy, preventive health program for, 363b
 intravenous administration of medication to, 45, 46f
 oral administration of bolus to, 37, 37f
 oral administration of liquid medication to, 37, 38f
 vaccines for, 358, 363-364
 xylazine dosage for, 83TN
 xylazine hydrochloride use as sedative for, 83
 Caustic Powder, 223
 Caustics, 223
 CAVM (complementary and alternative veterinary medicine), 372-373
 CCNU (lomustine), 338t
 Ceclor (cefaclor), 234
 Cefadroxil, 233t
 dosage forms of, 234
 Cefamandole, 233t
 Cefazolin, 233t
 dosage forms of, 234
 Cefepime, 234
 Cefotan (cefotetan), 234
 Cefotaxime, 234
 Cefoxitin, 233t, 234
 Cefpodoxime, 234
 Ceftazidime, dosage forms of, 234
 Ceftiofur, dosage forms of, 234
 Ceftiofur HCl, 233t
 Ceftiofur sodium, 233t
 Cell cycle, 334-335, 334f
 Cell cycle nonspecific, 326
 Cell cycle specific, 326
 Cell membrane
 drug passage through, 9
 receptors on, 13-14, 15f
 Celox granules, 332
 Center for Veterinary Medicine (CVM), 17, 371
 Central nervous system (CNS), 70-71, 74, 74f
 drugs that act on, 81-95
 barbiturates, 84-85
 for behavioral therapy, 95-97
 dissociatives, 86
 in euthanasia, 97
 inhalant anesthetics, 90-92
 miscellaneous, 92-93
 neuroleptanalgesics, 89
 neuromuscular blocking agents, 94-95
 opioid agonists, 86-88
 opioid antagonists, 88-89
 references on, 97-98
 review questions on, 99-100
 in seizure prevention and control, 89-90
 stimulants, 93-94
 tranquilizers and sedatives, 82-84
 pain sensation in, 279-281, 280f
 pharmacologically important areas of, 74, 74f
 synapses within, 73
 Central sensitization, 280
 Centrine (aminopentamide), 79, 157, 162
 Cephalexin, 233t
 dosage forms of, 234
 Cephalosporins, 232-234, 233TN, 234TN
 preparations of, 234
 including indications and antagonists, 233t
 Cephalothin, 233t, 234
 Cephapirin, 233t
 Cephadrine, 234
 Cephulac (lactulose), 163
 Ceptaz (ceftazidime), 234
 Cerebrum, 74
 Cerenia (maropitant citrate), s158
 Cerulytic, 208
 Cerumen, 28
 Cerumene, 208
 Cerumite, 207
 Cestex (epsiprantel), 263
 Cestodes, 251
 drugs effective against, 263
 topical solutions for, 264
 C.E.T. oral hygiene and preventive products, 168-169
 Chelating agent(s), 370, 376-377, 377TN
 Chemical name, of drug, 17
 Chemoreceptor trigger zone (CRTZ), 150, 154

- Chemotherapeutic drugs, 334-344
 administration of, and precautions, 337b
 alkylating agents, 336
 anthracyclines, 336-340
 antimetabolites, 340
 antitubulin agents, 340-341
 biologic response modifiers, 342-343
 categories of, 336
 combinations of, and side effects, 335-336
 commonly used, 338t-340t
 effectiveness of, 335
 immunosuppressive, 344-345
 miscellaneous, 341-342
 patient education about, and chemotherapy, 336
- Cheque Drops (mibolerone), 179
- Chick Ark Bronc vaccine, 351
- Chlor-Trimeton (chlorpheniramine maleate), 289
- Chlora-Otic, 206
- Chloral hydrate/magnesium sulfate, 93
- Chlorambucil, 338t
- Chloramphenicol, 238, 238TN
 contraindication to use of, 206
 dosage forms of, 238
 prohibited use of, as extralabel drug, 22
 in topical ophthalmic preparations, 203
 in topical otic preparations, 206
- Chlorasone, 203
- ChlorhexiDerm Maximum Shampoo, 218
- Chlorhexidine
 as disinfectant, 245t, 247
 as topical antiseptic, 217-218
- Chlorhexidine surgical solution,
 diluted, for flushing ear canal, 208
- Chlorinated hydrocarbons, for flea and tick control, 273, 273TN
- Chlorine, as disinfectant, 245t, 246, 246TN
- Chlorothiazide, 120, 144
- Chlorpheniramine maleate, 289
- Chlorpromazine, 82, 156TN
 as antiemetic, 156, 156TN
- Chlorpropamide, for polyuria and polydipsia in mild diabetes insipidus, 123TN
- Chlorpyrifos, 273
- Chlortetracycline, 235t
 dosage forms of, 235
- Cholecystokinin, 153-154
- Cholelyl SA (theophylline), 109
- Cholinergic, definition of, 70, 150
- Cholinergic agents (agonists), 78-79, 121
 adverse effects of, 79, 121TN
 direct-acting, 78, 165-166
 as gastrointestinal prokinetics, 165-166
 indirect-acting, 78-79
 in promoting urination, 121
- Cholinergic antagonists, 79
 as antiemetics, 157
 as bronchodilators, 109
 for promoting urine retention, 121-122
 for treatment of diarrhea, 162
- Cholinergic blockers. *See* Cholinergic antagonists.
- Cholinergic nervous system. *See* Parasympathetic (cholinergic) nervous system.
- Cholinergic receptor(s), responses of, 77, 78
- Cholinergic toxicity, signs of, and antidote, 121TN
- Chondroitin sulfate, 372
- Chondroprotectives, 370
- Chorionic gonadotropin, 177-178
- Chorulon (chorionic gonadotropin), 177
- Chronotropic effects, on heart rate, 130, 132
- CHX Guard, 168
- Ciliary spasm, cholinergic blocking agents for, 79
- Cimetidine, 158-159, 159TN, 289
- Ciprofloxacin, 238
 in topical ophthalmic preparations, 203
- Cisapride, 165
- Cisplatin, 339t, 341, 341TN
- Citrate phosphate dextrose adenine (CPDA-1), 331-332
- CL/Mab 231 (canine lymphoma monoclonal antibody 231), 343
- Claforan (cefotaxime), 234
- Clamps, for controlling IV fluid flow, 310, 311f
- Clear, Ear Cleansing Solution and Drying Solution, 207, 218
- Clemastine, 110
- Clenbuterol
 as bronchodilator, 109
 prohibited use of, as extralabel drug, 22
 veterinary approval, for horses, 109
- Clidinium, and chlordiazepoxide, 162
- Client education
 about antiparasitic medications and administration, 253-254
 about chemotherapeutic drugs and chemotherapy, 336
 about drugs and drug administration, 50
 in ear cleaning and otic medication administration, 205
 about nonsteroidal antiinflammatory drugs, 282
 in nutrition and predisposition to bladder stone development (in some dog breeds), 116
 about parasites, 251, 251TN
 about skin care and medications for skin conditions, 211
 about sodium restriction in cardiovascular disease, 145TN
 about stool sample collection, 253TN
 about tick removal, 207TN
 in urinary and renal conditions, 127
 about vaccination, 349-350, 355
- Clindamycin, 239-240
- Clinical trials, of new drugs, 21
- Clomicalm (clomipramine), 96
- Clomipramine, 96
- Clopidol, 264
- Cloprostenol sodium, 182
- Clorazepate, for seizure prevention, and control, 89
- Clorox bleach, as disinfectant, 246
- Closulan, 263-264, 264TN
- Closed-angle glaucoma, 196
 contraindication to epinephrine in, 198
- Clostratox BCD vaccine, 353
- Clostridium difficile* infection,
 vancomycin for, 240
- Clotisol, 332
- Clotrimazole cream, 221
- Clotting factors, 331t
- Clotting pathway, blood, 329, 330f
- Cloxacillin, 230t
 dosage forms of, 231
- Clozapen, 231
- CNS. *See* Central nervous system.
- Coal tar, in antiseborrheic agents, 215, 215TN
- Coating(s), 4t, 10
- Coban 60 (monesin), 264
- Coccidia, 264
 drugs effective against, 264, 264TN
- Codan syrup, 106

- Code (laboratory) name, of drug, 17
- Codeine, 88, 287
 as antitussive, 107
 controlled substance classification of, and codeine combinations, 107TN
 preparations of, 107
- Coenzyme Q, 372
- Colase (docusate sodium), 164
- Collagen, 211
- Collagen formation, in wound healing, 218-219
- Collagen shields, 202
 application of, anesthesia and sedation, 202TN
- Collamend, 219
- Colloid, 299
- Colloid solutions, in fluid therapy, 314-315, 315TN
- Colloidal oatmeal, as antipruritic, 216
- Coloring agent(s), 4t
- Combination, drug, 10
 with undesired consequences, 16, 16t
- Combot (trichlorfon), 261
- Comedo (comedones), 211
- Comfort Tear, 204
- Comfortis (spinosad), 272
- Compartments. *See* Body fluid compartments.
- Compazine (prochlorperazine), 82, 156
- Compendial name, of drug, 17
- Complementary and alternative veterinary medicine (CAVM), 372-373
- Compliance policy guidelines (CPGs), 22
 for compounding drugs, 23
- Compounding drugs, 2, 22-23
 and compounding pharmacies, information resources, 414t
- Comprehensive Drug Abuse Prevention and Control Act (1970), 17-18, 22t
- Compudose (estradiol implant), 190
- Concentration gradient, 10
- Concentration of solute, in solution, 59, 301
 for IV fluid administration (including calculations), 61-62
 milliequivalent expression of, 61, 301
 most commonly used expression of, 59
 percent, and calculation examples, 59-60
 ways of expressing, 59
- Congestive heart failure, 134-135
 adrenergic agents for, 80
 fluid therapy for, 306t
- Conjugation, 11
- Conjunctivitis, 196, 292
- Conofite preparations (miconazole), 221, 243
- Consil Dental, 169
- Constant rate infusion (CRI), 288
 calculation examples for, 61-62
- Constipation, drugs for, 163-164
- Constulose (lactulose), 163
- ConsumerLab, web site of, 372, 373
- Contraindication, to use of drug, 2
- Controlled substances, 5, 17-18, 49-50
 code for identification of, 49
 disposal of, 420
 information summary, 417-420
 inventory log of, 49, 50f, 391, 391TN
 laws and regulations identifying, 418
 opioid agonists as, 87-88
 oxybarbiturates as, 84-85
 record keeping requirements for, 419-420
 registration with DEA for handling, 418-419
 schedules of, 418
 secure handling procedures for, 419
 valid prescription requirement for, 420
- Conversion of units
 within metric system, 55-57, 56f
 between metric system and apothecary/household system, 58b, 64
- Copper poisoning, treatment of
 penicillamine for, 378-379
 sodium thiosulfate for, 379
- Copper sulfate, as caustic, 223
- Condarone (amiodarone), 140
- Corid (amprolium), 264
- Corrective Mixture (bismuth subsalicylate), 162
- Cort/Astrin Solution, 292
- Cortaba, 282
- Corticosteroids, 289-292
 adverse effects of, 292-293
 antiinflammatory action of, 291-292, 345
 basic molecular configuration of, 291f
 classification of, 289-290, 290t
 clinical uses of, 291, 292
- Corticosteroids (*Continued*)
 allergic respiratory conditions, 110-111
 for chemotherapy, 339t
 dermatosis and dermatitis, 220, 220TN
 hyperglycemic agents, 189-190
 immunosuppression, 345
 induction of parturition or abortion, 183
 ophthalmic inflammation, 203, 203TN
 principles of appropriate, 293
 skin inflammation and pruritis, 217
 dosage forms of, 292
 duration of action of, 290t
 natural, 290, 291f
 physiology of, 290-291, 291f
- Corticotropin releasing factor (CRF), 290, 291f
- Cortisate-20, 292
- CortiSpray, 292
- Cosopt (timolol maleate), 199
- Cough suppression, 105. *See also* Antitussive(s).
- Cough syrup, 105
- Cough tablets, 105
- Coumaphos, 261
- Coumarin derivatives, 331
 antidote to, 331TN
- Counterirritant(s), 28, 222-223
 topical administration of, 35
- COX (cyclooxygenase), 281
- Coyden 25 (clopidol), 264
- CPGs. *See* Compliance policy guidelines.
- Cream(s), 28
 application of, 47-48
- CRE. *See* Corticotropin releasing factor.
- CRTZ (chemoreceptor trigger zone), 150, 154
- Crystalloid solutions, for fluid therapy, 313-314
- Culturelle, 168
- Cuprimine Capsules, 378
- Cuprimyxin cream, 221
- Cunare (d-tubocurarine), 94
- Cunatrem (clorsulan), 263-264
- Cushing disease, 278
 caused by corticosteroid treatment, 292
- CVM (Center for Veterinary Medicine), 17, 371
- Cya-dote Injection, 379

- Cyanide poisoning, sodium thiosulfate for, 379, 379TN
- Cyanocobalamin (vitamin B12), 320-321
- Cyclic AMP, 109
- Cyclogyl (cyclopentolate hydrochloride), 198
- Cyclohexylamines, 86
- Cyclooxygenase (COX), 281
- Cyclopentolate hydrochloride, 198
- Cyclophosphamide, 336TN, 338t, 345
- Cycloplegia, 196
- Cycloplegic agents, 197-198
- Cyclosporin A. *See* Cyclosporine.
- Cyclosporine, 204
 - for atopic dermatitis, 223-224
 - for keratoconjunctivitis sicca, 204, 344, 344TN
- Cyrcin tablets (medroxyprogesterone acetate), 180
- Cydectin Pour-On (moxidectin), 262
- Cygro Type A Medicated Article, 264
- Cyproheptadine, 110
 - as appetite stimulant, 168
- Cystorelin (gonadorelin), 177
- Cythioate, 273
- Cytobin tablets (liothyronine sodium), 185
- Cytochrome P-450 enzyme, 16
- Cytomel (liothyronine sodium), 185
- Cytosine arabinoside, 339t, 340
- Cytotec (misoprostol), 161
- Cytotoxic, 326
- Cytosan (cyclophosphamide), 345
- D**
- D-128, 247
- D5W (dextrose in water), 313-314
- Dacabazine, 338t
- Dactinomycin, 337, 338t
- Daily fluid requirements, 308f
- Dairy Dewormer BX Crumbles (coumaphos), 261
- Dakin's solution, 219
- Danocrine (Danazol), 178
- Dantrolene (Dantrium), action of, and indications, 126t
- D.A.P (dog appeasing hormone), 184
- Daramide (dichlorphenamide), 121, 199
- Darbazine (prochlorperazine/isopropamide), 82, 156
- Dasuquin, 372
- Datril (acetaminophen), 284
- DEA (Drug Enforcement Agency), 49, 414t, 415t
 - drug classification schedules of, 17-18, 418
- DEA (Drug Enforcement Agency) (Continued)
 - forms required by, 386, 391, 392f, 404, 404TN
 - information found at web site of, 418
 - registration with, for handling controlled substances, 418-419
 - rules of, for handling controlled substances, 49-50
- DEA number, veterinarian, 404TN
- Deca-Durabolin (nandrolone decanoate), 192, 328
- Decamethonium, 94
- Decox (decoquinat), 264
- Decongestant(s), 102, 110
- Dectomax preparations (doramectin), 262-263
- Deep pain, 278
- Defend ExSpot Insecticide for Dogs, 272, 272TN, 273
- Dehorning Paste, 223
- Dehydration, 306t
 - clinical signs of, 307t
 - fluid therapy for, 306t. *See also* Fluid therapy.
 - percentage of, calculating, 305, 307
- Delta Albaplex (prednisolone), 111
- Delta-Cortef (prednisolone sodium succinate), 111
- Delta opiate receptors, 87
- Dembrexine, 106
- Demecarium bromide, 79, 199
- Demerol (meperidine), 87, 287
- Dendrite(s), 72, 72f
- Dencosyl, 372
- Dentifrice, 150
 - and oral cleansing products, 168
- Depen Titratabs, 378
- Depo-Medrol, 220, 292
- Depo-Provera (medroxyprogesterone acetate), 97, 180
- Depo-Testosterone, 178
- Depolarization, of cardiac muscle cell, 130, 132, 132f
- Depolarizing neuromuscular blocking agents, 94
- Depot, 10
- Depressant drugs, uses of, 81
- Deramaxx (deracoxib), 285
- DermaCide, 218
- DermaCool-HC, 217
- Dermal Dry, 207
- Dermal Wound Gel, 220
- Dermalone Ointment, 242
- Dermathycin (thyrotropin), 185
- Dermatitis, 211. *See also* Allergic dermatitis.
- Dermatologic conditions. *See* Skin disorders.
- Dermatophyte test, 242, 242f
- Dermatophytosis, 227
- Dermis, 212, 212f
- DES. *See* Diethylstilbestrol.
- Desflurane, physical properties of, 91t
- Detemir insulin, 189
- Detergent, 227
- Detomidine hydrochloride, 83, 83TN
- Detrusor areflexia, 115, 122
- Detrusor muscle, 115
 - abnormal function of, in atonic neuropathic bladder, 125
 - normal function of, in spastic neuropathic bladder, 125
- Development, of new drugs, 19-22
 - agencies overseeing, 19-20, 20f, 371
 - federal laws regulating, 21-23, 22t
 - steps in, 21
- Dex-A-Vet Injection, 292
- Dexamethasone, for allergic respiratory conditions, 111
- Dexamethasone Injection, for allergic dermatologic conditions, 220
- Dexamethasone Sodium Phosphate, 292
- Dexasone (dexamethasone), 111, 292
- Dexatrim (phenylpropanolamine), 80
- Dexpanthenol, 166, 166TN
- Dextran 70 solution, 314
- Dextromethorphan, 108
- Dextrose-electrolyte solution
 - compositions, 302t-303t
- Dextrose (2.5%) in half-strength (0.45%) saline/potassium solution, 314
- Dextrose (5%) in water, 313-314
- Dextrose (50%) solution, as supplement in fluid therapy, 317-318
 - calculations for, 317-318
 - concentration of dextrose in, 318TN
- DI-Tri-Octahedral Smectite, 162
- Diabetes mellitus, 186
 - fluid therapy for, 306t
 - type I, and drugs for treatment, 186-189
 - type II, and drugs for treatment, 186, 189
- Diabetic ketoacidosis, 186
- Diabinese. *See* Chlorpropamide.
- Diagnostic method, of drug choice, 3
- Diamox (acetazolamide), 121, 199

- Diarrhea, 161
 drugs for, 161-163
 cholinergic antagonists, 79, 162
 opioid agonists, 87, 88, 161-162
 protectants and adsorbents, 162-163
 fluid therapy for, 306t
- Diazepam, 82-83
 action of, and indications, 126t
 as appetite stimulant, 168
 for behavior modification in self-licking, 223
 in behavioral pharmacotherapy, 95-96
 as injectable anesthetic, 82
 metabolism of, 83TN
 for seizure prevention, and control, 89
 storage precautions for, 83TN
- Diazide (triamterene), 121
- Diazinon, 273
- Diazoxide, 189-190
- Dibenzylamine (phenoxybenzamine), 81, 122
- Dibucaine, 295
- DIC. See Disseminated intravascular coagulation.
- Dichlorphenamide, 121
 for treatment of glaucoma, 199
- Dichlorvos, 261, 273
- Diclazuril (Clinox), 264
- Diclofenac sodium, 203
- Dicrual (difloxacin), 238
- Dicumarol, 331
- Didoxacillin, and floxacillin, 230t
- Diestrus, 176
- Dietary management, in cardiovascular disorders, 144-145
- Dietary Supplement Health and Education Act (1994), 371
- Diethylcarbamazine citrate, 268, 268TN
- Diethylstilbestrol (DES), 178
 action of, and indications, 126t
 prohibited use of, as extralabel drug, 22
- Diffusion, of solutes, 301
- Difloxacin, 238
- Digestive enzyme(s), 166
- Digestive system. See Gastrointestinal system.
- Digitalis, 135-136
 effects of, on sodium-potassium-ATPase pump, 136f
- Digoxin, 136
 bioavailability of, 136TN
 client education about, 136TN
- Digoxin elixir, 136
- Dihydrotychsterol, 124
- Dilacor XR (diltiazem), 141
- Dilantin (phenytoin sodium), 89
- Dilatrend (carvedilol), 140
- Diltiazem
 for arrhythmias, 141
 for hypertension in renal insufficiency, 123
- Dimenhydrinate, as antiemetic in motion sickness, 157, 289
- Dimercaprol, for arsenic and heavy metal poisoning, 378
- Dimetapp DM, 108
- Dimethylsulfoxide (DMSO), 283-284
- Dimetridazole, prohibited use of, as extralabel drug, 22
- Dinoprost tromethamine, 181, 181TN
- Diocetyl sodium sulfo-succinate, 164
- Dipentum (olsalazine), 167
- Diphenhydramine, 110, 289
 as antiemetic in motion sickness, 157
- Diphenoxylate, for diarrhea, 88, 162
- Dipivalyl epinephrine, 198
- Diprenorphine, as antagonist to etorphine, 88
- Diprivan (propofol), 93
- Diprolene (betamethasone dipropionate), 217
- Diprosone (betamethasone dipropionate), 217
- Direct-acting hormones, 175
- Dirlotapide, 167-168
- Disal (furosemide), 120
- Disclosing solution, 169
- Disease processes, and drug distribution, 11
- Disinfectant(s), 227, 244, 244f
 and antiseptic, difference between, 244
 preparations of, and activity, 245t
- Disintegrant(s), 4t
- Disk susceptibility test, 228, 228f
- Dispensing drugs, versus prescribing drugs, 23
- Disposable Enema, 164
- Disseminated intravascular coagulation (DIC), 326, 329
 treatment of, 329-330
- Dissociation, of ions, 299, 301
- Dissociative agents, 86
- Distribution process (in body), drug, 10-11
 equilibrium of, 10, 10f
- Diuretics, 120-121
 use of, in heart failure, 143-144
- Diuride (furosemide), 120
- Diuril (chlorothiazide), 120, 144
- DMSO (dimethylsulfoxide), 283-284
- Dobutamine (Dobutrex), 80
 for inotropic effect on heart, 137
- Docusate Calcium, 164
- Docusate Sodium, 164
- Dog appeasing hormone (D.A.P.), 184
- Dogs
 ear cleaning process in, proper, 204-205
 hypothyroidism in, 184
 internal parasites in, drugs for specific, 254t
 intramuscular or subcutaneous injection of, 41
 intravenous bolus administration to, 42, 43, 45
 intravenous fluid administration to, 44
 ketamine and morphine infusion for pain control in, 62
 medetomidine use in, age restrictions, 84
 oral administration of liquids to, 37-38, 37f, 38f
 oral administration of tablets or capsules, 36-37, 36f, 37f
 predisposition to bladder stones, in some breeds, 116
 vaccinations and preventive health program for, 356, 357b-358b
 xylazine use in, precautions for, 83TN
- Dolophine (methadone), 88
- Domeboro powder, and tablets, 216
- Domitor (medetomidine), 84
 reversal agent for, 380
- Domperidone, as gastrointestinal prokinetic, 165
- Donnagel, 162
- Donnatal, 162
- Dopamine, 75, 77, 80
 for adjunctive use in heart failure, 137
 and behavioral pharmacotherapy, 95
 for hypertension in renal insufficiency, 123
- Dopamine hydrochloride, 137
- Dopaminergic antagonists, as gastrointestinal prokinetics, 165
- Dopaminergic receptors, 75
 responses of, 78t
- Dopram preparations (doxapram), 94
- Doramectin, 262-263

- Dormosedan (detomidine), 83
 Dorzolamide, 199
 Dosage, and patient response, 5-6, 6f
 Dosage calculations, 58-59
 units most commonly used in, 55
 Dosage form(s), 28-35
 bolus, 29
 implants, 35
 liquid preparations, 29
 microencapsulation, 35
 oral, 29
 parenteral, 29-35
 preservatives and solvents in, 35
 tablets and capsules, 28-29
 topical, 28-35
 Dose. *See also dosage entries.*
 definition of, 58
 Dose-response curve, 14
 DoseCalcu Online, 415t
 Downer cow syndrome, 288
 Doxapram, 94, 94TN, 111
 Doxirobe, 169
 Doxorubicin, 337, 338t, 340TN
 Doxy caps (doxycycline), 235
 Doxycycline, 235t
 dosage forms of, 235
 as perioecutic agent, 169
 Doxylamine, 110
 Dramamine (dimenhydrinate), 157
 Draxxin (tulathromycin), 239
 Drip rate, of fluid therapy,
 calculating, 309
 Droncit (praziquantel), 264
 Drontal Plus, 263
 Droperidol, 81
 and fentanyl, 89, 158
 Drops, application of, 47-48
 Drug(s), 2
 absorption of. *See Absorption.*
 administration of, 2, 5-8. *See also*
Drug administration.
 affinity of, to cell membrane
 receptor, 13-14, 15f
 combination of, 10
 with undesired consequences,
 16, 16t
 compounding, 22-23
 development and approval of new,
 19-22
 dispensing versus prescribing, 23
 distribution of, in body. *See*
Distribution process.
 efficacy of, 14
 extralabel use of, 4
 federal laws related to new drugs
 and drug use, 21-23
 Drug(s) (Continued)
 formulation of, 10. *See also Dosage*
form(s).
 half-life of, 13, 14f
 information resources about,
 414t-416t
 interaction among, 15-16,
 16TN, 16t. *See also Drug*
interaction(s).
 label of, information found on,
 17-19, 18f-19f
 marketing of, 23-24
 multiple effects of, 14
 names of, 16-17
 new, development and approval of,
 19-22
 object, 16, 16t
 over-the-counter, 4-5
 pharmacodynamics of, 13-15
 pharmacokinetics of, 5-13. *See also*
Pharmacokinetics.
 potency of, 14
 precipitant, 16, 16t
 prescription, 3-4
 routes of administration of, 6-8
 solubility of, 9-10
 sources of, 3
 storage of, appropriate, 50TN
 Drug administration, 2, 5-8, 27-52
 avoiding drug mixtures in, 16TN
 client education about, 50
 controlled substances in, 49-50
 documentation of, in medical
 record, 48, 48f
 dosage forms in, 28-35. *See also*
Dosage form(s).
 five Rights of, 35-36
 medication orders for, 48
 microencapsulation of drugs for, 35
 procedures and techniques of,
 35-47
 oral medications, 36-38
 parenteral medications, 38-47
 reconstitution of medication in, 29,
 31f, 35TN
 references on, 50
 review questions on, 51-52
 routes of, 6-8
 oral, 7, 28-29, 36-38. *See also*
Oral medications.
 parenteral, 2, 7-8, 28, 29, 38-40,
 46-47. *See also Parenteral*
medications.
 topical, 8, 35, 47-48. *See also*
Topical medications.
 transdermal, 278
 Drug Enforcement Agency (DEA).
See DEA (Drug Enforcement
Agency).
 Drug interaction(s), 15-16, 16TN, 16t
 Dry Eye Therapy, 204
 Drying agents, otic, 207
 ear cleaning before administration
 of, 207TN
 Dulcolax (bisacodyl), 164
 Duo 128 Disclosing Solution, 169
 Duocide Spray, 273
 Durabolin, 124
 Duragesic (fentanyl transdermal), 287
 Durakyl Pet Spray and Shampoo
 (resmethrin), 273
 Duramorph (morphine sulfate), 87
 Duramune Cv-K vaccine, 351
 Duramycin powder (tetracycline), 235
 Dusts, for flea and tick control, 270
 Dynapen (dicloxacillin), 231
 Dyrenium (triamterene), 121
 Dyrex T.E (trichlorfon), 261
 Dysrhythmia. *See Arrhythmia.*
 Dystocia, 173
 oxytocin use in, 182, 182TN
E
 Ear
 anatomy of, 205, 205f
 correct cleaning of, 204-205
 topical medications for, 205-208
 Ear canal, flushing procedure for, 208
 Ear mite infestation, 204-205. *See also*
Ectoparasites.
 preparations for, 206-207
 selamectin preparations for, 266t,
 268, 268TN, 269t
 Ear Miticide, 207
 Ear ticks, preparations for, 207. *See*
also Ticks.
 Eccentric tip syringe, 32f
 Eclipse 3 vaccine, 352
 Ectokyl IGR preparations
 (tetramethrin), 273
 Ectoparasites, 251, 252, 268. *See also*
Fleas; Ticks.
 drugs for, 268-272, 269t
 on cattle/sheep/goats, 260t
 on dogs and cats, 259t
 on horses, 259t
 on swine, 261t
 insecticides for, 272-275
 references on, 275
 Ectopic focus, 138
 Ectopic ureter, 125
 Ectopion, 196
 ED₅₀, 14

- Edecrin (ethacrynic acid), 120
- Edetate disodium ophthalmic, 204
- Edrophonium, 78
 - as antagonist to nondepolarizing neuromuscular blocking agents, 94
- EDTA (ethylenediaminetetraacetic acid), 331
- Education. *See* Client education; Veterinary technician.
- Effective osmoles, 301
- Effector organs, 70, 73
 - receptors in, 77, 77f
 - of sympathetic and parasympathetic nervous systems, 75, 77f
- Efficacy, drug, 2, 14
- Elavil (amitriptyline), 96, 125
 - for pain relief, 288
- Eldepryl (selegiline), 97
- Electrical impulse transmission, through neuron, 72-73, 72f
- Electrolyte(s), 299
 - in body fluid, 300-301, 300t
 - in therapeutic solutions, 61. *See also* Fluid therapy.
- Electrolyte imbalance, evaluation of, 300-301. *See also* Fluid and electrolyte disorders.
- Elixir(s), 28, 29
- Elmiron (pentosan polysulfate sodium), 126
- Elpak-G Electrolyte Gel, 319
- Elspar (asparaginase), 341
- Emesis, 150
- Emetics, 154-155. *See also* Vomiting, induction of.
 - centrally acting, 154-155
 - locally acting, 155-156
- Emodepside/praziquantel, 264
- Emodin, 164
- Empirical determinations, 299, 309
- Empirical estimation, of supplemental additives, 316
- Empirical method, of drug choice, 3
- Empirin with codeine, 107
- Emulsifier(s), 4t
- Emulsion(s), 28, 29
- Enacard (enalapril), 123, 143
- Enalapril, 123, 143, 143TN
- Endocrine disorders, 172-173
- Endocrine system, 173. *See also* Hormones.
 - anatomy and physiology of, 173-177
 - hormone regulation in, 175-177
 - pituitary gland in, 173-174
- Endocrine system (Continued)
 - feedback mechanisms in, 175-177, 175f
 - and nervous system, interaction of, 173-174, 174f
- Endogenous hormones, 173
- Endometrium, 173
- Endoparasites, 251, 252, 253. *See also* Cestodes; Heartworm disease; Nematodes; Protozoal infections; Trematodes.
 - drugs for, 253-268
 - in cattle/sheep/goats, 256t
 - in dogs and cats, 254t
 - in horses, 255t
 - in reptiles, 258t
 - in swine, 257t
 - topical, 264
 - references on, 275
- Endorphins, 279
- Endothelial layer, 326
 - injury to, and clotting mechanism, 329
- Endotoxic shock, fluid therapy for, 306t
- Endotracheal intubation,
 - neuromuscular blocking agents for, 94-95
- Endotracheal tube, with cuff, 47f
- Enemas. *See* Laxatives.
- Enkephalins, 279
- Enrofloxacin, 238
 - in topical otic anti-infectives, 206
- Enteric nervous system, 153
- Entrolyte, 319
- Entropion, 196
- Enulose (lactulose), 163
- Enuresis, 115
- Environmental Protection Agency (EPA), U.S., regulation of animal health products, 19-20, 20f
- Epakitin, 126
- Ephedrine, 80, 110
- Epi-Otic ear cleanser, 208
- Epi-Soothe Bath Treatment, 216
- Epi-Soothe Shampoo, 216
- Epidermis, 212, 212f
- Epidural administration, of drug, 7, 8
- Epidural anesthesia, 293
- Epidural Injection (procaine HCl), 294
- Epifirin (epinephrine), 198
- Epinal (epinephrine), 198
- Epinephrine, 77, 80
 - after cardiac arrest, 136-137
 - as bronchodilator, 109
 - as hyperglycemic agent, 189-190
 - as mydriatic agent, 198
- Epinephrine (Continued)
 - preparation notes for, 137TN
 - storage notes for, 137TN
- Epoetin alpha, 124, 328
- Épogen (erythropoietin), 328
- Epsiprantel, 263, 263TN
- Epsom Salts (magnesium sulfate), 163, 216
- Eqstim, 366
- Equ-Lin, 222
- Equi-Phar Pheylbutazone Gel/Tablets, 283
- Equi-Phar Proud Blue Liquid, 223
- Equi-Phar Sweet Psyllium, 163
- Equibot TC (trichlorfon), 261
- Equidone (domperidone), 165
- Equimate (fluprostenol), 181
- Equine Bluelite, 319
- Equine Laxative, 163
- Equine Psyllium, 163
- Equine Thyroid Supplement (levothyroxine sodium), 184
- Equipalazone (phenylbutazone), 283
- Equipoise (boldenone undecylenate), 192, 328
- Equiproxen (naproxen), 285
- Equivalent weight, definition of, 54
- Equizole (thiabendazole), 253
- Equalan (ivermectin), 262
- Ergonovine maleate, 183
- Erysipelothrix rhusiopathiae antiserum, 353
- Erythema, 211
- Erythro (erythromycin), 165, 239
- Erythromycin, as gastrointestinal prokinetic, 165
- Erythropoiesis, 115, 118-119
- Erythropoietin, 326
 - administration of, in renal failure, 124
 - clinical uses, dosage forms and adverse effects of, 328
 - stimulation of bone marrow by, 326, 327f
- Escherichia-Colicin-B antiserum, 353
- Escort, 273
- Escort Plus, 273
- Eserine (physostigmine), 79
- Esmolol, for arrhythmias, 140
- Esophageal feeder, 318, 319f
- Esophagitis, treatment of, 160
- Estradiol cypionate, 178
- Estradiol implants, 190-191
- Estrogen(s), 178
 - and anemia, association of, 178TN
 - contraindication to, in pregnancy, 178TN

- Estrogen(s) (*Continued*)
 in promoting weight gain in ruminants, 190-191
 synthetic, 178TN
- Estrumate (cloprostenol sodium), 182
- Estrus, 176
- Estrus cycle, 176, 176f
- Ethacrynic acid, 120
- Ethanol, as antidote to antifreeze poisoning, 379, 379TN
- Ethyl alcohol, 244-245
 70%, 217
- Ethylene oxide, as disinfectant, 245-246, 246TN
- Ethylenediaminetetraacetic acid (EDTA), 331
- EtoGesic (etodolac), 285
- Etorphine, 88
- Euthanasia-6 (pentobarbital), 97
- Euthanasia agents, 97
 barbiturates as, 84-85
- Euthasol-C III, 97
- Euthyroid, 173, 184
- Excenel (ceftiofur), 234
- Exogenous hormones, 173
- Expectorant(s), 102, 105
 therapeutic action of, 104-105
- Expiration date, on drug label, 18
- Expired air, excretion of metabolites in, 13
- Extracellular fluid (ECF), 299-300, 300f
- Extralabel use, of drugs, 2, 4
 guideline legislation for, 22
 prohibited, 22
- Exudation, 211
- Eye, external structures of, 197f
- Eye disorders. *See* Ophthalmic disorders.
- Eye examination, agents facilitating, 197-198
- Eye medications. *See* Ophthalmic preparations.
- Eyeball, internal structure of, 197f
- F**
- Factrel (gonadorelin), 177
- Famotidine, for gastric ulcers, 159
- FARAD (Food Animal Residue Avoidance Databank), 20-21
- Fat-soluble vitamins, 321
- Fatal-Plus (pentobarbital sodium), 97
- Fatty acid supplements, 221, 222
- Fatty acids, 372
- FDA. *See* Food and Drug Administration.
- Febantel, 262
- Fecal centrifugation techniques, diagnostic, 252
- Feces, excretion of metabolites in, 13, 13f
- Federal laws, regulating animal health drugs, 21-23, 22t
- Feed efficiency, 173, 190
- Feedback, 173
- Feedback mechanisms, of hormonal control, 175-177, 175f
- Felaxin (petrolatum), 164
- Felbamate, for seizure prevention, and control, 89
- Feline herpes virus infection, antiviral agents for, 244
- Feline psychogenic alopecia, behavior modifying drugs for, 223
- Feliway, 183
- Fenbendazole, 253
- Fenoxycarb, 274
- Fenpropalene, 181, 181TN
- Fentanyl, 88, 287
 and droperidol (Innovar-Vet)
 as antiemetic, 158
 as neuroleptanalgesic, 89
- Fentanyl transdermal patches, for chronic pain, 88, 287
 application of, and precautions, 287
- Fenthion, 273
- Fermycin, 235
- Fertagyl (gonadorelin), 177
- Fibrinolysis, 326
- Fibrinolytic drugs, 333
- Fick speculum, oral liquid administration with, 37, 38f
- Filaribits (diethylcarbamazine citrate), 268
- Filgrastim, 343-344
- Fillers/diluents, 4t
- Finadyne (flunixin meglumine), 283
- Finaplix H (trenbolone implant), 190
- Finaplix S (trenbolone implant), 190
- Fipronil, 269t, 271, 271TN
- Fipronil methoprene, 269t
- Firocoxib, 286
- Flagyl (metronidazole), 167, 264, 345
- Flavor agents, 4t
- Flaxedil (gallamine), 94
- Flea dips, 270, 270TN
- Fleas, 268
 environmental control products for, 270-271
 insecticides effective against, 272-275
 monthly application products for, 271-272
- Fleas (Continued)*
 prediluted sprays for, 268, 270, 270TN
 products for, and comparisons, 269t
- Fleet Enema, 163
- Florfenicol, 238-239
 contraindications to use of, 239TN
 intramuscular injection of, 239TN
- FloVent (fluticasone propionate), 111
- Flow agents, 4t
- Flucort Solution, 292
- Flucytosine, 243
- Fluid and electrolyte disorders, 306t
 clinical evaluation of, 305, 307, 307t
 fluid therapy for, 306t. *See also* Fluid therapy.
- Fluid compartments. *See* Body fluid compartments.
- Fluid requirements, daily, 308f
- Fluid therapy, 304-312. *See also* Solute(s); Solution(s).
 administration of, 305-312
 determining fluid amount, 305, 307
 equipment preparation, 311-312
 intravenous (IV), 40, 42-46, 298-318
 monitoring, 309-310
 oral, 318-319
 rate of, 308-309
 routes of, 307-308
 two fluid, 312, 312f
 body water content and electrolyte balance in, 299-304. *See also* Body fluid compartments; Body fluids.
- fat-soluble vitamins in, 321
 indications for, 304
 oral preparations for, 318-319
 parenteral nutrition in, 319
 parenteral vitamin/mineral products in, 319-320
 references on, 322
 review questions on, 323-324
 solutions used in, 302t-303t, 313-321
 additives to, 315-318
 coloidal, 314-315
 composition of, 302t-303t
 crystalloid, 313-314
 hypertonic, 315
 preservatives in, contraindications to, 314TN
 water-soluble vitamins in, 320-321
- Flukes. *See* Trematodes.
- Flumazenil, for reversal of benzodiazepine action, 380-381

- Flunixin meglumine, administration precautions for, 283TN
- Fluocinolone acetonide cream, 217
- Fluorescein ophthalmic stain, 201-202, 202TN
- Fluoride products, 168
- Fluorofoam, 168
- Fluoroquinolones, 237-238
dosage forms of, 238
prohibited use of, as extralabel drug, 22
safety of, 238TN
in topical, for Gram-negative corneal infection, 203
withdrawal periods for animals on, 238TN
- 5-Fluorouracil, 340, 340TN
- Fluoxetine, 96
for behavior modification in self licking, 223
- Fluprostenoil, 181, 181TN
- Flurbiprofen sodium, 203
- Flushing solution, 43
syringe changes in using, 43TN
- Fluticasone propionate, for allergic respiratory conditions, 111
- Fluvoxamine, 96
- Foggers, for flea and tick control, 270-271
- Follicle stimulating hormone (FSH), 174
role of, in estrus cycle, 176, 176f
target and actions of, 175t
- Follicle stimulating hormone-pituitary (FSH-P), 178
- Folliculitis, superficial, antiseborrheic agents for, 214t, 215
- Folutein (chorionic gonadotropin), 177
- Fomepizole, as antidote to antifreeze poisoning, 379, 379TN
- Food additives amendment, 22t
- Food and Drug Administration (FDA), U.S., 414t
and drug information on labels, 17-19, 18f-19f
and regulation of animal health products, 19-20, 20f
and regulation of nutraceuticals, 371
review of new drug application by, 21
- Food Animal Residue Avoidance Databank (FARAD), 20-21
- Foraminidines, 274
- Forane (isoflurane), 92
- Formaldehyde, as disinfectant, 246, 246TN
- Formula 911, 319
- Formularies, and drug databases, resources of, 415t
- Fortaz (ceftazidime), 234
- Forte-Topical, 221, 240
- Fortekor (benazepril), 123
- FortiFlora, 168
- Fresh Ear, 208, 218
- Friskies Cheweez Beefhide treats, 168
- Friskies Feline Dental Diet, 168
- Frontline, 269t
- Frontline Plus, 269t
- Frontline Top Spot for Cats, 271, 271TN
- Frontline Top Spot for Dogs, 271, 271TN
- FSH. See Follicle stimulating hormone.
- FSH-P (follicle stimulating hormone-pituitary), 178
- Full service companies, for veterinary products, 403
- Fulvicin, dosage forms of, 243
- Fungal infections, drugs for, 241-243
- Fungicidal agent, 227, 242
- Fungistatic agent, 227, 242
- Fungizone, 242
- Furazolidone, 241
prohibited use of, as extralabel drug, 22
- Furazolidone spray, 221
- Furosemide, 120
administration of, and client education, 144TN
use of, in heart failure, 144
- G**
- G. I. Conditioner, 168
- Gallamine, 94
- Gallimycin (erythromycin), 239
- Gamma aminobutyric acid (GABA), 75
and behavioral pharmacotherapy, 95
- Ganciclovir, 244
- Ganglia, of autonomic nervous system, 75, 76f
- Ganglionic blockers, 81
- Ganglionic synapse, 70
- Gastric ulcers, 158
drugs for treatment of, 158-161
antacids, 160
gastromucosal protectants, 160-161
H₂ receptor antagonists, 158-159
prostaglandin E-1 analogs, 161
proton pump inhibitors, 160
- Gastrin, 153-154
- Gastrogard (omeprazole), 160
- Gastrointestinal system, 150
anatomy and physiology of, 150-153
birds, 151, 153f
carnivorous species, 150-151, 151f
monogastric herbivores, 151, 152f
ruminant species, 151, 152f
function of, 150
monogastric, 150-151, 151f
regulation of, 153-154
- Gastrointestinal system disorders, and therapies, 149-150
appetite stimulation, 168
bloat, 167
constipation and impaction, 163-164
diarrhea, 161-163
digestion, 166
gastric ulcers, 158-161
induction of vomiting, 154-155
infection inhibition, 168
infections, 166-167
inflammation, 167
motility, 164-166
obesity, 167-168
references on, 169
review questions on, 170-171
vomiting and nausea control, 154-158
- Gastrointestinal ulcers, treatment of, 160-161
- Gastromucosal protectants, 160-161
- Gecolate (guaifenesin), 93
- Gelfoam sponge, 332
- Gemini (xylazine hydrochloride), 83
- Generic name, of drug, and location on label, 17
- Genesis, 217
- Gent-L-Tip Enema, 163
- Gentamicin, 236t, 237
in topical preparation for conjunctivitis, 203
- Gentamicin sulfate, 205-206
ototoxicity with use of, 206TN
- Gentamicin sulfate/betamethasone valerate, in ointment and spray, 221
- Gentamicin sulfate/betamethasone valerate/clotrimazole ointment, 221
- GentaVed Otic Solution, 206
- Gentocin Durafilm solution, 203

- Gentocin Otic Solution, 206
 Gentocin preparations, 237
 Gentocin Topical Spray, 217
 Gentran 70 solution, 314
 Geopen (carbenicillin), 231
 GH. See Growth hormone.
 Giardia infection, 264
 drugs for treatment of, 264, 264TN
 drugs preventing, 265, 265TN
 Giardia Vax, 265, 265TN
 Glargine insulin, 189
 Glaucoma, 196
 closed angle, contraindication to epinephrine in, 198
 contraindication to atropine sulfate in, 198
 drugs for treatment of
 adrenergic agents, 80
 beta blockers, 81
 cholinergic agents, 78
 miotics, 198-199
 Glaucon (epinephrine), 198
 Glipizide, 189
 Glomerular filtration, 12, 12f, 116-118, 117f
 direction of, 117f
 Glucamide. See Chlorpropamide.
 Glucocorticoids, 290, 290t
 as chemotherapy agents, 341-342
 inhibitory action of, in inflammation, 281f
 Glucophage XR (metformin), 189
 Glucosamine, 372
 Glucose, as diuretic, 120
 Glucotrol (glipizide), 189
 Glutaraldehyde, as disinfectant, 245t, 248
 Glycerol, 201
 Glyceryl guaiacolate, 93, 105
 Glyco-Flex, 372
 Glycols, and enhancement of drug solubility, 35
 Glycopeptides, prohibited use of, as extralabel drug, 22
 p-Glycoprotein drug transport, dog breeds with deficiency in, 11
 Glycopyrrolate, 79
 as bronchodilator, 109
 Glycosaminoglycans (GAGs), 126.
 See also Polysulfated glycosaminoglycans.
 Goiter, 184
 Gonadorelin, 177
 Gonadotropin(s), 173
 and gonadal hormones, 177-180
 Gonadotropin releasing hormone (GnRH), 176-177. See also Gonadorelin.
 in estrus cycle, 176f
 Government agencies, regulating veterinary medicine and animal health, 414t, 415t
 Gram (g), 55
 Gram stain, 227, 228f
 Granulation tissue, 211, 218-219
 caustic use for excessive, 223
 Granulex-V, 219
 Granulocyte colony stimulating factor (G-CSF), 343-344
 Gravity IV set, 45, 46f
 Green Book, 21, 415t
 Griseofulvin, 243, 243TN
 Growth hormone (GH), 174, 191
 target and actions of, 175t
 Growth hormones, insect, 274
 Growth promoting hormones (implants), 190-191, 191TN
 implantation site for, 190, 190f
 Guaifenesin, 93, 93TN, 105
 as expectorant, 105
 for extension of anesthesia, 105
 precautions in incremental administration, 93TN
 Guailaxin (guaifenesin), 93
 Guallaxin. See Guaifenesin.
H
 H₁ blockers. See Histamine-1 receptor antagonists.
 H₁ receptor. See Histamine-1 (H₁) receptor.
 H₂ blockers. See Histamine-2 receptor antagonists.
 Hair follicles, 212-213, 212f
 Half-life, of drugs, 2, 13, 14f
 Haloperidol (Haldol), as antiemetic, 158
 Halothane, 92
 physical properties of, 91t
 Haloxon, 261
 Happy Jack Kennel Dip, 273, 273TN
 Hartz Flavor Infused Oral Chews, 168
 Healing stimulators, 219, 219TN
 Heart, anatomy and physiology of, 130-133
 blood pressure in arterial conduction system, 132-133
 conduction system, 131-132, 132f
 control of heart rate, 132
 direction of blood flow, 130-131, 131f
 pumping action, 130-131
 Heart beat, phases of, 131
 events during, on electrocardiogram, 133f
 Heart disease, 130, 133-135. See also Cardiovascular system disorders.
 Heart failure
 ancillary treatment of, 145
 compensatory physiology in, 133, 141
 Heart rate
 control of, 132
 increasing, as compensatory mechanism, 133, 141
 Heartgard (ivermectin), 262, 267, 267TN
 Heartgard for Cats (ivermectin), 262, 267, 267TN
 Heartgard Plus (ivermectin), 262, 266t, 267, 267TN
 Heartworm disease, 265
 adulticides used in, 265, 267, 267TN
 microfilaricides for, 267
 preventive drugs for, 267-268
 preventive products for, comparison of, 266t
 Heatstroke, fluid therapy for, 306t
 Heavy metal poisoning
 dimercaprol for, 378
 penicillamine for, 378-379, 379TN
 Heifers, growth hormone implants for, 190-191
 Helminths, 251
 Hematemesis, 150
 Hematinic agents, 326
 action of, on blood oxygen carrying capacity, 327
 androgens, 328
 blood substitutes, 328-329, 329TN
 erythropoietin, 328
 iron compounds, 327-328
 Hematuria, 115, 116
 Hemoglobin, 326, 327f
 Hemopad Absorbable Collagen Hemostat, 332
 Hemorrhagic shock, fluid therapy for, 306t
 Hemostat Powder, 332
 Hemostatic agents, 332-333
 parenteral, 332
 topical, 332
 Heparin, 329-330, 331TN
 Herbals, 372-376
 Aloe vera, 375
 bloodroot (*Sanguinaria canadensis*), 375

- Herbals (*Continued*)
 bulk, dried, and liquid forms of, 373-374
 contraindication to, before surgery, 375TN
 dosage determination in using, 374
Echinacea purpurea, 375
 efficacy of, 373
 garlic (*Allium sativum*), 375
Ginkgo biloba, 376
 ginseng (*Panax*), 376
 goldenseal (*Hydrastis canadensis*), 376
 interaction of, with conventional drugs, 373, 374t
 milk thistle (*Silybum marianum*), 376
 references on, 375b
 saw palmetto, 373
 St. John's Wort, 376
- Herpes simplex keratitis, antiviral for, 202
- Hespan (hetastarch) solution, 314-315
- High blood pressure. *See* Hypertension.
- Hills t/d diets, 168
- Histacalm preparations, 216, 289
- Histamine(s), 278, 279
 action of, 108, 288, 288f
 on gastrointestinal system, 154, 288
 as bronchodilators, 108, 109
- Histamine-1 (H₁) receptor, activation of, 288, 288f
- Histamine-1 receptor antagonists (H₁ blockers), 288-289
 dosage forms of, 289
- Histamine-2 receptor antagonists (H₂ blockers), 289
 action of, 158, 158f, 166TN
 for gastric ulcers, 158-159
- Histavet-P (pyrilamine), 110, 289
- Homatropel Ophthalmic (homatropine hydrobromide), 198
- Homatropine hydrobromide, 198
- Hormonal disorders, 172-173
- Hormones, and endocrine agents
 anabolic (tissue building) steroids, 191-192
 controlling mechanisms of, 175-177, 290-291, 291f
 direct-acting, 174
 in gastrointestinal regulation, 153-154
 growth promoting, 190-191
 hyperglycemic, for treatment of insulinomas, 189-190
- Hormones, and endocrine agents (*Continued*)
 indirect-acting, 174
 pancreatic, for treatment of diabetes mellitus, 186-189
 production of, in hypothalamus and pituitary gland, 174-175
 references on, 192
 reproductive, 177-184
 drugs affecting uterine contractility, 182-183
 gonadotropins and gonadal hormones, 177-180
 pheromones, 183-184
 prostaglandins, 180-182
 review questions on, 193-194
 sources of, and target and actions, 175t
 thyroid, 184-186
- Horses
 detomidine hydrochloride for sedation/tranquilization of, 83
 inhalation therapy units for, 105
 intravenous administration of medication to, 45, 46f
 oral administration of bolus to, 37, 37f
 oral administration of liquid medication to, 37, 38f
 vaccinations and preventive health program for, 356, 359b
 xylazine hydrochloride use as sedative for, 83, 83TN
- Hot spots. *See* Moist dermatosis.
- Household system, of measurement. *See* Apothecary/household system.
- Humalog, 188
- Humectants, 4t
- Humidification, of inspired air, 102
 of inspired air, 103
- Humilac, 216
- Humorsol (demecarium bromide), 79, 199
- Humulin N, 188-189, 188t
- Humulin R, 188, 188t
- Hyalovet (hyaluronate sodium), 286
- Hyaluronidase, 7
- Hybridoma, 326, 342
- Hycodan (hydrocodone bitartrate), 88, 106-107
- Hydralazine
 for hypertension in renal insufficiency, 123
 as vasodilator in heart failure, 142
- Hydration deficit, 305, 307
- Hydrochlorothiazide, 120
- Hydrocodone, and homatropine, for nonproductive cough, 106
- Hydrocodone bitartrate, 88
 as antitussive, 106-107
- Hydrocodone syrup, generic, 106
- HydroDIURIL (hydrochlorothiazide), 120
- Hydrogen peroxide, as disinfectant, 248
- Hydrolysis, 11
- HydroPlus, 292
- Hydroxyurea, for chemotherapy, 340c, 342
- Hydroxyzine, 110, 289
- HylLy efa Bath Oil/Coat Conditioner, 216
- Hyosciamine, 162
 and phenobarbital, for treatment of diarrhea, 162
- Hyperadrenocorticism, fluid therapy for, 306t
- Hyperalgesia, 280
- Hypercalcemia, treatment of, 316
- Hyperglycemic agents, 189-190
- Hyperkalemia, 299
 treatment of, 316
- Hypernatremia, 299
- Hyperpigmentation, 211
- Hypertension, 115
 associated with heart failure, 141
 drugs for, 141-143
 associated with renal dysfunction, 120
 drugs for, 120-121, 122-123
- Hyperthyroidism
 drugs for, 185-186
 feline, 184
- Hypertonic solutions, 304
 in fluid therapy, 315, 315TN
- Hypertonus, 122
 definition of, 115
- Hypertrophic cardiomyopathy, beta blockers in treatment of, 81
- Hypoadrenocorticism, 292-293
- Hypocalcemia, treatment of, 316-317
- Hypodermis, 212, 212f
- Hypodermoclysis, 7
- Hypoglycemic agents
 injectable, 186-189. *See also* Insulin.
 oral, 189
- Hypokalemia, 115, 299
 as adverse effect of loop diuretics, 120
 as adverse effect of thiazide diuretics, 120TN
 prevention of, 120TN
 treatment of, 316, 318

- Hyponatremia, 299
- Hypophyseal portal system, 173, 174, 174f
- Hypotension
- adrenergic agents for treatment of, 80
 - adrenergic blocking agents in promoting, 81
- Hypothalamic-pituitary-adrenal axis, 290-291, 291f
- Hypothalamus, 74, 74f, 173-174, 174f
- control of reproductive system by, 176-177, 176f
- Hypothyroidism, 184-185
- primary, diagnosis of, 185
- Hypotonic solutions, 304
- Hypotonus, definition of, 115
- Hypovolemia, 299
- Hypovolemic shock, colloid solutions for, 314-315
- Hytakerol. *See* Dihydrotachysterol.
- I**
- I-131, for hyperthyroidism, 186
- Iatrogenic, definition of, 278
- Ibuprofen, 285
- ICM (inventory control manager), 386. *See also* Inventory control manager.
- Idarubicin, 337, 339t
- Idiopathic feline lower urinary tract disease, amitriptyline for, 125-126
- Idiosyncratic drug reaction, 15
- Idoxuridine, 202, 244
- Ifosfamide, 338t
- IgA, 102
- in mucociliary defense mechanisms, 104
- IgE release, from mast cells, 288
- IGR. *See* Insect growth regulators.
- Illotycin, 239
- Ilopan injection (dexpanthenol), 166
- Imidacloprid, 269t, 271, 271TN
- Imidacloprid/moxidectin, 267
- Imidacloprid/permethrin, 269t, 271, 271TN
- Imidazoles, 242-243
- Imidazothiazoles, 262, 262TN
- Imipramine, 96
- Immiscible substance, 59
- Immucide (melarsomine dihydrochloride), 265, 267
- Immunity, active and passive, 349
- Immunologic drugs, 348-365. *See also* Vaccination(s); Vaccine(s).
- Immunoregulin, 344, 365t, 366
- Immunostimulants, 342-344, 365-366, 365t
- Immunosuppressive drugs, 344-345, 365
- corticosteroids as, 291
 - and effects on immunotherapy, 366TN
 - for skin disorders, 223-224
- Immunotherapeutic drugs, 342-344, 365-366. *See also* Biologic response modifiers.
- indications for use of, 365t
 - references on, 366
 - review questions on, 367-368
- Imodium (loperamide), 162
- Implants, 35
- growth hormone, 190-191
- Implus H (estradiol/testosterone implant), 190
- Implus S (estradiol/progesterone implant), 190
- Imuran (azathioprine), 167, 344
- In Synch (dinoprost tromethamine), 181
- in vitro, and in vivo, effectiveness of antimicrobial agent, 227, 228
- Inactivated vaccines, 351
- Inactive (inert) ingredients, 3, 4t, 10, 35
- Inderal (propranolol), 81, 122, 140, 186
- Inderal LA (propranolol extended release capsules), 140
- Indications, for using drug, 2
- Indirect-acting cholinergics, 78-79
- Indirect-acting hormones, 174
- Induction chamber, small animal, 47f
- Indwelling catheter, 44f
- Ineffective osmoles, 301
- Inflammation, 279, 281-282, 281f
- acute and chronic, 279
 - drugs for treatment of, 167, 279
 - antihistamines, 288-289
 - corticosteroids, 289-293
 - muscle relaxants, 289
 - nonsteroidal antiinflammatory drugs, 281-286
 - references on, 295
 - review questions on, 296-297
 - topical ophthalmic, 203
 - inhibitory action of NSAIDs in, 281-282, 281f
- Information, veterinary and animal health, resources for, 414t-416t
- Infumorph (morphine sulfate), 287
- Inhalant anesthetics, 90-92
- alveolar concentration of, 90
 - MAC value of, 90
- Inhalant anesthetics (Continued)
- partition coefficient of, 90
 - physical properties of currently used, 91t
 - vapor pressure of, 90
 - veterinary technician exposure to, 90
- Inhalation therapy
- administration of, 8, 46, 47f
 - for respiratory disease, 105
 - units for small animals, 105
- Injection(s), 7, 38-41, 45, 46. *See also* Intramuscular (IM) injection; Subcutaneous (SC) injection.
- Injection calculations, practice problems involving, 65-66
- Innovar-Vet (fentanyl and droperidol), 89, 158
- Inotropic drugs, for cardiovascular disorders, 135-137
- Inotropic effect, on heart rate, 130
- parasympathetic nervous system and, 132
- Insect growth regulators (IGRs), 274
- Insect repellants, 274
- Insecticides, 272-275
- Inspired air, distribution and diffusion of, 104
- Inspissated, definition of, 102
- Inspissated respiratory mucus, 106
- Insulin
- administration routes for, 186. *See also* Insulin syringe(s).
 - classification of, 187-188
 - intermediate acting insulin, 188-189
 - long acting insulin, 189
 - short acting insulin, 188
 - client education about products and use, 189, 189TN
 - concentration of, in units per milliliter, 187
 - discontinued products containing, 189TN
 - hypersecretion of, in beta cell tumors, 189-190
 - products commonly used for dogs and cats, 188t
 - sources of therapeutic, 186
 - synthetic production of, 186-187
- Insulin dependent diabetes mellitus, 186
- Insulin syringe(s), 187t
- manufacturers of, 187t
 - with needle attached, 33b, 33f
 - types of, and needle size, needle gauge, and packaging, 187t

- Insulinomas, 189-190
- Integumentary system, 211-213
- Intensol (propranolol oral solution), 140
- Interceptor (milbemycin oxime), 266t, 267, 267TN
- Interferon, 343
recombinant, 244, 343
- Interleukins, as immunostimulants, 343, 365
- Intermediate acting insulin, 187, 188-189, 189TN
- Interneurons, 73
- Interstitial fluid, 299, 300f
composition of, 300-301, 300t
drug level in, 11
- Intraarterial (IA) administration, 7, 8
- Intraarticular administration, 7, 8
- Intracardiac administration, 7, 8
- Intracell, 219
- Intracellular fluid (ICF), 299-300, 300f
- Intradermal (ID) administration, 7
- Intramedullary administration, of drug, 7, 8
- Intramuscular (IM) injection, 7, 38
avoiding sciatic nerve in, 39f
common complications after, 40
negative syringe pressure in, 40
procedure for, 41, 46
- Intraocular pressure. *See* Glaucoma.
- Intraosseous route, of fluid therapy administration, 308
- Intraperitoneal (IP) administration, 7-8
of therapeutic fluids, 308
- Intrathecal administration, 8
- Intravascular fluid. *See* Plasma.
- Intravenous (IV) administration sets, 309, 311f
- Intravenous (IV) fluid administration, 7, 29, 40, 42-46, 307. *See also* Fluid therapy.
bolus using Y-injection site, 45
bolus with indwelling intravenous catheter, 43
calculations for, 58-62, 67-68, 305, 307
catheter replacement in, 40TN
direct bolus, 42
duration and drip rate calculations for, 308-309
equipment preparation for, 311-312
with indwelling catheter, 44, 44f, 44TN
with infusion pump, 46
- Intravenous (IV) fluid administration (Continued)
by injection with syringe, 38, 40, 40f
to large animals, 45, 46f
large volume bottle or bag in, 29, 30f
monitoring patient in, 46, 46TN, 309-310
to pediatric animals, and exotics, 45
to small animals, 40-45
- Intron A (recombinant interferon), 343
- Intropin (dopamine), 80, 123
- Inventory, 385-388
accounting systems for, 387-388, 389f, 404-405
controlling
objectives in, 390, 390TN
veterinary technician role in, 386-387, 387TN, 390, 405. *See also* Inventory control manager.
definition of, 386, 387-388
expense of, in veterinary operation, 388TN
FIFO method of, 386, 388
human pharmacy, 404
markup of, 386, 397, 397TN
monthly versus rotating, 399-401
ordering, 395, 397
organizing, 397, 399, 399TN
purchasing, 401-404
delayed billing in, 386, 401
return policies in, 401
statement payment in, 401
vendors used in, 403-404
rabies vaccine records in, 397
receiving shipment of, 401-403, 402TN
FOB rules and contracts in, 402, 402TN
references on, 405
reorder log in, 394, 394TN, 396f
reorder point for, 394TN
reorder quantity for, 397
review questions on, 406-407
shelf stocking, and product rotation, 403
special ordering, 404
time equation in managing, 388, 390
turnover of products in, 386, 390, 390TN
rate of, 390
vendors of products for, 403-404
- Inventory control manager (ICM), 386, 387TN
responsibilities of, 386-387, 387TN, 390, 405
back-ordering, 391
controlled substances handling and storage, 391, 391TN. *See also* Controlled substances.
DEA forms, 391, 392f, 404
expiration date checking, 391, 391TN
FOB rules and shipment contract, 402, 402TN
inventory taking, 399-401
invoice checking, 391, 393f
ordering, 395, 397, 403-404
organizing, 397, 399
packing slip checking, 391, 394f, 402, 402TN
pilferage checking, 391
purchasing, 401-402
rabies vaccine recording, 397, 398f
receiving shipment, 402-403, 402TN
recording accuracy, 391
reorder point setting, 394-395, 394TN
sale representative
communications, 404
staff memo, 399, 399TN
statement checking, 386, 391, 395f
turnover rate, 391, 391TN
- Invoice, 386, 391, 393f
- Involuntary control, of nervous system, 71-72
- Involution, 173, 182
- Iodine
as disinfectant, 245t, 246, 246TN
as topical antiseptic, 218
- Iodine-131, in treatment of hyperthyroidism, 186
- Iodine Shampoo, 221
- Iodine tincture, 218
as disinfectant, 246
- Iodophor(s), 227, 246
- Iopidine (apraclonidine), 200
- Ipecac oral syrup, 155
- Ipodate, 186
- Iprnidazole, prohibited use of, as extralabel drug, 22
- Iron compounds, 327-328, 328TN
- Irritants, for gastrointestinal stimulation, 164

- Isoflo (isoflurane), 92
 Isoflurane, 92
 physical properties of, 91t
 Isopropyl alcohol, 244-245
 70% to 90%, 217
 as counterirritant, 222
 Isoproterenol, 80
 for atropine resistant
 bradycardia, 137
 as bronchodilator, 109
 Isoptin (verapamil), 123, 141
 Isoptin SR (verapamil), 141
 Isopto Carpine (pilocarpine), 78, 199
 Isopto Homatropine (homatropine
 hydrobromide), 198
 Isotonic solutions, 304
 Isuprel (isoproterenol), 80, 109
 Itching. *See also* Pruritis.
 topical medications for, 216-217
 Itraconazole, 243
 topical, for ophthalmic fungal
 infections, 202
 Ivermectin, 262
 administration of chewable, 263TN
 as insecticide, 274
 as microfilaricidal agent, 267
 precautions in use of, 263TN
 as preventive agent against heart
 worm disease, 267
 unapproved uses of, 263TN
 Ivermectin/milbemycin, for ear mites,
 207
 Ivomec (ivermectin), 262
 Ivomec 1% Injectable for Cattle, 274
 Ivomec 1% Sterile Solution for
 Swine, 274
- J**
 Jenotone (aminopropazine), 126t
- K**
 K-Pek (kaolin/pectin), 162
 K-Y Jelly, 381
 K9 Advantix, 269t, 271, 271TN
 Kanamycin, 236t, 237
 Kantrim (kanamycin), 237
 Kao-Forte (kaolin/pectin), 162
 Kaolin/pectin, 162-163
 Kaopectol (kaolin/pectin), 162
 Kappa opiate receptors, 87
 Kat-A-Lax (petrolatum), 164
 Kefauver-Harris amendment, 22t
 Keflex (cephalexin), 234
 Keflin (cephalothin), 234
 Kefzol (cefazolin), 234
 Kennel sprays, for flea and tick
 control, 270
- KeraSolv Gel, 213
 Keratinized structures, of skin, 212-213
 Keratitis, 196
 caused by herpes simplex, 202
 mycotic, 202
 Keratoconjunctivitis sicca, treatment
 of, 204
 Keratolytic drugs, 211, 213-215
 Keratoplastic drugs, 211, 213-215
 Ketalar (Ketamine HCl), 86
 Ketamine HCl, 86, 288
 contraindications to, and
 precautions, 86TN
 intramuscular injection of, 46
 and morphine, 62, 288
 Ketaset (Ketamine HCl), 86
 KetoChlor, 218
 Ketoconazole, 242-243
 and infertility in male dogs, 243TN
 Ketofen (ketoprofen), 285
 Ketone bodies, 186
 Ketoprofen, 285
 Ketorolac, 286
 Ketorolac tromethamine, 203
 Kidneys. *See also* Renal system, and
 urinary tract.
 decreased function of, and resulting
 conditions, 118-119. *See also*
 Renal insufficiency.
 in drug metabolite excretion, 12, 12f
 failure of, 119-120
 function of, 116-119, 117f
- Kilogram (kg), 55
 Kirby-Bauer procedure, 228
 Konakion, 333
 Kopertex, 221
- L**
 Label(s), drug, 18f-19f
 information found on, 17-19, 371
 Labeling, of IV bag, for volume
 control, 310, 311f
 Lacri-Lube, 204
 Lactated Ringer's solution, 313
 Lactulose, 163
 Lambs, growth hormone implants
 for, 191
 Lameness, in horses, local anesthesia
 in diagnosis of, 293, 294f
 Laminitis
 antihistamines for, 288
 corticosteroids for, 292
 Lanoxicaps (digoxin capsules), 136
 Lanoxin preparations, 136
 Lansoprazole, 160
 Lantus (glargine insulin), 188t, 189
- Large-volume bottle(s), or bags, 29, 30f
 Lasix (furosemide), 120, 144
 Latanoprost, 200
 Laudanum (10% opium), 87
 Laxatives, 163
 bulk producing, 163-164
 lubricant, 164
 saline and hyperosmotic, 163
 Laxatone (petrolatum), 164
 LD₅₀, 14
 Lead poisoning, treatment of
 calcium EDTA for, 376-377,
 377TN
 dimercaprol for, 378
 penicillamine for, 378-379, 379TN
 Legend, 286, 370
 Legend drug. *See* Prescription drug.
 Length units, in metric system, 55t
 Lente insulin, 188-189
 Leukocell 2 vaccine, 351
 Leuprolide, for endocrine disorder
 therapies, 183
 Levamisole, 262
 as immunostimulant, 344
 Levasole (levamisole), 262
 Levemir (detemir insulin), 189
 Leventa (levorothyroxine sodium), 184
 Levo isomer(s), 173, 184
 Levobunolol, 200
 Levophed (norepinephrine), 80
 Levorothyroxine sodium (T₄), 184-185
 Levsin (hyoscyamine), 162
 LH. *See* Luteinizing hormone.
 Librax (clidinium/chlordiazepoxide),
 162
 Lidocaine, 288
 for arrhythmias, 139, 139TN
 effects of, on sodium ion channels,
 139f
 with epinephrine, contraindication
 to, in arrhythmias, 295TN
 injectable preparations of, 294, 295
 for pain relief, 288
 LIFECARE flexible fluid therapy bags,
 310f
 D-Limonene, 275
 Lin-O-Gel, 222
 Lincomycin, dosage forms of, 239
 Lincosamides, 239-240, 240TN
 Lindane, 273, 273TN
 Liniment(s), 28
 topical administration of, 35
 Liothyronine sodium (T₃), 185
 Lipid solubility, of drug, 9-10
 Liquamycin-LA 200
 (oxytetracycline), 235

- Liquichlor, 206
 Liquid measures, 412t
 and metric-apothecary equivalents, 412t
 Liquid preparation(s)
 for oral administration, 29, 37-38
 for topical application, 35
 Liquifilm Tears, 204
 Lispro insulin, 188
 Liter, 55
 Live vaccines, 351, 355
 Liver
 in drug metabolite excretion, 12, 13f
 metabolism of drugs in, 11
 Loading dose, 6
 Lock-and-key model, 13-14, 15f
 Lomotil (diphenoxylate), 88, 162
 Long acting barbiturates, 84-85
 Long acting insulin, 187, 189
 Loop diuretics, 120, 144
 Loperamide, 162
 Lopressor (metoprolol), 140
 Lorazepam, in behavioral pharmacotherapy, 95-96
 Losec (omeprazole), 160
 Lot number, on drug labeling, 18
 Lotion(s), topical administration of, 35
 Low blood pressure. *See* Hypotension.
 Lower motor neurons, 115
 lesions of, in atonic neuropathic bladder, 125
 Loxon (haloxon), 261
 Lube Jelly, 381
 Lubri-Nert, 381
 Lubricants, 381, 382TN
 intestinal, 164
 ocular, 204
 Lubrivet, 381
 Luer-Lok tip syringe, 32f
 Lufenuron, 271, 271TN
 Lugol's Solution, 218
 Lumigan (bimatoprost), 200
 Luminal (phenobarbital), 85t
 Lungs. *See* Respiratory system.
 Lutalyse (dinoprost tromethamine), 181
 Luteinizing hormone (LH), 174
 role of, in estrus cycle, 176f, 177
 target and actions of, 175t
 Luvox (fluvoxamine), 96
 Lymphocytic neoplasms, corticosteroids for, 291, 292
 Lymphocyte T-Cell
 Immunomodulator, 344
 Lysol I.C. Disinfectant Spray, 247
 LyTar preparations, 215
- M**
 M-99 (etorphine), 88
 Maalox, 160
 MAC (minimum alveolar concentration) value, of inhaled drug, 90
 Macro drip IV administration set, 309
 Macrolides, 239
 Maduramicin ammonium, 264
 Magnalax, 160
 Magnalax Bolus, and Powder, 163
 Magnesium hydroxide, 160
 as laxative, 163
 Magnesium sulfate, 163
 as antidote for lead absorption, 377TN
 for hypertonic wet dressings, 216
 Mail order discount houses, for veterinary products, 403
 Maintenance volume, value of, 305, 307
 Male adapter plug, examples of, 43f
 Malignant neoplasms, 333-334
 chemotherapeutic agents for, 334-344
 Mammary glands, excretion of metabolites from, 13
 Mannitol
 as osmotic diuretic, 120
 for treatment of glaucoma, 200-201
 Mannitol 20%, 120
 Manufacturer, of drug, and location on label, 17
 Manufacturing process, drug, 2
 and effect on molecular characteristics, 8
 Marbocyl (marbofloxacin), 238
 Marbofloxacin, 238
 Marcaine (bupivacaine), 294
 Marketing drugs, 23-24
 Maropitant citrate, as antiemetic, 158
 Marquis (ponazuril), 264
 Maxiban 72 (narsiti/nicarbazine), 264
 Maximum tolerated dose (MTD), 335
 determination of, 335, 335t
 Maxipime (cefepime), 234
 Maxitrol, 203
 Measurement, system(s) of, 55-58
 apothecary and household, 57-58
 equivalency tables between, 412
 metric, 55-57
 Mebendazole, 253
 Meclizine, 289
 as antiemetic in motion sickness, 157
- Meclofenamic acid, 286
 Medetomidine, 84, 84TN
 atipamezole as reversal agent for, 81, 84, 84TN
 bradycardia induced by, treatment of, 84TN
 Medication orders, 48, 49f
 Medrol, 220, 292
 Medroxyprogesterone, 97
 Medroxyprogesterone acetate (MPA), 179-180
 Medulla, 74
 Mefoxin (cefoxitin), 234
 Megace (megestrol acetate), 97, 179
 Megestrol acetate, 97, 179, 179TN
 Melarsomine dihydrochloride, 265, 267, 267TN
 Melatonin, for endocrine disorder therapies, 183
 Melena, 150
 Melengestrol acetate, in implants, 180
 Melophalan, 338t
 Meloxicam, 286
 Meperidine, 87, 287
 Mephyton, 333, 380
 Merbromin, 248
 Mercuric oxide, as vesicant, 222-223
 Mercurochrome (merbromin), 248
 Merthiolate (thimerosal), 248
 Mestinon (pyridostigmine), 79
 Meta-Dote, 377
 Metabolic acidosis, 299, 315
 Metabolic alkalosis, 299, 314
 Metabolism, of drugs, 2, 11-13
 and excretion of metabolites, 11-13
 factors influencing, 11
 in kidneys, 12, 12f
 in liver, 11, 12, 13f
 Metabolite(s), 11
 Metacam preparations (meloxicam), 286
 Metaflumizone, 272
 Metaflumizone/amitraz, 272
 Metamucil (psyllium), 163
 Metastasis, 326, 334
 Meteproterenol, as bronchodilator, 109
 meter (m), 55
 Metformin, 189
 Methadone, 88
 Methazolamide, 199
 Methemoglobin, 326
 Methemoglobinemia, 370
 antidote for treatment of, 377, 377TN
 Methicillin, 230t

- Methigel (methionine), 123
 Methimazole, for hyperthyroidism, 185
 Methio-Tabs (methionine), 123
 Methionine, 123-124
 Methocarbamol, 289
 Methohexital, 85
 Methoprene, 274
 Methotrexate, 339t, 340
 Methoxychlor, 273
 Methoxyflurane, 92
 physical properties of, 91t
 Methscopolamine, 79
 for treatment of diarrhea, 162
 Methylene blue, as antidote, 377, 377TN
 Methylprednisolone Tablets, 292
 Methylxanthines, as bronchodilators, 109-110
 Meticorten, 292
 Metipranolol, 200
 Metoclopramide, 78
 antagonists to action of, 157TN
 as antiemetic, 156-157
 contraindication to, in GI obstruction, 157TN
 as gastrointestinal prokinetic, 165
 Metofane (methoxyflurane), 92
 Metoprolol, for arrhythmias, 140
 Metrazol (pentylene-tetrazol), 94
 Metric system, 55-57
 conversion of units within, 55-57, 56f
 problems using, 63-64
 units of, 55t
 weights and measures, and equivalent apothecary values, 412t
 Metronidazole, 167, 167TN, 345, 345TN
 for *Giardia* infection, 264, 264TN
 immunosuppressive action of, 345
 Mexiletine, for arrhythmias, 139
 MGK 11 (2,3,4,5-bis (2-butylene)tetrahydro-2-furaldehyde), 274
 MGK 236 (di-n-propyl isoinchomerate), 274
 Mibolerone, 179
 contraindication to, in cats, 179TN
 Miconazole, 221, 242-243
 Miconazole solution, as ophthalmic antifungal agent, 202
 Micotil, 239, 239TN
 Micro Pearls Advantage Seba-Moist-Shampoo, 213
 Micro Pearls Benzoyl Plus Shampoo, 215
 Microdrip IV administration set, 309
 Microencapsulation, 35
 Microfilaria, 251
 Microorganism(s), 227
 Micturition, 115
 Midazolam, 82-83
 Midbrain, 74f
 MilbeMite (0.1% Milbemycin), 207
 Milbemycin oxime
 as microfilaricidal agent, 267
 as preventive agent against heartworm disease, 267, 267TN
 Milk of magnesia, 160, 163
 Milliequivalent(s) (mEq), and calculations, 61, 301
 Milliequivalent weight, definition of, 54
 Milligram (mg), 55
 Milliliter (ml), 55
 Millicsmole (mOsm), 301
 Milrinone, 137
 Mineral oil, as intestinal lubricant, 164, 164TN
 Mineralocorticoids, 290, 290t
 Minidrip IV administration set, 309
 Minipress (prazosin), 81, 122, 143
 Minocin (minocycline), 235, 235t
 Minor Use and Minor Species Animal Health Act (2001), 23
 Mitosis, 196
 Miotic agents, 198-199
 Miscible substance, 59
 Misoprostol
 contraindication to use of, in pregnant animals, 161TN
 for gastric ulcers associated with use of NSAIDs, 161
 Mita-Clear, 207
 Mitaban (amitraz), 274
 Mitaplex-R, 207
 Mites. See Ear mite infestation; Insecticides.
 Mitoxantrone, 337, 339t
 Mixed vaccine, 353-354
 Mixing drugs
 avoiding, 16TN
 interactions when, 16, 16t
 Mixture(s), 29
 MK (morphine and ketamine), 288
 MLK (morphine, lidocaine, and ketamine), 288
 Modified live vaccines, 351-352, 355
 Modulation, of nociceptive transmission, 278
 Moist dermatosis
 antiseborrheic agents for, 214t, 215
 systemic corticosteroids for, 220
 topical corticosteroids for, 217
 Mometamax, 206
 Monesin, 264
 Monistat (miconazole), 243
 Monoamine neurotransmitters, 95
 Monoamine oxidase-B inhibitors, 96-97
 Monoclonal antibodies, 342-343, 342f
 Monodox (doxycycline), 235
 Monovalent vaccine, 354
 Morantel tartrate, 261-262
 Morphine sulfate, 87, 287
 and ketamine, for pain control, 62, 288
 Motilin, 150
 Motilin-like drugs, 165
 Motility disorders, gastrointestinal.
 See Constipation; Diarrhea; Prokinetics and stimulants.
 Motilium (domperidone), 165
 Motion sickness, 288
 Motor neuron, 73
 Moxidectin, 262, 267, 268TN
 Moxifloxacin, in topical ophthalmic preparations, 203
 Moxisylyte
 action of, and indications, 126t
 for urinary retention treatment, 122
 MPA. See Medroxyprogesterone acetate.
 MTD (maximum tolerated dose), 335, 335t
 Mu opiate receptors, 87
 Mucociliary clearance, 104
 Mucolytic(s), 102, 106
 therapeutic action of, 104-105
 Mucomyst (acetylcysteine), 106, 377
 Mucosil preparations (acetylcysteine), 106, 377
 Mucus membrane congestion,
 adrenergic agents in reducing, 80
 Mucus secretion and movement, in upper respiratory tract, 103-104
 Multidose syringe, 33b, 33f
 Multidose vial(s), 29, 30f
 easing liquid withdrawal from, 41TN
 Multisol-R, 314
 Muscarinic receptor(s), 70, 77, 78
 Muscle relaxants. See Skeletal muscle relaxant(s).
 Musculoskeletal inflammation,
 corticosteroids for, 289-292
 Myasthenia gravis, cholinergic agents in diagnosis of, 78

- Mycitracin Sterile Ointment, 240
 Mycobacterial cell wall fraction, 365t, 366
 Mycodex Minifog (D-Phenothrin), 273
 Mycodex Pet Shampoo (D-trans allethrin), 273
 Mycodex pet Shampoo with Carbaryl, 273
 Mycodex Tar and Sulfur Shampoo, 215
 Mycophenolate mofetil, 345
 Mydrin (phenylephrine), 197
 Mydracyl (tropicamide), 198
 Mydriasis, 196
 Mydriatic agents, 197-198
 Myelin sheath, 72, 72f, 73
 Myeloma, 326, 342
 Myelosuppression, 326
 Mylanta, 160
 Mylepsin (primidone), 89
 Myocardial disease, 134
 Myofibril(s), 173
 contractility of uterine, 182
 Myosan Cream, 218
 Myotrol, 289
N
 Nalbuphine, 287
 Nalorphine (Nalline), 88
 adverse effects of, 89
 Naloxone, 88, 89
 for behavior modification in self licking, 223
 for respiratory stimulation in narcotic overdose, 111
 in reversal of apomorphine overdose, 155TN
 in reversal of narcotic overdose, 88, 89, 381, 381TN
 Naloxone HCl injection, 88
 Naltrexone, for behavior modification in self licking, 223
 Names, of drugs, 16-17
 Nandrolone, 124
 Nandrolone decanoate, 192
 Naproxen, 285
 Naproxyn (naproxen), 285
 Narasin/nicarbazine, 264
 Narcan (naloxone), 88, 381
 Narcotics. *See* Opioid agonists.
 Nasal cavity, defense mechanisms within, 104
 Natacyn (natamycin), 202
 National Animal Supplement Council
 logo of, 371f
 and quality control of herbals, 373
 Navelbine (vinorelbine), 341
 Naxel (ceftiofur sodium), 234
 approval for use in dairy animals, 233TN
 NDC (National Drug Code) number, on drug labeling, 18
 Nebulization, 102, 105
 of mucolytics, 105
 Needle(s), 34b, 34f
 for biopsy, 34f
 for bleeding, 34f
 common gauges for specific animal species, 30t
 hub, shaft, and bevel of, 34f
 proper discarding of, 35TN
 Nematel (morantel tartrate), 261-262
 Nematodes, 251
 drugs effective against, 253-263
 topical solutions for, 264
 Nembutal (pentobarbital sodium), 85, 85t
 Nemex (pyrantel pamoate), 261-262
 Neo-Carbazole (carbimazole), 185
 Neo-Predef, 203
 Neo-Synephrine (phenylephrine), 80, 197
 Neobacimyx Ophthalmic Solution, 240
 Neomycin, 236t, 237
 ototoxicity of, 206TN
 in topical ophthalmic preparations, 203
 in topical otic preparations, 206
 Neoplasms
 benign and malignant, difference between, 333-334
 drug therapy for, 333-344. *See also* Chemotherapeutic drugs.
 Neoral (cyclosporine), 204
 Neostigmine, 78-79
 as antagonist to nondepolarizing neuromuscular blocking agents, 94
 as gastrointestinal prokinetic, 166
 Nephrology, 115
 Nephron, 12, 12f, 115
 function of, 115
 Neptazane (methazolamide), 199
 Nerve block, 278, 293
 Nerve fiber(s), 73
 diameters of, 73
 myelin sheath of, 72f, 73
 in pain sensation, 279-280, 280f
 preganglionic and postganglionic, in autonomic nervous system, 75, 76f
 Nervous system, 70
 anatomy and physiology of, 70-75
 autonomic, 71-72. *See also* Autonomic nervous system.
 therapeutic drugs and effects on, 78-81
 central, 70-71. *See also* Central nervous system.
 drugs that act on, 81-97
 and endocrine system, interaction of, 173-174, 174f
 function of, 70
 impulse conduction through, 73-75, 74f
 neurotransmitters in, 72-73, 73f, 75
 organization of, 70-72, 71f
 parasympathetic, 72
 peripheral, 70-71. *See also* Peripheral nervous system.
 physiologic unit of, 72-73. *See also* Neuron(s).
 sympathetic, 72
 Neurogenic disorder(s), urinary incontinence as, 125
 Neurohormonal reflex, 176
 Neuroleptanalgesics, 89
 Neuromuscular blocking agents, 94-95
 avoiding use of aminoglycosides with, 237TN
 cholinergics as antidotes to, 78
 Neuron(s), 72, 72f
 impulse transmission through, 72-73, 72f
 Neurotransmitter(s), 72-73, 72f, 75
 in behavioral disorders, 95
 blocking of, 73f
 monoamine, 95
 physiological activity of, 73f
 Neutersol, 183
 Neutraceutical(s)
 definition of, 371
 evaluation of, for veterinary use, 371
 labeling regulation for, 371
 Newcastle disease vaccine, 352
 Nexaband, 220
 NFZ Puffer, 241
 Nicergoline
 action of, and indications, 126t
 for urinary retention treatment, 122
 Nicotinic receptor(s), 70, 77, 78
 Nifedipine, for arrhythmias, 141
 Nitenpyram, 274
 Nitro-Bid (nitroglycerin ointment), 142-143
 Nitrofurans, 241, 241TN
 Nitrofurantoin, 241

- Nitrofurazone preparations, 241
 Nitrogen balance, 173
 positive, 191
 Nitroglycerin ointment, 142-143, 143TN
 Nitroimidazoles, prohibited use of, as extralabel drug, 22
 Nitrol (nitroglycerin ointment), 142-143
 Nitrous oxide, 92
 physical properties of, 91t
 Nizatidine, as gastrointestinal prokinetic, 159
 Nizoral (ketoconazole) preparations, 242
 NK-1 receptor antagonists, as antiemetics, 158
 No String Barrier Film, 220
 Nociceptors, 278, 279-280, 280f
 Nocturia, 115
 Nolvadent oral cleansing solution, 168, 247
 Nolvamite, 207
 Nolvasan Antiseptic Ointment, 218
 Nolvasan preparations, 247
 Nomagen, 365t, 366
 Noncatecholamines, 80
 Nondepolarizing neuromuscular blocking agents, 94
 Noninsulin dependent diabetes mellitus, 186
 Nonneoplastic feline leukemia, antiviral agents for, 244
 Nonproductive cough, 102, 105
 antitussives for, 106-108
 Nonsteroidal antiinflammatory drugs (NSAIDs), 281-286
 acetaminophen, 284, 284TN
 action of, in analgesia and fever reduction, 281-282
 buscopan compositum, 284
 client education about, 282
 deracoxib, 285
 dimethylsulfoxide, 283-284
 etodolac, 285
 firocoxib, 286
 flunixin meglumine, 283, 283TN
 hyaluronate sodium, 286
 inhibitory action of, in inflammation, 281f
 ketorolac, 286
 meclufenamic acid, 286
 meloxicam, 286
 orgotein, 286
 polysulfated glycosaminoglycan, 286
 precautions in use of, 282TN
 Nonsteroidal antiinflammatory drugs (NSAIDs) (Continued)
 propionic acid derivatives, 284-285
 pyrazolone derivatives, 282-283, 283TN
 salicylates, 282, 282TN
 selenium and vitamin E, 286
 side effects of, 282
 tepxalin, 286
 topical, for ophthalmic inflammation, 203
 Nonsteroidal antipruritic medications, 216-217
 Noradrenalin (norepinephrine), s80
 Norcalciophos, 317
 Norcuron (vecuronium bromide), 95
 Norepinephrine, 75, 77, 80
 and behavioral pharmacotherapy, 95
 Norfloxacin, 238
 in topical ophthalmic preparations, 203
 Norgestomet, 180
 Normal saline solution, 313
 Normosol-M in 5% dextrose, 314
 Normosol-R, 314
 Noroxin (norfloxacin), 238
 Norvasc (amlodipine), 123, 141
 Novolin N, 188-189, 188t
 Novolin R, 188, 188t
 NovoLog, 188
 NPH (Neutral Protamine Hagedorn) insulin, 188-189
 NSAIDs. *See* Nonsteroidal antiinflammatory drugs.
 Nubain (nalbuphine), 287
 Nuflo injectable solution (florfenicol), 239
 Numorphan (oxymorphone), 87, 287
 NuSal-T Shampoo, 213
 Nutraceutical(s), 370-372
 definition of, 370
 Nutrient replacement, with fluid therapy, 313-314
 NutriVed T-4 Chewables (levothyroxine sodium), 184
 Nylar, 274
 Nystatin, 242
 O
 Obesity, canine, dirlotapide for, 167-168
 Object drug(s), 16, 16t
 Octreotide, 189-190
 N-Octyl bicycloheptene dicarboximide, 274
 Ocufen (flurbiprofen sodium), 203
 Ocular lubricants, 204
 Ocupress (cartelol), 200
 Official name, of drug, 17
 Ofloxacin, in topical ophthalmic preparations, 203
 Ointment(s), 28
 application of, 35, 47-48
 ophthalmic, application of, 47-48, 48f
 Olsalazine, 167
 Omeprazole, 160
 Omnizole (thiabendazole), 253
 Oncotic pressure, 299
 Oncovin (vincristine), 341
 Ondansetron, as antiemetic, 158
 Ongoing fluid loss, 305, 307
 Open-angle glaucoma, 196
 drugs for, 198-199
 Ophthaine (proparacaine hydrochloride), 201
 Ophthaine Solution Veterinary, 295
 Ophthalmic disorders, 195-197
 Ophthalmic preparations
 for anesthesia, 201, 295
 application of, 47-48, 48f
 patient education about, 196
 preventing contamination in, 241TN
 for artificial tears, 204
 choice of, considerations in, 196
 for collagen shields, 202
 for inflammation, 203, 292
 for keratoconjunctivitis sicca, 204
 miotic, 198-199
 miscellaneous, 204
 mydriatic and cycloplegic, 197-198
 references on, 208
 review questions on, 209
 for stains, 201-202
 for superficial infection, 202-203
 Ophthalmic stains, administration of, 202TN
 Ophthetic, 295
 Opiate receptors, 87
 Opioid agonists, 86-88, 286-288
 action of, in pain relief, 287
 adverse effects of, 88
 antagonists to action of, 88-89
 combined with antagonists, 287
 for diarrhea, 161-162
 naturally occurring, 87
 partial, 287-288
 synthetic, 87-88
 Opioid antagonists, 88-89, 287
 Opium, 87
 Opti-Chamber, 105
 Opticyl (tropicamide), 198
 Optimmune Ophthalmic Ointment (cyclosporine), 204

- OptiPranolol (metipranolol), 200
 Ora-Lyte, 319
 Oragrafin (ipodate), 186
 Oral corticosteroids, 292
 Oral electrolyte solutions, 318-319, 319TN
 dosage forms of, 319
 Oral fluid therapy, 308
 Oral hygienic products, 168-169
 Oral hypoglycemic agents, 189
 Oral medications, 36
 administration of, 7, 36-38
 calculations for, 58-59, 64-65
 rapid, 29TN
 gastrointestinal conditions and absorption of, 10, 37TN
 liquid formulations, 29
 administration of, 37-38
 tablet, capsule, bolus preparations of, 28-29
 administration of, 36-37
 Oral ulcers, treatment of, 160-161
 Orap (pimozide), 158
 OraVet preparations, 168
 Orbax (orbifloxacin), 238
 Orbenin (cloxacillin), 231
 Organic mercury compounds, as disinfectants, 248
 Organophosphates, 79, 251
 contraindications to administration of, 261TN
 for endoparasitic infections, 261
 for flea and tick control, 273-274, 274TN
 toxicity of, symptoms of, and antidotes, 261, 261TN
 Orgotein, 286
 Ornade (phenylpropanolamine), 80
 Oradis (ketoprofen), 285
 Osmoglyn (glycerol), 201
 Osmolality, 301
 Osmolarity, 301
 Osmole (osm), 301
 Osmotic diuretics, 120, 120TN
 for treatment of glaucoma, 200-201
 Osmotic effects, of fluids, 304, 304f
 Osmotic pressure, of body fluids, 301, 304
 Oti-Calm, 208
 Oti-Clear, 208
 Oti-Clens, 208, 219
 Otic disorders, 195
 Otic medications, 205-208
 antiinfective, 205-206
 antiparasitic, 206-207
 application of, 48, 205
 Otic medications (Continued)
 for cleansing, 207-208
 for drying, 207
 miscellaneous, 208
 references on, 208
 review questions on, 209
 Otomax, 206
 Ovaban (megestrol acetate), 97, 179
 Over-the-counter drugs, 4-5
 Overhydration, signs of, 310
 Ovine ecthyma vaccine, 351
 Oxacillin, 230t
 Oxibendazole, 253
 Oxidation, 11
 Oxy-Tet (oxytetracycline), 235
 Oxybarbiturates, 84-85
 Oxybiotic (oxytetracycline), 235
 OxyDex Gel and Shampoo, 215
 Oxygen and carbon-dioxide exchange, 104
 Oxygen therapy, 145
 Oxyglobin (hemoglobin glutamer-200), 329, 329TN
 Oxymetazoline, as decongestant, 110
 Oxymorphone, 87, 287
 Oxypolygelatin solution, 315
 Oxytetracycline, 235, 235t
 in topical ophthalmic preparations, 203
 Oxytocin, 175, 182
 neurohormonal reflex in release of, 176
 target and actions of, 175t
P
 P/M Naloxone HCl injection, 381
 Pacemaker, of heart, 131
 Pacheco's disease, antiviral agents for, 244
 Paclitaxel, 339t, 341
 Pain
 in animals, assessment of, 278
 drugs for treatment of, 277-279, 295TN
 action of, 280-281
 anesthetics, 293-295
 counterirritants, 35
 detomidine hydrochloride, 83
 medetomidine, 84
 muscle relaxants, 289
 nonsteroidal antiinflammatory drugs, 281-286
 opioid agonists, 87-88, 286-288
 opioids, 87
 references on, 295
 review questions on, 296-297
 xylazine hydrochloride, 83
 Pain (Continued)
 perception of, 280
 sensation of, anatomy and physiology, 279-281
 Palosein (orgotein), 286
 Pamine (methscopolamine), 162
 Panacur (fenbendazole), 253
 Panalog, 206, 221
 Panalog Cream, 242
 Pancreatic enzymes, 166
 Pancreatic hormones, 186
 in diabetes mellitus therapy, 186-189
 Pancrelipase, 166, 166TN
 Pancrezyme powder (pancrelipase), 166
 Pancuronium bromide, 94
 Panmycin (tetracycline), 235
 Panteck Cleanser, 247
 d-Panthenol preparations (dexpanthenol), 166
 Paramite Dip for Dogs, 273
 Parapectolin, 162
 Paraplatin (carboplatin), 341
 Parapox otis virus immunomodulator, 344
 Parasites
 external, 252, 268-275. *See also* Ectoparasites.
 internal, 252, 253-268. *See also* Endoparasites.
 life cycles of, 252
 otic, topical medications for, 206-207
 zoonotic, 252
 Parasitiasis, 251, 252
 Parasitosis, 251, 252
 Parasympathetic (cholinergic) nervous system, 70, 72, 75
 drugs acting on, 78-79
 drugs blocking action in, 79
 effector organs of, 75, 76f, 77f
 functions of, 75
 neurotransmitters of, 78
 preganglionic and postganglionic fibers of, 75, 77f
 receptors of, 77, 78
 Parasympathomimetic agents, 70, 78-79
 Paravertebral block, 293
 Paregoric, for treatment of diarrhea, 87, 162
 Parenteral hemostatic agents, 332-333
 Parenteral medications, 2, 7-8, 28, 29
 administration of, 2, 7-8, 28, 29, 38-40
 calculations for, 58-62, 65-68
 common complications after, 40

- Parenteral medications (*Continued*)
 needle gauge in, for specific species, 30t
 procedures for, 40-47
 bolus using indwelling intravenous line, 43
 bolus using Y-injection site, 45
 inhalation medication, 46
 intramuscular or subcutaneous injection, 41, 46
 intravenous direct bolus, 42
 intravenous fluids, 44
 syringe and needle use in, 29, 32b-34b
 causing tissue irritation, 46TN
 components settling out in, 46TN
 dosage containers for, 29, 30f
 preservatives in, purpose of, 35
- Parenteral nutrition, 319
- Parenteral vitamin/mineral products, 319-320
- Parietal cell(s), 150
 activation of, 158
- Paroxetine, 96
- Partition coefficient, 2
 of anesthetic gas, 90
- Parts, expression of concentration in, 59
- Parts per million (ppm), 59
- Passive immunity, 349
 vaccines that produce, 353
- Pavulon (pancuronium bromide), 94
- Paxil (paroxetine), 96
- Penicillamine, as antidote to copper and lead poisoning, 378-379, 379TN
- Penicillin binding proteins, 229
- Penicillin G
 avoiding subcutaneous injection of, 232TN
 dosage forms of, 231-232
- Penicillin G benzathine, 230t
 avoiding subcutaneous injection of, 232TN
- Penicillin G potassium, 230t
- Penicillin G procaine, 230t
- Penicillin G sodium, 230t
- Penicillin V, 230t
- Penicillins, 229-231, 229-232
 adverse effects of, 232
 beta-lactamase resistant, 229, 230t
 broad spectrum, 230t-231t
 contraindication to use of, 232TN
 dosage forms of, 231-232
 narrow spectrum, 230t
 pharmacodynamics of, 229, 231
- Penicillins (*Continued*)
 pharmacokinetics of, 229
 potentiated, 231t
 precautions in using, in allergic animals, 232TN
 preparations of (including indications and antagonists), 230t-231t
 tubular secretion of, inhibitor of, 231t
 withdrawal times for, 231-232, 232TN
- Pentacocine, 88, 287
- Pentobarbital sodium, 85
 classification of, and duration of action, 85t
 as euthanasia agent, 97
 recovery from, 85TN
 for seizure prevention, and control, 89
- Pentolair (cyclopentolate hydrochloride), 198
- Pentosan polysulfate sodium, 126
- Pentothal (thiopental), 85, 85t
- Pentylene-tetrazol, 94
- Pepcid (famotidine), 159
- Pepcid AC (famotidine), 159
- Pepcid IV (famotidine), 159
- Pepto-Bismol (bismuth subsalicylate), 162
- Percent, calculation of, 54
- Percent concentration, in solution, 59-60
 calculation examples of, 59-60
- Perccorten-V, 292
- Perfusion, 104
- Periactin (cyproheptadine), 110
- Perioceutic agents, 169
- Peripheral nervous system, 70-71
 subdivisions of, 71-72
- Peristalsis, 150, 152, 153f
- Permethrin Spray, 273
- Permethrin, 272, 272TN, 273
- Pet-Derm III, 292
- Petrolatum, as intestinal lubricant, 164
- Petroleum distillate, as solvent for pyrethrins and pyrethroids, 275
- Petroleum jelly
 contraindication to, around vesicant, 23
 contraindication to, as lubricant, 382TN
- P.G. 600 (chorionic gonadotropin), 177
- Pharmaceutical aids. *See* Inactive (inert) ingredients.
- Pharmaceutical companies, for veterinary drugs, 416t
- Pharmaceutical drug interaction, 16
- Pharmacodynamic drug interaction, 16
- Pharmacodynamic information resources, 414t
- Pharmacodynamics, 13-15
- Pharmacokinetic drug interaction, 15-16
- Pharmacokinetic information resources, 414t
- Pharmacokinetics, 5-13, 5f
 biotransformation in, 11-13
 dosage and patient response in, 5-6, 6f
 drug absorption in, 8-10
 drug administration routes in, 6-8
 drug distribution in, 10-11
- Pharmacology, 1-2
 calculations in, 53-68. *See also* Calculation(s).
 drug interactions in, 15-16
 drug sources and ingredients of pharmaceuticals in, 3
 pharmacodynamics in, 13-15
 pharmacokinetics in, 5-13
 pharmacotherapeutics in, 3-5
 references on, 24
 review questions on, 25-26
- Pharmacotherapeutics, 3-5
 Phenazopyridine, 125
- Phenergan (promethazine), 108, 157, 289
- Phenobarbital, 84-85
 for behavior modification in self-licking, 223
 classification of, and duration of action, 85t
 for seizure prevention, and control, 89
- Phenol Red Thread (PRT) test, 202
- Phenolics, as disinfectants, 245t, 246-247
- Phenothiazine derivatives, 82
 as antiemetic drugs, 156
 contraindication to, within 30 days of organophosphate treatment, 82TN
 tranquilizing effect of, in excited animal, 82TN
- D-Phenothrin, 273
- Phenoxybenzamine
 action of, and indications, 126t
 for urinary retention treatment, 122

- Phenylbutazone, 282-283, 283TN
preparations of, 283
prohibited use of, as extralabel drug, 22
- Phenylcyclidine, 86
- Phenylephrine, 80
as decongestant, 110
as mydriatic agent, 196
- Phenylpropanolamine, 80
action of, and indications, 126t
as decongestant, 110
- Phenylzone Paste (phenylbutazone), 283
- Phenytoin sodium, for seizure prevention, and control, 89
- Pheromones, 183-184
- Phosmet, 273
- Phosphodiesterase inhibitors, 109
- Phospholipase, 291
- Photosensitivity, 15
- Physicians GenRx, web site, 415t
- Physiologic saline, 313
- Physostigmine, 79
- Phytonadione, 333, 333TN, 380
- Pilling difficult animals, 37TN
- Pilling gun, small animal, 36f
procedure for use, 36
- Pilocar (pilocarpine), 78
- Pilocarpine, 78, 198-199
- Piloptic (pilocarpine), 199
- Pilostat (pilocarpine), 199
- Pimobendan, 137
- Pimozide, as antiemetic, 158
- Pindolol, for arrhythmias, 140
- Pip-Pop 320, 263
- Pipa-Tabs, 263
- Piperacillin, 231t
- Piperazine, 263
- Piperonyl butoxide, 274, 274TN
- Pitressin (vasopressin), 123
- Pituitary gland, 173-174
hormones secreted by, 174-175, 175t
lobes of, 174f
- Plasma, 299, 300f
composition of, 300-301, 300t
drug level in, 10-11
- Plasma-Lyte, 314
- Plasma-Lyte M in 5% dextrose, 314
- Plasma volume expansion, colloid solutions for, 314-315
- Platinol (cisplatin), 341
- Platinum drugs, 341
- Poisoning antidotes, online resource, 415t
- Polishing paste, 169
- Poly Ox II Bolus, 163
- Polydipsia, 115
in diabetes insipidus, antidiuretic hormone for, 123
- Polyene antifungal agents, 242
- Polymixin B
and bacitracin, 240
in topical ophthalmic preparations, 203, 240
- Polysulfated glycosaminoglycans, 286, 370, 370TN
- Polyuria, 115
in diabetes insipidus, antidiuretic hormone for, 123
- Polyvalent vaccines, 349, 353-354
- Ponazuril, 264
- Pontocaine (tetracaine), 201
- Pontocaine hydrochloride (tetracaine hydrochloride), 201
- Posilac (bovine somatotropin), 191
- Postanesthetics, opioids as, 87
- Postganglionic axon (nerve fiber), 75, 76f, 77f
- Potassium chloride, as supplement in fluid therapy solutions, 316, 316TN, 317t
- Potassium citrate, 124
- Potassium-sparing diuretics
for hypertension associated with renal dysfunction, 120-121
use of, in combination with other diuretics, 121TN
- Potassium supplementation guide, 317t
- Potency, drug, 14
- Poultry, vaccinations and preventive health program for, 364
- Povidone iodine solution
as disinfectant, 246
as ophthalmic antifungal agent, 202
- Powder formulation, 35
- Pralidoxime, as antidote to organophosphates, 79, 261TN, 378, 378TN
- Pramoxine HCl, as antipruritic, 216
- Praziquantel, 264
- Praziquantel/pyrantel pamoate/febantel, 263, 263TN
- Prazosin, 81, 122, 143
combination of, with diuretics, 122TN
- Preamesthetics
cholinergic blocking agents as, 79
opioid agonists as, 87-88
romifidine as, 84
- Precipitant agent(s), 16, 16t
- Preclinical (animal safety) trials, of new drugs, 21
- Pred Forte prednisolone, 203
- Predef, 292
- Prednisolone
for allergic respiratory conditions, 111
for chemotherapy, 341
in combination, as antitussive, 108
for inflammatory bowel disease, 167
- Prednisolone acetate drops, 203
- Prednisolone generic tablets, 292
- Prednisolone sodium phosphate drops, 203
- Prednisolone sodium succinate, 111
- Prednisone
for allergic dermatologic conditions, 220
for chemotherapy, 339t, 341
- Prednisone generic tablets, 292
- Preganglionic axon (nerve fiber), 75, 76f, 77f
- Preliminary trials, of new drugs, 21
- Preload, 130, 133
increased, in heart failure, 141
- Premature ventricular contractions (PVCs), 130
treatment of, 139
- Prescribing drugs, versus dispensing drugs, 23
- Prescription(s), for medication, 48, 49f
- Prescription diets, for sodium restricted patients, 145
- Prescription drug, 2, 3-4
- Preservatives, in drug formulations, 4t, 35
contraindications to, in fluid therapy for cats or dogs, 314TN
for vaccines, 35TN, 349
- Pressure administration cuff, 309, 309f
- Prevacid (lansoprazole), 160
- Preventic Tick Collar for Dogs, 274
- Preventive health programs. See Vaccination(s).
- Previcox Chewable Tablets (firocoxib), 286
- Prilosec (omeprazole), 160
- Primary hypothyroidism, 173, 185
- Primatene (ephedrine), 110
- Primidone, for seizure prevention, and control, 89
- Primor Tablets, 241
- Pro-Banthine (propantheline), 79, 122, 157, 162
- Pro-Bute (phenylbutazone), 283

- Probahist Syrup, 110, 289
 Proban Tablets and Liquid, 273
 Probenicid, 231t
 Probiotics, 168
 Procainamide, 139
 Procainamide derivatives, as
 antiemetics, 156-157
 Procaine HCl, 294
 Procarbazine, for chemotherapy, 340t,
 342
 Prochlorperazine
 as antiemetic, 156
 and isopropamide, 82, 156
 Procrit (epoetin alpha), 124, 328
 Proline solution, 221
 Productive cough, 102, 105
 as indication for expectorant, 105
 Proestrus, 176
 Profenal (suprofen), 203
 Profender (emodepside/praziquantel),
 264
 Progesterone
 as hyperglycemic agent, 189-190
 in promoting weight gain in
 ruminants, 190-191
 Progesterone/estradiol implant,
 190-191
 Progestins, 179-180, 180TN
 Proglycem (diazoxide), 189-190
 Program 6 Month Injectable for Cats,
 271
 Program Suspension, 271
 Program Tablets, 271
 ProHeart (moxidectin), 266t, 267,
 268TN
 Prokinetics and stimulants,
 gastrointestinal, 164-165
 acetylcholinesterase inhibitors, 166
 cholinergics, 78, 165-166
 dopaminergic antagonists, 165
 motilin-like drugs, 165
 serotonergic agents, 165
 Prolaxis Paste, 168
 Prolactin (LTH), 174
 Prolamine (phenylpropanolamine), 80
 Promace (acepromazine maleate), 82
 Promazine HCL, 82
 ProMeris (metaflumizone), 272
 ProMeris Duo (metaflumizone/
 amitrac), 272
 Promethazine, 289
 as antiemetic in motion sickness,
 157
 with dextromethorphan, 108
 Pronestyl (procainamide
 hydrochloride), 139
 Propanion, 168
 Propantheline, 79
 action of, and indications, 126e
 as antiemetic, 157
 in promoting urine retention, 122
 for treatment of diarrhea, 162
 Proparacaine hydrochloride, 201,
 201TN
 Propionibacterium acnes, 344, 365t,
 366
 Propionic acid derivatives, 284-285
 Propofol (propofol), 93
 Propofol, 92-93, 93TN
 Proportion(s)
 calculations involving, 54
 problems using, 63
 Propoxur, 273
 Propranolol, 81
 for cardiac arrhythmias, 140
 contraindication to, in overt heart
 failure, 140TN
 for hypertension in renal
 insufficiency, 122
 precautions in discontinuation of
 therapy with, 140TN
 preoperative administration of, to
 cats, 186
 Proprietary name, of drug, 17
 Propulsid (cisapride), 165
 Propylene glycol, as topical antiseptic,
 217
 Propylthiouracil, 186
 Prostaglandin(s), 180-182, 278, 279,
 291
 and influence on gastrointestinal
 system, 154
 for stimulation of uterine
 contractions, 183
 topical, for treatment of glaucoma,
 200
 Prostaglandin E-1 analogs, 161
 ProstaMate (dinoprost
 tromethamine), 181
 Prostigmine (neostigmine), 78-79
 Protamine sulfate, 332
 Protectants
 gastrointestinal, 162-163
 in wound dressing, 220, 220TN
 Protective reflexes, of upper
 respiratory tract, 104
 Protex-Bb vaccine, 351
 Proton pump inhibitors, 160
 Protopam (pralidoxime), 79, 378
 Protozoal infections, 264
 drugs effective against, 167, 264-265
 Proudsoff, 223
 Proventil (albuterol), 80, 109
 Provera tablets (medroxyprogesterone
 acetate), 180
 Prozac (fluoxetine), 96
 PRT (Phenol Red Thread) test, 202
 Pruritis, 211, 288
 antihistamines for, 288-289, 289TN
 fatty acid supplements for, 221-222
 phenothiazine derivatives for, 82
 topical medications for, 216-217
 Pseudoephedrine, as decongestant, 110
 Psyllium preparations, 163-164
 Pupil dilation, cholinergic blocking
 agents for, 79
 Purina Cattle Dust, 273
 Purina Veterinary Diets DH, 168
 Pustular dermatitis, superficial,
 antiseborrheic agents for, 214t,
 215
 Pyoben Gel and Shampoo, 215
 Pyoderma, 211
 deep, antiseborrheic agents for,
 214t, 215
 Pyopen (carbenicillin), 231
 Pyrantel pamoate, 261-262
 Pyrantel tartrate, 261-262
 Pyrazolone derivatives, 282-283,
 283TN
 Pyrethrins
 for flea and tick control, 272
 for otic ectoparasites, 207
 synergists with, 274, 274TN
 Pyrethroids, synthetic, for flea and
 tick control, 273, 273TN
 synergists with, 274, 274TN
 Pyridostigmine, 79
 Pylamine maleate, preparations of,
 110, 289
 Pyrogen, 279
 PZI (Protamine Zinc Insulin),
 188-189
 PZI Vet, 188-189, 188t
Q
 Q-Cide, 247
 Quarternary ammonium compounds,
 as disinfectants, 245t, 247
 Quest 2% Equine Oral Gel
 (moxidectin), 262
 Quinaglate DuraTabs (quinidine
 gluconate), 138
 Quinidex Extentabs (quinidine
 sulfate), 138
 Quinidine, 138
 dosage reduction, in animals being
 treated with digoxin, 138TN
 Quinora (quinidine sulfate), 138

- R**
- Rabies control, information resource on, 415t
- Rabies vaccine, and vaccination certificate of, 398f
- record keeping of, 397
- Raboral V-RG vaccine, 352
- Radioactive iodine, in treatment of hyperthyroidism, 186
- Ralgro beef cattle implant (zeranol), 191
- Ralgro feedlot lamb implant (zeranol), 191
- Ranitidine, 159, 166, 289
- advantage of, over cimetidine, 159TN
- Rapinivet (propofol), 93
- Ratio(s)
- calculations involving, 54
- problems using, 63
- Re-Sorb, 319
- Receptor(s), 73
- on cell membrane, 13-14, 15f
- in effector organs, 77-78
- Recombinant DNA technology, 349, 352
- Recombinant interferon, 244, 343
- Recombinant vaccines, 352
- Reconcile (fluoxetine), 96
- Reconstitution, of medication
- with preservatives, precautions in, 35TN
- procedure for, 29, 31f
- ReCovr (triplelenamine HCl), 110, 289
- Reduction, chemical, 11
- Reflex arc, 73-75, 74f
- Regimen, 2
- details of, 3
- Regional anesthesia, 278
- Reglan (metoclopramide), 78, 156-157, 165
- Regressin-V, 366
- Regu-Mate (altrenogest), 180
- Regular insulin, 188
- Regulatory agencies
- for animal health products, 19-20, 20f
- veterinary and animal health, 114t
- Regurgitation, 150
- Releasing hormones, 173, 174
- Relief brand preparations, 216
- Renal and urinary tract disorders, 118-120
- client education about, 127
- drugs used for, 114-116
- Renal and urinary tract disorders (Continued)
- adrenergic antagonists, 122
- amitriptyline, 125-126
- angiotensin converting enzyme inhibitors, 123
- anticholinergic agents, 121-122
- antidiuretic hormone, 123
- azodyl, 127
- calcium channel blockers, 123
- cholinergic agonists, 121
- diuretics, 120-121
- epakitin, 126
- pentosan polysulfate sodium, 126
- phenazopyridine, 125
- references on, 127
- review questions on, 127-128
- urinary acidifiers, 123-124
- urinary alkalinizers, 124
- vasodilators, 123
- xanthine oxidase inhibitors, 124
- Renal failure, 119-120
- acute, fluid therapy for, 306t
- chronic, fluid therapy for, 306t
- pharmacotherapy for complications of, 124
- Renal insufficiency, 118-119. *See also*
- Renal and urinary tract disorders.
- drugs contraindicated in, 119b
- drugs for therapy in, 114-116
- for hypertension, 120-121, 122-123
- drugs not contraindicated in, 119b
- drugs requiring dosage modifications in, 119b
- Renal system, and urinary tract, anatomy and physiology of, 115-119
- Renin-angiotensin system, 141, 142f
- Reorder log, 394, 394TN, 396f
- Repellants, insect, 274
- Repolarization, of cardiac muscle cell, 130, 132, 132f
- Reproduction, hormonal drugs associated with, 177-184
- drugs affecting uterine contractility, 182-183
- gonadotropins and gonadal hormones, 177-180
- pheromones, 183-184
- prostaglandins, 180-182
- Reproductive system, hormonal control mechanisms of, 176-177, 176f
- Research information, resources, 415t
- ResiCHLOR, 218
- Residue(s), 2, 13
- ResiHIST, 217
- ResiPROX, 217
- ResiSOOTHE, 216
- Resmethrin, 273
- Respiratory depression, stimulant agents for, 93-94
- Respiratory secretions, control of, 104-105
- Respiratory system, 102-104, 103f
- Respiratory system disorders. *See also*
- Respiratory therapeutics.
- drugs used in, 101-102
- antihistamines, 110, 288-289
- antitussives, 106-108
- bronchodilators, 108-110
- corticosteroids, 110-111
- decongestants, 110
- expectorants, 105
- mucolytics, 106
- references on, 111
- review questions on, 112-113
- stimulants, 110
- inhalation therapy for, 105
- Respiratory therapeutics, 104-105
- Restraint facilitation, 81
- dissociative agents for, 86
- romifidine for, 84
- tranquilizers in, 82-83
- xylazine hydrochloride in, 83
- Reticular activating system, 74-75
- Reticular formation, 74-75, 74f
- Revalor S (trenbolone/estradiol implant), 191
- Reversal agent(s)
- for alpha adrenergic agonists, 381, 381TN
- for benzodiazepine overdose, flumazenil, 380-381
- for medetomidine, atipamezole, 81, 84, 380, 380TN
- for narcotic overdose, naloxone, 88, 89, 155TN, 381, 381TN
- for xylazine overdose, 81, 381, 381TN
- Reverse sneeze, 102, 104, 288
- Revolution (selamectin)
- for flea control, 269t, 272, 272TN
- for preventing nematode infection, 266t, 268, 268TN
- Rheumatoid arthritis, corticosteroid action in, 291
- Rickettsial infections, tetracyclines for, 235
- Rifadin Powder, 241
- Rifampin, 241

- Rifampin Capsules, 241
 RigiCare fluid therapy bottles, 310f
 Rimadyl (carprofen), 285
 Ringer's solution, 314
 Rintal (febantel), 262
 Ritrol, 319
 RM Recombitek C4 vaccine, 352
 RM Recombitek Lyme vaccine, 352
 Robamox (amoxicillin), 231
 Robaxin-V (methocarbamol), 289
 Robenidine hydrochloride, 264
 Robenz Type A Medicated Article, 264
 Robinul-V (glycopyrrolate), 79
 Robitussin-AC (guaifenesin), 105
 Robitussin-DM (dextromethorphan and guaifenesin), 108
 Rocaltrol, 124
 Roccal-D Plus, 247
 Rodenticide poisoning
 (anticoagulant), Vitamin K1
 antidote to, 380
 Roferon-A, 343
 Romazicon (flumazenil), 381
 Romifidine, 84
 Rompun (xylazine hydrochloride), 83
 Rose bengal ophthalmic stain, 202
 Rotenone, 274
 for ear mites, 207, 274
 Round worms. *See* Nematodes.
 Royal Canin Veterinary Diet, 168
 Rubella Virus Immunomodulator,
 365t
 Rulax II, 160
 Rumatel (morantel tartrate), 261-262
 Rumen acidosis, treatment of, 160
 Ruminants. *See also* Cattle; Sheep.
 hormones increasing weight gain
 in, 190-191
- S**
 S-Adenosylmethionine (SAME), 372
 Safeguard (fenbendazole), 253
 Salicylates, 282, 282TN
 Salicylic acid, in antiseborrheic
 products, 213, 215TN
 Saline solution compositions,
 302t-303t, 313-314, 315
 Saliva, excretion of metabolites in, 13
 Salmeterol, as bronchodilator, 109
 SAME (S-adenosylmethionine), 372
 Sandimmune (cyclosporine), 204
 Sandostatin (octreotide), 189
 Saponated cresol, as disinfectant,
 245t, 246-247
 Sarcoptic mange, selamectin in
 prevention of, 266t, 268, 268TN,
 269t
 Saturated solution, 59
 Scar tissue, formation of, 218-219
 Scarlet Oil, 219
 Schirmer Tear Test, 202
 Schnauzer comedo syndrome,
 antiseborrheic agents for, 214t, 215
 Sciatic nerve, avoiding, in
 intramuscular injection, 39f
 Scolaban (burnamidine), 263
 Scopalamine, 79
 SebaLyt Shampoo, 213
 Sebolux Shampoo, 213
 Seborrhea, 211, 215
 Seborrhea oleosa, 211
 Seborrhea sicca, 211
 antiseborrheic agents for, 214t, 215
 sulfur in medications for, 213
 Seborrheic dermatitis, 211
 systemic corticosteroids for, 220
 Secretin, 153-154
 Sedation, 81
 in ancillary treatment of heart
 failure, 145
 barbiturates for, 84-85
 dissociative agents for, 86
 opioids for, 87
 tranquilizers for, 82-84
 Sedazine (xylazine hydrochloride), 83
 Sedivet (romifidine), 84
 Segmentation, 150, 152, 153f
 Seizure prevention, and control, 81
 barbiturates for, 84-85, 89-90
 benzodiazepine derivatives for,
 82-83, 89-90
 client noncompliance in failure of,
 90TN
 contraindicated drugs in, 90TN
 treatment of, 89-90
 Selamectin
 for flea control, 269t, 272, 272TN
 for preventing nematode infection,
 266t, 268, 268TN
 Seldane (terfenadine), 110, 289
 Seleen Plus Medicated Shampoo, 215
 Selegiline, 97
 Selenium, and vitamin E, 286
 Selenium sulfide, in antiseborrheic
 medications, 215, 215TN
 Selentrol solution (dirloptapide), 168
 Seletoc (selenium and vitamin E),
 286
 Self licking. *See* Canine acral lick
 dermatitis; Feline psychogenic
 alopecia.
 Selsun Blue Shampoo, 215
 Selsun Shampoo, 215
 Sensory neuron(s), 73
 Sentinel (milbemycin oxime), 266t,
 267, 267TN, 271, 271TN
 Septi-Serum, 353
 Septic shock, colloid solutions for,
 314-315
 Serevent (salmeterol), 109
 Sermion (nicergoline), 122
 Sernylan (phenylcyclidine), 86
 Serotonergic drugs, as gastrointestinal
 prokinetics, 165
 Serotonin, 75
 and behavioral pharmacotherapy, 95
 influence of, on gastrointestinal
 system, 154
 Serotonin receptor antagonists, as
 antiemetics, 158
 Serotonin reuptake inhibitors, 96
 Sertraline, 96
 Sevin Dust, 273
 Sevoflurane (SevoFlo), 92
 physical properties of, 91t
 SFO4 Stannous Fluoride Gel, 168
 Shampoos, for flea and tick control,
 270, 270TN
 Sheep, vaccinations and preventive
 health program for, 364-365
 Shin-O-Gel, 222
 Shock
 hemorrhagic or endotoxic
 corticosteroids for, 289-292
 fluid therapy for, 313-314, 315
 hypovolemic or septic, colloid
 solutions for, 314-315
 Short acting barbiturates, 84, 85
 Short acting insulin, 187-188, 188TN
 Sigma opiate receptors, 87
 Silvadene, 208
 Silver nitrate, as caustic, 223
 Silver nitrate sticks, 332
 Silver sulfadiazine, antibacterial and
 antifungal action of, 208
 Simplex IV set, 45, 46f
 Simplicef (cefepodoxime), 234
 Single-dose vial, 29, 30f
 Sinus bradycardia, cholinergic
 blocking agents for, 79
 Sirolimus, 345
 Skeletal muscle relaxant(s), 289
 guaifenesin as, 93
 methocarbamol as, 289
 neuromuscular blocking agents as,
 94-95
 Skin, anatomy and physiology of,
 211-213, 212f

- Skin disorders, 210-211
 drugs used for, 213-224
 antiseptics, 217-218
 astringents, 217
 caustics, 223
 counterirritants, 222-223
 fatty acid supplements, 221-222
 immunosuppressants, 223-224
 systemic corticosteroids, 220
 topical antibacterial agents, 220-221, 240
 topical antifungal agents, 221
 topical antipruritics, 216-217
 topical antiseborrheics, 213-215
 topical medications mixed with water, 215-216
 references on, 224
 review questions on, 225
 wound healing in, 218-220
- Skin turgor test, 305
- Skinfold dermatitis, antiseborrheic agents for, 214t, 215
- Sleepaway (pentobarbital sodium), 97
- Slip tip syringe, 32f
- Slo-bid (theophylline), 109
- SLUD mnemonic, 70
- Small diameter nerve fibers, 73
- Sneezing, controlling agents for, 105.
 See also Vasoconstriction.
- SOA/Sex, 183
- Soaps, disinfecting, 247-248
- Sodium bicarbonate, 315-316, 316TN
 for management of urolithiasis, 124
- Sodium hypochlorite, as disinfectant, 246
- Sodium hypochlorite solution, 0.5%, 219
- Sodium phosphate salts, as laxative, 163
 contraindication to, in cats, 163TN
- Sodium restriction, in cardiovascular disease, 145
 client education about, 145TN
- Sodium thiosulfate, for cyanide poisoning, 379, 379TN
- Solfoton. See Phenobarbital.
- Soloxine (levothyroxine sodium), 184
- Solu-Delta-Cortef (prednisolone sodium succinate), 111
- Solute(s), 59, 299
 in body water, 300-301, 300t
 milliequivalent concentration of, in electrolyte preparations, 61-62, 301
 percent concentration of, and calculations, 59-60
 ways of expressing, 59
- Solution(s), 59, 300-301
 definition of, 59
 drug concentration in, calculations, 59
 electrolyte concentration in, calculations, 61, 301
 in fluid therapy, 302t-303t. See also Fluid therapy.
 for IV administration, calculations, 61-62, 67-68
 percent concentration of drug in, calculations, 59-60
 saturated, 59
- Solvent(s), 59
 in drug formulations, 35
- Somatic nervous system, 71, 75
- Somatotropin. See Growth hormone.
- Sotalol, for arrhythmias, 140
- Spansule, 10
- Sparine (promazine hydrochloride), 82
- Spasgessic, 289
- Spastic neuropathic bladder, 125
- Spectinomycin, 240, 240TN
- Speculum, 28. See also Fick speculum.
- Spinal cord, 74f. See also Central nervous system.
- Spinal reflex, 73, 74f
- Spinosaad, 272
- Spinose ear tick, 207
- Spironolactone, 121, 144
- Sporanox Capsules (itraconazole), 243
- Sporicidal agent, 227
- Spotton (fenthion), 273
- Sputolin (dembrexine), 106
- Squalene, 206, 208
- Stadol (butorphanol), 287
- Stairstep method, of converting metric units, 56f
- Stanisol, 217
- Stanozolol, 191-192, 192TN
- Staphage Lysate (SPL), 365t, 366
- Staphylococcal protein A, as immunostimulant, 344
- Staphylococcus phage lysate, 365t, 366
- Starvation, fluid therapy for, 306t
- Steady state, 6
- Steers, growth hormone implants for, 190-191
- Stiglyn (neostigmine), 78-79
- Stiglyn injection (neostigmine methylsulfate), 166
- Stimulants
 of central nervous system, 81, 93-94
 of respiratory system, 111
- Stimuli and impulse formation, in sensory neuron, 73
- Stomach tube, large animal, oral administration of liquid medication, 37, 38f
- Stool softeners, 164
- Storage instructions, on drug labeling, 18, 50TN
- Storage of drugs, appropriate, 50TN, 399
- Stoxil (idoxuridine), 202
- Streptase (streptokinase), 333
- Streptokinase, 333
- Streptomycin, 236t
- Stress response, 290-291
- Stroke volume, of left ventricle, 130, 133
 increased, as compensatory mechanism, 133
- Strongid-T (pyrantel pamoate), 261-262
- Struvite urolith prevention, 123-124
- SU-PER Poultry, 222
- SU-PER Sweat, 222
- Subcutaneous (SC) injection, 7, 38, 40f
 of fluid therapy, 307-308
 procedure for, 41, 46
- Subdural administration, 7, 8
- Sublimase (fentanyl), 88
- Succinylcholine chloride, 94
- Sucostrin (succinylcholine chloride), 94
- Sucralfate, as gastromucosal protectant, 160-161, 161TN
- Sudafed (pseudoephedrine), 110
- Sulf/OxyDex Shampoo, 215
- Sulfabromomethazine, prohibited use of, as extralabel drug, 22
- Sulfacetamide, in topical ophthalmic preparations, 203
- Sulfadimethoxine, 264
 prohibited use of, as extralabel drug, 22
- Sulfaethoxypyridazine, prohibited use of, as extralabel drug, 22
- Sulfasalazine, for inflammatory bowel disease, 167
- Sulfonamides, 241, 241TN
 prohibited use of, for lactating dairy cattle, 22
- Sulfur, in shampoos and ointments, 213, 213TN
- SuperChar-Vet Powder and Liquid, 162
- Superoxide dismutase, 372

- Supersaturated solution, 59
 Suprofen, 203
 Surfack (docusate sodium), 164
 Surfactant(s), 102, 103-104
 as stool softeners, 164
 Surgical Absorbable Hemostate, 332
 Suspension(s), 28, 29
 definition of, 59
 Sustain III Cattle Bolus, 241
 Sweat, excretion of metabolites in, 13
 Sweetening agents, 4t
 Swine, vaccinations and preventive
 health programs for, 364-365, 364b
 Symbiosis, 251
 Symbiotic relationships, 251-252
 Sympathetic (adrenergic) nervous
 system, 70, 72, 75
 drugs acting on, 80
 drugs blocking action in, 80-81
 effector organs of, 75, 76f, 77f
 functions of, 75
 neurotransmitters of, 77
 preganglionic and postganglionic
 fibers of, 75, 77f
 receptors of, 75, 77, 77f, 78
 Sympathomimetic agents. *See*
 Adrenergic agonists.
 Symptomatic method, of drug choice, 3
 Synalar Cream, 292
 Synalar Otic Solution, 292
 Synanthic (oxfendazole), 253
 Synapse(s)
 in central nervous system, 73
 ganglionic, 70
 between neurons, 72-73, 72f
 Syncro-Mate-B (norgestomet), 180
 Syncurine (decamethonium), 94
 Synergists, with pyrethrins, 274, 274TN
 Syno-Flex, 372
 Synotic (DMSO and steroid), 284
 Synovex C (estradiol/progesterone
 implant), 190-191
 Synovex H (estradiol/testosterone
 implant), 190
 Synovex S (estradiol/testosterone
 implant), 190-191
 Synthetic progestins, in behavioral
 pharmacotherapy, 97
 Synthroid (levothyroxine sodium),
 184
 Syringe(s), 32b-33b
 needle attached to, 32f
 reading medication amount in, 33b,
 33f-34f
 tips available on, 32f
 Syrup(s), 29
 Syrup of ipecac, 155, 155TN
T
 T-61 (euthanasia agent), 97
 T₃ (liothyronine sodium), 185
 T₄ (levothyroxine sodium), 184-185
 Tablet(s), 28-29, 29f
 coating, with palatable substances,
 37TN
 oral administration, to dogs and
 cats, 36-37, 36f, 37f
 scored or unscored, 28, 29f
 Tachyarrhythmia(s), 130, 134, 138
 Tachycardia, 130
 Tacrolimus, 345
 Tagamet (cimetidine), 159
 Tail gland hyperplasia, 215
 Taktic, 274
 Talwin (pentazocine), 88
 Talwin-V (pentazocine), 88, 287
 Tanisol, 217
 Tanni-Gel, 217
 Tapazole (methimazole), 185
 Tapeworms. *See* Cestodes.
 Task (dichlorvos), 261
 Tavist (clemastine), 110
 Tazicef (ceftazidime), 234
 Tazidime (ceftazidime), 234
 TBW (total body water), 299-300
 TBZ (thiabendazole), 253
 T.D.N. MiniRockets, 168
 T.D.N. Rockets, 168
 Teat Infusion Cannula, for oral
 administration of liquid
 medication, 38TN
 Tegopen (cloxacillin), 231
 Telazol (tiletamine HCl), 86
 Telmin (mebendazole), 253
 Telmintic (mebendazole), 253
 Telodendra, 72, 72f
 Temaril-P (trimeprazine and
 prednisolone), 108, 111
 Temaril-P Tablets, 292
 Temperature equivalents, Fahrenheit/
 Celsius, 412t
 Tempra (acetaminophen), 284
 Tenormin (atenolol), 140
 Tensilon (edrophonium), 78
 Tepoxalin, 286
 Terbutaline, 80
 as bronchodilator, 109
 Terfenadine, 110, 289
 Terminal bronchioles, 103f
 Terminator, 273
 Terramycin dosage forms, 235
 Testosterone
 for weight gain in ruminants,
 190-191
 in weight gain products,
 classification as controlled
 substance, 179TN
 Testosterone cypionate, 178-179
 action of, and indications, 126t
 Testosterone enanthate, 124, 178-179
 Testosterone propionate, 178-179
 action of, and indications, 126t
 Tetanus antitoxin, 353
 Tetracaine, and tetracaine
 hydrochloride
 antimicrobial activity of, 201TN
 injectable preparations of, 295
 as topical ophthalmic anesthetics,
 201
 Tetracycline, 235, 235t
 Tetracycline preparations, 234-236,
 235t
 administration notes on, 236TN
 adverse effects of, 235, 236TN
 clinical uses of, 235
 contraindication to, in horses,
 236TN
 pharmacodynamics of, 234-235
 pharmacokinetics of, 234
 Tetrahydropyrimidines, 261-262,
 262TN
 Tetramethrin, 273
 Thalamus, 74, 74f
 Theo-Dur (theophylline), 109
 Theophylline, 109-110
 interaction of, with other
 commonly used drugs, 110TN
 Therabloat, 167
 Therapeutic drug monitoring, 6
 information resources for, 414t
 Therapeutic index, of drug, 14
 Thiabendazole, 253
 Thiamine hydrochloride (vitamin
 B1), 320, 380
 Thiazide diuretics, 144
 for hypertension associated with
 renal dysfunction, 120
 precaution in use, in crossing
 placental border, 120TN
 Thickening agents, 4t
 Thimerosal, 248
 Thiobarbiturates, 84-85, 85TN
 Thiola (tiopronin tablets), 124
 Thiopental, 85
 classification of, and duration of
 action, 85t

- Thoracocentesis, in ancillary treatment of heart failure, 145
 Thorazine (chlorpromazine), 82, 156
 Thorazine Spansule, 156
 Three-way valves, operation of, 312, 313f
 Thrombocytopenia, 326, 330
 Thromboembolism, 326, 330
 Thrombogen Topical Thrombin Solution, 332
 Thrombolytic drugs, 333
 Thromboxane, 332
 Thrombus, 326
 Thuja-Zinc Oxide Ointment, 220
 Thyro-Form (levothyroxine sodium), 184
 Thyro-L (levothyroxine sodium), 184
 Thyro-Tab (levothyroxine sodium), 184
 Thyroid hormones, 184-186
 for hyperthyroidism, 185-186
 for hypothyroidism, 184-185
 regulatory actions of, 184
 Thyroid stimulating hormone (TSH), 174-175, 185
 target and actions of, 175t
 Thyrotropin, 185
 Thyroxine, 184
 Thyroxine Tablets (levothyroxine sodium), 184
 Thytropar (thyrotropin), 185
 Ticarcillin, 231t
 dosage forms of, 232
 Ticks, 268
 ear, medications for, 207
 environmental control products for, 270-271
 insecticides effective against, 272-275
 monthly application products for controlling, 271-272
 prediluted sprays for, 268, 270, 270TN
 products for, comparison of, 269t
 removing, client education about, 207TN
 Tigan (trimethobenzamide HCl), 157
 Tiletamine HCl, 86, 86TN
 Timolol maleate, 81
 contraindications to use of, 199TN
 for treatment of glaucoma, 199
 Timoptic (timolol maleate), 81, 199
 Tiopronin tablets, 124
 Tissuemend, 220
 Tobramycin, 236t
 in topical preparation for conjunctivitis, 203
 Tocainide, for arrhythmias, 139
 Tofranil (imipramine), 96
 Tolazoline, 381, 381TN
 Tolnaftate cream, 221
 Tonicity, of body fluids, 301, 304
 Topical anesthetics, ophthalmic, 201
 Topical corticosteroids, 292
 Topical hemostatic agents, 332
 Topical medications
 application of, 8, 47-48
 formulations for, 35
 Topical wound spray, 218
 Torbugesic (butorphanol), 87-88, 106, 287
 Torbutrol (butorphanol), 87-88, 106, 287
 Total body water (TBW), 299-300, 300f
 Total nutrient admixture (TNA), 299, 319
 Total parenteral nutrition (TPN), 319
 Toxiban preparations, 162, 376
 Toxoid vaccines, 352-353
 Trachea. *See* Respiratory system.
 Tracrium (atracurium), 95
 Trade name, of drug, and location on label, 17
 Traditional Chinese Medicine (TCM), 373
 Tramadol, 287
 Tramisol (levamisole), 262
 Tranquillizer(s), 82-84
 as alpha blockers, 81
 benzodiazepine derivative, 82-83
 detomidine, 83
 medetomidine, 84
 phenothiazine derivative, 82
 romifidine, 84
 xylazine, 83
 D-trans allethrin, 273
 Transcellular fluid, 299
 Transdermal administration, of drug, 278
 Transduction, of noxious stimuli, 278, 279-280, 280f
 Travoprost (Travatan), 200
 Trematodes, 251
 drugs effective against, 263-264
 Trenbolone/estradiol implant, 190-191
 Trenbolone implant, 190-191
 Tressderm, 206, 207
 Tri-Otic, 206
 Triamcinolone, for allergic respiratory conditions, 111
 Triamcinolone Tablets, 292
 Triaminic Expectoant (guaifenesin), 105
 Triamterene, 121
 Tribissen 48% Injection, 241
 Trichlorfon, 261
 Tricyclic antidepressants, 96
 for behavior modification aids in skin disorders, 223
 for pain relief, 288
 Trifluridine, 202
 Trimeprazine tartrate, and corticosteroid, 108
 Trimethobenzamide HCl, as antiemetic in motion sickness, 157
 Tripelennamine HCl, 110, 289
 Tris-EDTA, 208
 Tritop, 206
 Tropic hormones, 173, 174
 Tropicacyl (tropicamide), 198
 Tropicamide, as mydriatic agent, 198
 Trovac-AIV H5 vaccine, 352
 Trusopt (dorzolamide), 199
 TSH. *See* Thyroid stimulating hormone.
 Tuberculin syringe, 32b-33b
 with needle attached, 32f
 d-Tubocurarine chloride, 94
 Tubular reabsorption, 12, 116, 118, 118f
 Tubular secretion, 116, 118, 118f
 of drug metabolites, 12, 12f, 118
 Tulathromycin, 239
 Tumul-K, 319
 Tumor, definition of, 333
 Turgor, 299
 Tussion (hydrocodone bitartrate), 88
 Tylan, 239
 Tylenol (acetaminophen), 284
 Tylenol with Codeine, 287
 Tylocine, 239
 Tylosin, 239
 Tyloxin, for chronic colitis, 167TN
 Type I recombinant vaccines, 352
 Type II recombinant vaccines, 352
 Type III recombinant vaccines, 352
U
 U/ml (units of insulin per milliliter), 187
 Ulcers. *See* Gastric ulcers.
 Ultrashort acting barbiturates, 85

- United States Pharmacopeia (USP)
 logo of, 371f
 web site of, 372
- Unknown quantity (X), 55
- Upper motor neurons, 115
 lesions of, in spastic neuropathic bladder, 125
- Upper respiratory system, 102-103
- Upper respiratory tract, physiology of, 103
- Urecholine (bethanechol), 78, 121
- Uremia, 115, 119
- Urethral obstruction, fluid therapy for, 306t
- Urethral sphincter, hypertonus of, 122
- Urinary acidifiers, 123-124
 and acidifying diets, precautions for clients about, 124TN
- Urinary alkalizers, 124
- Urinary bladder. *See also* Renal system, and urinary tract.
 neurogenic and nonneurogenic disorders of, 125
- Urinary incontinence, 115, 125
 drugs for management of, 125, 126t
 anticholinergic, 121-122
 neurogenic and nonneurogenic causes of, 125
- Urinary obstruction, functional
 alpha adrenergic agents for, 122, 125
 feline, phenoxybenzamine for, 81, 122
- Urinary output, agents increasing, 121
- Urinary retention, 125
 alpha adrenergic agents for, 122
 cholinergic agents for, 78, 121
- Urinary tract analgesics, 125
- Urinary tract infection, 115
 ruling out, in urinary incontinence, 125
- Urine, formation of, 116-119, 117f
- Urocit K (potassium citrate), 124
- Uroese (ammonium chloride), 123
- Urogenital system
 of bull, 116f
 of female dog, 115f
 of male cat, 116f
 of male dog, 116f
- Urokinase, 333
- Urolithiasis, drugs for management of, 123-124
- Urticaria, with acute allergic reactions, 288
- U.S. Dept. of Agriculture (USDA), 414t
 and regulation of animal health products, 19-20, 20f
 review of new drug application by, 21
- Uterine contractility, drugs affecting, 182-183
- Uvea, 196
- Uveitis, 196
 corticosteroid action in, 291
 homatropine hydrobromide for, 198
- V**
- Vaccination(s), 349-350, 350f
 administration of vaccine in, 46, 350, 350f, 354
 adverse responses to, 355-356
 client education about, 349, 355
 of food animals, 350, 354
 information resources on, 415t
 in preventive health programs, 356-365
 beef cattle, 361b-362b
 bovine, 358, 363-364
 canine, 356, 357b-358b
 dairy cattle, 363b
 equine, 356, 359b
 feline, 356, 358, 360b-361b
 poultry, 364
 sheep, 364
 small ruminants, 364-365
 swine, 364-365, 364b
 protocols for, 350
 purposes of, 349
 references on, 366
 review questions on, 367-368
 sarcomas associated with, 350
 and transfer of antibodies to offspring, 349
- Vaccine(s), 349
 for active immunity, 351-353
 administration of, 46, 350, 350f, 354
 antitoxin, 353
 appropriate handling and storage of, 355
 autogenous, 353
 inactivated, 351
 live, 351
 mixed, 353-354
 modified live, 351-352
 for passive immunity, 353
 recombinant, 352
 reconstitution of, 354
 references on, 366
 review questions on, 367-368
 toxoid, 352-353
- Vaccines
 information resources about, 415t
- Valacyclovir, 244
- Valbazen (albendazole), 253, 264
- Valium (diazepam), 82-83, 89, 95-96
- Valvular disease, of heart, 133-134
- Vanceryl (beclomethasone dipropionate), 111
- Vancomycin, 240
- Vapona (dichlorvos), 273
- Vapor pressure, of anesthetic gas, 90
- Vasoconstriction, adrenergic agents promoting, 80
- Vasodilators, 81
 action of, in heart failure, 141
 for hypertension in cardiovascular disease, 141-143
 for hypertension in renal insufficiency, 123
- Vasopressin, 175
 for polydipsia and polyuria in diabetes insipidus, 123
 target and actions of, 175t
- Vasotec injection, for IV use, 143
- Vasotec tablets, 143
- Vatronol (ephedrine), 80
- Vazepam (diazepam), 82-83
- VCPR. *See* Veterinarian-client-patient relationship.
- Vecuronium bromide, 95
- Vedalyte 8X, 319
- Velosef (cephradine), 234
- Ventilation, 104
 intermittent positive pressure, 105
- Ventipulmin syrup (clenbuterol), 109
- Ventolin (albuterol), 109
- Verapamil
 for arrhythmias, 141
 for hypertension in renal insufficiency, 123
- Versed (midazolam), 82
- Vesicant(s), 222-223, 326
- Vesication, 222-223
- Ver-Shield 72, 202
- Vetalar (Ketamine HCl), 86
- Vetalog, 111, 220
- Vetalog Cream, 217, 292
- Vetalog Oral Powder/Tablets, 292
- Vetalog Parenteral, 292
- Vetaplasma (oxypolygelatin), 315
- Veterinarian-client-patient relationship (VCPR), 2
 conditions of, 4
 educational aspects of, 50. *See also* Client education.
 validity of, in prescribing controlled substances, 420
- Veterinary associations, 414t

- Veterinary Feed Directive, 23
 Veterinary pharmaceutical companies, 416t
 Veterinary supply distributors, 403-404
 Veterinary technician
 drug administration by, 5
 education of
 about drugs and drug administration, 50
 resources for, 414t
 importance of, in veterinary medicine, 2. *See also* Client education.
- Vetmedin Chewable Tablets (pimobendan), 137
 Vetrepolycin, 203
 Vetsulin, 188-189, 188t
 Vial(s), single dose and multidose, 29, 30f
 Vibo-5/Somnugen, 351
 Vibramycin (doxycycline), 235
 Vinblastine, 339t, 341
 Vincristine, 339t, 341
 Vinorelbine, 339t, 341
 Viokase -V powder (pancrelipase), 166
 VIP Flea Control Shampoos, 275
 VIP Flea Dip, 275
 VIPPS, 24
 Viroptic ophthalmic solution (trifluridine), 202
 Virosan solution, 247
 Virulence, of infectious agent, 349, 351
 Viscidity, of secretion, 102, 105
 Vitamin(s)
 fat-soluble, 321
 water-soluble, 320-321
 Vitamin B complex, 320, 320TN
 Vitamin B1, 320
 Vitamin B12, 320-321
 Vitamin D, 321
 Vitamin D supplements, 124
 Vitamin E, 321
 Vitamin K, 321
 Vitamin K1, 333, 333TN
 as antidote to anticoagulant rodenticide poisoning, 380
 as antidote to coumarin derivatives, 331TN
 Vitamin/mineral products, parenteral, 319-320
 Voice production, 104
 Voltaren (diclofenac sodium), 203
- Volume control system, in fluid therapy administration, 310, 311f, 312f
 Volume equivalents, metric-apothecary, 58b, 412t
 Volume-per-volume (v/v) expression, of drug concentration, 59
 Volume units, in metric system, 55t
 Voluntary control, of nervous system, 71
 Vomiting, 154
 fluid therapy for, 306t
 induction of, agents for, 150, 154, 154f
 apomorphine, 88, 154-155
 syrup of ipecac, 155
 xylazine hydrochloride, 83, 155
 treatment of, agents for, 155-158
 antihistamines, 157, 288, 289
 butyrophenones, 158
 cholinergic blocking agents, 79, 157-158
 metoclopramide, 78, 156-157
 NK-1 receptor antagonists, 158
 phenothiazine derivatives, 82, 156
 serotonin receptor antagonists, 158
 Vomiting center, 150, 154, 154f
- W**
 Warfarin, 331
 Wartsoff, 223
 Water soluble vitamins, 320-321
 Weight
 apothecaries', table of, 412t
 avoirdupois, table of, 412t
 metric-apothecary equivalents, 58b, 412t
 Weight gain, implants promoting, 180, 190-191
 Weight loss
 and debilitation, anabolic steroids for, 191-192
 products promoting, 167-168
 Weight-per-volume (w/v) expression, of drug concentration, 59-60
 Weight-per-weight (w/w) expression, of drug concentration, 59
 Weight-to-body surface area conversion chart, 335t
 Weight units, in metric system, 55t
 White Liniment, 222
- Wildnil (carfentanil), 88
 WinGel, 160
 Winstrol-V (stanozolol), 191, 328
 Withdrawal time, 2
 Wound cleansers, 219-220
 precautions in administration of, 220TN
 Wound dressings, topical, 219
 cleansers used before, 219-220
 healing stimulators in, 219
 protectants in, 220
 Wound healing, 218-219
- X**
 X (unknown quantity), 55
 Xalatan (latanoprost), 200
 Xanax (alprazolam), 82-83, 95-96
 Xanthine oxidase inhibitors, 124
 Xenodine Spray, 218
 Xenodyne, 208
 Xylazine, and butorphanol, as neuroleptanalgesic, 89
 Xylazine hydrochloride, 83
 concentrations of, for large and small animals, 83TN
 as emetic, 83, 155
 extralabel use of, 83
 tolazoline as antidote to, 381, 381TN
 yohimbine as antidote to, 81, 381, 381TN
- Y**
 Y-injection site, 45, 45f
 Yard & Kennel Spray, 273
 Yard sprays, for flea and tick control, 270
 Yohimbine (Yobine), for xylazine overdose, 81, 111, 381, 381TN
- Z**
 Zantac (ranitidine), 159
 Zeniquin (marbofloxacin), 238
 Zeranol, for weight gain in ruminants, 190-191
 Zeranol implant, 190-191
 Zinc Oxide, and healing stimulator, 219
 Zithromax (azithromycin), 239
 Zofran (ondansetron), 158
 Zoloft (sertraline), 96
 Zoonotic parasites, 252
 Zovirax (acyclovir), 244
 Zubrin (tepozalin), 286
 Zylprim (allopurinol), 124

This page intentionally left blank