

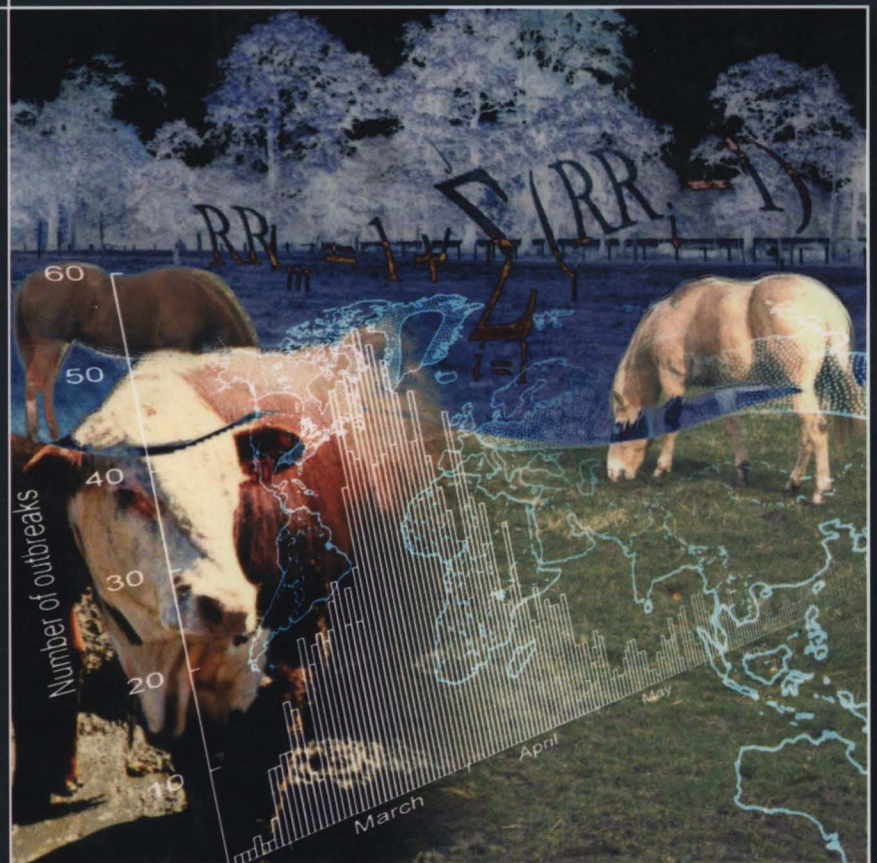

# VETERINARY EPIDEMIOLOGY

THIRD EDITION



MICHAEL THRUSFIELD

 Blackwell  
Publishing

# **Veterinary epidemiology**

*Third edition*



# **Veterinary epidemiology**

---

THIRD EDITION

**Michael Thrusfield**

*Veterinary Clinical Studies*

*Royal (Dick) School of Veterinary Studies*

*University of Edinburgh*

**Blackwell**  
Science



First edition © 1986 by Butterworth & Co. (Publishers) Ltd  
Second edition © 1995 by Blackwell Science Ltd  
Third edition © 2005, 2007 by Blackwell Science Ltd, a Blackwell Publishing company

Editorial offices:

Blackwell Science Ltd, 9600 Garsington Road, Oxford OX4 2DQ, UK  
Tel: +44 (0) 1865 776868  
Blackwell Publishing Professional, 2121 State Avenue, Ames, Iowa 50014-8300, USA  
Tel: +1 515292 0140  
Blackwell Science Asia Pty, 550 Swanston Street, Carlton, Victoria 3053, Australia  
Tel: +61 (0)3 8359 1011

The right of the Author to be identified as the Author of this Work has been asserted in accordance with the Copyright, Designs and Patents Act 1988.

All rights reserved. No part of this publication may be reproduced, stored in a retrieval system, or transmitted, in any form or by any means, electronic, mechanical, photocopying, recording or otherwise, except as permitted by the UK Copyright, Designs and Patents Act 1988, without the prior permission of the publisher.

Designations used by companies to distinguish their products are often claimed as trademarks. All brand names and product names used in this book are trade names, service marks, trademarks or registered trademarks of their respective owners. The Publisher is not associated with any product or vendor mentioned in this book.

This publication is designed to provide accurate and authoritative information in regard to the subject matter covered. It is sold on the understanding that the Publisher is not engaged in rendering professional services. If professional advice or other expert assistance is required, the services of a competent professional should be sought.

First published 1986 by Butterworth & Co. (Publishers) Ltd  
Second edition published 1995 by Blackwell Science Ltd  
Reissued in paperback with updates 1997  
Reprinted 1999, 2000, 2001, 2003 (twice)  
Third edition published 2005  
Reissued in paperback with updates 2007  
2 2008

ISBN: 978-1-405-15627-1

Library of Congress Cataloging-in-Publication Data (from the hardback third edition)  
Thrusfield, M.V.

Veterinary epidemiology / Michael Thrusfield. — 3rd ed.

p. cm.

Includes bibliographical references and index.

ISBN-13: 978-0-632-06397-0 (hardback : alk. paper)

ISBN-10: 0-632-06397-1 (hardback : alk. paper)

1. Veterinary epidemiology. I. Title.

SF780.9.T48 2005

636.089'44—dc22

2005 004 105

A catalogue record for this title is available from the British Library

Set in 10/12pt Palatino  
by Graphicraft Ltd, Hong Kong  
Printed and bound in Great Britain  
by TJ International Ltd, Padstow, Cornwall

The publisher's policy is to use permanent paper from mills that operate a sustainable forestry policy, and which has been manufactured from pulp processed using acid-free and elementary chlorine-free practices. Furthermore, the publisher ensures that the text paper and cover board used have met acceptable environmental accreditation standards.

For further information on Blackwell Publishing, visit our website:  
[www.blackwellpublishing.com](http://www.blackwellpublishing.com)

**To Marjory and Harriet, and in memory of David**



# Contents

---

<i>From the preface to the first edition</i>	xii	Evans' rules	37
<i>From the preface to the second edition</i>	xiii	Variables	38
<i>Preface to the third edition</i>	xiv	Types of association	38
1 The development of veterinary medicine	1	<i>Confounding</i>	40
Historical perspective	1	Causal models	40
<i>Domestication of animals and early methods of healing</i>	1	Formulating a causal hypothesis	42
<i>Changing concepts of the cause of disease</i>	2	<i>Methods of deriving a hypothesis</i>	43
<i>Impetus for change</i>	4	<i>Principles for establishing cause: Hill's criteria</i>	44
<i>Quantification in medicine</i>	10	4 Describing disease occurrence	46
Contemporary veterinary medicine	11	<i>Some basic terms</i>	46
<i>Current perspectives</i>	11	<i>Basic concepts of disease quantification</i>	49
<i>The fifth period</i>	16	The structure of animal populations	50
Recent trends	16	<i>Contiguous populations</i>	50
2 The scope of epidemiology	22	<i>Separated populations</i>	52
Definition of epidemiology	22	Measures of disease occurrence	53
The uses of epidemiology	23	<i>Prevalence</i>	53
Types of epidemiological investigation	25	<i>Incidence</i>	53
<i>Epidemiological subdisciplines</i>	26	<i>The relationship between prevalence and incidence rate</i>	56
Components of epidemiology	28	<i>Application of prevalence and incidence values</i>	57
<i>Qualitative investigations</i>	28	Mortality	57
<i>Quantitative investigations</i>	28	Survival	58
Epidemiology's locale	32	<i>Example of calculation of prevalence, incidence, mortality, case fatality and survival</i>	60
<i>The interplay between epidemiology and other sciences</i>	32	Ratios, proportions and rates	61
<i>The relationship between epidemiology and other diagnostic disciplines</i>	32	<i>Displaying morbidity and mortality values and demographic data</i>	65
<i>Epidemiology within the veterinary profession</i>	33	Mapping	65
3 Causality	34	<i>Geographic base maps</i>	67
Philosophical background	34	<i>Geographical information systems</i>	69
Causal inference	35	5 Determinants of disease	75
Methods of acceptance of hypotheses	36	<i>Classification of determinants</i>	75
Koch's postulates	37	Host determinants	78
		Genotype	78
		Age	79

<i>Sex</i>	79	<i>Trends in the temporal distribution of disease</i>	144
<i>Species and breed</i>	80	<i>Short-term trends</i>	144
<i>Other host determinants</i>	81	<i>Cyclical trends</i>	144
<i>Agent determinants</i>	82	<i>Long-term (secular) trends</i>	145
<i>Virulence and pathogenicity</i>	82	<i>True and false changes in morbidity and mortality</i>	146
<i>Gradient of infection</i>	85	<i>Detecting temporal trends: time series analysis</i>	146
<i>Outcome of infection</i>	86	<i>Trends in the spatial and temporal distribution of disease</i>	150
<i>Microbial colonization of hosts</i>	87	<i>Spatial trends in disease occurrence</i>	150
<i>Environmental determinants</i>	88	<i>Space-time clustering</i>	151
<i>Location</i>	88		
<i>Climate</i>	88	9 The nature of data	152
<i>Husbandry</i>	90	<i>Classification of data</i>	152
<i>Stress</i>	91	<i>Scales (levels) of measurement</i>	153
<i>Interaction</i>	92	<i>Composite measurement scales</i>	155
<i>Biological interaction</i>	93	<i>Data elements</i>	156
<i>Statistical interaction</i>	94	<i>Nomenclature and classification of disease</i>	156
<i>The cause of cancer</i>	95	<i>Diagnostic criteria</i>	157
6 The transmission and maintenance of infection	98	<i>Sensitivity and specificity</i>	158
<i>Horizontal transmission</i>	98	<i>Accuracy, refinement, precision, reliability and validity</i>	159
<i>Types of host and vector</i>	98	<i>Bias</i>	160
<i>Factors associated with the spread of infection</i>	100	<i>Representation of data: coding</i>	161
<i>Routes of infection</i>	103	<i>Code structure</i>	162
<i>Methods of transmission</i>	105	<i>Numeric codes</i>	162
<i>Long-distance transmission of infection</i>	106	<i>Alpha codes</i>	163
<i>Vertical transmission</i>	110	<i>Alphanumeric codes</i>	164
<i>Types and methods of vertical transmission</i>	110	<i>Symbols</i>	165
<i>Immunological status and vertical transmission</i>	110	<i>Choosing a code</i>	165
<i>Transovarial and trans-stadial transmission in arthropods</i>	110	<i>Error detection</i>	166
<i>Maintenance of infection</i>	111		
<i>Hazards to infectious agents</i>	111	10 Surveillance	168
<i>Maintenance strategies</i>	112	<i>Some basic definitions and principles</i>	168
7 The ecology of disease	116	<i>Definition of surveillance</i>	168
<i>Basic ecological concepts</i>	116	<i>Goals of surveillance</i>	169
<i>The distribution of populations</i>	116	<i>Types of surveillance</i>	169
<i>Regulation of population size</i>	120	<i>Some general considerations</i>	171
<i>The niche</i>	123	<i>Sources of data</i>	173
<i>Some examples of niches relating to disease</i>	124	<i>Mechanisms of surveillance</i>	179
<i>The relationships between different types of animals and plants</i>	126	<i>Surveillance networks</i>	179
<i>Ecosystems</i>	130	<i>Surveillance in developing countries: participatory epidemiology</i>	179
<i>Biotope</i>	130	<i>Techniques of data collection</i>	184
<i>Types of ecosystem</i>	130	<i>Strengths and weaknesses of participatory epidemiology</i>	186
<i>Landscape epidemiology</i>	132	<i>Some examples of participatory epidemiology</i>	186
<i>Nidality</i>	132		
<i>Objectives of landscape epidemiology</i>	133	11 Data collection and management	188
8 Patterns of disease	137	<i>Data collection</i>	188
<i>Epidemic curves</i>	137	<i>Questionnaires</i>	188
<i>The Reed–Frost model</i>	140	<i>Quality control of data</i>	195
<i>Kendall's waves</i>	142	<i>Data storage</i>	196

<i>Database models</i>	196	<i>Parametric and non-parametric techniques</i>	249
<i>Non-computerized recording techniques</i>	197	<i>Hypothesis testing versus estimation</i>	249
<i>Computerized recording techniques</i>	198	<i>Sample size determination</i>	250
<i>Data management</i>	201	<i>Statistical versus clinical (biological) significance</i>	250
<i>Changing approaches to computing</i>	201	<i>Interval and ratio data: comparing means</i>	252
<i>The Internet</i>	203	<i>Hypothesis testing</i>	252
<i>Veterinary recording schemes</i>	204	<i>Calculation of confidence intervals</i>	252
<i>Scales of recording</i>	204	<i>What sample size should be selected?</i>	253
<i>Veterinary information systems</i>	205	<i>Ordinal data: comparing medians</i>	254
<i>Some examples of veterinary databases and information systems</i>	207	<i>Hypothesis testing</i>	254
		<i>Calculation of confidence intervals</i>	257
12 Presenting numerical data	214	<i>What sample size should be selected?</i>	258
Some basic definitions	214	<i>Nominal data: comparing proportions</i>	258
Some descriptive statistics	215	<i>Hypothesis testing</i>	258
<i>Measures of position</i>	216	<i>Calculation of confidence intervals</i>	261
<i>Measures of spread</i>	216	<i>What sample size should be selected?</i>	261
Statistical distributions	217	$\chi^2$ test for trend	262
<i>The Normal distribution</i>	217	Correlation	263
<i>The binomial distribution</i>	218	Multivariate analysis	264
<i>The Poisson distribution</i>	218	Statistical packages	265
<i>Other distributions</i>	218		
<i>Transformations</i>	219	15 Observational studies	266
<i>Normal approximations to the binomial and Poisson distributions</i>	219	Types of observational study	266
Estimation of confidence intervals	220	<i>Cohort, case-control and cross-sectional studies</i>	266
<i>The mean</i>	220	<i>Ecological studies</i>	269
<i>The median</i>	221	Measures of association	269
<i>A proportion</i>	221	<i>Relative risk</i>	269
<i>The Poisson distribution</i>	221	<i>Odds ratio</i>	270
<i>Some epidemiological parameters</i>	222	<i>Attributable risk</i>	272
<i>Other parameters</i>	223	<i>Attributable proportion</i>	273
<i>Bootstrap estimates</i>	223	Interaction	274
Displaying numerical data	224	<i>The additive model</i>	275
<i>Monitoring performance: control charts</i>	224	Bias	276
		<i>Controlling bias</i>	278
13 Surveys	228	What sample size should be selected?	281
Sampling: some basic concepts	228	Calculating the power of a study	282
Types of sampling	229	<i>Calculating upper confidence limits</i>	283
<i>Non-probability sampling methods</i>	230	Multivariate techniques	284
<i>Probability sampling methods</i>	230	<i>The logistic model</i>	284
What sample size should be selected?	232		
<i>Estimation of disease prevalence</i>	232	16 Clinical trials	289
<i>Detecting the presence of disease</i>	238	<i>Definition of a clinical trial</i>	289
<i>The cost of surveys</i>	242	Design, conduct and analysis	291
Calculation of confidence intervals	242	<i>The trial protocol</i>	291
		<i>The primary hypothesis</i>	291
14 Demonstrating association	247	<i>The experimental unit</i>	293
Some basic principles	247	<i>The experimental population</i>	294
<i>The principle of a significance test</i>	247	<i>Admission and exclusion criteria</i>	294
<i>The null hypothesis</i>	248	Blinding	294
Errors of inference	248	Randomization	295
One- and two-tailed tests	248	Trial designs	296
Independent and related samples	249	What sample size should be selected?	297
		Losses to 'follow-up'	298

<i>Compliance</i>	298	<i>Process simulation modelling</i>	346
<i>Terminating a trial</i>	299	<i>Monte Carlo simulation modelling</i>	347
<i>Interpretation of results</i>	299	<i>Matrix population modelling</i>	349
<i>Meta-analysis</i>	300	<i>Network population modelling</i>	351
<i>Goals of meta-analysis</i>	300	<i>Systems modelling</i>	352
<i>Components of meta-analysis</i>	301	The rational basis of modelling for active	
<i>Sources of data</i>	301	disease control	352
<i>Data analysis</i>	302	<i>Available knowledge, and the functions of</i>	
		<i>models</i>	352
17 Diagnostic testing	305	<i>From theory to fact</i>	353
<i>Serological epidemiology</i>	305	<i>Model-building</i>	354
<i>Assaying antibodies</i>	306	20 The economics of animal disease	357
<i>Methods of expressing amounts of antibody</i>	306	<i>Popular misconceptions</i>	357
<i>Quantal assay</i>	307	Economic concepts and principles	358
Serological estimations and comparisons in		<i>Disease as an economic process</i>	359
populations	308	Assessing the economic costs of disease	361
<i>Antibody prevalence</i>	308	<i>Optimum control strategies</i>	361
<i>Rate of seroconversion</i>	309	Cost–benefit analysis of disease control	363
<i>Comparison of antibody levels</i>	309	<i>Partial farm budgets</i>	363
Interpreting serological tests	311	<i>Social cost–benefit analysis</i>	364
<i>Refinement</i>	311	21 Health schemes	368
<i>Accuracy</i>	312	Private health and productivity schemes	368
Evaluation and interpretation of		<i>Structure of private health and productivity</i>	
diagnostic tests	313	schemes	368
<i>Sensitivity and specificity</i>	313	<i>Dairy health and productivity schemes</i>	370
<i>Predictive value</i>	316	<i>Pig health and productivity schemes</i>	372
<i>Likelihood ratios</i>	318	<i>Sheep health and productivity schemes</i>	373
<i>ROC curves</i>	321	<i>Beef health and productivity schemes</i>	375
<i>Aggregate-level testing</i>	323	National schemes	378
<i>Multiple testing</i>	323	<i>Accredited/attested herds</i>	378
<i>Diagnostic tests in import risk assessment</i>	325	<i>Health schemes</i>	378
<i>Guidelines for validating diagnostic tests</i>	327	Companion-animal schemes	379
<i>Agreement between tests</i>	327	22 The control and eradication of disease	384
Practical application of diagnostic tests	329	<i>Definition of ‘control’ and ‘eradication’</i>	384
18 Comparative epidemiology	331	<i>Strategies of control and eradication</i>	385
<i>Types of biological model</i>	331	<i>Important factors in control and eradication</i>	
Cancer	332	programmes	393
<i>Monitoring environmental carcinogens</i>	332	Outbreak investigation	398
<i>Identifying causes</i>	333	<i>Cause known: foot-and-mouth disease</i>	398
<i>Comparing ages</i>	334	<i>Cause unknown: chronic copper poisoning</i>	400
Some other diseases	336	Veterinary medicine in the 21st century	401
<i>Diseases with a major genetic component</i>	336	<i>Livestock medicine</i>	401
<i>Some non-infectious diseases</i>	337	<i>Companion-animal medicine</i>	402
<i>Diseases associated with environmental</i>		General reading	404
pollution	337	Appendices	406
Reasoning in comparative studies	338	Appendix I: Glossary of terms	407
19 Modelling	340	Appendix II: Basic mathematical notation and	
<i>Types of model</i>	341	terms	412
Modelling approaches	341	Appendix III: Some computer software	414
<i>Deterministic differential calculus modelling</i>	341		
<i>Stochastic differential calculus modelling</i>	344		
<i>Empirical simulation modelling</i>	345		



Appendix IV: Veterinary epidemiology on the Internet	418	Appendix XV: Probabilities associated with the upper tail of the Normal distribution	448
Appendix V: Student's $t$ -distribution	420	Appendix XVI: Lower- and upper-tail probabilities for $W_x$ , the Wilcoxon–Mann–Whitney rank-sum statistic	449
Appendix VI: Multipliers used in the construction of confidence intervals based on the Normal distribution, for selected levels of confidence	421	Appendix XVII: Critical values of $T^+$ for the Wilcoxon signed ranks test	454
Appendix VII: Values of exact 95% confidence limits for proportions	422	Appendix XVIII: Values of $K$ for calculating 95% confidence intervals for the difference between population medians for two independent samples	456
Appendix VIII: Values from the Poisson distribution for calculating 90%, 95% and 99% confidence intervals for observed numbers from 0 to 100	429	Appendix XIX: Values of $K^*$ for calculating 95% confidence intervals for the difference between population medians for two related samples	459
Appendix IX: The $\chi^2$ -distribution	431	Appendix XX: Common logarithms ( $\log_{10}$ ) of factorials of the integers 1–999	460
Appendix X: Technique for selecting a simple random sample	432	Appendix XXI: The correlation coefficient	462
Appendix XI: Sample sizes	434	Appendix XXII: Some veterinary observational studies	463
Appendix XII: The probability of detecting a small number of cases in a population	441	Appendix XXIII: The variance-ratio ( $F$ ) distribution	480
Appendix XIII: The probability of failure to detect cases in a population	443	Appendix XXIV: Risk analysis	482
Appendix XIV: Sample sizes required for detecting disease with probability, $p_1$ , and threshold number of positives (in brackets) (probability of incorrectly concluding that a healthy population is diseased [in square brackets])	444	References	503
		Index	593

# From the preface to the first edition

---

The common aim of the many disciplines that comprise veterinary medicine is an increase in the health of animal populations, notably of domestic livestock and companion animals. This goal has traditionally been achieved by individual diagnosis and treatment: procedures that evolved contemporaneously in veterinary and human medicine, when infectious diseases, which had predominantly single causes and clearly identifiable signs, were commonplace.

Four major changes in the veterinarian's appreciation of and approach to disease problems have occurred over the past 20 years. First, despite traditional control techniques, for example slaughter and vaccination, some diseases remain at refractory levels and now require continuous scrutiny to detect changing levels of occurrence associated with ecological and management factors. An example is the detection of 'pockets' of bovine tuberculosis in England in areas where infection of badgers is recorded. Secondly, the control of infectious disease has freed animals from major causes of death, thereby facilitating the emergence of non-infectious diseases as major problems: examples are the cardiac, dermal and renal diseases of dogs. Many of these diseases have a poorly understood, often complex (i.e., multifactorial) cause. Thirdly, the intensification of animal industries has highlighted new 'diseases of production', often manifested as poor performance, rather than clinical disease, and

frequently with multifactorial causes. Fourthly, economic evaluation has become important: the economic advantages of disease control, which are obvious with the major animal plagues such as rinderpest, can be difficult to identify when overt disease and dramatic changes in levels of performance are not involved. These four changes in the approach to, and appreciation of, disease have added momentum to the emergence of veterinary epidemiology as a discipline concerned with the measurement of the amount of disease and its economic effects, the identification and quantification of the effects of factors associated with disease, and the assessment of the effects of prevention and treatment of disease in groups of animals.

A knowledge of elementary statistics is essential for an understanding of the full range of epidemiological techniques. Hitherto, most epidemiology books either have assumed a knowledge of statistics or have avoided a description of the mathematical manipulations that are commonly used in epidemiology. However, the extent of statistical teaching varies widely between veterinary schools. Two chapters therefore are included as an introduction to basic statistics, and are intended to make this book statistically self-sufficient (though not comprehensive). Similarly, a chapter includes an introduction to computers, which are now used widely in the recording and analysis of epidemiological data.

# From the preface to the second edition

---

Since publication of the first edition, veterinary medicine has faced several new problems, and has been forced to evaluate established ones more critically. Bovine spongiform encephalopathy emerged as a serious problem in the United Kingdom. Rinderpest is still the subject of a global eradication campaign. There is an increasing demand for comprehensive, high-quality, technical and economic information on animal disease and productivity at the national and international level; and information systems, such as the United States' National Animal Health Monitoring System, have been designed to suit these requirements. The moves towards an open market, both in the European Union and internationally following the Uruguay round of the General Agreement on Tariffs and Trade, highlight the need for information on animal disease status in trading nations. Multifactorial diseases continue to predominate in intensive produc-

tion systems, and many companion animal diseases are similarly complex. The solving of these problems and fulfilling of these tasks rely heavily on epidemiological principles and techniques.

All chapters of the first edition have been revised. Chapter 11 has been modified to take account of the increasing popularity of microcomputers, and the rapid development of veterinary information systems. New chapters on clinical trials and comparative epidemiology have been added in response to suggestions from colleagues. More statistical methods are included in Chapters 12–15 and 17. The goal of this edition nevertheless remains the same as that of the first: to provide an introduction to veterinary epidemiology for veterinary undergraduates, postgraduates who have received limited or no training in epidemiology, and practising veterinarians and members of other disciplines with an interest in the subject.

# Preface to the third edition

---

The ten years since publication of the second edition have witnessed further expansion in the application of veterinary epidemiology. Quantitative methods have increased dramatically, both in their development and use. Evidence-based clinical veterinary medicine is now widely appreciated, and relies heavily on the results of epidemiological analyses, including observational studies, clinical trials and the quantitative interpretation of diagnostic tests. The successful employment of epidemiological techniques has witnessed continued progress in rinderpest eradication, whereas the epidemic of foot-and-mouth disease in Europe (notably in the UK) in 2001 presented fresh challenges.

All chapters from the second edition have been revised. Numerous topics (e.g., causality, now explicitly considered in Chapter 3) have been expanded in response to questions raised by undergraduates, postgraduates and professional colleagues, with the aim of consolidating the more enduring principles and concepts of epidemiology. Surveillance is now addressed specifically in Chapter 10. Chapter 17 has been enlarged in response to increased interest in diagnostic-test validation and performance. The opportunity also has been taken to correct several typographical errors that were present in the second edition. The text continues to be an introduction to veterinary epidemiology, directed at all with an interest in the subject.

My gratitude is again due to colleagues whose comments during the writing of this third edition have been invaluable. Michael Campbell and Janet Wittes held lively email discussions in relation to sample-size calculation for the comparison of two sets of ordinal data, and an appropriate method is now included in Chapter 14. Bruce Gummow provided additional information on the chronic copper poisoning incident

described in Chapter 22. Andrew Catley, Matthias Greiner, Sam Mansley, Andrew Paterson, Nick Taylor and David Whitaker criticized various parts of the text. I owe a particular debt of thanks to George Gettinby and Keith Howe, whose scholarship and guidance have been enthusiastically offered to me during the writing of all three editions of this book, and whose longstanding friendship is particularly cherished. Sally Macaulay typed several tables, and Rhona Muirhead again produced numerous figures. Susanna Baxter, Samantha Jackson and Emma Lonie of Blackwell Publishing, and Mary Sayers, assisted with conversion of the manuscript to published text. Finally, I am grateful to the Literary Executors of the late Sir Ronald A. Fisher FRS and the late Dr Frank Yates FRS, and to the Longman Group Limited, London, for permission to reprint Tables III, IV, V and VII from their book, *Statistical Tables for Biological, Agricultural and Medical Research* (6th edition, 1974).

## **Author's note on the paperback reissue**

The publication of this paperback edition has provided the opportunity to correct typographical errors. The 'Further reading' section of several chapters has also been expanded. The opportunity has also been taken to include an appendix on risk analysis (Appendix XXIV) in response to requests from readers. I am grateful to Stuart MacDiarmid and aforementioned colleagues for their perceptive comments on this addition.

Michael Thrusfield  
September  
2006

# 1

## The development of veterinary medicine

---

Veterinary epidemiology is concerned with disease in animal **populations**. Its evolution has spanned several centuries and has been central to the successful control of animal disease. This introductory chapter traces the development of veterinary medicine in general (including relevant aspects of human medicine), showing that it has been inseparably linked to that of veterinary epidemiology.

Although man's association with animals began in prehistoric times, the development of scientific veterinary medicine is comparatively recent. A milestone in this growth was the establishment of the first permanent veterinary school at Lyons, France, in 1762. Early developments were governed largely by economic rather than humanitarian motives, associated with the importance of domestic stock as a source of food and as working animals; and there are still important economic reasons for concern about disease in animal populations. Later, with the advent of the industrial revolution and the invention of the internal combustion engine, the importance of draft animals declined in the developed countries. Although dogs and cats have been companion animals for several thousand years, it is only recently that they and other pets have increased in importance as components of human society.

Until the last half of the 20th century, the emphasis of veterinary medicine had been on the treatment of individual animals with clearly identifiable diseases or defects. Apart from routine immunization and prophylactic treatment of internal parasites, restricted attention had been given to herd health and comprehensive preventive medicine, which give proper consideration to both infectious and non-infectious diseases.

Currently, the nature of traditional clinical practice is changing in all developed countries. The stock

owner is better educated, and the value of individual animals relative to veterinary fees has decreased. Therefore, contemporary large animal practitioners, if they are to meet modern requirements, must support herd health programmes designed to increase production by preventing disease, rather than just dispensing traditional treatment to clinically sick animals.

In the developing countries, the infectious diseases still cause considerable loss of animal life and production. Traditional control techniques, based on identification of recognizable signs and pathological changes, cannot reduce the level of some diseases to an acceptable degree. Different techniques, based on the study of patterns of disease in groups of animals, are needed.

Similarly, contemporary companion-animal practitioners, like their medical counterparts, are becoming increasingly involved with chronic and refractory diseases which can be understood better by an investigation of the diseases' characteristics in populations.

This chapter outlines the changing techniques of veterinary medicine by tracing man's attempts at controlling disease in animals, and introduces some current animal disease problems that can be solved by an epidemiological approach.

### Historical perspective

#### Domestication of animals and early methods of healing

The importance of animal healers has been acknowledged since animals were initially domesticated, when they were already likely to have been chronically affected by various infections (McNeill, 1977). The

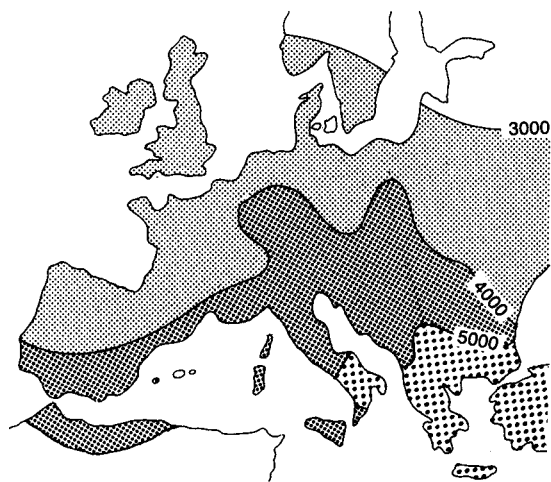

**Fig. 1.1** A generalized map to show the spread of farming from the Near East to Europe in years BC. (From Dyer, 1990.)

dog, naturally a hunter, was probably the first animal to be domesticated over 14 000 years ago when it became the companion of early hunters. Sheep and goats were domesticated by 9000 BC in the fertile Nile valley and were the basis of early pastoral cultures. A few of these societies have lasted, for example the Jews, but many were superseded by cattle cultures; in some the pig increased in importance (Murray, 1968). An Egyptian cattle culture evolved from 4000 BC, and farming spread from the Near East into Europe (Figure 1.1). There is archaeological evidence of cattle shrines in Anatolia dating back to 6000 BC (Mellaart, 1967). This record illustrates that animals had a religious as well as an economic significance in early civilizations. The aurochs was central to the religion of the Sumerians, who migrated throughout Asia, North Africa and Europe in the third millennium BC taking their animals and beliefs with them. India is the largest cattle culture that remains. Cattle cultures also persist in north-east Africa, the result of interaction between the Ancient Egyptians and early Nilotic tribes. Cattle still play important roles in these cultures: they are food, companionship, and status and religious symbols to the Suk (Beech, 1911) and Dinka tribes (Lienhardt, 1961) of the Sudan.

The first extensive colonization of the Eurasian steppe and semi-arid areas occurred in the third millennium BC. The horse provided the key to successful exploitation of the area north of the Black Sea, the Caucasus, and the Taurus and Zagros mountains (Barraclough, 1984), and a Eurasian horse culture, associated with warrior tribes, emerged (Simpson, 1951). Some of these tribes overran the older cattle cultures. The horse is represented in Iranian, Greek and Celtic pantheons. It has become a symbol of veterinary medicine in the form of a centaur, one of which,

Chiron, was considered to be the mythological founder of Greek medicine.

There have been several movements of animals with concomitant social and agricultural modifications since the early changes. The camel was introduced into Saharan Africa in the first century BC, and into the sub-Saharan region around AD 400 (Spencer and Thomas, 1978; Phillipson and Reynolds, 1996), the latter already having well established domestic cattle and goat populations (Cain, 1999; Tefera, 2004). The Spanish introduced cattle, sheep, pigs and goats to North America in the 16th century. Haired sheep were introduced to Africa by European slave traders. The Spanish brought turkeys to Europe from North America.

The early Egyptian healers combined religious and medical roles by being priest-healers, often associated with temples. Their therapeutic techniques are recorded in the veterinary *Papyrus of Kahun* (c. 1900 BC). Literary records of similar age, describing veterinary activities, are extant from other parts of the world, such as Indian Sanskrit texts from the Vedic period (1800–1200 BC).

## Changing concepts of the cause of disease

Concepts of the cause of disease have changed and evolved<sup>1</sup>. A method of treatment used by early Egyptians was incantation. This was partly ritual, but also reflected their belief in supernatural spirits as a possible cause of disease. Approaches to treatment and prevention are the direct result of theories of cause. There have been five main theories up to the middle of the last century<sup>2</sup>. One theory was often superseded by another, but traces of each can still be seen in different parts of the world.

## Demons

Early man attributed disease to supernatural powers, the product of animism which imbued all moving things with a spirit. In this 'spirit-world', disease could be produced by witches<sup>3</sup>, superhuman entities and spirits of the dead (Valensin, 1972). Treatment therefore included: placation, for example by sacrifice;

<sup>1</sup> Causality is outlined in this chapter specifically in the context of disease. A more general discussion is presented in Chapter 3.

<sup>2</sup> Theories of the cause of disease also have similarities with theories of the origin of species, and both have rationalistic and theological dimensions (Bullock, 1992).

<sup>3</sup> A witch was originally defined as 'one who by commerce with the Devil has a full intention of attaining his (or her) own ends' (Bodin, 1580). Witchcraft became widespread in Europe between the 12th and 18th centuries. In the depositions of witch trials, there are many examples of the supposed induction of disease and death in man and domestic animals by witches (L'Estrange Ewen, 1933).

exorcism (forcible expulsion); evasion, for instance scattering millet seeds to avoid vampires (Summers, 1961); and transference, often to human and animal 'scapegoats'<sup>4</sup>, probably the best known single example of which is the Gadarene swine (the *Bible*: Mark 5, i–xiii). The techniques included: ritual ceremonies; material objects that could be suspended (amulets and periapts), carried (talismans), hung in a building (fetishes and icons) or displayed in the community (totems); the use of special people such as witch doctors; and incantations. The meaning of the Indian word 'brahmin' originally was 'healer' because the brahmin were a class of healers. In the neolithic period (4200–2100 BC), trepanning (the removal of a bone disc from the skull) may have been practised to release demons from sick people.

During the 19th century, many European peasants still believed that diseases of cattle were caused by evil spirits, which could be kept at bay by fire (Frazer, 1890), and the African Nuer tribe occasionally still uses incantations during ritual sacrifice when cattle epidemics occur (Evans-Pritchard, 1956)<sup>5</sup>. Moreover, sacrifice was practised in England as late as the 19th century (Baker, 1974).

**Divine wrath**

The demonic theory involved many spirits; the next development, monotheistic in origin, argued that disease was the product of a displeased supreme being: disease was punishment. This belief is prominent in the Old Testament, for example the animal plague of Egypt (the *Bible*: Exodus 9, iii) and is also evident in Persian and Aztec writings. The only effective treatment of disease induced in this way was placation because exorcism and evasion would not be effective against a supreme being. Traces of this belief have persisted until recent times. The English veterinary surgeon, William Youatt, writing in 1835, supported the practice of burning crosses on the heads of cattle to cure and prevent disease. In 1865, Queen Victoria, believing that the current British rinderpest (cattle plague) outbreak was the result of divine displeasure, ordered that a prayer should be used in each church in England while the epidemic continued.

<sup>4</sup> The scapegoat had the dual purpose of averting and magically transferring guilt and evil, both generally and at a specific time of crisis, such as plague or failure of crops. It takes its name from the Hebrew rites of the Day of Atonement when a goat was driven into the wilderness after the High Priest had ritually confessed the sins of the people and transferred them to the goat. The custom occurs universally from Ancient Babylonian times to modern times, where human sacrificial scapegoats have been known in some tribal societies (Cooper, 1990).

<sup>5</sup> More recently, there has been a trend towards a contemporary understanding of disease (Hutchinson, 1996).

**Metaphysical medicine**

The next development did not assume the existence of a supreme being, either demonic or divine, but assumed the presence of occult forces beyond the physical universe. This 'metaphysical' medicine embodied a theory of natural laws but excluded scientific principles such as observation and the repeatability of phenomena. The moon, stars and planets were considered to affect health (Whittaker, 1960), these concepts being obvious predecessors of astrology. Several outbreaks of rinderpest in Dark Age Europe were ascribed to earthquakes, floods and comets.

Treatment frequently included particularly foul medicines and practices that persisted for many centuries. A recommended 17th century cure for broken wind in horses comprised toads, swallows and moles roasted alive and mixed with shoe soles. Divination, practised by the Babylonians using sheep livers, and the 'Doctrine of Signatures' which suggested a similarity between the disease and its cure – for example using toads to treat warts – were notable metaphysical developments.

**The universe of natural law**

A major intellectual revolution began in Greece in the sixth century BC in which the universe was rationalized without either demonic or metaphysical influences. The Greeks thought that disease was the result of derangement of four humours of the body, which were associated with four properties (heat, moisture, dryness and cold) and with four elements (air, earth, water and fire) (*Figure 1.2*). Diseases were considered to be caused by external forces, including climatic and geological changes that affected the

		CHARACTERISTIC	
		Moisture	Dryness
CHARACTERISTIC	Heat	Humour = Blood Associated element = Air Source = Heart Excess → Sanguine temperament	Humour = Yellow bile Associated element = Fire Source = Liver Excess → Choleric (bilious) temperament
	Cold	Humour = Phlegm Associated element = Water Source = Pituitary gland Excess → Phlegmatic temperament	Humour = Black bile Associated element = Earth Source = Spleen Excess → Melancholic temperament

**Fig. 1.2** Components of humoral pathology.



population. Local outbreaks of disease were thought to be the result of local eruptions of noxious air: **miasmata (miasmas)**<sup>6</sup>. The word 'malaria' literally means 'bad air' and hints at the 19th century belief that the disease was caused by stale air around swamps.

The concept of humoral derangement was reimported into mediæval Europe, via Sicily, during the Crusades, and food was imbued with the same properties as the humours (Tannahill, 1968). The concept persists in several cultures. In indigenous Indian Ayurvedic human and veterinary medicine, based on the Hindu Scriptures (Vedas), there are three humours (tridosha): vata (wind), pitta (bile) and kapha (phlegm); derangement of vata, for example, causing asthma and diarrhoea. This concept is also central to modern Mahayana Buddhist medicine. However, in Europe, the popularity of the miasmatic theory declined at the beginning of the 20th century, by which time the microbial theory of infectious disease was adequately supported.

The Greek idea of disease was susceptible to scientific investigation. Careful observation and the identification of specific causes became the hallmarks of the fifth century BC school of medicine at Cos, and were refined by Hippocrates whose text, *Discourse on Airs, Waters and Places* (Jones, 1923), dominated medicine for many centuries. Therapy was consistent with causal concepts, and included purges and alterations in diet.

### Contagion

The idea that some diseases can be transmitted from one animal to another has its ubiquitous origins in antiquity, and ancient veterinary accounts of disease provide strong evidence of the concept of contagiousness (Bodson, 1994). The Romans, Galen and Lucretius, believed that disease could be spread by airborne **seeds** or **animacula** (not necessarily living), which were taken in through the nose and mouth. The Jewish Talmud describes demons as hiding 'everywhere' – in water, crumbs and air – implying transmissibility. The primitive Hindus associated sick rats with human plague, the first suggestion of a zoonosis. The Veronan, Fracastorius, writing in the early 16th century, argued that diseases were transmitted by minute, invisible particles (Wright, 1930); and Lancisi, physician to Pope Clement XI, freed Rome from rinderpest by using a slaughter policy to prevent infection of unaffected animals. Thomas Lobb, writing in London in the 18th century, considered that human plague and rinderpest were caused by particles that multiplied in infected individuals and then infected

others, either by contact or through the air (Lobb, 1745). The 18th century American lexicographer and essayist, Noah Webster, classified diseases as miasmatic (e.g., pneumonia) or contagious (e.g., smallpox), representing an intermediate stage in the evolution of the contagion theory (Winslow, 1934).

The main advances in the identification of microbes as causes of infectious diseases occurred in the 19th century, although the concept of a living contagious agent, **contagium animatum**, was founded in the 17th century. Edward Jenner's development of a smallpox vaccine using cowpox-infective material, and early biological warfare conducted by American settlers who gave blankets belonging to smallpox victims to Indians as presents, implicitly recognized contagion.

Louis Pasteur's investigation of anthrax and rabies (Walden, 2003), and Robert Koch's discovery of the bacteria causing tuberculosis<sup>7</sup> and cholera (Münch, 2003), firmly established microbiology and marked the downfall of the miasmatic theory. The set of postulates formulated by Koch to define causal agents has been used to identify many microbial diseases since those early days of bacteriology (see Chapter 3).

Viruses were also discovered in the late 19th century, although not actually 'seen' until the invention of the electron microscope in the 1930s. In 1892, Iwanowsky demonstrated that tobacco mosaic disease could be transmitted by sap that had been filtered through bacteria-proof filters (Witz, 1998). Beijerinck serially transmitted the disease using bacteria-free filtrates, and coined the term **contagium vivum fluidum** to describe the infectious 'living' agent. In 1898–99 Loeffler and Frosch discovered the first animal virus, foot-and-mouth disease virus, and in 1911 Rous reported the first virus-induced transmissible tumour.

Towards the end of the 19th century, the first arthropod carrier (a tick) of an infectious disease was identified by Kilborne, Smith and Curtis, investigating Texas fever of cattle in the US.

### Impetus for change

Changing attitudes towards the cause of disease and the concomitant alterations in techniques of treatment and prevention are a small part of shifts in overall scientific thought. These changes have not taken place gradually, but have occurred as distinct 'revolutions', which terminate periods of stable science (Kuhn,

<sup>6</sup> This explains why urban Victorians draped thick curtains in their windows in an attempt to keep out disease.

<sup>7</sup> Anthrax and tuberculosis are diseases of great antiquity, dating back at least to Ancient Egypt, where the former bacterium was most likely the cause of some of the biblical plagues (Blaisdell, 1994; Willcox, 2002; Witowski and Parish, 2002; Sternbach, 2003).

1970<sup>8</sup>). Each period has its paradigm (model), which serves to guide research. As time passes, anomalies accumulate. Initially, scientists accommodate these by modifying the paradigm, but a time comes when the pressures on the old framework become so great that a crisis occurs, and there is a revolutionary shift in paradigms. For example, in astronomy, the old Ptolemaic model of the universe had to be modified and remodified by adding new planetary epicycles to account for the observed motion of the heavenly bodies, but eventually the critical point was reached when the old model was falling apart under the strain and was ceasing to be credible. Thus, the time was ripe for the dramatic shift in models called the Copernican revolution. Kuhn's thesis has also been applied to political, social and theological 'revolutions' (Macquarrie, 1978) and to the applied sciences (Nordenstam and Tornebohm, 1979) of which veterinary medicine is a part<sup>9</sup>.

Veterinary medicine has experienced five stable periods and revolutions up to the middle of the 20th century relating to disease control (Schwabe, 1982), which stimulated the changes in the causal concepts already described. The major problem that persisted during these periods, precipitating crises, was large-scale outbreaks of infectious disease: the classical animal plagues<sup>10</sup> (Table 1.1). Military campaigns frequently assisted the spread of these infections (Table 1.2 and Karasszon, 1988).

### The first period: until the first century AD

The initial domestication of animals brought man into close contact with animals and therefore with their diseases. The demonic theory was prevalent. However, despite the use of control techniques consistent with the theory, draft animals continued to die, and a crisis arose when urbanization increased the importance of animals as food resources. This resulted in the development of the first stable phase of veterinary medicine. This was characterized by the emergence of veterinary specialists such as the early Egyptian priest-healers and the Vedic *Salihotriya* who founded the first veterinary hospitals. Humoral pathology developed and

the miasmatic theory of cause evolved. Techniques of treatment required careful recognition of clinical signs following the Greek Coan tradition. Quarantine (derived from the Italian word meaning 'forty' – the traditional length, in days, of isolation in the Middle Ages) and slaughter became preventive strategies. These local actions, which lasted until the first century AD, were incapable of solving major problems in the horse, which was becoming an important military animal. This crisis resulted in the second phase: that of military healers.

### The second period: the first century AD until 1762

Veterinarians specialized in equine medicine and surgery, reflecting the importance and value of horses (e.g., Richards, 1954). A major veterinary text, the *Hippiatrika*, comprising letters between veterinarians, cavalry officers and castrators, dates from early Byzantine times. The major contributor to this work was Apsyrus, chief *hippiatros* to the army of Constantine the Great. This phase lasted until the mid-18th century and was marked by a continuing interest in equine matters. Several important texts were written, including Vegetius Renuatus' *Ars Veterinaria* (published in 1528) and Carlo Ruini's *Anatomy of the Horse* (published in 1598). Interest was taken in other species, too. The 15th century *Boke of Saint Albans* described diseases of falcons (Comben, 1969); and John Fitzherbert's *Boke of Husbandrie* (published in 1523) included diseases of cattle and sheep. The horse, however, was pre-eminent. This bias survived in Europe until early in the 20th century when equine veterinary medicine was still considered to be a more respectable occupation than the care of other species.

Varying emphasis was placed on the miasmatic and metaphysical theories of cause and on humoral pathology. The Arabians, for example, based their medicine largely on the metaphysical theory.

### The third period: 1762–1884

The animal plagues, especially those of cattle, became particularly common in Europe in the mid-18th century with the introduction of rinderpest from Asia (Scott, 1996). They provided the next major crisis involving civilian animals. The miasmatic theory persisted but the miasmata were thought to originate from filth generated by man, rather than from natural sources. A third stable phase developed, characterized by improvement of farm hygiene, slaughter and treatment as control techniques. When rinderpest entered England from Holland in 1714, Thomas Bates, surgeon to George I, advocated fumigation of buildings, slaughter and burning of affected animals, and resting of contaminated pasture as typical tactics

<sup>8</sup> For a critical assessment of Kuhn's philosophy, see Hoyningen-Huene (1993).

<sup>9</sup> The concept of dramatic paradigm shifts, however, may not be applicable to all areas of thought and progress. The 17th century German philosopher, Leibnitz, argued that change (e.g., in ethics and aesthetics) is gradual.

<sup>10</sup> A plague (Greek: *plege* = a stroke, a blow; Latin: *plangere* = to strike) traditionally is any widespread infectious disease with a high fatality rate among clinically affected individuals. In veterinary medicine, the term is extended to any widespread infectious disease causing major economic disruption, although the fatality rate may not be high (e.g., foot-and-mouth disease). In human medicine, the term is now commonly restricted to infection with the bacterium, *Yersinia (Pasteurella) pestis*.

**Table 1.1** Some dates of occurrence of animal plagues. (Most dates before 1960 extracted from Smithcors, 1957.)

<i>Date</i>	<i>Animal plagues</i>						
	<i>Rinderpest</i>	<i>Pleuropneumonia</i>	<i>Canine distemper</i>	<i>Anthrax</i>	<i>Foot-and-mouth disease</i>	<i>Equine influenza</i>	<i>Ill-defined diseases</i>
500 BC							Egypt 500 BC – time of Christ Egypt 278 BC abortion
AD				Rome AD 500			Rome 4th century AD (cattle) France 6th century AD (cattle) Ireland 8th century AD France 820, 850, 940–943 (cattle) England 1314 (cattle)
AD 1400	England 1490*, 1551				Italy 1514		
AD 1700	France 1710–14 Rome 1713 England 1714, 1745–46 France 1750	Europe 18th century				England 1688	
AD 1800			US 1760 Spain 1761 England 1763			England 1727 Ireland 1728 England 1733, 1737, 1750, 1760, 1771, 1788	
		England 1841–98			England 1839	England 1837	
	England 1865				England 1870–72, 1877–85	North America 1872	
	Africa 1890–1900					England 1889–90	

AD 1900

---

Belgium 1920

Middle East 1969–70

Africa 1979–84

India 1983–85

Turkey 1991–92

England 1922–25, 1942,  
1952, 1967–68

Canada 1951–52

Switzerland 1980

Channel Islands, France, Isle  
of Wight, Italy, Spain 1981

Denmark, Spain 1983

Germany (W.), Greece,  
The Netherlands,  
Portugal 1984

Italy 1985, 1988, 1993

India, S. Arabia 1990

Nepal 1993–94

Turkey 1995

Albania, Bulgaria, Greece,  
Macedonia, Yugoslavia  
1996

Taiwan 1997

Bhutan 1998

China 1999

Czechoslovakia 1957

Britain 1963

US 1963

Europe 1965

Poland 1969

USSR 1976

France, The Netherlands,  
Sweden 1978–79

England 1989

AD 2000

---

Greece, Japan, Mongolia, S.  
Africa 2000

France, Ireland, The  
Netherlands, UK 2001

---

\* Named as 'steppe murrain' (derivative of Latin *morí*= to die).

**Table 1.2** Military campaigns that disseminated rinderpest.

Century	Campaign
5th	Fall of Rome
8–9th	Charlemagne's conquest of Europe
12th	Genghis Kahn's invasion of Europe
13th	Kublai Kahn's invasion of Europe and China
15–16th	Spanish–Hapsburg conquest of Italy
17th	War of the League of Augsburg
18th	War of the Spanish Succession
18th	War of the Austrian Succession
18th	Seven Years' War
18–19th	Napoleonic Wars
19–20th	US invasion of the Philippines
19–20th	Italian conquest of Eritrea
20th	World War I
20th	World War II
20th	Vietnam War
20th	Lebanese War
20th	Sri Lankan conflict
20th	Azerbaijan conflict
20th	Gulf War

**Table 1.3** Veterinary schools founded to combat rinderpest.

Year of foundation	City	Country
1762	Lyon	France
1766	Alfort	France
1767	Vienna	Austria
1769	Turin	Piedmont
1773	Copenhagen	Denmark
1777	Giessen	Hesse
1778	Hannover	Hannover

(Bates, 1717–1719). Cattle owners were also compensated for loss. By the mid-19th century, disinfection (notably using carbolic and cresylic acids) was also being applied to control the disease (Brock, 2002).

Half of the cattle in France were destroyed by rinderpest between 1710 and 1714. The disease occurred irregularly until 1750, when it again became a serious problem. Little was known about the disease. This provided impetus for the establishment of the first permanent veterinary school at Lyons in 1762, and others were subsequently founded to combat the disease (Table 1.3)<sup>11</sup>.

The lifting of animal importation restrictions in England in 1842 increased the risk of disease occurring in Britain. Sheep pox entered Britain in 1847 from Germany, and pleuropneumonia became a serious

problem. Public concern, highlighted by the rinderpest outbreak of 1865 (Scott, 1997), was responsible for the establishment of the British State Veterinary Service in the same year. Similar services were founded in other countries. The legislature continued to strengthen the power of the veterinary services by passing Acts relating to the control of animal diseases.

#### The fourth period: 1884–1960

The animal plagues continued despite sanitary campaigns. This crisis coincided with the inception and acceptance of the microbial theory which, epitomized by Koch's postulates, defined a specific, single cause of an infectious disease and therefore implied a suitable control strategy directed against the causal agent.

This fourth stable phase of campaigns or mass actions began in the 1880s. Treatment of disease was based on laboratory diagnosis involving isolation of agents and identification of lesions followed by therapy. Control of disease by prevention and, subsequently, eradication involved mass testing of animals and immunization when an increasing number of vaccines became available<sup>12</sup>. The discovery of disease vectors facilitated prevention by vector control. An improved understanding of infectious agents' life histories enabled their life-cycles to be broken by manipulating the environment; the draining of land to prevent fascioliasis is a good example. Bacterial diseases remained as major clinical problems until the discovery and synthesis of antibiotics in the 20th century, when, in human medicine, the effectiveness of control measures was starkly reflected in changes in the 'league table' of causes of deaths (Figure 1.3). The veterinarian also experienced a similar increase in therapeutic power.

Many infectious diseases were either effectively controlled or eradicated between the latter part of the 19th century and the middle of the 20th century in the developed countries using the new techniques of the microbial revolution and older techniques including quarantine, importation restrictions, slaughter and hygiene. In 1892, pleuropneumonia in the US was the first disease to be regionally eradicated after a campaign lasting only five years. Notable British successes included rinderpest, eradicated in 1877, pleuropneumonia in 1898, and glanders and equine parasitic mange in 1928.

<sup>11</sup> There were other pressures, too, fostering the establishment of European veterinary schools. These included the need for military authorities to improve the effectiveness of horse-dependent armies, and the requirement for increased agricultural productivity in the face of population growth (Mathijsen, 1997).

<sup>12</sup> There had been earlier attempts to immunize animals against rinderpest, mimicking the practice of 'variolation' in humans, in which smallpox virus was inoculated to prevent the disease. The first such rinderpest trial was undertaken in 1711 by Bernardino Ramazzini at the University of Padua (Koch, 1891). Some authorities believe that the practice of immunization began in China; see Bazin (2003) for a brief history.

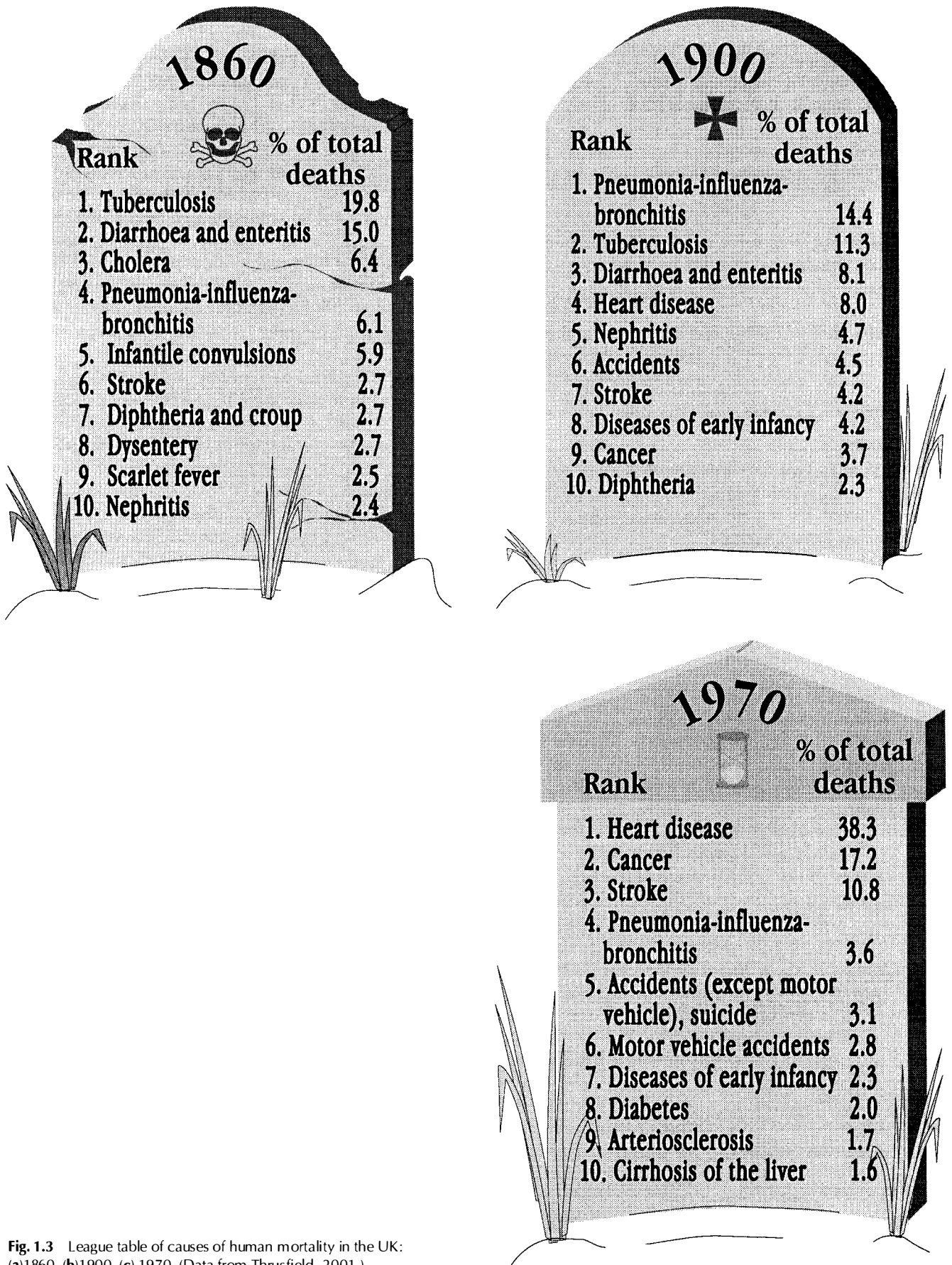

Fig. 1.3 League table of causes of human mortality in the UK: (a)1860, (b)1900, (c) 1970. (Data from Thrusfield, 2001.)

## Quantification in medicine

The evolution of understanding of the cause of disease purely qualitatively was accompanied by increased interest in disease in quantitative terms. This began primarily as a descriptive exercise. The ancient Japanese reported outbreaks of animal diseases. John Graunt (1662) published quantitative observations on London parish registers and 'Bills of Mortality'. An outbreak of rinderpest in France in the late 18th century was responsible for the establishment of a commission on epidemics, headed by Felix Vicq d'Azyr, Marie Antoinette's personal physician. This evolved into the Royal Society of Medicine, which pioneered the collection of statistical data on animal and human epidemics and the weather (Matthews, 1995).

### Post-Renaissance thinking and 'The Enlightenment'

The scientific revolution that began during the 16th century posited that the physical universe was orderly and could be explained mathematically (Dampier, 1948). This argument was extended to the biological world, where it was considered that 'laws of mortality' must exist. Graunt's mortality studies included attempts to formulate such laws by constructing life tables (see Chapter 4), Edmund Halley (1656–1742) constructed life tables for Breslau (Benjamin, 1959), and Daniel Bernoulli (1700–1782) applied life-table methods to smallpox data, thereby demonstrating that inoculation was efficacious in conferring lifelong immunity (Speiser, 1982). A hundred years later, William Farr (Halliday, 2000) produced a simple mathematical model of the 1865 rinderpest epidemic in the UK (see Chapter 19).

Quantitative analysis of biological (including medical) phenomena evolved in the 18th century, when the *Age of Enlightenment* saw a growth in literature dealing with the relationship between probability and the need for objectivity in science and society (the 'Probabilistic Revolution'). The mathematical foundation of probability was laid by Jakob Bernoulli in his *Ars Conjectandi*, which was published posthumously in 1713. He developed a theory of 'inverse probability', which stated that the frequency of an event would approach its probability of occurrence if the number of observations was large enough. This theory was mathematically refined by Siméon-Denis Poisson, who proposed a 'law of large numbers', which stated that, if an event was observed a large number of times, one could assume that the probability of its future occurrence would correspond to its observed frequency. The logical consequence of this conclusion is that, if there are sufficient observations, sound predictions can be made. Thus, in relation to therapy, Pierre-Simon Laplace (1814) suggested that a preferred method of treatment 'will manifest itself more and more in the measure that the number (of observations) is increased'.

A pivotal move towards comparative statistical techniques occurred when Pierre-Charles-Alexander Louis developed his 'numerical method', requiring systematic record keeping and rigorous analysis of multiple cases (Bollett, 1973). He documented typhoid in Paris, showing that the disease occurred predominantly in young adults, and that the average age of fatal cases was higher than that of survivors, suggesting that the younger patients had the best prognosis (Louis, 1836). He subsequently demonstrated that blood-letting was of no benefit to typhoid cases, and his calculation of average values was adopted by other early protagonists of clinical trials (e.g., Joseph Lister; see Chapter 16). Average values were also applied to provide a quantitative definition of a 'normal' individual; Adolphe Quetelet (1835), for example, recorded the range of the human cardiac and respiratory rates.

Application of probability theory to medicine was cautiously and tentatively accepted by British and French medical statisticians, who were largely concerned with the descriptive statistics of the major public health issues (e.g., *Figure 1.3*), rather than with statistical inference. Nevertheless, during the 19th century, strong links were forged between epidemiologists, mathematicians and statisticians through the common influence of Louis (Lilienfeld, 1978)<sup>13</sup>, and, by the 20th century, rigorous methods of statistical inference were developing (Stigler, 1986) and were being applied in medicine and agriculture. These methods necessitate observation of events in populations, rather than in the individual, and are thus central to the development of quantitative epidemiology (see Chapter 2).

The formulation of physical and biological events, however, now, as then, needs to be very carefully assessed, and may convey an illusion of certainty and security that is not warranted (Gupta, 2001). Moreover, it is not always considered to be socially beneficial<sup>14</sup>, and is not a substitute for rigorous, albeit sometimes onerous, analysis of field data (*The Economist*, 2002). Additionally, there may be a tendency to use whatever numerical data are available, regardless of their relevance and quality (Gill, 1993)<sup>15</sup>.

<sup>13</sup> An interesting 'family tree', showing the links between 18th–20th century statisticians, public-health physicians and epidemiologists, is depicted by Lilienfeld and Lilienfeld (1980).

<sup>14</sup> See, for example, Gregory (2002) for a brief theological discussion.

<sup>15</sup> Chambers (1997) amalgamates Gupta's and Gill's points, with sights set particularly on economists: 'Quantification and statistics can mislead, distract, be wasteful, simply not make sense or conflict with common values . . . Yet professionals, especially economists and consultants tight for time, have a strong felt need for statistics. At worst they grub around and grab what numbers they can, feed them into their computers and print out not just numbers, but more and more elegant graphs, bar charts, pie charts and three-dimensional wonders . . . Numbers can also reassure by appearing to extend control, precision and knowledge beyond their real limits . . . wrong numbers, one might add, are worst of all because all numbers pose as true.' Porter (1995) provides a philosophical discussion of quantification in general.



**Table 1.4** Current trends in the distribution of some infectious diseases of animals. (Extracted mainly from Mulhern *et al.*, 1962; Knight, 1972; Blaha, 1989; West, 1995; and Radostits *et al.*, 1999.)

Disease	Host	Trends
Anthrax	All animals, particularly devastating in cattle	World-wide range, now contracting to mainly tropics and sub-tropics
Aujeszky's disease	Pigs	Spreading, recently entered Japan
Bluetongue	Sheep	Spreading for past 100 years
Bovine brucellosis	Cattle	Eradicated from many developed countries in recent decades
Contagious bovine pleuropneumonia	Cattle	Eradicated from much of Europe
Glanders	Horses	Mostly eradicated from developed countries
Johne's disease	Cattle, sheep, goats	World-wide distribution with increasing prevalence in some countries, and spreading in Europe
Lumpy skin disease	Cattle	Extending from Africa to the Middle East
Rabies	All mammals, some birds	Eradication is problematic. Geographically isolated areas (including some island masses) are generally free, although most countries experience rabies to some extent
Rift Valley fever	Cattle, sheep, goats, man	Extending from Africa to the Middle East
Rinderpest	Artiodactyls	Only a few pockets of infection remaining. Global mass vaccination now ended
Sheep pox	Sheep	Eradicated from Europe in 1951. Present in Africa, Middle East and India
Swine vesicular disease	Pigs	Decreased significance since 1982
Tuberculosis	Many species, especially serious in cattle	Eradication has proved problematic but some success has been achieved. No country is totally free of tuberculosis

## Contemporary veterinary medicine

### Current perspectives

#### Infectious diseases

Although there have been notable successes in the control of the infectious diseases, some still pose problems in both developed and developing countries (*Table 1.4*), and some continue to recur; for example, foot-and-mouth disease (*Table 1.5*), which erupted most recently in western Europe with devastating consequences (notably in the UK) in 2001 (*Table 1.1*). Some have emerged as major problems this century, although there is circumstantial evidence that the infectious agents have existed for some time (*Table 1.6*). Others are apparently novel (*Table 1.7*)<sup>16</sup>. Military conflict continues to be responsible for spreading these diseases

(*Table 1.2*); for example, at the end of the Second World War, retreating Japanese soldiers brought rinderpest from Myanmar (Burma) to north-eastern Thailand.

The infectious diseases are particularly disruptive in the developing countries, where more than half of the world's livestock are located (*Table 1.8*), accounting for over 80% of power and traction (Pritchard, 1986) and, in pastoral communities, at least 50% of food and income (Swift, 1988) (with milk, alone, accounting for up to 75% of human daily energy requirements: Field and Simkin, 1985). There have been some successes, for example, the JP15 campaign against rinderpest in Africa (Lepissier and MacFarlane, 1966), although the benefits of this campaign were subsequently negated by civil strife and complacency (Roeder and Taylor, 2002) and the disease has only recently been effectively tackled again (FAO, 1996), with the goal of global eradication by 2010. Several vector-transmitted diseases

<sup>16</sup> Emergent and novel infectious diseases may be classified together as 'emerging diseases': '... infections that have newly appeared in a population or have existed but are rapidly increasing in incidence or geographic range' (Morse, 1995). Infectious diseases may emerge either as a result of genetic changes in infectious agents or their hosts (see Chapter 5) or following ecological changes (see Chapter 7). Schrag and Wiener (1995) conclude

that both ecological and genetic evolutionary changes can contribute to the emergence of infectious diseases, but that ecological change is probably the more general explanation for new epidemics (probably because ecological changes are less constrained than evolutionary changes in hosts and pathogens).

**Table 1.5** Number of outbreaks of foot-and-mouth disease in the United Kingdom, 1892–2001.

Year	Outbreaks	Year	Outbreaks	Year	Outbreaks	Year	Outbreaks
1892	95	1912	83	1932	25	1952	495
1893	2	1913	2	1933	87	1953	40
1894	3	1914	27	1934	79	1954	12
1895	0	1915	56	1935	56	1955	9
1896	0	1916	1	1936	67	1956	162
1897	0	1917	0	1937	187	1957	184
1898	0	1918	3	1938	190	1958	116
1899	0	1919	75	1939	99	1959	45
1900	21	1920	13	1940	100	1960	298
1901	12	1921	44	1941	264	1961	103
1902	1	1922	1140	1942	670	1962	5
1903	0	1923	1929	1943	27	1963	0
1904	0	1924	1	1944	181	1964	0
1905	0	1925	260	1945	129	1965	1
1906	0	1926	204	1946	64	1966	34
1907	0	1927	143	1947	104	1967	2210
1908	3	1928	138	1948	15	1968	187
1909	0	1929	38	1949	15	1969–2000	1 <sup>†</sup>
1910	2	1930	8	1950	20	2001	2030
1911	19	1931	97	1951	116		

<sup>†</sup> An isolated outbreak occurring on the Isle of Wight in 1981.

**Table 1.6** Some emergent infectious diseases and plagues of animals in the 20th Century.

Year	Country	Infection	Source
1907	Kenya	African swine fever	Montgomery (1921)
1910	Kenya	Nairobi sheep disease	Montgomery (1917)
1918	US	Swine influenza	Shope (1931)
1929	South Africa	Lumpy skin disease	Thomas and Maré (1945)
1929	US	Swine pox	McNutt <i>et al.</i> (1929)
1930	US	Eastern equine encephalomyelitis	Kissling <i>et al.</i> (1954)
1930	US	Western equine encephalomyelitis	Kissling (1958)
1932	US	Vesicular exanthema of pigs	Traum (1936)
1933	Iceland	Maedi-visna	Sigurdsson (1954)
1939	Colombia	Venezuelan equine encephalomyelitis	Kubes and Rios (1939)
1946	Canada	Mink enteritis	Schofield (1949)
1947	US	Transmissible mink encephalopathy	Hartsough and Burger (1965)
1953	US	Bovine mucosal disease	Ramsey and Chivers (1953)
1955	US	Infectious bovine rhinotracheitis	Miller (1955)
1956	Czechoslovakia	Equine influenza A (H7N7)	Bryans (1964)
1962	France	West Nile equine encephalomyelitis	Panthier (1968)
1963	US	Equine influenza A (H3N8)	Bryans (1964)
1966	UK	Bovine ulcerative mammillitis	Martin <i>et al.</i> (1966)
1972	Iran	Camel pox	Baxby (1972)
1972	US	Lyme disease	Steere <i>et al.</i> (1977)
1974	Kenya	Horsepox	Kaminjolo <i>et al.</i> (1974)
1975	South Africa	Haemorrhagic Rift Valley fever	Van Velden <i>et al.</i> (1977)
1977	Worldwide	Canine parvovirus	Eugster <i>et al.</i> (1978)
1977	USSR	Cat pox	Marennikova <i>et al.</i> (1977)
1980	UK	Infectious bursitis-2	McFerran <i>et al.</i> (1980)
1981	Zimbabwe	Mokola virus infection	Foggin (1983)
1983	US	Fulminating avian influenza (H5N2)	Buisch <i>et al.</i> (1984)
1985	Denmark	Danish bat rabies (Duvenhage)	Grauballe <i>et al.</i> (1987)
1986	UK	Bovine spongiform encephalopathy	Wells <i>et al.</i> (1987)
1986	US	Cache Valley teratogenesis	Chung <i>et al.</i> (1991)

**Table 1.7** Some novel infectious diseases and plagues of animals in the 20th Century.

Year	Country	Infection	Source
1907	Hungary	Marek's disease	Marek (1907)
1912	Kenya	Rift Valley fever	Daubney <i>et al.</i> (1931)
1923	The Netherlands	Duck plague	Baudet (1923)
1925	US	Avian laryngotracheitis	May and Tittler (1925)
1926	Java	Newcastle disease	Doyle (1927)
1928	France	Feline panleukopenia	Verge and Cristoforoni (1928)
1930	US	Avian encephalomyelitis	Jones (1932)
1930	US	Avian infectious bronchitis	Schalk and Hawn (1931)
1932	US	Equine virus abortion	Dimock and Edwards (1932)
1937	US	Turkey haemorrhagic enteritis	Pomeroy and Fenstermacher (1937)
1942	Ivory Coast	Goat plague (peste des petits ruminants)	Gargadennec and Lalanne (1942)
1945	US	Duck virus hepatitis-1	Levine and Fabricant (1950)
1945	US	Transmissible gastroenteritis of pigs	Doyle and Hutchings (1946)
1946	US	Bovine virus diarrhoea	Olafson <i>et al.</i> (1946)
1946	US	Aleutian disease of mink	Hartsough and Gorham (1956)
1947	Sweden	Infectious canine hepatitis	Rubarth (1947)
1950	US	Avian adenovirus-1	Olson (1950)
1951	US	Turkey bluecomb disease	Peterson and Hymas (1951)
1953	US	Feline infectious anaemia	Flint and Moss (1953)
1954	Japan	Akabane disease	Miura <i>et al.</i> (1974)
1954	Canada	Avian reovirus	Fahey and Crawley (1954)
1956	China	Goose plague	Fang and Wang (1981)
1957	US	Feline calicivirus	Fastier (1957)
1958	US	Feline viral rhinotracheitis	Crandell and Maurer (1958)
1959	Canada	Turkey viral hepatitis	Mongeau <i>et al.</i> (1959)
1959	Japan	Ibaraki disease	Omori <i>et al.</i> (1969)
1960	Israel	Turkey meningoencephalitis	Komarov and Kalmar (1960)
1962	US	Bovine adenovirus-1,2	Klein (1962)
1962	US	Avian infectious bursitis-1	Cosgrove (1962)
1964	UK	Feline leukaemia	Jarrett <i>et al.</i> (1964)
1964	UK	Porcine adenovirus	Haig <i>et al.</i> (1964)
1965	UK	Duck virus hepatitis-2	Asplin (1965)
1965	US	Canine herpes	Carmichael <i>et al.</i> (1965)
1965	US	Porcine enteroviruses	Dunne <i>et al.</i> (1965)
1966	Italy	Swine vesicular disease	Nardelli <i>et al.</i> (1968)
1967	UK	Porcine parvovirus	Cartwright and Huck (1967)
1967	UK	Border disease in sheep	Dickinson and Barlow (1967)
1967	US	Chronic wasting disease of deer	Williams and Young (1980)
1968	Canada	Bovine adenovirus-3	Darbyshire (1968)
1969	US	Duck virus hepatitis-3	Toth (1969)
1972	UK	Lymphoproliferative disease of turkeys	Biggs <i>et al.</i> (1974)
1973	US	Equine adenovirus	McChesney <i>et al.</i> (1973)
1974	US	Feline herpes urolithiasis	Fabricant and Gillespie (1974)
1974	US	Caprine arthritis-encephalitis	Cork <i>et al.</i> (1974)
1974	Japan	Kunitachi virus	Yoshida <i>et al.</i> (1977)
1976	The Netherlands	Egg-drop syndrome	Van Eck <i>et al.</i> (1976)
1976	Japan	Avian infectious nephritis	Yamaguchi <i>et al.</i> (1979)
1977	US	Chicken parvovirus	Parker <i>et al.</i> (1977)
1977	Ireland	Contagious equine metritis	O'Driscoll <i>et al.</i> (1977)
1978	Iraq	Pigeon paramyxovirus-1	Kaleta <i>et al.</i> (1985)
1979	Japan	Chick anaemia agent	Yuasa <i>et al.</i> (1979)
1981	US	Canine calicivirus	Evermann <i>et al.</i> (1981)
1984	China	Rabbit haemorrhagic disease	Liu <i>et al.</i> (1984)
1985	US	Potomac horse fever	Rikihisa and Perry (1985)
1985	UK	Rhinotracheitis of turkeys	Anon. (1985)
1985	Japan	Chuzon disease of cattle	Miura <i>et al.</i> (1990)
1987	USSR	Phocid distemper-2 (Baikal)	Grachev <i>et al.</i> (1989)
1987	US	Porcine reproductive and respiratory syndrome	Kefaber (1989)
1987	US	Morbillivirus of dolphins	Lipscomb <i>et al.</i> (1994)
1988	The Netherlands	Phocid distemper-1 (North Sea)	Osterhaus and Vedder (1988)
1990	The Netherlands	Bovine birnavirus	Vanopdenbosch and Wellemans (1990)
1994	Australia	Hendra virus (formerly equine morbillivirus)	Murray <i>et al.</i> (1995)
1995	New Zealand	Wobbly possum disease virus	Anon. (1997)
1996	US	Porcine wasting disease syndrome	Daft <i>et al.</i> (1996)

**Table 1.8** World livestock populations, 2001 (1000s of animals). (From FAO, 2002.)

	Cattle	Sheep	Goats	Pigs	Horses	Chickens	Buffaloes	Camels
US and Canada	110 223	7 805	1 380	71 738	5 685	1 988 000	–	–
Central America	50 453	7 522	12 308	25 707	8 453	716 000	5	–
South America	308 569	75 312	22 148	55 399	15 651	1 765 000	1 151	–
Europe	143 858	144 812	17 904	194 153	7 010	1 746 000	230	12
Africa	230 047	250 147	218 625	18 467	4 879	1 276 000	3 430	15 124
Asia	470 920	406 584	406 584	552 372	16 302	7 250 000	160 892	4 198
Oceania	37 722	164 001	684	5 094	376	119 000	–	–
All parts of the world	1 351 792	1 056 184	738 246	922 929	58 244	14 859 000	165 724	19 334

**Table 1.9** The livestock population of Great Britain, 1866–1997 (1000s of animals). (From HMSO, 1968, 1982, 1991, 1998.)

Year	Cattle	Sheep	Pigs	Horses (agricultural use)	Fowls	Turkeys
1866	4 786	22 048	2 478	–	–	–
1900	6 805	26 592	2 382	1 078	–	–
1925	7 368	23 094	2 799	910	39 036	730
1950	9 630	19 714	2 463	347	71 176	855
1965	10 826	28 837	6 731	21	101 956	4 323
1980	11 919	30 385	7 124	–	115 895	6 335
1989	10 510	38 869	7 391	–	121 279	–
1997	9 902	39 943	7 375	–	111 566*	–

– Data not available.

\* 1995 figure. (A new approach to collecting poultry information began in 1997, preventing direct comparisons with previous years.)

with complex life-cycles, including haemoprotozoan infections such as trypanosomiasis, have not been controlled satisfactorily<sup>17</sup>. The techniques of the microbial revolution have enabled these diseases to be identified. However, accurate means of assessing the extent and distribution of the diseases also are necessary in order to plan control programmes (e.g., the *Pan-African Rinderpest Campaign*: IAEA, 1991).

Some infectious diseases, for example brucellosis and tuberculosis, persist at low levels in developed countries, despite the application of traditional control methods. This problem can result from inadequate survey techniques and insensitive diagnostic tests (Martin, 1977). In some cases, an infectious agent may have a more complex natural history than initially suspected. For example, continued outbreaks of bovine

tuberculosis in problem herds in England (Wilesmith *et al.*, 1982) have been shown to be associated with pockets of infection in wild badgers (Little *et al.*, 1982; Krebs, 1997), which has resulted in a somewhat contentious control strategy of badger culling (Donnelly *et al.*, 2003; DEFRA, 2004).

The effective control of the major infectious diseases has allowed an increase in both animal numbers (Table 1.9) and productivity (Table 1.10) in the developed countries (mechanization making draft horses the exception)<sup>18</sup>. There has been an increase in the size of herds and flocks, notably in dairy, pig (Table 1.11) and poultry enterprises. Intensification of animal industries is accompanied by changes in animal health problems.

### Complex infectious diseases

The animal plagues are caused by 'simple' agents, that is, their predominant causes can be identified as single

<sup>17</sup> The reasons for lack of progress in the control of animal diseases in developing countries are complex, including more than lack of technical feasibility. Insufficient applied research to solve field problems, poor information, and neglect of farmers' needs and the requirement for farmer participation in disease control, all contribute to the problem (Huhn and Baumann, 1996; Bourn and Blench, 1999). With the demand for livestock products in developing countries estimated to double by 2020 (Delgado *et al.*, 1999), the supply of livestock services, including veterinary services, is likely to increase in importance, and issues such as privatisation (Holden *et al.*, 1996) and delivery to the poor (Ahuja and Redmond, 2004) will require close scrutiny.

<sup>18</sup> Some earlier improvements in productivity had occurred as a consequence of improved nutrition. For example, in England in the 18th century, more land was planted with high-yielding roots (e.g., turnips) and new types of grass, enabling animals to be fed adequately throughout the year. The average weight of an ox at London's Smithfield Market increased from 370 lb in 1710 to 800 lb in 1795 (Paston-Williams, 1993).

**Table 1.10** World cattle productivity, 2001. (From FAO, 2002.)

	Number of animals slaughtered (1000s of animals)	Carcass weight (kg/animal)	Milk yield (kg/animal)	Milk production (1000s metric tonnes)
US	36 690	327	8 226	75 025
South America	55 369	213	1 580	47 055
Asia	78 380	143	1 232	96 674
Africa	27 255	149	486	18 645
Europe	53 447	219	4 149	210 193
Oceania	12 408	214	4 232	24 623
All parts of the world	277 353	204	2 206	493 828

**Table 1.11** Pig herd structure in England and Wales (June). (Data supplied by the Meat and Livestock Commission.)

	1965	1971	1975	1980	1991	1999
Number of farms with pigs	94 639	56 900	32 291	22 973	13 738	10 460
Total sows (1000s)	756.3	791.0	686.0	701.1	672.4	580.5
Average herd size (sows)	10.4	18.5	27.6	41.4	70.4	86.3
Number of herds by herd size (sows):						
1–49	56 560 (75.4%)	39 000 (90.9%)	20 873 (84.0%)	12 900 (76.3%)	6 471 (67.8%)	4 714 (70.1%)
50–99	10 445 (13.9%)	2 700 (6.3%)	2 401 (9.7%)	2 000 (11.8%)	1 050 (11.0%)	522 (7.8%)
100–199	8 034 (10.7%)	1 000 (2.3%)	1 141 (4.6%)	1 300 (7.7%)	1 115 (11.7%)	581 (8.6%)
200 and over	–	200 (0.5%)	426 (1.7%)	700 (4.1%)	914 (9.5%)	911 (13.5%)
Total number of herds with sows	75 039	42 900	24 841	16 900	9 550	6 728

infectious agents. Diseases caused by single agents still constitute problems in developed countries. Examples include salmonellosis, leptospirosis, babesiosis and coccidiosis. However, diseases have been identified that are produced by simultaneous infection with more than one agent (mixed infections), and by interaction between infectious agents and non-infectious factors. These are common in intensive production enterprises. Diseases of the internal body surfaces – enteric and respiratory diseases – are particular problems. Single agents alone cannot account for the pathogenesis of these complex diseases.

### Subclinical diseases

Some diseases do not produce overt clinical signs although often affect production. These are called **subclinical** diseases. Helminthiasis and marginal mineral deficiencies, for example, decrease rates of live-weight gain. Porcine adenomatosis decreases growth in piglets, although there may be no clinical signs (Roberts *et al.*, 1979). Infection of pregnant sows with porcine parvovirus in early pregnancy destroys fetuses, the only sign being small numbers of piglets in litters. These diseases are major causes of production loss; their identification often requires laboratory investigations.

### Non-infectious diseases

Non-infectious diseases have increased in importance following control of the major infectious ones. They can be predominantly genetic (e.g., canine hip dysplasia), metabolic (e.g., bovine ketosis) and neoplastic (e.g., canine mammary cancer). Their cause may be associated with several factors; for example, feline urolithiasis is associated with breed, sex, age and diet (Willeberg, 1977).

Some conditions, such as ketosis, are particularly related to increased levels of production; ketosis is more likely in cows with high milk yields than in those with low yields. Intensive production systems may also be directly responsible for some conditions, for example foot lesions in individually caged broilers (Pearson, 1983).

### Diseases of unknown cause

The cause of some diseases has not been fully elucidated, despite intensive experimental and field investigations over many years. Examples include the related diseases, feline dysautonomia (Edney *et al.*, 1987; Nunn *et al.*, 2004) and equine grass sickness (Hunter *et al.*, 1999; McCarthy *et al.*, 2001; Wlaschitz, 2004).

In some situations, infectious agents have been isolated from cases of a disease but cannot be unequivocally associated with the disease. An example is *Mannheimia haemolytica* (previously named *Pasteurella haemolytica*) in relation to 'shipping fever' (Martin *et al.*, 1982). This syndrome occurs in cattle soon after their arrival at feedlots. Post-mortem examination of fatal cases has revealed that fibrinous pneumonia is a common cause of death. Although *M. haemolytica* is frequently isolated from lungs, it is not invariably present. Attempts to reproduce the disease experimentally are fraught with problems, not the least of which is the difficulty of establishing colonization of the nasal tract with the bacterium (Whiteley *et al.*, 1992). Other factors also seem to be involved (Radostits *et al.*, 1999). These include mixing animals and then penning them in large groups, the feeding of corn silage, dehorning, and, paradoxically, vaccination against agents that cause pneumonia, including *M. haemolytica* – factors associated with adrenal stress (see *Figure 3.5b* and Chapter 5).

Management and environment also appear to play significant, although often not clearly defined, roles in other diseases. Examples include enzootic pneumonia and enteritis in calves (Roy, 1980), enteric disease in suckling pigs, porcine pneumonia, bovine mastitis associated with *Escherichia coli* and *Streptococcus uberis* (Blowey and Edmondson, 2000b) and mastitis in intensively housed sows (Muirhead, 1976).

In some instances, the infectious agents that are isolated are ubiquitous and also can be isolated from healthy animals, for example, enteric organisms (Isaacson *et al.*, 1978). These are 'opportunistic' pathogens, which cause disease only when other detrimental factors are also present.

In all of these cases, attempts to identify a causal agent fulfilling Koch's postulates frequently fail, unless unnatural techniques, such as abnormal routes of infection and the use of gnotobiotic animals, are applied.

## The fifth period

The animal-health problems and anomalies that emerged in the 20th century stimulated a change, which began in the 1960s, in attitude towards disease causality and control.

### Causality

The inappropriateness of Koch's postulates as criteria for defining the cause of some syndromes suggested that more than one factor may sometimes operate in producing disease. A **multifactorial** theory of disease has developed, equally applicable to non-infectious

and infectious diseases. Interest in human diseases of complex and poorly understood cause grew in the early years of the 20th century (Lane-Clayton, 1926) and was responsible for the development of new methods for analysing risk factors, for example smoking in relation to lung cancer (Doll, 1959), and these epidemiological techniques are now firmly established in veterinary medicine, too (e.g., in the investigation of risk factors for respiratory disease in pigs: Stärk, 2000).

There is also now an awareness that the causes of disease include social, geographical, economic and political factors, as well as biological and physical ones (Hueston, 2001). For instance, although bovine spongiform encephalopathy subsequently spread to mainland Europe, its initial emergence in the UK (*Table 1.6*) was the result of recycling infective meat and bone meal to cattle, and this practice was extensive because meat and bone meal was an inexpensive source of high-quality protein in cattle rations in a country that had heavily intensified and in which plant proteins were limited. Likewise, bovine tuberculosis is a manifest and expanding problem in white-tailed deer in north-eastern Michigan in the US because the deer populations have increased as a result of feeding programmes established to serve the hunting industry that has replaced cattle farming in this economically deprived area.

### New control strategies

Two major strategies have been added to the earlier techniques (Schwabe, 1980a,b):

1. the structured recording of information on disease;
2. the analysis of disease in populations.

These methods involve two complementary approaches: the continuous collection of data on disease – termed **surveillance** and **monitoring** – and the intensive investigation of particular diseases. A further technique, used at the individual farm level, is the recording of information on both the health and productivity of each animal in a herd, as a means of improving production by improving herd health.

### Recent trends

Several recent trends have occurred in relation to the services that the veterinarian supplies to his clients, and to national and international disease reporting.

### Veterinary services

Veterinarians practising in the livestock sector continue to control and treat disease in individual

**Fig. 1.4** Areas of employment of veterinarians in the US, 1980 and 1990. LAE: exclusively large animal; LAP: predominantly large animal; MIX: mixed practice; SAP: predominantly small animal; SAE: exclusively small animal; EQ: equine; OPP: other private practice; UNI: university; FG: federal government; SLG: state or local government; US: uniformed services; IND: industry; OPC: other public and corporate. (From Wise and Yang, 1992.)

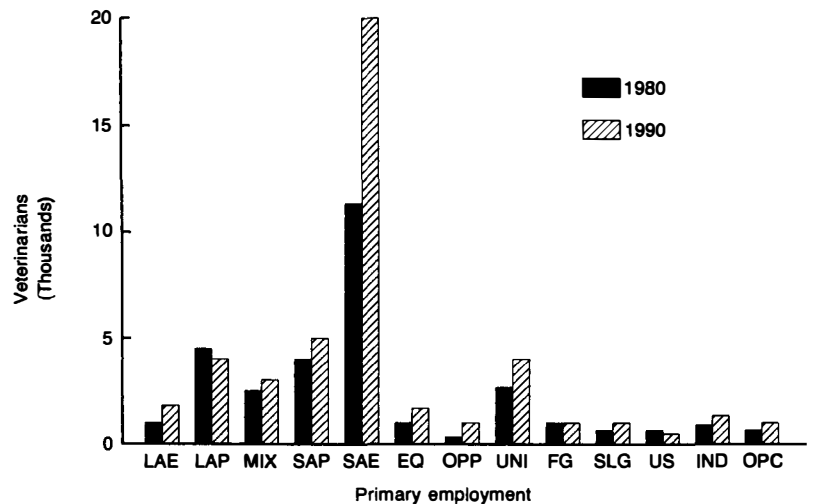

animals. Developments in molecular biology are improving diagnostic procedures (Goldspink and Gerlach, 1990), and offer new opportunities for vaccine production (Report, 1990). Additionally, in intensive production systems, the multifactorial nature of many diseases necessitates modification of the environment of the animal and management practices, rather than concentrating exclusively on infectious agents.

Diseases of food animals are also being considered directly in relation to their effect on **production**. Reduced levels of production can be used as 'diagnostic indicators', for example small litter size as an indicator of infection with porcine parvovirus. More significantly, veterinary emphasis has shifted from disease as a clinical entity in the individual animal to disease assessed in terms of suboptimal health, manifested by decreased herd performance: disease is being defined as the unacceptable performance of **groups** of animals. There is thus a need to identify all factors that contribute to the occurrence of disease, to select suitable 'performance indicators' (e.g., 'calving to conception interval'), and to define targets for these indicators in herds under a particular system of husbandry. It is then possible to identify those herds that miss the targets. This is called **performance-related diagnosis** (Morris, 1982), and includes not only the measurement of overt indicators, such as liveweight gain, but also estimation of covert biochemical values, such as metabolite levels in serum. Thus, clinical disease, subclinical disease and production need to be monitored in the context of anticipated ('normal') levels for a particular production system (Dohoo, 1993).

The veterinarian therefore has become more involved in husbandry, management and nutrition than previously, and less involved in traditional 'fire brigade' treatment of clinically sick animals. However, the livestock owner frequently still regards the veterinarian solely as a dispenser of treatment (Goodger

and Ruppner, 1982), relying on feed representatives, dairy experts and nutritionists for advice on breeding, nutrition and management. The extent of this problem varies from one country to another, but indicates that the veterinarian's evolving role in animal production requires a change not only in veterinary attitudes but also sometimes in those of animal owners.

Government veterinary services, too, are becoming increasingly concerned with investigations of specific animal health problems of complex cause, such as mastitis, thereby extending their role beyond the traditional control of mass infectious diseases.

As the mass infectious diseases are controlled, and animal production becomes more intensive, other diseases become relatively more important. They are currently major problems in developed countries, and in some developing countries that have intensive enterprises, such as poultry and pig units in Malaysia, the Philippines and Taiwan. These diseases will become increasingly significant in the developing countries when the mass infectious diseases are controlled.

Attention is being focussed on the health of companion animals, particularly in the developed countries (e.g., Heath, 1998)<sup>19</sup>. This is reflected in the employment trends in the veterinary profession (Figure 1.4). Many health problems of companion animals are complex too, and a full understanding of their cause and control is possible only when the contribution of genetic and environmental factors is appreciated. Examples include urinary tract infections in bitches, in which concurrent disease and recent chemotherapy are important factors (Freshman *et al.*, 1989), and equine colic, which is related to age and breed (Morris *et al.*, 1989; Reeves *et al.*, 1989). Problems of veterinary

<sup>19</sup> In many developing countries, private veterinary practice remains a minority employer of veterinarians, with companion animals of little significance (e.g., Turkson, 2003).





Fig. 1.5 A Victorian satire: *Microcosm dedicated to the London Water Companies 'Monster soup commonly called Thames Water'* by George Cruikshank (1792–1878). British Museum, London UK/Bridgeman Art Library.

interest now extend beyond clinical conditions to wider social issues, such as the biting of children by dogs (Gershman *et al.*, 1994), and animal welfare (see below).

Additionally, veterinary services have an enlarging responsibility for human health, including preventing and controlling emerging zoonotic diseases, and addressing antibiotic resistance (an area of endeavour that has been traditionally labelled **veterinary public health**), and protecting the environment and ecosystems (Chomel, 1998; Marabelli, 2003; Pappaioanou, 2004).

### Food quality

A particular area of concern in veterinary public health is food quality. The public's concern about what it consumes is not new (Figure 1.5). However, during the last two decades of the 20th century, concern increased because of major outbreaks of foodborne infections of animal origin (Cohen, 2000). Examples include an outbreak of salmonellosis affecting over 200 000 people in the US in 1994, and *Escherichia coli* O157:H7 infection

affecting over 6000 schoolchildren in Japan in 1996 (WHO, 1996). Other emerging foodborne pathogens include *Cryptosporidium* and *Campylobacter* spp. (Reilly, 1996) and *Listeria monocytogenes* (WHO, 1996). Additionally, the emergence of bovine spongiform encephalopathy, with its putative role as the cause of the fatal human disease, variant Creutzfeldt–Jakob disease (Will, 1997), has served to heighten public concern over food safety. In several western countries, this has led to the establishment of Food Standards Agencies whose remit is to oversee food quality.

The veterinarian's role is now extended beyond guaranteeing wholesomeness of food at the abattoir, and addresses all levels of the production chain, from the farm to the table ('from paddock to plate') (Smulders and Collins, 2002, 2004). This necessitates the establishment of quality assurance programmes on the farm, using techniques such as HACCP (Hazard Analysis Critical Control Points) (Noordhuizen, 2000), thus marking a shift in focus from herd health, alone, to quality control of food throughout the production chain (Figure 1.6). This approach is strengthened by quantitative evaluation of the risk of transmission

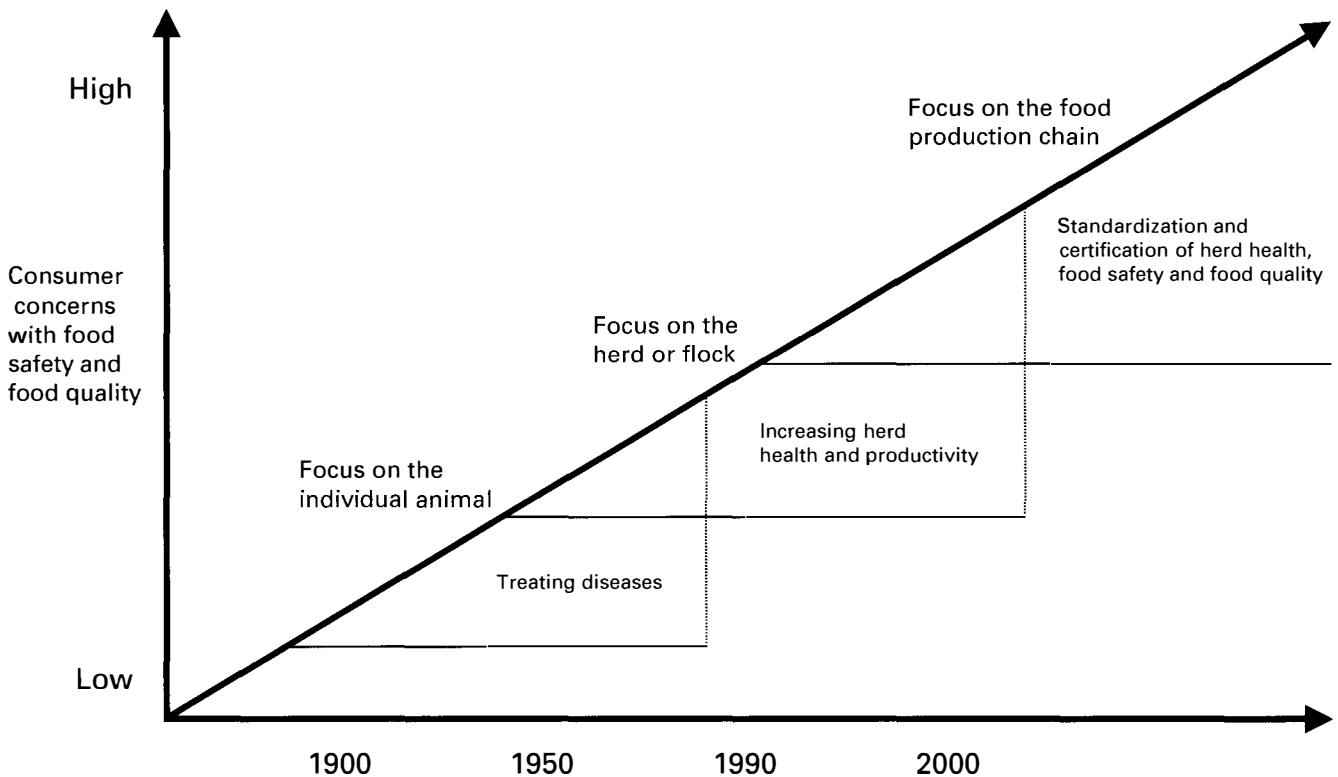

**Fig. 1.6** The changing focus of veterinary medicine practised in livestock, in relation to consumer concerns with food quality. (Reprinted from *Preventive Veterinary Medicine*, 39, Blaha, Th., Epidemiology and quality assurance application to food safety, Copyright © (1999), with permission from Elsevier Science.)

of infection throughout the chain (see Chapter 2: 'Microbial risk assessment').

### Animal welfare

The attitude of the public to animals (notably in developed countries) is reflected in contemporary concern for animal welfare, both among the scientific community (Moss, 1994; Appleby and Hughes, 1997) and the general public (Bennett, 1996)<sup>20</sup>. This encompasses health and 'well-being' (Ewbank, 1986; Webster, 2001)<sup>21</sup>. The latter term is difficult to define, and is also included in the *World Health Organization's* definition of human health (Old English: *hal* = whole) as 'a state of complete physical, mental and social well-being and not merely the absence of disease or infirmity' (WHO, 2003). Although this definition was not designed to be

<sup>20</sup> Concern for the welfare of animals is not just recent, though. In 1790, for example, there was public outrage over the wastage of horses in the British Army, which was losing more animals from disease and lack of care than from enemy action. This resulted, in 1795, in the Army directing that a veterinarian should be attached to each regiment. (The first to enlist as an Officer was John Shippis in 1796.) The shortage of trained veterinarians was so acute that London's Royal Veterinary College temporarily reduced its period of training from three years to three months.

<sup>21</sup> Animal welfare is therefore assessed primarily biologically, and is distinct from 'animal rights', which is an ethical and philosophical issue (Singer, 2000).

a framework for formulating goals of health policy (Noack, 1987), it illustrates that health is more than just absence of disease.

Obvious aspects of animal welfare are deliberate physical abuse (non-accidental injury) and neglect; contentious topics are surgical mutilation, such as tail docking of dogs (Morton, 1992), horses (Cregier, 1990) and pigs (Day and Webster, 1998), and velvet antler removal from deer (Pollard *et al.*, 1992). Companion animals are known to suffer a wide range of types of physical abuse (Munro and Thrusfield, 2001a,b,c) and sexual abuse (Munro and Thrusfield, 2001d) which are remarkably similar to those found in child abuse, and the link between abuse of animals and abuse of children is becoming recognized (Ascione and Arkow, 1999). Other animal-welfare issues may be more subtle; for example, the relationship between bovine mastitis and use of bovine somatotropin to increase milk production (Willeberg, 1993, 1997).

Welfare in livestock production systems is often evaluated in the context of the 'five freedoms' (Spedding, 2000):

1. freedom from hunger and thirst;
2. freedom from discomfort;
3. freedom from pain, injury and disease;
4. freedom to express normal behaviours;
5. freedom from fear and distress.

Behavioural problems may be associated with intensive husbandry systems; for example, cannibalism in laying hens (Gunnarsson *et al.*, 1998), but there may be less tangible issues (Ewbank, 1986) such as behavioural deprivation in sows tethered in stalls. The move towards organic farming in some western countries is justified, in part, by improved animal welfare (Sundrum, 2001), and the veterinarian therefore is concerned with disease, productivity and well-being, all of which can be interrelated, in all types of production system (Ewbank, 1988).

### National and international disease reporting

There is a requirement for improved disease reporting systems at the national and international level to identify problems, define research and control priorities and assist in the prevention of spread of infectious agents from one country to another. Additionally, residues need to be identified and eliminated (WHO, 1993). These include contamination of meat by pesticides (Corrigan and Seneviratna, 1989) and hormones (McCaughy, 1992), as well as the more long-standing issue of antibiotic residues, with the attendant problem of antibiotic resistance (Hugoson and Wallén, 2000; Teal, 2002).

The move towards a free internal market in the European Union (Anon., 1992), and global goals to liberalize international trade through the World Trade Organization (WTO), are highlighting the requirement for comprehensive disease reporting, and governmental veterinary services are responding to this need (DEFRA, 2002c). If liberalization is achieved, it will have advantageous effects on world trade, including that in livestock commodities (Page *et al.*, 1991). An important component of free trade therefore is assessment of the **risk** of disease and related events (e.g., carcass contamination) associated with the importation of animals and animal products (Morley, 1993). Established organizations, such as the *Office International des Epizooties* (OIE), are modifying their goals and reporting techniques, taking account of these new requirements (Blajan and Chillaud, 1991; Thiermann, 2005).

The advent of low-cost computing following the microelectronic revolution offers powerful means of storing, analysing and distributing data. Information can be transported rapidly using modern communications systems. These developments increase the scope for efficient disease reporting and analysis of the many factors that contribute to clinical disease and sub-optimal production, both of which require increased statistical acumen among veterinarians. Epidemiology has developed to supply these contemporary veterinary requirements.

### Further reading

- Ainsworth, G.C. (1986) *Introduction to the History of Medical and Veterinary Mycology*. Cambridge University Press, Cambridge
- Blancou, J. (2002) History of the control of foot and mouth disease. *Comparative Immunology, Microbiology and Infectious Diseases*, **25**, 283–296
- Blancou, J. (2003) *History of the Surveillance and Control of Transmissible Animal Diseases*. Office International des Epizooties, Paris. (Includes a global bibliography of veterinary writings from ancient times to the 15th century)
- British Veterinary Association Trust Project (1982) *Future of Animal Health Control – The Control of Infectious Diseases in Farm Animals*. Report of a symposium, University of Reading, 14–16 December 1982. British Veterinary Association, London
- Brown, C. and Bolin, C.A. (2000) *Emerging Diseases of Animals*. ASM Press, Washington
- Burroughs, T., Knobler, S. and Lederberg, J. (Eds) (2002) *The Emergence of Zoonotic Diseases: Understanding the Impact on Animal and Human Health*. National Academy Press, Washington
- Cohen, M.L. (2000) Changing patterns of infectious disease. *Nature*, **406**, 762–767
- Cornelius, S.T. (2003) Emerging African animal diseases. *Commonwealth Veterinary Association News*, **19** (2), 44–50
- Dorn, C.R. (1992) Veterinary epidemiology and its economic importance in A.D. 2000. *Preventive Veterinary Medicine*, **13**, 129–136
- Dunlop, R.H. (2004) Bourgelat's vision for veterinary education and the remarkable spread of the 'meme'. *Journal of Veterinary Medical Education*, **31**, 310–322. (A brief history of veterinary education)
- Dunlop, R.H. and Williams, D.J. (1995) *Veterinary Medicine: an Illustrated History*. Mosby Year-Book, St Louis
- Faber, K. (1930) *Nosography: The Evolution of Clinical Medicine in Modern Times*, 2nd edn. Paul B. Hoeber, New York. Reprinted by AMS Press Inc., New York, 1978. (A history of concepts of pathogenesis)
- Fleming, G. (1871) *Animal Plagues: Their History, Nature and Prevention*. Chapman and Hall, London
- Fleming, G. (1882) *Animal Plagues: Their History, Nature and Prevention*, Vol. 2 (from AD 1800 to 1844). Baillière, Tindall and Cox, London
- International Atomic Energy Agency (1998) *Towards Livestock Disease Diagnosis and Control in the 21st Century*. Proceedings of an international symposium on the diagnosis and control of livestock diseases using nuclear and related techniques jointly organized by the International Atomic Energy Agency and the Food and Agriculture Organization of the United Nations and held in Vienna, 7–11 April, 1997. International Atomic Energy Agency, Vienna
- Jackson, R. (2002) Veterinary epidemiology in New Zealand: a 50-year perspective. *New Zealand Veterinary Journal*, **50** (3) (Supplement), 13–16
- Karaszson, D. (1988) *A Concise History of Veterinary Medicine*. Akadémiai Kiadó, Budapest
- MacIntyre, D.K. and Breitschwerdt, E.B. (Eds) (2003) Emerging and re-emerging infectious diseases. *The Veterinary Clinics of North America, Small Animal Practice*, **33**, 677–943

- Matthews, J.R. (1995) *Quantification and the Quest for Medical Certainty*. Princeton University Press, Princeton. (A history of the application of statistical methods in medicine)
- Melby, E.C. (1985) The veterinary profession: changes and challenges. *Cornell Veterinarian*, **75**, 16–26
- Michell, A.R. (Ed.) (1993) *The Advancement of Veterinary Science. The Bicentenary Symposium Series. Volume 1: Veterinary Medicine beyond 2000*. CAB International, Wallingford
- Michell, A.R. (Ed.) (1993) *The Advancement of Veterinary Science. The Bicentenary Symposium Series. Volume 3: History of the Healing Professions, Parallels between Veterinary and Medical History*. CAB International, Wallingford
- Ministry of Agriculture, Fisheries and Food (1965) *Animal Health: A Centenary 1865–1965*. Her Majesty's Stationery Office, London. (A history of the government veterinary service in the UK)
- OIE (1994) Early methods of animal disease control. *Revue Scientifique et Technique, Office International des Epizooties*, **13**, 332–614
- Pattison, I. (1984) *The British Veterinary Profession 1791–1948*. J.A. Allen, London
- Phalen, D. (Ed.) (2004) Emerging diseases. *Seminars in Avian and Exotic Pet Medicine*, **13**, 49–107. (Describes some emerging diseases in birds, exotic pets and wild animals)
- Prescott, L.M., Harley, J.P. and Klein, D.A. (2002) *Microbiology*, 5th edn. McGraw Hill, Boston. (Includes a concise description of the development of microbiology)
- Pritchard, W.R. (1986) Veterinary education for the 21st century. *Journal of the American Veterinary Medical Association*, **189**, 172–177. (A general review of contemporary veterinary requirements in developed countries)
- Pugh, L.P. (1962) *From Farriery to Veterinary Medicine, 1785–1795*. W. Heffer, Cambridge
- Saunders, L.Z. (1996) *A Biographical History of Veterinary Pathology*. Allen Press Inc., Lawrence. (An international history of veterinary pathology, including microbiology and parasitology, described through the lives of individuals)
- Schwabe, C.W. (1978) *Cattle, Priests, and Progress in Medicine*. The Wesley W. Spink lectures on comparative medicine, Vol. 4. University of Minnesota Press, Minneapolis. (A comparative history of veterinary and human medicine)
- Schwabe, C.W. (1993) The current epidemiological revolution in veterinary medicine. Part II. *Preventive Veterinary Medicine*, **18**, 3–16
- Sherman, D.M. (2002) *Tending Animals in the Global Village*. Lippincott Williams & Wilkins, Baltimore. (Includes a discussion of recent global trends in veterinary medicine)
- Shryock, R.H. (1961) Quantification. The history of quantification in medical science. In: *A History of the Meaning of Measurement in the Natural and Social Sciences*. Ed. Woolfe, H., pp. 85–107. The Bobbs-Merrill Company, Indianapolis
- Smith, F. (1976) *The Early History of Veterinary Literature*. 4 vols. J.A. Allen & Co, London
- Smithcors, J.F. (1957) *Evolution of the Veterinary Art*. Veterinary Medicine Publishing Company, Kansas City. (A general history of veterinary medicine to the 1950s)
- Spinage, C.A. (2003) *Cattle Plague: A History*. Kluwer Academic/Plenum Publishers, New York (An encyclopaedic history of rinderpest)
- Stalheim, O.V.H. (1994) *The Winning of Animal Health: 100 Years of Veterinary Medicine*. Iowa State University Press, Ames. (A history of veterinary medicine in the US)
- Súilleabháin, B.Ó. (1994) The evolution of the State Veterinary Services. *Irish Veterinary Journal*, **47**, 21–27
- Swabe, J. (1999) *Animals, Disease and Human Society. Human–Animal Relations and the Rise of Veterinary Medicine*. Routledge, London and New York
- Thrusfield, M. (1988) The application of epidemiological techniques to contemporary veterinary problems. *British Veterinary Journal*, **144**, 455–469
- Thrusfield, M. (1990) Trends in epidemiology. *Society for General Microbiology Quarterly*, **17**, 82–84
- US Department of Health and Human Resources (1998) *Preventing Emerging Infectious Diseases. A Strategy for the 21st Century*. US Department of Health and Human Resources, Centres for Disease Control and Prevention, Atlanta. (A comprehensive discussion of the control of emerging human infections in the US, but also including some general principles and details of zoonotic and foodborne infections)
- Waltner-Toews, D. and Lang, T. (2000) A new conceptual basis for food and agriculture policy: the emerging model of links between agriculture, food, health, environment and society. *Global Change & Human Health*, **1**, 116–130. (A debate of the future of food and farming)
- Waterson, A.P. and Wilkinson, L. (1978) *An Introduction to the History of Virology*. Cambridge University Press, Cambridge
- Wilkinson, L. (1992) *Animals and Disease: an Introduction to the History of Comparative Medicine*. Cambridge University Press, Cambridge
- Winslow, C.E.A. (1944) *The Conquest of Epidemic Disease*. Princeton University Press, Princeton. (A historical account of the control of infectious diseases)
- Worboys, M. (1991) Germ theories of disease and British veterinary medicine, 1860–1890. *Medical History*, **35**, 308–327

# 2

## The scope of epidemiology

Many contemporary disease problems can be solved by an investigation of animal populations rather than the individual. The natural history of infectious diseases can be understood by studying their distribution in different populations. The measurement of the amount of infectious and non-infectious diseases in a population assists in determining their importance and the efficacy of control campaigns. Complex and unknown causes of diseases can be elucidated by studying the diseases in various groups of animals. The effects of diseases on production can be realistically estimated only in relation to decreased production in the herd or flock, rather than in a single animal. The economic impact of disease and of attempts to control it similarly are evaluated best in groups of animals, ranging from the individual farm to the national level. The investigation of disease in **populations** is the basis of epidemiology.

### Definition of epidemiology

Epidemiology is the **study of disease in populations and of factors that determine its occurrence**; the key word being **populations**. Veterinary epidemiology additionally includes investigation and assessment of other health-related events, notably **productivity**. All of these investigations involve **observing** animal populations and making **inferences** from the observations.

A literal translation of the word 'epidemiology', based on its Greek roots *επι-* (*epi-*) = upon, *δημο-* (*demo-*) = people, and *λογο-* (*logo-*) = discoursing, is 'the study of that which is upon the people' or, in modern parlance, 'the study of disease in populations'<sup>1</sup>. Traditionally, 'epidemiology' related to studies of human populations, and 'epizootiology', from the

Greek *ζωο-* (*zoo-*) = animal, to the studies of animal (excluding human) populations (e.g., Karstad, 1962). Outbreaks of disease in human populations were called 'epidemics', in animal populations were called 'epizootics', and in avian populations were called 'epornitics', from the Greek *ορνιθ-* (*ornith-*) = bird (e.g., Montgomery *et al.*, 1979). Other derivatives, such as 'epideminein' ('to visit a community'), give hints of the early association between epidemiology and infections that periodically entered a community, in contrast to other diseases that were usually present in the population.

The various derivatives can be used in different contexts. A study of a disease that is present only in an animal population, such as *Brucella ovis* infection of sheep, would not involve a simultaneous study of disease in humans; the term 'epizootiology' might then be

---

<sup>1</sup> Two adjectives, 'epidemiologic' and 'epidemiological' are in use, the former being more common in North American publications, whereas the latter is usual in British literature. The shorter version has probably arisen because of the general human tendency to go for simpler forms wherever possible. In the case of '-ic' and '-ical' this tendency is helped by the fact that they are virtually interchangeable. '-ic-' (pedantically, '-ik-') is one of the commonest Greek suffixes used to turn a noun into an adjective, whereas -al- performs the same function in Latin. Very many adjectives of these types were borrowed into English, and native speakers became so familiar with both suffixes that they used them without any conscious reference to their linguistic origin (e.g., 'anecdote' is a Greek borrowing, and should really have 'anecdotic' as its adjective, instead of the hybrid 'anecdotal'). Moreover, it is a feature of both Latin and Greek to use adjectives syntactically as nouns, and this has been carried over when words have been borrowed into English, resulting in 'logic' (properly an adjective) being used as a noun. This was then converted to the common adjective, 'logical', using the Latin suffix. However, since many of the '-ic' forms also remained as adjectives (e.g., 'comic', 'classic'), doublets such as 'comic(al)' and 'classic(al)' arose. The existence of these doublets explains why 'epidemiologic' and 'epidemiological' are essentially identical, one not being 'more correct' than the other.

used by some to indicate that the study was confined to animals other than man. Many diseases, called **zoonoses**, may be shared by man and lower animals. Thus, when studying diseases such as bovine brucellosis and leptospirosis, both of which are zoonoses, mechanisms of transfer of disease between human and non-human populations have to be considered. An important factor that determines the occurrence of such occupationally acquired zoonoses (in veterinarians, abattoir workers and farmers in these examples) is the amount of disease in domestic animals. The 'epidemiology' of brucellosis and leptospirosis in dairy farmers is therefore closely associated with the 'epizootiology' of these diseases in cattle. The semantic differentiation between studies involving human diseases and those concerned with animal diseases therefore is considered neither warranted nor logical (Dohoo *et al.*, 1994). Throughout this book, the word 'epidemiological' is used to describe any investigation relating to disease in a population, whether or not the population consists of humans, domestic animals, or wildlife.

## The uses of epidemiology

There are five objectives of epidemiology:

1. determination of the origin of a disease whose cause is known;
2. investigation and control of a disease whose cause is either unknown or poorly understood;
3. acquisition of information on the ecology and natural history of a disease;
4. planning, monitoring and assessment of disease control programmes;
5. assessment of the economic effects of a disease, and analysis of the costs and economic benefits of alternative control programmes.

### Determination of the origin of a disease whose cause is known

Many diseases with a known cause can be diagnosed precisely by the signs exhibited by the affected animals, by appropriate laboratory tests and by other clinical procedures such as diagnostic imaging. For instance, the diagnosis of foot-and-mouth disease is relatively straightforward: the infection produces distinct clinical signs in most species (sheep can be an exception), and can be readily diagnosed in the laboratory. However, determining why an outbreak occurred is important in limiting its spread and eradicating the disease. For example, the first reported case of the UK epidemic in 2001 was in an abattoir in south-east England. However, epidemiological investigations revealed that the disease had originated on a

pig farm several hundred miles north (Gibbens *et al.*, 2001b), and it was only by careful tracing of movements of animals that had been exposed to infection at this source that the widespread dissemination of the virus through sheep marketing was identified, and appropriate national control measures therefore instituted (Mansley *et al.*, 2003).

There are many examples of the investigation of diseases with known causes that involve answering the questions 'Why has an outbreak occurred?' or 'Why has the number of cases increased?'. For instance, an increased number of actinobacillosis cases in a group of cattle might be associated with grazing a particular pasture of 'burnt-off' stubble. Such an occurrence could be associated with an increase in abrasions of the buccal mucosae, caused by abrasive ash, which could increase the animals' susceptibility to infection with *Actinobacillus lignieresii* (Radostits *et al.*, 1999). Similarly, consumption of prickly pears (*Opuntia* spp.) may be associated with an increased frequency of the disease in sheep, for a similar reason. An increased number of cases of bone defects in puppies might be due to local publicity being given to the use of vitamin supplements, resulting in their administration to animals that were already fed a balanced diet, with consequent hypervitaminosis D, inducing osteosclerosis and bone rarefaction (Jubb *et al.*, 1993). An increase in the number of lamb carcasses with high ultimate pH values could be associated with excessive washing of the animals prior to slaughter (Petersen, 1983). These possible explanations can be verified only by epidemiological investigations.

### Investigation and control of a disease whose cause is either unknown or poorly understood

There are many instances of disease control based on epidemiological observations before a cause was identified. Contagious bovine pleuropneumonia was eradicated from the US by an appreciation of the infectious nature of the disease before the causal agent, *Mycoplasma mycoides*, was isolated (Schwabe, 1984). Lancisi's slaughter policy to control rinderpest, mentioned in Chapter 1, was based on the assumption that the disease was infectious, even though the causal agent had not been discovered. Edward Jenner's classical observations on the protective effects of cowpox virus against human smallpox infection in the 18th century (Fisk, 1959), before viruses were isolated, laid the foundations for the global eradication of smallpox.

More recently, epidemiological studies in the UK suggested that cattle developed bovine spongiform encephalopathy following consumption of feedstuffs containing meat and bone meal contaminated with a scrapie-like agent (Wilesmith *et al.*, 1988). This was

sufficient to introduce legislation prohibiting the feeding of ruminant-derived protein, although the causal agent had not been identified at the time.

Although the exact cause of 'blood splashing' (ecchymoses in muscle) in carcasses is still not known, observations have shown that there is a correlation between this defect and electrical stunning by a 'head only' method (Blackmore, 1983); and the occurrence of this condition can be reduced by adopting a short 'stun-to-stick' interval, stunning animals with a captive bolt, or using a method of electrical stunning that causes concurrent cardiac dysfunction (Gracey *et al.*, 1999). Similarly, there is a strong correlation between grass sickness and grazing, and the disease can be almost totally prevented by stabling horses continuously during spring and summer, although the cause of the disease is unknown (Gilmour, 1989).

The cause of squamous cell carcinoma of the eye in Hereford cattle ('cancer eye') is not known. Epidemiological studies have shown that animals with unpigmented eyelids are much more likely to develop the condition than those with pigment (Anderson *et al.*, 1957). This information can be utilized by cattle breeders to select animals with a low susceptibility to this neoplasm.

Epidemiological studies are also used to identify causes of disease (many of which are multifactorial and initially poorly understood) so that the most appropriate disease control techniques can be applied. Thus, the identification of low levels of water intake as an important component of the cause of feline urolithiasis (Willeberg, 1981) facilitated control of this syndrome by dietary modification. Investigations can also be used to identify characteristics of animals that increase the risk of disease. For example, entire, nulliparous bitches with a history of oestrus irregularity, pseudopregnancy, and use of oestrus-suppression drugs are particularly at risk of developing pyometra (Fidler *et al.*, 1966; Niskanen and Thrusfield, 1998); this information is of diagnostic value to the clinician, and is of assistance when advising owners on breeding policy.

### Acquisition of information on the ecology and natural history of a disease

An animal that can become infected with an infectious agent is a **host** of that agent. Hosts and agents exist in communities that include other organisms, all of which live in particular environments. The aggregate of all facts relating to animals and plants is their **natural history**. Related communities and their environments are termed **ecosystems**. The study of ecosystems is **ecology**.

A comprehensive understanding of the natural history of infectious agents is possible only when they

are studied in the context of their hosts' ecosystems. Similarly, an improved knowledge of non-infectious diseases can be obtained by studying the ecosystems and the associated physical features with which affected animals are related. The geological structure of an ecosystem, for example, can affect the mineral content of plants and therefore can be an important factor in the occurrence of mineral deficiencies and excesses in animals.

The environment of an ecosystem affects the survival rate of infectious agents and of their hosts. Thus, infection with the helminth *Fasciola hepatica* is a serious problem only in poorly drained areas, because the parasite spends part of its life-cycle in a snail that requires moist surroundings.

Each of the 200 antigenic types (serovars) of *Leptospira interrogans* is maintained in one or more species of hosts. Serovar *copenhageni*, for instance, is maintained primarily in rats (Babudieri, 1958). Thus, if this serovar is associated with leptospirosis in either man or domestic stock, then part of a disease control programme must involve an ecological study of rat populations and control of infected rats. Similarly, in Africa, a herpesvirus that produces infections without signs in wildebeest is responsible for malignant catarrhal fever of cattle (Plowright *et al.*, 1960). Wildebeest populations, therefore, must be investigated when attempting to control the disease in cattle.

An ecosystem's climate also is important because it limits the geographical distribution of infectious agents that are transmitted by arthropods by limiting the distribution of the arthropods. For example, the tsetse fly, which transmits trypanosomiasis, is restricted to the humid parts of Sub-Saharan Africa (Ford, 1971).

Infectious agents may extend beyond the ecosystems of their traditional hosts. This has occurred in bovine tuberculosis in the UK, where the badger population is an alternative host for *Mycobacterium tuberculosis* (Little *et al.*, 1982; Wilesmith *et al.*, 1982) in which the disease has been refractory (Report, 2000). Similarly, in certain areas of New Zealand, wild opossums are infected with this bacterium and can therefore be a source of infection to cattle (Thorns and Morris, 1983). Purposeful routine observation of such infections provides valuable information on changes in the amount of disease and relevant ecological factors and may therefore indicate necessary changes in control strategies.

Infectious diseases that are transmitted by insects, ticks and other arthropods, and which may be maintained in wildlife, present complex ecological relationships and even more complex problems relating to their control. Comprehensive epidemiological studies of these diseases help to unravel their life-cycles, and can indicate suitable methods of control.



### Planning, monitoring and assessment of disease control programmes

The institution of a programme to either control or eradicate a disease in an animal population must be based on a knowledge of the amount of the disease in that population, the factors associated with its occurrence, the facilities required to control the disease, and the costs and benefits involved. This information is equally important for a mastitis control programme on a single dairy farm and for a national brucellosis eradication scheme involving all the herds in a country. The epidemiological techniques that are employed include the routine collection of data on disease in populations (**monitoring** and **surveillance**) to decide if the various strategies are being successful.

Surveillance is also required to determine whether the occurrence of a disease is being affected by new factors. For example, during the eradication scheme for bovine tuberculosis in New Zealand, opossums became infected in certain areas. New strategies had to be introduced to control this problem (Julian, 1981). During the foot-and-mouth disease epidemic in the UK in 1967 and 1968, surveillance programmes indicated the importance of wind-borne virus particles in the transmission of the disease (Smith and Hugh-Jones, 1969). This additional knowledge was relevant to the establishment of areas within which there was a restriction of animal movement, thus facilitating eradication of the disease.

### Assessing the economic effects of a disease and of its control

The cost of the control of disease in the livestock industry must be balanced against the economic loss attributable to the disease. Economic analysis therefore is required. This is an essential part of most modern planned animal health programmes. Although it may be economic to reduce a high level of disease in a herd or flock, it may be uneconomic to reduce even further the level of a disease that is present at only a very low level. If 15% of the cows in a herd were affected by mastitis, productivity would be severely affected and a control programme would be likely to reap financial benefit. On the other hand, if less than 1% of the herd were affected, the cost of further reduction of the disease might not result in a sufficient increase in productivity to pay for the control programme.

This introduction to the uses of epidemiology indicates that the subject is relevant to many areas of veterinary science. The general agricultural practitioner is now primarily concerned with herd health. The companion animal practitioner is faced with chronic refractory diseases, such as the idiopathic

dermatoses, which may be understood better by an investigation of the factors that are common to all cases. The state veterinarian cannot perform his routine duties without reference to disease in the national animal population. The diagnostic pathologist investigates the associations between causes and effects (i.e., lesions); this approach is epidemiological when inferences are made from groups of animals. The veterinarian in abattoirs and meat-processing plants attempts to reduce the occurrence of defects and contamination by understanding and eliminating their causes. Similarly, industrial veterinarians, concerned with the design of clinical trials, compare disease rates and response to treatment in groups of animals to which different prophylactic and therapeutic compounds are administered.

## Types of epidemiological investigation

There are four approaches to epidemiological investigation that traditionally have been called 'types' of epidemiology. These types are **descriptive**, **analytical**, **experimental** and **theoretical** epidemiology.

### Descriptive epidemiology

Descriptive epidemiology involves observing and recording diseases and possible causal factors. It is usually the first part of an investigation. The observations are sometimes partially subjective, but, in common with observations in other scientific disciplines, may generate hypotheses that can be tested more rigorously later. Darwin's theory of evolution, for example, was derived mainly from subjective observations, but with slight modification it has withstood rigorous testing by plant and animal scientists.

### Analytical epidemiology

Analytical epidemiology is the analysis of observations using suitable diagnostic and statistical procedures.

### Experimental epidemiology

Experimental epidemiologists observe and analyse data from groups of animals from which they can select, and in which they can alter, the factors associated with the groups. An important component of the experimental approach is the control of the groups. Experimental epidemiology developed in the 1920s and 1930s, and utilized laboratory animals whose short lifespans enabled events to be observed more rapidly than in humans (see Chapter 18). A notable example is the work of Topley (1942) who infected



colonies of mice with ectromelia virus and *Pasteurella* spp. The effects of varying the rate of exposure of mice maintained in groups of various sizes provided insights into the behaviour of human epidemic diseases such as measles, scarlet fever, whooping cough and diphtheria, which followed similar patterns to the experimental infections (MRC, 1938). This work demonstrated the importance of the proportion of susceptible individuals in the population in determining the progress of epidemics (see Chapter 8); hitherto, changes in the virulence of a microorganism were thought to be the most important factor affecting epidemic patterns; for example, the decline in the occurrence of rinderpest in the UK in the 18th century was ascribed to its passing into a mild form of the disease (Spinage, 2003).

Rarely, a 'natural' experiment can be conducted when the naturally occurring disease or other fortuitous circumstance approximates closely to the ideally designed experiment. For instance, when bovine spongiform encephalopathy occurred in the UK, outbreaks of the disease on the Channel Islands (Jersey and Guernsey), which maintain isolated populations of cattle, provided an ideal situation in which to study the disease, uncomplicated by the possibility of transmission by contact with infected animals (Wilesmith, 1993). This added credence to the hypothesis that the disease was transmitted in contaminated feedstuffs.

### Theoretical epidemiology

Theoretical epidemiology consists of the representation of disease using mathematical 'models' that attempt to simulate natural patterns of disease occurrence.

### Epidemiological subdisciplines

Various epidemiological subdisciplines<sup>2</sup> are now recognized. These generally reflect different areas of interest, rather than fundamentally different techniques. They all apply the four types of epidemiology described above, and can overlap, but their separate identities are considered by some to be justifiable<sup>3</sup>.

<sup>2</sup> The term 'subdiscipline' implies that epidemiology is a discipline. That it is, is generally accepted (Howe and Christiansen, 2004), following the criterion of Hirst (1965); namely, that a discipline involves certain central concepts that are peculiar in character and form. The central concept of epidemiology is measuring, and drawing inferences from, disease in populations.

<sup>3</sup> The author's preference is not to compartmentalize epidemiology, which implies an insular, specialists' *modus operandi* rather than a broad approach to problems. However, listing of subdisciplines is vindicated on the grounds that they are still widely cited.

### Clinical epidemiology

Clinical epidemiology is the use of epidemiological principles, methods and findings in the care of individuals, with particular reference to diagnosis and prognosis (Last, 2001), and therefore brings a numerate approach to traditional clinical medicine, which has tended to be anecdotal and subjective (Grufferman and Kimm, 1984). It is concerned with the frequency and cause of disease, the factors that affect prognosis, the validity of diagnostic tests, and the effectiveness of therapeutic and preventive techniques (Fletcher *et al.*, 1988; Sackett *et al.*, 1991), and therefore is an important component of **evidence-based medicine** (Polzin *et al.*, 2000; Sackett *et al.*, 2000; Cockcroft and Holmes, 2003; Marr *et al.*, 2003), which is concerned with patient care based on evidence from the best available studies.

### Computational epidemiology

Computational epidemiology involves the application of computer science to epidemiological studies (Habtemariam *et al.*, 1988). This includes the representation of disease by **mathematical models** (see 'Quantitative investigations', below) and the use of **expert systems**. These systems are commonly applied to disease diagnosis where they incorporate a set of rules for solving problems, details of clinical signs, lesions, laboratory results, and the opinions of experts; examples are identification of the cause of coughing in dogs (Roudebush, 1984), and the diagnosis of bovine mastitis (Hogeveen *et al.*, 1993). Expert systems are also employed in formulating disease control strategies (e.g., for East Coast fever: Gettinby and Byrom, 1989), predicting animal productivity (e.g., reproductive performance in dairy herds: McKay *et al.*, 1988), and supporting management decisions (e.g., decisions on replacing sows: Huirne *et al.*, 1991).

### Genetic epidemiology

Genetic epidemiology is the study of the cause, distribution and control of disease in related individuals, and of inherited defects in populations (Morton, 1982; Roberts, 1985; Khoury *et al.*, 1993). It indicates that the disciplinary boundary between genetics and epidemiology is blurred. Many diseases involve both genetic and non-genetic factors (see Chapter 5), and genes are increasingly incriminated in diseases of all organ systems (*Figure 2.1*). Thus, the geneticist and epidemiologist are both concerned with interactions between genetic and non-genetic factors – only the frequently indistinct time of interaction may be used to classify an investigation as genetic or epidemiological.

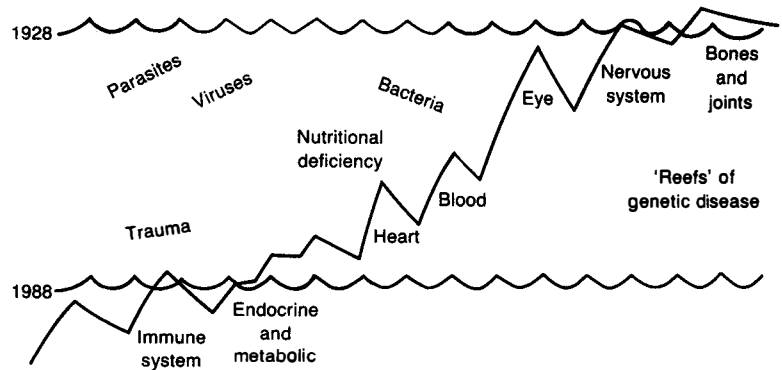

**Fig. 2.1** The discovery of the role of genes in the pathogenesis of disease. An analogy is made using the sea and reefs. The sea represents environmental factors (infectious and non-infectious); the reefs represent genetic factors. Only the reefs above the water level are known. As time passes, the water level falls, and more genetic factors are identified. (From Thrusfield, 1993; after Patterson, 1993.)

### Field epidemiology

Field epidemiology is the practice of epidemiology in response to problems of a magnitude significant enough to require a rapid or immediate action (Goodman and Buehler, 2002). For example, when outbreaks of foot-and-mouth disease occur, field epidemiologists promptly trace potential sources of infection in an attempt to limit spread of the disease (see Chapters 10 and 22). Field epidemiology is a timely, judgemental process based on description, analysis, common sense and the need to design practical control policies. It is sometimes termed 'shoe-leather epidemiology' because the investigator is often required to visit the field to study disease<sup>4</sup>.

### Participatory epidemiology

Awareness, in the 1980s, of the rudimentary development of veterinary services in some parts of the developing world, where animals were economically and socially important, prompted the use of local knowledge to gain information, with the main goal of improving animal health (Catley *et al.*, 2002a). The techniques that are employed evolved in the social sciences, and consist of simple visual methods and interviews to generate qualitative data. This approach became known as 'participatory appraisal' and its application in veterinary medicine is now termed 'participatory epidemiology'. It is a tool for the field epidemiologist, which is increasingly used in developing countries.

This area of interest is closely related to 'ethnoveterinary medicine' (McCorkle *et al.*, 1996; Martin *et al.*, 2001; Fielding, 2004), which is concerned with local

knowledge of, and practices relating to, the health of animals.

A brief introduction to participatory epidemiology is given in Chapter 10.

### Molecular epidemiology

New biochemical techniques now enable microbiologists and molecular biologists to study small genetic and antigenic differences between viruses and other microorganisms at a higher level of discrimination than has been possible using conventional serological techniques. The methods include peptide mapping, nucleic acid 'fingerprinting' and hybridization (Keller and Manak, 1989; Kricka, 1992), restriction enzyme analysis, monoclonal antibodies (Oxford, 1985; Goldspink and Gerlach, 1990; Goldspink, 1993) and the polymerase chain reaction (Belák and Ballagi-Pordány, 1993). For example, nucleotide sequencing of European foot-and-mouth disease virus has indicated that some outbreaks of the disease involved vaccinal strains, suggesting that improper inactivation or escape of virus from vaccine production plants may have been responsible for the outbreaks (Beck and Strohmaier, 1987). Sequencing has also indicated that unrestricted animal movement is a major factor in dissemination of the disease in West Africa (Sangaré *et al.*, 2004).

Additionally, infections that hitherto have been difficult to identify are now readily distinguished using these new molecular techniques; examples are infection with *Mycobacterium paratuberculosis* (the cause of Johne's disease) (Murray *et al.*, 1989) and latent infection with Aujeszky's disease virus (Belák *et al.*, 1989). The application of these new diagnostic techniques constitutes molecular epidemiology. A general description of the methods is given by Persing *et al.* (1993).

Molecular epidemiology is part of the wider use of biological markers (Hulka *et al.*, 1990). These are

<sup>4</sup> This contrasts with 'armchair epidemiology': a term (sometimes used cynically) referring to the analysis of data within the confines of one's office.

cellular, biochemical or molecular alterations that are measurable in biological media such as tissues, cells or fluids. They may indicate susceptibility to a causal factor, or a biological response, suggesting a sequence of events from exposure to disease (Perera and Weinstein, 1982). Some have been used by veterinarians for many years, for instance serum magnesium levels as indicators of susceptibility to clinical hypocalcaemia (Whitaker and Kelly, 1982; van de Braak *et al.*, 1987), serum transaminase levels as markers for liver disease, and antibodies as indicators of exposure to infectious agents (see Chapter 17).

### Other subdisciplines

Several other epidemiological subdisciplines have also been defined. **Chronic disease epidemiology** is involved with diseases of long duration (e.g., cancers), many of which are non-infectious. **Environmental epidemiology** is concerned with the relationship between disease and environmental factors such as industrial pollution and, in human medicine, occupational hazards. Domestic animals can act as monitors of environmental hazards and can provide early warning of disease in man (see Chapter 18). **Micro-epidemiology** is the study of disease in a small group of individuals with respect to factors that influence its occurrence in larger segments of the population. For example, studies of feline acquired immunodeficiency syndrome (FAIDS) in groups of kittens have provided insights into the widespread human disease, AIDS (Torres-Anjel and Tshikuka, 1988; Bendinelli *et al.*, 1993). Micro-epidemiology, which frequently uses animal biological models of disease, therefore is closely related to **comparative epidemiology** (see Chapter 18). In contrast, **macro-epidemiology** is the study of national patterns of disease, and the social, economic and political factors that influence them (Hueston and Walker, 1993; Hueston, 2001). Other subdisciplines, such as **nutritional epidemiology** (Willett, 1990; Slater 1996b), **subclinical epidemiology** (Evans, 1987), and, specifically in human medicine, **social epidemiology** (Kasl and Jones, 2002) and **psychosocial epidemiology** (Martikainen *et al.*, 2002) can also be identified to reflect particular areas of interest.

### Components of epidemiology

The components of epidemiology are summarized in *Figure 2.2*. The first stage in any investigation is the collection of relevant data. The main sources of information are outlined in Chapter 10. Investigations can be either **qualitative** or **quantitative** or a combination of these two approaches.

## Qualitative investigations

### The natural history of disease

The ecology of diseases, including the distribution, mode of transmission and maintenance of infectious diseases, is investigated by field observation. Ecological principles are outlined in Chapter 7. Methods of transmission and maintenance are described in Chapter 6, and patterns of disease occurrence are described in Chapter 8. Field observations also may reveal information about factors that may directly or indirectly cause disease. The various factors that act to produce disease are described in Chapter 5.

### Causal hypothesis testing

If field observations suggest that certain factors may be causally associated with a disease, then the association must be assessed by formulating a causal hypothesis. Causality (the relating of causes to effects) and hypothesis formulation are described in Chapter 3.

Qualitative investigations were the mainstay of epidemiologists before the Second World War. These epidemiologists were concerned largely with the identification of unknown causes of infectious disease and sources of infection. Some interesting examples of the epidemiologist acting as a medical 'detective' are described by Roueché (1991) and Ashton (1994).

## Quantitative investigations

Quantitative investigations involve measurement (e.g., the number of cases of disease), and therefore expression and analysis of numerical values. Basic methods of expressing these values are outlined in Chapters 4 and 12. The types of measurement that are encountered in veterinary medicine are described in Chapter 9. Quantitative investigations include **surveys, monitoring and surveillance, studies, modelling, and the biological and economic evaluation of disease control**. Some of these may be confined within the walls of the research organization – '**armchair epidemiology**'.

### Surveys

A survey is an examination of an aggregate of units (Kendall and Buckland, 1982). A group of animals is an example of an aggregate. The examination usually involves counting members of the aggregate and characteristics of the members. In epidemiological surveys, characteristics might include the presence of particular diseases, or production parameters such as milk yield. Surveys can be undertaken on a **sample** of the population. Less commonly, a **census**, which examines the

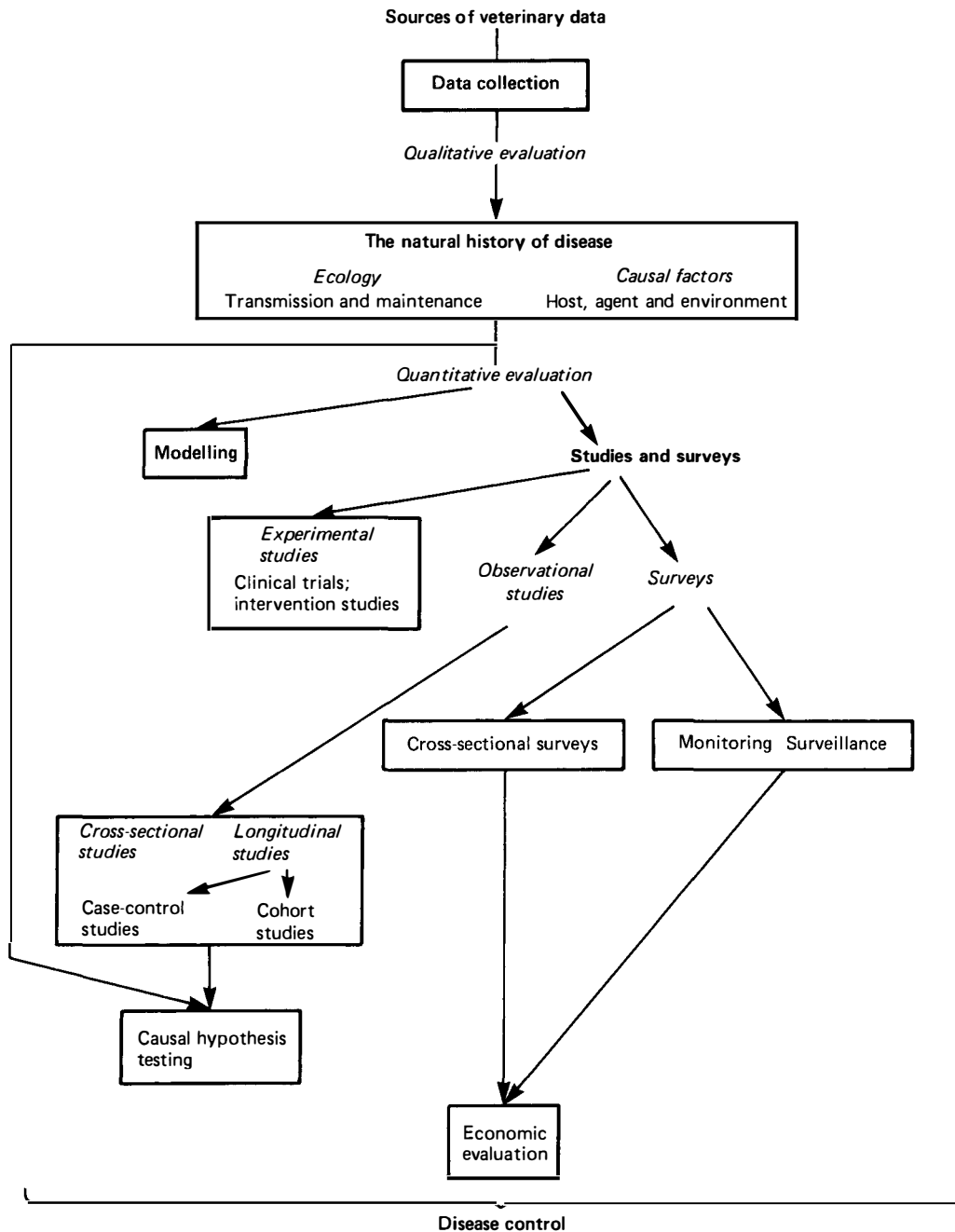

Fig. 2.2 Components of veterinary epidemiology. (Based on Thrusfield, 1985a.)

total animal population, can be undertaken (e.g., tuberculin testing). A **cross-sectional** survey records events occurring at a particular point in time. A **longitudinal** survey records events over a period of time. These latter events may be recorded **prospectively** from the present into the future; or may be a **retrospective** record of past events.

A particular type of diagnostic survey is **screening**. This is the identification of undiagnosed cases of disease using rapid tests or examinations. The aim is to separate apparently healthy individuals that probably

have a disease from those that probably do not. Screening tests are not intended to be diagnostic; individuals with positive test results (i.e., that are classified as diseased by the screening test) usually require further investigation for definite diagnosis. They therefore differ from diagnostic tests, which are applied to animals showing suspicion of disease.

Screening frequently involves investigation of the total population (**mass screening**); for example, the screening of cattle populations for tuberculosis. It may also be targeted at animals only in areas where there

have been cases of disease (**strategic screening**); for example, the serological sampling of sheep within a 3-km radius of premises on which foot-and-mouth disease has been diagnosed (Donaldson, 2000). **Pre-scriptive screening** aims at early identification of diseases that can be controlled better if they are detected early in their pathogenesis (e.g., mammography to detect breast cancer in women).

Screening also may be applied more generally to include the measurement of any characteristic or health problem which may not be apparent in a population (e.g., measurement of heavy metal levels in wild and domesticated animals) (Toma *et al.*, 1999).

Diagnostic tests and screening are considered in Chapter 17. The design of surveys in general is described in Chapter 13.

### Monitoring and surveillance

**Monitoring** is the making of routine observations on health, productivity and environmental factors and the recording and transmission of these observations. Thus, the regular recording of milk yields is monitoring, as is the routine recording of meat inspection findings at abattoirs. The identity of individual diseased animals usually is not recorded.

**Surveillance** is a more intensive form of data recording than monitoring. Originally, surveillance was used to describe the tracing and observation of people who were in contact with cases of infectious disease. It is now used in a much wider sense (Langmuir, 1965) to include all types of disease – infectious and non-infectious – and involves the collation and interpretation of data collected during monitoring programmes, usually with the recording of the identity of diseased individuals, with a view to detecting changes in a population's health. It is normally part of control programmes for specific diseases. The recording of tuberculosis lesions at an abattoir, followed by tracing of infected animals from the abattoir back to their farms of origin, is an example of surveillance. The terms 'monitoring' and 'surveillance' have previously been used synonymously, but the distinction between them is now generally accepted.

Surveillance is discussed in detail in Chapter 10.

### Studies

'Study' is a general term, which refers to any type of investigation. However, in epidemiology, a study usually involves **comparison** of groups of animals; for example, a comparison of the weights of animals that are fed different diets. Thus, although a survey generally could be classified as a study, it is excluded from epidemiological studies because it involves only description rather than comparison and the analysis

that the comparison requires. There are four main types of epidemiological study:

1. experimental studies;
2. cross-sectional studies;
3. case-control studies;
4. cohort studies.

In an **experimental study** the investigator has the ability to allocate animals to various groups, according to factors that the investigator can randomly assign to animals (e.g., treatment regimen, preventive technique); such studies are therefore part of experimental epidemiology. An important example is the **clinical trial**. In a clinical trial, the investigator assigns animals either to a group to which a prophylactic or therapeutic procedure is applied, or to a control group. It is then possible to evaluate the efficacy of the procedure by comparing the two groups. Clinical trials are discussed in Chapter 16.

The other types of study – cross-sectional, case-control and cohort – are **observational**. An observational study is similar to an experimental study: animals are allocated to groups with respect to certain characteristics that they possess (trait, disease or other health-related factors). However, observational studies are conducted on naturally occurring cases of disease in the field, and so it is not possible to assign animals to groups randomly because the investigator has little control over the factors that are being studied. For instance, a study of the relationship between bovine mastitis, type of housing and management practices would involve investigation of cases of the disease on farms under different systems of husbandry.

A **cross-sectional study** investigates relationships between disease and hypothesized causal factors in a specified population. Animals are categorized according to presence and absence of disease and hypothesized causal factors; inferences then can be made about associations between disease and the hypothesized causal factors, for example, between heart valve incompetence (the disease) and breed (the hypothesized causal factor).

A **case-control study** compares a group of diseased animals with a group of healthy animals with respect to exposure to hypothesized causal factors. For example, a group of cats with urolithiasis (the disease) can be compared with a group of cats without urolithiasis with respect to consumption of dry cat food (the factor) to determine whether that type of food has an effect on the pathogenesis of the disease.

In a **cohort study**, a group exposed to factors is compared with a group not exposed to the factors with respect to the development of a disease. It is then possible to calculate a level of risk of developing the disease in relation to exposure to the hypothesized causal factors. For instance, a group of young neutered bitches can

be compared with a group of young entire bitches with respect to the development of urinary incontinence, to ascertain if neutering is a risk factor for the condition.

Case-control and cohort studies often have been applied in human medicine in which experimental investigations of cause are usually unethical. For example, it would not be possible to investigate the suspected toxicity of a drug by intentionally administering the drug to a group of people in order to study possible side-effects. However, if symptoms of toxicity have occurred, then a case-control study could be used to evaluate the association between the symptoms and the drug suspected of causing the toxicity. Some argue that there are fewer ethical restraints on experimental investigation in veterinary medicine than in human medicine and so experimental investigation of serious conditions is more tenable. However, observational studies have a role in veterinary epidemiology, for example when investigating diseases in farm and companion-animal populations. Moreover, the increasing concern for animal welfare (see Chapter 1) is making these techniques even more attractive and useful than previously.

Basic methods of assessing association between disease and hypothesized causal factors in observational studies are described in Chapters 14 and 15.

Observational studies form the majority of epidemiological studies. Observational and experimental science have their own strengths and weaknesses, which are discussed in detail by Trotter (1930). A major advantage of an observational investigation is that it studies the natural occurrence of disease. Experimentation may separate factors associated with disease from other factors that may have important interactions with them in natural outbreaks.

## Modelling

Disease dynamics and the effects of different control strategies can be represented using mathematical equations. This representation is 'modelling'. Many modern methods rely heavily on computers. Another type of modelling is biological simulation using experimental animals (frequently laboratory animals) to simulate the pathogenesis of diseases that occur naturally in animals and man. Additionally, the spontaneous occurrence of disease in animals can be studied in the field (e.g., using observational studies) to increase understanding of human diseases. Mathematical modelling is outlined in Chapter 19, and spontaneous disease models are described in Chapter 18.

## Risk assessment

There is increasing and widespread interest in evaluation of the **risk** of the occurrence of adverse events,

such as accidents and disasters (Report, 1983, 1992). The analysis, perception and management of risk therefore have been the focus for the development of formal methods of qualitative and quantitative **risk assessment** (Stewart, 1992; Vose, 2000).

In veterinary medicine, disease is an adverse event, and observational studies provide a framework for identifying risk factors for disease occurrence. However, veterinary risk assessment has a much broader remit than identifying risks to the individual animal. For example, although diseases may occur at low levels and be adequately controlled, there may be a risk of importing them from other countries. Such a risk can only be removed completely if importation is totally prohibited. However, current political pressures in the world favour movement towards free trade, and the unquantified risk of introduction of a disease can now no longer be presented as a trade barrier. There is therefore a need to assess objectively the risks associated with the importation of livestock and their products. Examples include the risk of disease transmission by bovine embryo transfer (Sutmoller and Wrathall, 1995) and the risk of introduction of bovine spongiform encephalopathy (Wahlström *et al.*, 2002). Similarly, the risk of disease transmission between animals (e.g., transmission of *Mycobacterium tuberculosis* from badgers to cattle: Gallagher *et al.*, 2003) can be assessed.

**Microbiological risk assessment** (Kelly *et al.*, 2003) commonly is concerned with food safety risks, and involves estimation of the magnitude of microbial exposure at various stages in the production chain (rearing on the farm; transport and processing; retail and storage; preparation), so that the risk of foodborne infection can be estimated. It has been applied notably to *Campylobacter* spp. (e.g., Rosenquist *et al.*, 2003) and *Salmonella* spp. (e.g., Oscar, 1998) infections. The approach has also been used to assess the contribution of animal growth promoters to the transfer of antibiotic resistance to pathogens in humans (Kelly *et al.*, 2003).

Some aspects of import risk assessment are presented in Chapter 17.

## Disease control

The goal of epidemiology is to improve the veterinarian's knowledge so that diseases can be controlled effectively, and productivity thereby optimized. This can be fulfilled by treatment, prevention or eradication. The economic evaluation of disease and its control is discussed in Chapter 20. Herd health schemes are described in Chapter 21. Finally, the principles of disease control are outlined in Chapter 22.

The different components of epidemiology apply the four epidemiological approaches to varying degrees.

Surveys and studies, for example, consist of a descriptive and an analytical part. Modelling additionally may include a theoretical approach.

## Epidemiology's locale

### The interplay between epidemiology and other sciences

During the first half of the 20th century most epidemiologists were trained initially as bacteriologists, reflecting epidemiologists' early involvement in the qualitative investigation of outbreaks of infectious disease. As the century proceeded, epidemiology became established in the context of the ecology of infectious diseases, and was addressed as such in the standard veterinary and infectious-disease textbooks (e.g., Blood and Henderson, 1960; Andrewes and Pereira, 1964). The epidemiological approach, however, is now practised by veterinarians from many disciplines: the geneticist concerned with an hereditary defect in a population, the nutritionist investigating a deficiency or toxicity, and the clinician concerned with risk factors for non-infectious diseases such as cancer.

Today, members of a variety of other sciences also take part in epidemiological studies: statisticians analysing data from groups of animals, mathematicians modelling diseases, economists assessing the economic impact of disease, and ecologists studying the natural history of disease. Each of these sciences is concerned with different facets of epidemiology, ranging from the purely descriptive, qualitative approach to the quantitative analytical approach. There have been many definitions of epidemiology (Lilienfield, 1978), which reflect these facets. These definitions vary from the ecological, relating only to infectious diseases ('the study of the ecology of infectious diseases': Cockburn, 1963), to the mathematical, referring only to human populations ('the study of the distribution and dynamics of diseases in human populations': Sartwell, 1973). However, they all have the study of populations in common, and so are encompassed by the broad definition that was given at the beginning of this chapter. Moreover, the most profitable approach to epidemiology lies in balance between these qualitative and quantitative facets, with neither dominating the other<sup>5</sup>, and in an appreciation that the validity of

qualitative and quantitative research may be judged differently (Park, 1989; Maxwell, 1992).

### The relationship between epidemiology and other diagnostic disciplines

The biological sciences form a hierarchy, ranging from the study of non-replicating molecules to nucleic acids, organelles, cells, tissues, organs, systems, individuals, groups and, finally, whole communities and ecosystems (Wright, 1959). The various disciplines in veterinary medicine operate at different levels in this hierarchy. Histologists and physiologists study the structure and dynamics of the individual. Clinicians and pathologists are concerned with disease processes in the individual: clinicians diagnose disease using signs displayed by the patient; pathologists interpret lesions to produce a diagnosis. Epidemiologists investigate populations, using the frequency and distribution of disease to produce a diagnosis. These three diagnostic disciplines, operating at different levels in the hierarchy, are complementary (Schwabe *et al.*, 1977). Epidemiologists, dealing with the higher levels, must have a knowledge of those disciplines 'lower' in the hierarchy – they must be able to see both the 'wood' and 'trees'<sup>6</sup>. This means that they must adopt a broad rather than a specialist approach, avoiding the dangers of the specialist; dangers that have been described (somewhat cynically) by Konrad Lorenz (1977) in his book on the natural history of human knowledge:

'The specialist comes to know more and more about less and less, until finally he knows everything about a mere nothing. There is a serious danger that the specialist, forced to compete with his colleagues in acquiring more and more specialised knowledge, will become more and more ignorant about other branches of knowledge, until he is utterly incapable of forming any judgement on the role and importance of his own sphere within the context of human knowledge as a whole.'

Moreover, the specialist may be inclined to a 'positivist' approach (see Chapter 3), which requires strict separation of the object of inquiry from the investigating subject (and therefore, sometimes, the investigator) and thus may be somewhat divorced from the consequences of the knowledge that he generates, which may have profound social and economic effects.

Thus, the major attributes required to become a competent veterinary epidemiologist are a natural

<sup>5</sup> The need for balance between different disciplines with a common interest is acknowledged in several areas of endeavour. For example, a healthy relationship between philosophy and theology is beneficial, with the philosopher providing the theologian with useful methods of argument; this contrasts with periods when the relationship between these disciplines has been marked by acute controversy, with little benefit accruing (Macquarrie, 1998).

<sup>6</sup> Although the epidemiologist – operating at the higher levels – has always been concerned with the characteristics and effects of disease in populations and ecosystems, this interest has been freshly labelled 'conservation medicine' and 'ecological health' (Aguirre *et al.*, 2002).

curiosity, a logical approach, a general interest in, and knowledge of, veterinary medicine, and experience of the realities of animal disease. In spite of the preceding remarks on specialists, a special interest and expertise in a particular sphere of veterinary science may, however, be useful in some investigations, for example, a knowledge of economics when undertaking an evaluation of the economic effects of disease.

### Epidemiology within the veterinary profession

Brandeis (1971) proposed three 'peculiar characteristics' of a profession, as distinguished from other occupations:

'First. A profession is an occupation for which the necessary training is intellectual in character, involving knowledge and to some extent learning, as distinguished from mere skill. Second. It is an occupation which is pursued largely for others and not merely for one's self. Third. It is an occupation in which the amount of financial return is not the accepted measure of success.'

The practice of clinical veterinary medicine is entirely congruous with these characteristics, and there is a similar consistency in the five objectives of veterinary epidemiology, outlined earlier in this chapter, which all focus on the control of animal disease, to the benefit of animals, their owners, and society in general.

### Further reading

- Ashton, J. (Ed.) (1994) *The Epidemiological Imagination: a Reader*. Open University Press, Buckingham
- Davies, G. (1983) Development of veterinary epidemiology. *Veterinary Record*, **112**, 51–53
- Davies, G. (1985) Art, science and mathematics: new approaches to animal health problems in the agricultural industry. *Veterinary Record*, **117**, 263–267
- Ferris, D.H. (1967) Epizootiology. *Advances in Veterinary Science*, **11**, 261–320. (*An early description of veterinary epidemiology*)
- Hungerford, L.L. and Austin, C.C. (1994) Epidemiological investigation of disease and health in feline populations. In: *Consultations in Feline Internal Medicine 2*, Ed. August, J.R., pp. 593–606. W.B. Saunders, Philadelphia
- James, A. (2005) The state of veterinary epidemiology and economics. *Preventive Veterinary Medicine*, **67**, 91–99
- Martin, S.W. (1998) Art, science and mathematics revisited: the role of epidemiology in promoting animal health. In: *Society for Veterinary Epidemiology and Preventive Medicine, Proceedings, Ennis, 25–28 March 1998*, Eds Thrusfield, M.V. and Goodall, E.A., pp. xi–xxii
- Morabia, A. (Ed.) (2004) *A History of Epidemiologic Methods and Concepts*. Birkhäuser Verlag, Basel
- Nutter, F.W. (1999) Understanding the interrelationships between botanical, human, and veterinary epidemiology: the Ys and Rs of it all. *Ecosystem Health*, **5**, 131–140
- Rapport, D.J. (1999) Epidemiology and ecosystem health: natural bridges. *Ecosystem Health*, **5**, 174–180
- Riemann, H. (1982) Launching the new international journal 'Preventive Veterinary Medicine'. *Preventive Veterinary Medicine*, **1**, 1–4
- Scarlett, J.M. (1995) Companion animal epidemiology. *Preventive Veterinary Medicine*, **25**, 151–159
- Smith, G.D. and Ebrahim, S. (2001) Epidemiology – is it time to call it a day? *International Journal of Epidemiology*, **30**, 1–11
- Thrusfield, M. (1992) Quantitative approaches to veterinary epidemiology. In: *The Royal Veterinary College Bicentenary Symposium Series: The Advancement of Veterinary Science, London 1991. Volume 1: Veterinary Medicine beyond 2000*. Ed. Michell, A.R., pp. 121–142. Commonwealth Agricultural Bureaux, Farnham Royal
- Thrusfield, M. (2001) Changing perspectives in veterinary epidemiology. *Polish Journal of Veterinary Sciences*, **4**, 19–25
- Wilson, G. (1974) The use of epidemiology in animal disease. *British Veterinary Journal*, **130**, 207–213
- Wing, S. (1994) Limits of epidemiology. *Medicine and Global Survival*, **1**, 74–86



# 3

## Causality

---

Chapter 1 included a brief historical description of changing concepts of the cause of disease. This chapter initially discusses the cause of events more generally, as a necessary background to the investigation of the cause of disease, which follows.

### Philosophical background

**Causality (causation)** deals with the relationship between cause and effect, and is addressed in both science and philosophy. The scientist is primarily concerned with identification of causes to explain natural phenomena, whereas the philosopher attempts to understand the nature of causality, including its role in human actions (Vollmer, 1999). The philosopher provides an insight into the theory of the grounds of knowledge (formally termed 'epistemology'); and so a basic knowledge of the philosophy of causality contributes to the scientist's ability to assess the validity and limitations of his inferences in the broader context of human knowledge as a whole. Concepts of causality have progressed historically, as new areas of interest emerge (e.g., the recent interest in causality in relation to artificial intelligence: Shafer, 1996).

### The Classical period

In Classical times, Aristotle defined a doctrine of four causes (Barnes, 1984). These four 'causes' are really four different explanations or reasons for how and why a thing is as it is: (1) the **material cause** – what 'stuff' (matter) a thing comprises (some combination of the four elements: earth, air, fire and water: *Figure 1.2*); (2) the **formal cause** – the 'form and pattern' of a thing, or those properties without which a thing would not exist as it does; (3) the **efficient cause** – which is the

maker of a thing (and by which the formal cause is therefore explained); and (4) the **final cause** – which is the purpose of the thing (and therefore, in the case of natural things, usually synonymous with the formal cause). The notion of the 'universe of natural law' as a cause of disease (see Chapter 1) was consistent with this philosophy. Aristotle's emphasis lay on *purpose* as the only satisfactory explanation of why a thing is; and his doctrine failed to account for certain natural phenomena (e.g., why bodies accelerate while falling).

### The Scholastics

The Christian mediæval philosophers (termed the 'Scholastics') generally endorsed Aristotle's ideas<sup>1</sup>, but focussed on God as the efficient cause of all things (a view posited by St Thomas Aquinas in his *Summa Theologica*)<sup>2</sup>. The notion that disease was induced by divine wrath (see Chapter 1) was consistent with this philosophy. The extent to which individuals were secondary efficient causes of things, with God as the primary cause, was a subject of debate during this period.

### The 'Modern' period

Debate on causality expanded substantially during the so-called 'Modern' period of philosophy. Beginning

---

<sup>1</sup> The origins of Scholasticism can be traced back to the sixth-century Roman philosopher, Boethius (Rand, 1928) and Aristotle's influence was pre-eminent in mediæval universities, only being tempered by a broader philosophical curriculum in the late 14th century, possibly as a result of the teachings of the Byzantine scholar, Manuel Chrysoloras, who was brought to Florence in 1397 by the Chancellor of the city, Coluccio Salutati.

<sup>2</sup> This idea had a wide influence, for example, on the concept that right and wrong are absolute – a notion that was tempered by one that they are determined by circumstances (termed 'casuistry': Dewar, 1968).

with the French philosopher, René Descartes (1596–1650), the debate (which was an integral part of ‘The Enlightenment’: see Chapter 1) was complex, but essentially aimed to simplify and secularize the Classical and Scholastic concepts of causality (Clatterbaugh, 1999).

In science, the erosion of the Classical and Scholastic view had begun with Galileo. In his book, *Discorsi e Dimostrazioni Matematiche* (published in 1638), he emphasised the need to explain events mathematically in terms of ‘how’ (description), and ‘why’ (explanation). This was prompted, in part, by increasing mechanization and the consequent need for engineers to predict the effects of different designs (e.g., of ships, as navigation extended throughout the world). Increasingly, in science, a physical and mathematical explanation for natural phenomena was sought, and the techniques of causal inference were debated.

## Causal inference

Scientific conclusions are derived by two methods of reasoning: **deduction**, and **induction**<sup>3</sup>. Deduction is arguing from the general to the particular; that is, a general case is established, from which all dependent events are argued to be true. For example, in Euclidean geometry, axioms are established, from which specific theorems (e.g., Pythagoras’ Theorem) are then reasoned. Thus, if one posits the truth of the general proposition ‘all dogs are mammals’, it follows by deduction that any particular example of a dog will be a mammal. If the premisses of a deductively valid argument are true, it follows that the conclusion must also be true.

Induction, in contrast, is arguing from the particular to the general. For instance, a dog may be vaccinated against distemper virus, and shown to be immune to challenge with the agent, from which the conclusion is drawn that the vaccine prevents distemper in all dogs. It is important to note that, unlike the deductive example, the premiss in this example could be true and yet the conclusion false.

Induction has generally driven modern scientific investigation, requiring detached observation of events, and is frequently associated with ‘positivism’, a philosophical term describing scientific study based on the objective analysis of data, which excludes unverifiable speculation (*Britannica*, 1992)<sup>4</sup>. The

English theologian and philosopher, Thomas Bayes (1702–61) was the first to apply statistical probability inductively (Bayes, 1763). His method, eponymously named ‘Bayesian inference’, involves calculating, from the frequency with which an event had occurred previously (the ‘prior probability’), the probability that it will occur in the future (the ‘posterior probability’). The Bayesian view of probability is a way of registering degrees of belief, which may be strengthened or weakened by numerical data. A notable example of the Bayesian method is calculation of the probability of disease in an individual, depending on results of diagnostic tests (see Chapter 17).

Induction was later addressed in some detail by the 19th century English philosopher, John Stuart Mill (1868), whose ‘canons’ of inductive reasoning are still widely used in epidemiology, and are outlined and exemplified later in this chapter. However, the validity of induction as a demonstration of proof had already been challenged by the scepticism of the 18th century Scottish philosopher David Hume (1739–40), whose ideas are still the subject of debate (Strawson, 1989). Hume argued that the mere observation that one event preceded another (e.g., that a vaccine against canine distemper is observed to confer immunity to distemper virus when administered to a dog) was not *proof* that the former was the cause of the latter; because, first, even if the observation were repeated many times, coincidence could not be excluded, and, secondly, previous patterns cannot be guaranteed to continue in the future. Logically, then, inductive proof of a hypothesis<sup>5</sup> is impossible. It is, however, possible to refute a hypothesis by observing events that conflict with it on a single occasion<sup>6</sup>. This led the philosopher,

---

‘full picture’. For example, during the 2001 epidemic of foot-and-mouth disease in the UK, field investigations revealed uncorroborated suspicion of transmission of the disease by undisclosed movements of livestock, thereby providing a fuller explanation of the disease’s spread (Gibbens *et al.*, 2001b) – an approach with which positivists would be unsympathetic. In the social sciences, the need to locate oneself ‘within’ the area of research now is accepted as fundamental to the analytical procedure, and is formally termed ‘experiential analysis’ (Reinharz, 1983). This is similar to the acquisition of ‘interactive knowledge’, which is obtained by direct involvement with, and experience of, society (Habermas, 1972). Moreover, positivism excludes moral and ethical judgements (for example, on the social and psychological effects of a particular disease control campaign: Mephram, 2001), which are made possible only by reflection – so-called ‘critical knowledge’ (Habermas, 1972).

<sup>5</sup> A hypothesis is a theory that is not well tested. This contrasts with laws and facts. (See Chapter 19 for a fuller discussion.)

<sup>6</sup> Probably the commonest example quoted in the literature is of the cockerel and the sunrise. The crowing of the cockerel always precedes the rising of the sun. However, the hypothesis that the cockerel causes the sun to rise can be refuted by strangling it before dawn. The 20th century philosopher, Bertrand Russell, gives another poultry example: an ‘inductivist turkey’ who reasons to the effect that, since every day in the past he has been fed at nine o’clock by the farmer, he will today again be fed as the farmer approaches at nine o’clock, as usual – but today it is Christmas Eve!

<sup>3</sup> This is a simplification, which is inevitable in a brief introduction. A short, but scholarly, discussion is provided by Medawar (1969).

<sup>4</sup> This approach, which generates ‘instrumental knowledge’, has become synonymous with contemporary scientific method, but represents only one way of acquiring knowledge (Feyerabend, 1975; Giddens, 1987; Uphoff, 1992; Liamputton and Ezzy, 2005), and may not present the

Karl Popper (1959), to conclude that science advances only by elimination of hypotheses<sup>7</sup>.

In epidemiology, studies are generally undertaken to identify causes of disease so that preventive measures can be developed and implemented, and their subsequent effectiveness identified (Wynder, 1985). Such investigations of cause are usually based on inductive reasoning, which, despite its philosophical deficiencies, still forms the pragmatic basis on which most conclusions need to be drawn in epidemiology and other sciences, and on which a workable definition of 'proof' is based<sup>8</sup>.

## Methods of acceptance of hypotheses

One may accept (or reject) a causal hypothesis by four methods (Cohen and Nagel, 1934):

1. tenacity;
2. authority;
3. intuition;
4. scientific inquiry.

### Tenacity

Habit makes it easy to continue to believe a proposition and to offer a closed mind either to the opinions of others or to evidence that contradicts the proposition. Thus, some people continued to believe that smoking was beneficial because it 'cleared the chest', even after Doll (1959) provided evidence that it induced lung cancer. The method of tenacity is unsatisfactory because it disregards the opinions of others, and, if they are considered, provides no framework for choosing between them.

### Authority

Sometimes, appeal is made to a highly respected source to substantiate views. First, this may involve an appeal to an allegedly infallible source. This is, for instance, the basis of religious beliefs. However, this

cannot lead to unanimity or stability of belief because there may be a variety of conflicting sources<sup>9</sup>.

Secondly, appeal may be made to the opinions of experts, whose authority is generally acknowledged. This is a reasonable and widely used approach. However, experts' opinions may vary, and such authority is only relatively final because opinions may be modified in the light of new knowledge or more convincing arguments.

### Intuition

Some propositions may be considered to be self-evident, without being sustained by evidence. Thus, many veterinarians judged speed of slaughter of animals on infected premises to be crucial in the control of foot-and-mouth disease before firm evidence in support of this proposition was presented (Honhold *et al.*, 2004; Thrusfield *et al.*, 2005b). Intuition may be moulded by training, experience and fashion. However, intuitive notions (e.g., that the Earth is flat) may subsequently be shown to be false. Therefore, intuitions need to be tested.

Tenacity, authority and intuition may all contribute, to varying degrees, to an individual's belief in the veracity of a hypothesis, and such belief can be insidious, colouring scientific investigation – a danger highlighted by Sir Peter Medawar, former Director of the National Institute for Medical Research, London (1979):

'... the intensity of the conviction that a hypothesis is true has no bearing on whether it is true or not.'

### Scientific inquiry

Clarity, order and consistency in fixing beliefs, independent of the idiosyncrasies of a few individuals, are required. This is the basis of scientific inquiry, which involves making objective observations that can be repeated by many investigators. Scientific method encourages doubt (and the scientist's prudent distrust of himself: Baker, 1973) and, as either new evidence or new doubts arise, they are incorporated in the accumulating body of knowledge. Thus, science is progressive and is never too certain about its results<sup>10</sup>. It therefore differs radically from tenacity, authority and intuition, which generally exclude the possibility of errors and have no provision for correcting them.

<sup>7</sup> Popper's philosophy contrasts with Kuhn's concept of paradigm shifts in science (see Chapter 1). Between the rare crises that stimulate the latter, conservatism and conformity do not favour serious criticism of prevailing scientific assumptions; whereas Popper urges constant challenging of current scientific beliefs (Fuller, 2003). For a critical treatment of Popper's writings, see Notturmo (1999).

<sup>8</sup> Philosophers, too, have been aware of the utility of induction. Thus, although Mill and Hulme are both sceptical about induction, because induction itself cannot be established empirically (i.e., as being reliable merely by observation), they both appear to conclude that induction – though philosophically unjustifiable – is, none the less, indispensable.

<sup>9</sup> These may not only vary between faiths, but also within faiths, leading, for example, to shifting definitions of orthodoxy and heresy (George, 1995).

<sup>10</sup> The 19th century biologist, T.H. Huxley, concisely summarized a necessary consequence of scientific inquiry: '*The great tragedy of Science – the slaying of a beautiful hypothesis by an ugly fact*'.

The remainder of this chapter now focuses on causality specifically in the context of disease.

## Koch's postulates

Chapter 1 indicated that there has been a transition from the idea that disease has a predominantly single cause to one of multiple causes<sup>11</sup>. The former idea is epitomized by the postulates, formulated by Robert Koch in the late 19th century, to determine the cause of infectious disease (Koch, 1892). These postulates<sup>12</sup>, which are based on inductive reasoning, state that an organism is causal if:

- it is present in all cases of the disease;
- it does not occur in another disease as a fortuitous and non-pathogenic parasite;
- it is isolated in pure culture from an animal, is repeatedly passaged, and induces the same disease in other animals.

Koch's postulates brought a necessary degree of order and discipline to the study of infectious disease. Few would argue that an organism fulfilling the above criteria does not cause the disease in question; but is it the **sole** and **complete** cause? Koch provided a rigid framework for testing the causal importance of a microorganism but ignored the influence of environmental factors, which were relatively unimportant in relation to the lesions that were being studied. Microbiologists found it difficult enough to satisfy the postulates without concerning themselves with interactions between complex environmental factors. Therefore the microorganisms were assumed to be the sole causes of the diseases that the microbiologists were investigating.

Dissatisfaction became evident in two groups (Stewart, 1968). Some microbiologists thought that the postulates were too difficult to satisfy because there can be obstacles to fulfilling Koch's postulates with some infectious agents that are causes of disease (e.g., some pathogens can be isolated in pure culture from cases, but do not readily induce disease in other animals; see, for example, Chapter 5: 'Diseases caused by mixed agents'). Others thought that the postulates

were insufficient because they did not specify the environmental conditions that turned vague associations into specific causes of disease. Furthermore, the postulates were not applicable to non-infectious diseases. A more cosmopolitan theory of cause was needed.

## Evans' rules

Alfred Evans (1976) has produced a set of rules that are consistent with modern concepts of causality:

- the proportion of individuals with the disease should be significantly higher in those exposed to the supposed cause than in those who are not;
- exposure to the supposed cause should be present more commonly in those with than those without the disease, when all other risk factors are held constant;
- the number of new cases of disease should be significantly higher in those exposed to the supposed cause than in those not so exposed, as shown in prospective studies;
- temporally, the disease should follow exposure to the supposed cause with a distribution of incubation periods on a bell-shaped curve;<sup>13</sup>
- a spectrum of host responses, from mild to severe, should follow exposure to the supposed cause along a logical biological gradient;
- a measurable host response (e.g., antibody, cancer cells) should appear regularly following exposure to the supposed cause in those lacking this response before exposure, or should increase in magnitude if present before exposure; this pattern should not occur in individuals not so exposed;
- experimental reproduction of the disease should occur with greater frequency in animals or man appropriately exposed to the supposed cause than in those not so exposed; this exposure may be deliberate in volunteers, experimentally induced in the laboratory, or demonstrated in a controlled regulation of natural exposure;
- elimination (e.g., removal of a specific infectious agent) or modification (e.g., alteration of a deficient diet) of the supposed cause should decrease the frequency of occurrence of the disease;
- prevention or modification of the host's response (e.g., by immunization or use of specific lymphocyte transfer factor in cancer) should decrease

<sup>11</sup> Complexity, however, should not be sought when it is not justified. This guideline is encapsulated in the 'principle of parsimony' (Hamilton, 1852), whose frequent and thorough use by the mediæval English philosopher, William of Occam, gained it the name of 'Occam's razor': '*Pluralitas non est ponenda sine necessitate*': 'multiplicity ought not to be posited without necessity'. More generally, one should choose the simplest hypothesis that will fit the facts (Edwards, 1967).

<sup>12</sup> The postulates are more fully termed the **Henle-Koch postulates**. Koch empirically validated postulates deductively reasoned 40 years earlier by his teacher, Jacob Henle (Rosen, 1938).

<sup>13</sup> The bell shape is often obtained only when the horizontal 'time' axis is mathematically transformed (Sartwell, 1950, 1966; Armenian and Lilienfeld, 1974; Armenian, 1987); if a linear time scale is used, then the curve is usually positively skewed, that is, there are few long incubation periods relative to the number of short incubation periods. Mathematical transformation is described in Chapter 12.

- or eliminate the disease that normally occurs on exposure to the supposed cause;
- all relationships and associations should be biologically and epidemiologically credible.

An important characteristic of Evans' rules, which unified principles of establishing causality for both infectious and non-infectious diseases<sup>14</sup>, is that some require the association between a hypothesized causal factor and the disease in question to be **statistically significant**. This involves comparing **groups** of animals, rather than investigating associations in the individual.

Demonstration of a statistically significant association, however, does not *prove* that a factor is causal<sup>15</sup>. The logical reduction of proof requires that the mechanism of induction of a disease by a cause needs to be explained by describing the chain of events, from cause to effect, at the molecular level, corresponding to a 'deeper' level of understanding than that offered by statistical association (Lower, 1983). However, in the absence of experimental evidence, epidemiological identification of an association can be of considerable preventive value because it can indicate factors, the reduction or removal of which is empirically shown to reduce the occurrence of disease, although a specific cause has not been identified (see Chapter 2). Some of the statistical techniques of demonstrating association are described in Chapters 14 and 15.

## Variables

The object of detailed statistical analysis is to identify those factors that cause disease. Disease and causal factors are examples of **variables**.

### Variable

A variable is any observable event that can vary. Examples of variables are the weight and age of an animal and the number of cases of disease.

### Study variable

A study variable is any variable that is being considered in an investigation.

<sup>14</sup> In so doing, Evans built on the Henle–Koch postulates, the criteria for causality for non-infectious diseases established by Yerushalmy and Palmer (1959) and Huebner's (1957) argument that prevention should be counted among the criteria. For a detailed discussion of the evolution of causal criteria, see Lower and Kanarek (1983).

<sup>15</sup> Statisticians' views on the relationship between statistical association and causality, and the extent to which statistical associations demonstrated in either a single study or several studies (e.g., meta-analysis; see Chapter 16), indicate cause, vary widely (Pearson, 1911; Cox and Wermuth, 1996). Pearl (2000) discusses this issue in detail.

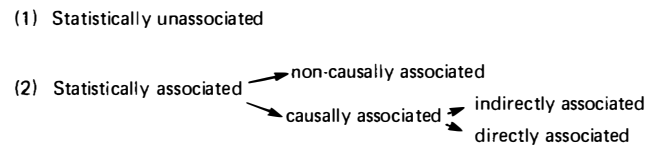

**Fig. 3.1** Types of association between disease and hypothesized causal factors.

## Response and explanatory variables

A **response** variable is one that is affected by another (**explanatory**) variable. In epidemiological investigations, disease is often the response variable. For example, when studying the effects of dry cat food on the occurrence of urolithiasis, cat food is the explanatory variable and urolithiasis is the response variable.

## Types of association

Association is the degree of dependence or independence between two variables.

There are two main types of association (*Figure 3.1*):

1. non-statistical association;
2. statistical association.

### Non-statistical association

A non-statistical association between a disease and a hypothesized causal factor is an association that arises by chance; that is, the frequency of joint occurrence of the disease and factor is no greater than would be expected by chance. For example, *Mycoplasma felis* has been isolated from the eyes of some cats with conjunctivitis. This represents an association between the mycoplasma and conjunctivitis in these cats. However, surveys have shown that *M. felis* also can be recovered from the conjunctivae of 80% of apparently normal cats (Blackmore *et al.*, 1971). Analysis of these findings revealed that the association between conjunctivitis and the presence of *M. felis* arose by chance: the mycoplasma could be present in healthy cats as well in those with conjunctivitis. In such circumstances, where a chance, non-statistical association occurs, a factor cannot be inferred to be causal.

### Statistical association

Variables are positively statistically associated when they occur together more frequently than would be expected by chance. They are negatively statistically associated when they occur together less frequently than would be expected by chance.

Positive statistical associations may therefore indicate a causal relationship. However, not all factors that

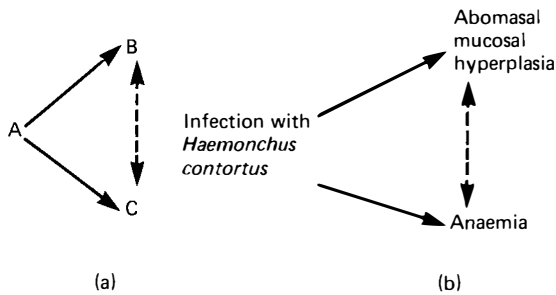

**Fig. 3.2** Path diagrams indicating the paradigm (a) and an example (b) of causal and non-causal statistical associations. A = Cause of disease (explanatory variable); B and C = manifestations of disease (response variables);  $\longrightarrow$  causal association;  $\longleftrightarrow$  non-causal association.

are positively statistically associated with a disease are necessarily causal. This can be understood with the aid of a simple path diagram (Figure 3.2a). The explanatory variable, A, is the cause of a disease. The response variables, B and C, are two manifestations of the disease. In these circumstances, there is a statistical causal association between A and B, and between A and C. There is also a positive statistical association between the two response variables, B and C, arising from their separate associations with A, but this is a non-causal association.

An example of these associations is given in Figure 3.2b. If infection of cattle with *Haemonchus contortus* were being investigated, then the following positive statistical associations could be found:

- between the presence of the parasite and abomasal mucosal hyperplasia;
- between the presence of the parasite and anaemia;
- between abomasal mucosal hyperplasia and anaemia.

The first two associations are causal and the third non-causal.

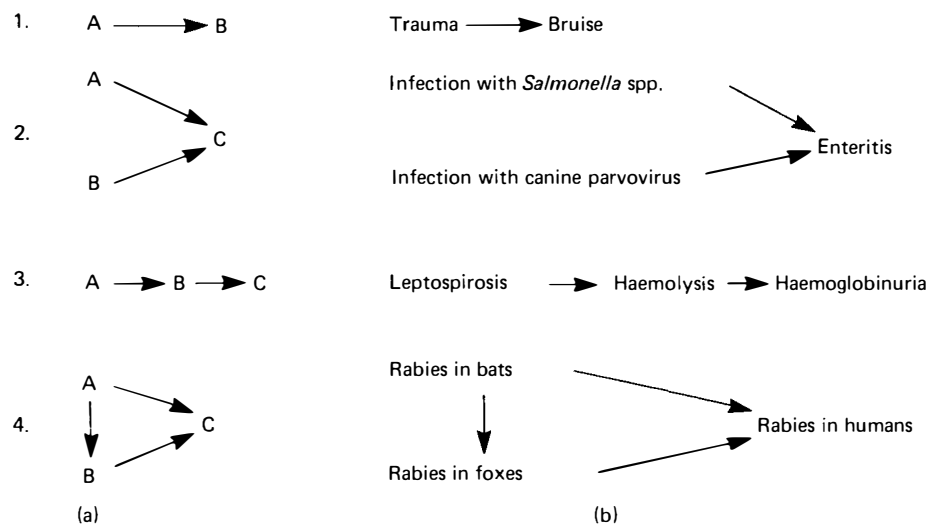

**Fig. 3.3** Path diagrams indicating the paradigm (a) and examples (b) of direct and indirect causal associations: 1 and 2 = direct causal associations; 3 = indirect causal association (A with C), direct causal association (B with C); 4 = direct and indirect causal association (A with C).

Abomasal mucosal hyperplasia and infection with *H. contortus* are **risk factors** for anaemia, that is, their presence increases the risk of anaemia. Similarly, in cats, lack of skin pigmentation results in white fur and also increased ultraviolet irradiation of the skin. The latter is associated with cutaneous squamous cell carcinoma (Dorn *et al.*, 1971), and white fur is a risk factor for this condition.

Risk factors therefore may be either causal or non-causal. (Some authors reserve 'risk factor' exclusively for causal factors, and use 'risk indicator' or 'risk marker' to describe both causally and non-causally associated factors: Last, 2001.) A knowledge of risk factors is useful in identifying populations at which veterinary attention should be directed. Thus, high milk yield is a risk factor for ketosis in dairy cattle. When developing preventive measures it is important to identify those risk factors that are causal, against which control should be directed, and those that are non-causal and will not therefore affect the development of disease.

Explanatory and response variables can be causally associated either **directly** or **indirectly** (Figure 3.3). Path diagrams 1 and 2 illustrate direct causal associations. Indirect associations are characterized by an intervening variable. Path diagram 3 illustrates an indirect causal association between A and C where the effect of A is entirely through the intervening variable B, whose effect is direct. This is equivalent to saying that A and B operate at different levels, therefore either A or B can be described as the cause of C. Leptospirosis, for example, causes haemoglobinuria by haemolysing red blood cells; a clinician would say that leptospirosis causes the haemoglobinuria, whereas a pathologist might attribute it to intra-vascular haemolysis.

Path diagram 4 in Figure 3.3 illustrates the situation where one explanatory variable, A, has not only a

direct causal association with a response variable, C, but also an indirect effect on C by influencing another variable, B. For example, in the US people have contracted rabies by inhalation on entering caves where rabies-infected bats roost. They can also contract rabies from foxes that are infected by living in bat-infested caves.

## Confounding

Confounding (Latin: *confundere* = to mix together) is the effect of an extraneous variable that can wholly or partly account for an apparent association between variables. Confounding can produce a spurious association between study variables, or can mask a real association. A variable that confounds is called a **confounding variable** or **confounder**.

A confounding variable is distributed non-randomly (i.e., is positively or negatively correlated with the explanatory and response variables that are being studied). A confounding variable generally must<sup>16</sup>:

- be a risk factor for the disease that is being studied; and
- be associated with the explanatory variable, but not be a consequence of exposure to it.

### Examples to illustrate the concept

An investigation of leptospirosis in dairy farmers in New Zealand (Mackintosh *et al.*, 1980) revealed that wearing an apron during milking was associated with an increased risk of contracting leptospirosis. Further work showed that the larger the herd being milked, the greater the chance of contracting leptospirosis. It also was found that farmers with large herds tended to wear aprons more frequently for milking than farmers with small herds. The association between the wearing of aprons and leptospirosis was not causal but was produced spuriously by the confounding effect of large herd size (Figure 3.4a), because large herd size was associated with leptospirosis, and also with the wearing of aprons. Figure 3.4b illustrates a similar confounding effect in relation to respiratory disease in pigs (Willeberg, 1980b). A statistical association was demonstrated between fan ventilation and respiratory disease. This was not because fan ventilation caused respiratory disease. The association resulted from the

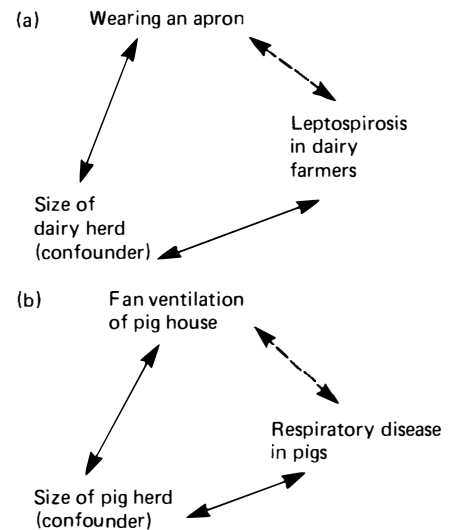

**Fig. 3.4** Examples of confounding: (a) large dairy herds in relation to leptospirosis in dairy farmers and the wearing of milking aprons; (b) large pig herds in relation to respiratory disease in pigs and fan ventilation.  $\longleftrightarrow$  'Real' association;  $\dashrightarrow$  spurious association.

confounding effect of herd size: large herds are more likely to develop respiratory disease than small herds, and are also more likely to have fan ventilation rather than natural ventilation.

These two examples have been selected to illustrate confounding in situations where the spurious association is obviously rather implausible. However, in many situations, confounding is less obvious, but must be considered, for example, in observational studies that test causal hypotheses (see Chapter 15).

## Causal models

The associations and interactions between direct and indirect causes can be viewed in two ways, producing two causal 'models'.

### Causal model 1

The relationship of causes to their effects allows classification of causes into two types: 'sufficient' and 'necessary' (Rothman, 1976).

A cause is **sufficient** if it inevitably produces an effect (assuming that nothing happens that interrupts the development of the effect, such as death or prophylaxis). A sufficient cause virtually always comprises a range of component causes; disease therefore is **multifactorial**. Frequently, however, one component is commonly described, in general parlance, as *the*

<sup>16</sup> Criteria for confounding are given in standard texts (e.g., Schlesselman, 1982), but there is controversy over conflicting definitions of confounding, and therefore over the conditions required (Kass and Greenland, 1991; Weinberg, 1993; Shapiro, 1997).

cause<sup>17</sup>. For example, distemper virus is referred to as the cause of distemper, although the sufficient cause actually involves exposure to the virus, lack of immunity and, possibly, other components. It is not necessary to identify all components of a sufficient cause to prevent disease because removal of one component may render the cause insufficient. For example, an improvement in floor design can prevent foot abscesses in pigs even though the main pyogenic bacteria are not identified.

A particular disease may be produced by different sufficient causes. The different sufficient causes may have certain component causes in common, or they may not. If a cause is a component of every sufficient cause, then it is **necessary**<sup>18</sup>. Therefore, a necessary cause must always be present to produce an effect.

In *Figure 3.5a*, A is the only necessary cause, because it is the only component appearing in all of the sufficient causes. The remaining causes (B–J) are not necessary because there are some sufficient causes without them. This concept is exemplified in *Figure 3.5b*, which depicts hypothesized sufficient causes of pneumonic pasteurellosis in cattle. Infection with *Pasteurella* spp. is the necessary cause, but other component causes, including lack of immunity, are required for induction of the disease.

Another example of a cause that is necessary but not sufficient is infection with *Actinobacillus ligneresi*, which must occur before actinobacillosis ('wooden tongue') can develop. However, other factors that damage the buccal mucosae (e.g. sharp, abrasive vegetation) must be present before the disease develops. In the absence of these factors, the bacterium can be present without disease developing.

It is obvious that necessary causes are frequently related to the definition of a disease; for example, lead is a necessary cause of lead poisoning, and *P. multocida* is a necessary cause of pneumonic pasteurellosis.

A cause may be necessary, sufficient, neither, or both, but it is unusual for a single component cause

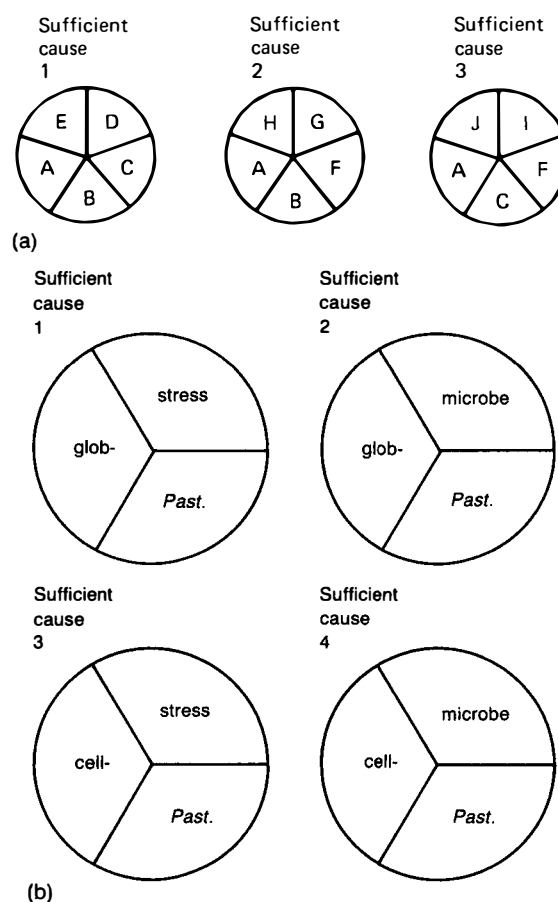

**Fig. 3.5** Scheme for the causes of disease (causal model 1). (a) Paradigm. (b) Hypothetical example for bovine pneumonic pasteurellosis. glob-: Lack of specific globulins; stress: adrenal stress of environmental origin (e.g., weather); Past.: presence of *Mannheimia (Pasteurella)* spp.; microbe: presence of viruses or mycoplastmata; cell-: lack of cellular immunity. ((a) From Rothman, 1976; (b) modified from Martin *et al.*, 1987.)

to be both necessary and sufficient. One example is exposure to large doses of gamma radiation with the subsequent development of radiation sickness.

Component causes therefore include factors that have been classified as:

- **predisposing factors**, which increase the level of susceptibility in the host (e.g., age and immune status);
- **enabling factors**, which facilitate manifestation of a disease (e.g., housing and nutrition);
- **precipitating factors**, which are associated with the definitive onset of disease (e.g., many toxic and infectious agents);
- **reinforcing factors**, which tend to aggravate the presence of a disease (e.g., repeated exposure to an infectious agent in the absence of an immune response).

<sup>17</sup> Philosophers are uneasy with such a definition. Note, for instance, Mill's 'argument from caprice': 'Nothing can better show the absence of any scientific ground for the distinction between the cause of a phenomenon and its conditions, than the capricious manner in which we select from among the conditions that which we choose to denominate the cause.' (Mill, 1868). Mill's argument has won the philosophical field, and is echoed by contemporary authors such as Lewis (1986): 'We sometimes single out one among all the causes of some event and call it "the" cause, as if there were no others. Or we single out a few as the "causes", calling the rest mere "causal factors" or "causal conditions" . . . We may select the abnormal or extraordinary causes, or those under human control, or those we deem good or bad, or just those we want to talk about. I have nothing to say about these principles of invidious discrimination.'

<sup>18</sup> Again, the philosopher would be uneasy. Just because one component has always been present in all cases, it does not follow that it is the causally operative/necessary component, or that it is a necessary component at all – what if the next case lacks this component?



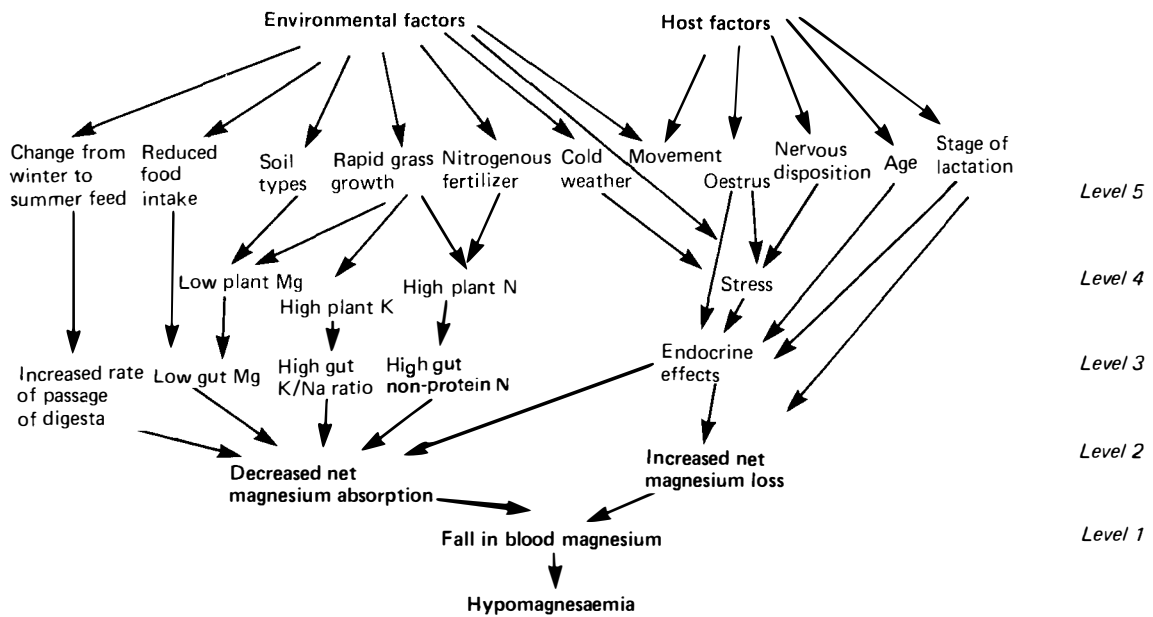

Fig. 3.6 Causal web of bovine hypomagnesaemia (causal model 2).

Pneumonia is an example of a disease that has sufficient causes, none of which has a necessary component. Pneumonia may have been produced in one case by heat stress where a dry, dusty environment allowed microscopic particulate matter to reach the alveoli. Cold stress could produce a clinically similar result.

Multifactorial syndromes such as pneumonia can have many sufficient causes, although no single component cause is necessary. Part of the reason is taxonomic: pneumonia is a loosely connected group of diseases whose classification (see Chapter 9) is based on lesions (inflammation of the lungs), rather than specific causes; the lesions can be produced by many different causes. When a disease is classified according to aetiology, there is, by definition, usually only one major cause, which therefore is likely to be necessary. Examples include lead poisoning, actinobacillosis and pasteuriosis, mentioned above, and many 'simple' infectious diseases, such as tuberculosis and brucellosis.

The object of epidemiological investigations of cause is the identification of sufficient causes and their component causes. Removal of one or more components from a sufficient cause will then prevent disease produced by that sufficient cause.

### Causal model 2

Direct and indirect causes represent a chain of actions, with the indirect causes activating the direct causes (e.g., Figure 3.3, path diagram 3). When many such relationships occur, a number of factors can act at

the same level (but not necessarily at the same intensity), and there may be several levels, producing a 'web of causation'. Again, disease is **multifactorial**. Figure 3.6 illustrates the causal web of bovine hypomagnesaemia.

### Formulating a causal hypothesis

The first step in any epidemiological investigation of cause is descriptive. A description of time, place, and population is useful initially.

#### Time

Associations with year, season, month, day, or even hour in the case of food poisoning investigations, should be considered. Such details may provide information on climatic influences, incubation periods and sources of infection. For example, an outbreak of salmonellosis in a group of cattle may be associated with the introduction of infected cattle feed.

#### Place

The geographical distribution of a disease may indicate an association with local geological, management or ecological factors, for example nutritionally deficient soil or arthropod transmitters of infection. Epidemiological maps (see Chapter 4) are a valuable aid to identifying geographical associations. For example, mapping of the location of cattle fatalities in South Africa, linked to meteorological data, revealed that the

fatalities were due to ingestion of grass contaminated with copper from a nearby copper mine (Gummow *et al.*, 1991) (addressed more fully in Chapter 22).

### Population

The type of animal that is affected often is of considerable importance. Hereford cattle are more susceptible to squamous cell carcinoma of the eye than other breeds, suggesting that the cause may be partly genetic. In many parts of the world, meat workers are affected more often by Q Fever than are other people, implying a source of infection in meat-processing plants.

When the major facts have been established, alternative causal hypotheses can be formulated. An epidemiological investigation is similar to any detective novel that unfolds a list of 'suspects' (possible causal factors), some of which may be non-statistically associated with a disease, and some statistically associated with the disease, either causally or non-causally.

### Methods of deriving a hypothesis

There are four major methods of arriving at a hypothesis:

1. method of difference;
2. method of agreement;
3. method of concomitant variation;
4. method of analogy.

#### Method of difference

The method of difference (Mill's canon 1) argues that, if the frequency of a disease is different in two different circumstances, and a factor is present in one circumstance but is absent from the other, then the factor may be suspected of being causal. For instance, Wood (1978) noted an increased occurrence of stillbirths in pigs in one of three farrowing houses. The only difference between this house and the other two was a different type of burner on its gas heaters. A hypothesis was formulated: that the different type of burner caused the stillbirths. Subsequently, the burners were shown to be defective and producing large amounts of carbon monoxide; the carbon monoxide was assumed to cause the stillbirths. The occurrence of stillbirths decreased when the faulty burners were removed, thus supporting the hypothesis.

Similarly, bovine spongiform encephalopathy occurred to a different extent on the Channel Islands (Jersey and Guernsey), and meat and bone meal was used more frequently in feedstuffs on the island

with the greater frequency of bovine spongiform encephalopathy (Wilesmith, 1993). This added credence to the hypothesis that the causal agent was transmitted in meat and bone meal in concentrate rations.

A defect of a hypothesis based on the method of difference is that several different factors usually may be incriminated as possible causes. The value of a hypothesis generated by this method is reduced if many alternative hypotheses can be formulated. For example, a comparison of the different disease patterns of pigs in Africa and Denmark would involve a large number of variables, many of which could be hypothesized as causal. In contrast, the marked occurrence of mannosidosis in Angus cattle (Jolly and Townsley, 1980), compared with the absence of this disease in other breeds, strongly suggests that a genetic factor is the cause.

#### Method of agreement

The method of agreement (Mill's canon 2) reasons that, if a factor is common to a number of different circumstances in which a disease is present, then the factor may be the cause of the disease. Thus, if a batch of meat and bone meal was associated with salmonellosis on widely different types of pig farms, and this was the only circumstance in common, then the causal hypothesis – that disease was caused by contamination of that batch – is strengthened.

A second example relates to bovine hyperkeratosis which was identified in cattle in the US (Schwabe *et al.*, 1977). The disease was called 'X disease' because initially the cause was unknown. It occurred in different circumstances:

- in cattle that were fed sliced bread;
- in calves that had been licking lubricating oil;
- in cattle that were in contact with wood preservative.

The bread slicing machine was lubricated with a similar oil to that which had been licked by the calves. The lubricating oil and the wood preservative both contained chlorinated naphthalene. This chemical was common to the different circumstances and subsequently was shown to cause hyperkeratosis.

#### Method of concomitant variation

The method of concomitant variation (Mill's canon 5) involves a search for a factor, the frequency or strength of which varies continuously with the frequency of the disease in different situations. Thus, the distance over which cattle are transported before slaughter appears to be related to the occurrence of bruises in their carcasses (Meischke *et al.*, 1974). Similarly, there appear to be relationships between the occurrence of squamous cell carcinoma of the skin of animals and the intensity

**Table 3.1** The relationship between frequency of milking and serological evidence of exposure to leptospirosis in dairy farm personnel in the Manawatu region of New Zealand.

Frequency of milking of cows by personnel	Serological leptospirosis		Total number of personnel	Percentage of personnel with serological leptospirosis
	Present	Absent		
9 times/week	61	116	177	34.5
1–8 times/week	4	11	15	26.7
Rarely or never	0	20	20	0.0

**Table 3.2** The relationship between number of cigarettes smoked per day and deaths from lung cancer in British doctors, 1951–61. (From Doll and Hill, 1964a.)

Cigarettes/day in 1951	Annual lung cancer death rate/1000 (1951–61)
None	0.07
1–14	0.54
15–24	1.39
≥25	2.27

of ultraviolet radiation, between the occurrence of bovine hypomagnesaemia and pasture levels of magnesium, and between infection of dairy personnel with leptospires and the frequency with which the personnel milk cows (Table 3.1). The classical medical epidemiological investigation of the association between smoking and lung cancer (Doll and Hill, 1964a,b) also illustrates this method of reasoning (Table 3.2): the number of deaths due to lung cancer is proportional to the number of cigarettes smoked per day<sup>19</sup>.

### Method of analogy

This method of reasoning involves comparison of the pattern of the disease under study with that of a disease that already is understood, because the cause of a disease that is understood may also be the cause of another poorly understood disease with a similar pattern. For example, some mammary tumours of mice are known to be caused by a virus, therefore some mammary tumours of dogs may have a viral cause. The climatic conditions associated with outbreaks of Kikuyu grass poisoning of cattle may suggest a mycotoxin as the cause because the circumstance is similar to those circumstances present in other mycotoxicoses (Bryson, 1982). Bovine petechial fever, caused by *Cytoecetes ondiri*, is present in a limited area of Kenya (Snodgrass, 1974). The mode of transmission of this

infectious agent is unknown. However, other members of the genus *Cytoecetes* are known to be transmitted by arthropods, and geographic limitation is a feature of arthropod transmitted diseases. Therefore, using the method of analogy, it has been suggested that *C. ondiri* may be transmitted by arthropods.

Evidence by analogy is not, in the strictest sense, evidence of fact, It can point to probabilities, and can confirm conclusions that may be reached by other means; but it can be dangerously misleading (and was not considered sound enough by Mill to be included as a canon). A classical example is the inference made by the 19th century medical epidemiologist, John Snow, that yellow fever was transmitted by sewage (Snow, 1855). He had already demonstrated that cholera was transmitted by sewage, and then observed that cholera and yellow fever were both associated with overcrowding. He then inferred that cholera and yellow fever had similar modes of transmission, whereas the latter actually is transmitted by an arthropod rather than by contaminated sewage.

### Principles for establishing cause: Hill's criteria

The British medical statistician, Austin Bradford Hill, proposed several criteria for establishing a causal association (Hill, 1965), including:

- the time sequence of the events;
- the strength of the association;
- biological gradient;
- consistency;
- compatibility with existing knowledge.

### Time sequence

Cause must precede effect. In a bacteriological survey, Millar and Francis (1974) found an increased occurrence of various infections in barren mares compared with others whose reproductive function was normal. However, unless the bacterial infections were present before the mares became infertile, it would be incorrect to infer that the bacterial infections caused infertility. The causal pathway may have been in the other

<sup>19</sup> This seminal investigation eventually became a 50-year study (Doll *et al.*, 2004).

direction: absence of normal reproductive cyclic activity may allow previously harmless infections to flourish.

### Strength of association

If a factor is causal, then there will be a strong positive statistical association between the factor and the disease.

### Biological gradient

If a dose–response relationship can be found between a factor and a disease, the plausibility of a factor being causal is increased. This is the basis of reasoning by the method of concomitant variation. Examples have already been cited: frequency of milking in relation to leptospirosis (see *Table 3.1*), and smoking in relation to lung cancer (see *Table 3.2*).

### Consistency

If an association exists in a number of different circumstances, then a causal relationship is probable. This is the basis of reasoning by the method of agreement. An example is bovine hyperkeratosis, mentioned above.

### Compatibility with existing knowledge

It is more reasonable to infer that a factor causes a disease if a plausible biological mechanism has been identified than if such a mechanism is not known. Thus, smoking can be suggested as a likely cause of lung cancer because other chemical and environmental pollutants are known to have a carcinogenic effect on laboratory animals. Similarly, if a mycotoxin were present in animal foodstuffs, then it might be expected to produce characteristic liver damage. On the other hand, the survey of leptospirosis of dairy farmers, mentioned earlier, showed a positive association between wearing an apron and having a leptospiral titre. This finding was not compatible with either existing knowledge or common sense, and a factor that might have confounded the result was sought and found.

Hill also included specificity of response (a single cause leads to a single effect) and analogy in his set of criteria<sup>20</sup>. However, the former is faulted (Susser, 1977): some causes are known to induce more than one

syndrome (see *Figure 9.3d*), and, earlier in this chapter, the latter has been shown to be a suspect method of reasoning.

A fuller discussion of reasoning and causal inference in general is given by Taylor (1967) and Pinto and Blair (1993), and, in the context of epidemiology, by Buck (1975), Maclure (1985), Weed (1986), Evans (1993) and Rothman and Greenland (1998). The testing of hypotheses using observational studies is described in Chapter 15.

### Further reading

- Doll, R. (2002) Proof of causality: deduction from epidemiological observation. *Perspectives in Biology and Medicine*, **45**, 499–515
- Evans, A.S. (1993) *Causation and Disease: A Chronological Journey*. Plenum Publishing Corporation, New York
- Falkow, S. (1988) Molecular Koch's postulates applied to microbial pathogenicity. *Reviews of Infectious Diseases*, **10**, Suppl. 2, S274–S276. (*Modification of Koch's postulates to suit the genetic basis of microbial pathogenicity*)
- Goodstein, D. (2000) How science works. In: *Reference Manual on Scientific Evidence*, 2nd edn, pp. 67–82. Federal Judicial Center, Washington. (*A brief, selective discussion of scientific method*)
- Jeffreys, H. (1973) *Scientific Inference*. Cambridge University Press, Cambridge
- Last, J.M. (Ed.) (2001) *A Dictionary of Epidemiology*, 4th edn. Oxford University Press, New York
- Lower, G.M. (1983) Systematic epidemiologic theory: conceptual foundations and axiomatic elements. *Medical Hypotheses*, **11**, 195–215. (*A concise discussion of causality, and causal criteria*)
- Rothman, K.J. and Greenland, S. (1998) *Modern Epidemiology*, 2nd edn. Lippincott-Raven, Philadelphia
- Susser, M. (1973) *Causal Thinking in the Health Sciences. Concepts and Strategies of Epidemiology*. Oxford University Press, New York, London and Toronto
- Susser, M. (1977) Judgment and causal inference: criteria in epidemiologic studies. *American Journal of Epidemiology*, **105**, 1–15
- Tarski, A. (1995) *Introduction to Logic and to the Methodology of Deductive Sciences*. Dover Publications, New York
- Taylor, R. (1967) Causation. In: *The Encyclopedia of Philosophy*, Vol. 2. Ed. Edwards, P., pp. 56–66. The Macmillan Company and The Free Press, New York
- Vineis, P. (2004) Causality in epidemiology. In: *A History of Epidemiologic Methods and Concepts*. Ed. Morabia, A., pp. 337–349. Birkhäuser Verlag, Basel

<sup>20</sup> Specificity of response, having its origins in Koch's postulates, had already been argued as being central to causal inference (Yerushalmy and Palmer, 1959), and was cited in the debate on the relationship between smoking and lung cancer (Berkson, 1960, 1962).

# 4

## Describing disease occurrence

---

This chapter discusses the types of animal population that are encountered in veterinary medicine, and describes the methods of expressing the amount and temporal and spatial distribution of disease in these populations.

Some basic terms

### Endemic occurrence

'Endemic' is used in two senses to describe:

1. the **usual frequency** of occurrence of a disease in a population;
2. the **constant presence** of a disease in a population.

Thus, the term implies a stable state; if a disease is well understood, then its endemic level is often **predictable**. The term 'endemic' can be applied not only to overt disease but also to disease in the absence of clinical signs and to levels of circulating antibodies. Therefore, the exact context in which the term is used should always be defined. For example, laboratory mice kept under conventional systems of 'non-barrier maintenance' (i.e., with no special precautions being taken to prevent entry and spread of infection into the population) are invariably infected with the nematode *Syphacia obvelata*. Infection of 100% of the mice would be considered the usual level of occurrence, that is, the endemic level of infection. When a disease is continuously present to a high level, affecting all age-groups equally, it is **hyperendemic**. In contrast, the endemic level of actinobacillosis in a dairy herd is likely to be less than 1%.

'Endemic' is applied not only to infectious diseases but also to non-infectious ones: the veterinary meat hygienist is just as concerned with the endemic level of carcass bruising as is the veterinary practitioner with the endemic level of pneumonia in pigs.

When endemic disease is described, the affected population and its location should be specified. Thus, although bovine tuberculosis is endemic in badgers in south-west England, the infection apparently is not endemic in all badger populations in the UK (Little *et al.*, 1982).

### Epidemic occurrence

'Epidemic' originally was used only to describe a sudden, usually unpredictable, increase in the number of cases of an infectious disease in a population. In modern epidemiology, an epidemic is an occurrence of an infectious or non-infectious disease to a level **in excess of the expected (i.e., endemic) level**. Thus, infection with *S. obvelata* should be absent from specific-pathogen-free (SPF) mice kept under strict barrier conditions where precautions are taken to prevent entry and spread of infectious agents in the colony. If an infected mouse gained entry to the colony, the infection would be transmitted throughout the resident population and an epidemic of the nematode infection would occur. Such an infection in SPF mice colonies would be **unusually frequent**, that is, epidemic. Similarly, if cattle grazed on rough pasture, which could abrade their mouths, there might be an increase in the number of cases of actinobacillosis. Although only 2% of the animals might become infected, this would be an unusually high (epidemic) level compared with the endemic level of 1% in the herd. Thus, an epidemic need not involve a large number of individuals.

When an epidemic occurs, the population must have been subjected to one or more factors that were not present previously. In the example of the SPF mouse colony that became infected with *S. obvelata*, the factor was a breakdown in barrier maintenance and the entry

of an infected mouse. In the case of the herd with actinobacillosis, the new factor was an increased consumption of vegetation that could cause buccal abrasions.

The popular conception of an epidemic frequently is an outbreak of disease that is noticed immediately. However, some epidemics may go undetected for some time after their occurrence. Thus, in London, in 1952, the deaths of 4000 people were associated with a particularly severe smog (fog intensified by smoke). The deaths occurred at the same time as the Smithfield fat stock show (HMSO, 1954). Although an epidemic of severe respiratory disease in the cattle was recognized immediately, and was associated with the air pollution caused by the smog, the epidemic of human respiratory disease was not appreciated until statistics recording human deaths were published more than a year later.

In contrast, some epidemics may be exaggerated. An increased number of deaths in foxes occurred in the UK in the late 1950s. This apparent epidemic of a 'new' fatal disease received considerable publicity and every dead fox was assumed to have died from the disease. Subsequent laboratory analyses identified chlorinated hydrocarbon poisoning as the cause of the increased fox fatality, but only 40% of foxes submitted for post-mortem examination had died from the poisoning. The other 60% had died of endemic diseases that had not previously stimulated general interest (Blackmore, 1964). This example illustrates that the endemic level of disease in a population has to be known before an epidemic can be recognized.

### Pandemic occurrence

A pandemic is a widespread epidemic that usually affects a large proportion of the population. Many countries may be affected. Pandemics of rinderpest (see *Table 1.1*), foot-and-mouth disease, and African swine fever have been the cause of considerable financial loss. By the 1970s, rinderpest was found only in north-west Africa and the Indian subcontinent, but the disease became pandemic in Africa and the Middle East during the early 1980s (Sasaki, 1991), and became the target of a global eradication campaign (Wojciechowski, 1991), which is reaching a successful climax (*Table 1.4*). In the late 1970s, a pandemic of parvovirus infection occurred in dogs in many parts of the world (Carmichael and Binn, 1981). Serious human pandemics have included plague (the Black Death), which spread throughout Europe in 1348<sup>1</sup>, cholera

in the 19th century, influenza soon after the First World War, and, currently, HIV/AIDS (particularly in Africa).

### Sporadic occurrence

A sporadic outbreak of disease is one that occurs **irregularly and haphazardly**. This implies that appropriate circumstances have occurred locally, producing small, localized outbreaks.

Foot-and-mouth disease is not endemic in the UK. A sporadic outbreak, thought to be associated with the importation of infected Argentine lamb that entered the animal food chain, occurred initially in Oswestry in October 1967 (Hugh-Jones, 1972). Unfortunately, this incident, and several subsequent ones associated with the imported lamb, resulted in an epidemic, which was not eliminated until the middle of 1968 (*Figure 4.1a*). Similarly, the more widespread epidemic of foot-and-mouth disease that occurred in the UK in 2001 (*Figure 4.1b*) began as a sporadic outbreak in a pig herd at Heddon-on-the-Wall in Northumbria (DEFRA, 2002b; Mansley *et al.*, 2003), and was most likely caused by contamination of swill by illegally imported meat. However, in both epidemics, the disease did not become endemic because of veterinary intervention. Conversely, in 1969, a single sporadic case of rabies occurred in a dog in the UK after it had completed the statutory 6-month quarantine period (Haig, 1977). No other animal was infected and so this sporadic outbreak was confined to the original case.

Thus 'sporadic' can indicate either a single case or a cluster of cases of a disease or infection (without obvious disease) that is not normally present in an area.

Infection with *Leptospira interrogans*, serovar *pomona*, is endemic in domestic pigs in New Zealand. The bacterium is also frequently the cause of sporadic epidemics of abortion in cattle. Infected cattle excrete the bacterium in their urine only for approximately 3 months. The bacterium therefore cannot usually be maintained, and so become endemic, in the herd. If a cow becomes infected with the bacterium by direct or indirect contact with pigs, this constitutes sporadic infection. This animal may now become a short-term source of infection to other pregnant cattle in the herd, and a sporadic epidemic of abortion, of 3 or 4 months' duration, is likely to occur. Post-infection leptospiral antibodies persist for many years in cattle, and sporadic infection with the bacterium is not uncommon; 18% of New Zealand cattle have been reported to have

<sup>1</sup> The pandemic eliminated nearly a third of the population, but population decline continued long after. In 1450, Europe's population was probably nearly half of what it had been in the early 14th century. Thus, agricultural labour became scarce, labourers became stronger, and land-

lords weaker. Consequently, wealth was sought in commerce, and the great cities of Amsterdam, Florence, London, Paris, Vienna and Venice developed. In Italy, this produced the urban cultural climate in which *The Renaissance* could be born and flourish (Holmes, 1996) – illustrating that disease can have consequences far beyond the bounds of health.

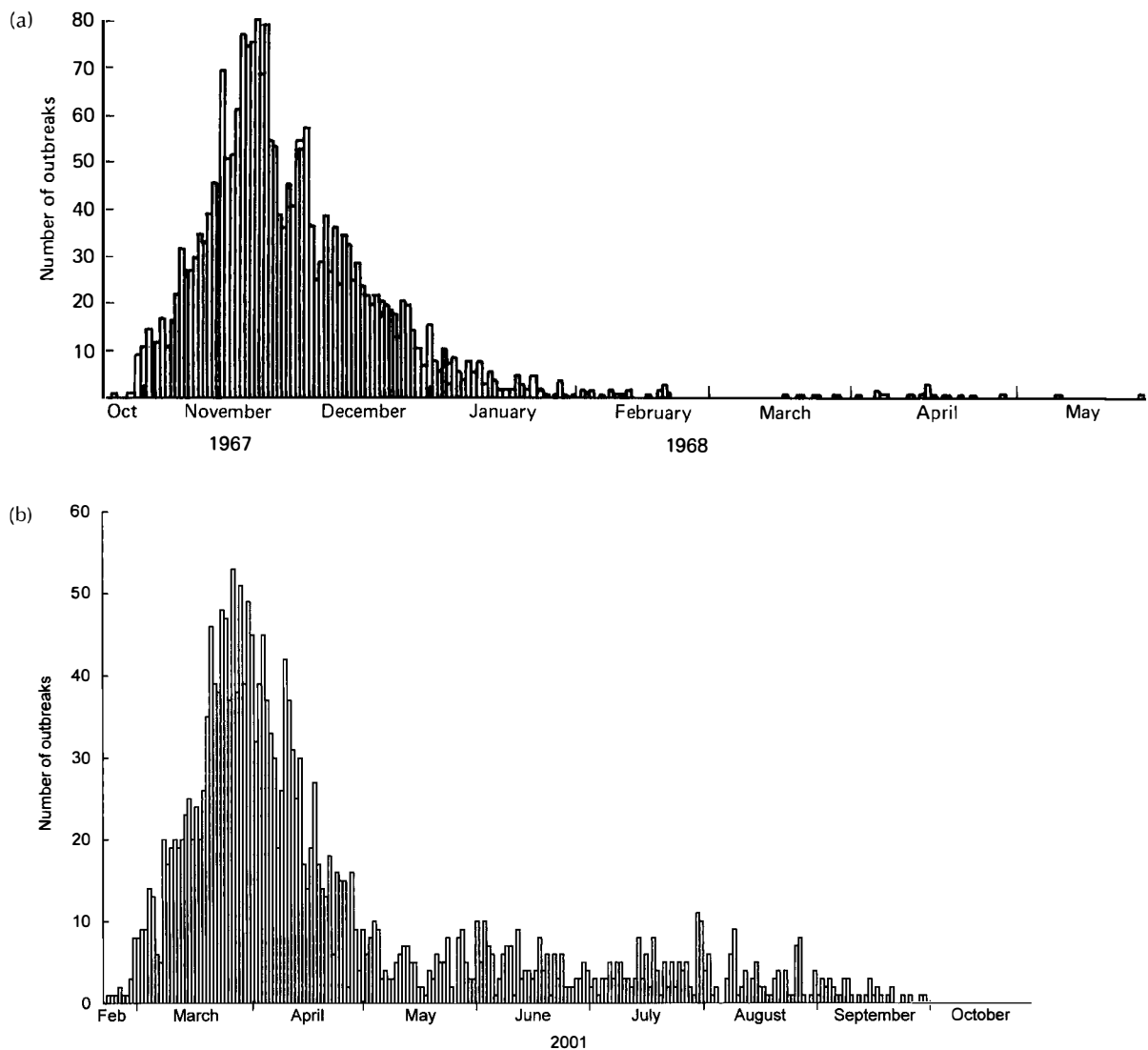

**Fig. 4.1** Epidemics of foot-and-mouth disease in the UK: number of outbreaks per day. (a) 1967–68. (From HMSO, 1969); (b) 2001. (From DEFRA, 2002b. © Crown copyright; Reproduced by kind permission of DEFRA.)

detectable antibodies to this organism. Thus, although infection and the abortion that may ensue are **sporadic**, there is an **endemic** level of antibody in the bovine population (Hathaway, 1981).

### Outbreaks

The *Office International des Epizooties* defines an outbreak as ‘an occurrence of disease in an agricultural establishment, breeding establishment or premises, including all buildings as well as adjoining premises, where animals are present’, the term generally implying that several animals are affected. Livestock in developed countries are usually kept as separated populations (see below) and so ‘outbreak’ can be applied unambiguously to an occurrence of disease on

an individual farm. For example, the epidemic of foot-and-mouth disease in the UK in 2001 comprised 2030 infected premises (i.e., outbreaks), which all originated from a single infected pig farm. In contrast, the term sometimes also is used in the context of a single source, irrespective of the number or premises involved. Thus, in the US in 2002–03, exotic Newcastle disease occurred in 21 commercial flocks in California, and over 1000 ‘backyard flocks’, including some in the neighbouring states of Arizona and Nevada. This was documented as only one outbreak because it was considered to have arisen from a single introduction of the disease. Subsequently, a second outbreak, involving only one premises, was recorded in Texas (some distance from the first outbreak); this was determined to be a separate introduction, based on DNA sequencing

**Table 4.1** Criteria for declaring an outbreak of foot-and-mouth disease. (From European Commission, 2002.)

An outbreak shall be declared where a holding meets one or more of the following criteria:

1. foot-and-mouth disease virus has been isolated from an animal, any product derived from that animal, or its environment;
2. clinical signs consistent with foot-and-mouth disease are observed in an animal of a susceptible species, and the virus antigen or virus ribonucleic acid (RNA) specific to one or more of the serotypes of foot-and-mouth disease virus has been detected and identified in samples collected from the animal or its cohorts;
3. clinical signs consistent with foot-and-mouth disease are observed in an animal of a susceptible species and the animal or its cohorts are positive for antibody to foot-and-mouth disease virus structural or non-structural proteins, provided that previous vaccination, residual maternal antibodies or non-specific reactions can be excluded as possible causes of seropositivity;
4. virus antigen or virus RNA specific to one or more of the serotypes of foot-and-mouth disease virus has been detected and identified in samples collected from animals of susceptible species and the animals are positive for antibody to foot-and-mouth disease virus structural or non-structural proteins, provided that in the case of antibodies to structural proteins previous vaccination, residual maternal antibodies or non-specific reactions can be excluded as possible causes of seropositivity;
5. an epidemiological link has been established to a confirmed foot-and-mouth disease outbreak and at least one of the following conditions applies:
  - (a) one or more animals are positive for antibody to foot-and-mouth disease virus structural or non-structural proteins, provided that previous vaccination, residual maternal antibodies or non-specific reactions can be excluded as possible causes of seropositivity;
  - (b) virus antigen or virus RNA specific to one or more of the serotypes of foot-and-mouth disease virus has been detected and identified in samples collected from one or more animals of susceptible species;
  - (c) serological evidence of active infection with foot-and-mouth disease by detection of seroconversion from negative to positive for antibody to foot-and-mouth disease virus structural or non-structural proteins has been established in one or more animals of susceptible species, and previous vaccination, residual maternal antibodies or non-specific reactions can be excluded as possible causes of seropositivity.

Where a previously seronegative status cannot be reasonably expected, this detection of seroconversion is to be carried out in paired samples collected from the same animals on two or more occasions at least 5 days apart, in the case of structural proteins, and at least 21 days apart, in the case of non-structural proteins.

differences between the two virus strains that were isolated from each outbreak. Moreover, definition of 'outbreak' may include criteria other than the presence of clinical cases, and may be tailored to specific infections (Table 4.1).

In developing countries, animal populations are frequently contiguous (see below) and so it may be difficult to define the limits of one outbreak. An outbreak is then considered as occurring in part of a territory in which, taking local conditions into account, it cannot be guaranteed that both susceptible and unsusceptible animals have not had direct contact with affected or susceptible animals. For example, in certain areas of Africa, an outbreak means the occurrence of disease within a sixteenth square degree; the occurrence is still referred to as an outbreak, even though the disease may occur in several places within the same sixteenth square degree. (Note that the area within a sixteenth square degree is not constant: it varies with latitude.)

## Basic concepts of disease quantification

A necessary part of the investigation of disease in a population is the counting of affected animals so that

the **amount** of disease can be described. Furthermore, it is usually desirable to describe **when** and **where** disease occurs, and to relate the number of diseased animals to the size of the **population at risk** of developing disease so that a disease's importance can be assessed. A report of 10 cases of infectious enteritis in a cattery, for example, does not indicate the true extent of the problem unless the report is considered in terms of the number of cats in the cattery: there may be only 10 cats present, in which case all of the cats are affected, or there may be 100 cats, in which case only a small proportion of the cats is affected.

The amount of disease is the **morbidity** (Latin: *morbus* = disease); the number of deaths is the **mortality**. The times of occurrence of cases of a disease constitute its **temporal** distribution, whereas places of occurrence comprise its **spatial** distribution. The measurement and description of the size of populations and their characteristics constitute **demography**<sup>2</sup> (Greek: *demo* = people; *-graphia* = writing, description).

<sup>2</sup> A distinction between zoography and demography is not made in this book, for the reasons given in Chapter 2 in relation to epizootiology and epidemiology.



## The structure of animal populations

The structure of populations influences the extent to which the size of the population at risk can be assessed, as well as affecting the ways in which disease occurs and persists in animals. The organization of animal populations can usually be described as either **contiguous** or **separated**.

### Contiguous populations

A contiguous population is one in which there is much contact between individuals in the population and members of other populations. Contiguous populations therefore predispose to transfer and persistence of infectious diseases over large areas because of the inherent mixing and movement of animals.

Most human populations are contiguous because there is mixing of individuals by travel. Populations of small domestic animals also are usually contiguous. Dogs and cats that are not confined to houses move freely within cities, coming into contact with other urban, suburban and rural animals of their own and different species<sup>3</sup>. African nomadic tribes similarly own animals that comprise contiguous groups. Many wild animals belong to this category, too.

### Assessing the size of contiguous populations

It is often difficult to assess the size of contiguous animal populations. Only limited demographic data about small domestic animals are available; for example, from Kennel Club registers (Tedor and Reif, 1978; Wong and Lee, 1985). In some developed countries, dogs must be legally registered, but this is a difficult law to enforce and so many dogs may not be recorded. There are pet registries that record and identify animals, for example, by ear or leg tattooing (Anon., 1984), but these records are voluntary and so exclude the majority of animals. Increased uptake of identification of companion animals by 'microchips', designed to an international standard (Anon., 1995; Ingwersen, 2000), should facilitate improved enumeration and tracing of these animals<sup>4</sup>. Over half a million animals were implanted with microchips in the UK within the ten years up to 2000 (Anon., 2000).

<sup>3</sup> Such animals are classified as 'free-roaming' (Slater, 2001), a category that includes strays (i.e., recently lost or abandoned animals) as well as unrestrained, but owned, animals.

<sup>4</sup> Microchips are an accurate means of identification of animals, provided they are properly implanted (Sorensen *et al.*, 1995; Fry and Green, 1999). However, the use of different standards in the US and Europe currently hampers international identification of all 'chipped' animals (Fearon, 2004).

Some studies have been undertaken to establish the size and other characteristics of small animal populations (Table 4.2). However, such animals frequently are kept in small numbers – often only one animal per household. It is therefore necessary to contact many owners to gain information about relatively few animals (i.e., the animal:owner ratio is low). This can be a difficult and costly exercise. The results may also be distorted by the lack of information on undetectable segments of the population such as stray, semi-domesticated and feral animals. Limited demographic data can be obtained from animal-cemetery records (e.g., Hayashidani *et al.*, 1988, 1989) and information held by pet insurance companies (e.g., Bonnett *et al.*, 1997; Egenvall *et al.*, 2000).

Non-thoroughbred horses and ponies kept as leisure animals similarly are difficult to count, and their enumeration is frequently indirect. In the UK, for example, estimation of population size has been based on the number of farriers (McClintock, 1988), the amount of shoeing steel produced (*Horse and Hound*, 1992), aerial counts (Barr *et al.*, 1986), and surveys of private households (McClintock, 1988; *Horse and Hound*, 1992). These methods have shortcomings. The first counted farriers, assuming that each shod 250 horses, and ignored unshod horses; the second assumed an average of four new sets of shoes per horse per year, again ignoring unshod horses; the aerial survey omitted horses indoors; and the household surveys excluded some categories of animals such as those in riding centres. However, each produced similar figures (for thoroughbred and non-thoroughbred horses, combined), ranging from 500 000–560 000 animals, suggesting valid, but conservative, estimates. In the US, a sample survey of equine operations has provided information on the age and type of horse (USDA, 1998).

The requirement for horse 'passports' within the European Union (EUROPA, 2000; Sluyter, 2001; HMSO, 2004) – although primarily designed to protect the health of those who eat horsemeat by preventing horses, dosed with any medicines that are not intended for use in food-producing animals, from entering the human food chain – should lead to better characterization of equine populations.

Populations of wild animals can be enumerated either **directly** or **indirectly**. Direct methods involve observation of individual animals, and include aerial and ground counts (Seber, 1973; Norton-Griffiths, 1978; Southwood, 1978; Buckland *et al.*, 1993). A common method is **capture–release–recapture** in which animals are caught, marked and released. A second sample is then captured. The numbers of marked animals recaptured in the second sample is then related to the number initially marked. The simplest index for estimating the number of individuals (Lincoln, 1930) is:

**Table 4.2** Some demographic studies of dog and cat populations.

Country/region	Characteristics recorded	Source
Bali	Type and characteristics of urban pet ownership*	Margawani and Robertson (1995)
Canada: Ontario	Breed, age, owner characteristics <sup>†</sup>	Leslie <i>et al.</i> (1994)
Cyprus	Population size	Pappaioanou <i>et al.</i> (1984)
Europe	Population size (by country) For UK: regional distribution, owner characteristics	Anderson (1983)
Malaysia	Breed, sex, litter size, seasonal distribution of whelping	Wong and Lee (1985)
Netherlands	Population size*	Lumeij <i>et al.</i> (1998)
Norway	For Bernese mountain dog, boxer, Bichon fris�: population size, sex, age, age-specific mortality	Moe <i>et al.</i> (2001)
Philippines	Density of rural dogs	Robinson <i>et al.</i> (1996); Childs <i>et al.</i> (1998)
Sweden	Breed-specific mortality Breed, sex, age, owner characteristics	Bonnett <i>et al.</i> (1997) Egenvall <i>et al.</i> (1999); Hedhammar <i>et al.</i> (1999); Sallander <i>et al.</i> (2001)
UK	Sex, age, diet Breed Breed, sex, age	Fennell (1975) Edney and Smith (1986) Thrusfield (1989)
US	Age, health status Free-roaming populations	Lund <i>et al.</i> (1999) Levy <i>et al.</i> (2003)
US: Boston	Age at death, breed, sex	Bronson (1981, 1982)
US: California	Breed, sex, age, owner characteristics Breed, sex, age <sup>‡</sup> Owner characteristics Breed, sex, age owner characteristics	Dorn <i>et al.</i> (1967b); Franti and Kraus (1974) Schneider and Vaida (1975) Franti <i>et al.</i> (1974) Franti <i>et al.</i> (1980) Schneider (1975)
US: Illinois	Sex, age, reproductive history, owner characteristics	Griffiths and Brenner (1977)
US: Indiana	Population size Sex, age, owner characteristics	Lengerich <i>et al.</i> (1992) Teclaw <i>et al.</i> (1992)
US: Kansas	Age, population dynamics	Nasser and Mosier (1980)
US: Nevada	Age, population dynamics	Nasser <i>et al.</i> (1984)
US: New Jersey	Breed, sex, age	Cohen <i>et al.</i> (1959)
US: Ohio	Breed, sex, age, owner characteristics	Schnurrenberger <i>et al.</i> (1961)
Zimbabwe	Population size, sex, age, owner characteristics	Butler and Bingham (2000)

\* Also reports ownership of birds and exotic species.

<sup>†</sup> Owner characteristics vary between studies, and include age, occupation, location (urban versus rural), number and age of children, and type of dwelling.

<sup>‡</sup> Also reports ownership of horses.

$$\hat{N} = \frac{an}{r}$$

where:

$\hat{N}$  = estimated population size;

$a$  = number of individuals initially marked;

$n$  = number of individuals in the second sample;

$r$  = number of marked individuals recaptured in the second sample.

Capture–release–recapture techniques have also been applied to estimating the size of dog populations (Beck, 1973; Anvik *et al.*, 1974; Heussner *et al.*, 1978); and these and other marking techniques can also provide information on the movement, home range and territories of wild animals, which can be relevant to disease transmission (see Chapter 7). The marking of bait, for example, has facilitated identification of badgers' territories that overlap with dairy farms in

**Table 4.3** Holdings by size of herd or flock: UK, June, 1997. (From HMSO, 1998.)

<b>Dairy breeding herds</b>	1-<10	10-<30	30-<40	40-<50	50-<70	70-<100	100-<200	200 and over	Total
No. of holdings	2 260	5 776	3 913	3 761	6 349	6 725	6 638	907	36 329
No. of cows	8 556	115 380	134 449	166 085	371 512	556 454	872 926	250 531	2 475 893
<b>Beef breeding herds</b>	1-<10	10-<30	30-<40	40-<50	50-<100	100 and over			Total
No. of holdings	26 648	24 588	5 802	3 876	7 401	2 799			71 114
No. of cows	117 719	431 979	196 459	169 690	502 693	421 978			1 840 518
<b>Cattle and calves</b>	1-<10	10-<30	30-<40	40-<50	50-<70	70-<100	100-<200	200 and over	Total
No. of holdings	13 815	27 613	9 853	8 391	13 849	15 338	26 123	14 517	129 499
No. of cattle	71 890	521 571	337 099	371 439	816 578	1 282 243	3 679 415	4 477 959	11 558 194
<b>Pig breeding herds</b>	1-<10	10-<20	20-<50	50-<100	100-<200	200-<500	500-<1000	1000 and over	Total
No. of holdings	4 583	1 206	1 260	864	979		1 327		10 219
No. of pigs	16 168	16 549	39 533	61 618	139 810		651 851		925 529
<b>Pigs</b>	1-<10	10-<20	20-<50	50-<100	100-<200	200-<500	500-<1000	1000 and over	Total
No. of holdings	4 039	1 329	1 606	1 022	1 035	1 622	1 309	2 281	14 243
No. of pigs	13 768	18 186	50 786	73 065	147 417	532 937	947 295	6 189 040	7 972 494
<b>Sheep breeding flocks</b>	1-<50	50-<100	100-<200	200-<500	500-<1000	1000 and over			Total
No. of holdings	22 446	14 861	16 138	18 204	7 903	3 008			82 560
No. of sheep	516 765	1 065 407	2 284 127	5 732 217	5 428 889	4 480 397			19 507 802
<b>Sheep</b>	1-<50	50-<100	100-<200	200-<500	500-<1000	1000 and over			Total
No. of holdings	15 740	10 658	14 463	20 608	13 367	12 301			87 137
No. of sheep	341 880	778 980	2 095 656	6 674 783	9 518 316	2 278 636			42 196 001

the south-west of England on which tuberculosis is present, indicating that infected badgers could be the source of infection on these farms (Cheeseman *et al.*, 1981).

The validity of this method depends on several assumptions such as complete mixing of marked animals in the population; the population is not increased by immigration and birth; marked and unmarked animals are equally likely to be captured in each sample; and marks are not lost or overlooked (Seber, 1973; Southwood, 1978). An alternative approach, with fewer assumptions, is **distance sampling**. This involves measurement of perpendicular distances between a series of transverse lines and animals observed from them, and then computation of animal density using an appropriate statistical model (Buckland *et al.*, 1993). The main assumptions are that animals are distributed randomly (see Chapter 8); the probability (see Chapter 12) of detecting animals from the lines is one; and distances are measured exactly. Childs *et al.* (1998) provide an example relating to rural dog populations, as well as an assessment of marking methods.

Direct methods can be inaccurate when animals live in concealed habitats. The size of deer populations in woodland, for example, may be underestimated by a factor of four when direct methods are used (Ratcliffe, 1987; Langbein, 1996). Indirect methods are then more appropriate. These semi-quantitative techniques include assessing the effect of grazing and browsing on trees and plants ('impact levels') (Mayle *et al.*, 1999),

dung surveys (Marques *et al.*, 2001) and counting tracks when they can be observed on snow and soft soil (Dzieciolowski, 1976).

### Separated populations

Separated populations occur as discrete units such as herds and flocks. They are particularly common in countries that practise intensive animal production, with many animals on one farm (e.g., many of the developed countries). Table 4.3 illustrates the various sizes of these units in the UK; most animals of all species are kept in larger units.

A separated population can be **closed**, with no movement of animals into or out of the unit (except to slaughter). An example is a dairy herd that raises its own replacements, or is under statutory control of movement. Two extreme examples of closed populations are the specific-pathogen-free (SPF) and gnotobiotic colonies of laboratory animals.

A separated population can also be **open**, with limited movement of individuals in and out. Examples include beef herds where animals are brought in from other farms and markets for fattening, and dairy herds that receive replacements from other farms.

Separated populations, especially of the closed type, are less likely to be infected with agents from other areas than contiguous populations. However, if infection enters separated populations, it may spread rapidly because the animal density frequently is high.

### Assessing the size of separated populations

It is often easier to obtain information on the size of a separated than a contiguous population. The large numbers of animals kept under conditions of intensive husbandry in a single separated unit usually have only one owner (i.e., the animal:owner ratio is high). Many demographic data about food animals are available as a result of regular censuses and estimations (annually, in the UK, for example<sup>5</sup>). The most extensive sources are the *Animal Health Yearbook* of the Food and Agriculture Organization of the United Nations and *Office International des Epizooties*; animal population sizes in *Tables 1.8* and *1.10* were obtained from the first source.

Thoroughbred horses are members of separated (usually open) populations. They are concentrated in stables in major training areas and can be counted easily. Published figures, however, may not be comprehensive. Thoroughbred horses in training in the UK, for example, are recorded annually, but they comprise only a small and variable age group. Stud books provide information on stallions, mares and foals, but may be incomplete.

## Measures of disease occurrence

### Prevalence

Prevalence,  $P$ , is the number of instances of disease or related attributes (e.g., infection or presence of antibodies) in a known population, at a designated time, without distinction between old and new cases. When the time is not specified, prevalence usually refers to **point prevalence**; that is, the amount of disease in a population at a particular point in time.

**Period prevalence** refers to the number of cases that are known to have occurred during a specified period of time; for example, a year (**annual prevalence**). It is the sum of the point prevalence at the beginning of the period and the number of new cases that occur during the period, and can therefore be used when the exact time of onset of a condition is not known (e.g., some behavioural condition). **Lifetime prevalence** is the number of individuals known to have had disease for at least part of their life.

Although prevalence can be defined simply as the number of affected animals, it is most meaningful

when expressed in terms of the number of diseased animals in relation to the number of animals in the population at risk of developing the disease:

$$P = \frac{\text{number of individuals having a disease at a particular point in time}}{\text{number of individuals in the population at risk at that point in time}}$$

For example, if 20 cows in a herd of 200 cows were lame on a particular day, then the prevalence of lameness in the herd on that day would be 20/200, that is, 0.1. This is a **proportion** that represents the **probability** of an animal having a specified disease at a given time. Prevalence can take values between 0 and 1, and is dimensionless. Sometimes, it is expressed as a percentage. Thus, a prevalence of 0.1 = 10%. Additionally, if a disease is rare, its prevalence may be expressed as:

$$\frac{\text{number of cases of disease}}{\text{population at risk}} \times 10^n$$

where  $n$  is an integer depending on the rarity of the disease. Thus, prevalence may be expressed per 10 000 population at risk ( $n = 4$ ) or per 1 000 000 population at risk ( $n = 6$ ).

### Incidence

**Incidence** is the number of new cases that occur in a known population over a specified period of time. The two essential components of an incidence value are:

1. the number of new cases;
2. the period of time over which the new cases occur.

Incidence, like prevalence, can be defined simply in terms of the number of affected animals, but again is usually expressed in relation to the population at risk.

### Cumulative incidence

The **cumulative incidence, CI**, (also termed **risk**) is the proportion of non-diseased individuals at the beginning of a period of study that become diseased during the period:

$$CI = \frac{\text{number of individuals that become diseased during a particular period}}{\text{number of healthy individuals in the population at the beginning of that period}}$$

It is therefore a proportion that can take values between 0 and 1 (or 0–100%), and is dimensionless.

Thus, if 20 animals in a cattery develop feline viral rhinotracheitis during a week, and there are 100 healthy cats in the cattery at the beginning of the week, then, for the week:

<sup>5</sup> The first census of livestock in England was undertaken as early as 1086, as part of the 'Domesday Survey'. Unfortunately, though, when the data were edited, they were also abridged by omission of the livestock numbers from the published document, the *Liber de Wintonia (Book of Winchester)*, for most parts of the country (Morris, 1976).

**Table 4.4** Example of calculation of incidence rate: enzootic bovine leucosis (EBL) (hypothetical data).

Cow number	Period of observation	Time of development of EBL after beginning of observation	Contribution to animal-years at risk
1	7 years	No disease	7 years
2	7 years	No disease	7 years
3	4 years	4 years	4 years
4	5 years	No disease	5 years
5	6 years	No disease	6 years
6	8 years	No disease	8 years
7	5 years	5 years	5 years
8	2 years	No disease	2 years
9	9 years	No disease	9 years
10	5 years	No disease	5 years
<i>Total</i>			58 years

**Calculation:**

Total number of cases = 2.

Incidence rate = 2 per 58 animal-years at risk

= 3.5 per 100 animal-years at risk, i.e. 0.035 per animal-year at risk.

$$CI = \frac{20}{100} = 0.2.$$

The longer the period of observation, the greater the risk. Thus, if 10 more cats developed the disease during a second week of observation, the cumulative incidence would be 0.3 for the 2-week period.

If the cumulative incidence has been estimated for one time period,  $x$ , it can be extrapolated to other periods,  $y$ :

$$CI_y = 1 - (1 - CI_x)^{y/x},$$

assuming that the risk is constant (Martin *et al.*, 1987). For example, if the cumulative incidence in 1 year is 0.30, and the value in 3 years is required, then  $x = 1$ ,  $y = 3$ , and:

$$\begin{aligned} CI &= 1 - (1 - 0.30)^{3/1} \\ &= 1 - 0.7^3 \\ &= 1 - 0.34 \\ &= 0.66. \end{aligned}$$

Cumulative incidence is an indication of the average risk of developing disease during a particular period, in both the individual and the population. It is usually calculated only for the first occurrence of a disease (rather than for multiple occurrences). When calculating cumulative incidence, additional animals at risk cannot be added to the initial number at risk during the period of observation. However, if non-diseased animals are removed from the population during this period, the denominator is modified by subtraction of half the value of the number removed (Kleinbaum *et al.*, 1982). Cumulative incidence is also used in dynamic populations if the period of risk is short and related to a specific event (e.g., dystokia at calving in

dairy herds), because all relevant animals can then be observed for the entire risk period.

**Incidence rate**

**Incidence rate,  $I$** , measures the rapidity with which new cases of disease develop over time:

$$I = \frac{\text{number of new cases of disease that occur in a population during a particular period of time}}{\text{the sum, over all individuals, of the length of time at risk of developing disease}}$$

The denominator is measured as 'animal-years at risk'. This is the sum of the periods of observation for each animal during which the latter is free from the disease (i.e., is at risk). As soon as an animal becomes diseased, it no longer contributes to this value. For example, six cows, free from disease, observed for 1 year would constitute '6 animal-years at risk'; equally, one cow observed for 6 years would constitute '6 animal-years at risk'. An example of calculation of incidence rate is given in Table 4.4. Note that incidence rate has a dimension,  $\text{time}^{-1}$ ; incidence rate is calculated **per animal-week**, **per animal-year**, and so on. This unit of time is sometimes termed the **internal time component**.

If the incidence rate has been estimated for one time period,  $x$ , it can be extrapolated to other periods,  $y$ :

$$I_y = I_x(y/x),$$

assuming that the rate is constant (Martin *et al.*, 1987). For example, if the incidence rate has been estimated as two cases per animal-year at risk, and the rate per animal-month is required, then  $y = 1$  and  $x = 12$  (1 year = 12 months), and:

$$I_y = 2(1/12) \\ = 0.17 \text{ per animal-month at risk.}$$

Similarly, an incidence rate of two cases per animal-month at risk is equivalent to 24 cases per animal-year at risk.

The technique is based on the idea that the movement to the diseased state depends on:

- the size of the population;
- the period of observation;
- the 'force of morbidity'.

The force of morbidity (also termed the 'hazard rate' and 'instantaneous incidence rate') is a theoretical measure of the risk of occurrence of disease at a point in time, and it is this that is estimated by the incidence rate. The measure accommodates movement into and out of the population (e.g., heifers being brought into, and cows leaving, a dairy herd) during an observed time period, and is calculated when the population is relatively dynamic and disease is not restricted to a particular period of time.

Frequently the exact period of observation of individual animals cannot be recorded, and so an exact incidence rate cannot be calculated. An approximate calculation is then:

$$I = \frac{\text{number of new cases of disease that occur in a population during a particular period of time}}{(\text{number at risk at the start of the time period} + \text{number at risk at the end of the time period})/2}$$

using a denominator that represents the average number at risk (Martin *et al.*, 1987).

Thus, if a herd with an average size of 70 cows was observed for a year, and pneumonia was reported in seven cows, the incidence rate is approximated by:

$$7/70 \text{ per animal-year at risk} \\ = 0.10 \text{ per animal-year at risk.}$$

The exact and approximate values are equal when the exact average period of risk for diseased animals is half of the period of observation. For example, if five animals are observed for 1 year, and three develop disease:

$$\text{one at day 72 (0.20 year)} \\ \text{one at day 180 (0.50 year)} \\ \text{one at day 290 (0.80 year)}$$

using the exact denominator:

$$I = 3/(2 + 0.20 + 0.50 + 0.80) \\ = 3/3.50 = 0.86;$$

using the approximate denominator:

$$I = 3/\{(5 + 2)/2\} \\ = 3/(7/2) = 0.86.$$

The exact and approximate incidence rates are equal, because the exact average period of risk for the diseased animals is 6 months:  $(0.20 + 0.50 + 0.80)/3 \text{ years} = 0.50 \text{ years}$ .

In contrast, if five animals are observed, and three develop disease:

$$\text{two at day 120 (0.33 year)} \\ \text{one at day 240 (0.67 year)}$$

using the exact denominator:

$$I = 3/(2 + 0.33 + 0.33 + 0.67) \\ = 3/3.33 \\ = 0.90;$$

and, using the approximate denominator, again  $I = 0.86$ .

The approximate denominator underestimates the exact rate because the exact average period of risk of diseased animals is less than 6 months:  $(0.33 + 0.33 + 0.67)/3 \text{ years} = 0.44 \text{ years}$ .

Finally, if five animals are observed, and three develop disease:

$$\text{one at day 120 (0.33 year)} \\ \text{two at day 240 (0.67 year)}$$

using the exact denominator:

$$I = 3/(2 + 0.33 + 0.67 + 0.67) \\ = 3/3.67 \\ = 0.82;$$

and, using the approximate denominator, again  $I = 0.86$ .

The approximate denominator overestimates the exact rate because the exact average period of risk of diseased animals is more than 6 months:  $(0.33 + 0.67 + 0.67)/3 \text{ years} = 0.57 \text{ years}$ .

When calculating an incidence rate, the internal time component should be short enough to allow only one bout of illness in each animal (after which time the animal ceases to be at risk). Thus, when measuring the incidence rate for bovine mastitis, an appropriate time unit could be 1 month, in which case the rate would be expressed in terms of animal-months at risk. However, in practice, some diseases may recur within the specified time unit (e.g., injuries). If the disease is of short duration, and subsequent recovery (and immunity) is brief, affected individuals can continue to be included in the population at risk, without interruption (Kleinbaum *et al.*, 1982). Alternatively, recovery periods can be defined, in which circumstance animals re-enter the population at risk after expiry of the periods (Bendixen, 1987).

The incidence rate is sometimes called, more fully, the **true incidence rate**, the **person-time incidence rate** (from human epidemiology), or the **incidence density** (Miettinen, 1976). It relates to the population, and cannot be interpreted at the level of the individual.

Cumulative incidence can be estimated from the incidence rate thus:

$$CI = 1 - e^{-I}$$

where  $e$  is the base of natural logarithms, 2.718 (see Appendix II). For example, if the incidence rate is 0.03 per year, for one year:

$$\begin{aligned} CI &= 1 - 2.718^{-0.03} \\ &= 1 - (1/2.718^{0.03}) \\ &= 1 - 0.97 \\ &= 0.03. \end{aligned}$$

Note that, in this example, the cumulative incidence and incidence rate are equal; this equality is roughly maintained when  $I < 0.10$  (Kleinbaum *et al.*, 1982). (Recall that cumulative incidence relates disease to the number at risk at the beginning of the period of observation, whereas an incidence rate relates disease to the average population at risk during the period – two different denominators. The rate is higher because the number under observation at the start of the period is reduced as cases occur and are therefore removed from the population at risk.)

Conversion of incidence rate to cumulative incidence is useful for comparing incidence between different studies of a disease that use each of the two parameters. For example, in a study of urinary incontinence in neutered bitches in the UK (Thrusfield *et al.*, 1998), an incidence rate of 0.0174 per animal-year at risk was estimated. This was the equivalent of a 10-year cumulative incidence of approximately 0.16, which was not dissimilar from the 0.20 value documented in a Swiss study (Arnold *et al.*, 1989).

Incidence is discussed in detail by Kleinbaum *et al.* (1982) and Bendixen (1987).

### Attack rate

Sometimes a population may be at risk for only a limited period of time, either because exposure to a causal agent is brief, or because the risk of developing the disease is limited to a narrow age range such as the neonatal period. Examples of the first reason would be the feeding of a batch of food contaminated with a mycotoxin to a herd of cattle (e.g., Griffiths and Done, 1991), and exposure to radiation during nuclear accidents. Even if observations were made on the animals for a long time, the incidence would not change. In these circumstances, when the period of risk is brief, the term **attack rate** is used to describe the proportion of animals that develop the disease.

A **secondary attack rate** can also be defined (Lilienfeld and Lilienfeld, 1980). This is the proportion of cases of a transmissible disease that develop as a result of contact with the primary case:

### Secondary attack rate

$$\begin{aligned} &\text{number of individuals exposed to the} \\ &\text{primary case that develop disease within} \\ &\text{the range of the incubation period} \\ &= \frac{\text{total number of individuals exposed}}{\text{to the primary case}} \end{aligned}$$

(Cases occurring outside the range of the incubation period are usually the result of contact with secondary cases, and are therefore called tertiary cases.) If the incubation period of the disease is not known, the numerator can be expressed in terms of a specified time period. The secondary attack rate is usually applied to closed aggregates of individuals such as pens and stables (and, in human populations, families and households) and is a useful measure of contagiousness (see Chapter 6).

### The relationship between prevalence and incidence rate

A disease with a long duration is more likely to be detected during a cross-sectional survey than is a disease of short duration. For example, chronic arthritis, lasting for several months, could be detected by a cross-sectional abattoir survey that was undertaken any time during the several months that the arthritis was present. However, clinical louping-ill, lasting for a few days, could be detected by a cross-sectional survey only if the survey was conducted during the short period that the disease was apparent.

Prevalence,  $P$ , therefore depends on the duration,  $D$ , and the incidence rate,  $I$ , of a disease:

$$P \propto I \times D.$$

This means that a change in prevalence can be due to:

- a change in incidence rate;
- a change in the average duration of the disease;
- a change in both incidence rate and duration.

A decrease in the incidence rate of a disease such as Johne's disease in cattle eventually will decrease the overall prevalence of the disease. Improvements in the therapy of diseases that are frequently fatal may decrease mortality, but could increase prevalence by prolonging the life of diseased animals that otherwise would have died quickly. For example, antibiotic treatment of acute bacterial pneumonia could decrease the fatality of the disease but could increase the number of convalescent animals with chronic pneumonia.

The prevalence of a disease also can be decreased if the duration of the disease is reduced. Improvements in therapy, for instance, may accelerate recovery.

### Calculation of incidence rate from prevalence

The exact relationship between prevalence and incidence rate is complex (Kleinbaum *et al.*, 1982), but a simple mathematical relationship can be derived under **steady-state** conditions (i.e., assuming a stable population and a constant incidence rate and prevalence):

$$P(1 - P) = I \times D.$$

When  $P$  is small, this simplifies to:

$$P = I \times D.$$

Therefore, if two components of the equation are known, the third can be calculated. For example, the annual incidence rate of occupationally acquired leptospirosis in New Zealand dairy farmers has been estimated (Blackmore and Schollum, 1983). Surveys had shown that 34% of farmers had serological reactions to leptospirosis (i.e., the prevalence of seropositive farmers was 0.34). Other work indicated that leptospiral titres of 1/24 or greater persist, on average, for 10 years (i.e., the duration of the infection, expressed as persistence of antibody at that titre, was 10 years). The number of notified cases of human leptospirosis had remained at approximately the same level for more than 10 years. Therefore, it could be assumed that a stable endemic level of disease existed in the human population. Thus:

$$P = 0.34,$$

$$D \text{ (years)} = 10.$$

Therefore:

$$\begin{aligned} I &= 0.34/10 \\ &= 0.034 \text{ (3.4\% per year).} \end{aligned}$$

This estimated annual incidence rate compares favourably to an annual notification value of 2.1% in dairy farmers in a large dairy region of New Zealand because official notifications are generally an underestimate of the true incidence of a disease. (See also Chapter 17 for a further discussion of seroconversion rates.)

### Application of prevalence and incidence values

Prevalence and incidence have different applications. Prevalence is useful if interest is focussed on existing cases; for example, in identifying disease problems for administrative purposes and for defining research priorities and long-term disease control strategies, and in evaluating diagnostic tests (see Chapter 17).

Cumulative incidence is used to predict an individual's change in health status because it indicates the probability of an individual becoming ill over a specified period of time. In contrast, an incidence rate cannot be directly interpreted at the individual level, but is appropriate when the speed of development of new cases in a population needs to be known.

### Causal studies

Investigations of causal factors ideally require knowledge of incidence. This is because incidence values directly estimate the probability of developing disease during a specified period of time, and therefore permit the epidemiologist to determine whether the probability of developing disease differs in different populations or time periods in relation to suspected causal factors (Lilienfeld and Lilienfeld, 1980). The choice of the appropriate incidence measure (cumulative incidence versus incidence rate) in causal studies is discussed briefly in Chapter 15 and in detail by Kleinbaum *et al.* (1982).

When attempting to identify causal associations, disease occurrence in the presence of a hypothesized causal factor is compared with disease occurrence in the absence of the factor. This can be conducted either by:

- comparing the **absolute** difference between values (e.g., the absolute difference between a cumulative incidence of 0.0010 over 10 years in a group 'exposed' to a factor, and of 0.0001 in an 'unexposed' group, is 0.0009); or
- comparing the **relative** difference between the two groups (0.0010/0.0001 = 10 in the above example).

A relative measure gives a clear indication of the **magnitude** of the difference, and is often applied in causal studies. This topic is discussed in detail in Chapter 15.

### Mortality

Mortality measures are analogous to incidence measures where the relevant outcome is death associated with, rather than new cases of, a specific disease.

### Cumulative mortality

**Cumulative mortality, CM**, can be estimated in a similar way to cumulative incidence, but with the numerator comprising the number of deaths due to a particular disease over a specified period of time, and the denominator comprising the number of individuals at risk of dying during that period. Diseased



animals present at the beginning of the period of observation are included in the denominator.

$$CM = \frac{\text{number of individuals that die during a particular period}}{\text{number of individuals in the population at the beginning of that period}}$$

### Mortality rate

**Mortality rate (mortality density),  $M$** , is calculated similarly to incidence rate. The numerator comprises the number of deaths. However, since an animal is at risk of dying **after** onset of disease, animals that develop disease continue to be included in the denominator until they die.

$$M = \frac{\text{number of deaths due to a disease that occur in a population during a particular period of time}}{\text{the sum, over all individuals, of the length of time at risk of dying}}$$

### Death rate

The **death rate** is the total mortality rate for **all** diseases – rather than one specific disease – in a population. (Some authors do not distinguish between mortality rate and death rate. Thus, a disease-specific death rate may be encountered. Similarly, a crude mortality rate, referring to deaths from all causes, may be described.)

### Case fatality

The tendency for a condition to cause the death of **affected** animals in a specified time is the **case fatality,  $CF$** . This is the proportion of diseased animals that die:

$$CF = \frac{\text{number of deaths}}{\text{number of diseased animals}}$$

It measures the probability of death in diseased animals, is dimensionless, and can take values between 0 and 1 (or 0–100%).

The value of the case fatality depends on the time of observation, which can range from a brief period of hospitalization to several years. If the period of observation is long (e.g., in cases of chronic diseases such as cancer), it is more appropriate to quote **survival**.

### Survival

**Survival,  $S$** , is the probability of individuals with a specific disease remaining alive for a specified length of time.

$$S = \frac{N - D}{N}$$

where:

$D$  = the number of deaths observed in a specified period of time,

$N$  = the number of newly diagnosed cases under observation during the same period of time.

Survival is the complement of case fatality. Thus, for a given period of observation, the sum of the case fatality and survival should equal 1 (100%).

During observation, an animal may die, survive, or be 'censored'. An animal is censored when follow-up ends before death or completion of the full period of observation (e.g., if an animal cannot be traced or the study is terminated)<sup>6</sup>.

One-year or 2-year (and in humans, 5-year or 10-year) survival times are often quoted for cancer cases. These times also provide a useful way of summarizing prognosis with or without treatment.

In domestic animals, survival depends not only on the characteristics of the disease but also on subjective factors, such as humane and economic reasons for euthanasia in pet animals and farm livestock, respectively. The effects of these factors can be removed when evaluating net effect of therapeutic procedures by including only animals that died from the disease or that were killed in its terminal stage.

Using the data in *Figure 4.2*, survival for at least 1 year can be estimated:

$$S = \frac{6}{7} = 0.86 \text{ (86\%)}$$

However, 2-year survival is more difficult to calculate because of the two censored observations (animals D and E). If these animals survived for at least 2 years, the 2-year survival would again be 6/7 (0.86). However, if these two animals died within 2 years, the survival would be 4/7 = 0.57. Statistical techniques, termed **survival analyses**, have been devised to deal with such incomplete data. A common method uses **life tables**.

Life tables were originally developed by demographers and actuaries to describe the lifetime of a theoretical population, based on the observed estimates from an actual population. They are, however, easily adapted to mortality and morbidity data.

<sup>6</sup> There are two types of censored observation resulting from an event not being observed on every subject. For example, if an aircraft-engine part is being tested, an experimenter may conduct the test on engine parts and decide to terminate observation at a pre-specified velocity. Thus, velocity disintegration is only known for those parts that break before the pre-specified velocity; this constitutes **Type I** censoring. Alternatively, the experimenter may decide observation is terminated when a given number of failures occurs, where this number is less than the number of parts observed; this is **Type II** censoring. In epidemiological studies, censoring is usually caused by time restrictions, and is therefore of Type I.

**Table 4.5** Life table of 86 diabetic dogs. (Raw data supplied by Peter Graham and Andrew Nash, University of Glasgow Veterinary School.)

Time from diagnosis (months) ( <i>j</i> )	No. survivors ( <i>n<sub>j</sub></i> )	No. censored observations ( <i>c<sub>j</sub></i> )	Population at risk ( <i>n<sub>j</sub> - c<sub>j</sub>/2</i> )	No. dogs dying ( <i>d<sub>j</sub></i> )	Estimated probability of death ( <i>q̂<sub>j</sub></i> )	Estimated probability of survival ( <i>p̂<sub>j</sub></i> )	Estimated cumulative probability of survival at beginning of interval ( <i>P̂<sub>j</sub></i> )
0-1	86	1	85.5	5	0.058	0.942	1.000
>1-2	80	0	80.0	3	0.038	0.963	0.942
>2-3	77	0	77.0	2	0.026	0.974	0.907
>3-4	75	1	74.5	3	0.040	0.960	0.883
>4-5	71	1	70.5	3	0.043	0.957	0.847
>5-6	67	0	67.0	2	0.030	0.970	0.811
>6-12	65	3	63.5	5	0.079	0.921	0.787
>12-18	57	3	55.5	6	0.108	0.892	0.725
>18-24	48	7	44.5	6	0.135	0.965	0.647
>24-30	35	4	33.0	2	0.061	0.939	0.559
>30-36	29	5	26.5	2	0.075	0.925	0.525
>36-42	22	5	19.5	3	0.154	0.846	0.486
>42-48	14	5	11.5	3	0.261	0.739	0.411
>48-54	6	1	5.5	1	0.182	0.818	0.304
>54-60	4	2	3.0	0	0.000	1.000	0.249
>60	2	1	1.5	1	1.000*	0.000	0.083

\* Logically, the probability of death beyond 5 years = 1.

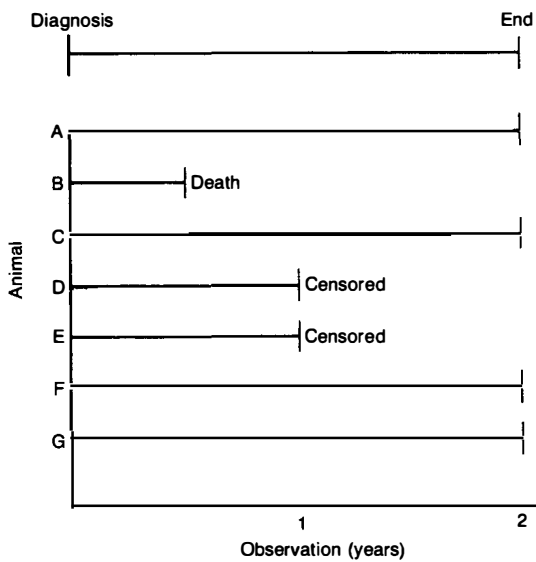

**Fig. 4.2** Survival of seven diseased animals (hypothetical data).

The events being observed are divided into *j* discrete intervals of time, and, given a sample of *N* individuals, the cumulative probability of survival is calculated, using the following data for each interval (Lee, 1992):

- the number of survivors in the population at the beginning of the interval, *n<sub>j</sub>*;
- the number of censored observations during the interval (i.e., individuals lost to follow-up), *c<sub>j</sub>*;
- the population at risk during the interval *n<sub>j</sub> - c<sub>j</sub>/2\**;

\* Half the number of withdrawals, *c<sub>j</sub>/2*, is applied on the assumption that the mean withdrawal time occurs at the midpoint of the time interval (Elandt-Johnson, 1977).

- the number of individuals in which death occurs during the interval, *d<sub>j</sub>*;
- the estimated probability of death occurring during the interval,  $\hat{q}_j = d_j / (n_j - c_j/2)$ ;
- the estimated probability of death not occurring during the interval,  $\hat{p}_j = 1 - \hat{q}_j$ ;
- the estimated cumulative probability of surviving all preceding intervals,  $\hat{P}_j = \hat{p}_0 \times \hat{p}_1 \times \dots \times \hat{p}_{j-1} = \hat{P}_{j-1} \times \hat{p}_{j-1}$ .

Table 4.5 is a life table for 86 diabetic dogs presented at a veterinary clinic.

Up to 1 month:

$$\begin{aligned}
 n_0 &= 86 \\
 c_0 &= 1 \\
 n_0 - c_0/2 &= 86 - 0.5 \\
 &= 85.5 \\
 d_0 &= 5 \\
 \hat{q}_0 &= d_0 / (n_0 - c_0/2) \\
 &= 5/85.5 \\
 &= 0.058 \\
 \hat{p}_0 &= 1 - \hat{q}_0 \\
 &= 1 - 0.058 \\
 &= 0.942
 \end{aligned}$$

$\hat{P}_0 = 1.000$  (all animals being alive at the beginning of the period of observation).

Thus, up to 2 months,  $\hat{P}_1 = \hat{p}_0 = 0.942$ ,

up to 3 months,  $\hat{P}_2 = \hat{p}_0 \times \hat{p}_1 = 0.942 \times 0.963 = 0.907$ ,

**Table 4.6** One-year survival of cats with mammary carcinoma according to some prognostic factors. (Based in Weijer and Hart, 1983.)

Prognostic factor	Number of cats	Survival
No tumour + ve lymph nodes	107	0.58
Tumour + ve lymph nodes	43	0.22
Diameter of primary tumour:		
1 cm	27	0.72
2 cm	31	0.41
3–5 cm	98	0.40
≥6 cm	44	0.23

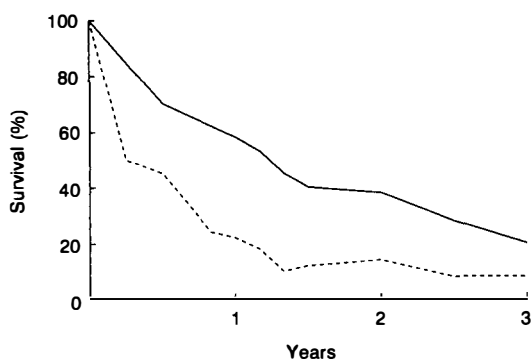
**Fig. 4.3** Survival curve of cats with mammary carcinoma in relation to the presence of tumours in lymph nodes at initial diagnosis. The survival of cats was calculated at 3-monthly intervals, and the points joined by straight lines. — no tumour-positive lymph nodes; - - - - tumour-positive lymph nodes. (Redrawn from Weijer and Hart, 1983.)

up to 4 months,

$$\begin{aligned}\hat{P}_3 &= \hat{p}_0 \times \hat{p}_1 \times \hat{p}_2 \\ &= 0.942 \times 0.963 \times 0.974 \\ &= 0.883,\end{aligned}$$

and so on.

The analysis reveals that diabetic dogs survive fairly well up to approximately 18 months after initial diagnosis (cumulative probability of survival = 0.725); survival then declines to below 25% 5 years after diagnosis.

Another common method of survival analysis is **Kaplan–Meier analysis** (Kaplan and Meier, 1958). *Table 4.6* lists the 1-year survival of cats with mammary carcinoma, after surgical removal of the tumour, estimated by the Kaplan–Meier technique, in relation to some prognostic factors (indicators). The results can also be presented graphically (*Figure 4.3*), and assist the clinician in determining prognosis. Thus, cats without secondary tumours in the lymph nodes when mammary cancer is diagnosed have a reasonable chance of surviving for 1 year (survival ≈ 60%), whereas cats with tumours in the lymph nodes have a much poorer prognosis (survival ≈ 20%).

Other measures of survival are also used in cancer studies (Misdorp, 1987). Thus, **tumour-free (disease-**

**Table 4.7** Some studies of the longevity of animals.

Species/breed etc.	Source
Captive mammals	Comfort (1957)
Cat	Comfort (1955); Hayashidani <i>et al.</i> (1989)
Dog	Comfort (1960); Hayashidani <i>et al.</i> (1988); Reid and Peterson (2000)
Bernese mountain dog, boxer, Bichon frisé: Irish wolfhound	Moe <i>et al.</i> (2001)
Horse	Comfort (1958); King (1696)
Mammals	Flower (1931)
Poultry	Pease (1947)
Sheep	Carter (1939)

**free**) survival can be estimated; however, this requires careful periodic examination for local recurrence or metastases. The success of local treatment can be expressed in terms of the **percentage recurrence** or **non-recurrence**. Systemic treatment (e.g., chemotherapy) can be assessed by the **percentage of complete or partial remission**.

Survival analysis can also be applied to periods of time during which animals are free from disease, and to studying longevity in healthy animals (Chiang, 1984); some examples are listed in *Table 4.7*.

#### Example of calculation of prevalence, incidence, mortality, case fatality and survival

Suppose a veterinarian investigates a disease that runs a clinical course ending in either recovery or death, in a herd of cattle. On 1 July 2003 the herd is investigated when the disease is already present. The herd is then observed for the following year, during which period the herd size remains the same and all animals are followed up (i.e., there are no censored observations).

Total herd size on 1 July 2003:	600
Total number clinically ill on 1 July 2003:	20
Total number developing clinical disease between 1 July 2003 and 1 July 2004:	80
Total number dying from the disease from 1 July 2003–1 July 2004:	30

**Prevalence** on 1 July 2003 = 20/600 = 0.03

**Cumulative incidence** 1 July 2003–1 July 2004 = 80/580 = 0.14

**Incidence rate** = 80/[(580 + 500)/2] = 0.15 per animal-year at risk

**Cumulative mortality** 1 July 2003–1 July 2004 =  $30/600 = 0.05$

**Mortality rate** =  $30/((600 + 570)/2)$

= 0.05 per animal-year at risk

**Case fatality** 1 July 2003–1 July 2004 =  $30/100 = 0.30$

**Survival** 1 July 2003–1 July 2004 =  $70/100 = 0.70$

(Note that in this calculation approximate incidence and mortality rates are calculated using the total population of susceptible animals as the denominator. Calculation of a true incidence rate and mortality rate would require observation of each animal so that the time of onset of disease, and occurrence of death, respectively, in each could be noted, and the number of animal-months at risk therefore recorded, as in *Table 4.4.*)

## Ratios, proportions and rates

The preceding parts of this chapter have introduced some descriptive measures of disease occurrence as proportions and rates. These two terms and a third – ratios – have been widely and sometimes improperly used in veterinary and human medicine, and therefore require further discussion.

A ratio is a value obtained by dividing one quantity by another. For example, a male:female sex ratio might be 3:2, the upper figure being the **numerator** and the lower figure the **denominator**. A proportion is a special case of a ratio in which the numerator consists of some of (i.e., is a subset of) the individuals in the denominator. Thus, prevalence, cumulative incidence, case fatality and survival are proportions. In epidemiology, the term ratio is usually confined to measures where the numerator is **not** drawn from the denominator. For example:

$$\text{fetal death ratio} = \frac{\text{number of fetal deaths}}{\text{number of live births}}$$

A rate is a ratio that expresses a change in one quantity (the numerator) with respect to another quantity (the denominator). 'Time' is usually included in the denominator. Velocity (e.g., 10 m per second) is a rate. True epidemiological rates have time as part of the denominator. Incidence rate is the commonest epidemiological rate.

However, 'rate' has sometimes been suffixed incorrectly to epidemiological ratios in which the numerator is a sub-set of the denominator (i.e., proportions). Thus, 'prevalence rate', 'cumulative incidence rate', 'case fatality rate' and 'survival rate' are sometimes used as synonyms for prevalence, cumulative incidence, case fatality and survival, respectively, although they are not true rates.

*Table 4.8* lists some common epidemiological ratios and rates. In most instances, the rates are proportions,

rather than true rates, but the terms are so well established that they are retained in this table.

Proportions and rates are expressed in three main forms: **crude**, **specific** and **adjusted**.

## Crude measures

Crude prevalence, incidence and mortality values are an expression of the amount of disease and deaths in a population as a whole; they take no account of the structure of the population affected. For instance, the crude death rate of two laboratory colonies of mice could be 10/1000/day and 20/1000/day, respectively. Initially this might suggest that the second colony has twice the disease problem of the first, but this difference in crude rates might be due only to a difference in age structure. Mice have a lifespan of about 2 years, and so if the second colony consisted of much older animals than the first, greater mortality would be expected in the second than the first colony, even without concurrent disease. Although crude rates may express the prevalence or incidence of a particular disease, they take no account of specific host characteristics, such as age, which can have a profound effect on the occurrence of disease in a population.

## Specific measures

Specific measures of disease are those that describe disease occurrence in specific categories of the population related to host attributes such as age, sex, breed and method of husbandry, and, in man, also race, occupation and socio-economic group. They convey more information than crude measures on the pattern of disease. They can indicate categories of animal that are particularly at risk of disease, and can provide evidence on its cause.

Specific measures are calculated in a similar manner to crude ones, except that the numerator and denominator apply to one or more categories of a population with specific host attributes. For instance, a whole series of different age-specific incidence rates could be calculated that would cover the entire lifespan of a particular population.

Age-specific incidence rates of many enteric diseases, such as salmonellosis and colibacillosis, can be higher in young than old animals. Sex-specific incidence rates of diabetes mellitus are higher in females than in males. The breed-specific prevalence of squamous cell carcinoma of the eye in cattle reveals that Herefords have the highest prevalence: although there is a crude prevalence of 93/100 000 for all breeds of cattle, the specific prevalence for Herefords and Hereford crosses is 403/100 000. The prevalence of goitre in budgerigars is higher in pet birds than in breeders' birds (Blackmore, 1963). Similarly, the

**Table 4.8** Some commonly used rates and ratios (indices usually refer to a defined population of animals observed for 1 year)\*. (Modified and expanded from Schwabe *et al.*, 1977.)

Name	Definition
<b>Rates</b>	
No-return rate at $n$ days:	$\frac{\text{No. animals bred that have not come back in heat in } n \text{ days after breeding}}{\text{No. animals bred}} \times 10^{a\dagger}$
Pregnancy rate at $n$ days:	$\frac{\text{No. animals pregnant at } n \text{ days after breeding}}{\text{No. animals bred}} \times 10^a$
Crude live birth rate:	$\frac{\text{No. live births occurring}}{\text{Average population}} \times 10^a$
General fertility rate:	$\frac{\text{No. live births occurring}}{\text{Average no. female animals of reproductive age}} \times 10^d$
Crude death rate:	$\frac{\text{No. deaths occurring}}{\text{Average population}} \times 10^a$
Age-specific death rate:	$\frac{\text{No. deaths among animals in a specified age group}}{\text{Average no. in the specified age group}} \times 10^a$
Calf (lamb, piglet, puppy, etc.) mortality rate:	$\frac{\text{No. deaths under a specified age}^{**}}{\text{No. live births}} \times 10^a$
Neonatal (calf, lamb, etc.) mortality rate:	$\frac{\text{No. deaths under a specified age}^{**}}{\text{No. live births}} \times 10^a$
Foetal death rate (also called stillbirth rate):	$\frac{\text{No. fetal deaths}}{\text{No. live births plus fetal deaths}} \times 10^a$
Cause-specific death rate:	$\frac{\text{No. deaths from a specified cause}}{\text{Average population}} \times 10^a$
Proportional morbidity rate:	$\frac{\text{No. of animals with a specified disease}}{\text{Total no. of diseased animals}} \times 10^a$
Proportional mortality rate:	$\frac{\text{No. deaths from a specified cause}}{\text{Total no. deaths}} \times 10^a$
<b>Ratios</b>	
Fetal death ratio (also called stillbirth ratio):	$\frac{\text{No. fetal deaths}}{\text{No. live births}} \times 10^a$
Maternal mortality ratio:	$\frac{\text{No. deaths in dams from puerperal causes}}{\text{No. live births}} \times 10^a$
Zoonosis incidence ratio (ZIR):	$\frac{\text{No. new cases of a zoonotic disease in an animal species in a given geographic area in a stated time period}}{\text{Average human population in the same area during the same period} \times \text{time}} \times 10^a$
Area incidence ratio (AIR):	$\frac{\text{No. new cases of a disease in a given time period}}{\text{Unit geographic area in which the observations are made} \times \text{time}} \times 10^a$

\* All rates could use other specified time periods.

\*\* There is not a universal agreement on the age at which animals cease to be neonates in veterinary medicine.

†  $a$  = a whole number, usually between 2 and 6; for example, if  $a = 3$ , then  $10^a = 10^3 = 1000$ .

occupation-specific prevalence values of human Q fever in Australia indicate that meat workers are the group at greatest risk (Scott, 1981).

Table 4.9a illustrates that the crude incidence rate of testicular neoplasia in castrated dogs (12.67 per 1000 dog-years at risk) reveals much less about the period at risk in a dog's life than the age-specific values. Likewise, the rates specific to location (Table 4.9b) indicate at which sites the lesion is most likely to occur.

Calculation of age-specific incidence values has given further clues to the cause of bovine spongiform encephalopathy (see Chapters 2 and 3). The mode (most frequent value) of the disease's incubation period is 4–5 years, and very few cases occur in 2-year-old animals. A statutory ban on ruminant-derived protein (meat and bone meal), the suspected source of the infection, was introduced in July 1988. Its impact therefore would be detected initially in 2-year-old

**Table 4.9** Specific incidence rates of testicular neoplasia in cryptorchid dogs. (From Reif *et al.*, 1979.)

<b>(a) Age-specific rates</b>				
Age (years)	No. of dogs	Dog-years at risk	No. of neoplasms	Age-specific rate/1000 dog-years
≤2	262	411.3	0	0.00
2-3	153	288.8	0	0.00
4-5	93	199.4	0	0.00
6-7	49	103.0	7	67.96
8-9	31	59.2	4	67.57
≥10	21	43.3	3	69.28
<i>Total</i>	609	1105.0	14	12.67

<b>(b) Rates specific to location</b>				
Location of testicles	No. of dogs	Dog-years at risk	No. of neoplasms	Incidence/1000 dog-years
Bilateral scrotal (controls)	329	680.0	0	0.00
Abdominal-scrotal	210	392.8	5	12.73
Inguinal-scrotal	188	372.2	9	24.18
Bilateral abdominal	54	96.8	0	0.00
Bilateral inguinal	27	52.5	0	0.00
Inguinal-abdominal	16	30.5	0	0.00
Cryptorchid unknown	114	160.2	0	0.00

animals 2 years later. None of the 2-year-old animals affected then had been born after the ban (Wilesmith and Ryan, 1992). This finding added credence to the hypothesis that meat and bone meal were the source of the infection.

### Adjusted (standardized) measures

Crude values can only be used to make **comparisons** between two different populations if the populations are similar with respect to all characteristics that might

affect disease occurrence. If the populations are dissimilar with respect to such characteristics, erroneous conclusions might be drawn because these characteristics may act as confounders (see Chapter 3).

For example, *Table 4.10a* presents the results of a survey of the prevalence of leptospiral antibodies (seroprevalence) in samples of unvaccinated dogs taken in two cities, Glasgow and Edinburgh. The crude seroprevalence in Glasgow is 3% higher than in Edinburgh (0.27 compared with 0.24). Assuming that the rate of antibody decline (i.e., the duration of seropositivity) is constant, this might suggest that the incidence of leptospiral infection is greater in Glasgow than in Edinburgh (reasons might include a larger population of infected feral animals in the former than the latter city).

However, factors other than location might also affect seroprevalence. Male dogs, for instance, may run a higher risk of infection because of sexual behaviour, particularly the licking of the vulva of females (Dunbar, 1979), which is likely to bring them into contact with infected urine. Other studies have already shown that leptospiral seroprevalence is higher in male dogs than in bitches (Stuart, 1946; Cunningham *et al.*, 1957; Arimitsu *et al.*, 1989).

The confounding effect of sex can be removed by adjustment (standardization) by direct and indirect methods. This involves adjusting the crude values to reflect the values that would be expected if the potentially confounding characteristics were similarly distributed in the two study populations.

**Direct adjustment** In direct adjustment, the specific values in each population are required. The sex-specific seroprevalence values for the data in *Table 4.10a* are listed in *Table 4.10b*. Note that the seroprevalence in males is higher than that in females. Note, too, that the crude values are the **weighted** average of the

**Table 4.10** Numbers and proportions (seroprevalence) of urban dogs with microscopic agglutination test antibody titres ≥1:10 to leptospire, Edinburgh and Glasgow, 1986-1988. (Based on van den Broek *et al.*, 1991.)

	<b>(a) Crude seroprevalence</b>						<b>Seroprevalence</b>	
	No. of dogs with positive titres			No. of dogs sampled				
Edinburgh	61			260			0.24	
Glasgow	69			251			0.27	
<i>Total</i>	130			511				

	<b>(b) Sex-specific seroprevalence</b>						<b>Seroprevalence</b>	
	No. of dogs with positive titres			No. of dogs sampled				
	Male	Female	Total	Male	Female	Total	Male	Female
Edinburgh	15	46	61	48	212	260	0.31	0.22
Glasgow	53	16	69	180	71	251	0.29	0.23
<i>Total</i>	68	60	130	228	283	511		

specific values, with the number of males and females used as the weights:

Edinburgh:

$$\begin{aligned}\text{Crude seroprevalence} &= \frac{(0.31 \times 48) + (0.22 \times 212)}{(48 + 212)} \\ &= 0.24.\end{aligned}$$

Glasgow:

$$\begin{aligned}\text{Crude seroprevalence} &= \frac{(0.29 \times 180) + (0.23 \times 71)}{(180 + 71)} \\ &= 0.27.\end{aligned}$$

To directly adjust these values, a **standard** population is selected, in which the frequency of the characteristic (sex, in this example) is known. Its choice is somewhat arbitrary, but it should be realistic and relevant. Thus, it may be a large population obtained from published demographic data, one of the two groups being compared, or the totals of the two groups. In this example, the totals of the two groups are used, that is, 228 males and 283 females.

The specific values in each group are now weighted by the frequency of the characteristic in the standard population:

$$\text{direct adjusted value} = sr_1 \times \frac{S_1}{N} + sr_2 \times \frac{S_2}{N}$$

where:

$sr$  = specific value in study population;

$S$  = frequency of characteristic in the standard population;

$N$  = total number in the standard population ( $S_1 + S_2 = N$ ).

For Edinburgh:

$$\begin{aligned}sr_1 \text{ (male)} &= 0.31 \\ S_1 &= 228 \\ sr_2 \text{ (female)} &= 0.22 \\ S_2 &= 283 \\ N &= 511\end{aligned}$$

$$\begin{aligned}\text{Adjusted value} &= \{0.31 \times (228/511)\} + \{0.22 \times (283/511)\} \\ &= 0.138 + 0.122 \\ &= 0.26.\end{aligned}$$

For Glasgow:

$$\begin{aligned}sr_1 \text{ (male)} &= 0.29 \\ S_1 &= 228 \\ sr_2 \text{ (female)} &= 0.23 \\ S_2 &= 283 \\ N &= 511\end{aligned}$$

$$\begin{aligned}\text{Adjusted value} &= \{0.29 \times (228/511)\} + \{0.23 \times (283/511)\} \\ &= 0.129 + 0.127 \\ &= 0.26.\end{aligned}$$

The adjusted values are similar. This suggests that sex is the factor responsible for the difference in seroprevalence between Edinburgh and Glasgow. If other characteristics (e.g., location or age) were responsible for the difference, the sex-adjusted values would be different.

In veterinary medicine, direct adjustment is indicated for age, sex, breed and other factors that may be confounders. However, the specific data are the 'facts'; the combination of specific values into a weighted average is merely a useful way of combining the values into a single index for the purpose of comparison of groups.

**Indirect adjustment** If specific values for one or both populations are not available, or the numbers with each characteristic are so small that large fluctuations in morbidity or mortality occur through the presence or absence of a few cases, the indirect method of adjustment can be used.

In indirect adjustment, only crude values are required for the two study populations, but the frequencies of the adjusting characteristic in these populations must be known. Additionally, specific values are required for the standard population. First, calculate the overall value *expected* in each population if the standard population's specific values applied:

$$\text{expected value} = Sr_1 \times \frac{S_1}{n} + Sr_2 \times \frac{S_2}{n}$$

where:

$Sr$  = specific value in standard population,

$s$  = frequency of characteristic in the study population,

$n$  = total number in the study population ( $s_1 + s_2 = n$ ).

In each population being compared, the ratio of the *observed* crude value to the *expected* value is termed the **standardized morbidity ratio** (or **standardized mortality ratio**, **SMR**, when mortality is being indirectly adjusted). These standardized ratios provide relative comparisons between two populations. They are multiplied by the crude value in the standard population to give the indirectly adjusted values for each population.

Age-adjusted SMRs, expressed as percentages, are commonly used in human medicine to relate mortality in particular occupations to the mortality experience of the general population (HMSO, 1958). The adjustment is made in 5-year blocks for adults between 20 and 64 years of age.

The advantages, disadvantages and pitfalls associated with adjustment are discussed in detail by Fleiss *et al.* (2003) and Kahn and Sempos (1989).

## Displaying morbidity and mortality values and demographic data

Morbidity and mortality values and demographic data should be recorded in a way that immediately conveys their salient features such as fluctuations in values. The methods of presentation include **tables**, **bar charts**, **time trend graphs** and **time lines**.

### Tables

Tabulation is one of the commoner techniques of displaying numerical data. It involves listing numerical values in rows and columns (e.g., *Table 4.3*).

### Bar charts

Bar charts display variables by vertical bars that have heights proportional to the number of occurrences of the variable (*Figure 4.4*). The bar chart is used to display categories in which counts are **discrete**, that is, they comprise whole numbers, such as numbers of cases of disease. (The frequency distribution of **continuous data** – defined in Chapter 9 – can be displayed in a similar fashion, in which case adjacent bars touch, and the chart is called a **histogram**; an example is given in *Figure 12.1*.) The bar chart strikingly demonstrates differences that would not be noted as easily in tables.

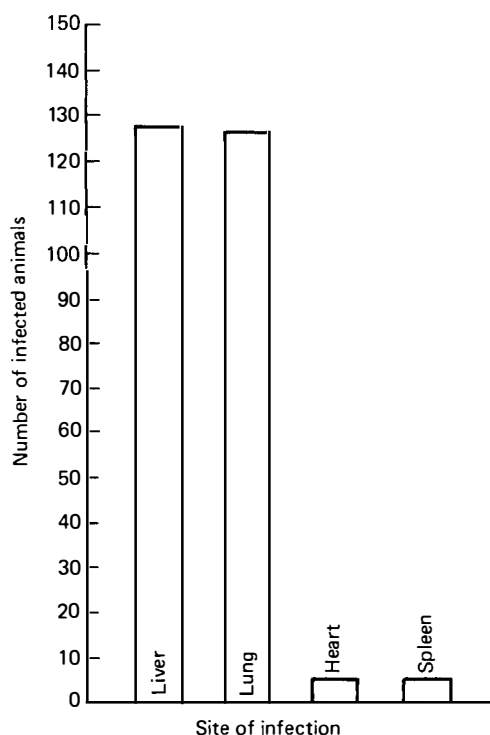

**Fig. 4.4** The distribution of hydatid cysts in organs of 765 Somalian cattle in Kuwait: an example of a bar chart. (Modified from Behbehani and Hassounah, 1976.)

### Time trend graphs

In a time trend graph the vertical position of each point represents the number of cases; the horizontal position corresponds to the midpoint of the time interval in which the cases were recorded. In *Figure 4.5*, for instance, the vertical coordinate of each point is the number of new cases of anthrax and the horizontal coordinate is the midpoint of the weekly intervals for which cases of anthrax were reported. The plotting of epidemics in this way produces **epidemic curves** (see *Figure 4.1* and Chapter 8)

### Time lines

Time lines depict disease and related events (e.g., implementation of control procedures) in chronological order, along a horizontal line representing the passage of time. They are a simple and useful way of visualizing key events (e.g., *Figure 4.6*).

## Mapping

A common method of displaying the geographical (spatial) distribution of disease and related factors is by drawing maps (cartography). This is of value not only in the recording of areas where diseases exist but also in investigating the mode and direction of transmission of infectious diseases. For example, the spatial distribution of cases of foot-and-mouth disease during the British outbreak in 1967 suggested that the infection may have been disseminated by wind (Smith and Hugh-Jones, 1969). Subsequent investigations have supported this idea (Hugh-Jones and Wright, 1970; Sellers and Gloster, 1980).

Maps can also suggest possible causes of diseases of unknown aetiology. Mapping indicated that tumours (notably of the jaw) in sheep in Yorkshire clustered in areas where bracken was common (McCrea and Head, 1978). This led to the hypothesis that bracken causes tumours. Subsequently, the hypothesis was supported by experimental investigation (McCrea and Head, 1981). Similarly, comparison of the maps of hypocupraemia in cattle (Leech *et al.*, 1982) with a geochemical atlas (Webb *et al.*, 1978) has indicated areas in England and Wales where bovine copper deficiency may be caused by excess dietary molybdenum.

At their simplest, maps may be qualitative, indicating location without specifying the amount of disease. They can also be quantitative, displaying the number of cases of disease (the numerator in proportions, rates and ratios), the population at risk (the denominator), and prevalence and incidence (i.e., including both numerator and denominator).



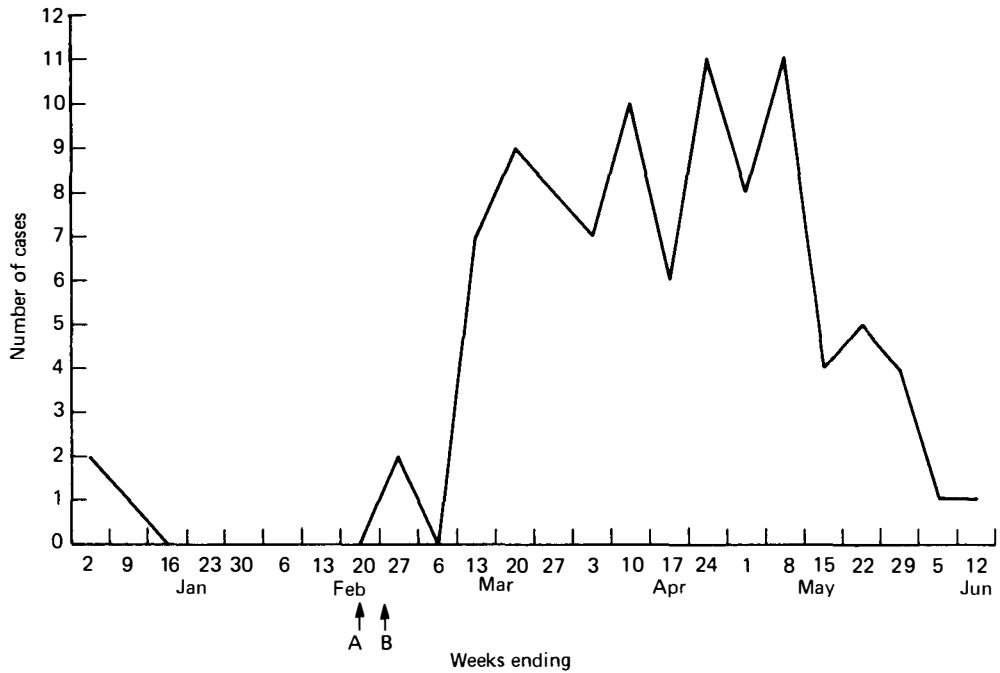
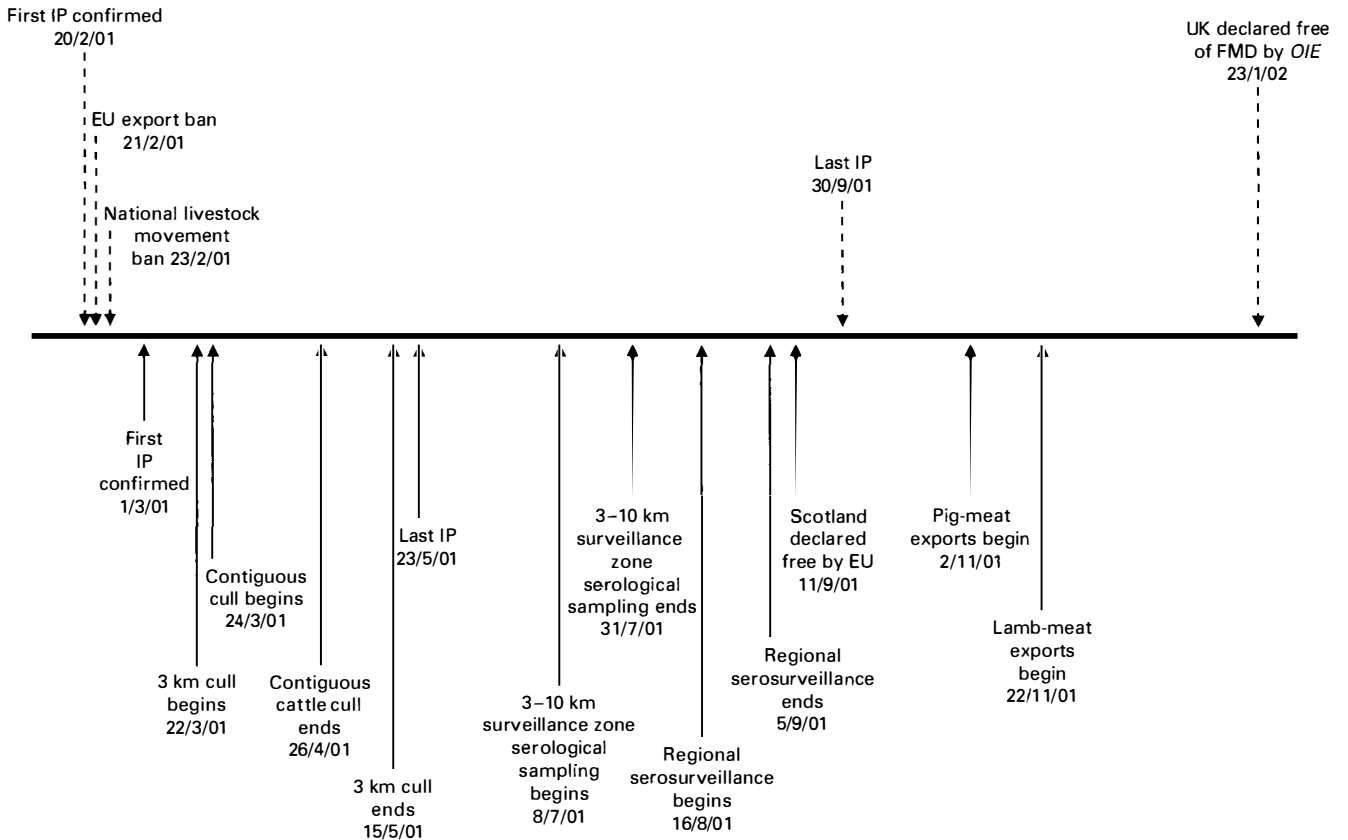
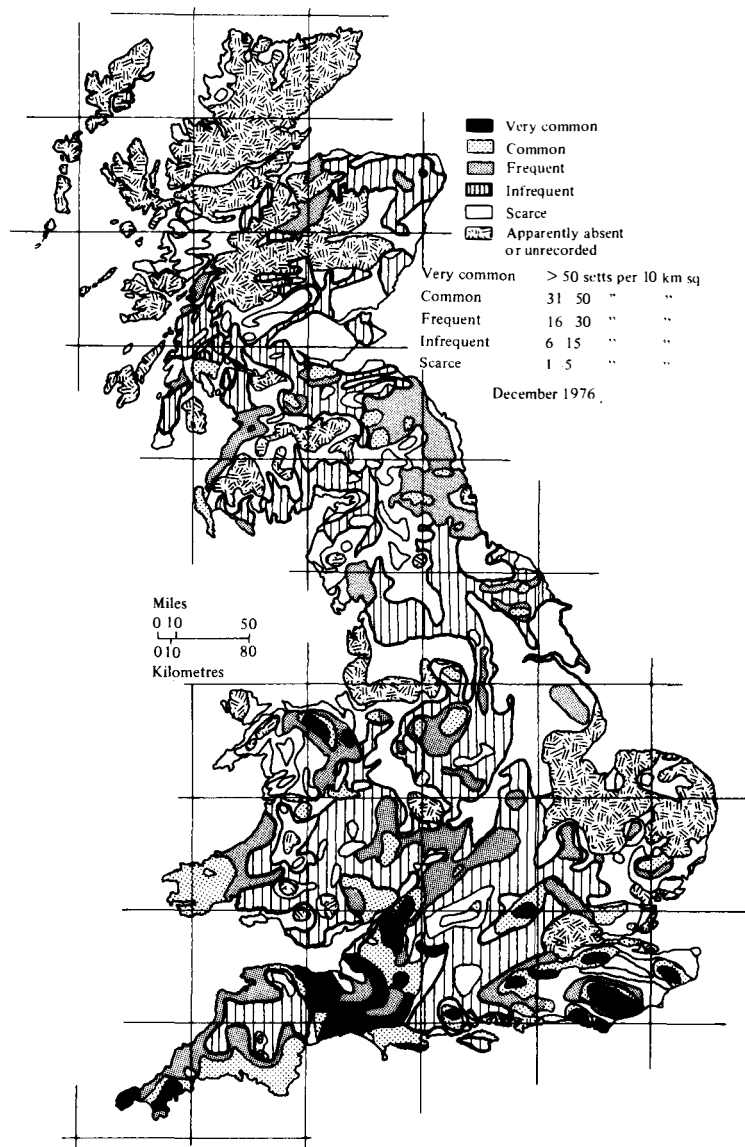

Fig. 4.5 An anthrax outbreak in cattle in England, 1 January–12 June 1977, associated with a batch of feedstuff: an example of a time trend graph. A = Feedstuff unloaded at docks; B = Feedstuff arrived at mills. (Modified from MAFF, 1977.)



Events in Dumfries and Galloway: —→; Events in the whole of the UK: - - - →. EU: European Union; IP: Premises confirmed as affected by foot-and-mouth disease; OIE: Office International des Epizooties.

Fig. 4.6 Time line of the main events in the foot-and-mouth disease epidemic in Dumfries and Galloway, Scotland, 2001. (From Thrusfield *et al.*, 2005a.)



**Fig. 4.7** Density of badger setts in Great Britain: an example of an isoplethic map (geographic base). (From Zuckerman, 1980.)

### Map bases

Maps can be constructed according to the shape of a country or region, in which case they are drawn to a **geographic base**. Alternatively, they can be drawn to represent the size of the population concerned, that is, to a **demographic (isodemographic)** base (Forster, 1966), in which morbidity and mortality information is presented in relation to population size. Demographic maps require accurate information on both the numerators and denominators in morbidity and mortality values and are not common in veterinary medicine because this information is often missing.

### Geographic base maps

Figure 4.7 is an example of a geographic base map. It is a 'conventional' map of Great Britain, showing the shape of the country. Most atlases consist of geographic base maps. There are several types of geographic base map, each with a different purpose, and displaying information in varying detail.

### Point (dot or location) maps

These maps illustrate outbreaks of disease in discrete locations, by circles, squares, dots or other symbols.

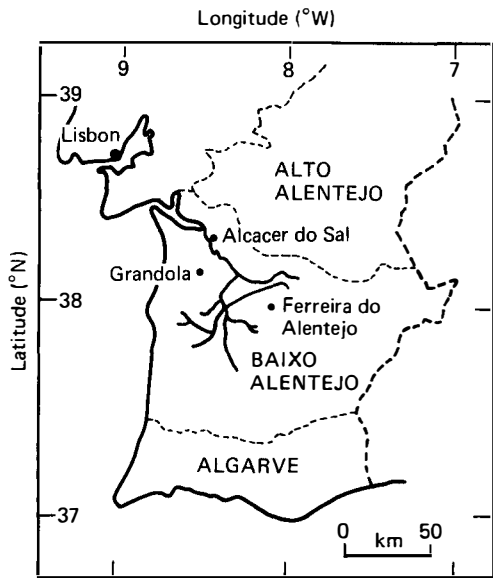

**Fig. 4.8** Outbreaks of bluetongue in Portugal; July 1956: an example of a point map. (From Sellers *et al.*, 1978.)

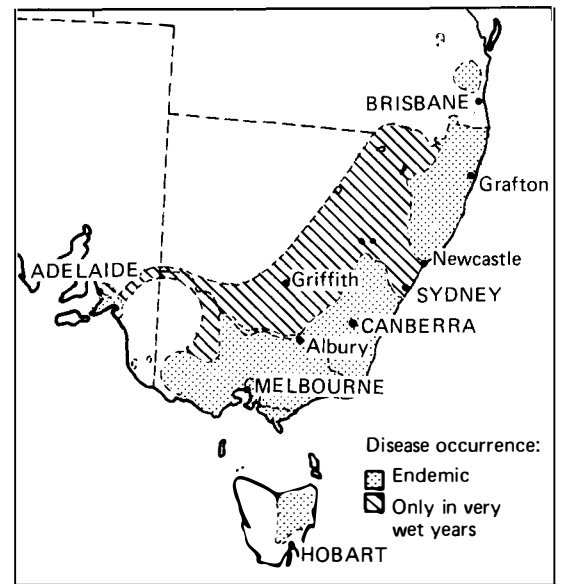

**Fig. 4.10** Fascioliasis in Australia: an example of a distribution map. (Modified from Barger *et al.*, 1978.)

An example is *Figure 4.8*, where the solid circles with adjacent names indicate the sites of outbreaks of bluetongue in Portugal. Point maps are qualitative; they do not indicate the extent of the outbreaks, which could each involve any number of animals. Point maps can be refined by using arrows to indicate direction of spread of disease. A series of point maps, displaying occurrence at different times, can indicate the direction of spread of an outbreak of disease. Additionally, point maps can be given a quantitative dimension (if data

are available) by varying the density of the dots in proportion to the amount of disease (*Figure 4.9*).

**Distribution maps**

A distribution map is constructed to show the area over which disease occurs. An example is given in *Figure 4.10*, illustrating areas in south-east Australia in which fascioliasis is continually present (endemic areas) and those that only experience the disease in wet

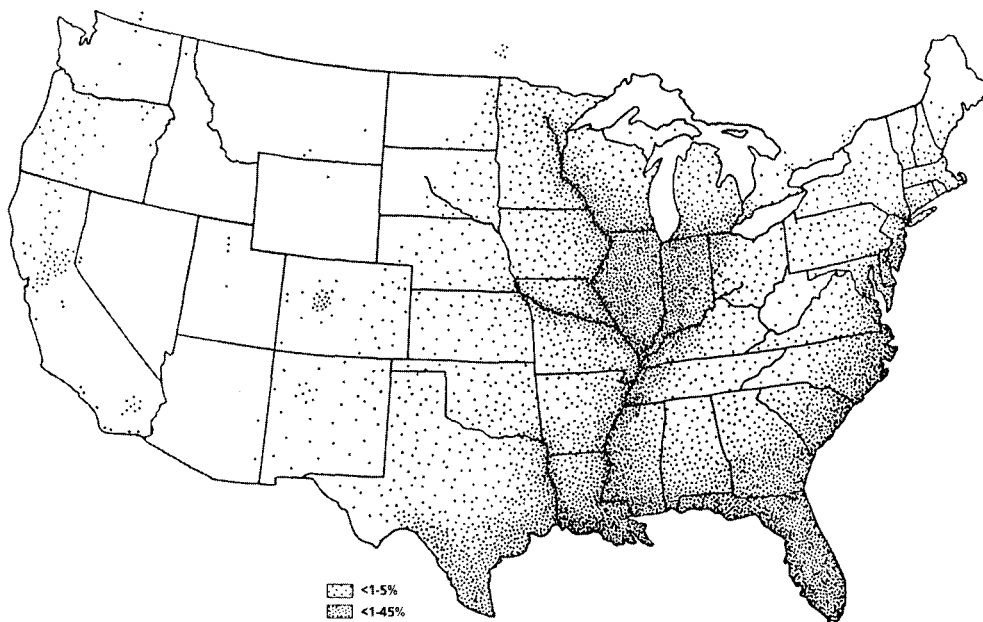

**Fig. 4.9** Prevalence of heartworm infection in the US, 1995. (From Soll and Knight, 1995.)

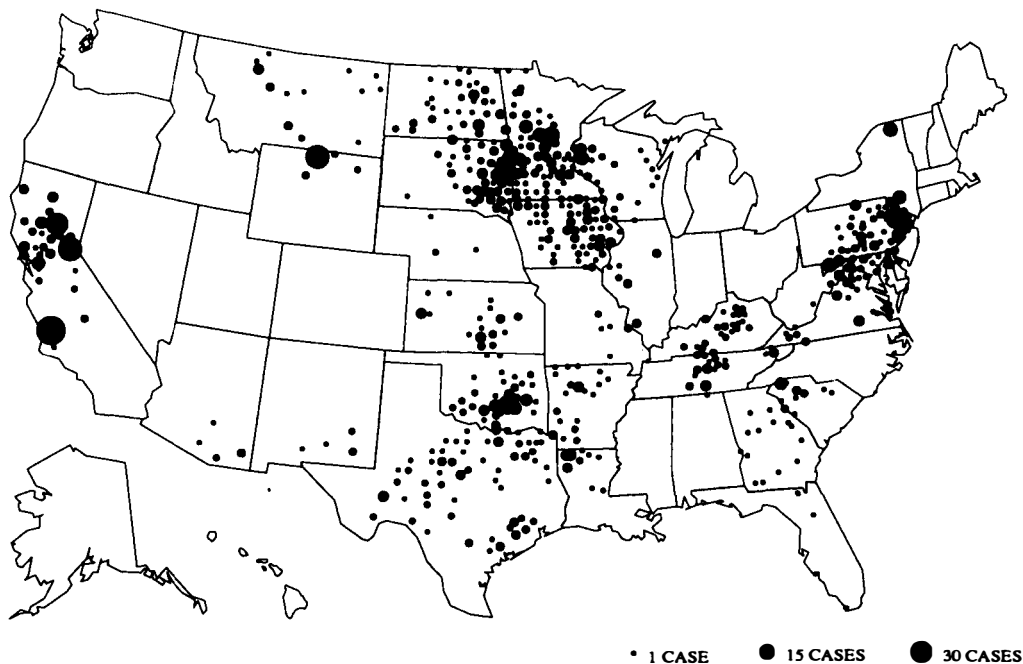

**Fig. 4.11** Reported cases of rabies in skunks in the US, by county, 1990: an example of a proportional circle map. The area of each circle is proportional to the number of cases in each county. (From Uhaa *et al.*, 1992.)

years. Further examples, showing the world distribution of the major animal virus diseases, are presented by Odend'hal (1983).

### Proportional circle maps

Morbidity and mortality can be depicted using circles whose area is proportional to the amount of disease or deaths (*Figure 4.11*). If the large values are substantially greater than the small values, the values can be represented by proportional spheres whose volume is proportional to the magnitude of the depicted characteristic. (Shading is used to give the impression of spheres on a two-dimensional map.)

### Choroplethic maps

It is also possible to display quantitative information as discrete shaded units of area, graded in intensity to represent the variability of the mapped data. The units can be formed from grid lines, but are commonly administrative areas such as parishes, shires, counties or states. Maps that portray information in this way are **choroplethic** (Greek: *choros* = an area, a region; *plethos* = a throng, a crowd, the population). *Figure 4.12* is an example.

Choroplethic maps display quantitative data, but the boundaries between different recorded values are artificial. They are not the actual boundaries between, for example, high and low prevalence; they are merely

the administrative boundaries of the areas over which the displayed values are averaged.

### Isoplethic maps

True boundaries between different values can be depicted by joining all points of equal value by a line, such as joining points of equal height to produce the familiar contour map. Maps produced this way are **isoplethic** (Greek: *iso* = equal). Lines joining points of equal morbidity are **isomorbs**, and those joining points of equal mortality are **isomorts**. If these lines are to be constructed, accurate estimates of both the number of cases of disease (numerator) and the size of the population at risk (denominator) over an area must be known.

*Figure 4.7* is an isoplethic map showing badger density in Great Britain, drawn in relation to bovine tuberculosis. In this example, the 'contours' are the boundaries between different ranges of badger density.

Medical mapping is discussed in detail by Cliff and Haggett (1988).

### Geographical information systems

Disease distribution can be mapped and analysed using **geographical information systems** (GIS) (Maguire, 1991). These are computerized systems for collecting, storing, managing, interrogating and

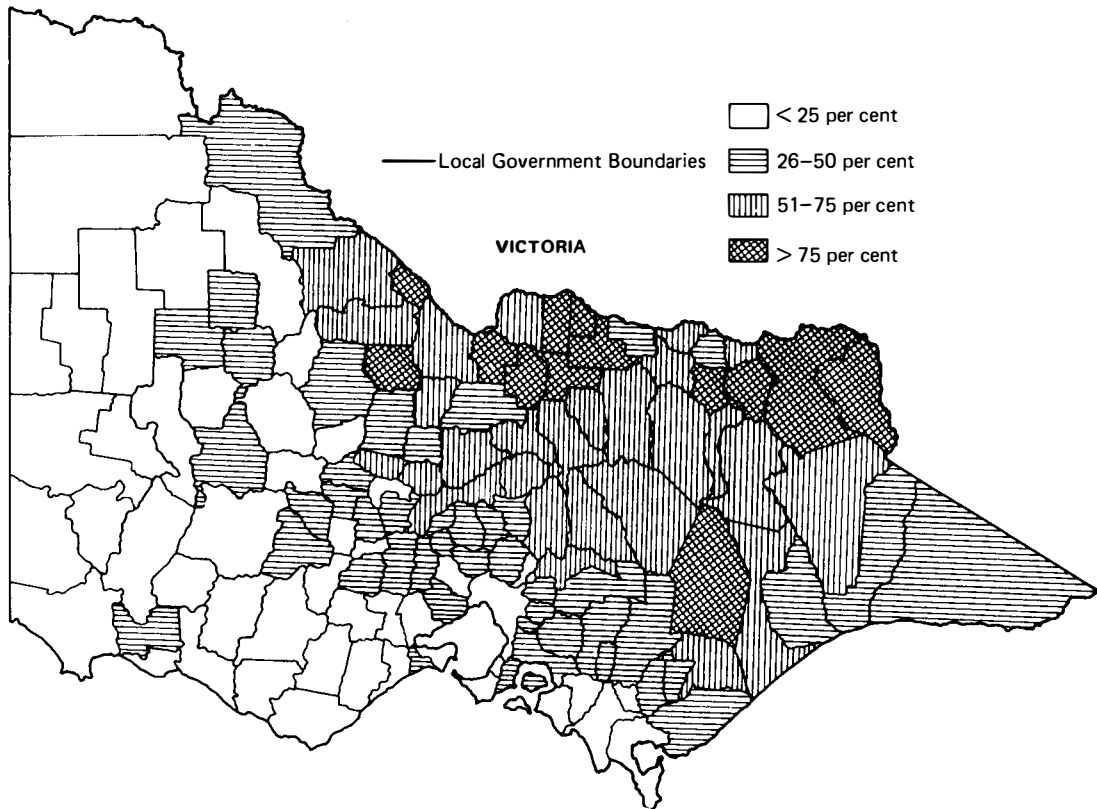

Fig. 4.12 Prevalence of fluke-affected livers by shire, Victoria, Australia, 1977–78: an example of a choropleth map. (From Watt, 1980.)

displaying spatial data. They have a range of powerful functions in addition to simple mapping; these include graphical analysis based on spatial location, statistical analysis and modelling.

### Structure of GIS

Data that are input may be **cartographic data**, describing the location of features; and textual **attribute data**, describing characteristics of the features. These types of data may be **primary** or **secondary**. Primary data may be **directly sensed** from field sketching, interviews and measurements. Alternatively, they may be **remotely sensed** (Hay *et al.*, 2000), that is, collected by a device not in direct contact with the object that is being sensed (e.g., a photographic camera). Meteorological satellites have also been used to detect habitats of ticks, mosquitoes, trematodes (Hugh-Jones, 1989) and tsetse flies (Rogers, 1991).

The GIS then store these **geographically referenced data** in a database management system in a form that can be graphically queried and summarized.

Cartographic data must be stored in **digital form** on computers. The digital maps are stored in two basic formats: **grid-based (raster-based)** and **vector-based**.

In grid-based systems, information is stored uniformly in relation to each cell that forms the grid (Figure 4.13). In vector-based systems, points and lines (arcs) are used to represent geographical features, the lines being composed of their respective straight-line segments. Areas enclosed by lines (e.g., farms) are termed polygons. A **digitizing tablet** is used to convert maps to a digital format for vector-based storage. This is an electronic board and pointer that accurately transcribes a map to digital format. A **scanner** is used for raster-based storage.

Grid-based systems store and manipulate regional and remotely sensed data conveniently, but data processing is relatively slow if high resolution is required. In contrast, vector-based systems have inherently high resolution but are complex to implement. Many current systems can analyse both vector and raster data.

### Applications of GIS

Applications of GIS (Sanson *et al.*, 1991b) include:

- **cartography**, with the advantage over traditional techniques that special-purpose maps can be produced and updated rapidly;

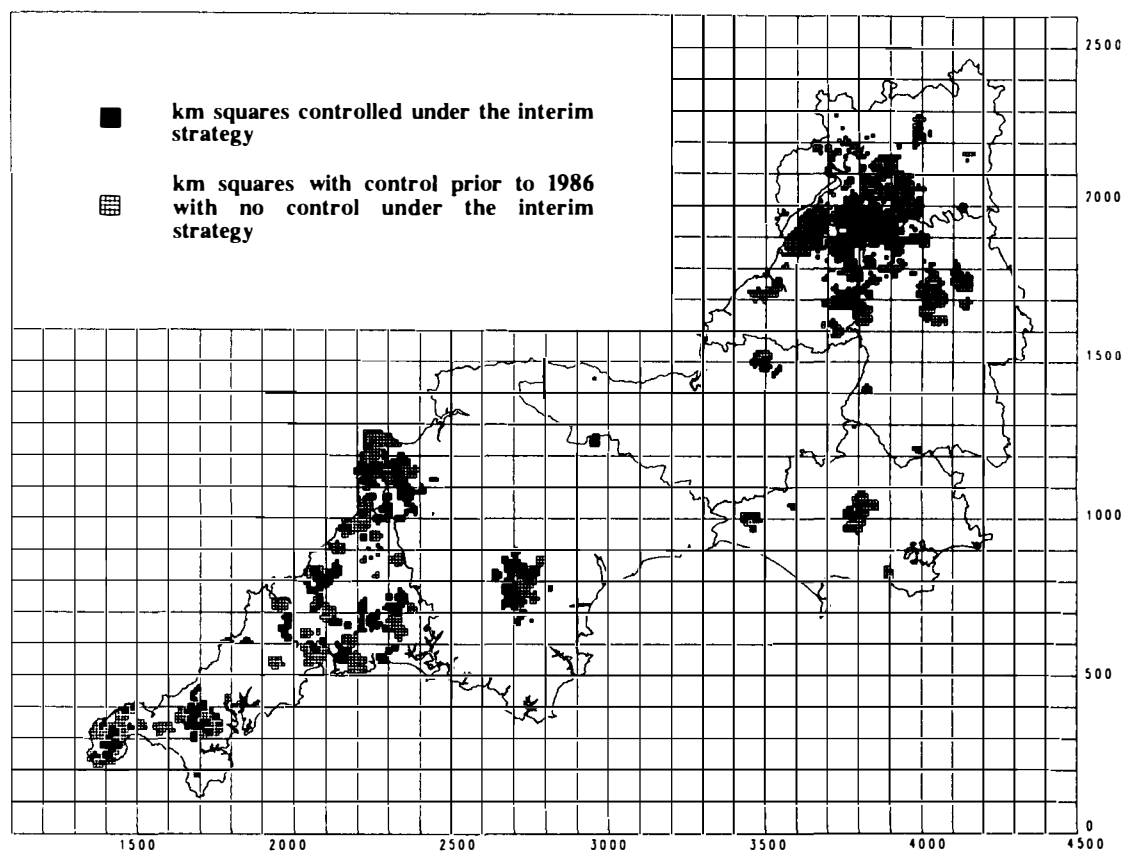

**Fig. 4.13** Areas of statutory badger control in south-west England: an example of a grid-based map generated by a geographical information system. Badgers are reservoirs of infection with *Mycobacterium tuberculosis* in this region. Statutory badger removal to control bovine tuberculosis started in 1975 and was based on areas delineated by physical barriers such as roads, so that the instigating herd of cattle and nearby herds were included. This strategy was costly and, in 1986, was replaced by an 'interim' strategy in which badgers were removed only from land used by infected herds in which infection had been unequivocally associated with badgers. Further analysis with the GIS identified areas where pre-emptive badger control could be applied. (From Clifton-Hadley, 1993.)

- **neighbourhood analysis** which allows an investigator to list all features that meet specified criteria (e.g., in the foot-and-mouth disease epidemic that occurred in the UK in 2001, in some regions all premises within a 3-km radius of an infected farm were identified, and sheep on these premises were pre-emptively culled (see Chapter 22) to reduce the perceived risk of spread of the disease, after which serosurveillance was conducted on small ruminants within a 10-km radius of each infected premises: *Figure 4.14*);
- **buffer generation** around or along certain features (e.g., definition of all properties at risk of infection within a given distance of an infected farm, or along a road that has been used by infected animals);
- **overlay analysis** in which two or more data sets are superimposed on top of one another and areas of intersection (overlay) of features identified (e.g., overlaying land-form, vegetation and watering-point locations to identify areas where animals

are difficult to muster for tuberculin testing; Laut, 1986);

- **network analysis** permitting optimal routing along networks of linear features;
- **three-dimensional surface modelling** (e.g., construction of isoplethic maps with height proportional to disease incidence or other characteristics: *Figure 4.15*).

The ability of GIS to link graphic and non-graphic data facilitates powerful analysis of the spatial distribution of disease and related factors. These systems are being increasingly applied to animal disease control as integral parts of veterinary decision support systems (see Chapter 11). Some GIS applications are listed in *Table 4.11*, and the value of GIS and remote sensing are discussed by Hugh-Jones (1991a,b) and Hay *et al.* (2000). Paterson (1995) outlines some of the problems associated with the practical implementation of GIS in veterinary epidemiology – particularly for the new user.

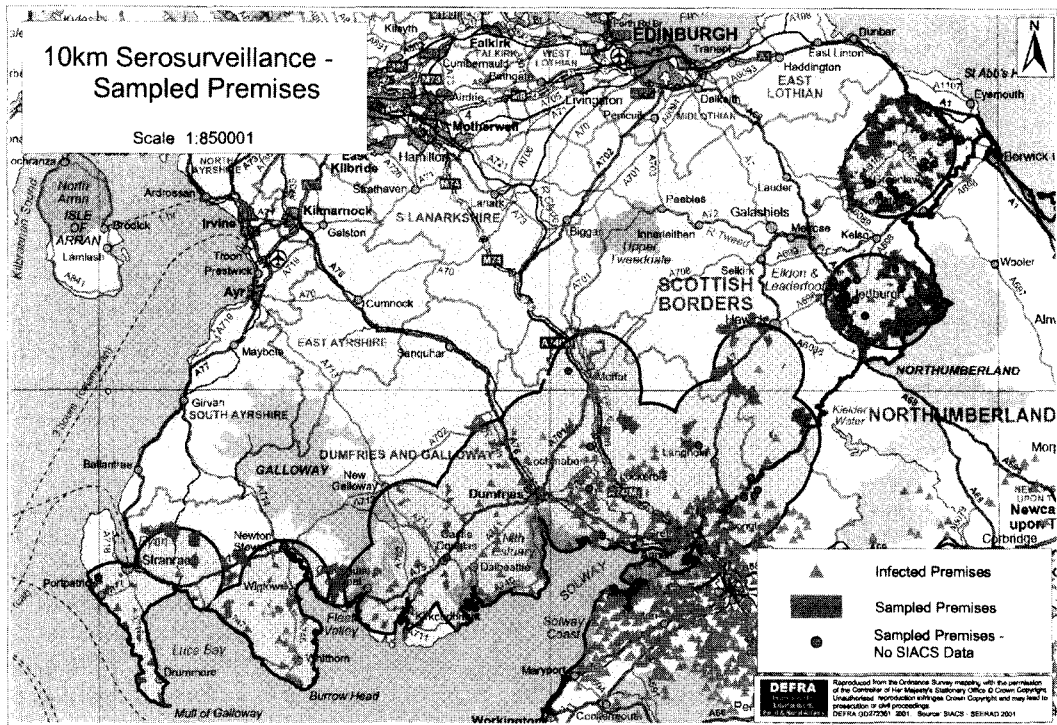

**Fig. 4.14** Identification of all small-ruminant holdings within a 10-km radius of premises with confirmed foot-and-mouth disease infection (the 'sampling frame'), preparatory to selecting a sample to demonstrate freedom from infection: an example of neighbourhood analysis using a GIS. Few stocked holdings were within a 3-km radius because of prior pre-emptive culling. (From Stringer and Thrusfield, 2001.)

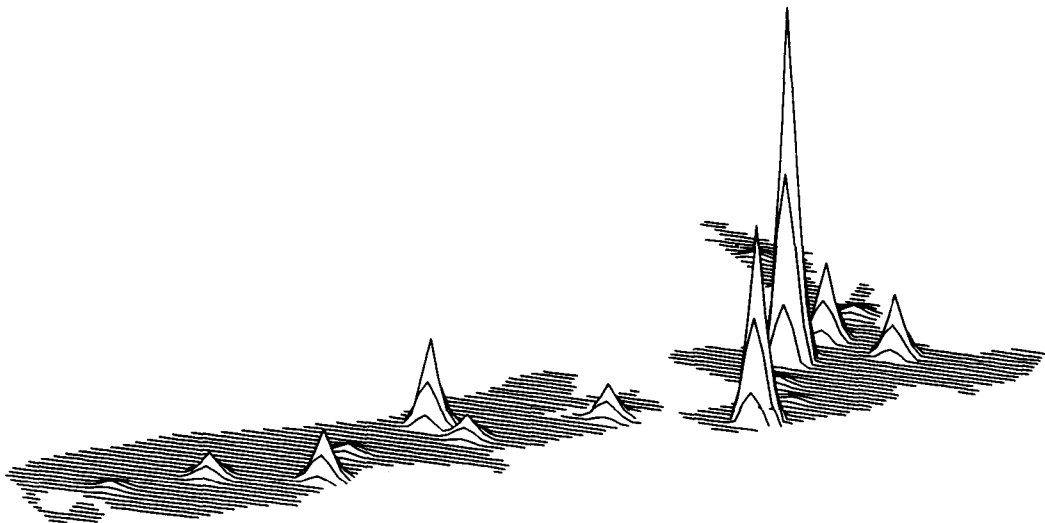

**Fig. 4.15** Spatial distribution of the number of tuberculin test reactors in cattle in New Zealand, 1988–89: an example of an isoplethic map generated by a geographical information system. The heights of the peaks represent numbers of tuberculin test reactors; the bases represent geographical areas of the country. (From *OIE Scientific and Technical Review*, 10(1), March 1991.)

**Table 4.11** Some applications of geographical information systems and remote sensing in veterinary and related fields.

Area of application	Country/continent	Source
Antibiotic resistance	US	Singer <i>et al.</i> (1998)
Aujeszky's disease	US Hungary	Marsh <i>et al.</i> (1991) Solymosi <i>et al.</i> (2004)
Bovine tuberculosis	Ireland New Zealand UK	Hammond and Lynch (1992) Sanson <i>et al.</i> (1991a) Clifton-Hadley (1993)
Blowfly strike	Australia	Ward and Armstrong (2000)
Canine cancer distribution	US	O'Brien <i>et al.</i> (1999)
<i>Corynebacterium pseudotuberculosis</i> infection (equine)	US	Doherr <i>et al.</i> (1999)
Disease control	Africa	Paterson <i>et al.</i> (2000)
Distribution of <i>Culicoides imicola</i> (vector of bluetongue)	Iberia Morocco Southern Africa Mediterranean Europe and North Africa	Rawlings <i>et al.</i> (1997) Baylis and Rawlings (1998) Baylis <i>et al.</i> (1999) Baylis <i>et al.</i> (2001) Tatem <i>et al.</i> (2003)
Dracunculiasis	West Africa	Clarke <i>et al.</i> (1991)
Equine motor neuron disease	US	De La Rúa-Domènech <i>et al.</i> (1995)
Echinococcosis	Germany	Staubach <i>et al.</i> (1998)
Fascioliasis	Ethiopia	Yilma and Malone (1998)
Foot-and-mouth disease	Brazil New Zealand Taiwan	Arámbulo and Astudillo (1991) Sanson <i>et al.</i> (1991b) Yamane <i>et al.</i> (1997)
Gastric cancer	UK	Matthews (1989)
Geographical referencing of farms	UK	Durr and Froggatt (2002)
Habitat of the snail <i>Fossaria bulimoides</i> (intermediate host of <i>Fasciola hepatica</i> )	US	Zukowski <i>et al.</i> (1991)
Handling epidemiological data	US	Campbell (1989)
Human population growth in relation to tsetse fly extinction	Africa	Reid <i>et al.</i> (2000)
Livestock production and health atlas	Global	Clements <i>et al.</i> (2002)
Mosquito population dynamics	US	Wood <i>et al.</i> (1991)
Prediction of outbreaks of <i>Oestrus ovis</i>	Namibia	Flasse <i>et al.</i> (1998)
Site selection for fish farming	Ghana	Kapetsky <i>et al.</i> (1991)
<i>Rickettsia conorii</i>	Italy	Mannelli <i>et al.</i> (2001)
Theileriosis	Africa	Lessard <i>et al.</i> (1988, 1990)
Tick habitats:		Hugh-Jones (1991c)
<i>Amblyomma variegatum</i>	St. Lucia Guadeloupe	Hugh-Jones and O'Neil (1986) Hugh-Jones <i>et al.</i> (1992)
Lyme disease tick distribution	US	Kitron <i>et al.</i> (1991)
<i>Rhipicephalus appendiculatus</i>	Czechoslovakia Africa	Daniel and Kolár (1990) Lessard <i>et al.</i> (1990) Perry <i>et al.</i> (1990) Randolph (1994)
Trypanosomiasis	Burkina Faso	Michel <i>et al.</i> (2002)
Tsetse fly control	Botswana	Allsopp (1998)
<i>Vibrio vulnificus</i> (model for cholera)	US	Hugh-Jones <i>et al.</i> (1996)
Wildlife disease management	Africa, New Zealand, UK	Pfeiffer and Hugh-Jones (2002)



### Further reading

- Clifton-Hadley, R.S. (1995) Geographic information systems and their use in animal disease research and control. *State Veterinary Journal*, **5** (4), 1–4
- Collett, D. (2000) *Modelling Survival Data in Medical Research*, 2nd edn. Chapman and Hall/CRC, Boca Raton. (*A comprehensive text on survival analysis*)
- Dawson-Saunders, B. and Trapp, R.G. (1990) *Basic and Clinical Biostatistics*. Appleton and Lange, East Norwalk
- Durr, P.A. and Gatrell, A.C. (Eds) (2004) *GIS and Spatial Analysis in Veterinary Science*. CABI Publishing, Wallingford
- Hay, S.I., Randolph, S.E. and Rogers, D.J. (2000) Remote sensing and geographical information systems in epidemiology. *Advances in Parasitology*, **47**, 1–351
- Hugh-Jones, M. (Ed.) (1991) Applications of remote sensing to epidemiology and parasitology. *Preventive Veterinary Medicine*, **11**, 159–366
- Last, J.M. (2001) *A Dictionary of Epidemiology*, 4th edn. Oxford University Press, New York
- Roht, L.H., Selwyn, B.J., Holguin, A.H. and Christensen, B. (1982) *Principles of Epidemiology. A Self-teaching Guide*. Academic Press, New York

# 5

## Determinants of disease

---

Chapter 3 introduced the concept that disease is caused by multiple factors. The factors are **determinants** of disease. A determinant is any characteristic that affects the health of a population. Diet, for example, is a determinant of bovine hypomagnesaemia: reduced food intake and low levels of plant magnesium, related to rapid grass growth, are associated with an increased incidence of the disease (*Figure 3.6*). Knowledge of determinants facilitates identification of categories of animal that are at particular risk of developing disease. It therefore is a prerequisite for disease prevention, and is an aid to differential diagnosis. This chapter discusses the types of determinant and the interactions that occur between them.

### Classification of determinants

Determinants can be classified in three ways, as:

1. **primary** and **secondary**;
2. **intrinsic** and **extrinsic**;
3. associated with **host**, **agent** or **environment**.

#### Primary and secondary determinants

Primary determinants are factors whose variations exert a major effect in inducing disease. Frequently, primary determinants are necessary causes (see Chapter 3). Thus, exposure to distemper virus is a primary determinant of canine distemper.

Secondary determinants correspond to predisposing, enabling and reinforcing factors. For example, sex is a secondary determinant of canine heart valve incompetence: male dogs are more likely to develop incompetence than females (Buchanan, 1977; Thrusfield *et al.*, 1985). The primary determinants may

include other genetically determined factors such as the rate of ageing of the valves, which may be associated with breed. Primary and secondary determinants are listed in *Table 5.1*.

#### Intrinsic and extrinsic determinants

*Table 5.1* also illustrates that some determinants (both primary and secondary) are internal to the host, for example, genetic constitution, including aberrant genes (which are the primary causes of genetic disorders), species, breed and sex. These determinants are **intrinsic**, also termed **endogenous** (Greek: *endon* = within). In contrast, some determinants are external to the host; for instance, transportation, which may result in physical trauma, producing bruising of carcasses (Jarvis and Cockram, 1994). Such determinants are **extrinsic**, also termed **exogenous** (Greek: *exo* = outside).

*Table 5.2* exemplifies this scheme of classification in relation to canine pruritus (tendency to itch), a common problem in small animal practice.

#### Determinants associated with host, agent and environment

Many diseases include infectious agents in their sufficient causes. Most infectious agents enter the host as challenges from the environment (see *Figure 2.1*), and, when fetal infection occurs, the dam can be the 'environment' too. However, during the microbial revolution, the early emphasis on microbes as the primary causes of disease resulted in their being considered separately from other environmental factors such as husbandry, trauma and toxic agents. Thus, determinants commonly are classified into those associated with the **host**, the **agent** and the **environment**. These three groups of factors are sometimes called the

**Table 5.1** Primary and secondary determinants.

PRIMARY DETERMINANTS <i>Intrinsic determinants</i>	<i>Extrinsic determinants</i>				
	<i>Animate</i>		<i>Inanimate</i>		
	<i>Endoparasitic</i>	<i>Ectoparasitic</i>	<i>Physical</i>	<i>Chemical</i>	<i>Allergic</i>
Genetic constitution	Viruses	Arthropods	Trauma	Excess	Allergens
Metabolism	Bacteria		Climate	Deficiency	
Behaviour	Fungi		Radiation	Imbalance	
	Protozoa		Stressors	Poisons	
	Metazoa			Photosensitizers	
SECONDARY DETERMINANTS <i>Intrinsic determinants</i>			<i>Extrinsic determinants</i>		
Genetic constitution (including sex, species and breed)			Location		
Age			Climate		
Size and conformation			Husbandry (housing, diet, general management, animal use)		
Hormonal status			Trauma		
Nutritional status			Concurrent disease		
Immunological status			Vaccination status		
Functional status (e.g. pregnant, lactating)			Stressors		
Behaviour					

**Table 5.2** Some determinants of canine pruritus. (Simplified from Logas, 2003; Mason, 1995.)

<i>Intrinsic determinants</i>		<i>Extrinsic determinants</i>				
<i>Host characteristics</i>	<i>Internal disease</i>	<i>Chemicals</i>	<i>Environment</i>	<i>Diet</i>	<i>Parasites</i>	<i>Bacteria, fungi and yeasts</i>
Breed	Neoplasia:	Irritant contact dermatitis	Solar dermatitis	Adverse food reactions	Hookworm dermatitis	Bacterial folliculitis
Age	mast cell tumour mycosis fungoides	Calcinosis cutis			<i>Pelodera</i> dermatitis	Deep pyoderma
	Immune-mediated disorders:				Schistosomiasis	Dermatophytosis
	systemic lupus erythematosus				Dirofilariasis	<i>Malassezia</i> dermatitis
	Hormonal hypersensitivity				Scabies	
					Pediculosis	
					Demodicosis	
					<i>Otodectes cyanotis</i>	
					Trombiculiasis	
					Cheyletiellosis	

**triad** (Figure 5.1). Some authors (e.g., Schwabe, 1984) consider that management and husbandry are important enough in intensive animal enterprises to be classified separately from the environment, as a fourth major group.

In some diseases, an infectious agent is the main determinant, and host and environmental factors are of relatively minor importance. Such diseases are 'simple'; examples are major animal plagues such as foot-and-mouth disease and rinderpest occurring in susceptible populations. A multifactorial nature is not obvious. In other diseases, termed 'complex', their multifactorial nature predominates and a clear **interaction** between host, agent and environment can be identified.

Thus, 'environmental' mastitis involves an interaction between *Escherichia coli* or *Streptococcus uberis* (the agent), milking machine faults, and poor environmental hygiene (Blowey and Edmondson, 1995). In addition, cows (the hosts) are most susceptible in early lactation. Similarly, it has been claimed that the binding of copper and manganese (trace elements found in the soil) to prion proteins may influence the pathogenesis of scrapie and other transmissible spongiform encephalopathies (Purdey, 2000).

The complexity of a multifactorial disease depends upon how the disease is defined. Most 'diseases' with which the veterinarian is initially concerned are actually clinical signs presented by animals' owners. Thus,

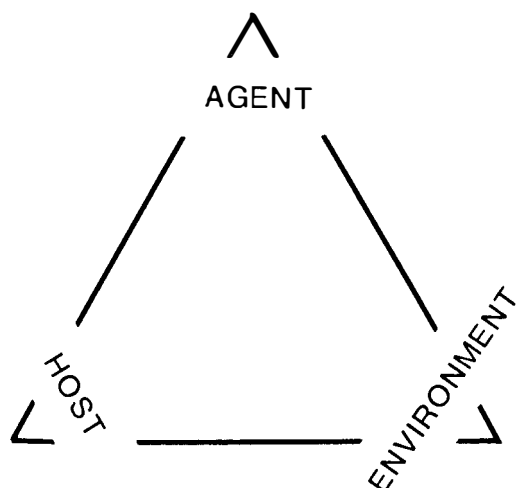

Fig. 5.1 The 'triad': three main headings under which determinants can be classified.

pruritus in a dog is a clinical sign, which can be caused by several different lesions each with their own sufficient causes. Further examples of signs and lesions with different causes are given in Figures 9.3b and 9.3c. The causal web can become very complex when the 'disease' is defined in terms of a production short-fall in a herd or flock. Thus, 'reproductive failure' in a pig herd, reflected in unacceptably low numbers of piglets being born in a herd in a defined period of time, can be produced by decreased male or female fertility, or infection or metabolic derangement of the sow or fetus during pregnancy. Figure 5.2 divides the causes of reproductive failure in pigs into six main areas relating to genetic constitution, nutrition, infections, toxic agents, environment and management; it therefore

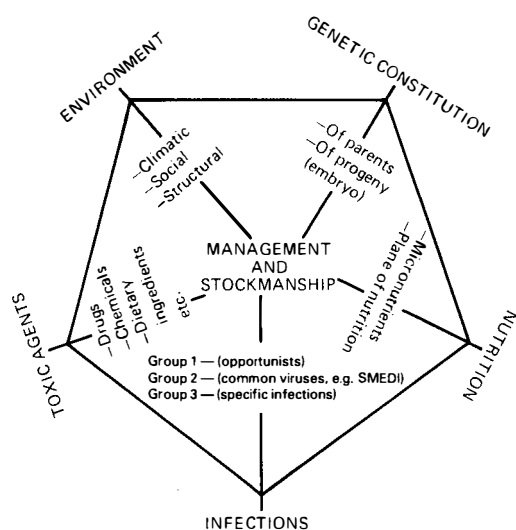

Fig. 5.2 Diagrammatic representation of causes of reproductive failure in a pig herd. (Modified from Pritchard *et al.*, 1985).

represents a subdivision of agent, host and environmental determinants. These six areas are discussed in detail by Wrathall (1975).

Genetic factors include genetic defects affecting the parents (e.g., abnormal genitalia or gametes) and the offspring (e.g., malformations and inherited predisposition to disease).

Failure to supply nutritional requirements for specific micronutrients (vitamins, minor minerals and trace elements) can result in reduced litter sizes, embryonic death and delayed puberty. The plane of nutrition can also affect performance. Restriction of diet can delay puberty. In contrast, 'flushing' (increasing the amount fed) a few days before ovulation is due can increase the number of ova released in gilts.

Infections are classified into three groups:

1. opportunistic pathogens;
2. common viruses;
3. specific infectious diseases.

Group 1 pathogens are ubiquitous and frequently endogenous. They cause disease sporadically when host resistance is lowered. Examples include *Staphylococcus* and *Listeria* spp. – infections causing prenatal deaths and abortions. Notable in group 2 are the porcine parvoviruses, also termed SMEDI viruses, an acronym for stillbirth, mummification, embryonic death and infertility, which effects they produce. Group 3 infections include brucellosis, leptospirosis, toxoplasmosis and swine fever – infections caused by exogenous pathogens, which can produce low conception rates and induce abortion.

Toxic substances include those ingested in the food (e.g., mycotoxins which can induce vulvovaginitis and abnormal oestrus), and environmental pollutants such as wood preservatives which can cause abortion.

The environment affects reproduction through its climatic, social and structural components. High environmental temperatures, for example, can induce infertility in males.

Important management factors include herd age (young females may have a low ovulation rate and therefore small litter size), the boar:sow ratio, boar management, efficiency of heat detection and pregnancy diagnosis, breeding policy and record keeping.

The three schemes of determinant classification are not mutually exclusive. They are just three different ways of viewing the multifactorial nature of disease. Determinants are described below using the third system of classification: into those associated with host, agent or environment. This system is also followed by Schwabe *et al.* (1977), Martin *et al.* (1987) and Smith (2005) in their discussion of determinants of animal diseases, and by Reif (1983) in his consideration of determinants of diseases of dogs and cats.

## Host determinants

### Genotype

The genetic constitution of a host is its **genotype**. Some diseases appear to have an almost totally genetic cause; that is, alterations in gene structure are considered to have a marked effect on their pathogenesis, and they may be inherited by succeeding generations; an example is haemophilia A and B in dogs. Such diseases, in which aberrant genes are primary determinants, are traditionally termed **genetic diseases**. Other diseases, such as the simple infectious diseases, appear to have little or no genetic component. Many diseases, however, occupy positions intermediate to these two extremes; examples are bovine foot lameness (Peterse and Antonisse, 1981) and mastitis (Wilton *et al.*, 1972).

Genetic diseases generally belong to one of three categories (Nicholas, 1987, 2003):

1. chromosomal disorders;
2. Mendelian (simply inherited) disorders<sup>1</sup>;
3. multifactorial disorders.

The first two categories represent diseases that are almost totally genetic. The third category represents diseases that have a variable, complex, genetic component. Such diseases have been reported to occur more commonly than those belonging to the first two categories; their mode of inheritance will therefore be discussed in more detail.

### Multifactorial inheritance

Many of the simply inherited disorders are qualitative, 'all-or-none' characteristics.

In contrast, other characteristics, such as muscle mass and the severity of some diseases (e.g., hip dysplasia: Morgan *et al.*, 2000), are quantitative, displaying continuous variation. The genetic component of this variation is explained by the cumulative (usually additive) effects of many genes at several sites (loci) on the chromosomes. This is **polygenic** inheritance. The polygenic component additionally interacts with environmental factors; thus, there is a **multifactorial** cause to such traits. For example, canine hip dysplasia requires both a genetic weakness to the muscles supporting the hip joint, and conditions in early life that favour separation of the joint, resulting in the osseous changes that characterize the disease. These changes can be prevented by confining to cages pups that have genetically weak muscles, with their hindlimbs flexed

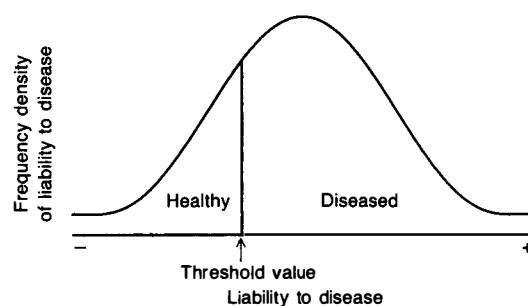

**Fig. 5.3** Genetic model for manifestation of a multifactorial disease. The disease occurs when the number and combination of genes, in association with environmental factors, exceeds the threshold value.

and abducted. The development of the condition is also exacerbated by excess energy consumption (Fries and Remedios, 1995). Thus, there is clearly a non-genetic component relating to management and nutrition early in life. The relative (but not exclusive) occurrence of hip dysplasia in different giant breeds, between which there is no genetic movement, supports the hypothesis that large, poorly muscled breeds (whose conformation is genetically determined) are particularly at risk. Furthermore, litter mates can be affected to different degrees, suggesting a polygenic cause.

Some disorders, such as congenital heart defects, do not show continuous variation, but liability to the condition nevertheless can be interpreted as having a polygenic component. An individual can inherit the 'right' number and combination of genes, and be exposed to environmental determinants, to pass beyond a **threshold value**, beyond which the disease occurs (Falconer and Mackay, 1996). *Figure 5.3* illustrates this concept. The horizontal axis is the 'liability to disease', '+' indicating the presence of many, and '-' of few, of the right genes and environmental factors. The vertical axis is the relative frequency of values of liability to disease in the population. The congenital heart defect, patent ductus arteriosus, for example, is inherited multifactorially, and is discussed in more detail in Chapter 18 in the context of comparative epidemiology.

The likelihood of a relative inheriting the right combination of causal genes becomes less as a relationship becomes more distant. The likelihood of the right number and combination of genes being inherited also decreases as the number of genes required for manifestation of the disorder increases.

Initially, simple and polygenic modes of inheritance appeared to be mutually exclusive. However, it is now clear that the additive effects of many genes, inherited in a Mendelian manner, can be applied to the polygenic model for continuous traits. Conversely, a single-gene model can be applied to quantitative traits by converting the trait to a dichotomy, with an animal characterized as to whether its trait value is above or

<sup>1</sup> Developments in molecular biology, however, have resulted in a reassessment of the classical Mendelian modes of inheritance (Zlotogora, 1998).

below a threshold value. Moreover, liability to disease can be applied to simple, single-gene traits where environmental factors have an effect (e.g., human phenylketonuria).

Although it is currently believed that many common diseases have a genetic component, it is unclear whether this amounts to a multifactorial (polygenic) predisposition or to the involvement of a single major chromosomal locus interacting with environmental factors. It is also difficult to infer a genetic component to the cause of a disease in the absence of data relating to genetically distinct groups (breeds, families, and sire and dam lines).

Foley *et al.* (1979) describe heritable diseases of companion animals and livestock in detail, and Ackerman (1999) specifically addresses conditions in dogs. Identification of putative genes, or ones that map closely to them ('linked markers'), is an important component of the control of inherited disorders (see Chapter 22).

## Age

The occurrence of many diseases shows a distinct association with age. Many bacterial and virus diseases, for instance, are more likely to occur, and to be fatal, in young than in old animals, either because of an absence of acquired immunity or because of a low non-immunological host resistance. Many protozoan and rickettsial infections, in contrast, induce milder responses in the young than in the old.

The absolute number of cases of a disease clearly is not an indication of the impact of disease in a particular age range because the ranges are present in different proportions in the total population. This is illustrated in *Figure 5.4*, which depicts **population pyramids** for dogs and cats. These show the age distribution of animals (male and female indicated separately). Thus, age-specific rates (see Chapter 4) provide the most valuable information about disease in particular age groups, because they relate morbidity and mortality to a uniform size of population at risk. *Figure 5.5* displays age-specific rates for canine neoplasia and shows that tumours are more common in old than in young animals. (There are some notable exceptions such as canine osteosarcoma and lymphosarcoma which show peak incidences between 7 and 10 years of age: Reif, 1983.)

## Sex

Sexual differences in disease occurrence may be attributed to hormonal, occupational, social and ethological, and genetic determinants.

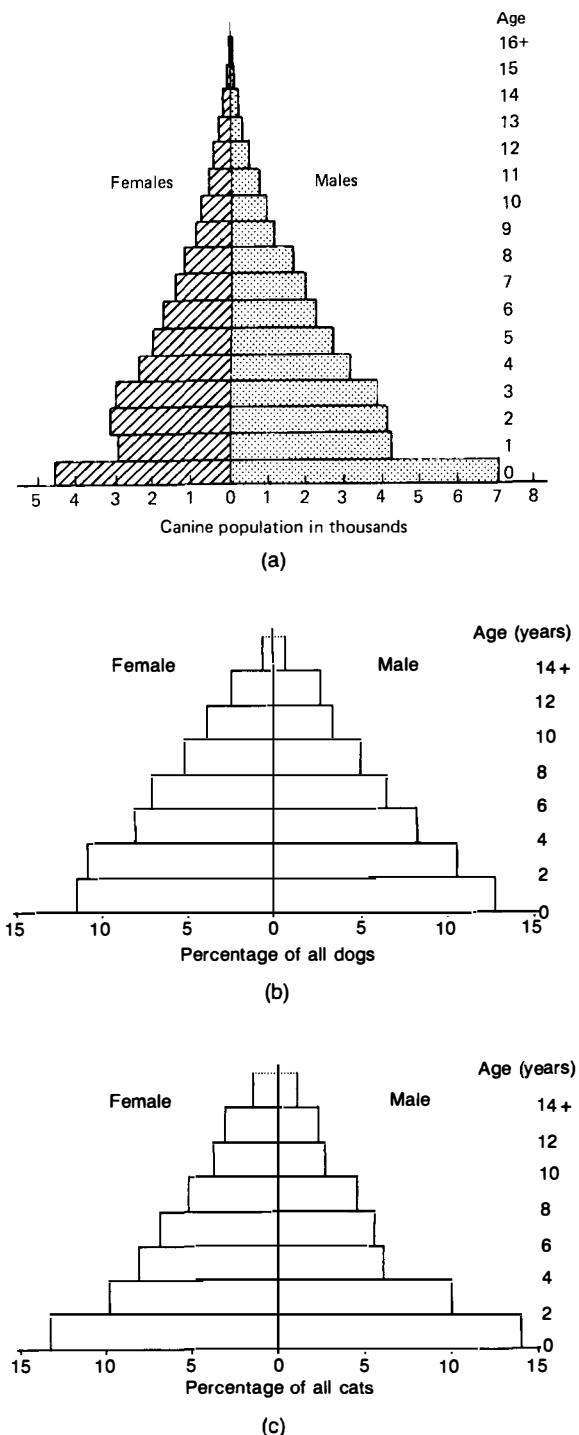

**Fig. 5.4** Canine and feline population pyramids. (a) Canine: New Jersey, USA, 1957; (b) canine: UK, 1986; (c) feline: UK, 1986. ((a) From Cohen *et al.*, 1959; (b) and (c) from Thrusfield, 1989.)

## Hormonal determinants

The effects of sex hormones may predispose animals to disease. Bitches are more likely to develop diabetes mellitus than dogs (Marmor *et al.*, 1982) and signs often develop after oestrus, possibly related to the

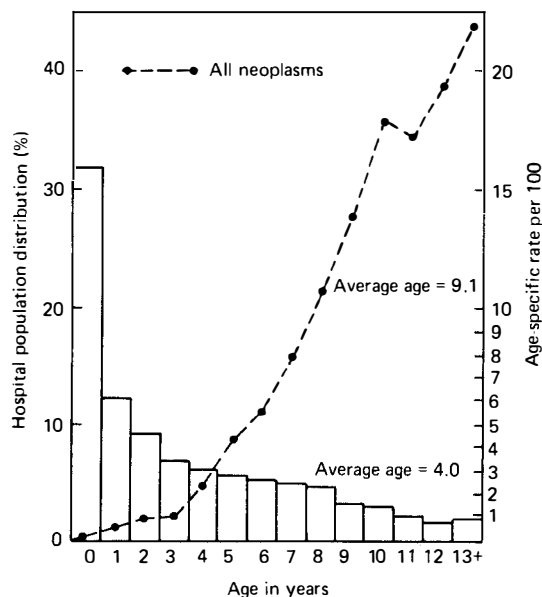

**Fig. 5.5** Age distribution of a total canine hospital population (bars) and age-specific rates (graph) for canine neoplasia: University of Pennsylvania, 1952–1964. (From Reif, 1983.)

increased insulin requirements of diabetic bitches during oestrus. Similarly, the neutering of bitches decreases the likelihood of mammary carcinoma developing (Schneider *et al.*, 1969), perhaps from the effect of oestrogens on this tumour (see Chapter 18).

### Occupational determinants

Sex-associated occupational hazards, although more relevant to human than animal disease, can be identified occasionally in animals, where animal use is equated with occupation. Thus, the increased risk of contracting heartworm infection by male dogs relative to bitches (Selby *et al.*, 1980) may result from increased 'occupational' exposure of male dogs during hunting to the mosquito that transmits the infection.

### Social and ethological determinants

Behavioural patterns may account for bite wound abscesses being more common in male than female cats. Behaviour can also affect the likelihood of transmission of infection from one species to another. Thus, in New Zealand, opossums stand their ground when confronted by cattle, thereby increasing the chance of aerosol transmission (see Chapter 6) of tuberculosis from infected opossums to cattle by inhalation. In contrast, in the UK, badgers' immediate response to threatening behaviour is to retreat, and so aerosol transmission of tuberculosis from infected badgers is less likely (Benham and Broom, 1989).

### Genetic determinants

Genetic differences in disease incidence may be inherited either by being **sex-linked**, **sex-limited**, or **sex-influenced**. Sex-linked inheritance is commonly associated with Mendelian inheritance, and occurs when the DNA responsible for a disease is carried on either the X or Y sex chromosomes. Canine haemophilia A and B, for example, are associated with the X chromosome and are inherited recessively, the defects being predominant in males (Patterson and Medway, 1966). Sex-limited inheritance occurs when the DNA responsible for the disease is not in the sex chromosomes, but the disease is expressed only in one sex, for example cryptorchidism in dogs. In sex-influenced inheritance, the threshold for the overt expression of a characteristic (based on the multifactorial genetic model: Figure 5.3) is lower in one sex than the other, therefore, there is an excess incidence in one sex over the other. Canine patent ductus arteriosus (see Chapter 18) may be an example.

In many diseases, there may be excess disease occurrence in one sex over the other, but either a genetic component has not been identified clearly or the method of inheritance has not been established. Examples that are reported to occur predominantly in male dogs include epilepsy (Bielfelt *et al.*, 1971), melanoma and pharyngeal fibrosarcoma (Cohen *et al.*, 1964).

Some diseases may be apparently sex-associated, but are actually associated with other determinants that are related to gender. For instance (Schwabe *et al.*, 1977), the increased mortality rate in male dairy calves may appear to be sex-associated. However, the real association is with husbandry: male dairy calves may not be given as much attention as females because they are worth less (in this instance husbandry, therefore, is a confounder: see Chapter 3).

### Species and breed

Species and breeds vary in their susceptibility and responses to different infectious agents, and therefore in the role they play in disease transmission. Dogs, for example, do not develop heartwater. Pigs are harder to infect with foot-and-mouth disease virus via the respiratory tract than cattle and sheep (Sellers, 1971; Donaldson and Alexandersen, 2001). Thus, cattle are the species most likely to be infected by between-farm spread of airborne virus, because of their extreme susceptibility to airborne infection and higher respiratory tidal volume (Donaldson *et al.*, 1982; Donaldson, 1987). Pigs are not only less susceptible to airborne virus but also, because of their lower tidal volume and the practice of housing them indoors, are less likely to

encounter sufficient virus to initiate clinical disease. In contrast, if infection does occur, pigs excrete vast quantities of airborne virus (one pig being equivalent to 3000 cattle) and so are important sources of airborne virus during epidemics because they are often kept in large numbers. (See also Chapter 6.)

Rottweilers and Dobermann Pinschers react more severely to canine parvovirus enteritis than other breeds (Glickman *et al.*, 1985), and boxers appear to be more susceptible than other breeds to mycotic diseases, such as coccidioidomycosis (Maddy, 1958) (for a distribution map of the fungus see Figure 7.2). Different breeds of poultry vary in their susceptibility to a range of viruses (Bumstead, 1998; Hassan *et al.*, 2004).

The reasons for species susceptibility are many and not fully understood. The efficacy of the immune mechanism against an infectious agent may be important. Thus, humans are not usually susceptible to infection with *Babesia* spp. but splenectomized individuals can develop the disease. Different species have been shown to have different receptors for infectious agents on the cell surface. This is particularly important with viruses, which must enter the host cell. Monkeys are not susceptible to poliovirus because they do not have the 'right' cell receptors. Removal of the virus capsid allows the virus to divide lytically in monkey cells if it is first made to enter them. Susceptibility can vary within a species, too. Thus, only certain pigs are susceptible to the strain of *Escherichia coli* possessing the K88 antigen because susceptibility is determined by the presence of an intestinal receptor that is specified by one or more genes (Vögeli *et al.*, 1992).

Phylogenetically closely related animals are likely to be susceptible to infection by the same agent, albeit with different signs. Herpesvirus B causes labial vesicular lesions in non-human primates, but fatal encephalitis in man. The rider to this – that phylogenetically closely related agents infect the same species of animal – is not, however, generally true. Measles, distemper and rinderpest are closely related paramyxoviruses, yet usually infect quite different species: man, dogs and cattle, respectively.

Apparently new diseases can develop when a species or breed is placed in a new ecosystem (see Chapter 7) that contains a pathogen that has a well balanced relationship with local species or breeds. In such circumstances inapparent infection (discussed later in this chapter) is common in the local animals but clinical disease occurs in the exotic ones. This happened in South Africa, when European breeds of sheep were exposed to bluetongue virus. The agent did not produce clinical signs in the indigenous sheep, but caused severe disease in imported Merino sheep. Similarly, malaria developed as a clinical disease in early European visitors to West Africa, whereas

the local population was tolerant of the parasite. Resistance to the tick *Boophilus microplus* is greater in indigenous Zebu cattle (*Bos indicus*) than in European cattle (*Bos taurus*) (Brossard, 1998), and the importation of European cattle to West Africa also accentuated the problem of dermatophilosis.

There is also species and breed variation in the occurrence of non-infectious diseases. Thus, British breeds of sheep develop intestinal carcinoma more frequently than fine wool breeds, Hereford cattle develop ocular squamous cell carcinoma more commonly than other breeds (see Chapter 4), and there is considerable variation in canine and feline breed predisposition to skin tumours (Goldschmidt and Schofer, 1994).

Many diseases having distinct associations with a particular familial line or breed are considered to be primarily genetic (Ubbink *et al.*, 1998b). Patterson (1980) has described over 100 such diseases in the dog. A genetic causal component is more likely when disease incidence is higher in pedigree animals than in crossbreeds. Examples include congenital cardiovascular defects (Patterson, 1968) and valvular heart disease (Thrusfield *et al.*, 1985) in dogs.

Diseases may be present in a range of breeds, because the breeds are genetically related. Boston terriers and bull terriers show a high risk of developing mastocytoma, which may be related to their common origin (Peters, 1969). In contrast, the risk of a particular breed developing a disease may vary between countries, indicating different genetic 'pools' (or a different environment or method of management). Thus, Das and Tashjian (1965) found an increased risk of developing valvular heart disease in cocker spaniels in North America, whereas, in Scotland, Thrusfield *et al.* (1985) did not detect an increased risk in that breed. In contrast, valvular heart disease is commoner in cavalier King Charles spaniels in Scotland (Thrusfield *et al.*, 1985) than in Australia (Malik *et al.*, 1992). Gough and Thomas (2003) document breed dispositions to diseases in dogs and cats.

## Other host determinants

### Size and conformation

Size, independent of particular breed associations, has been identified as a disease determinant. Hip dysplasia and osteosarcoma are more common in large than small breeds of dog (Tjalma, 1966). Interestingly, the latter disease is also more common in large than small children (Fraumeni, 1967). The conformation of animals may similarly increase the risk of some diseases. For instance, cows with a small pelvic outlet relative to their size (e.g., Chianina and Belgian blue) are predisposed to dystokia. Conformation may also



have less direct effects. Thus, some calves cannot suckle their dams because the latter have large, bulbous teats (Logan *et al.*, 1974). This can result in the calves being hypogammaglobulinaemic, with the increased risk of fatal colibacillosis.

### Coat colour

Predisposition to some diseases is associated with coat colour, which is heritable and a risk indicator. For example, white cats have a high risk of developing cutaneous squamous cell carcinoma (Dorn *et al.*, 1971) related to the lack of pigment, which protects the skin from the carcinogenic effects of the sun's ultraviolet radiation. In contrast, canine melanomas occur mainly in deeply pigmented animals (Brodey, 1970). White cats often have a genetic defect associated with deafness (Bergsma and Brown, 1971). White hair colour is also associated with congenital deafness in Dalmatians (Anderson *et al.*, 1968).

## Agent determinants

### Virulence and pathogenicity

Infectious agents vary in their ability to infect and to induce disease in animals<sup>2</sup>. The ability to infect is related to the inherent susceptibility of a host and whether or not the host is immune. The ability to induce disease is expressed in terms of **virulence** and **pathogenicity**. Virulence is the ability of an infectious agent to cause disease, in a **particular** host, in terms of **severity**<sup>3</sup>. It is also sometimes expressed quantitatively as the ratio of the number of clinical cases to the number of animals infected (Last, 2001). Case fatality (see Chapter 4) is an indicator of virulence when death is the only outcome. Pathogenicity is sometimes incorrectly used as a synonym for virulence, with virulence reserved for variations in the disease-inducing potential of different strains of the same organism. However, 'pathogenicity' refers to the quality of disease induction (Stedman, 1989). Thus, the protozoan parasite *Naegleria fowleri* is pathogenic to man in warm, but not in cold, water, pathogenicity being governed in this instance by environment. Pathogenicity also may be quantified as the ratio of the number of individuals developing clinical illness to the number exposed to infection (Last, 2001).

<sup>2</sup> This is also true for plant pathogens (Mills *et al.*, 1995).

<sup>3</sup> The conventional wisdom is that parasites evolve into less virulent forms because, in killing their hosts, lethal parasites appear to 'commit suicide'. However, recent evidence (Ebert and Mangin, 1995) suggests that parasite evolution involves a subtle balance between virulence and transmission rate.

Pathogenicity and virulence are commonly intrinsic characteristics of an infectious agent and are either **phenotypically** or **genotypically** conditioned. Phenotypic changes are transient, and are lost in succeeding generations. For example, Newcastle disease virus, cultivated in the chorioallantois of hens' eggs, is more virulent to chicks than virus that is cultivated in calf kidney cells. Genotypic changes result from a change in the DNA (and RNA, in RNA viruses) of the microbial genome (the agent's total genetic complement). Most pathogenic bacteria express their virulence genes only when they are inside the host; the conditions in the host somehow facilitating expression of these genes.

Pathogenicity and virulence are determined by a variety of host and agent characteristics. Bacterial virulence and pathogenicity are determined by a relatively small group of factors ('common themes'), including toxin and adhesin production, and common themes for invasion of the host and resistance to the clearance and defence mechanisms of the host (Finlay and Falkow, 1997). An agent may achieve pathogenicity, or increase virulence, by a change in antigenic composition to a type to which the host is not genetically or immunologically resistant. However antigenic changes are not always the cause of changes in pathogenicity. They may simply be indicators of such changes, the determinants being associated with the production of inhibitory, toxic or other substances (e.g., exotoxins and endotoxins) and the immune-mediated damage that may ensue (Biberstein, 1999). Genotypic changes also can alter the sensitivity of bacteria to antibiotics.

### Types of genotypic change

Various genotypic changes can occur in infectious agents (Table 5.3). Major ones include **mutation**, **recombination**, **conjugation**, **transduction** and **transformation**.

Mutation is an alteration in the sequence of nucleic acids in the genome of a cell or virus particle. There may be either **point mutation** of one base, resulting in misreading of succeeding codon triplets, or **deletion mutation**, where whole segments of genome are removed. Deletion mutants are more likely to occur because they result in changes without redundant genetic material. Frequent mutation may produce antigenic diversity, which may induce recurrent outbreaks of disease in a population that is not immune to the new antigen. Within the same organism, mutation rates can vary for different genetic markers by a factor of 1000. Sites within the genome that frequently mutate are termed 'hot spots'. If these spots code for virulence determinants and antigens in the infectious agent, then the agent can change virulence and

**Table 5.3** Potential sources of genetic variability in bacterial and virus populations. (Modified from *Trends in Ecology and Evolution*, 10, Schrag, S.J. and Wiener, P. Emerging infectious diseases: what are the relative roles of ecology and evolution?, 319–324 © (1995), with permission from Elsevier.)

Bacteria	Viruses
<p><b>Mutation:</b> Mutation rate is approximately <math>10^{-9}</math>–<math>10^{-6}</math> per base pair. Point mutations, deletions, insertions and inversions can lead to significant changes in virulence factors (e.g., adhesion ability, toxin production). Antigenic drift can allow bacterial pathogens to 'hide' from mammalian immune systems.</p> <p><b>Transposition:</b> Transposons are segments of DNA that can be integrated into new sites on the same or different DNA molecules from their origin; conjugative transposons are elements that can promote their own transfer from one bacterial cell to another.</p> <p><b>Transformation:</b> Uptake and integration into bacterial chromosome of exogenous DNA.</p> <p><b>Plasmid exchange:</b> Transfer of plasmids between bacterial cells.</p> <p><b>Conjugation:</b> Plasmid-mediated chromosome transfer between bacterial cells.</p> <p><b>Lysogeny:</b> Incorporation of phage genes into bacterial genome via phage integration (e.g., <i>Escherichia coli</i> 0157).</p> <p><b>Transduction:</b> Phage-mediated transfer of small portions of bacterial DNA.</p>	<p><b>Mutation:</b> RNA viruses have significantly higher mutation rates than DNA viruses or bacteria, because of the greater instability of RNA molecules and the higher error rates of RNA replication enzymes. Point mutations can generate rapid antigenic variation.</p> <p><b>Recombination between viruses:</b> Intraspecific and interspecific recombination has been observed in some RNA and DNA viruses.</p> <p><b>Recombination with host genes:</b> Recombination can occur in DNA viruses that integrate into host chromosomes or in the DNA provirus step of retrovirus replication. If the host chromosome has previously incorporated pieces of virus DNA, recombination can result in the integration of both host and virus genes into virus genetic material.</p> <p><b>Reassortment of virus segments:</b> In RNA viruses with segmented genomes (e.g., influenza viruses) reassortment of segments among progeny rapidly leads to high levels of genetic variability within populations.</p>

antigens frequently. If mutation occurs at sites that are not associated with either virulence or antigenic type, then changes in these two characteristics are rare. Sometimes only one or two mutations is sufficient to convert a relatively harmless bacterium or virus into a highly virulent form (Rosqvist *et al.*, 1988).

The switch from virulence to non-virulence – which is reversible – is sometimes termed **phase variation**. This can occur with a high frequency; approximately 1 in  $10^6$  in *Bordetella pertussis* (the cause of whooping cough in children), for example. The phase variation is manifested in changes in colonial characteristics, and similar changes occur in *Bordetella bronchiseptica*, the cause of canine 'kennel cough', (Thrusfield, 1992), in which infections may range from the clinically inapparent to the overt (Bemis *et al.*, 1977; McKiernan *et al.*, 1984; and see below 'Gradient of infection').

Recombination is the reassortment of segments of a genome that occurs when two microbes exchange genetic material. Thus, influenza A viruses have a genome that is packaged in each virion (virus particle) as eight strands of RNA. Influenza viruses are divided into groups based on the structure of two major antigens: the haemagglutinin and neuraminidase (see also Table 17.6). Reassortment between current human and avian strains of the virus (possibly in pigs) is likely to

produce recombinants with novel haemagglutinin and neuraminidase combinations (Webster *et al.*, 1992). Major changes are referred to as 'shift' and minor changes as 'drift'. The major changes are responsible for the periodic – approximately decadal – pandemics of influenza in man (Kaplan, 1982; Webster, 1993). (Note that antigenic drift also occurs in trypanosomes, but by a totally different mechanism. The superficial cell membrane is shed to reveal new antigens<sup>4</sup>. The epidemiological result, though, is similar: new antigens, therefore a partially or totally susceptible population.) Recombination may also occur in the orbiviruses (e.g., African horse sickness and blue-tongue) where the precise mechanism is not known, and the term 'genetic reassortment' has been applied (Gorman *et al.*, 1979).

<sup>4</sup> African trypanosomes can spend a long time in the blood of their mammalian host, where they are exposed to the immune system and are thought to take advantage of it to modulate their own numbers. Their major immunogenic protein is the variant surface glycoprotein (VSG). Trypanosomes escape antibody-mediated destruction through periodic changes of the expressed VSG gene from a repertoire of 1000 genes (Barry and McCulloch, 2001; Gibson, 2001; Vanhamme *et al.*, 2001; Barry and Carrington, 2004).

Conjugation (Clewell, 1993) involves transmission of genetic material – usually in the form of a **plasmid**<sup>5</sup> – from one bacterium to another, by a conjugal mechanism (i.e., they touch) through a sex pilus<sup>6</sup>. The greatest practical effect of conjugation is in conferring resistance to antibiotics in both ‘established’ and emerging and re-emerging pathogens (McCormick, 1998); for example, gentamycin resistance in *Staphylococcus* spp. (Schaberg *et al.*, 1985), which may pose a particular problem in nosocomial infections<sup>7</sup>. Conjugally mediated drug resistance may therefore be an important determinant of the effectiveness of therapy when infections occur, and there is increasing evidence that some antibiotic-resistant strains of zoonotic bacteria have evolved in farm livestock (Fey *et al.*, 2000; Willems *et al.*, 2000)<sup>8</sup>. Conjugation occurs in many bacteria, including *Bordetella bronchiseptica*, *E. coli*, and *Clostridium*, *Pasteurella*, *Proteus*, *Salmonella*, *Shigella* and *Streptococcus* spp.

Transduction (Snyder and Champness, 1997) is the transfer of a small portion of genome from one bacterium to another, ‘accidentally’, by a bacterial virus (bacteriophage)<sup>9</sup>. Again, resistance factors, as well as surface antigens, may be transferred in this way. It occurs in *Shigella*, *Pseudomonas* and *Proteus* spp.

Transformation (Snyder and Champness, 1997) involves release of DNA from one bacterial cell and then its entry into another cell of the same bacterial species. It occurs spontaneously in *Neisseria* spp. but, to occur in other bacterial species, DNA has to be extracted in the laboratory. (This type of transformation should not be confused with the *in vitro* production of malignant cells, which is also called transformation.)

In addition to these five methods of genetic alteration, infection by more than one type of virus particle may be necessary to produce disease. Such infections do not strictly involve a change in a virus genome, rather a complementation of it, which may render a non-pathogenic virus particle pathogenic. This occurs in some plant virus infections because several plant viruses have split genomes that are packaged in

separate particles. Each particle carries a portion of the total genome which is, itself, non-infectious, but which contributes to the whole infectious unit. For example, tobacco rattle virus has two virions: one containing a promoting gene, and the other containing replication and maturation genes. All three genes, and therefore both types of virion, are necessary to instigate the successful infection of a tobacco plant. In animals, Rous sarcoma virus has capsid proteins that are genetically determined by a separate helper virus. Similarly, some adeno-associated viruses require an adenovirus for infectivity. The different particles present in human hepatitis B fall into this double infection group too.

Infection with immunosuppressive viruses can exacerbate other infections (e.g., rinderpest infection aggravates haemoprotozoan infections). Conversely, infection by one virus may prevent infection by, or lessen the virulence of, a second virus. This occurs when the first virus induces the host’s cells to release an inhibitory substance now known as interferon.

The ways in which virulence and pathogenicity affect the transmission and maintenance of infection are discussed in Chapter 6.

### Genotypic variability and microbial taxonomy

Initially, classification of microbes was based on physical and chemical properties; for example, buoyant density and susceptibility to heat inactivation to define genera of the virus family, Picornaviridae, which includes the foot-and-mouth disease virus species. Subsequently, nucleotide sequencing and other microbial characteristics have been used to classify microbes in a manner that may reflect, more accurately, variation in pathogenicity and virulence. Thus, foot-and-mouth disease virus occurs as seven **serotypes** – A, O, C, Southern African Territories (SAT) 1, SAT 2, SAT 3, and Asia 1 – defined by the inability of infection or vaccination to confer immunity against other serotypes. Substantial genetically determined antigenic variation exists within each serotype (particularly types A and O), and is associated with varying virulence<sup>10</sup>.

The genetic variation in microbes may also provide valuable clues to the origin of epidemics. The type O foot-and-mouth disease viruses, for instance, exhibit genetically and geographically distinct evolutionary lineages (**topotypes**) (Samuel and Knowles, 2001). Using a 15% nucleotide-sequence difference as the upper limit defining a single topotype, eight topotypes of type O have been identified: European/South American (Euro-SA), Middle East/South Asia (ME-SA), South East Asia (SEA), Cathay, East Africa (EA),

<sup>5</sup> Plasmids are small, autonomously replicating molecules in bacterial cells.

<sup>6</sup> Plasmids also can be transferred non-conjugally (Storrs *et al.*, 1988).

<sup>7</sup> Nosocomial infections are those that are acquired in hospitals or clinics (Greek: ‘nosokomeian’ = hospital). In human and (probably) veterinary hospitals, the most common are those of the urinary tract, followed by pneumonias, surgical site infections, and bacteraemias (Emori and Gaynes, 1993; Greene, 1998b).

<sup>8</sup> There is also evidence that the process is reversible, when in-feed antibiotics are subsequently banned (Ferber, 2002).

<sup>9</sup> There are two types of transduction: **generalized** and **specialized**. In the former, any region of the bacterial DNA can be transferred; whereas, in the latter, only certain genes close to the phage’s attachment site on the bacterial chromosome can be transferred.

<sup>10</sup> The variation is so substantial that each isolate may be unique (Clavijo and Kitching, 2003).

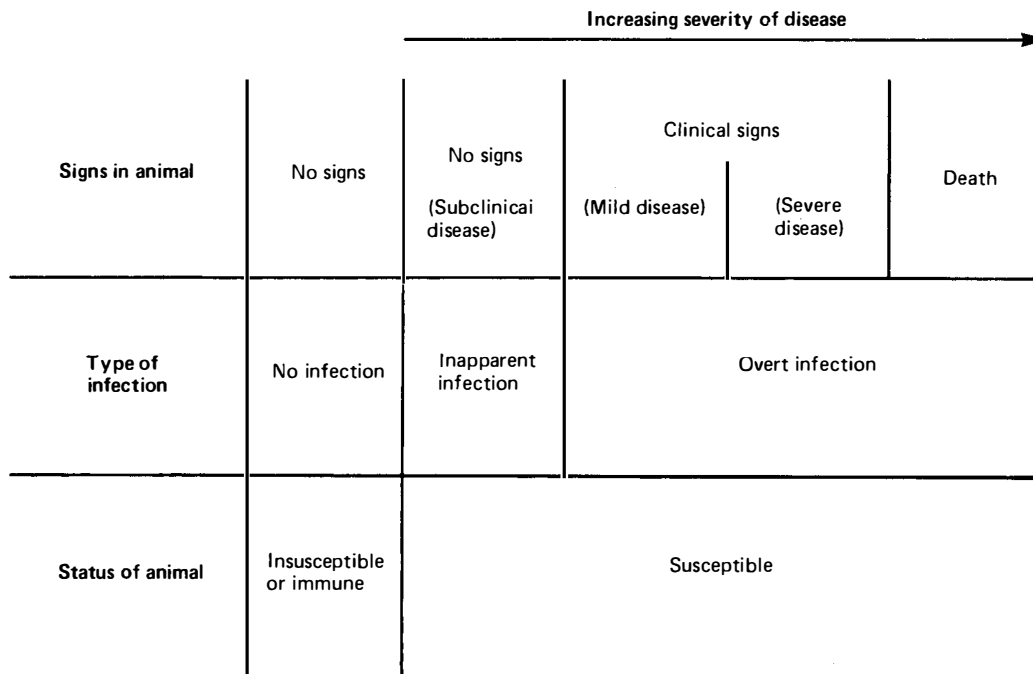

**Fig. 5.6** Gradient of infection: the various responses of an animal to challenge by an infectious agent.

West Africa (WA), Indonesia 1 (ISA-1) and Indonesia 2 (ISA-2). The 2001 epidemic in the UK was caused by the PanAsia strain, a genetic sublineage of the ME-SA toptotype, which emerged in India in 1990 before spreading throughout Asia and into the Middle East, South Africa and southern Europe (Kitching, 1998). Identification of this strain therefore supported the hypothesis that meat, illegally imported from the Far East, may have been the source of the epidemic (DEFRA, 2002b).

## Gradient of infection

'Gradient of infection' refers to the variety of responses of an animal to challenge by an infectious agent (Figure 5.6) and therefore represents the combined effect of an agent's pathogenicity and virulence, and host characteristics such as susceptibility and pathological and clinical reactions. These responses affect the further availability of the agent to other susceptible animals, and the ability of the veterinarian to detect, and therefore to treat and control, the infection. If an animal is either insusceptible or immune, then infection and significant replication and shedding of an agent do not usually occur and the animal is not important in the transmission of infection to others.

### Inapparent (silent) infection

This is infection of a susceptible host without clinical signs<sup>11</sup>. The infection may run a similar course to that

which produces a clinical case, with replication and shedding of agent. The inapparently infected animal poses a considerable problem to the disease controller because it is impossible to detect without auxiliary diagnostic aids such as antigen detection or serology. For example, sheep may show either no or transient clinical signs of infection with foot-and-mouth disease virus (Kitching and Hughes, 2002), although they may excrete virus (Sharma, 1978). Demonstration of infection by serology is therefore recommended in this species (Donaldson, 2000).

**Subclinical** infection occurs without overt clinical signs. Some authors use this term and inapparent infection synonymously. Others ascribe a loss of productivity to subclinical infection, which is absent from inapparent infection. 'Subclinical' can also be applied to non-infectious conditions, such as hypomagnesaemia, where there may be no clinical signs.

### Clinical infection

Clinical infection produces clinical signs. Disease may be **mild**. If the disease is very mild with an illness too indefinite to permit a clinical diagnosis, then it is termed an **abortive reaction**. Thus, the spectrum of response to foot-and-mouth disease virus infection in sheep may result in only mild signs of foot-and-mouth

<sup>11</sup> Some authorities use the term 'unapparent' synonymously (e.g., Suttmoller and Olascoaga, 2002).

disease (Bolton, 1968; Kitching and Hughes, 2002), leading to difficulty in unequivocal diagnosis (Ayres *et al.*, 2001; De la Rua *et al.*, 2001). Laboratory diagnosis is therefore prudent (and probably necessary) to confirm a diagnosis in this species, and to avoid misclassifying unaffected sheep as affected<sup>12</sup>.

There is a gradation to severe disease, which is called a **frank clinical reaction**, when the intensity is sufficient to allow a clinical diagnosis. The spectrum of response to foot-and-mouth disease virus infection in sheep may therefore also include clear clinical signs, often associated with times of stress such as parturition (Brown, 2002; Reid, 2002; Tyson, 2002).

The severest reaction results in death. Paradoxically, death is the logical climax of some infections because it is the only means by which the agent can be released to infect other animals. An example is infection with *Trichinella spiralis*, which is transmitted exclusively by flesh eating.

Inapparent and mild clinical infections may indicate an adaptation of some antiquity between host and parasite; the relationship between bluetongue virus and indigenous South African sheep has already been cited.

## Outcome of infection

Clinical disease may result in the development of a long-standing chronic clinical infection, recovery, or death. Chronically infected cases are potential sources of an infectious agent. Death usually removes an animal as a source of infection, although there are important exceptions such as infection with *T. spiralis*, and anthrax infection where carcasses contaminate the soil. Recovery may result in **sterile immunity** following an effective host response, which removes all of the infectious agent from the body. Animals that have sterile immunity no longer constitute a threat to the susceptible population.

Two states, however, are important determinants:

1. the carrier state;
2. latent infection.

### The carrier state

'Carrier' is used loosely to describe several situations. In a broad sense, a carrier is any animal that sheds an infectious agent without demonstrating clinical signs. Thus, an inapparently or subclinically infected animal may be a carrier, and may shed agent, either continu-

ously or intermittently. The periods for which animals are carriers vary. They are rarely lifelong, but carriers may be important sources of infection to susceptible animals during these periods.

**Incubatory carriers** are animals that excrete agent during the disease's incubation period. For instance, dogs usually shed rabies virus in their saliva for up to 5 days before clinical signs of rabies develop (Fox, 1958), and periods as long as 14 days have been reported (Fekadu and Baer, 1980). Thus, in countries in which rabies is endemic, the World Health Organization recommends that dogs and cats that have bitten a person should be confined for 10 days; this protocol is designed to determine if the bitten person was exposed to rabies virus.

**Convalescent carriers** are animals that shed agent when they are recovering from a disease, and the agent may then persist for prolonged periods.

**The carrier state in foot-and-mouth disease** A carrier of foot-and-mouth disease virus is precisely defined as an animal from which the virus can be isolated from oropharyngeal fluid samples, collected by probang, for periods greater than 28 days after virus challenge (Salt, 1994). It occurs in cattle and sheep following clinical and subclinical disease, the latter commonly following challenge with low titres of virus, and in cattle with partial immunity (Sutmoller *et al.*, 1968), such circumstances occurring in areas in which the disease is endemic. Persistence also may occur in vaccinated cattle that are subsequently challenged. The oropharynx is the primary site of replication of virus in cattle, whereas, in sheep, virus is most frequently isolated from the tonsillar region. However, virus titres are low, and decline, falling below the level considered necessary for transmission (Donaldson and Kitching, 1989).

The duration of the carrier state varies between species, with sheep and goats carrying foot-and-mouth disease virus for up to 9 months, cattle for up to 3 years, and the African buffalo for at least 5 years; whereas pigs do not act as carriers. The frequency of development of the carrier state in nature also appears to be species-related. Thus, up to 50% of cattle have been recorded as carriers for 6 months following epidemics (Sutmoller and Gaggero, 1965), whereas the carrier state in sheep and goats has been rarely reported naturally (Anderson *et al.*, 1976; Hancock and Prado, 1993; Donaldson, 2000).

Although virus-laden oropharyngeal fluid from carrier animals can infect cattle and pigs experimentally (van Bekkum, 1973), many experiments have failed to demonstrate transmission from carrier animals to in-contact susceptible animals (Davies, 2002; Sutmoller and Olascoaga, 2002). Similarly, there is a paucity of evidence that carriers can transmit infection in

<sup>12</sup> This is particularly important if animals incorrectly classified as diseased on clinical examination alone ('false-positives': see Chapter 17) are subject to mandatory slaughter.

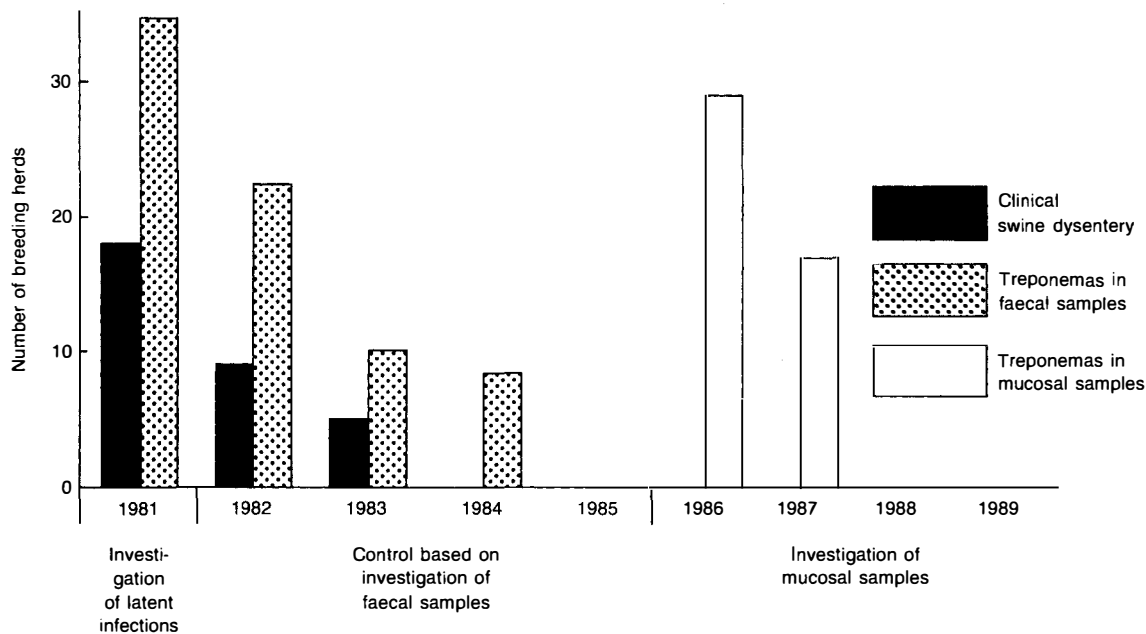

Fig. 5.7 Control and eradication of swine dysentery: Thuringia, Germany, 1981–89. (Modified from Blaha, 1992.)

the field, relating largely to African buffalo infected with SAT serotypes, and circumstantial evidence of transmission from carrier domesticated livestock in outbreaks in Zimbabwe due to the SAT2 serotype (Thomson, 1996).

Collectively, this information suggests that although the carrier state may be a clearly identified phenomenon, its role as a determinant of transmission and maintenance of infection during epidemics is uncertain.

### Latent infection

A latent infection is one that persists in an animal, and in which there are no overt clinical signs. Thus, the distinction between latency, chronic infection and the carrier state is blurred. Latency may or may not be accompanied by transmission to other susceptible animals. In persistent bacterial infections (e.g., tuberculosis), a balance occurs between host and agent such that the agent replicates, but the disease may not progress for a long time. In virus and rickettsial infections, persistence is not usually associated with demonstrable replication of the agent unless the latter is reactivated. Many examples of virus and rickettsial latency are known, but the role of latency in perpetuating infection in a population, except in a minority of infections such as bovine virus diarrhoea virus infection (Lindberg, 2003), is still unclear.

The likelihood of persistence can depend not only on the particular infectious agent and host species but also on the host's age at the time of infection. For

instance, all kittens transplacentally infected with feline leukaemia virus become permanently infected (Jarrett, 1985). However, from 8 weeks of age, an increasing proportion of cats resist infection: by 4–6 months of age only about 15% of naturally infected cats become permanently infected. Latently infected cats do not appear to transmit infection (except possibly female cats to their kittens, in milk).

Unidentified latent infections can be obstacles to the control of disease. For example, the bacterium *Brachyspira* (previously *Serpulina*, *Treponema*) *hyodysenteriae*, the cause of swine dysentery, can latently infect pigs. Attempts to control swine dysentery in the Thuringia region of Germany in the 1960s and 1970s were unsuccessful because only pigs in clinically affected herds were treated, and the infection was maintained in latently infected animals. However, when latently infected herds were identified by examining faecal samples for presence of the bacterium, and control measures were instituted in these herds, the disease declined (Figure 5.7). Pathogen-free status was subsequently monitored by examination of mucosal scrapings from the colon.

### Microbial colonization of hosts

Infectious agents enter a host at varying times during its life. Some – the vertically transmitted ones (see Chapter 6) – infect the host before birth. Initial infection may or may not be followed by the immediate development of disease.

### Exogenous and endogenous pathogens

The previous description of microbes involved with reproductive failure in pigs illustrates that pathogenic infectious agents can be classified into two groups: **exogenous** and **endogenous** (Dubos, 1965).

The exogenous pathogens are not usually present in the host. They cannot normally survive for a long time in the external environment (soil, water, etc.). They do not usually form persistent relationships with the host. They are generally acquired by exposure to an infected animal, and usually produce disease with clearly identifiable clinical signs and pathological lesions. Examples include canine distemper, rinderpest, and the other traditional animal plagues.

The endogenous pathogens are often found in healthy animals, commonly in the gastrointestinal and respiratory tracts, and usually do not cause disease unless the host is stressed. An example is *E. coli*, which is commonly found in the intestinal tract of calves, and which may cause disease only when a calf is immunodeficient, for example due to deprivation of colostrum (Isaacson *et al.*, 1978).

This twofold classification is somewhat simplistic. Some pathogens possess characteristics of both groups. For example, *Salmonella* spp. usually produce distinct clinical signs when they infect animals. However, some animals can permanently carry and intermittently excrete the agent without showing signs, as carriers. The bacterium can also be transmitted by methods other than direct contact with infected animals, for example in contaminated food.

### Opportunistic pathogens

Some organisms cause disease only in a host whose resistance is lowered; for example by drug therapy and other diseases. Such organisms are **opportunistic**, may colonize the host at any time during life, and may be endogenous or exogenous. Examples described earlier are the group 1 pathogens that can cause prenatal deaths and abortions in pigs.

### Environmental determinants

The environment includes location, climate and husbandry. Particular attention has been paid to environmental determinants of disease in livestock enterprises, where intensive production systems expose animals to unnatural environments (e.g., chicken battery houses), and in human medicine, where social and occupational exposure to possible causal factors (e.g., to smoke in relation to lung cancer: *Table 3.2*) can occur. Moreover, the health and welfare of captive wild

animals may also be affected by their environment (Kirkwood, 2003).

### Location

Local geological formations, vegetation and climate affect the spatial distribution of both animals and disease. Thus, the incidence of jaw tumours in sheep, mentioned in Chapter 4, is associated with the distribution of bracken, and illustrates the value of maps in identifying causes of disease. Non-specific chronic canine pulmonary disease in middle-aged and old dogs has been shown to be associated with urban residence in the US (Reif and Cohen, 1970); urban residence being defined in relation to atmospheric pollution (see Chapter 18). This investigation has been refined by demonstrating an urban/rural gradient in the occurrence of canine pulmonary disease (Reif and Cohen, 1979): an example of the application of the method of concomitant variation (see Chapter 3) in inferring cause. The effects of proximity of livestock to oil and natural-gas sites are equivocal (Waldner *et al.*, 2001a,b; Scott *et al.*, 2003a,b).

Noise is associated with location and may also be considered as being related to 'occupation' and husbandry. The impact of noise on human health has been investigated extensively (Kryter, 1985; Butler *et al.*, 1999), but its effect on animal health has not been studied in detail. Most investigations have been conducted on man and laboratory animals where, apart from the obvious induction of temporary or permanent deafness, noise has been shown to cause a general stress reaction (discussed later in this chapter) with altered secretion of adrenocortical hormones. In a review of the effects of noise on animal health, Algers *et al.* (1978) describe leucopenia (which could be associated with immunosuppression), decreased milk production in dairy cows, and oligospermia and an increased incidence of abortion in rats. Studies in horses suggest that impulse noises (sonic booms) have no effect on animal health or behaviour (Ewbank and Cullinan, 1984).

The temporal distribution of disease is also affected by location because of the seasonal effects of climate. These effects, and methods of identifying them, are discussed in Chapter 8.

### Climate

Two types of climate can be identified: **macroclimate** and **microclimate**.

#### Macroclimate

The macroclimate comprises the normal components

of weather to which animals are exposed: rainfall, temperature, solar radiation, humidity and wind, all of which can affect health (Webster, 1981). Temperature may be a primary determinant, for example low temperatures in the induction of hypothermia, to which newborn animals are particularly prone. Wind and rain increase heat loss from animals. Cold stress predisposes animals to disease, for example by reducing efficiency of digestion, which may predispose to infectious enteritis. Wind also can carry infectious agents (e.g., foot-and-mouth disease virus) and arthropod vectors (e.g. *Culicoides* spp. infected with bluetongue virus) over long distances (see Chapter 6).

Solar radiation can act as a primary determinant: the carcinogenic effect of solar ultraviolet radiation has already been mentioned in relation to cutaneous squamous cell carcinoma. It is also an important component of the sufficient cause of infectious bovine keratoconjunctivitis, in which the primary determinant is infection with *Moraxella bovis* (Hughes *et al.*, 1965), the ultraviolet radiation 'loosening' the corneal epithelium, thereby facilitating colonization of the cornea by the bacterium (George, 1993). The bacterium alone only produces mild clinical signs; the classical disease only occurs when high levels of ultraviolet radiation are present. The disease therefore tends to be seasonal, occurring most frequently during summer, and occasionally in winter, when ultraviolet radiation is reflected from fresh snow (Hubbert and Hermann, 1970). Current stratospheric ozone depletion, with the associated increase in ultraviolet radiation, may therefore cause an increase in the incidence of this and other diseases, including Ueberreiter's syndrome (chronic superficial keratoconjunctivitis) in dogs, and cataracts and skin lesions in farmed fish (Mayer, 1992).

The macroclimate can also affect the stability of infectious agents, in which circumstance it is a secondary determinant. Bovine rhinotracheitis virus survives well when humidity is low, whereas rhinoviruses survive when it is high. Porcine transmissible gastroenteritis virus is sensitive to solar ultraviolet radiation, and therefore is more likely to be inactivated in summer than winter. The statistical association between respiratory disease and cool damp weather conditions is probably due to a build-up of pathogens, rather than a reduction in host resistance by climatic stress (Webster, 1981).

Drought can have mixed effects. The one in England and Wales in the summer of 1976, for example, was associated not only with decreased milk yield and weight gain in cattle, and an increase in the prevalence of warble fly infestation in sheep, but also with a beneficial reduction in levels of fascioliasis and parasitic bronchitis (SVS, 1982).

Climatic variation can also induce changes in disease occurrence over vast distances. For example,

the epidemic of Rift Valley fever that occurred in East Africa in 1997–98 was the result of an increase in the size of the mosquito vector population following increased rainfall stemming from the El Niño phenomenon<sup>13</sup> (Brown and Bolin, 2000).

Climatic impact can be measured in several ways. A common method is to calculate the **wind-chill index**. This combines the effects of temperature and wind-speed, and is especially important at temperatures below freezing, where convective heat losses are magnified by wind. The **standard environmental temperature** (McArthur, 1991) relates the effects of temperature, wind-speed and humidity, and can take values considerably below or above actual air temperature.

The macroclimate, in conjunction with geological features, determines vegetation and affects the spatial distribution of disease because of the resultant distribution of hosts and vectors; this is discussed in Chapter 7. Macroclimatic changes may therefore alter the frequency and distribution of many diseases, and it has been speculated that global warming, resulting from an increase in the 'greenhouse effect' caused by the high industrial output of carbon dioxide emissions, may be an important determinant during this century (Aitken, 1993). For example, if there is a mean rise in temperature of 2–4°C in Europe over this period, the growing season in the UK would be extended and the rainfall pattern would alter. Extension of the grazing season could increase the incidence of bovine hypomagnesaemia (see *Figure 3.6*) and selenium and cobalt deficiency in lambs. A concomitant change to 'softer' grazing with more lush pasture could also lead to an increase in dental problems in sheep.

The distribution of biological vectors may also alter, resulting in changes in vector-transmitted diseases; for example, louping-ill, Lyme disease and tick-borne fever could become more common as the pattern of activity of the agents' vector, the tick *Ixodes ricinus*, shifted. Moreover, the patterns of parasitic diseases such as fascioliasis, nematodiriasis and haemonchosis could also be modified because of the importance of temperature in the development of the parasites' stages in the environment and cold-blooded intermediate hosts. Similarly, *Culicoides imicola*, the vector of bluetongue, appears to be extending its range northwards and westwards; and it is possible that other species of *Culicoides* might become competent vectors of the virus (DEFRA, 2002d).

Patz *et al.* (1996, 2000), McMichael and Haines (1997), Patz and Lindsay (1999), Kiska (2000), Wittmann and Baylis (2000), Epstein (2001), McCarthy *et al.* (2001), Alitzer *et al.* (2002) and Hunter (2003) discuss the broad

<sup>13</sup> El Niño is a disruption of the oceanic-atmospheric system in the tropical Pacific (Philander, 1990).



**Table 5.4** Occupational exposure limits of gases and dust in livestock buildings. (Modified from Wathes, 1994.)

	Human occupational exposure limits		Animal exposure limits (maximum continuous)
	Long-term (8-h time-weighted average)	Short-term (10 min)	
<i>Gases (ppm)</i>			
Ammonia, NH <sub>3</sub>	25	35	20
Carbon dioxide, CO <sub>2</sub>	5 000	15 000	3 000
Carbon monoxide, CO	50	300	10
Formaldehyde, HCHO	20	30	–
Hydrogen sulphide, H <sub>2</sub> S	10	15	0.5
Methane, CH <sub>4</sub>	Asphyxiant	–	–
Nitrogen dioxide, NO <sub>2</sub>	3	5	–
<i>Dusts (mg m<sup>-3</sup>)</i>			
Grain dust*			
Total inhalable fraction	10	–	–
Non-specific dust			
Total inhalable fraction	10	–	3.4 <sup>†</sup>
Respirable fraction	5	–	1.7 <sup>†</sup>

\* Maximum exposure time.

<sup>†</sup> 24-h time-weighted average.

implications of climate change for the distribution of infectious diseases and vectors.

### Microclimate

A microclimate is a climate that occurs in a small, defined space. This may be as small as within a few millimetres of a plant's or an animal's surface or as large as a piggery or calf house. In the former, microclimate may be **terrestrial** (e.g., over the surface of leaves) or **biological** (e.g., over the surface of a host's body). The terrestrial microclimate affects the development of arthropods and helminths. The biological microclimate can change during the course of a disease, assisting in its spread. For instance, sweating during the parasitaemic phase of human malaria increases the humidity of the body's surface and attracts more mosquitoes to the humid skin surface at a time when the protozoon is readily available.

The microclimate in intensive animal production units is an important determinant of disease. Stable dust is associated with respiratory hypersensitivity and non-allergic pulmonary disease, and can act as a vehicle for microorganisms (Collins and Algers, 1986). High levels of ammonia are associated with keratoconjunctivitis in hens (Charles and Payne, 1966) and turbinate atrophy in pigs (Drummond *et al.*, 1981). Poor ventilation is associated with chronic equine respiratory disease (Clarke, 1987). Therefore, adequate ventilation is recommended to remove stale air, microbial aerosols and dust, and to reduce humidity (Wathes *et al.*, 1983; Wathes, 1989), and exposure limits

for dust and gases, for both humans and animals in livestock buildings, have been suggested (Table 5.4). Although the effects of high concentrations of non-pathogenic airborne bacteria on livestock are unclear, there is evidence (Pritchard *et al.*, 1981) that reduced levels of airborne bacteria are associated with a reduced incidence of clinical and subclinical respiratory disease.

Domestic microclimates may also be determinants. High levels of household humidity, for example, are related to increased levels of canine mite allergens (Randall *et al.*, 2003).

### Husbandry

#### Housing

The importance of well designed ventilation in an animal house has already been mentioned. The structure of bedding materials and surfaces is also a determinant. Thus, claw lesions are more common and severe in pigs reared on aluminium slats than in pigs reared on steel or concrete slabs, or on soil (Fritschen, 1979). Limb lesions are more common in pigs reared on concrete than on asphalt-based floors (Kovacs and Beer, 1979); and hoof lesions and vulva biting (associated with aggression) are common problems in group-housed sows (Kroneman *et al.*, 1993). Smith (1981) suggests that excessive floor slope may predispose to rectal prolapse in pigs because of the increased effect of gravity.

## Diet

Diet has obvious effects in diseases caused by energy, protein, vitamin and mineral deficiencies. Sometimes the effects are less clearly defined. There is evidence, for example, that increased dietary levels of biotin reduce the incidence of foot lesions in sows (Penny *et al.*, 1980). However, there is no evidence of an association between a deficiency of the vitamin and an increased incidence of the lesions.

Feeding regimes may be a determinant. Thus, gastric torsion in sows kept in sow stalls has been associated with once-a-day rather than twice-a-day feeding, which may indicate that the ingestion of a relatively large amount of food is a causal factor (Crossman, 1978).

## Management (including animal use)

Management determines stocking density and production policy. Increased densities increase the challenge of microbial pathogens. An internal replacement policy (i.e., maintaining a 'closed' population: see Chapter 4) is less likely to introduce pathogens into an enterprise than a policy involving buying in animals from outside the herd.

The use to which an animal is put (its 'occupation') can affect disease occurrence. Equine limb injuries are relatively common in hunters. 'Hump-sore' ('yoke gall') occurs more frequently in draught zebus than in non-working cattle. Apparently sex-related differences in disease occurrence, which are actually related to animal use, have been described earlier.

## Stress

No general theory of stress has been universally accepted (Moberg, 1985; Moberg and Mench, 2000), and there has been conflict and confusion over interpretation of the related physiological responses (Becker, 1987). In human medicine, it is used to describe emotional conflicts and displeasure. In veterinary medicine, it is often considered as arising from factors such as weaning, overcrowding, transportation, changes in diet and other environmental factors. However, in such circumstances, stress may just be a convenient term to describe an area of interest or particular conditions of management, and may mask understanding of underlying principles and mechanisms (Rushen, 1986). A similar vagueness may also be demonstrated in human medicine (Stansfield, 2002).

Stress was initially considered in relation to the physiological 'flight or fight' reaction (Cannon, 1914). Factors such as physical exertion and fear stimulate

secretion of catecholamines by the adrenal medulla. These in turn assist muscular exercise by redistributing blood to the muscles, enabling animals to respond by either 'flight' or 'fight'.

A more comprehensive theory of stress was formulated by Selye (1946), who described the effects of noxious stimuli (e.g., cold, heat, immobilization and severe infections) in laboratory animals. These stimuli were called **stressors**, and their effects were later collectively termed the **general adaptation syndrome**. This was divided into three parts:

1. general alarm reaction;
2. phase of resistance (phase of adaptation);
3. phase of reaction.

Initial responses included a decrease in the size of the liver, lymph nodes, spleen and thymus, and the development of erosions in the digestive tract. The phase of resistance began after approximately 48 hours, and included adrenal enlargement. If this was unsuccessful in dealing with the stimuli, death could occur in the final stage.

Selye argued that there was a similar, that is, **non-specific**, response to all stressors, which always involved adrenal activity (e.g., increased secretion of cortisol into the circulation). However, later studies (Mason *et al.*, 1968) demonstrated that the adrenal response is closely related to psychological stimuli, and that it does not occur when some stressors (e.g., fasting) are applied in the absence of psychological stressors. This resulted in the rejection of a non-specific stress response (Mason, 1971). Consequently, the particular stimulus responsible for an observed reaction should be identified; this is particularly important in practical situations (e.g., transportation) where several stimuli are involved. Changes in variables such as plasma cortisol are found in response to a variety of psychological stimuli; some of these may be considered aversive, whereas others may be considered pleasurable. The changes in biological function in response to a stressor can be sufficient to remove the threat. However, when the response is prolonged and extensive, some aspects of biological function may be affected, leaving the animal vulnerable to detrimental effects; for example, endocrine events vital for reproductive success may be disrupted, immune function may be altered, resulting in susceptibility to infectious disease, and abnormal behaviour may develop (Moberg, 1985).

There is large variation in how animals respond to stressors. One individual may respond to some stimuli, whereas others may not, and some animals, compared with other animals, may show a completely different type of response to the same stressor. Factors such as experience, genetics and 'coping style' will

affect whether or not an animal perceives a stimulus as a stressor, and the type of biological response initiated by the animal in response to the stimulus (Moberg, 1985).

Evidence for the role of stress as a determinant of disease has usually been in the context of particular conditions of management, rather than in relation to a well understood, unequivocal physiological response. It is in the former context that stress is now discussed.

Stress can be a primary determinant. A notable example is when stress results from the capture of animals, where it can produce a **postcapture myopathy syndrome**. This syndrome is reported in wild animals in South Africa (Basson and Hofmeyer, 1973). It is characterized by ataxia, paresis or paralysis, the production of brown urine, and asymmetric muscular and myocardial lesions. A similar disease occurs in red deer following capture (McCallum, 1985).

Stress is also a primary determinant of the **porcine stress syndrome**. This is the inability of susceptible pigs to tolerate the usual environmental stressors (e.g., castration, vaccination, movement and high ambient temperatures) that are associated with normal management. The syndrome occurs rapidly – often within minutes – after exposure to a stressor. The disease, which is considered to be identical to malignant (fulminant) hyperthermia in humans, dogs, cats, horses and pigs, is characterized initially by muscle and tail tremors. Further stress can produce dyspnoea, cyanosis, increased body temperature and acidosis. The final stage is marked by total collapse, muscle rigidity, hyperthermia and death. The condition is a genetically determined error of metabolism, which induces a switch of energy utilization in muscles of affected pigs from aerobic to anaerobic metabolism. It is inherited through an autosomal recessive gene with high or complete penetrance. Susceptible pigs can be detected by the rapid development of malignant hyperthermia under halothane anaesthesia, and by certain blood-group-linked genes (Archibald and Imlah, 1985).

Stress may be a secondary determinant of several diseases. The immune system can be suppressed by stressors (Dohms and Metz, 1991). Although the significance of such immunosuppression in predisposing animals to infectious disease is unclear, epidemiological studies have provided evidence that it is functionally relevant. Thus, shipping fever (see Chapter 1) is associated with transportation, dehorning, castration and winter weather, and the increased incidence of malignant catarrhal fever and yersiniosis in deer in winter may be due to prolonged exposure to cold and a low plane of nutrition.

## Interaction

Determinants associated with host, agent or environment do not exert their effects in isolation, but **interact** to induce disease. 'Interaction' refers to the interdependent operation of factors to produce (or prevent) an effect (Last, 2001). Thus, factors that result in net decreased magnesium intake interact with those that induce net increased loss to produce hypomagnesaemia (see *Figure 3.6*). Nutritional intake of protein and gastrointestinal parasitism interact because the parasitism induces protein deficiency by increasing the demands for amino acids in the alimentary tract; this, in turn, affects the development and maintenance of immunity, which is sensitive to protein supply (Sykes and Coop, 2001). Bovine alimentary papillomas, caused by a papilloma virus (the agent), can transform to carcinomas in areas where bracken fern (the environment) is common, indicating an interaction between agent and environment (Jarrett, 1980). There is an interaction between a gene (the host) and stressors (the environment), which induces the porcine stress syndrome.

### Diseases caused by mixed agents

An important example of interaction between agents is the **mixed infection**, that is, an infection with more than one type of agent. The main infectious disease problems in intensive production systems relate to the body surfaces. Common problems are enteric and respiratory diseases and mastitis. These diseases are frequently caused by mixed infections. Two categories of diseases can be identified (Rutter, 1982):

1. diseases in which clinical signs can be reproduced by single agents independently, although mixed infections usually occur in animals;
2. diseases in which two or more microbial components are necessary to induce disease.

Some examples are listed in *Table 5.5*. Category I agents include *E. coli*, rotaviruses, caliciviruses, and *Cryptosporidium* spp., all of which can induce diarrhoea. Category II agents are exemplified by those that cause calf pneumonia, which include five viruses, four mycoplasmata and 19 bacterial species. The precise mechanism of the interaction is unclear, but investigations in mice (Jakab, 1977) suggest that pulmonary phagocytosis of bacteria may be reduced by virus inhibition of intracellular killing mechanisms in macrophages, and that increased bacterial adherence to virus-infected cells may increase.

Similarly, respiratory disease in calves is often associated with mixed infections with *Mannheimia* (*Pasteurella*) spp., bovine respiratory syncytial virus, parainfluenza-3 virus, and bovine virus diarrhoea

**Table 5.5** Examples of diseases caused by mixed infections. (Modified and expanded from Rutter, 1982.)

Disease	Classification*	Agents
Enteric disease (most species)	I (?II)	Enterotoxigenic <i>Escherichia coli</i> Rotavirus Coronavirus Calicivirus <i>Cryptosporidium</i> spp.
Respiratory disease (calves)	I	<i>Mannheimia (Pasteurella)</i> spp. Bovine respiratory syncytial virus Parainfluenza-3 virus Bovine virus diarrhoea virus
Atrophic rhinitis (pigs)	I	<i>Bordetella bronchiseptica</i> <i>Pasteurella multocida</i>
Foot-rot (sheep)	II	<i>Corynebacterium pyogenes</i> <i>Fusobacterium necrophorum</i> <i>Dichelobacter nodosus</i> Motile fusobacteria
Pneumonia (sheep)	II	Parainfluenza-3 <i>Mannheimia (Pasteurella) haemolytica</i>
Swine dysentery (pigs)	II	<i>Treponema hydysenteriae</i> Gut anaerobes
'Coli septicaemia' (chickens)	II	<i>Escherichia coli</i> Infectious bronchitis virus
Respiratory disease (bovine)	?II	<i>Mycoplasma bovis</i> <i>Mycoplasma dispar</i> Parainfluenza-3 Respiratory syncytial virus Infectious bovine rhinotracheitis virus <i>Pasteurella</i> spp. Other bacteria
Summer mastitis (bovine)	?II	<i>Corynebacterium pyogenes</i> <i>Peptococcus indolicus</i> <i>Streptococcus dysgalactiae</i> Micro-aerophilic cocci

\* I = Single agents can reproduce clinical signs but mixed infections frequently occur

II = Mixed infections are essential with cooperative or synergistic interactions

? = Insufficient evidence for definitive classification

virus (Fulton *et al.*, 2000). Although the first two viruses can induce respiratory disease when acting individually, bovine virus diarrhoea virus interacts with them and *Mannheimia* spp. through its immunosuppressive effect (Yates, 1982; also see Figure 3.5).

Foot-rot in sheep also demonstrates interaction. There are four component organisms: *Corynebacterium pyogenes*, *Fusobacterium necrophorum*, *Bacteroides nodosus* and non-pathogenic motile fusobacteria. Each of these four alone is only poorly virulent but supplies growth factors or substances that overcome the host's defence mechanisms in the complete infection (Roberts, 1969).

Other examples of interactions demonstrated experimentally include intestinal coccidiosis in chickens, which may predispose to necrotic enteritis with the associated proliferation of *Clostridium perfringens*

(Shane *et al.*, 1985), and haemorrhagic enteritis virus infection of turkey poults which increases their susceptibility to colibacillosis (Larsen *et al.*, 1985). A full discussion of microbial interactions is presented by Woolcock (1991).

In addition to this general concept of interaction, two specific meanings are attached to interaction, defining **biological** and **statistical** interaction, both of which have been tentatively redacted (Rothman and Greenland, 1998).

### Biological interaction

Biological interaction involves dependence between two factors based on an underlying physical or chemical

association and reaction – also therefore termed ‘mechanical interaction’ (Rothman and Greenland, 1998). For instance, there is a chemical interaction between the K88 antigen of *E. coli* (the agent) and receptors in the intestines of some pigs (the host), described earlier in this chapter, which results in the bacteria that possess the antigen being pathogenic to pigs with the receptors. There appears to be a physical interaction, also mentioned earlier, between the presence of bacteria and poor ventilation in the induction of calf respiratory disease, associated with the density of airborne bacteria. Biological interaction similarly is demonstrated by category II mixed agents. Biological interactions therefore relate to identifiable stages in a causal pathway, and represent many of the known general qualitative interactions.

Two or more factors also can interact biologically to produce an effect that is greater than that expected of either factor alone; this is **synergism**. An example would be the potentiating effect of combinations of antibiotics. Similarly, there is synergism between the four component organisms of ovine foot-rot, described above.

‘Synergism’ should be reserved to describe **biological** mechanisms. In the epidemiological literature, however, synergism has also been used to describe certain types of statistical, rather than biological, interactions, and this has led to some confusion (Kleinbaum *et al.*, 1982). The use of ‘synergism’ in a statistical context is discussed in the following section.

## Statistical interaction

Statistical interaction is a quantitative effect involving two or more factors. Often disease occurrence does not depend simply on the presence or absence of a factor; there may be continuous variation in the frequency of occurrence of disease associated with both the strength of a factor (e.g., the frequency with which dairy farm personnel milk cows and infection with *Leptospira* spp.: see Table 3.1) and the number of factors involved. There is often a ‘background’ frequency of occurrence associated with none of the factors under consideration. When two or more factors are associated with disease, the frequency of disease may be proportional to the occurrence of disease resulting from the **separate** frequencies attributable to each factor (i.e., the frequency when each factor is present singly, minus the ‘background’ frequency). Alternatively, the frequency may be either in excess of or less than that expected from the combined effects of each factor, in which case **statistical interaction** occurs. For example, Willeberg (1976), in his study of the feline urological syndrome (FUS), showed that castration and high levels of dry cat food intake, when present simultaneously, resulted

in a frequency of the FUS in excess of that expected from the combined effects of each factor, indicating positive statistical interaction between the two factors.

When several component causes are present simultaneously, their joint effect can be explained quantitatively in terms of two causal models: **additive** and **non-additive** (Kupper and Hogan, 1978). The additive model interprets disease occurrence, when two or more factors are present, as the **sum** of the amount of disease attributable to each factor. If no interaction exists, then, for example:

when X and Y are both absent, suppose ‘background’ disease occurrence =  $\gamma$ ;  
 when cause X is present alone, disease occurrence =  $2 + \gamma$ ;  
 when cause Y is present alone, disease occurrence =  $5 + \gamma$ ;  
 when X and Y are both present, disease occurrence =  $7 + \gamma$ .

If positive interaction occurs, then the level of disease occurrence, when X and Y are present, will be greater than  $7 + \gamma$ .

The commonest non-additive model is the multiplicative. This interprets disease occurrence, when two or more factors are present, as the **product** of the amount of disease attributable to each factor. If no interaction exists, then, for example:

when X and Y are both absent, suppose ‘background’ disease occurrence =  $\delta$ ;  
 when cause X is present alone, disease occurrence =  $2\delta$ ;  
 when cause Y is present alone, disease occurrence =  $5\delta$ ;  
 when X and Y are both present, disease occurrence =  $10\delta$ .

If positive interaction occurs, then the level of disease occurrence, when X and Y are present, will be greater than  $10\delta$ .

Disease occurrence can be measured in terms of incidence or other measures of the risk of disease developing (see Chapter 15). The type of model depends on the means of expressing disease occurrence; for example, a multiplicative model may become additive if log transformation of the measure of occurrence is conducted.

In epidemiology the additive model is of particular relevance to assessing the impact of a factor on disease occurrence in a population, whereas the multiplicative model has a role in the elucidation of causes (Kleinbaum *et al.*, 1982). When there is evidence of positive interaction based on the additive model, the model has sometimes been described as **synergistic**. However, there are arguable differences between interaction and synergism (Blot and Day, 1979). Evidence of a positive statistical interaction does not

necessarily imply a causal relationship. However, if it can be inferred that the factors are part of an aggregate of causes with a common causal pathway, then synergism is said to have occurred (MacMahon, 1972). Synergism, in a statistical context, therefore may be thought of as a positive statistical interaction where a causal pathway may be inferred. Thus, castration and high levels of dry cat food intake (usually associated with overfeeding and sometimes related to insufficient water intake) are synergistically associated in the FUS: both may result in inactivity, thereby reducing blood flow to the kidneys, impairing renal function, and therefore promoting changes in the urine that are conducive to the formation of uroliths.

The value of assessing statistical interaction lies in its ability to identify the **degree** to which various determinants interact. It then may be possible to predict the extent to which disease incidence may be reduced by modification of the determinants. Thus, the value of interaction often lies in its ability to **predict** outcome, rather than to explain biological interaction (Kupper and Hogan, 1978). The quantification of statistical interaction is described in Chapter 15.

## The cause of cancer

The cause of cancer exemplifies interaction between host, agent and environment. The abnormal, unrestricted multiplication of cells produces a tumour. Tumours may be benign, in which growth is restricted, and spread to other parts of the body does not occur, or malignant, in which growth is unrestricted, and spread (metastasis) may occur. Malignant tumours are commonly termed cancers, the word taking its meaning from the zodiacal constellation of the crab, because malignant tumours 'put out' extensions like the limbs of a crab.

## The induction of cancer

The mass of cancerous cells that constitutes a malignant tumour originates from a single 'founder' cell which once was normal, but which has undergone a fundamental change. This change is manifested in several abnormal characteristics such as excessive dependence on anaerobic metabolism and the presence of unusual tumour antigens, in addition to the disregard for normal territorial boundaries, which is a cancer's most obvious characteristic. These complex alterations in cell behaviour appear to originate from a surprisingly restricted set of genetic changes (Weinberg, 1983). Thus, cancer can be induced in laboratory animals by the introduction of cells that have been transferred to the cancerous state, *in vitro*, by infection with polyoma virus.

Epidemiological investigations previously had revealed that, in addition to viruses, chemical and physical agents can induce cancer. Hydrocarbons in soot were the first chemicals to be incriminated. In 1775, Percival Pott, a London surgeon, recorded an increased incidence of scrotal epithelioma in chimney sweeps. Since then, a range of chemical carcinogens has been identified (Coombs, 1980), including hydrocarbons, aromatic amines (associated with bladder cancer in dyestuff workers), *N*-nitroso compounds (associated with liver cancer in fish, birds and mammals), steroids (e.g., oestrone, inducing mammary cancer in mice), inorganic products such as asbestos (associated with mesothelioma in man; see Chapter 18) and some natural products (e.g., the fungal aflatoxins, which are contaminants of peanut oil, implicated in liver cancer in humans and in fish exposed to contaminated foodstuffs).

The pathogenesis of cancer has a well established molecular basis (Cullen *et al.*, 2002). Evidence suggests that tumour-inducing (oncogenic) viruses, chemical and physical carcinogens, and spontaneous mutations alter cellular DNA and, therefore, that cancer results from alterations to genetic material (Coop and Ellis, 2003). The critical genes that are the targets of these alterations fall into two families: proto-oncogenes and oncosuppressor genes (Lee and Yeilding, 2003). **Proto-oncogenes** code for the products that directly support cell proliferation, or, sometimes, inhibit cell death. These products form a group of cell-regulatory molecules, including growth factors, membrane-associated growth factor receptors, GTP-binding proteins, tyrosine and serine kinases, and transcription factors. These molecules are vital for the normal modulation of cell behaviour. When modified, for example by mutation, through interaction with chemical carcinogens or ionizing radiation, they acquire the potential to transform cells directly towards the cancerous state. Such modified forms of the proto-oncogenes are called **oncogenes**. Many transforming animal retroviruses contain versions of such oncogenes, presumably acquired during the sojourn of the virus within host cells.

**Oncosuppressor genes** have the property of restraining growth. In association with proto-oncogenes, such genes exert extremely important roles in physiological cell regulation. One such gene (the retinoblastoma susceptibility gene, Rb-1) regulates cell movement into and around the replication cycle. Another (p53) initiates cell cycle arrest in response to genotoxic injury, so permitting DNA repair. Others may modulate the passage of signals from cell to cell or from substratum to cell, via adhesion molecules, and so adjust cell behaviour and proliferation in response to prevailing cell density within a tissue. In carcinogenesis, these genes are silenced, usually by mutation

or by acquired loss of part of the chromosome containing the gene. Normal diploid cells contain two copies of each oncosuppressor gene, and in general both must be inactivated to achieve the full change of phenotype that is recognized as cancer. However, these paired events do not necessarily occur at the same time. They may be acquired one after the other through continuous exposure to a carcinogen, or only one may be acquired, the other being inherited in the germ line. Animals that inherit such defective oncosuppressor genes are clearly at higher risk of acquiring cancer through subsequent exposure to environmental carcinogens, and several well known inherited cancer-susceptibility syndromes in humans (e.g., familial retinoblastoma and familial polyposis coli) are the result of this type of inherited gene defect. Interestingly, the transforming genes of several animal DNA viruses (e.g., in the papova-, papilloma-, adeno-virus groups) appear to act through binding to the products of endogenous oncosuppressor genes.

Many tumours show a steeply rising age-incidence relationship (Armitage and Doll, 1954; Peto, 1977; and see *Figure 5.5*). This can be accurately modelled by assuming that carcinogenesis requires multiple independent events. Laboratory reconstructions, in which different oncogenes are inserted, in active form, into previously normal cells, also confirm the view that multiple changes are required to achieve full transformation from normality to the cancer cell. Hence, it is not surprising that the majority of known cancers can be shown to contain multiple oncogene and oncosuppressor gene alterations. The concept of **multistage carcinogenesis**, however, also includes interactions between agents that may not effect permanent changes in DNA structure in the manner outlined above for oncogenes and oncosuppressor genes. Early experiments with chemical carcinogens delineated two main processes in carcinogenesis (Becker, 1981): **initiation and promotion**.

Initiation, either by oncogenic viruses, ionizing radiation, chemical carcinogens, or inherited or spontaneous changes in the genome, is assumed to involve an irreversible alteration in cellular DNA.

Initiation alone is not sufficient to induce a cancer, but produces a cell with a high risk of becoming malignant. Malignancy results when promotion occurs. This step was considered to be reversible, although there is evidence that, when cells have reached a certain stage of change, they progress irreversibly to cancer (e.g., Peraino *et al.*, 1977). Several chemical promoters have been identified, such as croton oil, which promotes skin tumours. The active ingredient in croton oil is an ester that is an analogue of an endogenous cellular regulatory molecule, but the biochemical basis of promotion is generally still poorly understood. Many

chemical carcinogens are both initiators and promoters (**complete carcinogens**).

'**Co-carcinogen**' is a general term for a factor that furthers the action of a carcinogen, such as chronic inflammation or a chemical promoter. Squamous cell carcinoma of sheep in northern Australia occurs predominantly on the ears, the prevalence increasing with decreasing latitude. Solar ultraviolet radiation has been incriminated as a physical carcinogen. An infectious agent, transmitted on ear marking instruments, may be a co-carcinogen, and would explain why the lesions are commoner on the ear than on other parts of the head.

### Investigating the cause of cancer

Biochemists, virologists and molecular biologists have identified inducers and promoters, using animals and tissue cultures. At the top of the biological hierarchy, epidemiologists have identified risk factors using observational studies. Two groups of factors are defined (Gopal, 1977):

1. specific causal agents;
2. modifying factors.

Specific physical causal agents that have been incriminated include ultraviolet and ionizing radiation (the latter experimentally inducing thyroid tumours and leukaemia in dogs), chronic irritation (associated with some horn cancers in Indian cattle: Somvanshi, 1991) and parasites (e.g., *Spiroceria lupi* associated with canine oesophageal osteosarcoma and fibrosarcoma). Specific chemical and biological initiators, such as viruses, have already been described. Modifying factors are not incriminated as initiators, but in some way affect the incidence of cancer, and include co-carcinogens. The genetic composition of the host is the most important modifying factor, and may be related to the presence of suitable proto-oncogenes. Some cancers can be hereditary; for example, porcine lymphosarcoma (McTaggart *et al.*, 1979).

Interactions have been demonstrated in which chemical carcinogens enhance the production of tumours *in vitro* by oncogenic viruses. One outstanding example is the interaction between bracken fern and infection with bovine papilloma virus, described above. Some non-oncogenic viruses are also reported to interact with chemical carcinogens (Martin, 1964). Thus, chickens infected with pox viruses, and mice infected with influenza virus, are more susceptible to chemical carcinogenesis than non-infected animals. Doll (1977) has contended that most cancers have environmental causes as either initiators or promoters.

Investigation of the cause of cancer therefore involves cooperation between several disciplines: biochemistry,

pathology, molecular biology and epidemiology, and attempts have been made to produce conceptual models that link molecular to epidemiological studies (Moolgavar, 1986). However, Rothman and Greenland (1998) comment that

'Description of a mechanism whereby such [biological] interactions take place does not immediately lead to precise predictions about epidemiological observations. One reason this is so is that rarely if ever is a mechanism proposed that would account for all observed cases of disease, or all effects of all risk factors, measured and unmeasured. Background "noise", in the form of unaccounted-for effects and interactions, would easily obliterate any pattern sought for by the investigator.'

The various disciplines should therefore be considered as complementary suppliers of different pieces of the 'cancer jigsaw puzzle'.

Tumours of domestic animals and some of their causes are reviewed by Meuten (2002). Domestic animals can also be useful biological models of human cancer (Pierrepoint, 1985); this topic is discussed further in Chapter 18.

## Further reading

- Clarke, A. (1987) Air hygiene and equine respiratory disease. *In Practice*, **9**, 196–204
- Clayton, D. and McKeigue, P.M. (2001) Epidemiological methods for studying genes and environmental factors in complex diseases. *Lancet*, **358**, 1356–1360
- Coop, A. and Ellis, M.J. (2003) The nature and development of cancer. In: *Oxford Textbook of Medicine*, Vol. 1. Eds Warrell, D.A., Cox, T.M., Firth, J.D. and Benz, E.J., pp. 219–228. Oxford University Press, Oxford
- Darcel, C. (1994) Reflections on viruses and cancer. *Veterinary Research Communications*, **18**, 43–61
- Dennis, M.J. (1986) The effects of temperature and humidity on some animal diseases – a review. *British Veterinary Journal*, **142**, 472–485
- Doll, R. and Peto, R. (2003) Epidemiology of cancer. In: *Oxford Textbook of Medicine*, Vol. 1. Eds Warrell, D.A., Cox, T.M., Firth, J.D. and Benz, E.J., pp. 193–218. Oxford University Press, Oxford
- Ekesbo, I. (1988) *Environment and Animal Health*. Proceedings of the 6th International Congress on Animal Hygiene, Skara, Sweden, 2 vols. Swedish University of Agricultural Sciences, Report No. 21
- Furuuchi, S. (1993) Weather and animal diseases. In: *Agricultural Meteorology CAgM Report No. 52, Report of the RA II Working Group on Agricultural Meteorology, Geneva, January 1993*. WMO/TD-No. 524, pp. 1–37. World Meteorological Organization, Geneva
- Gough, A. and Thomas, A. (2003) *Breed Predispositions to Disease in Dogs and Cats*. Blackwell Publishing, Oxford
- Greene, C.E. (1998) Environmental factors in infectious disease. In: *Infectious Diseases of the Dog and Cat*, 2nd edn. Ed. Greene, C.F., pp. 673–683. W.B. Saunders, Philadelphia
- Hartigan, P.J. (2004) Stress and disease. In: *Bovine Medicine: Diseases and Husbandry of Cattle*, 2nd edn. Eds Andrews, A.H., Blowey, R.W., Boyd, H. and Eddy, R.G., pp. 1133–1148. Blackwell Science, Oxford
- Lactera, N., Bernabucci, U., Khalifa, H.H., Ronchi, B. and Nardoni, A. (Eds) (2003) *Interactions between Climate and Animal Production*. Wageningen Academic Publishers, Wageningen
- MacMahon, B. (1972) Concepts of multiple factors. In: *Multiple Factors in the Causation of Environmentally Induced Disease*. Fogarty International Center Proceedings No. 12. Eds Lee, D.H.K. and Kotkin, P., pp. 1–12. Academic Press, New York and London
- Madwell, B.R. and Theilen, G.H. (1987) Etiology of cancer in animals. In: *Veterinary Cancer Medicine*, 2nd edn. Eds Theilen, G.H. and Madwell, B.R., pp. 13–26. Lea and Febiger, Philadelphia
- Mims, C.A., Nash, A. and Stephen, J. (2000) *Mims' Pathogenesis of Infectious Disease*, 5th edn. Academic Press, London
- Muller, M. and Brem, G. (coordinators) (1998) Genetic resistance to animal diseases. *Revue Scientifique et Technique, Office International des Epizooties*, **17**, 1
- Patterson, D.F. (1993) Understanding and controlling inherited diseases in dogs and cats. *Tijdschrift voor Diegeneeskunde*, **118**, Suppl. 1, 23S–27S
- Philips, C. and Piggitt, D. (Eds) (1992) *Farm Animals and the Environment*. CAB International, Wallingford. (Includes discussions of environment-dependent diseases, stress, and the effects of ventilation on health and performance)
- Reif, J.S. (1983) Ecologic factors and disease. In: *Textbook of Veterinary Internal Medicine*. Vol. 1: *Diseases of the Dog and Cat*, 2nd edn. Ed. Ettinger, S.Y., pp. 147–173. W.B. Saunders Company, Philadelphia
- Sainsbury, D.W.B. (1991) Environmental factors affecting susceptibility to disease. In: *Microbiology of Animals and Animal Products*. World Animal Science, A6. Ed. Woolcock, J.B., pp. 77–94. Elsevier, Amsterdam
- Sainsbury, D.W.B. (1998) *Animal Health*, 2nd edn. Blackwell Science, Oxford. (A concise account of factors affecting the health of livestock in intensive production systems)
- Schaechter, M., Engleberg, N.C., Eisenstein, B.I. and Medoff, G. (Eds) (1999) *Mechanisms of Microbial Disease*, 3rd edn. Lippincott Williams and Wilkins, Philadelphia
- Wathes, C.M. (1992) Ventilation. In: *Farm Animals and the Environment*. Eds Phillips, C. and Piggitt, D., pp. 83–91. CAB International, Wallingford. (A discussion of the biological consequences of ventilation, including its effects on health and performance)
- Wathes, C.M. and Charles, D.R. (Eds) (1994) *Livestock Housing*. CAB International, Wallingford. (A broad review of the housing requirements of production species in relation to health)
- Wyllie, A.H. (1992) Growth and neoplasia. In: *Muir's Textbook of Pathology*, 13th edn. Eds MacSween, R.N.M. and Whaley, K., pp. 355–410. Edward Arnold, London



# 6

## The transmission and maintenance of infection

Infectious disease is the result of the invasion of a host by a pathogenic organism. The continued survival of infectious agents, with or without the induction of disease, depends on their successful transmission to a susceptible host, the instigation of an infection therein and replication of the agent to maintain the cycle of infection. The complete cycle of an infectious agent is its **life history (life-cycle)**. A knowledge of the life history of an infectious agent is essential when selecting the most applicable control technique (see Chapter 22). This involves knowledge of:

- the modes of transmission and maintenance of infection;
- the ecological conditions that favour the survival and transmission of infectious agents.

This chapter is concerned with the first topic; the second is considered in Chapter 7 with reference to basic ecology.

Transmission may be either **horizontal (lateral)** or **vertical**. Horizontally transmitted infections are those transmitted from any segment of a population to another; for example, influenza virus from one horse to a stable-mate. Vertically transmitted infections are transmitted from one generation to the next by infection of the embryo or fetus while *in utero* (in mammals) or *in ovo* (in birds, reptiles, amphibians, fish and arthropods). Transmission by milk to offspring is also considered, by some, to be vertical.

### Horizontal transmission

Infections can be transmitted horizontally either **directly** or **indirectly** (Figure 6.1).

Direct transmission occurs when a susceptible host contracts an infection, either by physical contact with

an infected host or by contact with the latter's infected discharges (e.g., the transmission of canine distemper in infected urine and faeces).

Indirect transmission involves an intermediate vehicle, living or inanimate, that transmits infection between infected and susceptible hosts. This vehicle generally may be termed a **vector**, although the term is usually restricted, by common usage, to living carriers (see 'vector' below). Indirect transmission can involve a vector of a different species from that of the initially infected host. The life-cycle of infectious agents therefore may be complex, with several different hosts. Details of specific life-cycles are not presented in this chapter, but a basic knowledge of veterinary microbiology and parasitology is assumed.

Airborne transmission of infectious agents, frequently over long distances, is often defined as indirect, although it is more correctly classified as direct because no intermediate vehicle is involved.

### Types of host and vector

A variety of terms describe the range of host/parasite relationships, and are used by the epidemiologist,

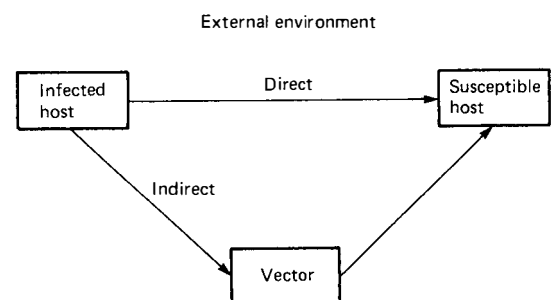

Fig. 6.1 Basic mechanisms of transmission of infectious agents.

protozoologist, entomologist, helminthologist and microbiologist. Each of these may use terms specific to his discipline that have the same general meaning, from the point of view of the life-cycle of the disease, as different words from other disciplines; for example, **intermediate host** in helminthology and **biological vector** in entomology (see below).

## Hosts

**Host** A plant, animal or arthropod that is capable of being infected with, and therefore giving sustenance to, an infectious agent. Replication or development of the agent usually occurs in the host.

**Definitive host** A parasitological term describing a host in which an organism undergoes its sexual phase of reproduction (e.g., *Taenia pisiformis* in dogs; *Plasmodium* spp. in mosquitoes).

**Final host** A term used in a more general sense (i.e., in connection with all types of infectious agent) as a synonym for **definitive host**. Both 'final' and 'definitive' imply the 'end of the line'; in other words, the termination of a dynamic process. They are, in most cases, therefore improperly used.

**Primary (natural) host** An animal that maintains an infection in the latter's endemic area (e.g., dogs infected with distemper virus). Since an infectious agent frequently depends upon a primary host for its long-term existence, the host is also called a **maintenance host**.

**Secondary (aberrant) host** A species that additionally is involved in the life-cycle of an agent, especially outside typical endemic areas (e.g., cattle infected with strains of foot-and-mouth virus that usually cycle in buffaloes). A secondary host sometimes can act as a maintenance host<sup>1</sup>.

**Paratenic host** A host in which an agent is transferred **mechanically**, without further development (e.g., fish, containing *Diphyllobothrium* spp. larvae, which are preyed upon by larger fish). This term is exclusive to helminthology, and could be considered

<sup>1</sup> The distinction between the primary and secondary hosts is important in relation to microbial evolution. For instance, although influenza viruses can infect a wide variety of birds and mammals, the primary hosts are wild waterfowl, shorebirds, and gulls. The evolutionary rate of influenza virus in the primary hosts is believed to be slow, while in mammals, chickens and turkeys the rate is much higher (Suarez, 2000). The higher rate of evolution in mammals is thought to be a result of selective pressure on the virus to adapt to an aberrant host species.

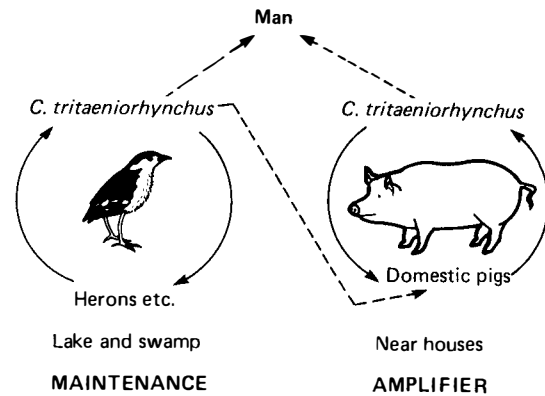

**Fig. 6.2** The maintenance and amplifier hosts of Japanese encephalitis virus in Japan. The vector is the mosquito, *Culex tritaeniorhynchus*. (From Gordon Smith, 1976, based on Buescher *et al.*, 1959, and Scherer *et al.*, 1959.)

to have its entomological analogue in the term **mechanical vector**.

**Intermediate host** An animal in which an infectious agent undergoes some development, frequently with **asexual reproduction** (e.g., *Cysticercus pisiformis* in rabbits and hares). This term is parasitological in origin.

**Amplifier host** An animal which, because of temporally associated changes in population dynamics that produce a sudden increase in the host population size, may suddenly increase the amount of infectious agent. Multiplication of the agent occurs in this type of host. This term is most commonly used in relation to virus diseases. An example is litters of baby pigs infected with Japanese encephalitis virus (Figure 6.2).

**Hibernating host** An animal in which an agent is held, probably without replication, in a state of 'suspended animation' (e.g., hibernating snakes infected with either western, eastern or Japanese encephalitis virus).

**Incidental (dead-end or accidental) host** One that does not usually transmit an infectious agent to other animals (e.g., bulls infected with *Brucella abortus*). 'Final' and 'definitive' can be applied validly to this type of host.

**Link host** A host that forms a link between other host species (e.g., pigs linking infected herons to man in Japanese encephalitis: Figure 6.2).

**Reservoir** A term commonly used as a synonym for, or prefix to, 'host'; ('**reservoir host**'). A reservoir host is one in which an infectious agent normally lives and multiplies, and therefore is a common source of

infection to other animals; thus, it is frequently a primary host. In Kenya, for example, buffalo and water-buck are reservoirs of bovine ephemeral fever virus, acting as a source of infection for cattle (Davies *et al.*, 1975). Similarly, in the tropics, cattle are reservoirs of bluetongue virus, and therefore can be sources of infection for sheep (Hourrigan and Klingsporn, 1975). Animals may be important reservoirs of infection for humans. In Sierra Leone, the multimammate mouse, *Mastomys natalensis*, is the primary host and reservoir of Lassa fever, a virus disease with a high case fatality rate in man (Monath *et al.*, 1974). The mouse is adapted to life both within houses and in fields, and comes into contact with man in rural areas, particularly during the wet season, when it may seek shelter in houses and thus may transmit the infection to man. Likewise, birds are reservoirs of eastern equine encephalitis, and so farmed birds can be used as 'sentinels' for surveillance of the infection (see Chapter 10). Reservoirs may be primary or secondary hosts.

'Reservoir' is also used to refer to any substance that is a common source of infection (e.g., soil as a source of anthrax spores).

**Vector** An animate transmitter of infectious agents. By common usage, vectors are defined as invertebrate animals – usually arthropods – that transmit infectious agents to vertebrates. The dictionary definition of the term implies independent movement; that is, a living vehicle. Inanimate carriers of agents (e.g., feed concentrates contaminated with *Salmonella* spp.) usually are called 'fomites' (singular: fomes, from the Greek meaning 'tinder'; because fomites were thought metaphorically to be the 'tinder' by which the 'fire' of an epidemic was ignited).

**Mechanical vector** An animal (usually an arthropod) that physically carries an infectious agent to its primary or secondary host (e.g., mosquitoes and fleas transmitting myxomatosis virus between rabbits). The infectious agent neither multiplies nor develops in the mechanical vector.

**Biological vector** A vector (usually an arthropod) in which an infectious agent undergoes either a necessary part of its life-cycle, or multiplication, before transmission to the natural or secondary host.

Three types of biological transmission occur:

1. **developmental transmission:** with an essential phase of development occurring in the vector (e.g., *Dirofilaria immitis* in mosquitoes);
2. **propagative transmission:** when the agent multiplies in the vector (e.g., louping-ill virus in ixodid ticks);
3. **cyclopropagative transmission:** a combination of 1 and 2 (e.g., *Babesia* spp. in ticks).

Development in the vector involves migration of the infectious agent. Thus, two types of transmission are identified in the life-cycles of members of the protozoan genus *Trypanosoma* (Maudlin *et al.*, 2004). The African trypanosomes that parasitize the blood and tissues of infected animals are ingested by insects of the genus *Glossina*, in which they undergo a developmental cycle that involves migration from their initial focus of infection in the midgut and back to the salivary glands, from which infective forms are released; this is **salivarian** transmission. In contrast, members of the species *Trypanosoma cruzi* (the cause of Chagas' disease in man in South America, with dogs, cats and some wild animals implicated as reservoirs) are ingested by bugs of the family *Reduviidae*, from which infective forms are shed in the faeces, human infection occurring by contamination of wounds and the eyes; this is **stercorarian** transmission.

Biological vectors are frequently either definitive or intermediate hosts; for example, mosquitoes are biological vectors and the definitive hosts of *Plasmodium* spp. (the cause of malaria).

## Factors associated with the spread of infection

Three factors are important in the transmission of infection (Gordon Smith, 1982):

1. characteristics of hosts;
2. characteristics of pathogens;
3. effective contact.

### Characteristics of hosts

A host's **susceptibility** and **infectiousness** determine its ability to transmit infection. Susceptibility to infection may be limited to a single species or group of species. For example, only equids are naturally susceptible to equine rhinopneumonitis virus infection. Alternatively, several widely different species may be susceptible to an infection; for example, all mammals are susceptible to rabies.

Susceptibility within a species may vary markedly and may be associated with selection of genetically resistant animals following exposure to an infectious agent. For example, the mortality in rabbits, exposed experimentally to a standard dose of myxomatosis, fell from 90% to 25% over a 7-year period (Fenner and Ratcliffe, 1965).

'Infectiousness' refers to:

- the duration of the period when an animal is infective;
- the relative amount of an infectious agent that an animal can transmit.

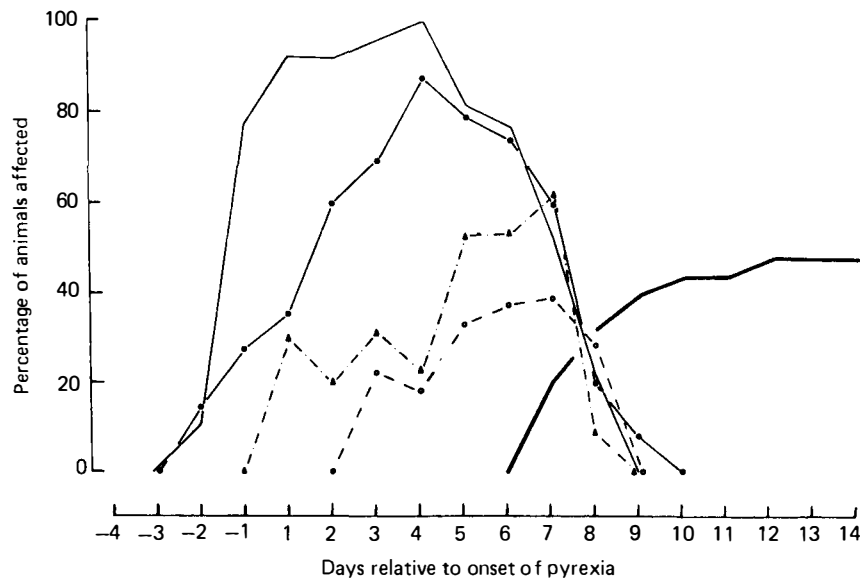

**Fig. 6.3** Correlation of viraemia and virus excretion in cattle infected experimentally with virulent rinderpest virus (strain RGK/1): — viraemia; •—• nasal excretion of virus; ▲—• urinary excretion of virus; •—• faecal excretion of virus; — mortality. (From Liess and Plowright, 1964.)

An animal is not infectious as soon as it is infected – a period of time lapses between infection and the shedding of the agent; this is a parasite's **prepatent period**, a virus's **eclipse phase**, and a bacterium's **latent period**<sup>2</sup>. In contrast, the **incubation period** is the period of time between infection and the development of clinical signs. Thus, inapparent infections have a prepatent period, but do not have an incubation period. The **generation time** is the period between infection and maximum infectiousness. This is considered by some authorities (Last, 2001) to be synonymous with the **serial interval**: the period of time between analogous phases of an infectious illness (e.g., infection, onset of clinical signs) in successive cases of a chain of infection spread from animal to animal. These periods, for a given agent and host species, are not the same for all animals, but show natural variation. The frequency distribution of incubation periods, for example, follows a lognormal statistical distribution (see *Figure 12.4* and Sartwell, 1950, 1966).

*Figure 6.3* plots the excretion of rinderpest virus in a group of experimentally infected cattle. It illustrates that nasal excretion is the most common form of shedding of the virus, that virus is shed **before** the appearance of clinical signs, and that, for **the group**, the period of maximum infectiousness is 4 days after the onset of clinical signs (i.e., pyrexia).

<sup>2</sup> 'Latent period' is also used for this time interval for infectious diseases in general. For non-infectious diseases, it is the interval between exposure to a cause and appearance of manifestations of disease. The latent period of canine bladder cancer, for example, is approximately 4 years (see Chapter 18).

		Characteristic of host population		
		Low density	Mixed or changing densities	High density
Characteristic of infectious agent	Short incubation period	□	▼	▼▼▼▼▼
	Mixed incubation periods	▼▼▼	▼▼▼▼▼▼▼	▼▼▼▼▼
	Long incubation	▼▼▼▼▼	▼▼▼	▼▼▼▼▼

**Fig. 6.4** The relationship between duration of incubation period of an infectious agent, density of the host, and the potential of the infectious agent to exist in a population. □: Conditions unfavourable for the existence of infectious agent. ▼: Conditions favourable for the existence of infectious agent; the number of triangles indicates the relative degree to which the conditions are favourable. (Modified from Macdonald and Bacon, 1980.)

Diseases with short incubation periods run a clinical course, terminating in either recovery or death, relatively quickly. Thus, a high host density is required to ensure that the agent's life-cycle can be perpetuated (*Figure 6.4*). An example is distemper virus infection of dogs with an incubation period of 4–5 days. This disease therefore is endemic only in urban areas where there is a high density of dogs. In contrast, infectious diseases with long incubation periods can maintain their cycles of infection in varying animal densities (*Figure 6.4*); rabies is an example.

The time between infection and availability of an infectious agent in an arthropod vector is the agent's **extrinsic incubation period**.

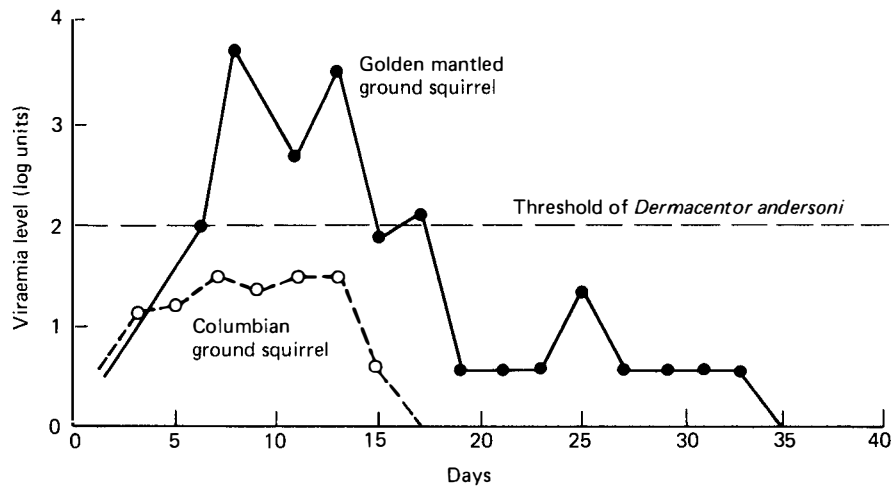

**Fig. 6.5** Colorado tick fever: the relationships between viraemia levels in a maintenance host (the golden mantled ground squirrel) and an accidental host (the Columbian ground squirrel) and the threshold of infection of the arthropod maintenance host (*Dermacentor andersoni*). (From Gordon Smith, 1976, after Burgdorfer, 1960.)

For transmission to occur between a vertebrate host and an arthropod vector, an infectious agent must be present to a minimum concentration in the vertebrate host's circulation. This is the **threshold level**. Some vertebrate hosts may become infected, but are unable to transmit infection to arthropods because the threshold level is not achieved. These are therefore 'dead end' hosts. For example (Figure 6.5), the Columbian ground squirrel is an incidental (dead end) host for Colorado tick fever. However, when the virus infects and multiplies in the golden mantled ground squirrel, the threshold level is attained; therefore the vector, the tick *Dermacentor andersoni*, can ingest virus particles, and this squirrel can act as a maintenance host.

### Characteristics of pathogens

Three important characteristics of pathogens that affect transmission of infectious agents are **infectivity**, **virulence** and **stability**.

**Infectivity** relates to the amount of an organism that is required to initiate infection. The infectivity of different organisms varies considerably. For example, the **particle:infectivity ratio** (the number of virus particles required to instigate infection) of bacterial viruses (bacteriophages) in tissue culture is approximately 1:1, indicating a high degree of infectivity. Lower degrees of infectivity are demonstrated by animal viruses, with ratios of between 10:1 and 100:1. Plant viruses have an even lower infectivity, with a ratio of approximately 1000:1. Infectivity can vary between different strains of the same organism, and can depend upon the route of the infection, and the age and innate resistance of the host.

When an agent is capable of infecting more than one species, its infectivity for different hosts is often quite

different. For instance, the infective dose of strains of *Campylobacter jejuni* isolated from chickens is only 500 bacteria for chickens, whereas the infective dose of strains of the same bacterium isolated from seagulls is above  $10^7$  for chickens. This example illustrates that the infectivity of an agent cannot be specified without reference to the host that it infects.

**Virulence** (see Chapter 5) also affects transmission and can change. Repeated passage through the same species of animal tends to increase virulence for that species but to simultaneously lower virulence for the original natural host. Thus, serial passage of Ross River virus in suckling mice increases its virulence for mice (Taylor and Marshall, 1975), but alternate passage in mice and the mosquito *Aedes aegypti* does not alter virulence. In contrast, when Edwards (1928) passaged rinderpest virus of bovine origin serially through several hundred goats, its virulence for cattle dramatically decreased, enabling production of the first veterinary modified live virus vaccine.

The length of time for which an organism can remain infective outside its host is the organism's **stability**. Some organisms survive only for short periods of time; that is, they are very **labile** (e.g., *Leptospira* spp. in dry environments), whereas others are more resistant (Table 6.1). Stability is frequently facilitated by protective capsules, such as those forming the outer layer of bacterial spores (e.g., *Bacillus anthracis*). The hazards presented to infectious agents by the external environment, and techniques of achieving stability, are discussed later in this chapter.

### Effective contact

Effective contact describes the conditions under which infection is likely to occur. For a particular infection it

**Table 6.1** The effect of temperature and pH on time for 90% foot-and-mouth disease virus inactivation. (From Pharo, 2002.)

Effect of temperature (at pH 7.5)		Effect of pH (at 4°C)	
Temperature	Inactivation time (90%)	pH	Inactivation time (90%)
61°C	30 seconds	10.0	14 hours
55°C	2 minutes	9.0	1 week
49°C	1 hour	8.0	3 weeks
43°C	7 hours	7.0–7.5	>5 weeks
37°C	21 hours	6.5	14 hours
20°C	11 days	6.0	1 minute
4°C	18 weeks	5.0	1 second

depends on the stability of the organism and the routes by which the organism leaves an infected host and enters a susceptible one.

Effective contact may be very short (e.g., seasonally transmitted, vector-borne diseases) or potentially of many years' duration (e.g., anthrax spores in soil: Dragon and Rennie, 1995). The duration of infectiousness determines the number of susceptibles that can be infected by an infected animal. Thus, upper respiratory tract infections (e.g., kennel cough in dogs) result in short periods of infectiousness of several days' duration, whereas cows infected with bovine tuberculosis may excrete the bacterium in their milk for several years.

Behaviour, which may be changed during infection<sup>3</sup>, can also affect the likelihood of effective contact. Thus, feral animals that are naturally shy of man may enter houses when they contract rabies, therefore increasing the likelihood of human infection. Humans infected with Guinea worm are driven to soothe affected limbs in rivers, thus facilitating release of the parasite from lesions, and transmission to other individuals. Sticklebacks infected with cestodes become sluggish, and so are likely to be caught by predatory birds, in which the life-cycle is completed.

The pathogenesis of disease may increase the likelihood of transmission; for example, respiratory diseases may induce coughing and sneezing, thereby spreading respiratory pathogens to near neighbours.

<sup>3</sup> Host behavioural changes following infection are widespread throughout the Animal Kingdom (Poulin, 1995), also involving intermediate hosts. For example, *Leucochloridium*, a helminth parasite with birds as its definitive hosts, has a snail as its intermediate host. The tentacles of infected snails change in size, shape and colour, and pulsate in response to light (Kagan, 1951), thereby attracting the definitive hosts. The magnitude of the effect of parasites on host behaviour appears to be similar in vertebrate and invertebrate hosts; among helminth parasites, nematodes appear to induce the greatest behavioural changes (Poulin, 1994).

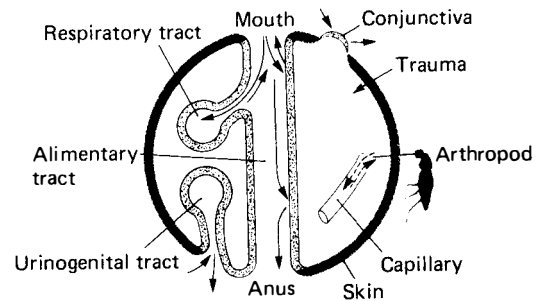

**Fig. 6.6** Body surfaces as sites of horizontal infection and shedding of infectious agents. (Modified from Mims *et al.*, 2000.)

## Routes of infection

The site or sites by which an infectious agent gains entry to a host (Figure 6.6), and by which it leaves the host (Table 6.2), are the agent's routes of infection.

### The oral route

Infection via the mouth is one of the more common routes of entry, especially in relation to the enteric organisms, which often 'escape' from an infected animal in the faeces. Organisms such as rotaviruses, *Salmonella* spp. and gastrointestinal parasites may contaminate water and foodstuffs, which then act as fomites. Ingested agents may be excreted in the faeces, producing the **faecal–oral** transmission cycle.

Agents that gain entry to the body orally may be disseminated from the infected animal by a variety of routes, apart from in the faeces. *Brucella abortus* often infects cows orally but is excreted later in the milk and uterine discharges. Similar circumstances occur in relation to infection of ruminants with the rickettsia *Coxiella burnetii*, the cause of Q fever. Such agents may then be retransmitted by both the oral and other routes. Although some organisms can be transmitted by the oral route, the low pH of gastric secretions is an effective barrier against this method of transmission for a wide variety of organisms.

### The respiratory route

The respiratory route is also a common method of transmission for many infectious agents, including those that are not restricted to the respiratory tract (e.g., *Salmonella typhimurium*: Wathes *et al.*, 1988). Infectious agents seldom occur as individual airborne particles, but are usually associated with other organic matter in the form of droplets or dust. The nature and size of such composite particles affect their dispersal and stability. Particles of a diameter of 5 nm or greater do not reach the alveoli of the lung and therefore initially cause infection only of the upper respiratory tract.

**Table 6.2** Examples of routes by which animal pathogens are shed from infected hosts. (Modified from Wathes, 1994.)

Site of exit	Contaminated tissue or fluid	Pathogen	Disease	Host
Body surface	Hair	<i>Microsporum canis</i>	Ringworm	Dog, man, etc.
	Lesion crusts	Poxviruses	Cowpox	Ox, sheep, etc.
	Exudate (e.g., pus)	<i>Staphylococcus aureus</i>	Abscesses	
Nose	Secretions	Paramyxovirus spp.	Distemper	Dog
	Exudate (bloodstained)	Orthomyxovirus spp.	Influenza	Pig, horse, birds
		<i>Bacillus anthracis</i>	Anthrax	Ox, sheep
Mouth	Saliva	Foot-and-mouth virus	Foot-and-mouth disease	Ox, sheep
	Sputum	Lyssavirus spp.	Rabies	Dog
		<i>Mycobacterium tuberculosis</i>	Tuberculosis (pulmonary)	Ox, man
		<i>Erysipelothrix rhusiopathiae</i>	Erysipelas	Pig
Mammary	Milk	<i>Streptococcus agalactiae</i>	Mastitis	Ox
Anus	Faeces	<i>Mycobacterium johnei</i>	Johne's disease	Ox, sheep
		Rotavirus spp.	Enteritis	Pig
		<i>Salmonella dublin</i>	Enteritis, septicaemia	Ox
Urogenital tract	Urine, semen	<i>Leptospira canicola</i>	Leptospirosis	Dog
		<i>Campylobacter fetus</i>	Infertility	Ox
	Eggs	<i>Salmonella pullorum</i>	Pullorum disease	Poultry
Eyes	Tears	<i>Haemophilus influenzae</i>	Pink eye (New Forest disease)	Ox
Wound (tick vector)	Blood	<i>Rickettsia burnetti</i>	Q-fever	Ox

Infections spread by the respiratory route are more likely to occur where population densities are high and ventilation is poor. Examples of such conditions are enzootic pneumonia in intensively reared pigs, and occupationally acquired brucellosis in meat workers. In environmental extremes, diseases that are spread rarely by the respiratory route become transmissible by this method. These circumstances arise in the airborne transmission of rabies from insectivorous bats to animals and man within the confines of a cave. Similarly, African swine fever virus, which is usually transmitted by *Ornithodoros* spp. ticks, spreads rapidly by the oral route in piggeries. In crowded and poor living conditions, pneumonic plague is transmitted directly between people, rather than by the bites of infected fleas, the latter method of transmission inducing the less severe bubonic plague.

### Infection via skin, cornea and mucous membranes

Transmission via the skin is **percutaneous** (Latin: *per* = through, across; *cut* = skin). Certain agents infect only the skin, and transmission is always by direct contact with either another infected animal or a fomes; examples are 'ringworm' and ectoparasitic infestations. The incidence of such infections and infestations is particularly influenced by the population density of the susceptible hosts. Intact skin acts as an effective barrier to the majority of infectious agents, but some, particularly the immature stages of some nematodes and

trematodes, can penetrate this barrier and cause infection. Examples include blood fluke (*Schistosoma* spp.) and hookworm (*Ancylostoma* spp.) infections, the latter infection also being zoonotic and the cause of cutaneous larva migrans in man.

If the skin is cut or abraded, then infection by a variety of organisms can occur, resulting in localized infections of the skin (e.g. by *Staphylococcus* spp. and the cutaneous form of human anthrax). Other agents, such as leptospire and swine vesicular disease virus, may gain entry to the body percutaneously and then develop a more generalized infection.

Another important form of percutaneous infection is from bites by both vertebrates and arthropods. Agents that are present in the saliva, such as the viruses of rabies and lymphocytic choriomeningitis, and bacteria such as *Streptobacillus moniliformis* (a common inhabitant of the oropharynx of rats), are transmitted by animal bites. Diseases transmitted by the bites of infected arthropod vectors constitute a particular class of infections that was introduced earlier in this chapter during the description of hosts and vectors.

Infection of the cornea may remain localized, for example, bovine keratoconjunctivitis caused by *Moraxella bovis*. Alternatively, the infection may spread to other parts of the body, for instance, corneal infection of birds with Newcastle disease virus.

Although few diseases can be transmitted through intact skin, several can infect undamaged mucous membranes. An important class of such agents is those

that are very labile in the external environment, and require intimate sexual contact during coitus to be transmitted to the urogenital tract, for example *Trypanosoma equiperdum* in horses.

## Methods of transmission

Six main methods of transmission, which bring infectious agents into contact with the sites of infection, can be identified:

1. ingestion;
2. aerial transmission;
3. contact;
4. inoculation;
5. iatrogenic transmission;
6. coitus.

### Ingestion

This may occur via a mechanical vehicle (fomes), for example, contaminated water, or by ingestion of intermediate hosts, such as cestode cysts in meat. Ingested agents are usually excreted in the faeces, producing the faecal–oral transmission cycle. Some agents are excreted only faecally because they are localized to the intestine (e.g., the Johne's disease bacillus in cattle). Other agents, if they invade the bloodstream, can be excreted by additional means, such as the urine (e.g., *Salmonella* spp.). Sometimes, agents are excreted on the breath (e.g., reoviruses and rinderpest virus).

### Aerial transmission

This involves airborne transmission of infectious agents via contaminated air. It is the usual method of transmission with the hardy spores of fungi and some bacteria, and also occurs with pathogens of the respiratory tract that are expired on the breath of infected animals and enter susceptible ones during inspiration.

Quasistable suspensions of liquids or solids in gases, that are capable of floating for some time, are formed only when droplet diameters do not exceed 5 nm. Expiratory droplets range in size from 15 to 100 nm and thus even the smallest sediment rapidly (within 3 seconds). Therefore, they cannot travel far. Direct infection from expiratory droplets is thus limited to the area directly in front of the infected individual (the 'expiratory cone'). Very localized droplet infection can occur on food bowls and by sniffing.

**Aerosol transmission** is a type of airborne transmission involving transmission via an aerosol which is defined variously as (1) any solution in the form of a fine spray in which the droplets approximate colloidal

**Table 6.3** Common pathogens of pigs and poultry known to be transmitted aurally. (From Wathes, 1987.)

<b>Bacteria</b>	
<i>Bordetella bronchiseptica</i>	<i>Mycobacterium tuberculosis</i>
<i>Brucella suis</i>	<i>Mycoplasma gallisepticum</i>
<i>Corynebacterium equi</i>	<i>Mycoplasma hyorhinus</i>
<i>Erysipelothrix rhusiopathiae</i>	<i>Mycoplasma suis pneumoniae</i>
<i>Escherichia coli</i>	<i>Pasteurella multocida</i>
<i>Haemophilus gallinarum</i>	<i>Pasteurella pseudotuberculosis</i>
<i>Haemophilus parasuis</i>	<i>Salmonella pullorum</i>
<i>Haemophilus pleuropneumoniae</i>	<i>Salmonella typhimurium</i>
<i>Listeria monocytogenes</i>	<i>Staphylococcus aureus</i>
<i>Leptospira pomona</i>	<i>Streptococcus suis</i> type II
<i>Mycobacterium avium</i>	
<b>Fungi</b>	
<i>Aspergillus flavus</i>	<i>Coccidioides immitis</i>
<i>Aspergillus fumigatus</i>	<i>Cryptococcus neoformans</i>
<i>Aspergillus nidulans</i>	<i>Histoplasma farcinorum</i>
<i>Aspergillus niger</i>	<i>Rhinosporidium seeberi</i>
<b>Rickettsia</b>	
<i>Coxiella burnetii</i>	
<b>Protozoa</b>	
<i>Toxoplasma gondii</i>	
<b>Viruses</b>	
African swine fever	Infectious nephrosis of fowls
Avian encephalomyelitis	Infectious porcine encephalomyelitis
Avian leukosis	Marek's disease
Foot-and-mouth disease	Newcastle disease
Fowl plague	Ornithosis
Hog cholera	Porcine enterovirus
Inclusion body rhinitis	Swine influenza
Infectious bronchitis of fowls	Transmissible gastroenteritis of swine
Infectious laryngotracheitis of fowls	

size (1–100 nm), and (2) finely divided virus particles hanging or floating in air. Thus, quasistable suspensions and expiratory droplets can both be involved in aerosol transmission.

Some agents that are not primarily pathogens of the respiratory tract can contaminate the air and therefore may also be airborne. An example is foot-and-mouth disease virus shed from ruptured vesicles (see also 'Long-distance transmission of infection' below). Similarly, some *Salmonella* spp. infections are airborne and infect animals via the conjunctiva (Moore, 1957).

Table 6.3 lists some common pathogens of pigs and poultry that can be transmitted aurally.

### Contact

Contact transmission is transmission without transmission factors (e.g., mechanical vectors) and without participation of an external medium. This is particularly important in relation to infectious agents that are shed from the body surfaces, such as vesicular viruses, and with agents that gain entry through the body surface.



Very few agents are transmitted merely by touch; some degree of trauma is necessary, albeit microscopic. Transmission may be by bites (e.g., rabies and rat bite fever), or by scratches (e.g., cat scratch fever).

Diseases transmitted by contact may be described as 'contagious' (Latin: *contagio* = to touch closely) but this term now is used less commonly than previously.

### Inoculation

Inoculation (Latin: *inoculatus* = engrafted, or implanted) is the introduction into the body, by puncture of the skin or through a wound, of infectious agents.

Although classified separately here, inoculation is frequently associated with contact transmission (e.g., bites from rabid dogs). Arthropods that act as vectors may inoculate infectious agents into the blood by biting (e.g., tsetse flies infected with *Trypanosoma* spp., in which development of the parasite occurs in the salivary gland, gut and mouthparts).

### Iatrogenic transmission

Iatrogenic literally means 'created by a doctor'. Thus, an iatrogenically transmitted infection is one that is transferred during surgical and medical practice.

There are two main types, involving:

1. introduction of pathogens by dirty instruments, (e.g., during non-aseptic surgery and tattooing) or by contaminated body surfaces;
2. introduction of pathogens contaminating prophylactic or therapeutic preparations (e.g., *Pseudomonas aeruginosa* in intramammary dry-cow antibiotic preparations: Nicholls *et al.*, 1981; porcine reproductive and respiratory syndrome virus in needles: Otake *et al.*, 2002; lumpy skin disease in anaplasmosis vaccine; scrapie in louping-ill vaccine; human hepatitis B virus and HIV/AIDS in serum preparations and blood<sup>4</sup>) and, more rarely, by organ transplantation (e.g., rabies virus by corneal transplants).

### Coitus

Some infectious agents may be transmitted during coitus. Certain diseases are transmitted only in this way. These were called venereal diseases (Latin: *venereus* = pertaining to sexual love). In human

medicine they now are referred to as sexually transmitted diseases (STDs). Sexual transmission can occur not only in vertebrates but also in arthropods. For example, African swine fever virus can be sexually transmitted from male to female ticks of the genus *Ornithodoros* (Plowright *et al.*, 1974).

The mode of transmission of agents frequently governs the epidemic picture. Thus, agents that are transmitted by the faecal-oral and airborne modes often produce sudden explosive epidemics, whereas coitally transmitted diseases spread more slowly, over a long period of time.

### Long-distance transmission of infection

Infectious diseases can be transmitted by the methods described above over long distances as a result of the mobility of infected animals, microorganisms and parasites, vectors and fomites.

### Host mobility

Previously, transportation by sea provided a period of quarantine, but epidemics, nevertheless, did occur. For example, Italian colonists accidentally introduced a few cattle infected with rinderpest into the Horn of Africa in 1880, resulting in a pandemic that swept through sub-Saharan Africa, from Somalia to Cape Town (Scott, 1964).

The increasing use of air transport now means that animals incubating infections can arrive at their destination before clinical signs of infection have appeared. The movement of horses, in connection with their sale, breeding and competition, has spread a variety of equine infections, including contagious equine metritis, equine infectious anaemia, piroplasmosis and influenza, between continents (Powell, 1985). International livestock trade also poses a clear risk of disease transmission; enzootic bovine leucosis, *Mycoplasma bovis*, *M. canadensis*, *Haemophilus somnus* and infectious bovine rhinotracheitis may have been introduced into the UK in this way (Scudamore, 1984). The translocation of farmed fish for angling and food production poses similar risks (Cable and Harris, 2003), and disease can spread between free-ranging and captive wildlife as a result of movement between the two types of population (Table 6.4).

The importation of animals infested with the screw-worm fly, *Chrysomya bezziana*, has spread the disease from Uruguay to Libya; the giant fluke, *Fascioloides magna*, was introduced into European elk from North America; and duck plague was introduced into North American wild ducks and geese through the importation of infected domestic ornamental waterfowl

<sup>4</sup> Vaccines – while not actually being contaminated with pathogens – also may induce acute hypersensitive reactions (Tizard, 1990), as well as being determinants of chronic immune-mediated diseases (Hogensch et al., 1999; Dodds, 2001).

**Table 6.4** Movement of species among free-ranging and captive wildlife populations that has exacerbated the spread of disease. (Modified from Cleaveland *et al.* (2002) The role of pathogens in biological conservation. In: *The Ecology of Wildlife Diseases*, Edited by Hudson, P.J. *et al.* By permission of Oxford University Press.)

Disease	Species of concern	Movement	References
Canine distemper	Black-footed ferret	Wild to captive	Thorne and Williams (1988)
Haematozoa ( <i>Plasmodium kempfi</i> )	Wild turkeys	Wild to wild	Castle and Christensen (1990)
Lungworm ( <i>Bronchonema magna</i> )	Bontebok, springbok	Wild to wild	Verster <i>et al.</i> (1975)
<i>Mycoplasma</i> spp.	Gopher and desert tortoises	Captive to wild; Wild to wild	Jacobson (1994); Jacobson <i>et al.</i> (1995)
Parvovirus	Racoons	Wild to wild	Woodford (1993)
Rabies	Racoons, skunks	Wild to wild	Jenkins <i>et al.</i> (1988)
Rinderpest	Cloven-hoofed artiodactyls (e.g., wildebeest, eland, buffalo, bushbuck)	Domestic to wild; wild to wild	Lowe (1942); Thomas and Reid (1944); Sinclair and Norton-Griffiths (1979); Scott (1981)
Tuberculosis	Arabian oryx	Captive to wild	Kock and Woodford (1988)
Warble flies, nostril flies	Caribou	Captive to wild	Woodford (1993)
'Whirling disease'	Rainbow trout	Captive to wild	Trust (1986)

(Leighton, 2002). There is a risk of the introduction of heartwater into the US associated with the importation of tick-infected reptiles and wild game from Africa, and from infected livestock imported from the Caribbean (BurrIDGE *et al.*, 2002).

Transmission can also involve more complex relationships. Thus, Crimean–Congo haemorrhagic fever virus infects its vector, *Hyalomma* spp. ticks, which are then carried by migrating birds from the Crimea to Africa where they are responsible for outbreaks of the disease (Hoogstraal, 1979).

There is concern that *C. bezziana*, which is endemic in Papua New Guinea, may be imported into Australia as an inadvertent passenger on international flights, or by animal movement between the Torres Strait Islands (see the case study in Chapter 20 for further details). The movement of people by aeroplane can also distribute human exotic diseases over all parts of the world (Prothro, 1977)<sup>5</sup>. Although smallpox has been globally eradicated (see Chapter 22), it is believed that unofficial virus stocks<sup>6</sup> exist (Henderson, 1998) and, if intentionally released, could be widely distributed by air travel (Grais *et al.*, 2003).

The movement of animals may also contribute to epidemics of human disease. For example, epidemics of human trypanosomiasis ('sleeping sickness') occur

in distinct foci in Africa, in contrast to trypanosomiasis in animals, which tends to occur throughout the tsetse fly region. Cattle are also reservoirs of infection of human trypanosomes, and the movement of infected cattle (e.g., to market) appears to be responsible for translocating human infective trypanosome strains into regions previously free from the disease (Hide *et al.*, 1996; Hide, 2003).

### Airborne (atmospheric) transmission

Airborne transmission of infection (atmospheric transmission) is a specific category of long-distance transmission. It cannot occur with expiratory droplets because they sediment rapidly (see above). Transmission of respiratory and vesicular infections indirectly through the air over long distances (atmospheric transmission) must, therefore, be effected by other means. The evaporation of water from droplets (which can occur when droplets are airborne or on the ground) produces desiccated **droplet nuclei**, ranging in diameter from 2 nm to 10 nm. The smallest of these are quasistable and can travel over long distances, assisted by wind. The rate of formation of these nuclei depends on the temperature and relative humidity. Rain sediments the nuclei.

**Foot-and-mouth disease** Atmospheric transmission of foot-and-mouth disease has received considerable attention. Thus, during the 1967–68 foot-and-mouth disease epidemic in the UK, a series of secondary outbreaks followed the primary one (Figure 6.7a). Initially,

<sup>5</sup> There are also other health-related risks associated with flying, such as deep-vein thrombosis and additional risks to sufferers of pulmonary disease (Buik, 2004).

<sup>6</sup> Stocks are officially confined at the Centers for Disease Control and Prevention, Atlanta, Georgia, and Vector, Koltsovo, Novosibirsk.

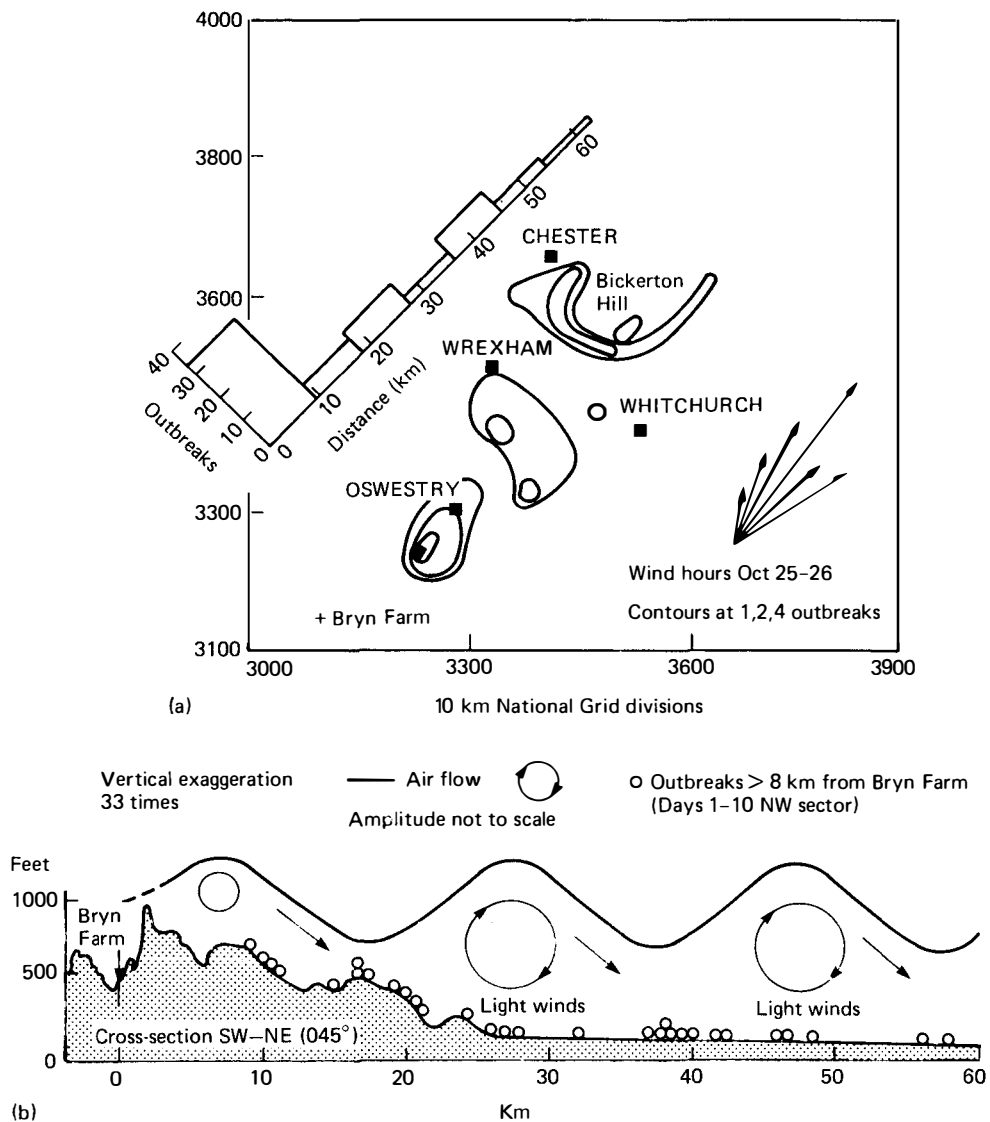

**Fig. 6.7** The 1967-68 English foot-and-mouth disease epidemic: (a) outbreaks from days 1-10; (b) profile through Bryn Farm illustrating the lee wave hypothesis of aerial spread of virus. (Reprinted by permission from *Nature*, Vol. 227, pp. 860-862. Copyright © 1970 Macmillan Journals Limited.)

it was suggested that this was due to infected imported lamb, because no human or mechanical links could be established between the secondary outbreaks and the primary outbreak at Bryn Farm. However, a complex meteorological hypothesis has been presented (Tinline, 1970, 1972) suggesting that the secondary outbreaks were caused by virus particles being pulled downwards in a current of air, which is forced into vertical oscillation as it flows over a hill. This phenomenon is called a **lee wave** (Figure 6.7b)<sup>7</sup>.

Another, more general model of airborne transmission of foot-and-mouth disease virus uses the meteorological **Gaussian plume** model for atmospheric

diffusion (Hanna *et al.*, 1982) which is a basic model for dispersion calculations. This predicts horizontal elliptical spread, the shape of the virus-laden plume depending on wind speed, downwind distance from the source of infection, and air stability. More recent model formulations include the **ALOHA** (Aerial Location of Hazardous Atmospheres) system (Casal *et al.*, 1997), initially developed to predict the dispersal of toxic gases from chemical engineering plants; and the **Rimpuf** model (Sørensen *et al.*, 2000). The latter model – which considers topography and factors that affect virus survival (e.g., relative humidity) – simulates plumes by breaking them into independent, three-dimensional concentration fields ('puffs'), transportation of which depends on atmospheric stability. This model predicts that the distance at which susceptible animals are at risk of infection from infected animals

<sup>7</sup> For fuller discussions of lee waves, see Casswell (1966) and Bradbury (1989). Recent studies (Gloster *et al.*, 2005) suggest that the role of lee waves may have been exaggerated.

depends on the species of each, and the number of infected animals (Table 6.5)<sup>8</sup>. The distance over which animals are at risk also depends on the infecting strain: virus production by animals infected by the C Noville strain (Table 6.5a) being approximately 300 times greater than when infected by the PanAsia strain (Table 6.5b).

Long-distance spread of foot-and-mouth disease virus is most likely under the following conditions:

- high output of virus from the infected animals: pigs are an important source of airborne virus because they excrete vast quantities of airborne virus (see Chapter 5) – and are often kept in large numbers (Donaldson *et al.*, 1982; Donaldson, 1987);
- steady wind direction so that animals may be exposed for several hours;
- relative humidity greater than 60%, allowing high survival of virus (Donaldson *et al.*, 1982); however, heavy rains wash the virus out of the air;
- low levels of atmospheric turbulence associated with a flat landscape, stable surface air (particularly over water) and light winds, which result in low dispersion of virus (Gloster *et al.*, 1982).

Extensive windborne spread, however, is not common, probably because the likelihood of all the predisposing factors occurring together is small<sup>9</sup>. Analysis of field data has shown the most usual pattern of airborne spread of the virus is from pigs at source to cattle downwind (Henderson, 1969; Hugh-Jones and Wright, 1970; Sellers, 1971; Sellers and Forman, 1973; Donaldson *et al.*, 1982; Gloster *et al.*, 1982). The 1967–68 epidemic in the UK occurred in one of the most densely stocked dairy areas in the country. During the first 3 weeks, around 350 separate outbreaks occurred and more than 2000 farms were affected over a period of 9 months (Figure 4.1a). The size of the outbreak was attributed to its explosive start, which occurred following extensive airborne transmission from an infected pig unit (HMSO, 1969). The 2001 epidemic (Figure 4.1b) began in similar fashion by airborne spread from a pig unit to nearby cattle and sheep farms (DEFRA, 2002b; see Chapter 4).

**Some other diseases** Identification of isolates of Aujeszky's disease virus using molecular epidemiological techniques has also suggested that airborne

**Table 6.5** Effect of species and number of animals excreting foot-and-mouth virus on the risk for different species downwind. ((a) from Sørensen *et al.*, 2000; (b) from Donaldson *et al.*, 2001.)

**(a) C Noville strain**

Species excreting virus	Distance (km) downwind at which species are at risk		
	Cattle	Sheep	Pigs
1000 infected animals			
Pigs	300	90	20
Cattle	3	0.5	<0.1
Sheep	3	0.5	<0.1
100 infected animals			
Pigs	120	15	5
Cattle	0.7	<0.1	<0.1
Sheep	0.7	<0.1	<0.1
10 infected animals			
Pigs	30	4	1
Cattle	<0.1	<0.1	<0.1
Sheep	<0.1	<0.1	<0.1
1 infected animal			
Pigs	5	1	0.3
Cattle	<0.1	<0.1	<0.1
Sheep	<0.1	<0.1	<0.1

**(b) PanAsia strain**

Species excreting virus	Distance (km) downwind at which species are at risk		
	Cattle	Sheep	Pigs
1000 infected animals			
Pigs	6	2	<0.2
Cattle	0.7	0.2	<0.1
Sheep	0.7	0.2	<0.1
100 infected animals			
Pigs	2	0.4	<0.1
Cattle	0.2	<0.1	<0.1
Sheep	0.2	<0.1	<0.1
10 infected animals			
Pigs	0.5	0.1	<0.1
Cattle	<0.1	<0.1	<0.1
Sheep	<0.1	<0.1	<0.1
1 infected animal			
Pigs	<0.1	<0.1	<0.1
Cattle	<0.1	<0.1	<0.1
Sheep	<0.1	<0.1	<0.1

<sup>8</sup> The modelled infection is *between* populations, where it is generally argued that the size of an infected population affects transmission to other populations (Willeberg *et al.*, 1994; Van Nes *et al.*, 1998). This contrasts with transmission of infection *within* a population, where transmission depends on the density of susceptible individuals, rather than population size (Bouma *et al.*, 1995; De Jong *et al.*, 1995) (see Chapter 8).

<sup>9</sup> Concerns that virus might be spread by smoke rising from incinerated infected carcasses, for example, are probably unfounded (Gloster *et al.*, 2001; Jones *et al.*, 2004a).

transmission of this virus over long distances can occur (Christensen *et al.*, 1990, 1993), and this suggestion has been supported by dispersion models (Gloster *et al.*, 1984; Grant *et al.*, 1994). Similarly, studies of outbreaks of vesicular stomatitis, based on nucleotide fingerprinting and trajectory analysis of winds, suggest that wind could have been responsible for carrying infection from Mexico to the US (Sellers and

Maarouf, 1990). There is also evidence for airborne transmission of Newcastle disease (Smith, 1964) and the virus causing porcine reproductive and respiratory syndrome (Beilage *et al.*, 1991; Mortensen and Madsen, 1992).

Wind can also carry arthropod vectors over long distances (Pedgley, 1983). The outbreak of bluetongue in Portugal in 1956 (Sellers *et al.*, 1978) may have been caused by windborne transfer of the African vector, *Culicoides imicola*, from North Africa<sup>10</sup>, although the latter now is permanently established in Portugal (Mellor *et al.*, 1985). Windborne transfer has also been incriminated in the introduction of the disease into Cyprus (Polydorou, 1980), Israel (Braverman and Chechik, 1993) and the Balearic Islands (Alba *et al.*, 2004). African horse sickness can also be transferred in a similar way.

## Vertical transmission

### Types and methods of vertical transmission

There are two types of vertical transmission: **hereditary** and **congenital**.

Hereditarily transmitted diseases are carried within the genome of either parent. Thus, retroviruses, which have integrated DNA copies of the virus in the host's genome, are transferred hereditarily.

Congenitally transmitted diseases are, literally, those present at birth. According to strict etymology, hereditarily transmitted diseases are a part of this group. However, by common usage, 'congenital' refers to diseases **acquired** either *in utero* or *in ovo*, rather than inherited.

Transmission can occur at various stages of embryonic development. It may produce either abortion, if incompatible with life, or teratoma (literally 'monsters'). Alternatively, infection which is inapparent and continuous after birth (**innate infection**) can occur.

### Germinative transmission

This involves either infection of the superficial layers of the ovary, or infection of the ovum itself. Examples include the chicken leukosis viruses, spontaneous lymphoid leukaemias of mice (Gross, 1955), murine lymphocytic choriomeningitis and avian salmonellosis.

### Transmission to the embryo

This is via the placenta (transplacentally) or via the fetal circulation, through the placenta, to the fetus. For

example, kittens can be transplacentally infected with feline panleucopenia virus (Csiza *et al.*, 1971). Viruses, being small, cross the placenta with greater ease and earlier in pregnancy than larger microbes. The fetal circulation, however, can carry most microbes. Infection of the placenta does not always produce infection of the fetus. Q fever particles, for instance, may be found in large quantities in bovine placentae without infection of the developing calves.

### Ascending infection

This is infection that is transmitted from the lower genital canal to the amnion and placenta (e.g., some *Staphylococcus* and *Streptococcus* spp. infections).

### Infection at parturition

This is infection acquired from the lower genital canal at birth (e.g., human herpes simplex infection).

### Immunological status and vertical transmission

The immunological status of the fetus is important when agents are transmitted vertically. Immune tolerance of microbial antigens by the fetus can be detrimental in postnatal life, because 'non-self' antigens are then recognized as 'self'. The result is a lack of a protective immune response, sometimes with the development of a carrier state with the subsequent dangers to other susceptible animals, as in the case of feline panleucopenia. However, immune tolerance by the fetus can occasionally be advantageous when infections have clinical and pathological effects mediated by the immune response. The paradigm of this is lymphocytic choriomeningitis (LCM) infection of mice (Oldstone, 1998). In adults the disease is mediated by a lethal infiltration of the brain by responsive T lymphocytes. Prenatal infection induces a tolerance to LCM virion antigens; therefore no lymphocytic infiltration occurs in adult infections; and thus there is no clinical disease.

### Transovarial and trans-stadial transmission in arthropods

Some arthropods, notably ticks and mites, transmit bacteria, viruses and protozoa from one generation to another via their eggs; this is **transovarial** transmission. Examples of transovarially transmitted infections include bovine anaplasmosis (a protozoan disease causing anaemia in cattle in the tropics and subtropics, transmitted by several genera of ticks) and canine

<sup>10</sup> The wind is capable of transporting the midges as 'aerial plankton' up to 700 km (Witmann and Baylis, 2000).

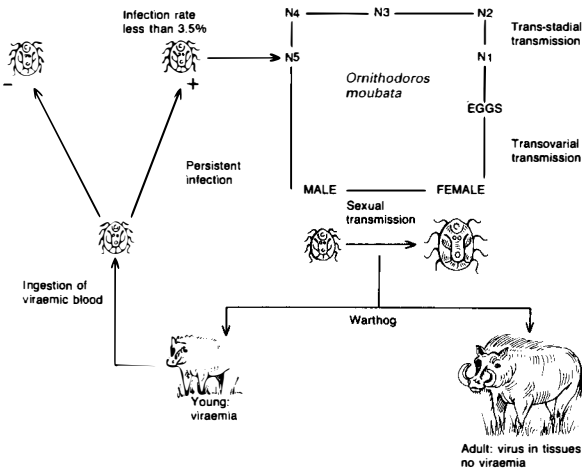

**Fig. 6.8** Transmission cycle of African swine fever virus in warthogs and *Ornithodoros moubata*, N = nymphal stage. (Modified from Wilkinson, 1984.)

babesiosis (another protozoan disease causing anaemia in dogs, transmitted by ticks of the genera *Dermacentor* and *Haemaphysalis*).

In contrast, some arthropods only transmit infections from one developmental stage to another (e.g., in ticks: larva to nymph, nymph to adult); this is **trans-stadial** transmission. An example of a trans-stadially transmitted disease is theileriosis, caused by protozoa of the genus *Theileria*, occurring in cattle, sheep and goats, and transmitted by ticks of the genus *Rhipicephalus*.

Some infections are spread both transovarially and trans-stadially, for example Nairobi sheep disease, a virus infection transmitted by the brown tick, *Rhipicephalus appendiculatus*. Investigations of tick-transmitted diseases are revealing that many infections, once thought to be transmitted by only one of these methods, are transmitted by both.

Some infections involve transovarial, trans-stadial and sexual transmission in arthropods. Thus, in Africa, African swine fever virus is primarily maintained in the tick *Ornithodoros moubata* by these three methods of transmission (Figure 6.8). Warthogs are infected by the bite of the tick, but there is neither horizontal nor vertical transmission between them, and only a small proportion of nymphal ticks are persistently infected when they bite young warthogs during a brief viraemic phase.

## Maintenance of infection

### Hazards to infectious agents

The transmission of infection involves some stages when the infectious agent is in the host, and others

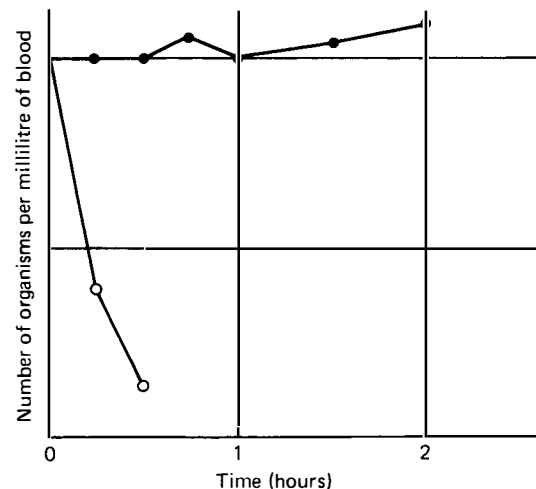

**Fig. 6.9** The protective action of bacterial capsules: pneumococci, capsulated (●) and not capsulated (○), injected intravenously into mice; blood of mice then sampled every 15 minutes. (From Boycott, 1971.)

when it is in the external environment or in a vector, or in both (Figure 6.1). Both internal and external environments present hazards to infectious agents.

### The environment within the host

The host has its natural defence mechanisms: surface-active chemicals, specific reactive cells, phagocytes and humoral antibodies. The successful parasite must be able to avoid, in part, these mechanisms, and must also avoid competition with other agents that may simultaneously infect the host in a similar niche (see Chapter 7). Parasites have evolved strategies to resist the host's protective mechanisms, such as acid-resistant helminth cuticles (to resist gastric acid) and an intracellular mode of life (to avoid humoral antibodies). Some bacteria possess capsules that protect them against phagocytosis, for example, *Pneumococcus* spp. (Figure 6.9). Many parasitic nematodes have a greater fecundity than their free-living counterparts (Table 6.6), thus ensuring that some offspring will survive the host's immune response and potentially lethal conditions in the external environment.

### The external environment

The two main hazards presented by the external environment are desiccation and ultraviolet light. Desiccation is not always lethal, but frequently inhibits multiplication. Low temperatures are not usually lethal, but can inhibit multiplication. The high temperatures attained in temperate climates are probably not lethal but those reached in tropical countries may be more effective. Many agents may be partially protected from desiccation by being discharged in moist

**Table 6.6** The comparative fecundity of *Platyhelminthes* and *Nemathelminthes*. (From Dobson *et al.*, 1992.)

Species	Fecundity	Host
<b>Free-living species</b>	(young/adult/ breeding season)	
Turbellaria		
<i>Polycelis nigra</i>	2.5	
<i>P. tenuis</i>	1.0	
<i>Dugesia polychroa</i>	0.8–1.7	
<i>Planaria torva</i>	4.9–15.2	
<i>Dendrocoelom lacteum</i>	4.9–10.3	
<i>Bdellocephala punctata</i>	16.0	
<b>Parasitic species</b>	(eggs/worm/day)	
Digenea		
<i>Schistosoma mansoni</i>	100	Hamster
Cestoda		
<i>Echinococcus granulosus</i>	600	Dog
<i>Hymenolepis diminuta</i>	200 000	Rat
<i>Taenia saginata</i>	720 000	Man
Acanthocephala		
<i>Moniliformis moniliformis</i>	5 000	Rat
Nematoda		
<i>Ascaris lumbricoides</i>	200 000	Pig
<i>Enterobius vermicularis</i>	11 000	Man
<i>Wuchereia bancrofti</i>	12 500	Man

carriers such as faeces and urine. They may also persist by being shed into favourable surroundings; leptospores, for example, persist longer in paddy fields than in semi-arid regions. Some viruses that survive loss of water and become desiccated remain viable for months or years. Other viruses (e.g., the pox viruses) are resistant to desiccation and can survive for long periods in dry infected scab material. Agents may also survive in inanimate material in the environment, which may therefore act as a fomes; for example, animal foodstuffs contaminated with *Salmonella* spp. Foot-and-mouth disease virus can survive for several weeks on a variety of fomites (Table 6.7), necessitating thorough cleansing and disinfection of premises after outbreaks (Quinn, 1991)<sup>11</sup>.

<sup>11</sup> The following description of the cleansing and disinfection procedures used in Scotland during the 2001 foot-and-mouth disease epidemic exemplifies the intensity of effort that is required to effectively remove the hazard of further infection from environmental contamination. First, and usually within a day of slaughter of affected animals, preliminary cleansing and disinfection of affected farms was undertaken by teams of six: two with pressure washers at the gate to disinfect all leaving vehicles, and four to help with the carcass disposal pyre, carcass moving and preliminary disinfectant spraying of the premises. It was often necessary to provide water bowsers to assist with this. All areas that had been in contact with susceptible stock (especially the slaughter area) were thoroughly soaked with a disinfectant. If immediate removal of carcasses was not possible, then they, also, were soaked with disinfectant and covered until removed. On removal, the area on which the carcasses were located, and any other areas used for transportation and removal, were again sprayed with disinfectant. Next, premises were visited by specially

**Table 6.7** Foot-and-mouth disease virus survival times in animal products, and on some common fomites. (Compiled from Sanson, 1994; Pharo, 2002.)

Product/material	Survival time
Lymph and haemal nodes at 4°C	120 days
Bone marrow at 4°C	210 days
Skeletal muscle (pH<6) at 4°C	2 days
Frozen carcass (no <i>rigor mortis</i> )	6 months
Milk pH 2.0 4°C	1 minute
Milk pH 5.8 4°C	18 hours
Milk pH 7.0 4°C	15 days
Dried casein	2 months
Cheese (manufactured from raw milk) pH 6	30 days
Cheese (manufactured from raw milk) cured at >2°C	120 days
Frozen or liquid manure	>6 months
Wool	14 days
Ox's hair	4–6 weeks
Houseflies	10 weeks
Contaminated footwear	11–14 weeks
Wood, hay, straw, feed sack, etc.	15 weeks

## Maintenance strategies

The ways in which infectious agents are maintained can be considered as **strategies** for maintenance. Five main strategies can be identified:

1. avoidance of a stage in the external environment;
2. the development of resistant forms;
3. a 'rapidly in, rapidly out' strategy;
4. persistence within the host;
5. extension of host range.

### Avoidance of a stage in the external environment

Some agents avoid transfer via the environment. There are four main methods:

trained cleansing-and-disinfection officers to discuss implementation of cleansing and disinfection, either by the farmer alone, or in combination with a contractor, or by the latter alone. A proforma of work to be carried out on approximately 800 premises was completed. Faeces were removed, stacked to heat up, and sprayed with disinfectant. Slurry, by preference, was treated with caustic soda on farms to raise the pH to 11, and then spread on fields; 193 premises were treated in this way. Slurry in towers was left for at least 90 days, before spreading. Some slurry in pits was partially treated and removed to give space for wash water. Some was left for at least 150 days, and then spread. A further 150 premises were dealt with either by these timed methods, or by caustic-soda treatment by the farmers themselves. All areas in contact with susceptible livestock were first hosed down with water. A detergent degreaser then was applied to remove grease and encrusted faeces. These areas were washed down again, and further degreased and washed, if required. Particularly dirty roofs were also washed or vacuumed. The clean areas were then sprayed with disinfectant, and, finally, 7 days later, the areas were disinfected once more. Additionally, approximately 800 3-km pre-emptively-culled premises (see Figures 4.6, 4.14 and Chapter 22) had to have all areas in contact with livestock sprayed with disinfectant.

1. by vertical transmission;
2. by venereal transmission;
3. by vector transmission;
4. by transmission by sarcophagia (flesh eating); for example, the helminth *Trichinella spiralis* occurs in cysts in the muscle of pigs, rats and other animals, and is only transmitted when these animals are eaten by predators and scavengers, including man; 'salmon poisoning' is another example (see Figure 7.9).

### Resistant forms

The harshness of the external environment can be buffered by surrounding the infectious agent with a shell that is resistant to heat and desiccation. Some bacteria form such shells (spores). Examples include members of the genera *Clostridium* and *Bacillus*, which can survive boiling water, even flames, for short periods of time, and may survive in the external environment for decades. Fungi may also produce spores. Generally these are less resistant than bacterial spores. Some helminths and protozoa form resistant shells (cysts). These can protect the agent from the host's defence mechanisms; the protozoan parasite, *Toxoplasma gondii*, for example, can survive for many years in its cystic form in the host, until the latter is eaten. Thick-shelled helminth eggs can resist the external environment and may overwinter on pasture.

### 'Rapidly in, rapidly out' strategy

Some agents enter the host, replicate and leave very quickly, before the host has time to mount an immune response or die. Many viruses of the upper respiratory tract can do this within 24 hours. The strategy requires a continuous supply of susceptible hosts. This may be one reason why respiratory and enteric infections, such as the common cold virus in man, are not present in primitive societies of low population density, and may not have occurred in small prehistoric societies (Brothwell and Sandison, 1967; Black, 1975)<sup>12</sup>.

### Persistence within the host

Infectious agents may persist within the host, sometimes for life. Persistence occurs because the host's defence mechanisms fail to eliminate agents. This failure may arise because microorganisms adapt to the host's phagocytic cells, or develop strategies for avoiding the host's immune response (Mims *et al.*, 2000). The latter include **immunosuppression** and **tolerance**.

Immunosuppression results in the agents being maintained in the host for varying periods of time. It may be general or antigen-specific. General immunosuppression is demonstrated by some viruses (e.g., rinderpest) and protozoa (e.g. *T. gondii*), and facilitates survival of these and other agents in the host. Antigen-specific immunosuppression only involves the response to the infecting microorganism, the responses to other agents being unaffected. Human leprosy and tuberculosis induce this type of immunosuppression.

Tolerance is due to a primary lack of responsiveness by the host, rather than active suppression. This can occur prenatally; the example of LCM has been given earlier in this chapter. It can also occur when there are large amounts of circulating antigen or antigen-antibody complexes, for instance, in human leishmaniasis and cryptococcosis. Tolerance is sometimes found in infections with microorganisms that have antigens similar to normal host antigens (e.g., *Bacterioides* spp. infections in mice). It has been suggested that such 'molecular mimicry' is generally associated with tolerance, but the evidence is equivocal.

Other means of avoiding the host's immune response are **antigenic variation** (see Chapter 5), **intracellular parasitism** (see Chapter 7), multiplication in **sites inaccessible** to the immune response (e.g., mammary tumour virus of mice, infecting the luminal surface of the mammary gland), and the induction of **ineffective antibodies** (e.g., Aleutian disease virus of mink).

Other examples of persistent infections are *Mycobacterium johnei*, tapeworm infections of the gut, and *T. spiralis* in tissues. Specific types of persistent infection (latent and chronic infection, and the carrier state) have already been discussed in Chapter 5.

Persistence can be associated with a long incubation or prepatent period. A group of virus diseases, termed 'slow virus diseases' because of their long incubation period, fall into this category. Maedi-Visna, for example, is a slow virus disease of sheep, producing neurological and respiratory signs, with an incubation period of 2–8 years. Similarly, scrapie is a virus-like disease, also of sheep, which produces neurological signs and has an incubation period of 1–5 years. Its persistence within its host facilitates vertical and possibly horizontal transmission in a flock.

Alternatively, an agent's prepatent period may be relatively short, but excretion of the agent may continue for a long time (i.e., the period of infectiousness is long). Excretion may be intermittent, for example, *Salmonella* spp. infection can be associated with intermittent clinical episodes or subclinical infection, both associated with occasional excretion of the bacterium. Infection may also result in continuous excretion. For instance, infection of cattle by *Leptospira*, serovar *hardjo*, results in urinary excretion of the bacterium that can last for 12–24 months. The long period of

<sup>12</sup> Grenfell *et al.* (2004) present a detailed discussion of the evolution of the dynamics of infection.



**Table 6.8** Some characteristics of host/parasite relationships between fleas, acting as vectors, and infectious agents. (Simplified from Bibikova, 1977.)

Disease and pathogen	Site of pathogen in flea	Reproduction of pathogen in flea	Duration of pathogen in flea	Pathogenic effect on flea
Myxomatosis <i>Fibromavirus myxomatosis</i>	Digestive tract	No	Up to 100 days	Yes
Tularaemia <i>Franciseela tularensis</i>	Digestive tract	No	Several days	No
Murine typhus <i>Rickettsia mooseri</i>	Digestive tract	Yes	Lifetime	No
Murine trypanosomiasis <i>Trypanosoma lewisi</i>	Digestive tract	Yes	Lifetime	No
Salmonellosis <i>Salmonella enteritidis</i>	Digestive tract	Yes	Up to 40 days	Yes
Plague <i>Yersinia pestis</i>	Digestive tract	Yes	Several months to over 1 year	Yes

**Table 6.9** Some infectious diseases commonly transmitted from wildlife to domestic livestock. (Modified from Bengis *et al.*, 2002.)

Disease and causal agent	Maintenance host	Domestic animals affected	Epidemic potential
Foot-and-mouth disease (aphthovirus)	African buffalo and cattle	Cattle, pigs, sheep and goats	Major
Trypanosomiasis ( <i>Trypanosoma</i> spp.)	Elephant, wild ruminants and wild suids	Cattle, horses, pigs, sheep, goats and dogs	Moderate
African swine fever (asfarvirus)	Argasid ticks, warthogs	Domestic pigs	Major
Theileriosis or Corridor disease ( <i>Theileria parva</i> group)	African buffalo	Cattle	Moderate
Heartwater ( <i>Cowdria ruminantium</i> )	Suspect buffalo, other artiodactyls, chelonians and gallinaceous birds	Cattle, sheep and goats	Moderate
African horse sickness (orbivirus)	Zebra	Horses and donkeys	Moderate
Bluetongue (orbivirus)	Various artiodactyls (uncertain)	Sheep and cattle	Moderate
Lumpy skin disease (capripox)	Uncertain	Cattle	Moderate
Malignant catarrhal fever	Blue and black wildebeest	Cattle	Limited (seasonal)
Newcastle disease	Wild birds, exotic pet birds	Poultry	Major
Classical swine fever	Wild boar	Pigs	Major

infectiousness of hosts infected with such agents ensures that a susceptible population, resulting from regular births, is always available. Some endogenous agents (see Chapter 5) may persist as the bacterial flora of hosts.

Agents may persist not only within vertebrate hosts but also in arthropod vectors. African swine fever virus, for example, persists in ticks for up to 8 months (Haresnape and Wilkinson, 1989). Table 6.8 lists the duration of infection of fleas by various microbial agents. Note that some agents (e.g., murine typhus) can persist in fleas for the latter's lifetime which can be very long – over 500 days in the case of unfed *Pulex irritans* (Soulsby, 1982). Additionally, agents can persist in flea excreta for long periods; murine typhus, for example, can persist for over 9 years (Smith, 1973).

### Extension of host range

Many infectious agents can infect more than one host. Indeed, their number exceeds that of one-host agents. For example, over 80% infectious agents to which humans are susceptible are shared by other species of animal. An important role of the veterinarian is to control these zoonoses (e.g., tuberculosis and canine ascarid infections). Some infections of various hosts are inapparent, increasing the difficulty of control. For example, the bacterium *Borrelia burgdorferi*, the tick-transmitted cause of Lyme disease in man and other animals, also inapparently infects several wild and domestic mammals and birds, which maintain the infection in Europe and the US (Anderson, 1988). Table 6.9 lists some infectious diseases with wildlife as

maintenance hosts that transmit infection to domestic livestock.

Extension of host range is an obvious way of maintaining infection, and is facilitated by the presence of the various hosts in the same area. However, if an agent is present in different species in the same region, it should not be assumed that transfer between them always occurs. Thus, 18 southern African species of wildlife have been found to have antibodies to foot-and-mouth disease virus (Condy *et al.*, 1969; Keet *et al.*, 1996), but only the wild buffalo has been shown to be an efficient maintenance host (Condy *et al.*, 1985) and occasional transmitter of infection to cattle (Thomson, 1996) and some cloven-hoofed species of wildlife (Bastos *et al.*, 2000). In contrast, several species of wild animals, such as the elephant, act as dead-end hosts and are incapable of transmitting the virus to other animals (Brooksby, 1972).

## Further reading

- Anderson, R.C. (2000) *Nematode Parasites of Vertebrates: Their Development and Transmission*, 2nd edn. CABI Publishing, Wallingford
- Appel, M.J. (Ed.) (1987) *Virus Infections of Vertebrates Vol. 1. Virus Infections of Carnivores*. Elsevier, Amsterdam
- Blahe, T. (Ed.) (1989) *Applied Veterinary Epidemiology*. Elsevier, Amsterdam. (Includes details of the transmission and maintenance of the major infectious diseases of domestic animals)
- Brooksby, J.B. (Ed.) (1983) The aerial transmission of disease. *Philosophical Transactions of the Royal Society of London, Series B*, **302**, 439–604
- Dieckmann, U., Metz, J.A.J., Sabelis, M.W. and Sigmund, K. (2002) *Adaptive Dynamics of Infectious Diseases: In Pursuit of Virulence Management*. Cambridge University Press, Cambridge
- Dinter, Z. and Morein, B. (Eds) (1990) *Virus Infections of Vertebrates Vol. 3. Virus Infections of Ruminants*. Elsevier, Amsterdam
- Fèvre, E.M., Bronsvoort, B.M. de C., Hamilton, K.A. and Cleaveland, S. (2006) Animal movements and the spread of infectious diseases. *Trends in Microbiology*, **14**, 125–131
- Geering, W.A., Forman, A.J. and Nunn, M.J. (1995) *Exotic Diseases of Animals: a Field Guide for Australian Veterinarians*. Bureau of Resource Sciences, Australian Government Publishing Service, Canberra. (A general description of exotic diseases, with a discussion of eradication in the context of Australia)
- Gibbs, E.P.J. and Bokma, B.H. (Eds) (2002) *The Domestic Animal/Wildlife Interface: Issues for Disease Control, Conservation, Sustainable Food Production, and Emerging Diseases*. *Annals of the New York Academy of Sciences*, Vol. 969. The New York Academy of Sciences, New York. (Includes discussions of wild animal reservoirs of infection)
- Gordon Smith, C.E. (1982) Major factors in the spread of infections. In: *Animal Disease in Relation to Animal Conservation*. Symposium of the Zoological Society of London No. 50. Eds Edwards, M.A. and McDonnell, U., pp. 207–235. Academic Press, London and New York
- Hirsh, D.C. and Zee, Y.C. (Eds) (1999) *Veterinary Microbiology*. Blackwell Science, Malden
- Hurd, H. (1999) Manipulative parasites. *Biologist*, **46**, 162–166. (A concise outline of transmission strategies adopted by parasites)
- Matumoto, M. (1969) Mechanisms of perpetuation of animal viruses in nature. *Bacteriological Reviews*, **33**, 404–418
- McFerran, J.B. and McNulty, M.S. (Eds) (1993) *Virus Infections of Vertebrates Vol. 4. Virus Infections of Birds*. Elsevier, Amsterdam
- Mims, C.A., Playfair, J.H.L., Roitt, I.M., Wakelin, D. and Williams, R. (1993) *Medical Microbiology*. Mosby Europe, London. (A description of host/parasite relationships, host defence mechanisms and microbial strategies for transmission)
- Mims, C.A., Nash, A. and Stephen, J. (2000) *Mims' Pathogenesis of Infectious Disease*, 5th edn. Academic Press, London
- Pastoret, P.-P., Thiry, E., Brochier, B., Schwers, A., Thomas, I. and Dubuisson, J. (1988) Diseases of wild animals transmissible to domestic animals. *Revue Scientifique et Technique, Office International des Epizooties*, **7**, 705–736
- Pensaert, M.B. (Ed.) (1989) *Virus Infections of Vertebrates Vol. 2. Virus Infections of Porcines*. Elsevier, Amsterdam
- Osterhaus, A. (Ed.) (1994) *Virus Infections of Vertebrates Vol. 5. Virus Infections of Rodents and Lagomorphs*. Elsevier, Amsterdam
- Quinn, P.J., Markey, B.K., Carter, M.E., Donnelly, W.J.C. and Leonard, F.C. (2002) *Veterinary Microbiology and Microbial Disease*. Blackwell Science, Oxford
- Sewell, M.M.H. and Brocklesby, D.W. (Eds) (1990) *Handbook on Animal Diseases in the Tropics*. 4th edn. Baillière Tindall, London. (A description of tropical infectious diseases of animals, including concise summaries of transmission and maintenance)
- Simpson, V.R. (2002) Wild animals as reservoirs of infectious diseases in the UK. *Veterinary Journal*, **163**, 128–146
- Studdert, M.J. (Ed.) (1996) *Virus Infections of Vertebrates Vol. 6. Virus Infections of Equines*. Elsevier, New York
- Urquhart, G.M., Armour, J., Duncan, J.L., Dunn, A.M. and Jennings, F.W. (1996) *Veterinary Parasitology*, 2nd edn. Blackwell Science, Oxford
- Williams, E.S. and Barker, I.K. (Eds) (2001) *Infectious Diseases of Wild Mammals*, 3rd edn. Manson Publishing, London
- Woldehiwet, Z. and Ristic, M. (Eds) (1993) *Rickettsial and Chlamydial Diseases of Domestic Animals*. Pergamon Press, Oxford

# 7

## The ecology of disease

---

The study of disease in populations requires an understanding of the relationships between organisms (hosts and agents) and their environment. These relationships govern the spatial and temporal occurrence of disease. Climate, for example, affects the survival of hosts and infectious agents and the distribution of the latter's vectors either directly or, more subtly, by regulating the occurrence of plants that support the organisms. Similarly, the type of plant can affect the availability of minerals and trace elements, and therefore the occurrence of disease associated with a deficiency, an excess, or an imbalance of these chemicals. For instance, white clover (*Trifolium repens*) absorbs relatively small amounts of selenium, whereas brown top (*Agrostis tenuis*) absorbs large amounts (Davies and Watkinson, 1966). Therefore, when pasture is top-dressed with selenium salts to prevent selenium deficiency in animals, the risk of selenium toxicity is greater if the latter plant predominates.

The study of animals and plants in relation to their habits and habitation (habitat) is **ecology** (Greek: *oikos* = house; *logo-* = discoursing)<sup>1</sup>. Ecology developed as a discipline relating to animals and plants, but has been extended to include microorganisms (e.g., Atlas and Bartha, 1998) and has a qualitative and quantitative framework similar to epidemiology (Dodson *et al.*, 1998). In the context of animal disease, the scale of ecological studies therefore ranges from an investigation of leptospire in the 'environment' of the renal tubules to the distribution and dynamics of sylvatic hosts of foot-and-mouth disease in the African savannahs. The study of a disease's ecology (also termed its natural

history) is frequently a part of epidemiological investigations. This has two objectives:

1. an increase in the understanding of the pathogenesis, maintenance and, for infectious agents, transmission of disease;
2. the use of knowledge of a disease's ecology to predict when and where a disease may occur, to enable the development of suitable control techniques.

This chapter introduces basic ecological concepts and relates them to epidemiology.

### Basic ecological concepts

Two major factors that determine the occurrence of disease are the distribution and size of animal populations. The former depends on the distribution of suitable food; the latter depends on availability of food, mates and the species' breeding potential.

### The distribution of populations

#### Vegetational zones

Botanists were among the first to note the division of the Earth into different vegetational zones. In some parts of the world this division is clear; for example, the border between forest and tundra in northern regions, and the zoning of forests as one ascends mountains. In other areas the change is more gradual, for instance the transition from deserts to prairies. Early 18th century naturalists suggested that the world was divided into discrete **formations** of vegetation, such as tundra, savannah and desert, and they drew

---

<sup>1</sup> The term 'ecology' was first used in 1866 by Ernst Haeckel in his book *General Morphology*, in support of the ideas propounded by Charles Darwin, 7 years earlier, in his seminal *Origin of Species*.

**Table 7.1** Koppen's system of classification of climate based on de Candolle's plant groups. (From Colinvaux, 1973.)

<i>De Candolle's plant group</i>	<i>Postulated plant requirements</i>	<i>Formation</i>	<i>Koppen's climatic division</i>
Megatherms (most heat)	Continuous high temperature and abundant moisture	Tropical rain forest	A (rainy with no winter)
Xerophiles (dry-loving)	Tolerate drought, need minimum hot season	Hot desert such as Sonoran	B (dry)
Mesotherms (middle heat)	Moderate temperature and moderate moisture	Temperate deciduous forest	C (rainy with mild winters)
Microtherms (little heat)	Less heat, less moisture, tolerate long cold winters	Boreal forest	D (rainy climates with severe winters)
Hekistotherms (least heat)	Tolerate polar regions 'beyond tree-line'	Tundra	E (polar climates with no warm season)

maps that neatly but erroneously separated formations by lines.

The first serious attempt to explain these apparently neat formations was made by de Candolle (1874), who argued that climate, particularly temperature, dictated vegetation. He drew the first vegetational map based on isotherms. Rain forests were described as formations of **megatherms**, deciduous forests of **mesotherms**, and deserts of **xerophiles**. At the beginning of the 20th century Koppen used de Candolle's classification as the basis of the modern system (Table 7.1), which provides a good correlation between climatic and vegetational regions. Climate may dictate boundaries, but in a much more complex way than merely by ground-level temperature changes and rainfall. Meteorological work using satellites, and long-term studies of the thermal composition of air masses, however, have suggested that the mean positions of air fronts over the Earth roughly coincide with vegetational types.

## Biomes

In the 19th century, zoologists noted that the broad divisions of the Earth were populated by similar animals. Even if the divisions were discontinuous (e.g., Africa and South America), some animals, especially birds, showed similar features. This assisted the evolutionists in adding credence to their theory of **convergent evolution**, which states that animals of different ancestral stock evolve similar features to suit similar environments.

Zoologists attempted to classify different areas of the world according to the types of animal and plant that were present, because the distribution of animals appeared to be related to vegetation. One such person was the American, Merriam (1893) who defined **life zones** in North America after studying the distribution of animals and plants at various altitudes on North American mountains.

Merriam proposed four main life zones (Figure 7.1):

1. boreal (northern), involving the Canadian, Hudsonian and Alpine Arctic;
2. transition, containing animals and plants from the Boreal and Sonoran;
3. Sonoran (named after Sonora, a state in NW Mexico), comprising the Upper and Lower;
4. Tropical.

A fifth, minor one (the Lower Californian), is also indicated in Figure 7.1.

The first impression of the vegetation in a life zone is termed its **vegetational physiognomy**; for example, the boreal life zone is dominated by conifers. However, it is important to note that there is a gradual transition from one zone to another; the apparent boundary on the life-zone map is set sharply by the cartographer. African ecological zones, based on climate, vegetation and potential for agricultural use, are described by Pratt *et al.* (1966), White (1983) and FAO (1999).

Merriam, like de Candolle, thought that temperature governed the distribution of animals. He argued that, in the Northern hemisphere, an animal's northern boundary was drawn by the threshold temperature below which reproduction was not possible. The animal's southern boundary was drawn by the threshold temperature above which the heat was intolerable. Although Merriam spent much time measuring mean temperatures, he was never able to match isotherms with life zones. Although reasons for the transition from one life zone to another are not available, the existence of these zones is clear. They are now commonly called **biomes**. Thus, tropical rain forest, savannah and tundra are biomes, each with its own particular range of plants and animals (the boreal biome is colloquially called the 'Spruce-Moose' biome).

The distribution of infectious agents and their vectors, and therefore of the diseases produced by the former, may be limited by the environmental conditions

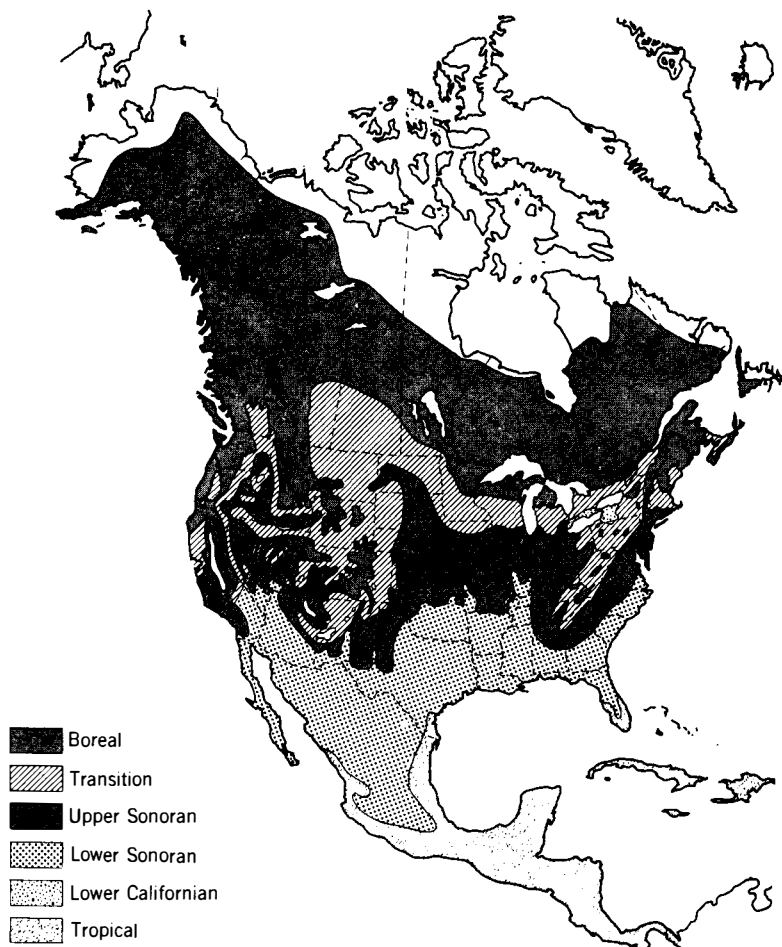

Fig. 7.1 Map of the life zones of North America proposed by Merriam (1893).

of biomes. The distribution of Rift Valley fever (a virus disease of sheep and cattle), for example, is associated with the wetter African ecological zones. This may be related to the abundance of mosquito vectors in these zones (Davies, 1975). Similarly, the fungus *Coccidioides immitis*, which systemically infects humans, dogs, cattle and pigs, producing primary respiratory signs in humans and dogs, appears to be endemically limited to the Lower Sonoran life zone (Figure 7.2: Schmelzer and Tabershaw, 1968). This zone is characterized by hot summers, mild winters, sparse vegetation, an annual rainfall of 6–8 inches (15–20 cm), an alkaline soil pH and wind conditions that are conducive to maintenance and dissemination of the fungus (Egeberg, 1954). Although the disease was first reported over 100 years ago (Deresinski, 1980), the number of cases has recently increased dramatically, and can be particularly severe in immunosuppressed individuals, such as those infected with human immunodeficiency virus (the cause of AIDS) (Kirkland and Fierer, 1996).

The prevalence of heartworm (*Dirofilaria immitis*) infection of dogs in California is related to plant climatic zones (Figure 7.3). The seven zones are based on average temperatures during the day and night.

The time required for the parasite's microfilariae to develop to infective L<sub>3</sub> larvae in the mosquito vector varies considerably between each zone, thus limiting the 'window' of transmission. The high prevalence in the Interior Valley areas also may be explained by the large amount of agricultural land devoted to rice production, which is known to increase the abundance of mosquitoes (Hill and Cambournac, 1941)<sup>2</sup>.

The nature of an ecological zone also has a major influence on animal husbandry, which, in turn, can affect morbidity and mortality (Carles, 1992). For example, animals reared on rangelands throughout the world experience marked climatic and nutritional changes (e.g., in forage type and availability), and inadequate nutrition therefore occurs. Fertility is particularly sensitive to the status of the body's reserves, and so infertility is a common problem on rangelands (Carles, 1986). The practice of trekking may pose additional stress, and so diseases in which stress is a component cause (e.g., pasteurellosis; see Figure 3.5b) are also rangeland problems. Localized environments,

<sup>2</sup> The relationship between malaria and rice cultivation is well-documented (Service, 1989).

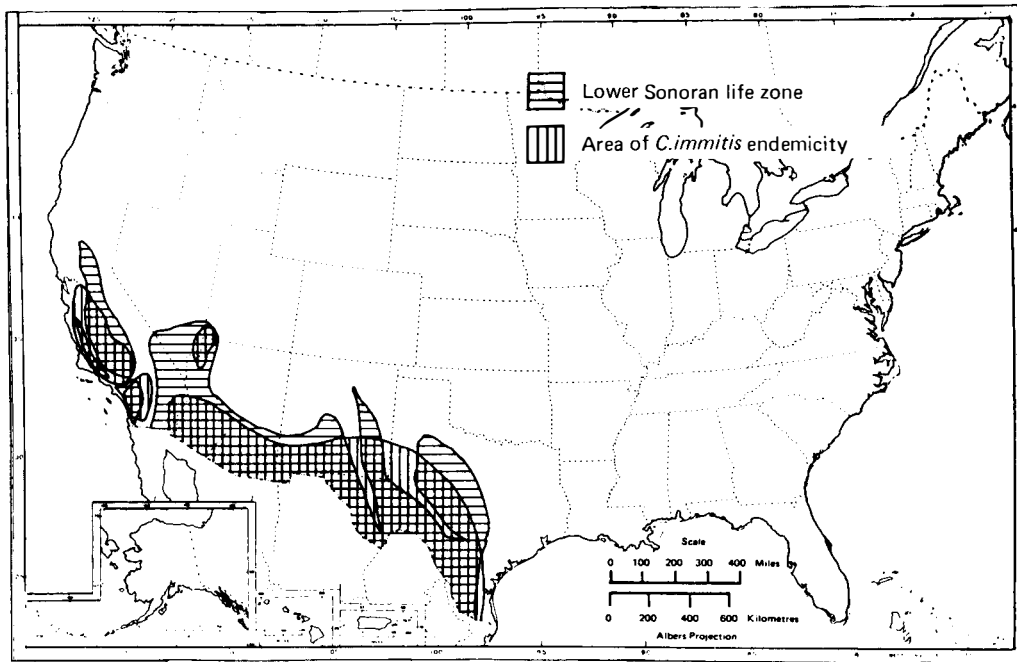

Fig. 7.2 Lower Sonoran life zone and area of endemic *Coccidioides immitis* (nosoarea) in the US. (From Schmelzer and Tabershaw, 1968.)

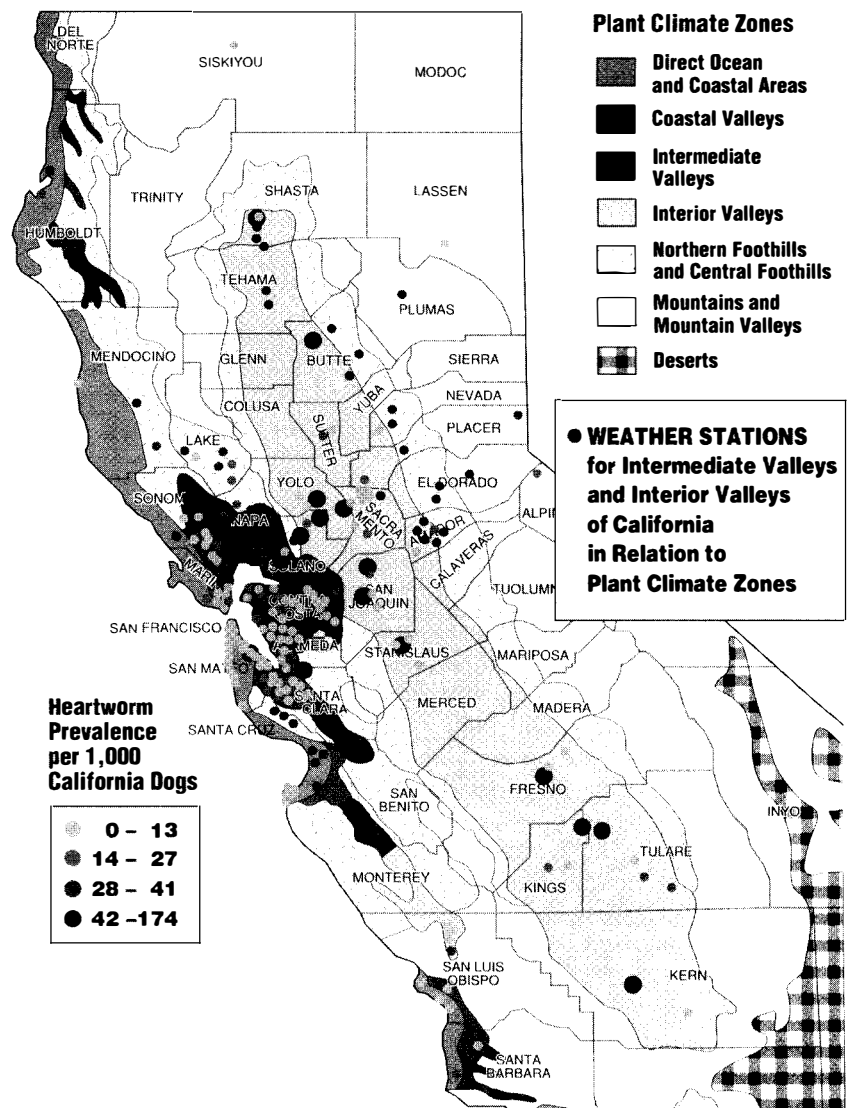

Fig. 7.3 Prevalence of canine heartworm in California. (From Theis *et al.*, 1998.)

such as night enclosures and watering points, become heavily contaminated with microorganisms that are responsible for septicaemias in neonatal kids and lambs in some African pastoral systems. The high prevalence of brucellosis among livestock kept on rangelands may be associated with difficulties in the adequate disposal of aborted fetuses. Pre-weaning and post-weaning mortality rates are therefore often high: in sheep and goats reared extensively on tropical rangelands in Africa, India and Australia they often exceed 30%.

## Regulation of population size

### The 'balance of nature'

The early biologists were impressed by the stability of animal and plant populations. Populations grow, reach a certain size, and then stop growing. The population becomes stable and **balanced**, with the rate of reproduction equalling the death rate.

### Control of population size by competition

Two hypotheses have been formulated to explain the balance of nature. Chapman (1928) argued that there was **environmental resistance**. Animal populations had an intrinsic rate of increase but there was some quality of the environment that resisted the increase. This theory may be good but there is no evidence to support it. The currently accepted theory is that populations are brought into balance by **competition** for the resources of the habitat, the most common of which is food. Competition therefore is **density-dependent**.

In order to test this hypothesis it is necessary to conduct an experiment with food supply controlled. Such an experiment was conducted by Gause (1934), using one species of *Paramecium* with a constant supply of food. The growth curve for this protozoon is a sigmoid (Figure 7.4) that approximates to a mathematical equation, called the **logistic equation** (see also Chapter 15).

The logistic equation is derived thus: if  $R$  = observed rate of increase,  $r$  = intrinsic rate of increase,  $N$  = number of animals, then, for the slope of the curve:

$$R = rN.$$

If  $K$  = saturation number, then, with increasing competition, when  $N = K$ ,  $R = 0$ .

The complete history of the sigmoid curve is:

$$R = rN \left( 1 - \frac{N}{K} \right).$$

Early in growth, when growth is rapid because much food is available,  $N$  is small; therefore the quotient  $N/K$  is small:

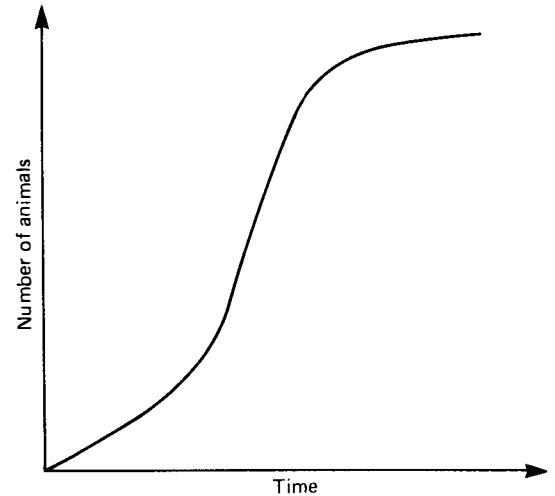

Fig. 7.4 The sigmoid growth curve for a simple population in a confined space with limited input of energy.

$$1 - \frac{N}{K} \text{ approaches } 1$$

and  $R$  approaches  $rN$ .

Later, as growth decreases (because less food is available):

$$\frac{N}{K} \text{ approaches } \frac{K}{K} = 1$$

Thus  $1 - \frac{N}{K}$  approaches 0.

Thus  $R = rN \times 0$   
 $= 0$ .

Further laboratory studies, for example with the fruit fly *Drosophila*, supported the hypothesis of density-dependent competition for food. Parasite populations may also be regulated by this mechanism. Reproduction of *Ascaris* spp., for example, is density-dependent (Croll *et al.*, 1982). However, experiments with other insects, notably the flour beetle, showed that density-dependent factors other than food availability may control the size of populations, for instance the build-up of metabolic excretory products, and decreased reproduction due to crowding. Thus, the competition model is a useful theoretical concept that has aided understanding of regulatory<sup>3</sup> mechanisms, but in the real world density dependence is rarely the result of just a single factor: various factors may operate at different times to control population size.

<sup>3</sup> 'Population regulation' and the 'balance of nature' are synecdoches, which imply that there is active control with a particular purpose. However, both terms are used by ecologists simply to describe the processes that affect population dynamics – no purpose is required.

## Dispersal

In some parts of the world, there may be dramatic seasonal variations in climate. An Australian species of grasshopper overwinters in its egg. The warmth of spring causes the eggs to hatch. The adults that develop then lay eggs as long as the weather is wet. A drought kills all of the adults. This is not density dependent; it occurs long before competition occurs. Such insects survive only by **dispersal** over large areas to different climates so that at least some are in an area that is wet. This phenomenon led Andrewartha and Birch (1954) to suggest that large animals too were controlled by climate, not competition for food. They emphasized the dangers of oversimplification using the logistic model.

## Predation

Predation has an obvious plausible role in controlling the size of populations, but most of the evidence suggests that this is not true for large animals because predators take only the sick and weak and young animals. Since the latter probably would not die otherwise (a small number of deaths may occur, for example by drowning during migration), predation could have some effect on population size. There is, however, contradictory evidence. In the Serengeti of Africa there are about 200 000 wildebeests, but lions kill only 12 000–18 000 each year, an insignificant number, and mostly of newborn animals that become lost.

However, small predators, notably of insects, are efficient controllers of populations. Predators have been used to control insect pests; for example, the use of ladybirds to control cotton cushiony-scale insects.

## Infectious disease

Pandemics with high case fatality rates, such as the Black Death and rinderpest (see Chapter 4) clearly have a severe impact on populations. However, considerable interest is developing in the role of infectious disease in determining and regulating the size of populations more generally (Anderson and May, 1986, 1991). There is circumstantial evidence, for instance, that the approximate decadal fluctuations in populations of forest-dwelling Lepidoptera are caused by epidemics of disease (Myers, 1988), and there may be similar effects in vertebrate populations. The fungus, *Batrachochytrium dendrobatidis*, for example, probably caused population decline in rainforest-dwelling frogs in Australia and Panama (Berger *et al.*, 1999). Intentional release of rabbit haemorrhagic disease virus appears to be an effective method of controlling rabbit populations (Sanson *et al.*, 2000), and myxomatosis appears to have a regulatory effect, too (Ross *et al.*, 1989). Moreover, infections are a major risk to endan-

gered species (McCallum and Dobson, 1995) when they 'spill over' from other species, canine distemper virus, for example, killing over 70% of the last remaining free-living colony of black-footed ferrets (Table 6.4).

Infectious agents can be divided into two groups according to their generation dynamics: **microparasites** and **macroparasites** (May and Anderson, 1979); this is a useful classification when considering the effects of parasites on host populations. The microparasites multiply directly when inside the hosts, increasing the level of parasitism. They include viruses, bacteria and protozoa. Macroparasites, in contrast, do not increase the level of parasitism: they *grow* in the host, but multiply by producing infective stages which are released from the host to infect new hosts. They include helminths and arthropods.

Microparasitic infections can obviously depress host population size when they occur as epidemics or pandemics with high case fatality rates. Such effects are usually transient, but they do indicate a potential for more general regulation of the host population akin to that of predators.

The intrinsic growth rate of a population must be influenced by parasites if they are to regulate population size. This rate is governed by host survival and reproductive capacity. Microparasites are frequently pathogenic organisms of high virulence. Their obvious regulatory potential therefore lies in their capacity to kill hosts, but they may also have less direct effects such as inducing susceptibility to opportunistic infections and rendering infected hosts 'less competitive' than their peers.

There are certain experimentally and theoretically identified conditions under which microparasites can regulate host population size (Anderson, 1981). Disease-induced mortality must be high compared with the disease-free rate of growth. The influence of high pathogenicity and virulence, however, is often moderated by a short period of infectiousness because fewer individuals are likely to be infected. Moreover, enduring immunity in recovered individuals prevents recurrence of disease. These last two factors therefore mitigate the regulatory effects of virus and bacterial infections in vertebrates. (Invertebrates cannot develop acquired immunity, and the capacity of pathogenic bacteria and viruses to regulate invertebrate populations is generally acknowledged.) Early epidemiological studies indicated that AIDS may be able to reverse positive population growth (Anderson and May, 1988), and recent evidence supports this (Whiteside, 1998; Barnett and Whiteside, 2002). Characteristics of the infection that contribute to this effect are the virus's high pathogenicity, the lack of an immune response in the host (and, consequently, the invariably fatal outcome of the disease), the long period of infectiousness, and vertical transmission.



**Table 7.2** The average parasite burdens of North American mammals.\* (From Dobson *et al.*, 1992.)

	Mean burden per individual host	Mean number of species per host population
Trematodes	108	1.8
Cestodes	140	2.8
Nematodes	117	5.3
Acanthocephalans	1	0.3
Number of parasite species	3	10

\* The data are from 76 populations of mammals comprising 10 species of lagomorphs, 22 species of rodents, 35 species of carnivores and 11 species of artiodactyls. Carnivores generally had the most diverse range of parasites, and lagomorphs the least. Gregarious species had the highest mean parasite burdens.

Infections with macroparasites, particularly helminths, are ubiquitous in the animal kingdom (Table 7.2). Therefore, they could have a widespread regulatory effect on animal populations, although the effect may not be as overt as those induced by microparasites. Helminths not only significantly decrease an animal's growth rate, but also can reduce host survival and reproductive capacity. For example, sheep mortality is related to intensity of infection with *Fasciola hepatica* (Smith, 1984); and red grouse infected with *Trichostrongylus tenuis* produce smaller clutch sizes than uninfected birds (Hudson, 1986).

Infections may also act more subtly, for example, by increasing a host's susceptibility to predation (Anderson, 1979). Thus, cormorants capture a disproportionately large number of roach infected with the tapeworm, *Ligula intestinalis*, compared with the prevalence of infected fish in the population as a whole (Dobben, 1952).

Microparasites and macroparasites have been identified as suitable candidates for the control of rats, dogs, cats and goats that are introduced to oceanic islands; parasitic nematodes and viruses of low to intermediate pathogenicity being the most appropriate (Dobson, 1988). It has also been postulated that microparasites might be used less directly to control vertebrate pest populations by being genetically engineered to express genes encoding gamete proteins, thus 'immuno-sterilizing' the pests (Tyndale-Biscoe, 1994).

The population dynamics of microparasites are discussed by Nokes (1992) and Bulmer (1994). Dobson *et al.* (1992) discuss macroparasites.

### Home range

Certain animals have a natural restriction to the area over which they roam; this is their **home range**. For example, arctic birds have a larger home range

when food is scarce than when it is plentiful. This may control the population, and has implications for the transmission of infectious disease; infected animals may transmit infection over their home range, but no further. For example, rats are the maintenance hosts of the rickettsial disease scrub typhus. Trombiculid mites (chiggers) are the vectors; they parasitize mammals and birds. The small home range of the rats results in the mite's life-cycle being restricted to small areas, called 'mite islands' (Audy, 1961). When the mites are infected with the rickettsia, localized endemic areas of scrub typhus, associated with the mite islands, occur. Extension of the infection occurs only by dispersal of infected mites by wider-ranging incidental hosts such as birds and man, in whom the infection causes serious disease.

### Territoriality

The part of an animal's home range that it defends aggressively from invaders is the animal's **territory**. This behavioural response is **territoriality**, and is particularly conspicuous in birds. This has an advantage, economizing movement when searching for food. Territoriality may also control the population because there is a minimum size to a territory and a finite amount of space, and therefore a finite number of animals that can exist in the territory. The conditions that favour territoriality over non-territorial organization may depend on the 'economics' of the strategy (Brown, 1964). If a resource (food) is scarce, widely dispersed, or subject to seasonal fluctuation, then it may be too costly to defend by territorial behaviour. These factors interact to determine optimum territorial size (Carpenter *et al.*, 1983).

### Social dominance

In the 1920s, a social hierarchy called the 'peck order' was discovered among birds. Some gregarious species, especially rodents, inhabit favourable places. When crowding occurs, the socially weaker animals are forced out. This may be a population control mechanism.

### The 'Wynne-Edwards' hypothesis

The population-control consequence of territoriality, social hierarchy and behaviour may be just a side-effect. The Aberdeen zoologist, Wynne-Edwards, suggested that population control was the main purpose of **group behaviour** (Wynne-Edwards, 1962), which sometimes causes physiological stress (see Chapter 5). The crowding of rats results in associated fighting, cannibalism and reduced fecundity. Such experimentally stressed animals, and those that are naturally stressed (e.g., sewer-dwelling rats), have hypertrophied

adrenals, indicative of the general adaptation syndrome (see Chapter 5).

At certain times of the year animals congregate, although there are no obvious spatial restrictions (e.g., deer during the rutting season). Wynne-Edwards suggested that this 'head count' of the population evoked, by feedback, the general adaptation syndrome and controlled reproduction. There are two problems with this theory: evolution tends to select individuals, not groups, and the hypothesis suggests that birth-controllers are favoured, whereas evolution usually selects the efficient producers. This theory is not fashionable today.

For whatever reason animals congregate, the increased contact can aid transmission of infectious agents, and can produce seasonal trends in disease occurrence (see Chapter 8). Thus, when North American leopard frogs congregate to spawn during the winter, there is seasonal transmission of Lucké's frog virus (McKinnell and Ellis, 1972).

It is difficult to produce a general theory of population control. Food availability is important, and energy availability limits the supportable biomass (see 'The distribution of energy between trophic levels' below). Infectious disease also may have a role.

However, different mechanisms probably operate in different circumstances.

### The implications for disease occurrence of the distribution and control of populations

The distribution, the home range of animals, and other behavioural activities of hosts of infectious agents affect the latter's transmission. An example is vulpine rabies. The infection is maintained in Europe in foxes (Wachendörfer and Frost, 1992). The behaviour of foxes during the year alters the association between foxes. The animals may be solitary, paired, or part of a family unit. Similarly, rabid foxes' behaviour depends on the type of rabies that they display; foxes with dumb rabies may seek a solitary existence, whereas furious rabies may cause foxes to approach other animals readily. Figure 7.5 illustrates how these different behaviour patterns affect the survival and spread of rabies virus between animals.

Increases in home range also may increase spread of infection. Thus, during the summer months, rabies may be confined to foxes in the northern tundra and forests of Canada, but in winter, as food supplies become scarce, infected foxes may invade more southerly regions and introduce rabies to such areas.

### The niche

Gause's work with *Paramecium*, mentioned earlier in

		Grouping of foxes				
		Solitary	Pair	Family	Social groups	Mixed society
Behaviour of rabid foxes	Dumb	□□□□	▼	▼▼	▼▼▼	▼▼
	Furious	▼	▼▼	▼▼▼	▼▼▼▼	▼▼▼
	Mixed	▼	▼▼	▼▼▼▼	▼▼▼▼	▼▼▼▼

Fig. 7.5 Social group behaviour and behaviour of rabid foxes as determinants of rabies in foxes. □: Conditions unfavourable for existence of rabies virus; number of squares indicates the relative degree to which conditions are unfavourable. ▼: Conditions favourable for the existence of rabies virus, number of triangles indicates the relative degree to which conditions are favourable. (From Macdonald and Bacon, 1980.)

this chapter, is an example of **intraspecific competition**, that is, competition between members of the same species. **Interspecific** competition also can occur when two species live together, in which circumstance they either might both thrive, or one may be exterminated by the other.

The solving, simultaneously (in the mathematical sense), of the logistic equation for each species to find the relative size of each population produces pairs of equations that were derived independently in the US by Lotka (1925) and in Italy by Volterra (Chapman, 1931). These equations are therefore called **Lotka-Volterra** equations. They can be derived for varying degrees of competition. The conclusion drawn from these equations is of fundamental importance in ecology. It is that *the coexistence of two strongly competing species is impossible*. Coexistence is possible only if competition is weak. This was tested, again by Gause, using two different species of *Paramecium* in a test-tube culture. He found that either one or the other species triumphed, depending on the composition of the environment. This led to the principle of **competitive exclusion**: that competition will exclude all but one species from a particular position defined by an animal's feeding habits, physiology, mechanical abilities and behaviour. This position is an animal's **niche** (Elton, 1927). The principle of competitive exclusion can therefore be summarized as 'one species, one niche'. (This implies that Charles Darwin's original concept of the survival of animals most suited to their environment, as a result of competition, should be modified to one of survival by the avoidance of competition.)

There are examples of competition leading to exclusion in the world as a result of strong competition, although they are few. Probably the best-documented

one is of the Abington turtles. Abington is an island in the South Atlantic that had an indigenous species of turtle. During the 19th century, sailors introduced goats to the island. The goats had exactly the same requirements as the turtles for food. Therefore there was strong competition, which led to the extinction of one of the species, in this case the turtles, according to the Lotka–Volterra prediction. Competitive exclusion is known to operate among virus infections at the cellular level (Domingo *et al.*, 1999).

Competitive exclusion has been used as a means of disease control. The snail, *Biomphalaria glabrata*, which is an intermediate host for schistosomiasis, has been replaced by the more competitive snail *Marisa cornuarietis*, which is not an intermediate host for the helminth (Lord, 1983). *Marisa cornuarietis* is reared and then released into streams and ponds, which are the habitat of *B. glabrata*. *Marisa cornuarietis* dominates within a few months of its release, and *B. glabrata* virtually disappears. It also offers prospects for control of *Salmonella* and *Campylobacter* spp. and *Escherichia coli* infections in poultry (Mead, 2000) and *E. coli* infections in pigs (Genovese *et al.*, 2000) (also see Chapter 22). There is also evidence that coyotes exclude red foxes from their domestic family territories (Voigt and Earle, 1983; Sargeant *et al.*, 1987; Harrison *et al.*, 1989), and it has therefore been suggested that such interspecific competition could be used to control the vulpine vector of rabies, and therefore the disease (Kappeler, 1992).

However, the ‘real world’ is very diverse and there are many opportunities for animals to avoid competition by finding their own niche. Sometimes the mechanism of avoidance is not obvious; for example, marine zooplankton are all filter feeders but actually filter particles of different sizes and therefore do not compete.

Avoidance of competition is usual in **sympatric species**, that is, species found in the same country or area. Giraffe, Thompson’s gazelles and wildebeests are sympatric species in East Africa. They avoid competition for food: the giraffe, with its long neck, feeds high up; the gazelle and wildebeest, although of similar stature, eat differently: the gazelle eats ground-hugging leaves, while the wildebeest eats side shoots.

There are two sympatric species of cormorant in England: the common cormorant and the shag. Both species look alike, occupy the same stretches of shore, are submarine feeders, nest on cliffs, and are fairly abundant. They appear to occupy the same niche, but do not. The common cormorant has a mixed diet, but excluding sand eels and sprats. It fishes out to sea and nests high on cliffs on broad ledges. The shag, in contrast, eats mostly sand eels and sprats, fishes in the shallows, and nests low on cliffs or on shallow ledges.

There are many other examples of sympatric species occupying different niches, ranging from cone shells

that occupy different sublittoral zones, to warblers that occupy different parts of the same tree. Short-lived animals, for example insects, can occupy the same niche and avoid competition by pursuing their activities during different seasons.

Disease can affect relationships between sympatric species when avoidance of competition does not occur (De Leo *et al.*, 2002). Parasites can indirectly tip the balance of competition and allow one host species to exclude another from a potentially sympatric range. Thus, the meningeal helminth parasite, *Parelaphostrongylus tenuis*, has prevented moose and caribou from becoming established in areas in the Eastern US, easing competition for white-tailed deer (Schmitz and Nudds, 1993).

Although competition may be avoided by sympatric species, their inevitably close proximity can provide the opportunity for transmission of infection between them; these may include endangered species, whose populations may consequently decline (Table 7.3).

Gause noted a laboratory example of the development of a mechanism to avoid competition. During an experiment with two species of *Paramecium*, he noticed that both species survived in the same test tube because one species had changed its mode of living to inhabit only the top half of the test tube, while the other species had moved to the bottom of the tube, thus avoiding competition. This process was explained first by Darwin when he developed the concept of **divergence of character**: characters must diverge when closely related species live in the same region, be it test tube or prairie. The synonymous term **character displacement** was first used in the 1950s.

One would expect displacement to be more common than exclusion because the world offers many ways of subtly changing niches. Displacement is also a mechanism of increasing species diversity. One example illustrates this phenomenon. Two species of nuthatch occur in Greece, Turkey and other parts of Asia: *Sitta neumayer* and *Sitta tephronota*. The external appearance of *S. neumayer* in Greece, and *S. tephronota* in Central Asia, where the species do not overlap, is similar. However, in Iran, where the two species overlap and coexist, the external appearance of each species is different. This external divergence of characters probably reflects other changes that avoid competition.

## Some examples of niches relating to disease

### Louse infestations

Lice tend to be host-species-specific; pig lice do not live on man or dogs, and vice versa. By being host-specific, species of lice avoid competition: they have their own niche. The human louse also demonstrates character

**Table 7.3** Infections transmitted from more common sympatric populations that have caused population declines in threatened mammals. (Modified from Cleaveland *et al.* (2002) The role of pathogens in biological conservation. In: *The Ecology of Wildlife Diseases*, Edited by Hudson, P.J. *et al.* By permission of Oxford University Press.)

Threatened host	Infection	Reservoir host	References
Ethiopian wolf	Rabies, canine distemper virus	Domestic dogs	Sillero-Zubiri <i>et al.</i> (1996); Laurenson <i>et al.</i> (1998)
African wild dog	Rabies, canine distemper virus	Domestic dogs	Alexander <i>et al.</i> (1993, 1996); Gascoyne <i>et al.</i> (1993); Alexander and Appel (1994); Kat <i>et al.</i> (1995)
Baikal seal	Canine distemper virus	Domestic dogs	Mamaev <i>et al.</i> (1995)
Caspian seal	Canine distemper virus	Possibly terrestrial carnivores	Forsyth <i>et al.</i> (1998)
Black-footed ferret	Canine distemper virus	Various wild carnivores	Williams <i>et al.</i> (1988)
Arctic foxes	Otodectic mange	Domestic dogs	Goltsman <i>et al.</i> (1996)
Chimpanzee	Polio	People	Van Lawick-Goodall (1971)
Bighorn sheep	<i>Pasteurella</i> spp.	Domestic sheep	Foreyt and Jessup (1982); Foreyt (1989)
Chamois	Infectious keratoconjunctivitis	Domestic sheep	Degiorgis <i>et al.</i> (2000)
Monk seal	Morbillivirus	Possibly dolphins	Osterhaus <i>et al.</i> (1998)
Mountain gorilla	Measles	People	Hastings <i>et al.</i> (1991)
Rainforest toads	Chytridiomycosis	Cane toads	Berger <i>et al.</i> (1998)

displacement. Two types of louse live on man: the head louse and the body louse. These each parasitize the two different parts of the body, rather like Gause's two species of *Paramecium* living in the top and the bottom of the test tube.

### Internal parasitism

An animal comprises a connected set of organ systems, which are potential niches for many internal parasites with complex life-cycles. The **fundamental niche** is the range of sites that can be occupied by a parasite; whereas **realized niches** are the sites that are actually occupied (Poulin, 1998). Realised niches may be the optimal sites of a parasite within the fundamental niche, if competition with other species does not occur. Alternatively, if there is potential competition, realized niches may be those that are occupied to avoid competition, and such 'interactive site segregation' (Holmes, 1973) is known to occur. For example, several species of helminth parasitize the intestine of grebes, but, on average, occupy different sites along the length of the intestine (Figure 7.6).

### Intracellular parasitism

Intracellular parasites comprise all viruses, some bacteria (e.g., *Brucella* spp., *Mycobacterium tuberculosis*, and *Rickettsia*, *Ehrlichia*, *Coxiella* and *Chlamydia* spp.) and some protozoa (e.g., *Babesia* spp.). They occupy a variety of niches in cells, including the cytoplasm,

endosomes, lysosomes and vesicles. There are several advantages to this type of existence, such as safety from humoral antibodies and the avoidance of competition with extracellular agents. The intracellular environment, however, is harsh; this is reflected in the relatively low generation times of intracellular parasites compared with extracellular ones. The intracellular environment shares this characteristic with larger extreme environments such as snowfields and salt lakes (Table 7.4).

Intracellular parasites therefore have evolved diverse mechanisms for evading the host's cellular defences

**Table 7.4** Comparison of the intracellular environment with terrestrial extreme climates. (After Moulder, 1974.)

	Terrestrial extreme environments (e.g. deserts, salt lakes, hot springs, snowfields)	The cell
Diversity of inhabiting species is low	+	+
Dominant forms have evolved unique fitness traits	+	+
Dominant forms dependent on species diversity limiting factors	Factor is <b>abiotic</b> , e.g. heat, salinity, dryness	Factor is <b>biotic</b> : the cell

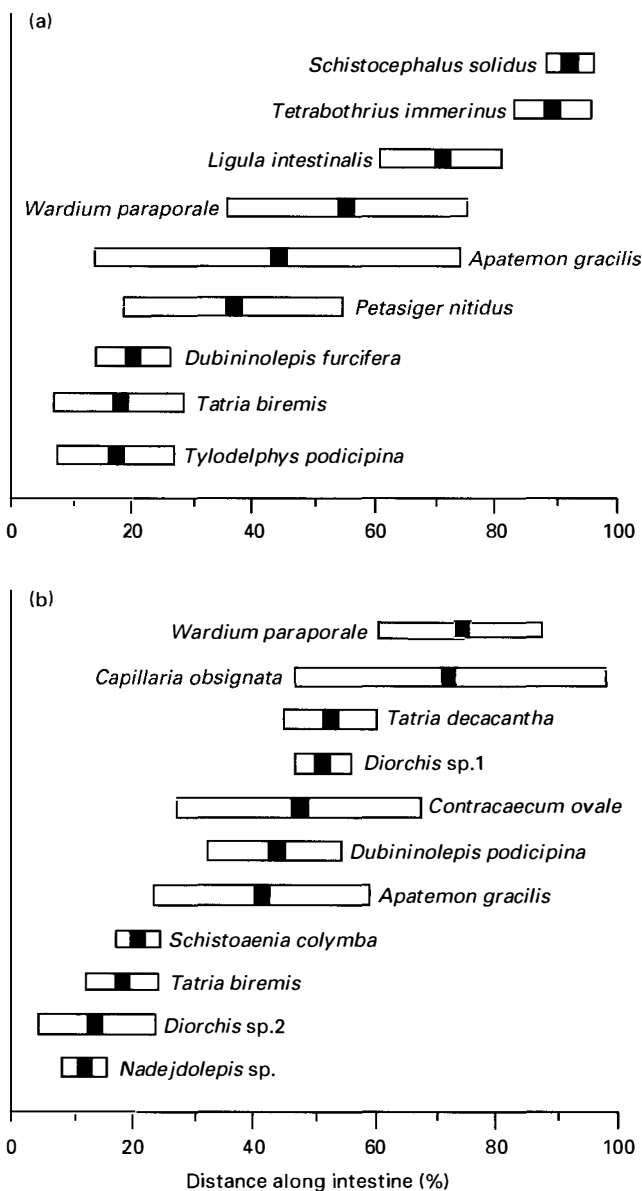

**Fig. 7.6** Distribution of intestinal helminth parasites in two species of grebes (a) *Aechmophorus occidentalis*, and (b) *Podiceps nigricollis*. ■: Mean; □: standard deviation. (From Poulin, 1998; data from Stock and Holmes, 1988.)

(Hackstadt, 1998). These include rapid escape from phagocytic vacuoles (*Rickettsia* spp.), blocking of maturation of endosomes (*Mycobacterium* and *Ehrlichia* spp.) and adaptation to lysosomal conditions (*Coxiella* spp.).

### Epidemiological interference

Studies in India (Bang, 1975) have shown that the presence, in a human community, of one type of respiratory adenovirus prevents infection with other types, even though the latter are common in surrounding communities. This is because the first type occupies a

niche (the lower respiratory tract), which therefore cannot be filled by other agents. This phenomenon is **epidemiological interference**.

Similarly, there is evidence that infection of laboratory animals and domestic livestock with one serodeme (a population demonstrating the same range of variable antigens: WHO, 1978) of *Trypanosoma congolense* delays the establishment of infection with a different serodeme in the same animals (Dwinger *et al.*, 1986).

Interference can affect the time of occurrence of disease. An epidemic caused by one agent may suppress epidemics caused by other similar agents. This is true of certain human respiratory infections in North America and India (Bang, 1975) and measles and whooping cough (Rohani *et al.*, 2003). Some diseases are common in the young. Interference by other agents during early life causes the diseases of the young to occur in older age cohorts, altering the age-specific incidence rates. There is evidence that this occurs with certain virus infections in man (Bang, 1975).

Interference can also affect the rate of natural immunization. If an infectious agent is present at continued high levels, and infection is followed by immunity, then there is usually a decreased incidence in older age groups. However, if other agents interfere with the agent in the young, then immunity induced by the agent is delayed, producing continued infection in older subjects. There is evidence, for example, that interference by other enteroviruses delays natural poliovirus immunization in man (Bang, 1975).

Epidemiological interference may be a general phenomenon. The delay in its discovery is probably due to the lack of long-term surveys on the incidence of infections. The phenomenon has an obvious place in the evolution of disease: it prevents massive multiple and possibly fatal infections of the young. An example of the application of epidemiological interference to the control of enteric diseases is given in Chapter 22.

### The relationships between different types of animals and plants

A particular biome contains different types of animals and plants. Some are common, others are scarce. Some are large, others are small. Reasons for these variations have been suggested by ecological studies.

Animals tend to move about *en masse*, and so it is difficult to study them all simultaneously. Ecologists therefore chose to look in detail at one species of animal, in conditions that favoured easy observation. Charles Elton (1927) visited Bear Island near Spitzbergen and observed Arctic foxes, with particular reference to what they ate. Bear Island was essentially a tundra biome, thus foxes were easy to observe.

## Food chains

Elton noted what the foxes ate in the summer and the winter. In the summer, the foxes ate birds (e.g., ptarmigan and sandpiper). The birds ate berries, tundra, leaves and insects. The insects also ate leaves. Thus, Elton noted that there was a **food chain**: tundra–insects–birds–fox. In addition, the foxes ate marine birds, which in turn ate smaller marine animals, which in turn ate marine plants. Thus, there was a further food chain: marine plants–marine animals–seabirds–fox.

In the winter, the birds migrated to the south, leaving only polar bear dung and the remains of carcasses of seals that had been killed by polar bears. Thus, in the winter, there was a different food chain: marine animal–seal–polar bear dung–fox. In animal communities, therefore, a complex system has evolved, with food chains linking animals.

## The size of animals and food webs

Elton observed that animals fed at different levels in the food chain. These levels he termed **trophic levels**. He also noted that animals occupying different trophic levels generally were of different sizes. The foxes were the largest, and the birds (one level down) were smaller. Similarly, those further down the pyramid (e.g., the insects) were even smaller. Also, moving down the food chain (e.g., from foxes to insects), the animals were **more abundant**. There were more birds than foxes, and more insects than birds. A histogram depicting animal size against number of individuals is shown in *Figure 7.7a*. If the vertical axis of the

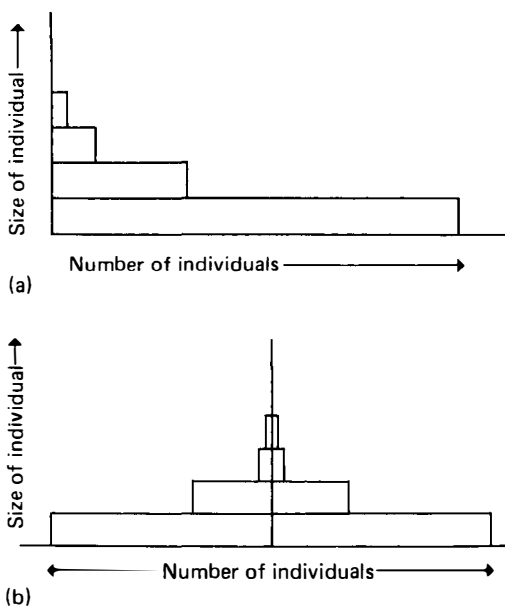

**Fig. 7.7** (a) The relationship between size of animals and size of populations; (b) the Eltonian 'pyramid of numbers'.

histogram is moved to the centre, and the bars are arranged symmetrically, a pyramid is produced (*Figure 7.7b*); this is the Eltonian **pyramid of numbers**. As animals become larger and rarer, they have larger home ranges and therefore, if shedding an infectious agent, transmit infections over larger areas than small animals. Thus, although hedgehogs (relatively small animals) can be infected with foot-and-mouth disease virus (McLaughlan and Henderson, 1947), they have relatively small home ranges, and so probably play only a minor role in the dissemination of the virus during epidemics.

The food chain is a simplistic view of the relationship between an animal and its food. In reality, an animal usually eats a variety of food, and so there are generally many linked food chains radiating outwards from the lower plant trophic levels to the herbivores, and then inwards towards the top carnivores, producing **food webs** (*Figure 7.8*). In addition, parasitic food webs can be identified in which the small parasites occupy a level in the food web higher than the organisms that they parasitize<sup>4</sup>.

Although early ecological studies highlighted the complexity of food webs, recent studies suggest that all webs follow relatively simple rules, involving such characteristics as the length of the food chain, similarities between trophic levels, and 'connectance'<sup>5</sup> (Williams and Martinez, 2000).

An animal's feeding habits and its place in the trophic hierarchy place restrictions on its mode of life; this led Elton to define the niche: 'an animal's place in the biotic environment; its relation to food and enemies'.

## The significance of food webs to disease transmission

The food web of an animal can determine to which orally transmitted infectious agents an animal acts as host, and from which food poisoning toxins it is at risk. Predators, for instance, risk being infected with microbes ingested with infected food. For example, captive raptors (some of which are endangered species) can be fatally infected with viruses through consumption of food of avian origin (Forbes *et al.*, 1997; Rideout *et al.*, 1997). It has therefore been suggested that captive raptors that are likely to be released into

<sup>4</sup> There are also complex marine food webs involving parasites (Poulin and Chappell, 2002).

<sup>5</sup> 'Connectance' or 'connectivity' refers to the extent to which the different components of the web interact. It is part of the wider issue of the structure of **networks**, which pervades modern science (e.g., power grids, the Internet, and cellular and metabolic pathways: Strogatz, 2001). Connectivity is also of relevance to disease spread, where the degree of contact between populations of susceptible animals is an important determinant of disease transmission (May and Lloyd, 2001; Webb and Sauter-Louis, 2002; Christley and French, 2003; Weber *et al.*, 2004).

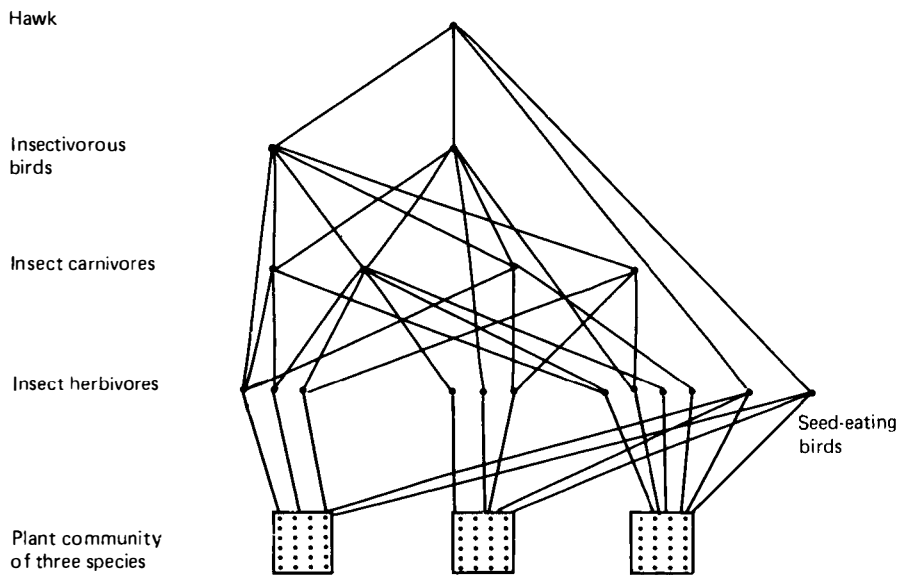

**Fig. 7.8** Hypothetical food web involving carnivorous, insectivorous and herbivorous birds, carnivorous and herbivorous insects, and plants.

the wild should be fed with rodents, rabbits and other small mammals – rather than chickens – to reduce the risk of released birds transmitting infection to wild populations (Höffle *et al.*, 2002).

Helminth diseases, for which there are definitive and intermediate hosts, are frequently transmitted via food webs. For example, the tapeworm *Echinococcus granulosus* includes the sheep as an intermediate host and the dog as the definitive host. The cysts in the liver and lungs of the intermediate host are transmitted to dogs when the latter eat sheep offal; hence the recommendations that raw sheep offal should not be fed to dogs.

Figure 7.9 illustrates the complex life-cycle of *Neorickettsia helminthoeca*<sup>6</sup>. This rickettsia produces a febrile disease in dogs and foxes. The disease is called 'salmon poisoning' because it is associated with the feeding of salmon to dogs. This agent's life-cycle also illustrates a parasitic food chain, in which the smallest member, the rickettsia, parasitizes a fluke which in turn parasitizes a snail for part of its life-cycle. The

snail in turn releases infected miracidia which parasitize the salmon. Feeding salmon to dogs transmits the rickettsia to the latter, where the microbe produces clinical disease.

Ingestion of intermediate stages of parasites sometimes may control, rather than transmit, infection. For example, members of the genus *Utricularia* (carnivorous bladderworts) have been shown to ingest cercariae and miracidia of *Schistosoma mansoni* (Gibson and Warren, 1970). It has been suggested (Lord, 1983) that the absence of schistosomiasis from Cuba, which has 17 species of *Utricularia*, may be related to this activity.

Parasitic food chains might also be exploited in the control of other helminth parasites (Waller, 1992). Some bacteria are effective controllers of plant nematode parasites (Tribe, 1980). Predaceous fungi might be used to control nematode parasites of livestock; *Duddingtonia flagrans*, for example, is able to trap and destroy free-living stages of trichostrongylid larvae (Larsen, 1999). Similarly, *Arthrobotrys oligospora*, a predator of infective larvae of the bovine nematode *Ostertagia ostertagi*, has reduced the level of parasitism in cattle when applied to dung pats (Grønvold *et al.*, 1989, 1993), although oral administration has had little benefit yet (Hashmi and Connan, 1989).

### The distribution of energy between trophic levels

Elton's theory explained why animals occupying different trophic levels were of different sizes, but it did not explain why there were so few animals higher up the pyramid. There could be geometric restrictions: more small animals can be packed into a fixed space than larger ones. However, the sea contains few

<sup>6</sup> Complex life-cycles have evolved in wide and distantly related groups of parasitic nematodes (Adamson, 1986). The simplest explanation is that, at first, only single-host cycles in vertebrates occurred, with intermediate hosts (initially, paratenic hosts: see Chapter 6) being added later. Intermediate hosts offer an advantage by protecting the parasite from the environment, and offering it to the host in the food chain (Anderson, 1984). Alternatively, there may be an advantage to the evolution of multiple-host cycles by conferring greater 'fitness' on the parasite when one host is used for food and the other for dispersion (Morand, 1996). This is supported by the greater virulence of helminth parasites in the intermediate host (the food base) than in the definitive host (the mode of dispersion) (Ewald, 1995). Moreover, studies in sympatric species of cestodes, with only the life-cycles – one-host versus two-host – varying, indicate that the two-host species are more abundant than the one-host species (Robert *et al.*, 1988; Morand *et al.*, 1995).

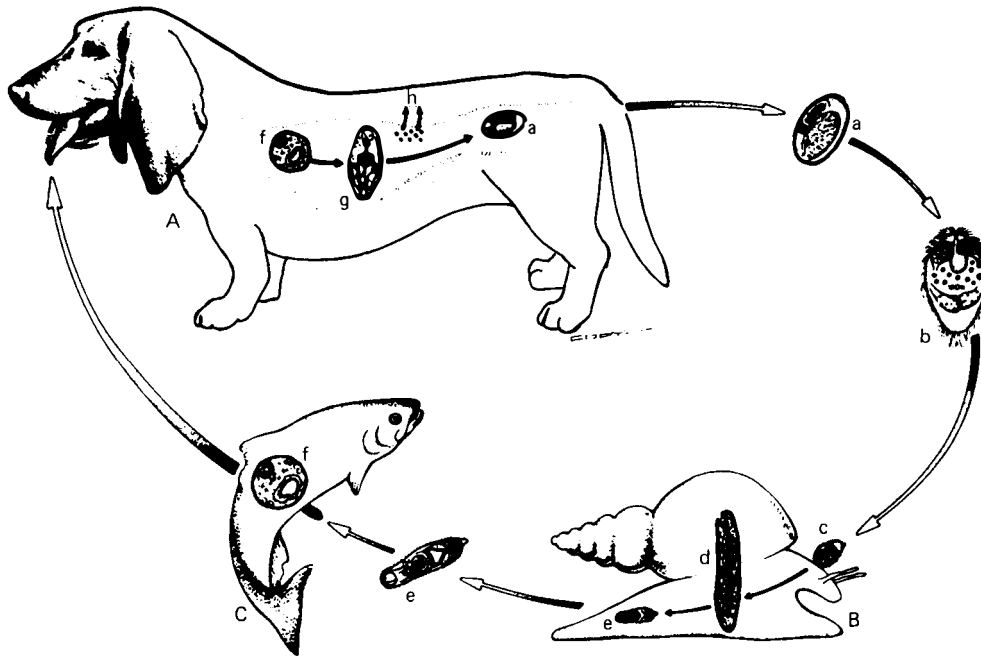

**Fig. 7.9** Life-cycle of the fluke *Nanophyetus salmincola salmincola* and the microorganism *Neorickettsia helminthoeca*. A, Dog (definitive host); B, *Oxytrema silicula* (first intermediate host); C, Salmonidae fish (second intermediate host); a, *Nanophyetus salmincola salmincola* egg in dog faeces; b, miracidium; c, miracidium enters snail by skin penetration; d, redia; e, cercaria; f, encysted metacercaria in salmon, ingested by the dog in raw salmon meat; g, adult fluke develops in duodenal mucosa; h, *Neorickettsia helminthoeca* leave the fluke and infect the dog systemically. (From Booth *et al.*, 1984.)

predators (e.g., sharks) at the top of the pyramid even though the sea is very large.

Lindemann (1942) explained population density at different levels of the pyramid by considering the food chain, not in terms of particulate food, but in terms of **calorific energy flow**. According to the second law of thermodynamics, the process of converting energy from one state to another is wasteful, that is, there is not 100% conversion of energy. Thus, moving up from one level to another in the Eltonian pyramid, conversion at each level wastes energy and so less protoplasm can be supported at progressively higher levels. Therefore, even if animals at different levels were of the same size, there would be fewer higher up. Since those higher up are larger, the packaging of a supportable amount of protoplasm produces even fewer animals.

It is because of the greater availability of energy at lower levels that ungulates are often bigger than their carnivorous predators. The biggest animals tend to be those that feed very low in the pyramid (e.g., filter feeders like blue whales) because much energy is available to them. When civilization dawned and man ceased to be a hunter/gatherer and began cultivating crops, he 'climbed down' the pyramid, tapping more energy. This is one reason for the increase in the world's population in the cradle of civilization in early Egypt and the associated development of horticulture and livestock farming (see Chapter 1).

### The analysis of predation

The association between predator and prey is a special case of interaction in a food chain. Many mathematical models have been devised to analyse predator/prey interactions. The one to be discussed here is that devised independently by Lotka and Volterra (Lotka, 1925; Chapman, 1931). They reasoned that predator/prey interactions were similar to interactions between competing species and so adapted their formulae accordingly.

The three predictions of this model are:

1. the fluctuation of two species, one of which feeds on the other, are periodic, and the periods depend only on the coefficient of growth;
2. the ultimate mean values of the numbers of individuals of the two species are, with fixed coefficients, independent of the initial numbers of individuals;
3. if individuals of the two species are eliminated in proportion to their total number, then the recovery potential of the prey is greater than that of the predator; conversely, increased protection of the prey from all risks, including the predator, allows both species to increase.

Thus, applying the first prediction, the prevalence of rabies in foxes is related to the population density of foxes (a predator) and, therefore, to the population





**Fig. 7.10** The relationship between the population density of mice and the prevalence of fox rabies. The relationship arises from a predator/prey relationship between foxes and mice (see text). (From Sinnecker, 1976.)

density of mice (a prey). *Figure 7.10* illustrates this relationship, using demographic and disease prevalence data collected in Germany.

There are also similarities between predator/prey interactions and parasite/host interactions. For example, cyclic patterns of measles and other childhood diseases (Yorke and London, 1973) are equivalent to Lotka–Volterra cycles because the development of immunity by infected individuals is equivalent, in its effect on parasite populations, to the effects of removal of prey on predator populations.

## Ecosystems

The relationship between animals linked by food chains defines the variety of animals in a particular area. Similarly, climate and vegetation govern the distribution of plants and therefore of the animals that live off them. These areas are characterized by the animals and plants that occupy them, and by their physical and climatic features. This unique interacting complex is called an **ecosystem** (Tansley, 1935). The components of an ecosystem can be considered separately, and ecosystems themselves can vary in size. Various terms have been devised to describe these components (Schwabe, 1984) including **biotope** and **biocenosis**.

## Biotope

A biotope is the smallest spatial unit providing uniform conditions for life. An organism's biotope therefore describes its location. This contrasts with a niche, which describes the functional position of an organism in a community. A biotope can vary in size. For example, it may be the caeca of a chicken for coccidia,

or an area of poorly drained land for *Fasciola hepatica* infection of cattle.

## Biocenosis

A biocenosis is the collection of living organisms in a biotope. The organisms include plants, animals and the microorganisms in the biotope. Sometimes **biotic community** is used synonymously with biocenosis. On other occasions, 'biotic community' refers to a large biocenosis. Major biotic communities are biomes.

## Types of ecosystem

Three types of ecosystem can be identified, according to their origin: **autochthonous**, **anthropurgic** and **synanthropic**.

### Autochthonous ecosystems

'Autochthonous' derives from the Greek adjective *autos*, meaning 'oneself' or 'itself'; the Greek noun *chthon*, meaning 'the earth' or 'the land'; and the adjectival suffix *-ous*, meaning 'deriving from'. Hence an autochthonous ecosystem is one 'coming from the land itself'. Examples are to be found in biomes such as tropical rain forests and deserts.

### Anthropurgic ecosystems

'Anthropurgic' is derived from the Greek noun *anthropos*, meaning 'man': and the Greek verb root *erg*, meaning 'to work at, to create, to produce'. Thus, an anthropurgic ecosystem is one created by man (strictly, it can also mean 'creating man'). Examples are those found in cultivated pastures and towns. Some authors use 'anthropogenic' (Greek: *gen-* = 'be produced') in a similar context.

### Synanthropic ecosystems

'Synanthropic' originates from the Greek preposition *syn*, meaning 'along with, together with'; and the Greek noun *anthropos*, meaning 'man'. Thus, a synanthropic ecosystem is one that is in contact with man. An example is a rubbish tip, harbouring a variety of vermin. It follows that some synanthropic ecosystems, such as rubbish tips, are anthropurgic.

Synanthropic ecosystems facilitate the transmission of zoonotic infections from their lower animal hosts to man. For example, the brown rat, *Rattus norvegicus*, inhabits rubbish dumps and can be inapparently infected with *Leptospira*, serovar *ballum*. Humans in proximity to rubbish dumps that harbour infected rats may therefore be infected with the bacterium.

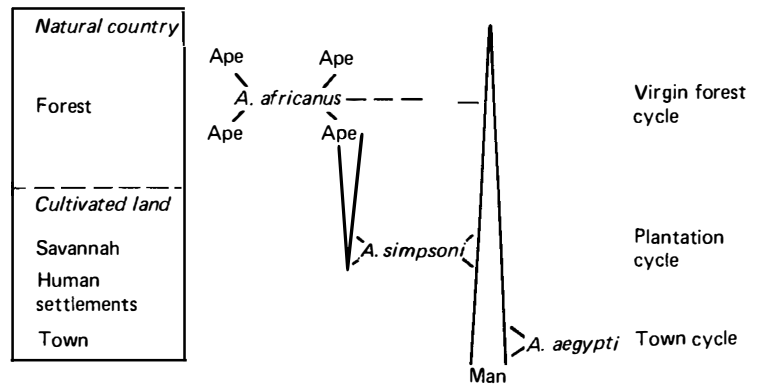

**Fig. 7.11** The transmission of yellow fever between apes (primary hosts) and man (the secondary host). (From Sinnecker, 1976.)

### An ecological climax

An ecological climax traditionally is said to have occurred when plants, animals, microbes, soil and macroclimate (see Chapter 5) have evolved to a stable, balanced relationship<sup>7</sup>.

Characteristically, when infections are present, they too are stable and therefore are usually endemic. Also, the balance between host and parasite usually results in inapparent infections. Such stable situations can be disrupted, frequently by man, resulting in epidemics. For example, bluetongue, a virus disease of sheep, was recognized only after the importation of European breeds of sheep to South Africa towards the end of the 19th century (Neitz, 1948). The virus, however, was present in indigenous sheep before that time, but was part of an ecological climax in which it only produced inapparent infections. The importation of exotic sheep represented a disturbance of the stable climax.

A climax involving endemic infectious agents indicates that all factors for maintenance and transmission of the agent are present. Sometimes changes in local ecology may tip the balance in favour of parasites, thus increasing disease incidence. For example, the seasonal periodicity of foot-and-mouth disease in South America may result from seasonal increases in the size of the susceptible cattle population when animals are brought into an endemic area for fattening (Rosenberg *et al.*, 1980).

### Ecological interfaces

An ecological interface is a junction of two ecosystems. Infectious diseases can be transmitted across these interfaces. An example is the transmission of yellow fever, an arbovirus disease of man. The virus is maintained in apes in Africa in an autochthonous forest

ecosystem in the forest canopy (Figure 7.11). The canopy-dwelling mosquito, *Aedes africanus*, transmits the virus between apes. The mosquito *A. simpsoni* bridges the interface between the autochthonous forest ecosystem and the anthropurgic cultivated savannahs. This mosquito therefore maintains a plantation cycle in which man and apes may be infected. Finally, the urban mosquito, *A. aegypti*, can maintain an urban cycle in man. People who enter forests may also contract the infection from *A. africanus*.

Several diseases can be propagated across the interface between wildlife ecosystems and cultivated land stocked with domesticated animals (Bengis *et al.*, 2002; see also Table 6.9). Sylvatic foci of infection may constitute refractory problems to eradication of disease in livestock (e.g., tuberculosis in badgers: see Chapter 2), as well as increasing the frequency of disease in companion animals (e.g., epidemics of rabies in raccoons related to the increased occurrence of rabies in domestic cats: Gordon *et al.*, 2004).

### Ecological mosaics

An ecological mosaic is a modified patch of vegetation, created by man, within a biome that has reached a climax. Infection may spread from wild animals to man in such circumstances. For example (Schwabe, 1984), the helminth infection, loiasis, is transmitted by arthropods between man, living in small forest clearings, and canopy-dwelling monkeys. Similarly, clearing of the forest canopy encourages a close cover of weeds on the ground, creating conditions that are favourable for the incursion of field rats with mites infected with scrub typhus, which form mite islands and the resulting local areas of endemic scrub typhus (Audy, 1961).

However, transmission does not always occur in the mosaics because suitable vectors may not be available. Thus, in Malaya, man lives unharmed in forests in mosaics with monkeys infected with a variety of species of *Plasmodium* (a protozoon) that are pathogenic to man. Transmission to man from monkeys

<sup>7</sup> In some ecosystems (e.g., tropical rain forests) an ecological climax is determined exclusively by plant/arthropod relationships (Janzen, 1971; Way, 1977).

does not occur because vectors that bite both types of primate are not present in the ecosystem.

## Landscape epidemiology

The study of diseases in relation to the ecosystems in which they are found is **landscape epidemiology**. Terms conveying the same meaning are **medical ecology**, **horizontal epidemiology** (Ferris, 1967) and **medical geography**. Investigations are frequently qualitative, involving the study of the ecological factors that affect the occurrence, maintenance and, in the case of infectious agents, transmission of disease. This contrasts with the study of quantitative associations between specific diseases and hypothesized factors – sometimes termed ‘vertical’ epidemiology – as described in Chapters 14, 15, 18 and 19. Landscape epidemiology was developed by the Russian, Pavlovsky (1964), and later expanded by Audy (1958, 1960, 1962) and Galuzo (1975); it involves application of the ecological concepts described above in the study of disease.

## Nidality

The Russian steppe biome was the home of the great plagues such as rinderpest. Many arthropod-transmitted infections present in the steppes were also limited to distinct geographical areas. These foci were natural homes of these diseases and were called **nidi** (Latin: *nidus* = nest). The presence of a nidus depends

on its limitation to particular ecosystems. An area that has ecological, social and environmental conditions that can support a disease is a **nosogenic territory** (Greek: *noso-* = sickness, disease; *gen-* = to produce, to create). A **nosoarea** is a nosogenic territory in which a particular disease is present. Thus, Britain is a nosogenic territory for rabies and foot-and-mouth disease, but is not a nosoarea for these diseases, because the microbes are prevented from entering the country by quarantine of imported animals. Diseases that show strict geographical boundaries within an ecosystem or series of ecosystems are **nidal** because they are confined to a specific nidus. Salmonellosis is endemic in most parts of the world because virtually all vertebrates and some invertebrates (see *Table 6.8*) can act as hosts for the various species of *Salmonella*. Rabies, when maintained in foxes, is endemic in a large zone around the northern hemisphere because this large area supports a fox population of high density (*Figure 7.12*). The nosoarea for coccidioidomycosis was described earlier in this chapter (see *Figure 7.2*).

When diseases are vector-transmitted, they are often restricted to more precise geographical boundaries than other infectious diseases. This is because the ecosystem has to satisfy the requirements of both the vertebrate host and the arthropod vector. Thus, Rocky Mountain spotted fever, a rickettsial disease of rodents transmitted by ticks, is essentially restricted to particular areas of North America, as the name of the disease suggests.

At the opposite end of the spectrum from diseases with a wide distribution are those that may be confined to relatively small areas within a town or on a

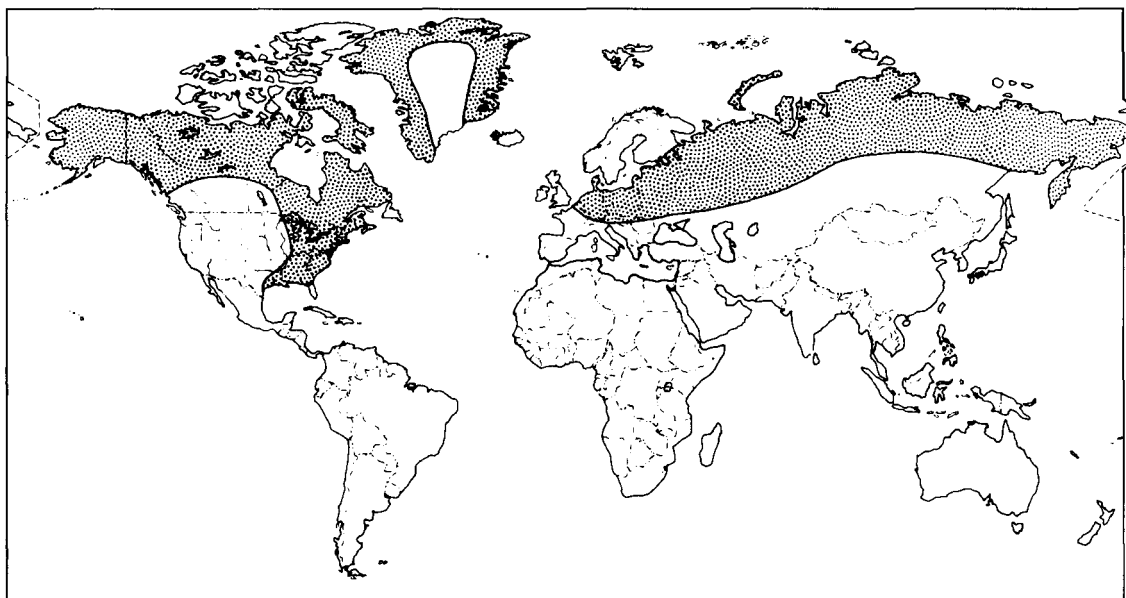

**Fig. 7.12** Nosoarea (shaded) of endemic fox rabies. (From Winkler, 1975.)

**Table 7.5** Probable ecological factors responsible for emerging infectious diseases. (Compiled from Morse, 1995; Williams *et al.*, 2002; and *Trends in Ecology and Evolution*, **10**, Schrag, S.J. and Wiener, P. Emerging infectious diseases: what are the relative roles of ecology and evolution?, pp. 319–324 © (1995), with permission from Elsevier.)

	Factor(s) contributing to emergence
<b>Viruses</b>	
Argentine, Bolivian haemorrhagic fever	Changes in agriculture favouring rodent host
Dengue	Urbanization, factors favouring mosquito hosts
Duck plague	Changes in lake water management
Hantaviruses	Ecological or environmental changes increasing contact with rodent hosts
Influenza (pandemic)	Possibly pig–duck agriculture, facilitating reassortment of avian and mammalian influenza viruses (see Chapter 5)
Lassa fever	Urbanization favouring rodent hosts, increasing exposure (usually in homes)
US, rabies	Illegal translocation of raccoons to new areas
Rift Valley fever	Dam building, agriculture, irrigation; possibly change in virulence or pathogenicity of virus
<b>Bacteria</b>	
Mycoplasmal conjunctivitis of wild finches	Sale and transportation of birds
Lyme disease ( <i>Borrelia burgdorferi</i> )	Reforestation around homes and other conditions favouring tick vector and deer (a secondary reservoir host)
Plague ( <i>Yersinia</i> sp.)	Unsanitary urban environments
<b>Parasites</b>	
Schistosomiasis	Dam building

farm. An isolated clump of trees that is used as a roost by starlings may be the only reservoir of infection for histoplasmosis within a large area. The faeces from these birds provide an ideal environment in which the fungal agent can survive and replicate (Di Salvo and Johnson, 1979). Even smaller nidi can be identified. For example, a focus of infestation with the tropical dog tick, *Rhipicephalus sanguineus*, has been identified in a house in London (Fox and Sykes, 1985), the warm conditions of the house providing a suitable environment for the tick. The affected dog had not been imported from abroad, but probably contracted the infestation from a quarantine kennel where it had been boarded.

Changes in ecosystems stemming from human activity can modify nosogenic patterns substantially, resulting in the emergence of infectious diseases (Table 7.5). These changes represent one class of factor that contributes to the introduction and spread of such infections (Table 7.6).

## Objectives of landscape epidemiology

Landscape epidemiology is founded on the concept that, if the nidality of diseases is based on ecological

factors, then a study of ecosystems enables predictions to be made about the occurrence of disease and facilitates the development of appropriated control strategies. Three examples will illustrate this concept.

### Leptospirosis

It is known that the prevalence of *Leptospira*, serovar *ballum*, in the brown rat is density dependent; an estimation of the number of rats inhabiting an area enables a prediction of the prevalence of serovar *ballum* infections to be made (Blackmore and Hathaway, 1980: Figure 7.13). The number of rat burrows in an area is a good indicator of the number of rats, and these burrows are seldom more than 100 m from the major feeding ground, and are seldom more than 40 cm deep (Pisano and Storer, 1948). Thus, if inspection of the area reveals a large number of burrows and evidence of recent rat activity, it is likely that the area constitutes a reservoir of infection for serovar *ballum*. Conversely, if the rubbish dump is well managed and the area surrounding it shows evidence of regular bulldozing and few inhabited burrows, then the rat population is likely to be small, and any rats present are unlikely to constitute a maintenance population for this leptospiral serovar.

**Table 7.6** Probable factors for the emergence of some infectious diseases. (Compiled from Morse, 1995; Whittington, 2003.)

Factor	Examples of specific factors	Examples of diseases
Ecological changes (including those due to economic development and land use)	Agriculture; dams, changes in water ecosystems; deforestation/reforestation; flood/drought; famine; climate changes	Schistosomiasis (dams); Rift Valley fever (dams, irrigation); Argentine haemorrhagic fever (agriculture); Hantaan (Korean haemorrhagic fever) (agriculture); hantavirus pulmonary syndrome, southwestern US, 1993 (weather anomalies)
Human demographics, behaviour	Societal events: population growth and migration (movement from rural areas to cities); war or civil conflict; urban decay; sexual behaviour; intravenous drug use; use of high-density facilities	Introduction of HIV; spread of dengue; spread of HIV and other sexually transmitted diseases
International travel and commerce	Worldwide movement of goods, animals and people; air travel	'Airport' malaria; dissemination of mosquito vectors; rat-borne hantaviruses; introduction of cholera into South America; dissemination of O139 <i>Vibrio cholerae</i>
Deliberate introduction	Introduction of natural or engineered agent in a legal or illegal control programme, or a terrorist act	Rabbit calicivirus
Technology and industry	Globalization of food supplies; changes in food processing and packaging; organ or tissue transportation; drugs causing immunosuppression; widespread use of antibiotics	Haemolytic uraemic syndrome ( <i>E. coli</i> contamination of hamburger meat); bovine spongiform encephalopathy; transfusion-associated hepatitis (hepatitis B, C), opportunistic infections in immunosuppressed patients; Creutzfeldt–Jakob disease from contaminated batches of human growth hormone (medical technology)
Microbial adaptation and change	Microbial evolution, response to selection in environment	Antibiotic-resistant bacteria; antigenic drift in influenza virus
Breakdown in public health measures	Curtailment or reduction in prevention programmes; inadequate sanitation and vector control measures	Resurgence of tuberculosis in the US; cholera in refugee camps in Africa; resurgence of diphtheria in the former Soviet Union

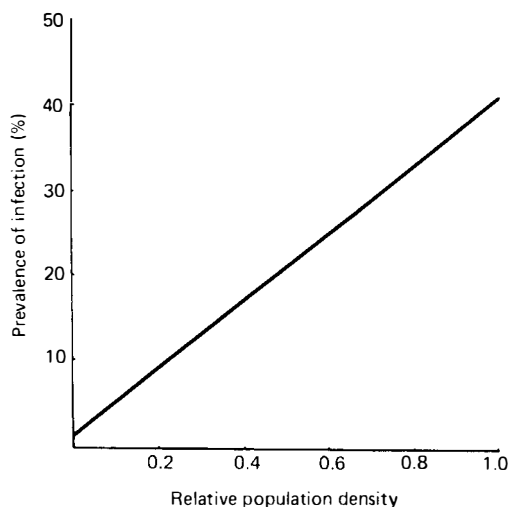
**Fig. 7.13** Relationship between the relative population density and prevalence of *Leptospira*, serovar *ballum*, infection in the brown rat (*Rattus norvegicus*). (Simplified from Blackmore and Hathaway, 1980.)

### Tularaemia

In 1967 in Sweden, an epidemic of tularaemia occurred with more than 2000 human cases and a high mortality rate of hares (Borg and Hugoson, 1980). This epi-

demic was associated with the clearing of small areas of forest to create areas of grazing, which led to a sudden increase in the population density of hares and rodents. A consideration of local ecology in this instance would have suggested that the creation of these synanthropic ecosystems, in which man can be infected either by handling dead hares or through bites of infected mosquitoes, could result in such consequences.

### Kyasanur Forest disease

Kyasanur Forest disease is caused by an arbovirus. Symptoms in humans include headache, fever, back and limb pains, vomiting, diarrhoea and intestinal bleeding. Death due to dehydration can occur in untreated cases. It is apparently restricted to an area 600 miles square in the Indian state of Mysore. The virus endemically and inapparently infects some small mammals, including rats and shrews, in the local rain forest. The virus is transmitted by several species of tick (Singh *et al.*, 1964), only one of which, *Haemaphysalis spinigera*, will infest humans. The usual host of the tick is the ox. Thus, when humans create ecological mosaics by cultivating areas for rice, their cattle roam into the surrounding rain forest and

may become infested with virus-infected ticks. Dense populations of ticks therefore build up around villages and, when infected, these ticks can transmit the infection to humans (Hoogstraal, 1966).

### Further reading

- Aguirre, A.A., Ostfeld, R.S., Tabor, G.M., House, C. and Pearl, M.C. (2002) *Conservation Medicine: Ecological Health in Practice*. Oxford University Press, Oxford. (A study of human and animal diseases in an ecological context)
- Bengis, R.G. (Coordinator) (2002) Infectious diseases of wildlife. *Revue Scientifique et Technique, Office International des Epizooties*, **21**, 1–402
- Bokma, B.H. and Blouin, E. (Eds) (2004) *Impact of Ecological Changes on Tropical Animal Health and Disease Control*, *Annals of the New York Academy of Sciences*, Vol. 1026. New York Academy of Sciences, New York
- Burnet, F.M. and White, D.O. (1962) *Natural History of Infectious Disease*. Cambridge University Press, Cambridge
- Bush, A.O., Fernandez, J.C., Esch, G.W. and Seed, R. (Eds) (2001) *Parasitism: The Diversity and Ecology of Animal Parasites*. Cambridge University Press, Cambridge
- Chadwick, D.J. and Goode, J. (Eds) (1997) *Antibiotic Resistance: Origins, Evolution, Selection and Spread*. CIBA Foundation Symposium 207. John Wiley, Chichester
- Cherrett, J.M. (Ed.) (1989) *Ecological Concepts*. Blackwell Scientific Publications, Oxford. (A general ecology text, which also includes a discussion of predator/prey and host/pathogen interactions)
- Crawley, M.J. (Ed.) (1992) *Natural Enemies: the Population Biology of Predators, Parasites and Diseases*. Blackwell Scientific Publications, Oxford
- Daszak, P., Cunningham, A.A. and Pepper, I.L. (1998) Emerging infectious diseases of wildlife – threats to biodiversity and human health. *Science*, **287**, 443–449
- Deem, S.L., Kilbourn, A.M., Wolfe, N.D., Cook, R.A. and Karesh, W.B. (2000) Conservation medicine. *Annals of the New York Academy of Sciences*, **916**, 370–377
- Desowitz, R.S. (1981) *New Guinea Tapeworms and Jewish Grandmothers. Tales of Parasites and People*. W. Norton and Company, New York and London. (Essays on ecological and anthropological aspects of some parasitic diseases)
- Dieckmann, U., Metz, A.J., Sabelis, M.W. and Sigmund, K. (Eds) (2002) *Adaptive Dynamics of Infectious Diseases: In Pursuit of Virulence Management*. Cambridge University Press, Cambridge. (A comprehensive presentation of the evolutionary ecology of infectious diseases)
- Edwards, M.A. and McDonnell, U. (Eds) (1982) *Animal Disease in Relation to Animal Conservation*. Symposia of the Zoological Society of London No. 50. Academic Press, London
- Ewald, P.W. (1994) *Evolution of Infectious Diseases*. Oxford University Press, Oxford
- Fayer, R. (1998) Global change and emerging infectious diseases. *Journal of Parasitology*, **86**, 1174–1181
- Galuzo, I.G. (1975) Landscape epidemiology (epizootiology). *Advances in Veterinary Science and Comparative Medicine*, **19**, 73–96
- Gibbs, E.P.J. and Bokma, B.H. (Eds) (2002) *The Domestic Animal/Wildlife Interface: Issues for Disease Control, Conservation, Sustainable Food Production, and Emerging Diseases*. *Annals of the New York Academy of Sciences*, Vol. 969. New York Academy of Sciences, New York. (Includes discussions of disease transmission across ecological interfaces)
- Grenfell, B.T. and Dobson, A.P. (Eds) (1995) *Ecology of Infectious Diseases in Natural Populations*. Cambridge University Press, Cambridge
- Grenfell, B.T., Pybus, O.G., Gog, J.R., Wood, J.L.N., Daly, J.M., Mumford, J.A. and Holmes, E.C. (2004) Unifying the epidemiological and evolutionary dynamics of pathogens. *Science*, **305**, 327–332
- Hastings, A. (2004) *Population Biology*, 2nd edn. Springer-Verlag, New York. (A basic text on population biology, with emphasis on simple mathematical models)
- Hudson, P.J., Rizzoli, A., Grenfell, B.T., Heesterbeek, H. and Dobson, A.P. (Eds) (2002) *The Ecology of Wildlife Diseases*. Oxford University Press, Oxford
- Learmonth, A. (1988) *Disease Ecology: An Introduction*. Basil Blackwell, Oxford. (A text focussing on human diseases, but also covering some zoonoses)
- Levin, B.R., Lipsitch, M.N. and Bonhoeffer, S. (1999) Population biology, evolution, and infectious disease: convergence and synthesis. *Science*, **283**, 806–809. (A discussion of population biology in the context of molecular epidemiology, pathogenesis, and disease control)
- Lord, R.D. (1973) Ecological strategies for the prevention and control of health problems. *Bulletin of the Pan American Health Organization*, **17**, 19–34
- Lower, G.M. (1984) The ecology of infectious and neoplastic disease: a conceptual unification. *Ecology of Disease*, **2**, 397–407
- May, R.M. (1981) Population biology of parasitic infections. In: *The Current Status and Future of Parasitology*. Eds Warren, K.S. and Purcell, E., pp. 208–235. Josiah Macy Jr. Foundation, New York
- Morse, S.S. (Ed.) (1993) *Emerging Viruses*. Oxford University Press, New York
- Osofsky, S.A. (Ed.) (2005) *Conservation and Development Interventions at the Wildlife/Livestock Interface*. Occasional Paper of the IUCN, Species Survival Commission No. 30. IUCN Gland, Switzerland/Cambridge. (Includes a discussion of diseases in wildlife and associated domestic species)
- Pavlovsky, E.N. (1964) *Prirodnaya Ochagovost Transmissivnykh Bolezney v Svyazi s Landshoftnoy Epidemiologiy Zooantroponozov*. Translated as *Natural Nidality of Transmissible Disease with Special Reference to the Landscape Epidemiology of Zooanthroponoses*. Plous, F.K. (translator), Levine, N.D. (Ed.) (1966). University of Illinois Press, Urbana
- Pastoret, P.-P., Thiry, E., Brochier, B., Schwers, A., Thomas, I. and Dubuisson, J. (1988) Diseases of wild animals transmissible to domestic animals. *Revue Scientifique et Technique, Office International des Epizooties*, **7**, 705–736
- Rapport, D.J. (1999) Epidemiology and ecosystem health: natural bridges. *Ecosystem Health*, **5**, 174–180
- Rapport, D., Costanza, R., Epstein, P.R., Gaudet, C. and Levins, R. (Eds) (1993) *Ecosystem Health*. Blackwell Science, Oxford. (A discussion of the impact of environmental change on ecosystems, including human and animal disease)

- Ricklefs, R.E. and Miller, G.L. (2000) *Ecology*, 4th edn. W.H. Freeman, New York. (A general ecology text, which also includes a discussion of parasitism and disease)
- Schneider, R. (1991) Wildlife epidemiology. In: Waltner-Toews, D. (Ed.) *Veterinary Epidemiology in the Real World: a Canadian Potpourri*, pp. 41–47. Canadian Association of Veterinary Epidemiology and Preventive Medicine, Ontario Veterinary College, Guelph. (A concise discussion of the role of disease in regulating animal populations)
- Schrag, S.J. and Wiener, P. (1995) Emerging infectious diseases: what are the relative roles of ecology and evolution? *Trends in Ecology and Evolution*, **10**, 319–324
- Schwabe, C.E. (1984) *Veterinary Medicine and Human Health*, 3rd edn. Williams and Wilkins, Baltimore. (Includes a section on medical ecology)
- Sinnecker, H. (1976) *General Epidemiology* Walker, N. (translator). John Wiley and Sons, London. (An ecological approach to epidemiology)
- Sterns, S. (Ed.) (1999) *Evolution in Health and Disease*. Oxford University Press, Oxford
- Williams, E.S. and Barker, I.K. (Eds) (2001) *Infectious Diseases of Wild Mammals*, 2nd edn. Manson Publishing, London
- Wobeser, G.A. (1994) *Investigation and Management of Disease in Wild Animals*. Plenum Press, New York

# 8

## Patterns of disease

Methods of expressing the temporal and spatial distribution of disease were described in Chapter 4. The various patterns of disease that can be detected when disease distribution is recorded are discussed in this chapter. A considerable bulk of mathematical theory has been formulated to explain disease patterns (e.g., Bailey, 1975). Most of this is beyond the scope of this book, but a brief introduction will be given in this chapter. Additionally, the application of mathematics to the development of predictive models, of practical value to disease control, is described in Chapter 19.

### Epidemic curves

The representation of the number of new cases of a disease by a graph, with the number of new cases on the vertical axis and calendar time on the horizontal axis, is the most common means of expressing disease occurrence. The graph of an epidemic in this way produces an **epidemic curve**. *Figure 8.1* depicts the various parts of an epidemic curve, stylized to a symmetric shape for the purpose of illustration. Epidemic curves are given for foot-and-mouth disease in *Figure 4.1*, with the number of new outbreaks (Appendix I) approximately indicating the number of new cases. Note that the culmination point (peak) is shifted to the left, that is, the curve is positively skewed.

### Factors affecting the shape of the curve

The shape of the curve and the time scale depend on:

- the incubation period of the disease;
- the infectivity of the agent;
- the proportion of susceptible animals in the population;
- the distance between animals (i.e., animal density).

Thus, a highly infectious agent with a short incubation period infecting a population with a large proportion of susceptible animals at high density produces a curve with a steep initial slope on a relatively small time scale, representing a rapid spread of infection among the population.

A minimum density of susceptible animals is required to allow a contact-transmitted epidemic to commence. This is called the **threshold level**, and is defined mathematically by **Kendall's Threshold Theorem** (in Discussion to Bartlett, 1957). *Figure 8.2* illustrates application of the theorem in relation to rabies in foxes. Above a certain density of susceptible animals, one infected fox can, on average, infect more than one susceptible fox, and an epidemic can occur; the greater the density, the steeper the slope of the progressive stage of the epidemic curve. Few threshold values relating to animal diseases are known.

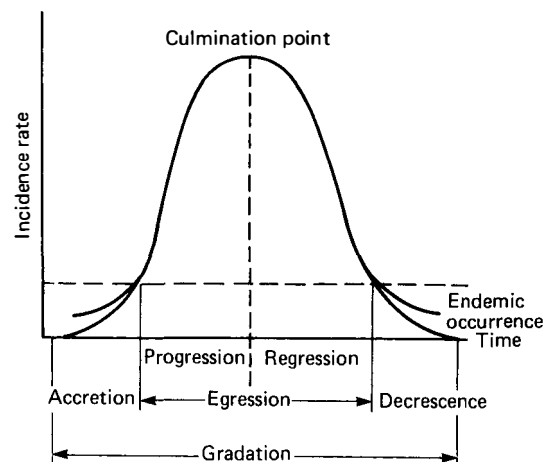

**Fig. 8.1** Components of an epidemic curve (stylized to a symmetric shape). The horizontal dotted line indicates the average number of new cases. (From Sinnecker, 1976.)



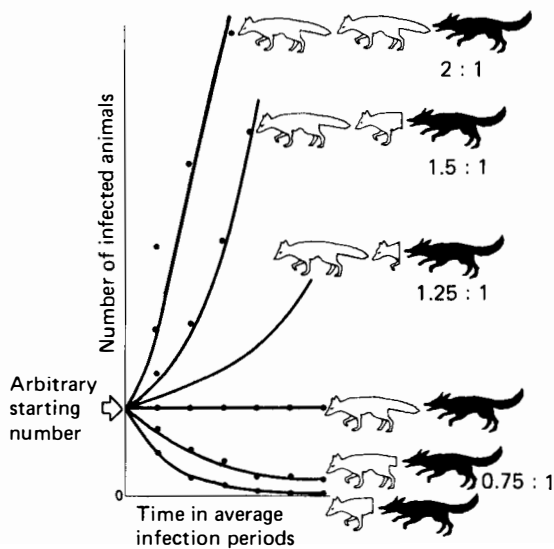

**Fig. 8.2** Application of Kendall's Threshold Theorem to rabies in foxes: the theorem predicts that, if a rabid fox infects more than one other before it dies, the disease increases exponentially; if each animal infects less than one other, the disease decreases exponentially. White animals: susceptible; black animals: infected and infectious. Numbers refer to the **contact rate**: the number of susceptible animals that are infected by an infected animal. (From Macdonald and Bacon, 1980.)

Wierup (1983) has estimated that a minimum density of 12 dogs/km<sup>2</sup> is required before a canine parvovirus epidemic can occur.

The threshold level is more generally defined in terms of the **basic reproductive number (basic reproduction ratio; basic reproductive rate)  $R_0$** : the average number of secondary cases caused by one typical infectious individual during its entire infectious period (Diekmann *et al.*, 1990).

For microparasitic diseases (see Chapter 7):

$$R_0 = \beta \times d$$

where:  $\beta$  = number of contacts per unit time  $\times$  transmission probability per contact, and:  $d$  = duration of infectiousness.

If  $R_0 > 1$ , an infection will invade a population; whereas if  $R_0 < 1$  it cannot.

The basic reproductive number is not specific to a particular microbe. It is a characteristic of a particular microbial population in a particular host population at a specific time. The value of  $\beta$  is affected by the conditions under which effective contact (see Chapter 6) occurs. For example, during a foot-and-mouth disease epidemic, contact rates in hill sheep are likely to be lower than in housed sheep. Direct estimation of  $R_0$  is therefore difficult (Dietz, 1993)<sup>1</sup>.

<sup>1</sup> Indirect methods can be used when transmission is in equilibrium (e.g., when, on average, one infectious case produces one other infectious case); see Halloran (1998) for details.

The basic reproductive number can also be applied to macroparasitic diseases, where it refers to the average number of offspring produced throughout the life span of a mature parasite (Anderson and May, 1991); a parasite population will establish within a host community only when  $R_0 > 1$ .

As an epidemic proceeds, the number of susceptible animals is decreased, either as a result of death of infected animals, or by increasing immunity following infection (Figure 8.3). Eventually, the epidemic cannot continue because there are insufficient susceptible animals available for infection. In the case of canine parvovirus, for instance, an epidemic stops when the density of susceptible dogs falls below 6/km<sup>2</sup> (Wierup, 1983). A period of time is then necessary to allow replacement of susceptible animals before another epidemic can commence. This explains the cyclicity of some epidemics.

In veterinary medicine, concern frequently focuses on the progress of an epidemic at herd level. The **dissemination rate (DR)** is the propensity of infection to spread to other herds (Miller, 1976)<sup>2</sup>. It represents the average number of uninfected herds (or premises) to which an infectious agent is delivered by each infected herd.

The DR depends on several factors:

- the environment (geography, herd density and sometimes weather);
- type of farming enterprise (species of livestock, opportunity for transmission by fomites);
- animal movements (e.g., marketing, movement to pasture from winter housing);
- behaviour of the farmer ('biosecurity', travel);
- disease control strategies (quarantine, movement restrictions);
- host factors (immunity, concurrent disease, age, breed, pregnancy).

In epidemics involving farmed livestock (e.g., foot-and-mouth disease), infection is usually curtailed by a decline in the DR, rather than just by a lack of susceptible animals. The decline may be due to the implementation of disease control strategies, increased awareness among livestock owners, and other factors initially favourable to dissemination no longer acting (e.g., the mixing and crowding of animals in markets no longer occurring).

The complex of factors that generate a value of the DR renders precise prediction of the course of an

<sup>2</sup> A herd-level parameter is valuable because herds are stationary, having only indirect contact with other herds (e.g., through fomites). The concept of effective contact (see Chapter 6) occurring at random within a homogeneously mixed population, which forms the basis of simple epidemic models (e.g., the Reed-Frost model described later in this chapter), is therefore inappropriate.

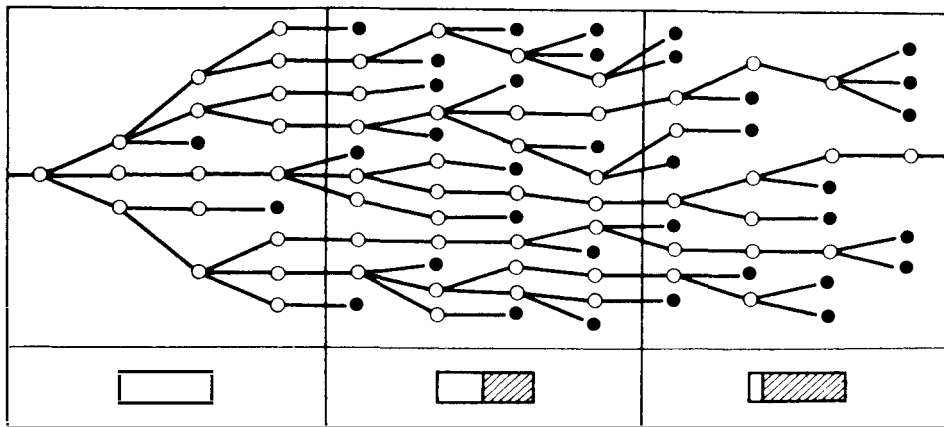

**Fig. 8.3** The course of a typical epidemic caused by an infectious agent infecting a totally susceptible population. Each circle represents an infection, and the connecting lines indicate transfer from one case to the next. Black circles represent infected individuals who fail to infect others. Three periods are shown: the first when practically the whole population is susceptible; the second at the height of the epidemic; and the third at the close, when most individuals are immune. The proportions of susceptible (white) and immune (hatched) individuals are indicated in rectangles beneath the main diagram. (From Burnet and White, 1972.)

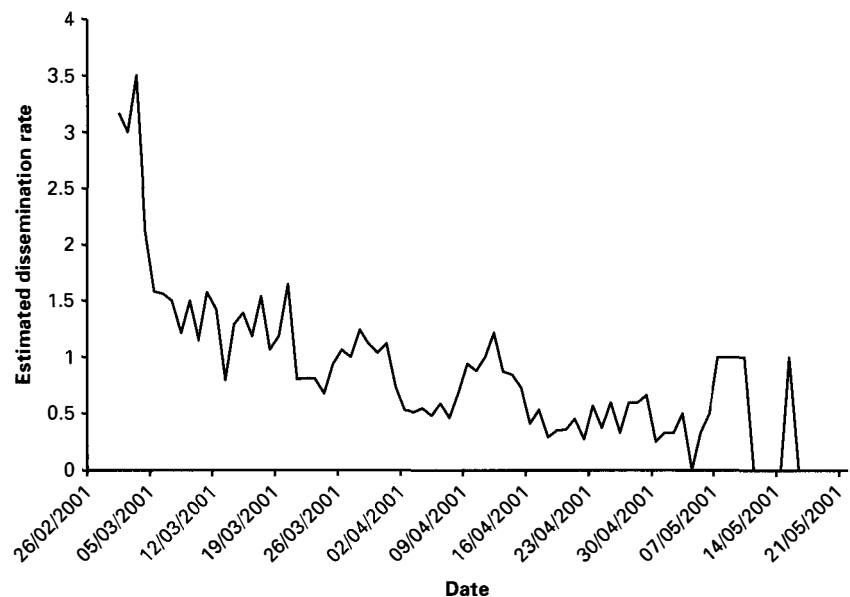

**Fig. 8.4** Daily estimated dissemination rate of foot-and-mouth disease in Dumfries and Galloway, UK, 2001. (Modified from Thrusfield *et al.*, 2005b.)

epidemic impracticable. Therefore, during an epidemic, the **estimated dissemination rate (EDR)** is calculated from the observed outbreaks of disease. This represents the rate of growth of the epidemic. In foot-and-mouth disease it is often plotted using a 7-day interval: the number of outbreaks in a population over a 7-day period divided by the number of outbreaks in the same population in the previous 7-day period (e.g., Gibbens *et al.*, 2001b). An  $EDR > 1$  indicates that an epidemic is increasing, whereas an  $EDR < 1$  points to a decline. *Figure 8.4* plots the EDR of foot-and-mouth disease in Dumfries and Galloway, during the epidemic in the UK in 2001, plotted daily, using a 7-day interval. The EDR dropped below one on 21 March, and subsequently there were transient increases above one at the

end of March and early in April. However, these last two peaks should not be interpreted as failures in disease control. They resulted from eruption of disease in new areas north-west of Dumfries and south and south-east of Dalbeattie, rather than recrudescence in the initial focus in the south-east of the region (see *Figure 4.14*). This highlights the importance of expressing disease occurrence both temporally *and* spatially, and recognizes the need to collect and analyse field data *during* an epidemic.

#### Common source and propagating epidemics

A **common source epidemic** is one in which all cases are infected from a source that is common to all

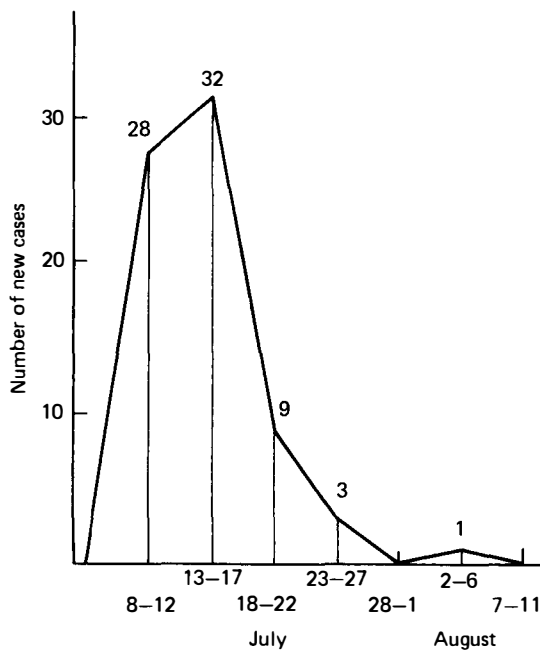

**Fig. 8.5** A point-source epidemic: human leptospirosis associated with contaminated water supply, Rostov-on-Don, USSR, 1955. (From Ianovitch *et al.*, 1957.)

individuals. If the period of exposure is brief, then a common source epidemic is a **point-source** (or, more briefly, just a **point**) epidemic. A food-poisoning outbreak, in which a single batch of food is contaminated, is a typical point-source epidemic. *Figure 8.5* illustrates a point-source epidemic of human leptospirosis in the USSR in 1955 associated with the contamination of the water supply with the urine of infected dogs. An epidemic of leptospirosis was occurring in dogs, and contaminated urine was discharged on to fields. A cloud-burst occurred on 28 June during a brief period of heavy rainfall. This washed off the topsoil. Some of the soil entered a water pumping station inspection shaft which was open for repair. Thus, the water supply was contaminated, and resulted in the human epidemic.

A **propagating epidemic** is an epidemic caused by an infectious agent in which initial (i.e., **primary**) cases excrete the agent, and thus infect susceptible individuals, which constitute **secondary** cases. Epidemics of foot-and-mouth disease are examples (*Figure 4.1*). One of the primary cases is frequently the **index case**, that is, the first case to come to the attention of investigators.

The time interval between peaks of successive temporal clusters of cases, separating the primary from subsequent secondary cases, reflects the incubation period of the infection. Typically, all cases of a point-source epidemic occur within one incubation period of the causal agent. Thus, if the period between subsequent peaks is less than the most common incubation

period, then it is difficult to differentiate between a propagating epidemic and a series of point-source epidemics. Sartwell (1950, 1966) describes a suitable technique of differentiation, based on the statistical distribution of incubation periods.

### The Reed–Frost model

The shape of the epidemic curve in a propagating epidemic in a defined population can be mathematically modelled (Bailey, 1975). One of the basic models is the **Reed–Frost model** (Abbey, 1952; Frost, 1976). In this model's classical simple form, the population is divided into three groups, comprising:

1. infected animals (cases);
2. susceptible animals;
3. immune animals.

The number of individuals in each group determines the shape of the epidemic curve and the pattern of immunity in the population.

Assuming that the period of infectiousness of infected animals is short, and the incubation period or latent period is constant, then, starting with a single case (or several simultaneously infected cases), new cases will occur in a series of stages. Cases occurring at each stage can be expected to have a binomial distribution (see Chapter 12), depending on the number of susceptible and infectious animals at the previous stage. A **chain of binomial** distributions thus can be expected; this model is therefore termed a 'chain-binomial model'. The model also assumes that all infected animals develop disease, become infectious in the next stage, and then become immune.

The model is constructed using the formula:

$$C_{t+1} = S_t(1 - q^{C_t}),$$

where:

- $t$  = the time period: usually defined as the incubation period or latent period of the infectious agent (ideally, the serial interval of infection: see Chapter 6);
- $C_{t+1}$  = the number of infectious cases in time period,  $t + 1$ ;
- $S_t$  = the number of susceptible animals in the time period,  $t$ ;
- $q$  = the probability (see Chapter 12) of an individual **not** making effective contact.

The value,  $q$ , is given by  $(1 - p)$ , where  $p$  = the probability of a specific individual making effective contact (see Chapter 6) with another individual which would result in infection if one were susceptible and the other were infectious. The term  $(1 - q^{C_t})$  arises because it represents the probability that at least one of the  $C_t$

**Table 8.1** Simulation of an epidemic using the classical Reed–Frost model.

Time ( $t$ )	Number of Cases ( $C_t$ )	Number of susceptible animals ( $S_t$ )	Number of immune animals ( $I_t$ )	Totals	Probability of effective contact ( $p$ )	$pS_t$
0	1	100	0	101	0.06	6.00
1	6	94	1	101	0.06	5.64
2	29	65	7	101	0.06	3.90
3	54	11	36	101	0.06	0.66
4	11	0	90	101	0.06	0.00
5	0	0	101	101	0.06	0.00

infectious cases makes effective contact. The magnitude of  $p$  is a matter of chance, and depends on a variety of factors, including those already described in Chapter 6. It is usually estimated empirically from real epidemics (Bailey, 1975).

If, at time  $t$  (the beginning of an epidemic), there are 100 susceptible animals, no immune animals, and one case, then  $S_t = 100$  and  $C_t = 1$ .

If  $p = 0.06$ , then  $q = (1 - 0.06) = 0.94$ .

At time  $t + 1$ :

$$C_{t+1} = 100(1 - 0.94^1) \\ = 6,$$

and

$$S_{t+1} = 100 - 6 \\ = 94.$$

At time  $t + 2$ :

$$C_{t+2} = 94(1 - 0.94^6) \\ = 29,$$

and

$$S_{t+2} = 94 - 29 \\ = 65.$$

At time  $t + 3$ :

$$C_{t+3} = 65(1 - 0.94^{29}) \\ = 54,$$

and

$$S_{t+3} = 65 - 54 \\ = 11,$$

and so on.

The number of immune animals at any time period is the cumulative total of infected animals during the preceding time periods. Thus, at time  $t + 1$ , the number of immune animals  $I_{t+1} = 1$  (the 1 case from time  $t = 0$ ); at time  $t + 2$ ,  $I_{t+2} = 6 + 1 = 7$ ; at time  $t + 3$ ,  $I_{t+3} = 7 + 29 = 36$ , and so on.

Table 8.1 presents the results of the Reed–Frost model, using the above parameters, for the complete

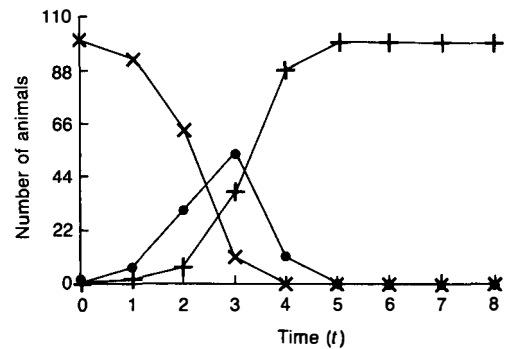

**Fig. 8.6** An epidemic curve, number of susceptible animals and number of immune animals simulated by the classical Reed–Frost model. —•— Cases; —+— immune animals; —x— susceptible animals. (Data from Table 8.1.)

course of the modelled epidemic. The results are also plotted in Figure 8.6. Note that an epidemic can only occur when  $p \times S_t > 1$ , and declines (or cannot initially occur) when  $p \times S_t < 1$ . The likelihood of an epidemic occurring, and the shape of the epidemic curve, are therefore functions of the probability of effective contact and the number of susceptible animals.

The **proportion** of the population that is susceptible is often used as a general guide to the likelihood of an infection spreading – commonly, at least 20–30% of the population; with the corollary that, if 70–80% of the population is immune, infection will not spread. Although the latter level of protection will prevent a **major** epidemic, infection can spread with a relatively low proportion of susceptible animals if there are sufficient susceptible animals to render  $p \times S_t$  greater than 1.

Figure 8.7 depicts epidemic curves that are simulated using various values for the number of susceptible and immune animals, and the parameter,  $p$ . A number of immune animals at the beginning of an epidemic can decrease the amplitude of the epidemic and delay its peak; a change in effective contact can also alter the amplitude.

The basic Reed–Frost model can be modified to include control components, such as vaccination with

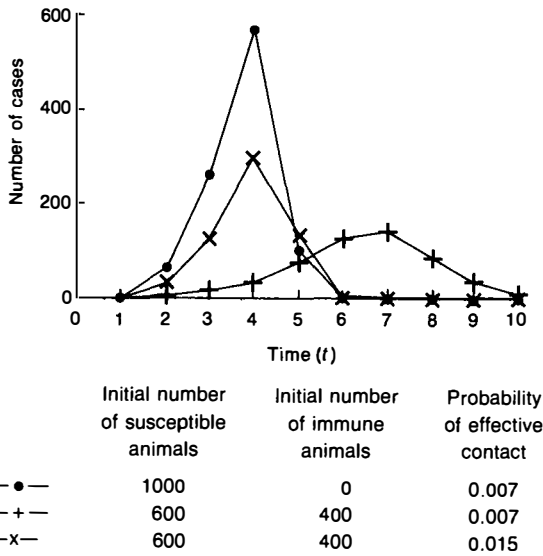

Fig. 8.7 Some epidemic curves simulated by the classical Reed–Frost model. Population size = 1000; a single case is introduced into the population.

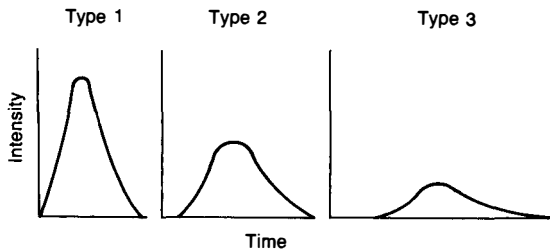

Fig. 8.8 Kendall’s concept of changing wave shape over time. (From Cliff and Haggett, 1988.)

a varying duration of immunity (Carpenter, 1988), and varying periods of infectiousness (Bailey, 1975)<sup>3</sup>.

### Kendall’s waves

Some epidemics – notably those caused by viruses – occur as a series of outbreaks which can be considered as a series of epidemic **waves**: a **wave-train**. Three types of wave, representing particular stages of a continuum, were identified by Kendall (1957); these are called **Kendall’s waves** (Figure 8.8). There are three main differences between these waves (Cliff and Haggett, 1988):

1. **amplitude** – decreasing intensity from type 1 to type 3;
2. **peakedness** (concentration of cases) – also decreasing, from type 1 to type 3;
3. **skewness** – noticeable in type 1, but decreasing in succeeding types.

The shape of each wave in the wave-train at a given time or place in a population at risk of size  $S$  depends on the rate of infection,  $\beta$ , and the rate of removal,  $\mu$ . Removal occurs when infected animals die, are isolated, or recover and become immune. These two parameters are related in a third,  $S_c$ : the **relative removal rate**.

$$S_c = \mu/\beta.$$

The relative removal rate defines a critical susceptible threshold population size whose magnitude compared with  $S$  determines the wave’s shape. When  $S$  is much greater than  $S_c$ , a type 1 wave occurs. Type 3 waves occur when the number of animals at risk is low, and consequently  $S$  is only slightly greater than  $S_c$ . These waves are characterized by relatively lengthy outbreaks of low amplitude. Type 2 waves are intermediate to types 1 and 3.

The shape of the waves changes as an epidemic spreads over time and space. This is exemplified by the epidemic of the virus disease, Newcastle disease, which occurred in England and Wales in 1970–71, and which is charted in Figures 8.9 and 8.10. The infection is spread by movement of live birds and other animals, fomites, poultry products and airborne transmission (Calnek, 1991). Although the disease is preventable by vaccination, the previous epidemic had occurred 6 years earlier and the subsequent casual attitude to vaccination resulted in a level of population immunity well below the 75% required to prevent a major epidemic. The epidemic began in the East of England and spread westwards. Initially, the amplitude was great, but succeeding waves showed a transition over time and space from type 1 to type 3; locations 1, 2 and 3 in Figure 8.9 corresponding to the wave types predicted by Kendall. The contours in Figure 8.10 are time contours of 15-day periods (15 days is a rough multiple of the average incubation period, calculated from a range of 3–10 days). Thus, the contour with the value 9 marks the 135th day of the epidemic. These contours suggest that the ‘velocity’ of the epidemic temporarily decreased as the epidemic moved westwards.

The changes in the shape of these waves must result from a decrease in the value of  $S/S_c$  over time and space. This could occur either because  $S$  decreases and/or  $S_c$  increases. An increase in the latter could occur because of a change in the value of the removal rate,  $\mu$ , but this is unlikely for a specific disease. Alternatively, the rate of infection,  $\beta$ , could increase,

<sup>3</sup> Some models of the age distribution of cancer also show remarkable similarities to the Reed–Frost model (Burch, 1966), reflecting underlying biological similarities. Contact between an infectious and a susceptible individual is similar to an environmental carcinogen effectively ‘hitting’ a cell; and the conversion of a susceptible individual to a case is similar to a mutation that converts a normal cell to a malignant one (see Chapter 5).

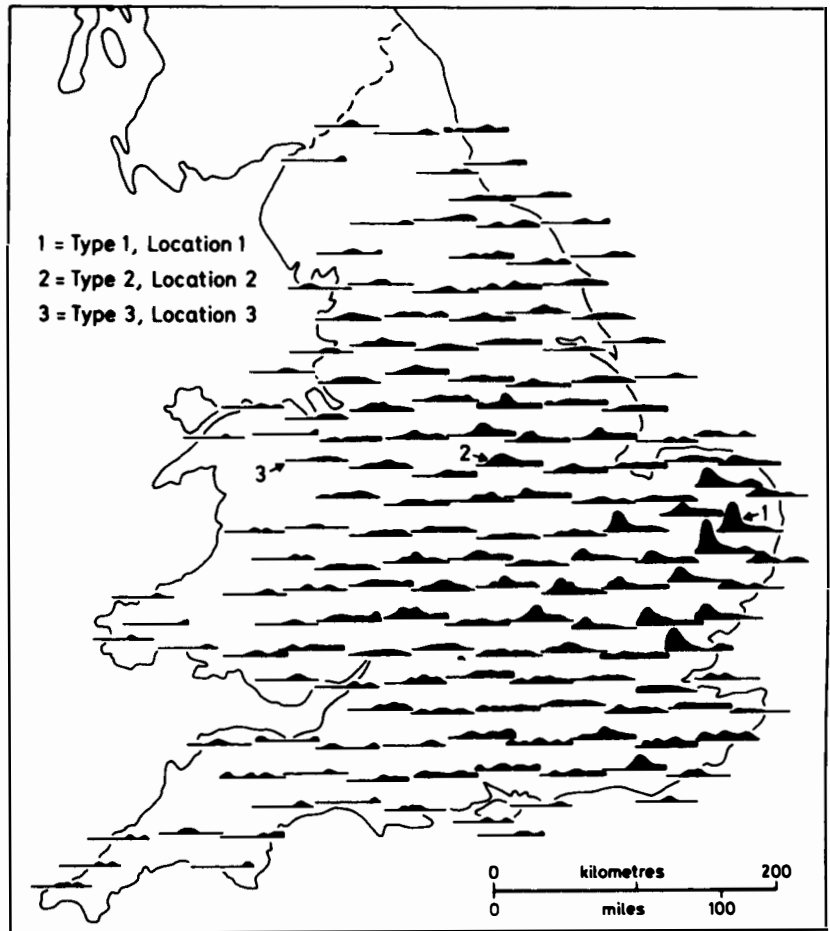

Fig. 8.9 Newcastle disease epidemic of 1970–71 in England and Wales. (From Cliff and Haggett, 1988.)

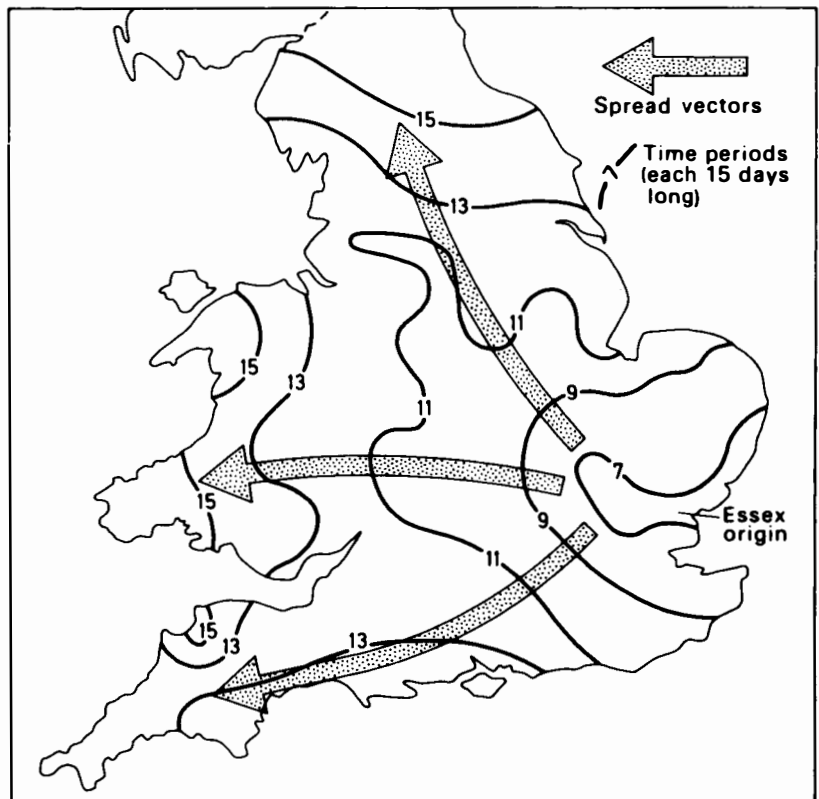
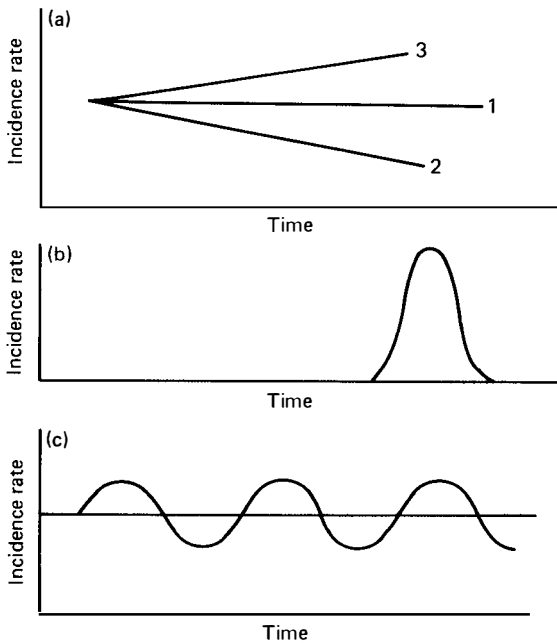

Fig. 8.10 Progress of the Newcastle disease epidemic of 1970–71 in England and Wales from its origins to the rest of the country. (From Cliff and Haggett, 1988.)



**Fig. 8.11** Temporal trends in disease occurrence. (a) Long-term trend: (1) with equilibrium between infectious agent and host; (2) host/agent interaction biased to the host; (3) host/agent interaction biased to the agent. (b) Short-term trend. (c) Cyclical trend. (From Sinnecker, 1976.)

but this is equally unlikely, necessitating a change in virulence or infectiousness of the agent during the course of the epidemic. Thus, the most probable reason for the change in the wave shape is a reduction in  $S$ , which could plausibly be brought about by isolation of animals and vaccination. This is consistent with the pattern of the Newcastle disease epidemic, in which increased vaccinations and mandatory restrictions on poultry movement during the epidemic would have decreased the value of  $S$ .

### Trends in the temporal distribution of disease

The temporal changes and fluctuations in disease occurrence can be classified into three major trends (Figure 8.11):

1. short-term;
2. cyclical (including seasonal);
3. long-term (secular).

#### Short-term trends

Short-term trends (Figure 8.11b) are typical epidemics, which have already been discussed.

#### Cyclical trends

Cyclical trends (Figure 8.11c) are associated with regular, periodic fluctuations in the level of disease occurrence. They are associated with periodic changes in the size of the susceptible host population and/or effective contact, and may produce **recurrent epidemics** or **endemic pulsations** (regular, **predictable** cyclical fluctuations). Thus, the 3- to 4-year cycle of foot-and-mouth disease in Paraguay (see Figure 8.17), and the predicted 4-year periodicity of fox rabies in Britain, with a contact rate of 1.9 (see Figure 19.4a), probably are related to the time taken for the susceptible population to reach the threshold level.

#### Seasonal trends

A seasonal trend is a special case of a cyclical trend, where the periodic fluctuations in disease incidence are related to particular seasons. Fluctuations may be caused by changes in host density, management practices, survival of infectious agents, vector dynamics and other ecological factors. Thus, before eradication, rinderpest occurred in Africa more commonly in the dry than the wet season because animals congregated at water holes, increasing the local animal density.

The prevalence of Lassa virus infection of the multimammate mouse (see Chapter 6) is related to density-dependent variations in mortality, competition with other rodents, and seasonal factors. The mouse may seek shelter in homes during the wet season, and this may partly explain the increased incidence of human Lassa fever during the wet season.

Rat plague demonstrates a seasonal incidence, being associated with climatically determined fluctuations in the population size of certain fleas that are vectors of the disease. Additionally, the rat population increases during the interepidemic season, thereby exacerbating the seasonal trend (Pollitzer and Meyer, 1961).

Myxomatosis in lowland rabbits in the UK has a two-peaked annual cycle, with a main autumnal peak between August and December, and a subsidiary peak in February (Figure 8.12). This is the result of several

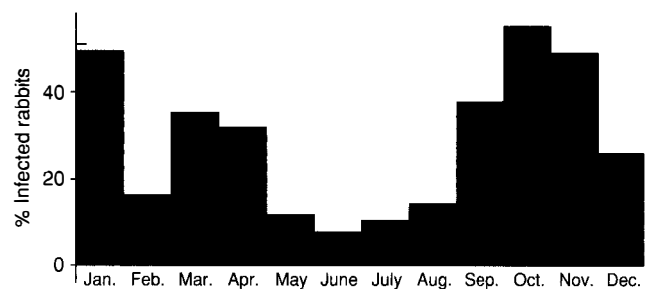

**Fig. 8.12** Monthly percentage of live-trapped farmland rabbits infected with myxomatosis, Hampshire, UK, 1971–78. (Redrawn from Ross *et al.*, 1989.)

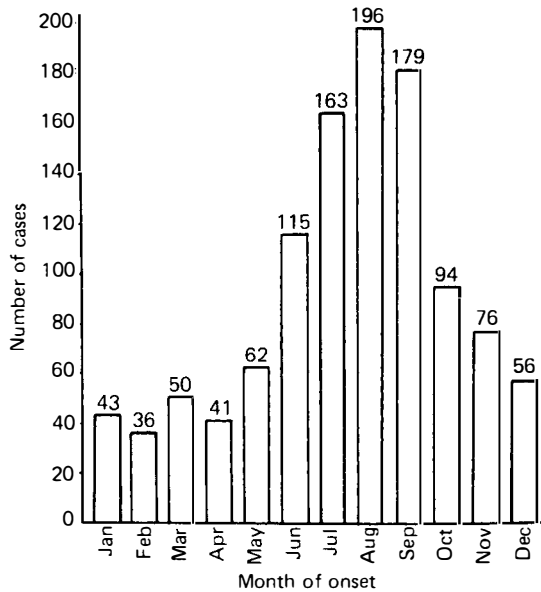

**Fig. 8.13** Bar chart depicting the seasonal occurrence of human leptospirosis in the US. (From Diesch and Ellinghausen, 1975.)

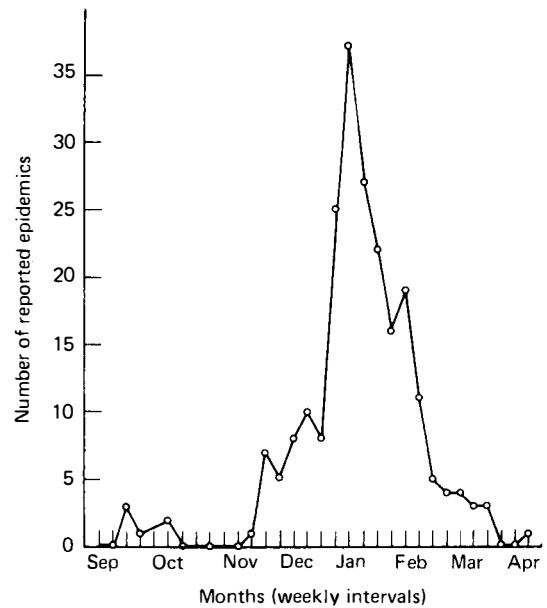

**Fig. 8.14** Seasonal trend of transmissible gastroenteritis of pigs: reported epidemics in Illinois, 1968–69. (From Ferris, 1971.)

ecological factors, including mass movement of fleas and seasonal fluctuations in the abundance of rabbits (Ross *et al.*, 1989). In Spain, clinical myxomatosis occurs in the winter and spring, corresponding to the recruitment of young susceptible rabbits (Calvete *et al.*, 2002).

Leptospirosis is more common in the summer and early autumn than the winter in temperate climates (Figure 8.13) because the warm, moist conditions during the summer predispose to survival of the pathogen (Diesch and Ellinghausen, 1975; Ward, 2002).

In contrast, transmissible gastroenteritis of pigs is more common in winter than summer (Figure 8.14). This may be because the survival time of the virus is very short in summer because of the stronger ultraviolet light and higher temperatures than (Haelterman, 1963).

In the US, feline panleucopenia shows a seasonal peak in August and September (Reif, 1976). This is associated with a peak in the number of births in the cat population in June, which increases the number of susceptible cats in the population at risk. The kittens are protected passively by maternal antibody for approximately the first 2 months of life, therefore the peak 'herd' susceptibility occurs 2 months after the birth peak. Such seasonal fluctuations are less likely in canine than in feline populations because births of puppies are distributed more evenly throughout the year than those of kittens (Tedor and Reif, 1978).

Some non-infectious diseases may also show seasonal trends. Thus, bovine hypomagnesaemia is common in spring and is associated, among other factors, with low levels of magnesium in rapidly growing pastures (see Figure 3.6).

Sometimes seasonal determinants may be unidentified. For example, canine diabetes mellitus, like human insulin-dependent diabetes, is more common in winter than summer (Marmor *et al.*, 1982).

### Long-term (secular) trends

Secular trends (Figure 8.11a) occur over a long period of time and represent a long-term interaction between host and parasite. If a balance occurs, then a stable, endemic level of disease is maintained (1 in Figure 8.11a); if the interaction is biased to the host, then there is a gradual decrease in disease occurrence (2); and if the interaction is biased to the parasite, there is a gradual increase in disease occurrence (3).

Figure 8.15 illustrates a **reported** increasing long-term trend in the annual prevalence of rabies in

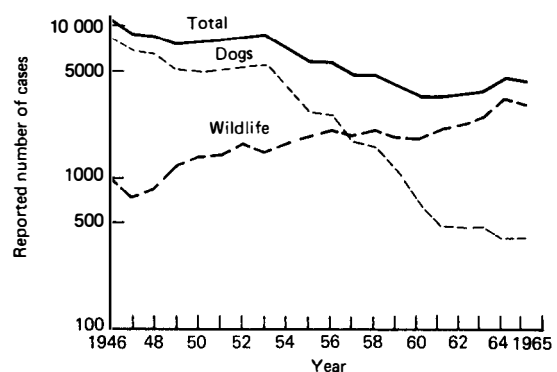

**Fig. 8.15** An example of a secular trend: reported cases of rabies in the US, 1946–65. (From West, 1972.)



wildlife in the US, whereas the prevalence in dogs is decreasing due to adequate control. 'Reported' is emphasized to stress that accurate estimation of trends is open to errors, some of which are described below.

Upward trends may also result from the intervention of man and changing human habits. Such trends occur with the so-called 'diseases of civilization' and 'urbanization' in man, (e.g., coronary heart disease) and the diseases of intensive production in animals. Secular decreases in morbidity may be the product of prophylaxis (e.g., vaccination). Mortality may show a secular decrease due to improved therapeutic techniques.

### True and false changes in morbidity and mortality

The temporal changes that occur in recorded morbidity and mortality rates may be either true or false. The recording of mortality rates is rarer in veterinary than in human medicine because recording death in animals is not compulsory. Thus, details of trends in mortality in animals are usually unavailable.

The common measures of morbidity – prevalence, cumulative incidence and incidence rate – comprise a numerator (number of cases) and a denominator ('population at risk' for first two measures, and 'animal-years at risk', or a suitable approximation, for the third – Chapter 4). Changes in either numerator or denominator induce changes in these measures that may be either true or false (Table 8.2). True changes in risk and an incidence density can affect these recorded measures and prevalence; additionally, changes in disease duration affect prevalence (see Chapter 4).

A major cause of false changes is variation in the recognition and reporting of disease. Thus, the increasing secular trend in wildlife rabies in the US

between 1946 and 1965 (Figure 8.15) may have resulted from increased recognition and reporting of affected animals, rather than a genuine increase in incidence. In the US, reports of feline heartworm disease have increased over the years (Guerrero *et al.*, 1992), but it is difficult to say if this is due to increased awareness, improved methods of diagnosis, or a true rise in the disease's incidence. Similarly, apparent increases in parietal chronic pleuritis in Danish abattoirs can be explained by an increased frequency of detection resulting from increased diagnostic sensitivity (Enøe *et al.*, 2003).

The sampling of an animal population to record morbidity is also subject to inherent **variation** in the samples (see Chapter 12), and so appropriate statistical analysis should be undertaken (see Chapter 13).

Apparently changing patterns therefore should be interpreted with due regard to the possibility that they are artificial.

### Detecting temporal trends: time series analysis

Short-term, seasonal and secular changes are temporal trends that can occur simultaneously, and may be mixed with random variation. In such circumstances, the various changes can be identified by statistical investigation. One method, originally applied in commerce, that is used in epidemiology to detect temporal trends, is **time series analysis**.

A time series is a record of events that occur over a period of time; cases of disease are typical events. The events are plotted as points on a graph, with 'time' along the horizontal axis. Table 8.3, for instance, records the percentage of sheep lungs condemned monthly because of pneumonia or pleurisy at a Scottish slaughterhouse. Figure 8.16a plots these monthly values. There is considerable variation in the location of the points, but, by eye, an annual cycle is suggested and there appears to be a slight secular trend of increased prevalence from 1979 to 1983. Trends in these data may be detected by three methods:

1. free-hand drawing;
2. calculation of rolling (moving) averages;
3. regression analysis;

the object being to identify, and, if required, to remove, random variation, seasonal and secular trends.

#### Free-hand drawing

The joining of points by eye is an obvious, easy method of indicating a trend. However, it is susceptible to subjective interpretation and cannot counteract random variation readily.

**Table 8.2** Reasons for true and false temporal changes in incidence and prevalence according to changes in the numerator (cases) and denominator (animal-years at risk etc./population at risk).

True changes	
Incidence:	change in incidence
Prevalence:	(a) change in incidence (b) change in duration of disease
False changes	
Prevalence and incidence:	
1.	Errors in the numerator:
	(a) changes in the recognition of disease
	(b) changes in the procedures for classifying disease
2.	Errors in the denominator:
	(a) errors in enumeration of the animal-years at risk etc./population at risk

**Table 8.3** Percentage of sheep lungs condemned monthly because of pneumonia and/or pleurisy, and average monthly and yearly percentage condemnation rates (1979–83) at a Scottish abattoir. (From Simmons and Cuthbertson, 1985.)

	Jan%	Feb%	Mar%	Apr%	May%	Jun%	Jul%	Aug%	Sep%	Oct%	Nov%	Dec%	Yearly% condemnation rate
1979	0.33	0.24	0.46	0.57	0.65	0.23	0.27	0.37	0.14	0.30	0.24	0.14	0.33
1980	0.40	0.38	0.39	0.65	0.58	0.49	0.49	0.19	0.27	0.34	0.30	0.44	0.41
1981	0.48	0.58	0.62	0.75	0.51	0.44	0.21	0.17	0.18	0.21	0.35	0.27	0.40
1982	0.72	0.71*	0.75*	0.85	0.45	0.34	0.26	0.43	0.95	0.60	1.41	0.63	0.68
1983	0.71	0.64	0.48	0.84	0.38	0.48	0.69	0.80	1.09	0.76	1.25	0.97	0.76
Average monthly % condemnation rate	0.53	0.51	0.54	0.73	0.51	0.40	0.38	0.39	0.53	0.44	0.71	0.49	

\* Estimated

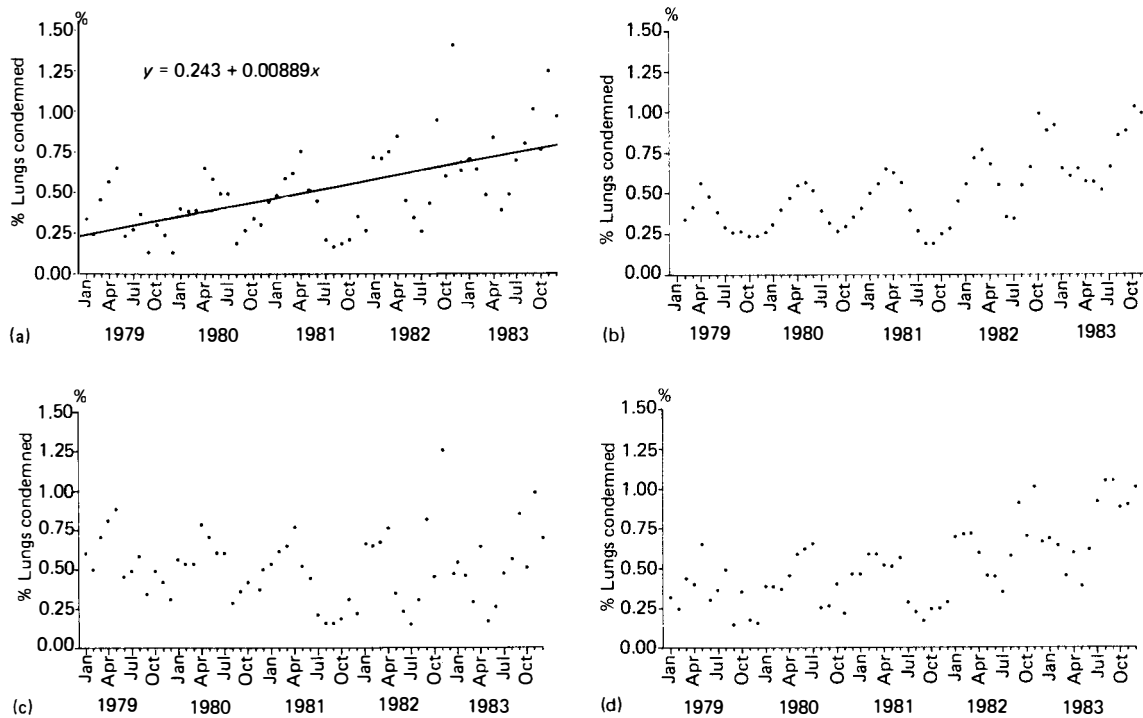
**Fig. 8.16** Percentages of sheep lungs condemned monthly because of pneumonia and/or pleurisy, and average monthly and yearly percentage condemnation rates (1979–83) at a Scottish abattoir. (a) Percentages of lungs condemned monthly because of pneumonia and/or pleurisy (data from Table 8.3) with regression line. (b) Three-monthly rolling average percentage lung condemnation rate because of pneumonia and/or pleurisy (data from Table 8.4). (c) Percentages of lungs condemned monthly (corrected to remove secular trend) because of pneumonia and/or pleurisy. (d) Percentages of lungs condemned monthly (corrected to remove seasonal trend) because of pneumonia and/or pleurisy. (From Simmons and Cuthbertson, 1985.)

### Calculation of rolling (moving) averages

A rolling average is the arithmetic average of consecutive groups of measurements. Thus, to construct a rolling 3-month average of the monthly data in Table 8.3, sequential sets of three adjacent values are averaged. For example, the rolling average for February 1979 is calculated by summing the monthly averages for January, February and March, and dividing by 3:

3-month rolling average (February 1979)

$$= \frac{0.33 + 0.24 + 0.46}{3} = 0.34.$$

The 3-month rolling average for March 1979 likewise is calculated by summing the values for February, March and April 1979, and dividing by 3. Table 8.4 presents 3-month rolling averages using the data in Table 8.3, and Figure 8.16b presents these averages graphically. This technique reduces random variation,

**Table 8.4** Three-month rolling average percentage condemnation rates because of pneumonia and/or pleurisy (1979–83) at a Scottish abattoir. (Calculated from the data in Table 8.3.)

	Jan %	Feb %	Mar %	Apr %	May %	Jun %	Jul %	Aug %	Sep %	Oct %	Nov %	Dec %
1979		0.34	0.42	0.56	0.48	0.38	0.29	0.26	0.27	0.23	0.23	0.26
1980	0.31	0.39	0.47	0.54	0.57	0.52	0.39	0.32	0.27	0.30	0.36	0.41
1981	0.50	0.56	0.65	0.63	0.57	0.39	0.27	0.19	0.19	0.25	0.28	0.45
1982	0.56	0.72	0.77	0.68	0.55	0.35	0.34	0.55	0.66	0.99	0.88	0.92
1983	0.66	0.61	0.65	0.57	0.57	0.52	0.66	0.86	0.88	1.03	0.99	

and therefore may reveal underlying trends; an annual cyclic trend is clearly visible in Figure 8.16b.

The seasonal trend in this example cannot be explained readily. However, it is known that the prevalence of atypical pneumonia increases as the stocking density increases and as the altitude at which sheep are reared decreases (Jones and Gilmour, 1983). Thus, lowland, intensively reared sheep are more likely to develop pneumonia than hill sheep. Lambs slaughtered in the spring are most frequently from the lowlands, and lambs slaughtered in the late summer and autumn are most frequently from the hill; this policy therefore could explain the seasonal trend.

Two disadvantages of rolling averages are that the first and last elements of a data set cannot be averaged (January 1979 and December 1983 in Table 8.4), and the averages can be affected unduly by extreme values.

### Regression analysis

Regression analysis is a statistical technique for investigating relationships between two or more variables. It requires a knowledge of statistics and so the reader who is unfamiliar with basic statistics should read Chapters 12 and 14 before proceeding further.

Regression and correlation (the latter described in Chapter 14) are related. However, there is one major difference: a correlation coefficient may be evaluated if both or all variables exhibit random variation. Regression, however, involves the **selection** of individuals on the basis of one or more measurements (the explanatory variables) and then records the others (the response variables); therefore the explanatory variables should have no random variation. Discussion here will consider only one explanatory variable and one response variable.

When observations are made at defined intervals, these **selected** intervals of time represent the explanatory variable,  $x$ , which is why regression, not correlation, is applied to detecting an association between events and time. The technique can be applied to the data in Table 8.3.

A graph showing the variation of the mean of  $y$  in relation to  $x$  would show the relationship between  $y$  and  $x$  that is observed, in practice, with random vari-

ation. If it is assumed that the true values of  $y$ , for each value of  $x$ , lie in a straight line, then this line is known as the **regression line** of the linear regression of  $y$  on  $x$ . The slope of the line is termed the **regression coefficient** of  $y$  on  $x$ . This may be positive, negative, or, if  $x$  and  $y$  are unassociated, zero. The estimation of the regression coefficient and the intercept with the vertical axis, and the interpretation of the values of these estimates, is called **regression analysis**. If the relationship is not a linear one, then a suitable transformation of  $x$  or  $y$  or both, such as their squares or logarithms, may transform the relationship to linearity.

Assume that the equation of the true regression line is:

$$y = \alpha + \beta x,$$

where  $\beta$  is the regression coefficient, and  $\alpha$  is the intercept defining the point of interception of the  $y$  axis by the regression line. A set of  $n$  points  $(x, y)$  of observations is available to estimate this line. The regression coefficient,  $\beta$ , is estimated by:

$$b = \frac{\sum(x - \bar{x})(y - \bar{y})}{\sum(x - \bar{x})^2} \\ = \frac{\sum(xy) - (\sum x)(\sum y)/n}{\sum x^2 - (\sum x)^2/n}$$

The intercept,  $\alpha$ , is estimated by:

$$a = \bar{y} - b\bar{x}$$

Using the data in Table 8.3, the values of  $x$  being integers from 1 to 60 (i.e., monthly intervals for 5 years) and of  $y$  being the respective monthly condemnation rates:

$$\begin{aligned} \sum x &= 1830.0 & \sum y &= 30.820 \\ (\sum x)^2 &= 3\,348\,900 & \sum x^2 &= 73\,810 \\ \sum(xy) &= 1100.0 & n &= 60 \\ \bar{x} &= 30.500 & \bar{y} &= 0.513\,67. \end{aligned}$$

Thus:

$$b = \frac{1100.0 - (1830.0 \times 30.820)/60}{73\,810 - 3\,348\,900/60} \\ = 0.008\,89$$

and:

$$a = 0.513\ 67 - (0.008\ 89 \times 30.500) \\ = 0.2425.$$

The regression line now can be plotted, substituting the values of  $x$ , from 1 to 60, in the formula for the regression line, to determine the respective values of  $y$  (Figure 8.16a).

Thus, when  $x = 1$  (January 1979)

$$y = 0.2425 + 0.008\ 89 \times 1 \\ = 0.2514;$$

when  $x = 2$  (February 1979)

$$y = 0.2425 + 0.008\ 89 \times 2 \\ = 0.2603;$$

and so on.

Note that, in this example, the relationship between  $x$  and  $y$  is linear.

The effect of the secular trend can be removed by subtracting  $b(x - \bar{x})$  from each value of  $y$ . Thus, for July 1979,  $x = 7$  and:

$$b(x - \bar{x}) = 0.008\ 89(7 - 30.500) \\ = 0.008\ 89 \times (-23.500) \\ = -0.2089;$$

and the value of  $y$  with the secular trend removed is:

$$0.27 - (-0.2089) = 0.4789.$$

The results for the 60-month period, with the secular trend removed, are depicted in Figure 8.16c.

The effect of seasonal variation can be removed by calculating a 'seasonal index', in this example for each month. The value of  $y$  for each month of a year is taken as a proportion of the total of  $y$  for that year; these proportions are averaged for a particular month over the period of study (5 years in this instance) to give a seasonal index for each month of the year. The results are 'de-seasonalized' by dividing each value of  $y$  by the relevant monthly index multiplied by 12. Thus, for July 1979, the proportion of the total of  $y$  contributed by July is:

$$0.27 / (0.33 + 0.24 + 0.46 + 0.57 + 0.65 + 0.23 + 0.27 \\ + 0.37 + 0.14 + 0.30 + 0.24 + 0.14) \\ = \frac{0.27}{3.95} = 0.0684.$$

The proportions for July 1980, 1981, 1982 and 1983 are 0.0995, 0.0440, 0.0320 and 0.0759, respectively. The July seasonal index therefore is:

$$(0.0684 + 0.0995 + 0.0440 + 0.0320 + 0.0759) / 5 \\ = 0.3199 / 5 = 0.0640,$$

and the 'de-seasonalized' value for July 1979 is:

$$0.27 / (0.0640 \times 12) = 0.352.$$

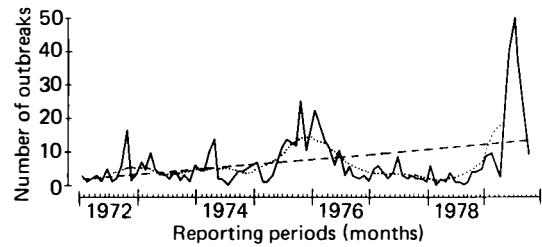

Fig. 8.17 Foot-and-mouth disease outbreaks reported by month, 12-month rolling average and trend, Paraguay, 1972–79. Raw data; ..... 12-month rolling average; --- trend. (From Peralta *et al.*, 1982.)

The 'de-seasonalized' results for the period of study are shown in Figure 8.16d.

Note that a considerable amount of random variation remains when the secular and seasonal trends are removed (Figures 8.16c and d, respectively); this variation tends to obscure the seasonal trend in Figure 8.16c, and the secular trend in Figure 8.16d. In such circumstances, calculation of rolling averages provides a rapid means of reducing random variation. An increase in sample size also should reduce the effects of this variation. A formal significance test may be required when the effects of random variation are considerable. A description of a suitable test, and the estimation of the standard error and confidence limits of  $\beta$ , is given by Freund and Wilson (1998).

Figure 8.17 shows the results of a time series analysis of foot-and-mouth disease in Paraguay (Peralta *et al.*, 1982). The disease shows a cycle with a periodicity of 3–4 years (peaks in 1972, 1975–76 and 1979), due to type O virus. The small peak in 1974 that was not consistent with the cycle was caused by a sporadic outbreak due to type C virus. The reason for the cyclicity may be the changes in the proportion of the susceptible cattle population, 3–4 years being necessary to increase again the number to the threshold level. Identification of this temporal pattern can indicate times when particular attention should be paid to control.

A similar time series analysis of rabies in Chile, comparing the disease's temporal pattern before and after implementation of a control campaign (Ernst and Fabrega, 1989), is depicted in Figure 8.18. There was a slight, but statistically significant, secular increase in rabies between 1950 and 1960, attributable to cases in dogs, when no control was undertaken (Figure 8.18a). A national control programme, involving vaccination of humans and dogs, was instituted in 1961, and rabies declined between 1961 and 1970 (Figure 8.18b). The steady decline continued between 1971 and 1986 (Figure 8.18c). No cases were reported in 1982, but a previously undescribed sylvatic cycle was reported in insectivorous bats in 1985 and resulted in cases in dogs

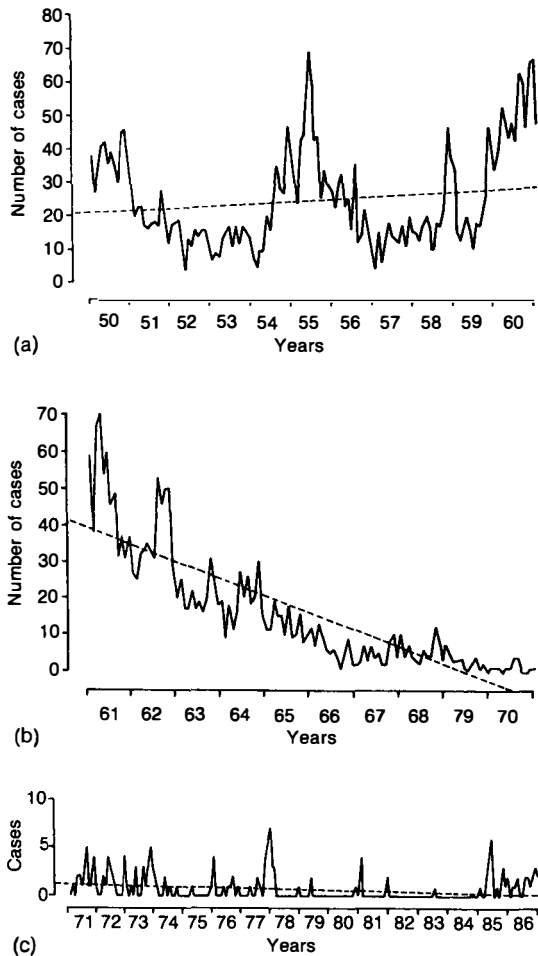

**Fig. 8.18** Total number of laboratory-confirmed cases of rabies reported by month and trend, Chile, 1959–86. (a) 1950–60, (b) 1961–70, (c) 1971–86. — Raw data; --- trend. (From Ernst and Fabrega, 1989.)

and cats (Figure 8.18c). This study also revealed a seasonal trend, and a 5-year cyclical trend, possibly associated with fluctuations in the size of the susceptible dog population.

Regression is discussed in standard introductory statistics texts such as that by Petrie and Watson (1999) and, in the context of time series analysis, by Shumway and Stoffer (2000).

## Trends in the spatial and temporal distribution of disease

### Spatial trends in disease occurrence

An epidemic represents not only the clustering of cases over a period of time, but also a clustering of cases in a defined area. An infectious disease that propagates through a population results in a **contagious** spatial pattern, in contrast to sporadic outbreaks that are

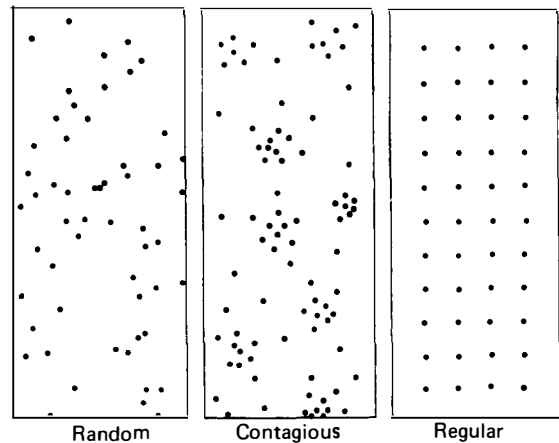
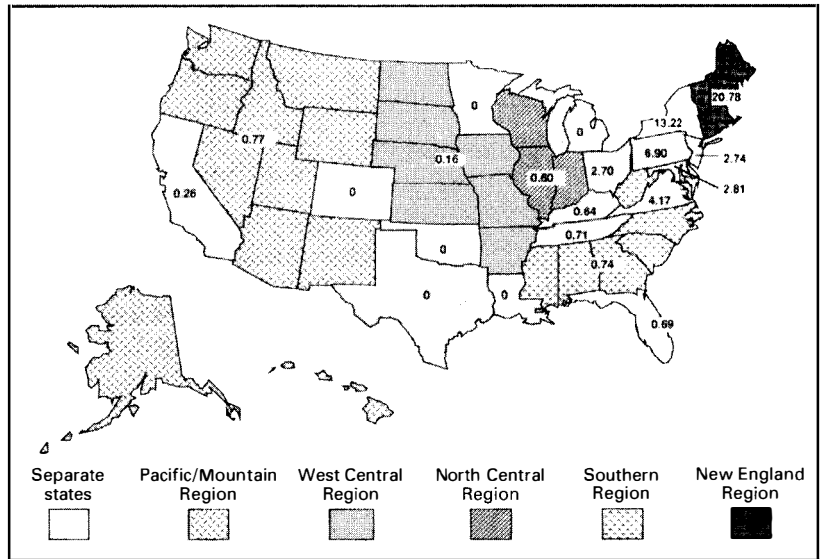

**Fig. 8.19** Patterns of the spatial distribution of disease. (From Southwood, 1978.)

distributed **randomly**. These two patterns can be compared with **regular** spatial occurrence (Figure 8.19). 'Contagious' can also be applied, in a general sense, to the spatial clustering of disease, whether or not it is infectious (ecologists sometimes use 'over-dispersion' to refer to this type of spatial clustering in animal populations, with 'under-dispersion' referring to more regular spacing).

A variety of statistical distributions (see Chapter 12) serve as models for the spatial distribution of events (Southwood, 1978). The Poisson distribution has commonly been applied. The goodness of fit of a set of data to the Poisson distribution can be tested by performing a  $\chi^2$ -test on the observed and expected values; standard statistical texts, such as Bland (2000), give details. If the variance is less than the mean, it implies the occurrence of a more regular distribution than is described by a Poisson series. If the variance is greater than the mean, it implies that a 'contagious' distribution is present.

Identification of spatial clustering can assist in the identification of the cause of disease (Rothman and Greenland, 1998). Thus, the clustering of feline leukaemia among genetically unrelated cats provided early evidence of horizontal transmission and therefore of the disease's infectious nature (Brodey *et al.*, 1970). It may also indicate areas for further investigation. For example, equine motor neuron disease is a degenerative condition, which occurs in North America and parts of South America, Europe and Asia. Its cause is unknown, but, in the US, vitamin E deficiency appears to play a role (de la Rúa-Domènech *et al.*, 1997; Polack *et al.*, 2000). It also shows distinct spatial clustering in the US, with the highest incidence in the north-east (Figure 8.20). Variation in the geographical distribution of reported risk factors (age and breed) and other potentially confounding factors (sex and month of diagnosis) does not explain the



**Fig. 8.20** State-specific or region-specific incidence rates of equine motor neuron disease (cases per 1 000 000 horse-years at risk) in 21 geographical units in the US, January 1985–January 1995. (From de la Rúa-Domènech *et al.*, 1995.)

clustering (de la Rúa-Domènech *et al.*, 1995), suggesting that exploration of regional variations in management and husbandry practices may give clues to the cause of the disease.

The methods for identifying different spatial patterns are reviewed by Pfeiffer (2000) and described in detail by Cliff and Ord (1981).

### Space–time clustering

Space–time clustering is an interaction between the places of onset and the times of onset of a disease; cases that are close in space tending to be close in time. The Poisson distribution sometimes can be applied to this type of interaction – particularly for large samples (David and Barton, 1966). Techniques for detecting space–time clustering are beyond the scope of this book. They are described by Knox (1964), David and Barton (1966), Mantel (1967) and Pike and Smith (1968). They are reviewed by Williams (1984), Schukken *et al.*

(1990), Pfeiffer (2000), Ward and Carpenter (2000a,b) and Carpenter (2001).

### Further reading

- Bailey, N.T.J. (1975) *The Mathematical Theory of Infectious Diseases*, 2nd edn. Charles Griffin and Company, London and High Wycombe
- Cliff, A.D. and Haggett, P. (1988) *Atlas of Disease Distributions: Analytic Approaches to Epidemiological Data*. Basil Blackwell, Oxford
- Devesa, S.S., Donaldson, J. and Fears, T. (1995) Graphical presentation of trends in rates. *American Journal of Epidemiology*, **141**, 300–304. (*Guidelines on depicting trends in disease occurrence.*)
- Durr, P.A. and Gatrell, A.C. (Eds) (2004) *GIS and Spatial Analysis in Veterinary Science*. CABI Publishing, Wallingford
- Halpin, B. (1975) *Patterns of Animal Disease*. Baillière Tindall, London
- Sinnecker, H. (1976) *General Epidemiology* (translated by N. Walker). John Wiley and Sons, London

# 9

## The nature of data

The epidemiologist investigates the frequency and distribution of disease (and sometimes other characteristics, such as performance) in groups of animals. This involves the collection and analysis of **data** (singular: datum): 'facts, especially numerical facts, collected together for reference or information' (*Oxford English Dictionary*, 1971). These data may relate to clinical signs, therapy, and post-mortem and laboratory examinations. If an investigation is undertaken prospectively, the epidemiologist has to decide what data should be collected. If an investigation is undertaken retrospectively, the epidemiologist may use data that have been collected by veterinary practices, abattoirs, laboratories, clinics, and other organizations (see Chapter 10). Therefore, it is necessary to know whether the types of data that are collected are suitable for a particular investigation.

Inferences about the cause of disease involve categorizing individuals into a group that has a disease and a group that does not have the disease, the object being to decide whether these two groups differ with respect to possible determinants. This is the basis of observational studies (outlined in Chapter 2 and detailed in Chapter 15). Animals are put into the diseased category because they possess certain attributes, such as clinical signs and lesions, that are used to define, and sometimes to name, the disease. Knowledge of the various features that are pertinent to the classification of disease is therefore necessary.

Some data are observations; for example, the recording of diarrhoea. Other data are interpretations of observations; for instance, a diagnosis, which represents an interpretation of a set of clinical signs, lesions and laboratory results. The interpretation, and therefore the diagnosis, may be incorrect; this could result in animals being erroneously categorized as having a particular disease. Any inferences on association

between possible causal factors and disease, drawn from a study of such animals, may therefore be erroneous.

Additionally, some data that epidemiologists use nowadays are stored in computers as codes.

### Classification of data

Data can be broadly classified into **qualitative** and **quantitative** (Figure 9.1).

Qualitative data describe a property of an animal; that is, its membership of a group or class. Such data therefore are termed **categorical**. Examples are the breed and sex of an animal.

Quantitative data relate to **amounts**, rather than just indicating classes. Examples are prevalence, incidence, body weight, milk yield, temperature and antibody titre. These data may be further divided into **discrete** and **continuous**.

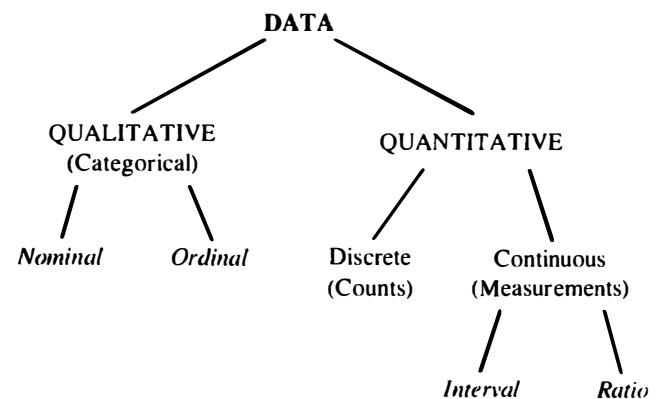

Fig. 9.1 A broad classification of data. Scales (levels) of measurement are italicized.

Discrete data can have only one of a specified set of values, such as whole numbers (1, 2, 7, 9, etc.); for example, the number of teats on a sow. Discrete data generate **counts**. Thus, aggregates of qualitative (categorical) data are counted (e.g., the total number of male dogs or Friesian cows).

Continuous data may have any value within a defined range (though the range can be infinite). Examples are the girth of a cow and its body weight. Continuous data are usually quantified by comparison with a fixed unit; that is, they are measured. Continuous data therefore generate **measurements**.

## Scales (levels) of measurement

Although measurement can be applied strictly only to quantitative, continuous data, 'scale of measurement' is also conventionally used to describe the 'strength' of values that can be attached to both qualitative and quantitative data. There are four main scales (levels) of measurement (Stevens, 1946): **nominal**, **ordinal**, **interval** and **ratio** (Figure 9.1); and a **visual analogue scale** is also sometimes used.

### The nominal (classificatory) scale

This scale involves the use of numbers (or other symbols) to classify objects. Thus, male and female can be **coded** 1 and 2, respectively, and a non-veterinary example is the use of numbers or letters on aircraft or car number plates to indicate their origin. The property of a nominal scale is **equivalence**: members in a class must possess the same property.

The only legitimate operation that can be performed on a nominal scale is transformation of the symbols. For example, if the disease, diabetes, was numerically coded as 671, then this value could be transformed or changed to 932 for **all** diabetics. This scale is a 'weak' form of 'measurement'.

### The ordinal (ranking) scale

The ordinal scale allows groups to be related to other groups. Most commonly, the relation can be expressed in terms of equal to, greater than (>) or less than (<). Examples are the use of body condition scores for sheep (Russel, 1991), cattle (DEFRA, 2001), horses (Henneke *et al.*, 1983) and dogs and cats (Lund *et al.*, 1999), and clinical grading of severity of disease, such as lameness (Table 9.1).

The difference between the nominal and the ordinal scale therefore is that the ordinal includes not only equivalence but also the 'greater than' and 'less than' property.

In the ordinal scale, any transformation must preserve the order. It does not matter what number is attached to a class, as long as the relationship with other classes is consistent. Thus, a carcass condition score scale can include 5 = 'good' and 1 = 'poor', and equally 1 = 'good' and 5 = 'poor', as long as the numbers between 1 and 5 maintain the same order of ranking. Although 'stronger' than the nominal scale, the ordinal scale is still a relatively 'weak' form of 'measurement'.

### The interval scale

In an interval scale, the distance between the ranked values is known with some accuracy. A good example is body temperature. Two thermal interval scales commonly are used – Celsius and Fahrenheit – each containing the same amount of information. The ratios of the intervals (temperature differences in this example) are independent of the zero point (0°C = 32°F) and are equal to the ratios of the differences on the other interval scales. For example:

$$\begin{aligned} 37^{\circ}\text{C} &= 99^{\circ}\text{F} \text{ (approximately)} \\ 22^{\circ}\text{C} &= 72^{\circ}\text{F} \text{ (approximately)} \\ 6^{\circ}\text{C} &= 43^{\circ}\text{F} \text{ (approximately)}. \end{aligned}$$

$$\text{Thus } (^{\circ}\text{C}) \frac{37 - 22}{22 - 6} = \frac{15}{16} = 0.9375$$

$$\text{and } (^{\circ}\text{F}) \frac{99 - 72}{72 - 43} = \frac{27}{29} = 0.9310344 \dots$$

that is, the ratios are approximately the same (0.9).

The interval scale therefore includes equivalence, 'greater than' relationships, and ratios of intervals. Because the ratios are independent of the zero point, arithmetic calculations can be performed only on differences between numbers. The interval scale is a relatively 'strong' form of (actual) measurement.

### The ratio scale

The ratio scale is an interval scale with a true zero point. Weight is a ratio scale. The various weight ratio scales may have units of kilograms, grams, pounds or ounces, but they all start from the same zero point. This means that arithmetic operations can be performed not only on the ratios of differences but also on the numbers themselves. Note that a ratio scale is not necessarily associated with ratios, many of which are ratios of counts (e.g., prevalence; see Chapter 4). Weight, for instance, is a ratio scale that is not a ratio.

### The visual analogue scale

The visual analogue scale (VAS) uses a straight line, usually 10 cm long, the extreme limits of which are



**Table 9.1** A scoring scheme for lameness in pigs. (From Main *et al.*, 2000.)

Lameness score	Initial response to human presence	Pig's response after opening gate	Behaviour of individual within the group	Standing posture	Gait
0	Bright, alert and responsive (pigs rise immediately and approach inquisitively)	Inquisitive, will tentatively leave pen	Freely participates in group activity	Pig stands squarely on all four legs	<b>Even strides.</b> Caudal body sways slightly while walking. Pig is able to accelerate and change direction rapidly
1	As for score 0	As for score 0	As for score 0	As for score 0	<b>Abnormal stride length</b> (not easily identified) <b>Movements no longer fluent</b> – pig appears stiff. Pig still able to accelerate and change direction
2	As for score 0	As for score 0	May show mild apprehension to boisterous pigs	<b>Uneven posture</b>	Shortened stride. Lameness detected. Swagger of caudal body while walking. No hindrance in pig's agility
3	Bright but less response (may still remain down, or 'dog-sitting', before eventually rising)	Often last to leave pen	Apprehensive to boisterous pigs (usually remains separate from group activity)	<b>Uneven posture. Will not bear weight on affected limb</b> (appears to be standing on toes)	Shortened stride. Minimum weight-bearing on affected limb. Swagger of caudal body while walking. Will still trot and gallop
4	May be dull (only rises when strongly motivated)	<b>Unwilling to leave familiar environment</b>	Will try to remain separate from others within the group	<b>Affected limb elevated off floor.</b> Pig appears visibly distressed	<b>Pig may not place affected limb on the floor while moving</b>
5	<b>Dull and unresponsive</b>	No response	May appear distressed by other pigs in the group but may be unable to respond	Will not stand unaided	<b>Does not move</b>

**Bold type** – identifies the defining criteria that must be present to assign a score. Normal type shows supporting criteria that are useful for assigning a score.

marked with perpendicular lines. Both ends have a verbal description of each extreme of the variable that is being measured; *Figure 9.2* is an example of a VAS for recording severity of lameness in sheep. The observer marks the line in a position corresponding to the 'severity' of the variable that is being evaluated, and its position from the zero point is measured with a ruler (usually to a precision of 1 mm). The VAS is commonly used in human medicine to assess pain, and has been similarly applied in veterinary medicine (Reid and Nolan, 1991; Lascelles *et al.*, 1997; Holton *et al.*, 1998; Thornton and Waterson-Pearson, 1999; Kent *et al.*, 2004)<sup>1</sup>.

<sup>1</sup> The assessment of pain is complex, and there are differences between the veterinary and human fields (for veterinary and human definitions of pain, see Molony (1997) and IASP (1979), respectively). In the former, assessment is, of necessity, based on observations, whereas, in the latter, it includes subjective assessment and emotional responses by the affected individual (Melzack, 1983, 1987). There are, however, similarities between assessment in infants and animals, where, in the absence of speech, physiological and behavioural changes may be used as indicators (Anand and Craig, 1996; Hardie, 2000; Holton *et al.*, 2001).

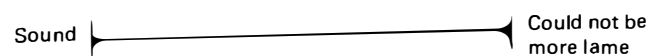

**Fig. 9.2** An example of a visual analogue scale: severity of lameness in sheep (reduced). (From Welsh *et al.*, 1993.)

Ordinal and visual analogue scales are relatively simple, non-invasive ways of recording severity of lesions and clinical signs, and so are attractive options for recording changes in patients' status in clinical trials (see Chapter 16). However, both scales are subjective. For example, the lameness scoring system for pigs (*Table 9.1*), and similar schemes for lameness in poultry (Kestin *et al.*, 1992), cattle (Manson and Leaver, 1988) and sheep (Welsh *et al.*, 1993), are based on individuals' observations and subsequent classification of them (e.g., 'even strides' and 'movements no longer fluent' in *Table 9.1*). Similarly, scoring of gastric lesions in horses may involve 'mild hyperkeratosis' or 'moderate hyperkeratosis' (Murray *et al.*, 1996) or 'superficial' and 'deep' (MacAllister *et al.*, 1997). Some

**Table 9.2** REQ<sup>†</sup> scoring for assessing pain in lambs. (Reprinted from *Applied Animal Behaviour Science*, 76, Molony *et al.* Validation of a method for assessment of an acute pain in lambs, 215–238. © (2002), with permission of Elsevier.)

Behaviour	Description
Restlessness	Number of times a lamb stood up and lay down; each unit scored included both the act of rising and lying down. Instances of the lamb rising as far as its knees were included in the count
Rolling	Lamb rolled from lying on one side, to the other without getting up. Half rolls where the lamb rolled on its back and then returned to lying on the same side were included
Jump	Lamb moved forward using 'bunny hops' with its hind limbs
Foot stamping and kicking	One action was recorded when either a front or hind limb (usually hind limb) was lifted and forcefully placed on the ground while standing or was used to kick while standing or lying
Easing quarters	One action was recorded each time a front or hind limb, including the shoulder and hindquarters, was moved in a less forceful manner than stamping or kicking, or the whole body was shifted or eased without moving from the place of rest; tensing of leg muscles was also included. Stretching with the forelegs forward and with the hind limbs back was recorded separately and included in this category

<sup>†</sup> REQ = Restlessness . . . Easing Quarters

scoring schemes may be particularly complex; for example, canine hip dysplasia (Gibbs, 1997) and stress (María *et al.*, 2004). Different observers therefore may put a different interpretation on what they see. Consequently, the accuracy and repeatability (see below) of these scales are complex, and may be influenced by the experience of the observer (Kent *et al.*, 2001). Repeatability can vary along the length of a VAS (Dixon and Bird, 1981) and ordinal scale (Main *et al.*, 2000), with consistency logically more likely at the extremes. Welsh *et al.* (1993) demonstrated good correlation<sup>2</sup> between the two scales, and between repeated measurements on the same animals, when assessing lameness in sheep. Main *et al.* (2000) also found the repeatability of the ordinal scoring scheme given in Table 9.1 to be high, when undertaken by observers who were familiar with it.

These scales of measurement have been considered in detail because of their importance in determining appropriate statistical methods. Most statistical tests can be used with interval and ratio scales. However, not all tests can be applied to nominal, ordinal and visual analogue scales. This point will be expanded in Chapter 14.

## Composite measurement scales

The measurements described so far either comprise objective, single values (e.g., weight) or single subjective values based on several qualitative criteria (e.g., the lameness scoring scheme given in Table 9.1). Scales may also be devised by numerically combining nom-

inal, ordinal, and interval and ratio data; these are termed **composite measurement scales** (CMSs).

Table 9.2, for example, summarizes the components of a CMS for acute pain in lambs following castration and tail-docking. The scale – termed REQ scoring (named from the initial letters of its first and last components) – sums the frequency of observation of various behavioural characteristics over a period of time (usually 30–60 minutes) after the procedures were undertaken.

There is a danger that CMSs may be constructed somewhat arbitrarily, without evaluation of their properties; notably (1) **content validity**: do they capture all aspects of the characteristic that they purport to assess (e.g., pain), and (2) **construct validity**: do they adequately reflect the qualities of the characteristic?<sup>3</sup> Assessment of these characteristics of a CMS and reliability is complex (Coste *et al.*, 1995). The validity of the REQ CMS, for example, was judged by assessing the extent to which its scores correctly allocated lambs to different treatment groups intuitively ranked according to severity (e.g., bilateral castration and tail-docking with rubber rings was assumed to induce more pain than bilateral castration alone). The validity was deemed to be high, allowing this CMS to be used subsequently in a clinical trial of different techniques of castration and tail-docking (Kent *et al.*, 2004). If such CMSs for pain, based on observed behavioural changes, are valid, they offer advantages over VASs, many of which require the development of considerable assessment skills (Firth and Haldane, 1999) and

<sup>2</sup> Note, however, that *correlation* is not the same as *agreement* (see Chapter 17).

<sup>3</sup> These terms are more formally defined: (1) **content validity** – the extent to which a measurement incorporates the domain of the phenomenon under study, (2) **construct validity** – the extent to which a measurement corresponds to the theoretical concepts (constructs) concerning the phenomenon under study (Last, 2001).

**Table 9.3** Scales for recording lung lesions in some vaccination trials against *Mycoplasma hyopneumoniae*.

Measurement scale	Reference
Ordinal: lung-lesion score	Dawson <i>et al.</i> (2002)
Continuous: percentage of pigs with maximum lung-lesion scores	Petersen <i>et al.</i> (1992)
Nominal: 'ongoing', 'healing' or 'healthy'	Wallgren <i>et al.</i> (1998)
Continuous: percentage consolidation of lungs	Ristow <i>et al.</i> (2002)
Continuous: percentage of pigs with pneumonic lesions	Pommier <i>et al.</i> (2000)

have not had their reliability assessed (Holton *et al.*, 1998).

The variety of measurement scales that may be used may make it difficult to make comparisons between various studies addressing the same issue; notably, in meta-analysis (see Chapter 16). *Table 9.3*, for example, list the scales of measurement that have been used to assess efficacy of vaccination against mycoplasmal pneumonia in pigs, where lung lesions were used as the main indicators of resistance following challenge with the microbe (either in the field or experimentally). It is difficult to match an ordinal score, both with a percentage (i.e., from 0 to 100) and a nominal categorization, all of which are used as scales of measurement (either at the individual-animal or herd level) in the various studies listed in *Table 9.3*.

## Data elements

### Nomenclature and classification of disease

Nominal data relating to disease frequently include the names of diseases. The name given to a disease is closely associated with the way in which a disease is classified. Diseases are defined at three levels (*Figure 9.3a*) in relation to:

1. specific causes;
2. lesions or deranged functions;
3. presenting problems.

Diseases are generally named according to their allocation to one of these three levels; for example, parvovirus infection (specific cause), hepatitis (lesion) and ataxia (presenting problem). A fourth method of naming involves the use of eponyms; for example, Rubarth's disease and Newcastle disease.

The situation is frequently more complicated: a presenting problem may have more than one set of

lesions and specific causes (*Figures 9.3b* and *9.3c*). Similarly, one specific cause may produce more than one lesion and therefore more than one presenting sign (*Figure 9.3d*).

Veterinarians usually define (and therefore record) disease as a diagnosis in terms of a combination of specific cause, lesion and presenting problem. Sometimes one or more levels may be missing; thus, the dilated pupil syndrome in cats (feline dysautonomia) is defined in terms of lesions and presenting problem, although the specific cause is unknown (Gaskell, 1983). Initially this disease was eponymously named the 'Key-Gaskell syndrome'.

### The significance of the nomenclature and classification of disease in epidemiological investigations

Different sectors of the veterinary profession require different types of information for their work. Pathologists have a major interest in lesions. When notifiable diseases occur, administrators act according to sets of rules that are defined by legislation; the classification of these diseases is of little consequence to the action that is taken. Similarly, epidemiologists who undertake surveys of morbidity that do not involve the testing of a causal hypothesis are concerned only with identification of a disease, irrespective of the way in which it is classified or named. However, the method of classifying disease is important in causal investigations.

The classification shown in *Figure 9.3* can be simplified to two methods:

1. by **manifestations**, namely signs and lesions;
2. by **cause**.

An epidemiological causal investigation attempts to detect associations between causal factors and disease. The investigation therefore is conducted because one or more component causes are not known. In such a case, the disease that is being studied is frequently named according to manifestations. For example, considering *Figure 9.3b*, if the disease being studied were defined as ataxia (a presenting sign which is a manifestation), then ataxia animals would be heterogeneous with respect to cause; four separate sufficient causes, with different component causes, could be involved. This would make causal inference more difficult than if there were only a single sufficient cause that was common to all animals classified as diseased. Similarly, in *Figure 9.3c*, if disease were defined as polioencephalomalacia (a lesion, which is a manifestation), then the animals with the lesion could also be heterogeneous with respect to cause. Classification by cause in *Figure 9.3a* assists causal inference, because a common sufficient cause may be demonstrated in all cases of animals that are classified as diseased.

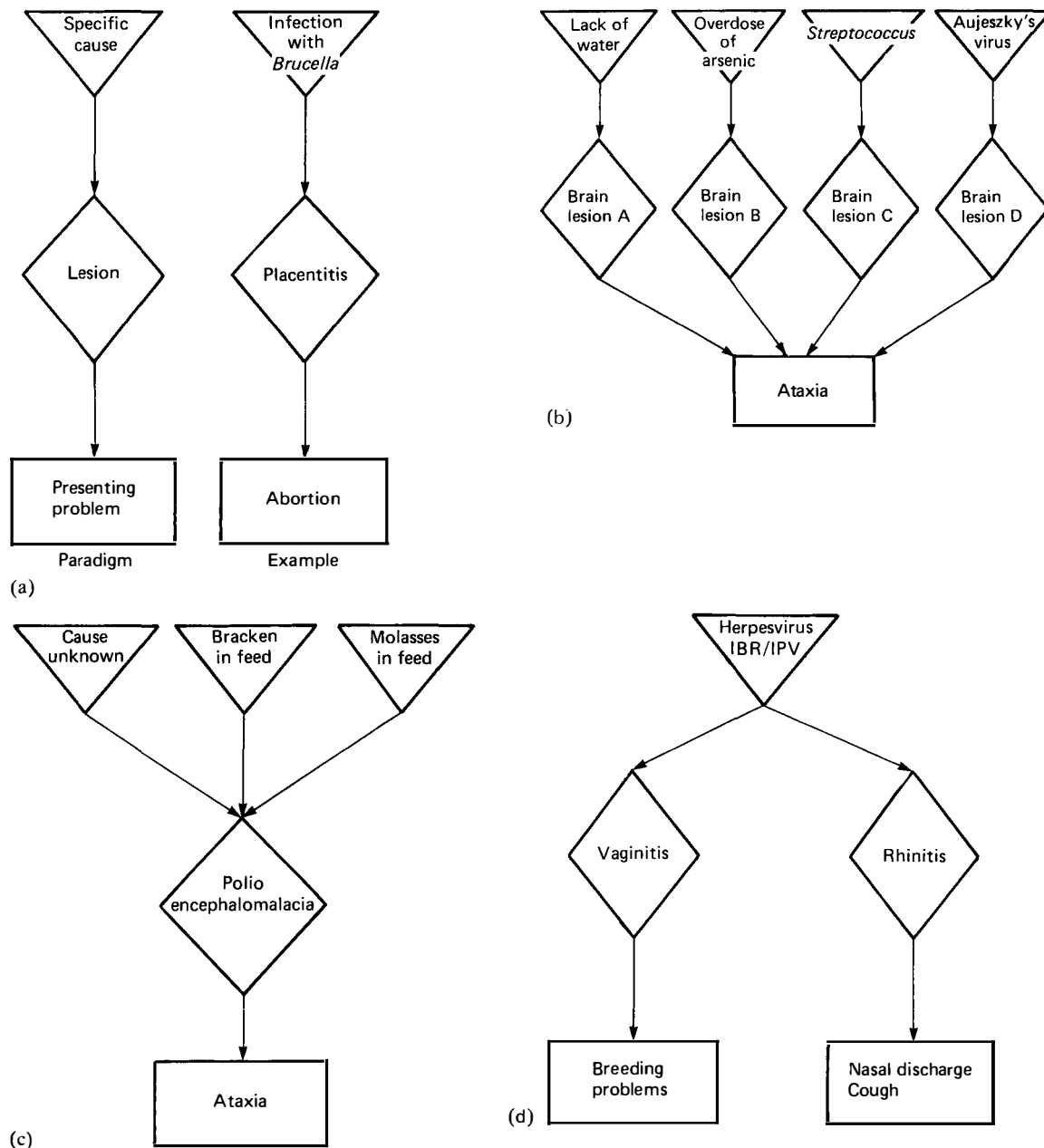

**Fig. 9.3** (a) The three levels of disease classification. (b) A presenting problem common to multiple sets of lesions and specific causes. (c) A presenting problem and a lesion common to multiple specific causes. (d) A specific cause with divergent sets of lesions and presenting problems. In terms of causal model 1 (Chapter 3), a specific cause represents a major component of a sufficient cause. ((a) Modified from Hall, 1978; (b) (c) and (d) from Hall, 1978.)

Frequently, only suboptimal data relating just to manifestations (often just signs) are available, and they must be used with due regard to their defects, or as the basis of more detailed investigations. Russell *et al.* (1982), for example, were aware that lameness (a datum defining disease in terms of presenting signs, and frequently involving several lesions and causes) was a problem in British dairy herds, and used this as the starting point for an investigation in which they

attempted to elucidate the underlying lesions and causes, by means of a questionnaire, before trying to develop suitable control strategies.

### Diagnostic criteria

Disease can be diagnosed using one or more of four criteria:

1. clinical signs and symptoms<sup>4</sup>;
2. detection of specific agents;
3. reactions to diagnostic tests;
4. identification of lesions.

### Observational and interpretive data

Records relating to the four diagnostic criteria may be of either **observations** or **interpretations** (Leech, 1980). The terms overlap in that observations usually imply a comparison with the normal which itself is often a matter of judgement. For example, to observe and record that a cow is diarrhoeic implies that its faeces are less firm than those of its peers, and must also take into account that cows at peak yield, receiving much concentrate, usually have loose faeces.

A clinical sign may represent an observation; for example nasal discharge. A diagnosis represents an interpretation of one or several observations. Distemper, for example, is a diagnosis that implicitly involves the interpretation of several signs, including perhaps nasal discharge, diarrhoea and coughing.

Specific agents may be observed; for instance species of *Babesia* may be identified in a blood smear. Alternatively, the presence of agents may be recorded interpretatively; for example the presence of *Escherichia coli* in the faeces of an animal with diarrhoea may be recorded as being 'not clinically significant'.

Test reactions may be observed; for example the recording of antibody titres in serological tests. Results may also be interpreted, for example the result of an intradermal tuberculin test may be recorded as 'inconclusive'.

Pathological lesions may be observed; for example an histological description of a skin tumour may be given. This description may then be interpreted as a diagnosis; for example defining a skin tumour as equine sarcoid.

Interpretation involves the use of currently acceptable diagnostic criteria. The recording of 'distemper', mentioned above, assumes a causal association between a particular virus and several signs. This assumption, based upon previous experimental work and many field observations, has been acceptable for many years. Similarly, the recording of *E. coli* as being 'not clinically significant' in some diarrhoea cases uses a criterion based upon current knowledge of commensalism.

Sometimes, however, diagnostic criteria may be difficult to define; for example when the histological appearance of a tumour can vary considerably (e.g., equine sarcoid: Ragland *et al.*, 1970). Additionally, criteria may be complex and subject to change. Thus,

navicular disease has historically had several criteria for its diagnosis, including heel pain, soundness following palmar digital nerve block, and radiological evidence of enlarged vacular foramina, cystic formations, thinning of the flexor cortex, marginal osteophytosis and remodelling of the normal shape of the bone (McClure, 1988). However, many conditions causing heel pain can be blocked by palmar digital nerve block, and studies suggest that there is no difference between the frequency of radiographically identified lesions of navicular disease in clinically affected animals and animals with no history of lameness (Turner *et al.*, 1987).

An observational datum is easily recorded in full. However, it is difficult to record an interpretative datum fully; this would require not only the interpretation (e.g., a diagnosis) but also a record of the criteria used in the interpretation. In many cases, the criteria are implicit, as in the case of distemper, and so are not recorded explicitly. In others, where diagnostic criteria are complex (e.g., navicular disease), the criteria should be listed, otherwise comparison between cases (past, present and future) is impossible.

Observational and interpretative data are applied in different ways. Veterinary administrators, organizing national disease control campaigns, frequently use interpretative data to make decisions. For example, an animal's future may depend upon whether it reacts 'negatively', 'inconclusively' or 'positively' to screening tests.

Epidemiological investigations, particularly of diseases of unknown aetiology, require data such as details of diet, exposure to possible causal agents, and the various stages of a disease's pathogenesis, that are unambiguous. In this context, interpretative data may be misleading. Thus, when investigating obesity, it is better to have even an approximate estimate of an animal's body weight and food intake, than to have a subjective (interpretative) impression of its weight as 'heavy' or 'light', and its food intake as 'a little' or 'a lot', because these terms may represent different weights and amounts of food to different people. Observational studies also require an unambiguous, consistent definition of cases, and so the diagnostic criteria used to classify animals as diseased and healthy should be specified.

### Sensitivity and specificity

Events may be recorded as being true when, actually, they are not. Thus, a dog may be diagnosed as having diabetes mellitus when it does not. This constitutes a **false positive** record, and renders the diagnosis inaccurate. The error in this case may have resulted from an improper inference based upon only a few clinical signs such as polyphagia and polydipsia, with no

<sup>4</sup> A sign is an abnormal feature of the patient that is observed; a symptom is a subjective abnormal feature that is described by the patient himself in human medicine.

**Table 9.4** Possible results of a diagnostic test exemplified by application of a centrifugation/flotation technique to horses of known tapeworm status. (From Proudman and Edwards, 1992.)

Test status	True status		Totals
	Positive	Negative	
Flotation positive	22(a)	1(b)	23
Flotation negative	14(c)	43(d)	57
Total	36	44	

Sensitivity =  $a/(a + c) = 22/36 = 0.61$  (61%)  
 Specificity =  $d/(b + d) = 43/44 = 0.98$  (98%)

supporting biochemical evidence. Alternatively, diabetes may not be diagnosed when it is actually present. This constitutes a **false negative** record. Such errors inevitably lead to misclassification of 'diseased' and 'non-diseased' animals. These errors can occur when using clinical signs, detection of specific agents and reactions to diagnostic tests as diagnostic criteria.

These errors can be quantified by comparing results obtained by the diagnostic method with those obtained from an independent valid criterion. For example (Table 9.4), the validity of a faecal centrifugation/flotation technique in diagnosing equine cestodiasis can be determined by comparing the results of the test with those obtained from post-mortem examination of the intestinal tract to identify tapeworms (the independent valid criterion).

The **sensitivity** of a diagnostic method is the proportion of true positives that are detected by the method. The **specificity** of the method is the proportion of true negatives that are detected. Sensitivity and specificity can be quoted either as a probability between zero and one, or as a percentage. Thus, the sensitivity and specificity of the centrifugation/flotation technique are 0.61 and 0.98, respectively (Table 9.4); that is, 61% and 98%, respectively.

The sensitivity and specificity of a diagnostic test are important in deciding the value of the test in disease control campaigns (see Chapter 17) and in categorizing animals in observational studies (see Chapter 15).

## Accuracy, refinement, precision, reliability and validity

These terms can be used in relation to qualitative data (e.g., the description of a disease) and to quantitative measures (e.g., of prevalence and weight).

### Accuracy

**Accuracy** is an indication of the extent to which an investigation or measurement conforms to the truth.

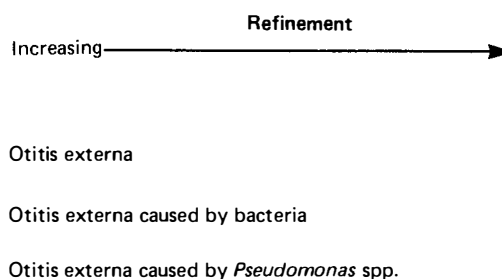

**Fig. 9.4** Example of increasing refinement of a diagnosis.

Thus, if a set of scales records an animal's weight at 15 kg and this is the actual weight of the animal, then the measurement is accurate.

### Refinement

The degree of detail in a datum is its **refinement**. Thus, 13 kg and 13.781 kg may both represent the accurate weight of an animal, but the second record is more refined than the first. Similarly, 'orthopaedic surgery' is a less refined description of a surgical technique than is 'bone plating'. In Figure 9.4, 'otitis externa' is a less refined diagnosis than either 'otitis externa caused by bacteria' or 'otitis externa caused by *Pseudomonas* spp.'. The less refined definition may be described as 'coarse grained', and the more refined definitions as 'fine grained' by analogy with photographic film (Cimino, 1998). Specificity is sometimes used synonymously with refinement.

Increasing the refinement of descriptive diagnostic data may improve their epidemiological value because it usually moves towards a definition of disease in terms of particular sufficient causes (see Chapter 3), whereas a less refined definition in terms of manifestations can include several sufficient causes (Figure 9.3c).

Auxiliary tests are frequently required to increase the refinement of a diagnosis. Thus, physical examination may facilitate the diagnosis of otitis externa, but a more refined diagnosis of otitis externa involving *Pseudomonas* spp. infection would require the use of microbiological techniques. The refinement of auxiliary techniques may also vary. For example, the complement fixation test will detect types of influenza A virus, but will not detect subtypes. Identification of the latter requires more refined tests; for example haemagglutination and neuraminidase inhibition.

### Precision

**Precision** can be used in two senses. First, it can be used as a synonym for refinement. Secondly, it can be used statistically to indicate the consistency of a series of measurements. Thus, repeated sampling of a population may allow estimation of a prevalence value of,

say,  $40\% \pm 2\%$ . Alternatively, the value may be estimated as  $40\% \pm 5\%$ . The first estimation is more precise than the second. Precision, in the second sense, is discussed in more detail in Chapter 12.

### Reliability

A diagnostic technique is **reliable** if it produces similar results when it is repeated. Thus **repeatability** is a characteristic of a reliable technique. This is defined in terms of the degree of agreement between sets of observations made on the same animals by the same observer (see Chapter 17). This contrasts with **reproducibility**, which can be defined in terms of agreement between sets of observations made on the same animals by **different** observers: BSI (1979)<sup>5</sup>.

### Validity

If a diagnostic technique measures what it purports to measure, it is **valid**. Validity is a long-term characteristic of a technique, of which sensitivity and specificity are indicators. The validity of a technique depends upon the disease that is being investigated and the method of diagnosis. A midshaft femoral fracture, for example, may be diagnosed very accurately when using only physical examination (*Figure 9.5*): the lesion is rarely misdiagnosed; thus physical examination, as a diagnostic technique, is highly valid in this instance. However, physical examination alone may not be considered sufficiently error-free when used to diagnose diabetes mellitus. Biochemical examination, in this case urine analysis, may be used to decrease error, and fasting blood sugar estimation to decrease it further. The use of auxiliary diagnostic aids, such as biochemical, radiological and microbiological investigation, is simply a means of increasing the accuracy of a diagnosis by selecting diagnostic techniques of higher validity.

The value of a diagnostic technique is judged in terms of its **reliability** and **validity**. This can be exemplified using target shooting as an analogy (*Figure 9.6*). In target A, each shot is accurate (i.e., close to the bull's-eye, which represents the true value); therefore validity and repeatability are high. In target B, none of the shots is accurate, but the result is repeatable. In target D, none of the shots is accurate, and reliability is low because the shots are inconsistent with one another.

<sup>5</sup> Everitt (1995) gives a fuller definition of repeatability as 'The closeness of results obtained in the same test material by the same observer or technician using the same equipment, apparatus and/or reagents over reasonably short intervals of time'; and reproducibility as 'The closeness of results obtained in the same test material under changes of reagents, conditions, technicians, apparatus, laboratories, and so on'. However, the terminology in this area is subject to variation in usage; Last (2001), for example, draws no distinction between repeatability and reproducibility.

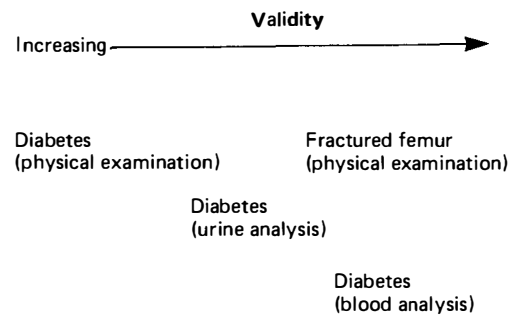

**Fig. 9.5** Validity of diagnostic techniques in relation to the disease being studied.

Target C illustrates that, **on average**, it is possible to obtain high validity when the accuracy of individual shots is low. Thus, high validity corresponds to shots, on average, hitting the bull's-eye, whereas high reliability corresponds to shots being tightly packed.

Although there has been ambiguity in the use of these five terms (Last, 2001), accuracy is best considered as the property of a single diagnosis (i.e., of one shot at the bull's-eye) whereas validity should be considered as a long-term characteristic of a diagnostic technique (i.e., the average result of several shots).

Sensitivity, specificity and reliability are discussed further in Chapter 17.

### Bias

The shots fired at target B in *Figure 9.6* are not accurate, but they are repeatable. Thus, the results are reliable, but of low validity. In this example, the results may have occurred because the sights on the gun were **biased** to the right of the centre of the target. A similar bias can occur in diagnostic tests and epidemiological studies. Bias is any systematic (as opposed to random) error in the design, conduct or analysis of a study that renders results invalid.

Several types of bias can be identified (Last, 2001). Major ones are:

- **bias due to confounding** (see Chapter 3);
- **interviewer bias**, where an interviewer's opinions may affect accurate reporting of data;
- **measurement bias**, involving inaccurate measurements or the misclassification of animals as diseased and non-diseased (e.g., when sensitivity and specificity are less than 100%);
- **selection bias**, where animals selected for study have systematically different characteristics from those that are not selected for study; for example, animals selected from an abattoir are unlikely to have clinical disease, whereas the general population will include some clinically diseased individuals.

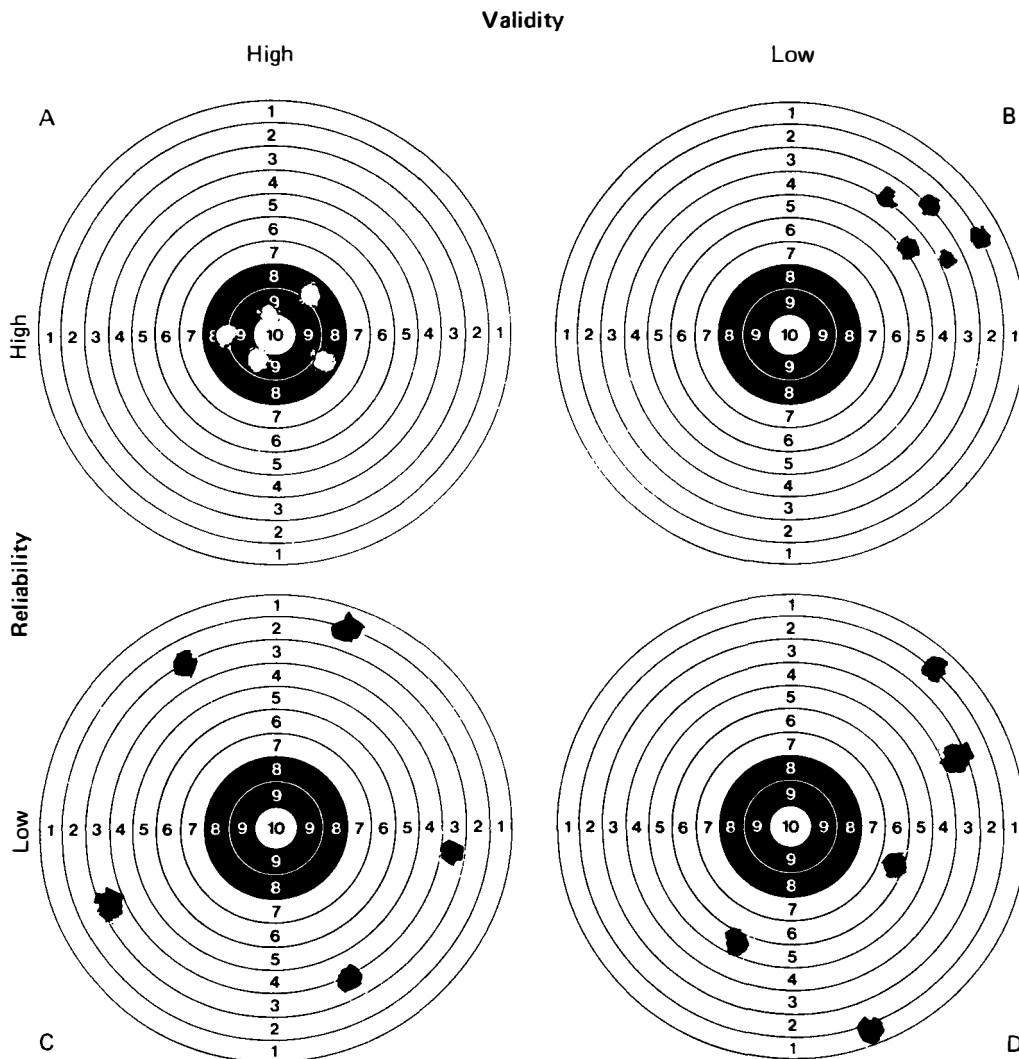

**Fig. 9.6** Reliability and validity of diagnostic tests presented as analogues of target shooting.

Bias is a **long-run** effect. Any individual shot in target B could have been one of those in targets C or D. Only when all of the shots have been fired can the bias be detected, because it requires demonstration of reliability. Thus, an individual observation from a population cannot be biased. Similarly, if many samples produce repeatable inaccurate results, then bias is present in the **population** from which the sample was drawn.

Bias can be corrected if its extent is known. Thus, the sights on the gun can be adjusted to compensate for the bias; shots will then be accurate. Similarly, biased estimates of prevalence, resulting from a test's specificity and sensitivity being less than 100%, can be corrected if the sensitivity and specificity are known (see Chapter 17).

## Representation of data: coding

Data are usually represented by both words and numbers. An alternative type of notation involves **coding**. This is a means of representing text and numerals in a standardized, usually abbreviated, form. The coding of medical information has spanned over two centuries, having its origins in the 18th century disease classification system of John Graunt (see Chapters 1 and 19), the *Nosologia Methodica* of Francois Bossier de Lacrois, and the *Synopsis Nosologiae Methodicae* of William Cullen (Gantner, 1977). Momentum increased in the 1960s and 1970s when computers became available. Codes are easier and more economic to handle by a computer than is plain text and so offer advantages to computerized recording systems (see Chapter 11).



Thus, it is easier and quicker to record the code number 274 than to write its possible textual equivalent, 'contagious bovine pleuropneumonia'. More recently, advances in software and computer storage capacity have made the efficiency of codes less critical than hitherto. However, coded data remain of value; for example, in statistical packages that require manipulation of numerically coded values.

### Code structure

Data about animals divide into two groups; any system of coding must cope with both groups. The first includes categories that relate to **permanent** data such as details of species, breed, date of birth and sex. These data have been termed 'tombstone data' because they remain unchanged during the whole of an animal's life. The second group comprises data relating to events that **vary** during life, such as date of occurrence, lesions, test results, signs and diagnoses. The various categories sometimes are called **descriptors** or **specifier types**. Other data can be derived from these categories; for example, the animal's age at the onset of disease.

### Components

The data that define disease can comprise a single component, called an **axis**; for example, 'bronchiolitis'. Alternatively, the definition can be broken down into constituent parts. In the case of a lesion, two convenient axes are the underlying pathological process and its site (topography). Using this **biaxial** system (two axes), bronchiolitis can be recorded as 'inflammation' and 'bronchiole'. Similarly, surgical procedures can be coded biaxially, in terms of procedure and site; for example, 'intramedullary pinning' and 'femur'. It is therefore possible to build up disease definitions from basic components in various axes.

### Numeric codes

Numeric codes represent text by numbers, for example: seborrhoea = 6327. Most of the early veterinary and medical coding systems were numeric. A veterinary system, developed in North America, is the *Standard Nomenclature of Veterinary Diseases and Operations* (SNVDO: Priester, 1964, 1971), which is based on the medical *Standard Nomenclature of Diseases and Operations* (SNDO: Thompson and Hayden, 1961). This codes diseases and operations (treatments) biaxially: diseases by topography and either aetiology or lesion, and operations by topography and procedure. Examples are:

**Table 9.5** An example of hierarchic numeric codes.

	Code	Meaning
Treatment	100	General medical therapy
	110	Antibiotic
	112	Oxytetracycline
	120	Parasiticide
	122	Thiabendazole
	Species and breed	100
110		Pony
111		Welsh mountain pony
120		Warm blooded
121		English thoroughbred
200		Dog
300		Cat
400		Cow
410		Friesian

diagnosis: 3530 3900.0 = bronchiolitis due to allergy,  
treatment: 723 52 = ureteric anastomosis.

In these examples, the diagnosis includes a topographical part (3530 = bronchiole) and an aetiological part (3900.0 = allergy). Similarly, treatment is defined in terms of topography (723) and procedure (52).

### Consecutive and hierarchic codes

A **consecutive** code is one in which consecutive numbers are drawn up to represent data, for example: 001 = distemper, 002 = infectious hepatitis, 003 = acute cystitis.

It is also possible to draw up a list of codes with a **hierarchic** structure; that is, with initial digits representing broad categories, and succeeding digits indicating more refined categories; the more digits used, the more refined the definition. An example is given in *Table 9.5*, and its hierarchic structure, resembling the roots of a tree, is illustrated in *Figure 9.7*. The use of initial digits alone produces 'coarse grain' definitions; use of additional succeeding digits produces 'fine grain' (i.e., more detailed) definitions.

There are three advantages to hierarchic codes. First, if accurate auxiliary diagnostic techniques are not available and therefore refined diagnoses are not definable, then a coarse grain code may be used without succumbing to the temptation of offering a more refined diagnosis than can be substantiated. Secondly, the individual interests of data collectors can be accommodated. For example, someone with a specialist interest in chemotherapy may be able to record the use of a particular antibiotic, whereas those who are content with recording just that an antibiotic has been used may record in the coarser grain. Thirdly, most computerized recording systems allow flexible querying at various levels of a hierarchy using a 'wild card'

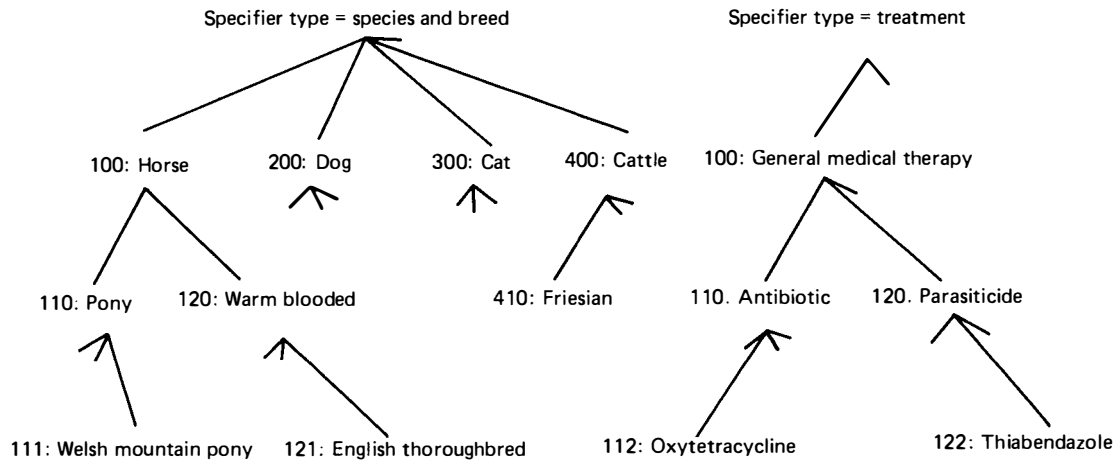

Fig. 9.7 Diagrammatic representation of a hierarchic code (code listed in Table 9.5).

facility. This uses a character which, when positioned on the right of specified codes, indicates that the codes specified on the left of it, and **all** codes on its right, are to be selected. For instance, if '%' is the wild card character, and a query is conducted on the treatment codes in Table 9.5, thus:

'select 1%'

then all records of medical therapy at all levels of the hierarchy would be selected (all antibiotics, all parasiticides, etc). In contrast, if '12%' were specified, only all parasiticides would be selected.

In addition to recording qualitative data, it is possible to use code to record quantitative data such as test results. There is some loss of refinement compared with the use of the results themselves because coding often involves the grouping of individual values into ranges of values (blocks). Table 9.6, for example, illustrates the numeric codes for ranges of numbers of helminth eggs isolated from faeces. Some test results are already blocked, although the blocking is often

**Table 9.6** An example of numeric coding of quantitative data: frequency codes for numbers of eggs per gram of faeces (epg) for use on a parasitology data report form. (From Slocombe, 1975.)

Code	epg	Code	epg
004	1–500	014	5001–5500
005	501–1000	015	5501–6000
006	1001–1500	016	6001–6500
007	1501–2000	017	6501–7000
008	2001–2500	018	7001–7500
009	2501–3000	019	7501–8000
010	3001–3500	020	8001–8500
011	3501–4000	021	8501–9000
012	4001–4500	022	9001–9500
013	4501–5000	023	9501–10 000

concealed by the mode of expression. Thus, a serological test quoted as positive at a dilution of 1:1024 implies that it was negative at 1:1025, whereas the next dilution tested that yielded a negative result was probably 1:2048. Blocking converts interval and ratio data to ordinal data, and this must be considered when selecting statistical methods for analysing the coded data (see Chapter 14).

## Alpha codes

Alpha codes represent plain text by alphabetical abbreviations or acronyms, for example: FN = Female neuter, M = Male.

Table 9.7 lists some components of a hierarchic alpha coding system for diagnoses. It has two axes: location and abnormality. Thus, displaced abomasum is coded DA PD, retained placenta is coded GL PR, and hepatitis is coded DH B.

**Table 9.7** An example of hierarchic alpha diagnostic codes (2 axes). (From Williams and Ward, 1989a.)

Axis 1 Location		Axis 2 Abnormality	
Code	Meaning	Code	Meaning
D	Digestive system	B	Inflammation
DA	Abomasum	E	Exudate
DE	Oesophagus	EBH	Haemorrhage
DH	Liver	P	Position
G	Reproductive system	PD	Displaced
GO	Ovary	PL	Dislocation
GU	Uterus	PR	Retention
GL	Placenta	PP	Prolapse
GS	Scrotum		

**Table 9.8** An example of alphanumeric diagnostic codes (three axes). (From Stephen, 1980.)

Code	Axis 1 Name of disease	Axis 2 Anatomical system involved	Axis 3 Aetiological agent or other indicated cause
ABO 10	Abomasitis, mycotic	UDIG (upper digestive)	MYCO (mycotic)
BRA 10	Brachygnathia	BOJOS (bones, joints, etc.)	CONGEN (congenital)
ENC 45	Encephalomyelitis, equine, Western	NERVO (nervous)	VIRO (virus)
EPI 10	Epidermitis, porcine, exudative	SKAP (skin and appendages)	BACTE (bacterial)
TOX 64	Seneciosis (including pyrrolizidine poisoning)	LIVBIP (liver and biliary)	TOXO (toxicosis)

## Alphanumeric codes

Alphanumeric codes have evolved more recently than numeric codes. An example is given in *Table 9.8*, where the disease is located in three axes: the disease's name, its topography and its aetiology. The first axis classifies the disease according to its name. In the first example in the table, the first (alpha) part of the first axis relates to the broad disease category (abomasitis) and the second (numeric) component produces a 'finer grain' description (mycotic abomasitis); this is therefore a simple hierarchy. The second axis classifies the disease according to the anatomical system that it affects (UDIG = upper digestive system). The third axis classifies the disease according to cause (MYCO = mycosis).

Signs may also be coded alphanumerically. *Table 9.9* illustrates a hierarchic alphanumeric code of signs.

## SNOMED

The most widely used multiaxial international coding system is *SNOMED* (*Systematized Nomenclature of Human and Veterinary Medicine* (SNOMED, 2004), which was introduced as an exclusively medical system, *SNOP* (*Systematized Nomenclature of Pathology*) in the mid 1960s in the US. An early version was modified for veterinary use (Cordes *et al.*, 1981), and the *Systematized Nomenclature of Veterinary Medicine* (SNOVET), which used six axes: topography, morphology, aetiology, function, disease and procedure (Pilchard, 1985), subsequently evolved. This was modified and combined with *SNOMED* (*Systematized Nomenclature of Medicine*) to form *SNOMED III: Côté et al.*, 1993), which, despite shortcomings, is considered a sound base for coding veterinary findings, phrases, terms and concepts (Case, 1994; Klimczak, 1994). Examples of *SNOMED III* codes, which hierarchically occupy nine axes (topography; morphology; function; living organisms; chemicals, drugs and biological products; physical agents, activities and forces; occupations; social context; and modifying linkages to modify contents of axes) are given in *Table 9.10*.

**Table 9.9** An example of hierarchic alphanumeric codes for signs. (From White and Vellake, 1980.)

Acoustic sense signs	
A00	Deafness
	A01 Complete deafness
	A02 Partial deafness
A10	Discharge from ear
	A11 Bloody discharge from ear
	A12 Purulent discharge from ear
A20	Excess wax/cerumen in ear
A30	Abnormal ear size
A40	Other signs referable to the ear
	A41 Mite infestation of ear, parasite, dirt
	A42 Odour bad ear
	A43 Cold ears
Digestive system signs	
D00	Abnormal appetite
	D01 Decreased appetite
	D02 Polyphagia—excessive appetite
	D03 Anorexia—loss of appetite
	D04 Pica—Depraved appetite
D10	Difficulty in prehension, cannot get food in mouth
D20	Chewing difficulty
D30	Signs of the jaw
	D31 Weakness of jaw
	D32 Inability to close jaw
	D33 Inability to open jaw
	D34 Malformation of jaw
D40	Odour from mouth
D50	Signs referable to the oral mucosa
	D51 Bleeding oral mucosa
	D52 Ecchymosis oral mucosa
	D53 Petechia oral mucosa
	D54 Dryness oral mucosa
	D55 Cold oral mucosa

**Table 9.10** Examples of SNOMED codes (topography, morphology and living organisms axes). (From Côté *et al.*, 1993.)

Axis	First-level code	Second-level code	Third-level code
Topography (T)	T01 Skin and appendages	T010–012 Skin appendages	T01100 Epidermis T01110 Stratum corneum T01120 Stratum lucidum
		T013 Skin appendages T017 Animal skin structures and appendages	T01705V Comb T01706V Dewlap
Morphology (M)		M017–018 Eruptions	M01720 Maculopapular M01780 Erythema M01790 Erythematous plaque
Living agents (L)	L 1–2 Bacteria and rickettsiae	L107 <i>Actinomyces</i>	L10801 <i>A. bovis</i> L10807 <i>A. suis</i>

Diseases are given specificity by capturing the organ, pathological change, causal agent and functional disturbance, thus:

Tuberculosis:

Lung: T 28000

Granuloma: M 44060

*Mycobacterium tuberculosis*: E 2001

Fever: F 03003

SNOMED has now become an international standard (Campbell *et al.*, 1997), and recent developments include SNOMED RT (SNOMED Reference Terminology), introduced in 2000 to provide an infrastructure for electronic health recording worldwide; and SNOMED CT (SNOMED Clinical Terms), which was introduced in 2002 after international collaboration (SNOMED, 2004).

## Symbols

Symbols can be used as codes. Thus, ↑ and ↓ are frequently used to represent elevated and lowered body temperature, respectively. Symbols may be combined with letters such as D+ and D– to indicate the presence and absence, respectively, of diarrhoea. Table 9.11 lists some examples of symbolic codes used in the international veterinary disease reporting system of the Office International des Epizooties (see Chapter 11). These may appear to represent very vague descriptions. However, they reflect the level of knowledge of

**Table 9.11** An example of symbolic codes. (From FAO-WHO-OIE, 1997.)

Code	Disease occurrence
–	Not reported
?	Suspected but not confirmed
(+)	Exceptional occurrence
+	Low sporadic occurrence
++	Endemic
+++	High occurrence
+?	Serological evidence and/or isolation of causative agent, no clinical disease
+..	Disease exists, distribution and co-occurrence unknown
()	Confined to certain regions
()	Ubiquitous
!	Recognized in country for the first time
<=	Only in imported animals (quarantine)
...	No information available

morbidity in many countries, where reliable, accurate, quantitative data are unavailable. The value of such general terms was noted in the 19th century by a notable medical epidemiologist William Farr: 'The refusal to recognize terms that express imperfect knowledge has an obvious tendency to encourage reckless conjecture'.

## Choosing a code

The choice of a code is partly subjective. Some people find numbers easier to handle; others are more content

with letters. There are, however, several definable advantages and disadvantages to numeric and alpha codes.

If acronyms or abbreviations are used (e.g., ABO for abomasum) they may be easier to relate to the plain text data and to remember than numeric codes (Williams and Ward, 1989a).

In some cases, alpha codes, in order to be acronymic, may require more characters than their numeric counterparts, even though 26 alternatives are available for each alpha character, and 36 for alphanumeric, compared with only 10 for numeric systems. This has been an important space consideration in computerized systems, which, in any case, can pack numeric data more tightly than either alpha or alphanumeric strings. The recent expansion in computer storage volume, however, has rendered this less critical than hitherto.

Numeric codes can be entered into computers more quickly than alpha codes. Most computer keyboards have a nine-digit numeric keypad which can be depressed more quickly than the alphabetic typewriter-style keyboard, especially if the user cannot type.

If a consecutive numeric code is used, care should be taken to ensure that it is long enough to accommodate all definitions of a specifier type. A four-digit code (e.g., 0000–9999), can accommodate 10 000 definitions (1000, if the last digit is a 'check digit' – see below), and then would be 'full'. If more than 10 000 definitions were required, a five-digit code would have to be used.

If there is a requirement for a variable 'grain' in the definition, then a hierarchic code is the most suitable. Alpha codes can be used, although numeric codes are more common. Numeric codes can have ten categories (0–9) at each level of the hierarchy. Alpha codes, based on the Roman alphabet, can have 26 categories (A–Z) at each level of the hierarchy.

Numeric codes are not subject to language differences. Alpha codes, however, if acronymic, may need to vary according to the language of the user.

When all of these merits are considered, subjective assessment is still a major factor. This is a reason for the considerable range of codes that are available and for the lack of a universally acceptable one.

## Error detection

Provision must be made for verifying data during the process of combining them with an existing collection of data. In general, as many checks as possible should be made on each datum, and the criteria used for checking should remain a permanent characteristic of the data that have satisfied the criteria. This is important when combining data from different sources and when combining data that have satisfied different, perhaps incompatible, sets of criteria.

## Consistency

Initially, checks should be made that the codes are recognizable, and then that they are internally consistent. Thus, it is illogical to record an elevated body temperature and a lowered body temperature at the same time. Placing the event in the context of what else is known about the animal's life history may reveal other inappropriate data. For instance, the recording of 'dystocia' becomes unacceptable when the animal's existing record shows it to be either male, or juvenile, or to have undergone an ovariohysterectomy some time ago. All of these inconsistencies would suggest that the animal may have been misidentified.

The initial check that the code is recognizable is simple if consecutive codes are employed: the check is that the code that is offered is neither less than the lowest nor greater than the highest code that is in use. Alphanumeric codes may need to be checked against a list held within the computer containing all permissible codes. Some codes (e.g., Table 9.8) use combinations of code elements taken from different lists; for example, representing organs, pathological processes and causes. Each element must be identified and checked against the appropriate list; further checks are required to ensure that any particular combination of organ, pathological process and cause is feasible and, for quantitative data, that extreme values are plausible.

## 'Finger trouble'

Data that are entered via keyboards (a common form of data entry in computerized systems – see Chapter 11) are subject to four types of error, collectively and colloquially termed 'finger trouble'. These errors are:

1. **insertion**, where extra characters are erroneously added;
2. **deletion**, where characters are omitted;
3. **substitution**, where the wrong character is typed;
4. **transposition**, where the correct characters are typed in the wrong order.

The danger is that the incorrect version may be an allowable code, which means something totally different from the intended code. If the codes have the same number of characters, then insertion and deletion are easily detected because the incorrectly entered code is the wrong length. The likelihood of entry of an incorrect code can be reduced by increasing the 'redundancy' of the code; that is, by adding more characters to the code. Unfortunately, highly redundant codes with many characters require many keystrokes which itself increases the chance of error. A balance must be found between these conflicting requirements.

Data that are transmitted electronically, for example from one computer to another via telephone links or computer networks (see Chapter 11), can be corrupted

during transit by the 'noise' of the transmission medium, although improved telecommunications (notably digital transmission) have reduced the frequency of such errors. There are several ways of protecting data from this degradation, including inclusion of a 'check digit' in numeric codes, which also increases redundancy.

### Check digits

These are mathematical functions of the preceding digits of the code. For example:

5029 = anaemia.

The first three digits (502) are a consecutively ordered code, which relates to anaemia, and the fourth digit (9) is a check digit, which is a function of the code numbers. The check digit, in this case, may have been generated using the formula:

$$(1\text{st digit} \times 2) + \text{second digit} - \frac{\text{third digit}}{2}$$

= check digit.

The computer will not accept 5028 or 5020 because it recognizes that the last digit is not the correct function of 502. Similarly it will not accept 5019 or 5039, which represent two totally different diagnoses. This is therefore a useful validation check against corruption to incorrect codes. (Of course, in this example, 4229 and 4109 would be consistent with the formula used to produce the check digit, but these are so unlike 5028

and 5020 that it is very improbable that they would be entered.)

### Further reading

- Abramson, J.H. and Abramson, Z.H. (1999) *Survey Methods in Community Medicine*, 5th edn. Churchill Livingstone, Edinburgh. (Includes concise guidelines on construction of measurement scales)
- Bowling, A. (1995) *Measuring Disease*. Open University Press, Buckingham. (A comprehensive review of measurement scales in human medicine, containing useful general principles)
- Cimino, J.J. (1995) Coding systems in health care. In: *Yearbook of Medical Informatics*, Eds van Bommel, J.H. and McCray, A.T., pp. 71–85. International Medical Informatics Association, Rotterdam
- Cimino, J.J. (1998) Desiderata for controlled medical vocabularies in the twenty-first century. *Methods of Information in Medicine*, **37**, 394–403. (A review of medical terminology, with particular reference to computerized data recording and retrieval)
- Hall, S.A. (1978) Farm animal disease data banks. *Advances in Veterinary Science and Comparative Medicine*, **22**, 265–286. (Includes a discussion of disease nomenclature)
- Leech, F.B. (1980) Relations between objectives and observations in epidemiological studies. In: *Veterinary Epidemiology and Economics*. Proceedings of the Second International Symposium, Canberra, 7–11 May, 1979. Eds Geering, W.A., Roe, R.T. and Chapman, L.A., pp. 254–257. Australian Government Publishing Services, Canberra
- Streiner, D.L. and Norman, G.R. (2003) *Health Measurement Scales: a Practical Guide to Their Development and Use*, 3rd edn. Oxford University Press, Oxford. (Includes a discussion of the 'philosophy' of validity and reliability)

# 10

## Surveillance

An essential part of disease control is the ability to document the occurrence of disease with the goal of developing effective control and eradication strategies; this is **surveillance**<sup>1</sup>. This chapter outlines basic principles of surveillance, whereas some of its components, including data collection, the design of appropriate information systems, surveys, and the application of diagnostic tests are discussed in Chapters 11, 13 and 17. Outbreaks of major epidemic diseases (e.g., classical swine fever and foot-and-mouth disease) require rapid surveillance protocols, linked to prompt control procedures, to ensure that epidemics are brought under control quickly; this topic is addressed in Chapter 22 (under 'Outbreak investigation').

### Some basic definitions and principles

#### Definition of surveillance

Surveillance was originally applied to individuals; primarily to contacts of serious communicable diseases (e.g., pneumonic plague), who were closely watched for the development of the first signs of illness (Langmuir, 1971). Gradually, it was broadened to include diseases and related factors, such that there is

no standard definition<sup>2</sup> (Table 10.1). Some definitions describe it in terms of monitoring<sup>3</sup>. Some authorities have used 'monitoring' and 'surveillance' synonymously and interchangeably (Acheson *et al.*, 1976). However, there is a contemporary consensus that, although these two terms are closely interdependent (Weatherall and Haskey, 1976), they now have separate and distinct meanings.

**Monitoring** is the routine collection of information on disease, productivity and other characteristics possibly related to them in a population. For example, in the UK, isolation of *Mycoplasma* spp. from ruminant specimens submitted to regional veterinary diagnostic laboratories regularly documented *M. bovis* over the 10-year period, 1990–2000, and initially identified *M. canis* in 1995 (Ayling *et al.*, 2004). Thus, monitoring is firmly grounded in the recording of vital statistics initiated by William Farr (see Chapter 1 and Langmuir, 1976).

**Surveillance**, in contrast, is a more intensive form of data recording than monitoring, and has three distinct elements:

1. **gathering, recording and analysis** of data;
2. **dissemination** of information to interested parties, so that:
3. **action** can be taken to **control disease**.

It has therefore been likened to a nerve cell, with an afferent arm that receives data; a cell body that analyses

<sup>1</sup> The procedure is not new, having its origins in the reporting of disease outbreaks (see Chapter 1). The Committee of Inquiry following epidemics of rinderpest in the UK in the 18th century (Table 1.1) recommended compulsory notification of disease (Spinage, 2003), and in France in the 19th century the *Conseil de Salubrité* advised that the authorities were immediately notified of outbreaks of foot-and-mouth disease (Reynal, 1873). Surveillance of non-notifiable diseases in the UK was expanded in the early 20th century (MAFF, 1965), and international interest in surveillance increased with the establishment of the *Office International des Epizooties* in 1924 (see Chapter 11).

<sup>2</sup> 'Surveillance' is derived from the French, *surveiller*, 'to watch or guard a person' (*Oxford English Dictionary*, 1971); it came into English use in this context at the beginning of the 19th century.

<sup>3</sup> 'To monitor' is 'to keep under observation, especially so as to regulate, record, or control' (Latin: *monere* = 'to warn, advise, admonish': *Oxford English Dictionary*, 1971). It was introduced in the field of regulated recorded sound early in the 20th century, and is now in general use to indicate regular measurements of any continuous process.

**Table 10.1** Some definitions of surveillance.

Definition	Source
Surveillance of <i>individuals</i> : close observation to detect early signs of infection without restricting [ <i>their</i> ] freedom of movement.	Langmuir (1963)
Surveillance of <i>disease</i> : the continued watchfulness over the distribution and trends of incidence through the systematic collection, consolidation and evaluation of morbidity and mortality reports and other relevant data.	Langmuir (1963)
... a more active system [ <i>than monitoring</i> ] and implies that some form of directed action will be taken if the data indicate a disease level above a certain threshold.	Martin <i>et al.</i> (1987)
Continuous analysis, interpretation, and feedback of systematically collected data, generally using methods distinguished by their practicality, uniformity, and rapidity rather than by accuracy or completeness.	Eylenbosch and Noah (1988)
The collection, collation, analysis and dissemination of data; a type of observational study that involves continuous monitoring of disease occurrence within a population.	Stedman (1989)
The maintenance of an ongoing watch over the status of a group or a community.	Abramson and Abramson (1999)
Ongoing systematic and continuous collection, analysis and interpretation of health data (often designed to detect the appearance of specific diseases), allowing epidemiologists to follow in time and space the health status and some risk factors associated with diseases for a given population, for use in the planning, implementation, and evaluation of disease control measures.	Toma <i>et al.</i> (1999)
The ongoing systematic collection, collation, analysis and interpretation of accurate information about a defined animal population with respect to disease and/or infection, closely integrated with timely dissemination of that information to those responsible for control and prevention measures.	Ministry of Agriculture, Fisheries and Food, UK: Meah and Lewis (2000)
Surveillance of <i>disease</i> : the continuing scrutiny of all aspects of occurrence and spread of disease that are pertinent to effective control.	Last (2001)
... refers to a specific extension of monitoring where obtained information is utilized and measures are taken if certain threshold values related to disease status have been passed. It therefore is part of disease control programmes.	Noordhuizen and Dufour (2001)
The ongoing systematic collection, analysis, and interpretation of outcome-specific data essential to the planning, implementation, and evaluation of public health practice, closely integrated with the timely dissemination of these data to those who need to know.	Centers for Disease Control and Prevention, US, quoted by Thacker and Birkhead (2002)
... the continuous investigation of a given population to detect the occurrence of disease for control purposes, which may involve testing of part of a population.	Office International des Epizooties: OIE (2002)

data; and an efferent arm that takes appropriate action (Thacker and Birkhead, 2002).

## Goals of surveillance

The broad aims of veterinary surveillance follow the goals of veterinary medicine in general: namely, maintenance of high standards of animal health and welfare, and the protection of public health (by the control of zoonoses and foodborne infections). Several specific objectives can be identified:

- rapid detection of disease outbreaks;
- early identification of disease problems (endemic and non-endemic);

- assessment of the health status of a defined population;
- definition of priorities for disease control and prevention;
- identification of new and emerging diseases;
- evaluation of disease control programmes;
- provision of information to plan and conduct research;
- confirmation of absence of a specific disease.

## Types of surveillance

There are several types of surveillance, defined by function and method.



## Disease surveillance

**Disease surveillance** addresses aspects of the occurrence and spread of disease that are pertinent to disease control. Thus, during outbreaks of foot-and-mouth disease, sources of infection must be traced, isolated and removed. Disease surveillance is therefore more focussed than surveillance in general, which, for instance, may include recording of the distribution of agents and vectors, and serological 'imprints' of past infection.

## Epidemiological surveillance

'Epidemiological surveillance' is a fuller description of surveillance, as generally and variously defined in *Table 10.1*. Some authors (e.g., Toma *et al.*, 1999) relate it closely to monitoring.

## Sentinel surveillance

Surveillance can include the entire national herd (e.g., testing for bovine tuberculosis). Alternatively, a few farms, abattoirs, veterinary practices or laboratories may be selected; these are then referred to as '**sentinel**' units, because they are designed to 'keep watch' on a disease<sup>4</sup>. Thus, sentinel equine premises can be used to investigate persistence of vesicular stomatitis virus, using previous history of the disease as the selection criterion (McCluskey *et al.*, 2002). The *National Arbovirus Monitoring Program* (NAMP, 2004) utilizes sentinel cattle herds to plot the distribution of insect-borne viruses in Australia.

Alternatively, attention may be focussed on a species in general. Horses can be used as sentinels for Venezuelan equine encephalitis virus infection (Dickerman and Scherer, 1983) and stray dogs as sentinels for canine parvovirus infection (Gordon and Angrick, 1985), the infections being identified serologically. Other species of animal that also are susceptible to an infectious agent can be used as sentinels for the infection in the main population of concern. For example, wild birds can be used to monitor the activity of St Louis encephalitis virus, providing early information on the activity of the virus at a time when avian infection rates are still too low to pose an immediate threat to man (Lord *et al.*, 1974). Eastern equine encephalitis (a mosquito-borne virus disease) infects horses and other vertebrates, including man, but has a reservoir in birds. Surveillance of this infection therefore includes regular serological testing of sentinel flocks of chickens or pheasants kept outdoors, in association with the results of virus culture on captured mosquitoes, and

veterinary surveillance of eastern equine encephalitis-like illness in horses (Thacker and Birkhead, 2002). Similarly, in the US, an integrated approach to surveillance of West Nile virus, which emerged in the Western Hemisphere in 1999 (Nash *et al.*, 2001), involves surveillance of humans, horses, dogs, cats, wild birds (particularly dead crows), the vector mosquitoes, and sentinel chicken units (USGS, 2004). Domestic animals also can be used as sentinels of human environmental health hazards such as carcinogens and insecticides; this topic is discussed in detail in Chapter 18.

Thus, 'sentinel' can refer to either a specific unit of observation or a species of animal.

## Serological surveillance

**Serological surveillance (serosurveillance)** is the identification of patterns of current and past infection using serological tests (see Chapter 17). For instance, following epidemics of foot-and-mouth disease in the European Union, all small-ruminant holdings within a 3-km radius of infected premises must be serologically sampled according to a precise statistical sampling protocol (see Chapter 13) before the area can be declared free from infection, and movement restrictions lifted. Sometimes more extensive sampling may be undertaken; this occurred in the UK following the 2001 epidemic, when serological surveillance extended to a 10-km radius (*Figure 4.14*).

## Passive and active surveillance

**Passive and active surveillance** each have been given different meanings. First, passive surveillance has been defined as the examination of only clinically affected cases of specified diseases; this contrasts with active surveillance, which involves the sampling (including post-mortem examination) of clinically normal animals in the population, therefore being important in the surveillance of diseases in which subclinical cases and carriers predominate (Blood and Studdert, 2002).

Secondly – and most commonly in veterinary medicine – passive surveillance has been described as the continuous monitoring of the existing disease status of the populations that are surveyed, using routinely collected data to produce outputs that can feed into policy decisions (Scudamore, 2000). Examples include reports of laboratory diagnoses, routine meat inspection findings and statutory notification of disease. Passive surveillance is therefore essentially monitoring with the intention of acting on its findings. Active surveillance, in contrast, involves the committed effort of veterinary authorities to collect information, commonly by undertaking surveys of specific diseases.

<sup>4</sup> The origin is Italian: '*sentinella*' 'sentry; guard'.

Passive and active surveillance each have strengths and weaknesses (Meah and Lewis, 2000; Scudamore, 2000). Passive surveillance uses data that may be biased (e.g., voluntary submissions to diagnostic laboratories), frequently lacking denominator values (see Chapter 4), and so cannot give unbiased estimates of disease frequency. In contrast, active surveillance, based on well-designed surveys, can produce such estimates. Passive surveillance may also underestimate the frequency of disease; for example, in Kenya, only 12 rabid dogs per 100 000 dogs were identified by passive surveillance, in contrast to 860 per 100 000 by active surveillance (Kitala *et al.*, 2000). However, passive surveillance is the first stage in identifying new and emerging diseases, which active surveillance cannot target (because the target is not yet identified); examples have included the initial identification of bovine spongiform encephalopathy and porcine reproductive and respiratory syndrome (Tables 1.6 and 1.7). Moreover, in passive surveillance, submission of samples to laboratories, with feedback of results to farmers and veterinarians, establishes good relationships, facilitating 'informal' intelligence on animal health. Passive surveillance also usually involves a lesser cost than active surveillance. Therefore, both passive and active surveillance programmes are necessary components of national surveillance systems: the US's *National Animal Health Monitoring System* is a good example (see Chapter 11).

### Targeted and scanning surveillance

The term 'passive' has the further disadvantage of failing to describe adequately the functions of surveillance, outlined above. Moreover, the term can give the impression of being 'unscientific', is sometimes dependent on chance, and might imply that action is not taken (i.e., it may be categorized as monitoring *per se*). Additionally, active surveillance now includes activities in addition to surveys (e.g., outbreak investigations). Therefore, a new vocabulary is evolving to replace 'active' and 'passive'.

**Targeted surveillance** collects specific information about a defined disease so that its level in a defined population can be measured and its absence monitored. It is often planned using appropriate statistical sampling theory, and commonly focuses on populations that are at increased risk of being affected, thereby increasing the efficiency of detection. Examples are the targeting of fallen stock for surveillance of bovine spongiform encephalopathy (Doherr *et al.*, 2000) and equine colic cases for nosocomial *Salmonella* spp. infection (Kim *et al.*, 2001).

**Scanning (global) surveillance** maintains a continuous watch over endemic disease. Thus, questionnaires distributed to veterinarians in Scotland provided a regional picture of calf pneumonia and enteritis (Gunn and Stott, 1996). Therefore, unexpected changes can be

recognized. If scanning surveillance identifies an unusually high frequency of similar, undiagnosed cases (e.g., of respiratory disease), it may trigger a more detailed investigation to explore the likelihood of a new disease occurring; this is **syndromic surveillance**<sup>5</sup>.

### Some general considerations

#### Nature of data

Data from some sources may be unsuitable because they are **inaccurate**. Moreover, accuracy may vary over time (e.g., as a result of the changing ability to diagnose disease), producing spurious changes in disease trends (see Chapter 8).

Data also may be of the **wrong type**. For example, a record that just notes 'lameness' would be useful in a general estimation of the prevalence of bovine foot problems, but would be of little value to a detailed study of the various lesions and their causes that produce lameness. Hierarchical coding systems allow data of varying degrees of refinement ('granularity') to be recorded (see Chapter 9) and therefore may assist in the recording of disease profiles according to the available diagnostic detail (e.g., Stärk *et al.*, 1996).

Additionally, sources of veterinary data may be **biased** (see Chapter 9); a common type being selection bias. The bias in the sources of data listed below is indicated when they are described.

#### Co-operation

The lack of co-operation can pose a problem to surveillance and other epidemiological investigations. There are several reasons why people may not be willing to supply data.

The **reasons** for collecting information may not be clear to potential suppliers of data, and so they may be discouraged. This emphasizes that the **objectives** of data gathering should be explained to all who are involved in it. Co-operation is more likely if data collection is part of a planned disease control programme than if it is undertaken in isolation. For example, Sudanese farmers co-operated in a survey of mortality due to schistosomiasis because this survey was part of an investigation of the financial viability of a new vaccine against *Schistosoma bovis* (McCauley *et al.*, 1983a,b). However, surveys in Haiti, conducted without a concomitant animal health programme, eventually met with resistance from local animal owners (Perry and McCauley, 1984).

**Motivation** may be difficult to maintain in long-term data collection. This is of relevance not only to

<sup>5</sup> The term derives from 'syndrome': the aggregate of signs associated with a disease that provides a description of it (Greek: *syn* = 'together'; *dromos* = 'running').

surveillance but also to prospective epidemiological studies (e.g., cohort studies: see Chapter 15). For example, during a 5-year study of urinary incontinence in bitches, only 7% of veterinary practitioners returned completed questionnaires, despite initial enthusiasm, agreement to participate and regular contact by the investigators (Thrusfield *et al.*, 1998).

The collection of information may risk a breach of **confidentiality**; for example, if practitioners' records that contain details of financial transactions of practices are examined. This, too, may prevent co-operation.

Co-operation is unlikely if data collection is **laborious** or **time-consuming**, for instance completing a complex or cumbersome questionnaire (see Chapter 11). The method of data collection therefore should be as simple as possible, within the constraints of the requirements of the data collection programme.

### The cost of data collection

The collection of data always incurs a cost, and this is particularly relevant to active surveillance. Costs include laboratory examination charges and postal charges when the data are collected by postal questionnaire (see Chapter 11). The value of data therefore has to be judged in the context of the cost of collecting them. In most countries the collection of information on diseases of national importance is supported by government funds. Similarly, in many countries funds are available for research on diseases of economically important livestock. However, investigation of companion animals' diseases, especially if they are not demonstrably of public health significance, relies on the limited financial support available from welfare societies and charities. Lack of funds therefore can restrict companion animal data collection.

### Traceability

Traceability (Latin *tractus* = 'track', 'course') is a neologism referring to the ability to trace the history, application or location of an item by recorded identification (EPA, 1998). Increased attention has been paid to the traceability of animals and animal products over the past two decades, fostered, in Europe, by crises such as bovine spongiform encephalopathy, foot-and-mouth disease and dioxin contamination of feed (Vallat, 2001)<sup>6</sup>, and tracing systems<sup>7</sup> have thus

become a priority for national and international veterinary services.

The starting point for a tracing system is animal identification (e.g., *Figure 10.1*), which has increased in sophistication with the development of electronic 'microchip' implants, both in livestock and companion animals (see Chapter 4), ruminal boluses, electronic ear tags (Fallon, 2001; Ribó *et al.*, 2001) and genetic markers (Cunningham and Meghen, 2001). Individual-animal documentation (e.g., animal 'passports': see Chapter 4), linked to details of diagnostic tests, movements and livestock holdings, then forms the basis of a system for documenting an animal's history and current location. For example, the control of chlamydiosis in Californian parakeets was facilitated by a state law requiring all parakeets to be banded with details of their year of birth and breeding establishment (Schachter *et al.*, 1978). In contrast, the UK's *Vetnet Tracing and Verification System* proved insufficient to trace efficiently all potentially infected sheep during the 2001 foot-and-mouth disease epidemic because they could only be traced in batches and, when broken up, consequently became progressively more difficult to track (Gibbens *et al.*, 2001b). Similarly, in Canada, lack of animal identification hampered final efforts to eradicate bovine tuberculosis and to trace sheep potentially infected with scrapie (Greenwood, 2004).

Examples of national tracing systems include a tracing system for cattle in Northern Ireland (Houston, 2001) and Canada (Stanford *et al.*, 2001).

Increased world trade also means that there is a requirement for minimum standards in animal health, including the need to track animals and their products between countries (Wilson and Beers, 2001). This is because one needs to know the origin of animals and the places in which they have stayed because, for trade, health status is linked to location (e.g., some types of farm in some countries are known to be disease-free and so animals on such farms need not be proved to be individually disease-free). Thus, in the European Union, *ANIMO* (*ANIMAL MOVEMENT*) is a computerized network linking veterinary authorities (EUROPA, 2004). It exchanges information about intra-Community trade, importation or transit in the Union of live animals, semen and embryos, as well as trade in mammalian animal waste, and importation of certain kinds of animal products. A development is the integration of *ANIMO* with *SHIFT* (a computerized

<sup>6</sup> The idea is not new: the marking of animals is documented in the *Code of Hammurabi*, sixth king of the Amorite Dynasty of Old Babylon (18th century BC), and written certification of the origin of animals was introduced by Friedrich William, King of Prussia, in 1716, as a component of the control of rinderpest (Tornor, 1927). A detailed history of the traceability of animals and their products is presented by Blancou (2001).

<sup>7</sup> Caporale *et al.* (2001) draw a nice distinction between tracing systems and traceability systems. The former are implemented specifically to assist in disease control (e.g., tracing the origin of tuberculosis reactors), whereas the latter aim to document the history of a product along the whole production chain ('from paddock to plate': see Chapter 1).

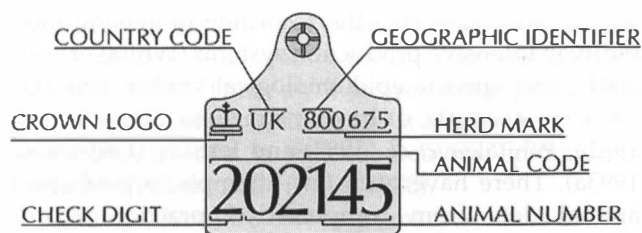

(a)



(b)

**Fig. 10.1** An example of animal identification: ear tagging of cattle in the UK: (a) ear-tag design (the geographical identifier is illustrative); (b) location of tagged animals according to the first two digits of a tag's geographical identifier.

network for veterinary import procedures) to produce *TRACES* (*TR*AdE Control and *EX*pert System), although weaknesses in cattle identification and registration still exist (Auditors, 2004).

## Sources of data

The organizations and groups described below represent a comprehensive list of possible sources for surveillance and other types of epidemiological investigation. The membership of the list will vary between countries. Some countries, particularly the developed ones, have veterinary infrastructures that facilitate potential or actual data collection from the majority of these sources. The developing countries may be able to utilize only a few of them. Some organizations record and store data routinely and therefore provide structured collections of data (databases) and information systems to which reference can be made for surveillance activities and when mounting other epidemiological studies (see Chapter 11).

## Government veterinary organizations

Most countries have organized government veterinary services. These services investigate diseases of national importance, particularly those infectious ones for which legislation enforces reporting (the notifiable diseases). Many governments also operate diagnostic laboratories. Reports are sometimes prepared and published routinely; for example, records of diagnoses made at diagnostic laboratories in the United Kingdom (Hall *et al.*, 1980). Submissions to diagnostic laboratories from practitioners are often voluntary and may therefore reflect personal interest and motivation, causing selection bias. Reports of notifiable diseases, similarly, depend upon the conscientiousness of observers.

Publications that collate information from a variety of government sources, including field and laboratory investigations, are also available routinely. In some cases routine reports are prepared but are confidential and therefore not readily available. An international bulletin of animal diseases, covering most countries of the world, is published by the *Office International des Epizooties* (OIE; Blajan and Chillaud, 1991). The

bulletin provides a statement of disease prevalence, based on regular reports of member countries of *OIE* (see Chapter 11).

Sometimes surveys have been undertaken that use data collated from several sources. A good example is the survey of livestock diseases in Northern Ireland that was undertaken in 1954 and 1955 (Gracey, 1960). This included demographic and disease data relating to a wide range of infectious and non-infectious diseases in cattle, sheep and pigs. It included data collected from 70% of farms in the country by field officers, and abattoir data.

### Veterinary practices

In countries with private veterinary practices (notably the developed countries), practitioners have contact with farm and companion animals, although the extent of contact varies. Farm animal veterinarians have the greatest contact with dairy cattle, less contact with pigs and beef cattle, and the least with sheep. Problems in ruminants tend to be seasonal and related to parturition.

Owners of companion animals usually attend private clinics. Thus, the practitioner is a major potential source of small animal and equine data that relate to a reasonably representative cross-section of animals.

In companion-animal practices the cost of therapy may prevent animals being presented for treatment, and so diseases of animals owned by the poor may be under-represented, therefore inducing selection bias.

In large-animal practices mild diseases and hopeless cases are not usually brought to the practitioner's attention by the farmer and so may be under-represented.

Even when information is freely available, it usually exists as separate accumulations of records in the individual practices and therefore may be difficult to collect and collate. Questionnaires can be used (see Chapter 11), but are time consuming. A few continuous monitoring programmes have been instigated using veterinary practice data, for example, those that collect data from several veterinary practices in Minnesota in the United States (Diesch, 1979); (see also *Table 11.2*). However, use of veterinary practice data in surveillance has tended to be limited.

#### *Computerized practice records*

Modern developments in computer technology, however, are increasing the accessibility of data (see Chapter 11), and now present the possibility of using routinely collected veterinary practice data for surveillance and epidemiological research. There are several computerized livestock health and productivity recording schemes operated by veterinary practices, bureaux and universities (see *Table 11.2* and Chapter 21),

which have facilitated the recording of general morbidity in intensive production systems (Whitaker *et al.*, 2004), and specific epidemiological studies and surveys; for example, of bovine lameness (Russell *et al.*, 1982a; Whitaker *et al.*, 1983) and fertility (Esslemont, 1993a). There have been few attempts to pool small animal data from computerized practice records (Thrusfield, 1991). However, the Internet (see Chapter 11) is an expanding resource, and already has been used to collect small-animal surveillance data (Gobar *et al.*, 1998).

The use of pre-existing data is attractive because these data can be extensive, covering a representative cross-section of the population, and are less expensive than data that are collected for a particular purpose (*ad hoc*). However, there are problems associated with routinely collected computerized data. First, some of the data may be of insufficient refinement for a proposed study. Secondly, data from various recording systems may be difficult to unify and compare because the systems contain varying categories of data of varying degree of refinement. For example, one computerized system may record lesions of the bovine foot in considerable detail (e.g., Russell *et al.*, 1982), whereas another simply may record that lameness is present (Smith *et al.*, 1983). Thirdly, the researcher has little control of the collection, and therefore the quality, of the data (Willeberg, 1986); this may result in inaccurate records (e.g., caused by 'finger trouble': see Chapter 9), incomplete data, selection bias, misclassification and confounding<sup>8</sup>. Fourthly, conversion of the records into a form that is suitable for analysis can be complex (Mulder *et al.*, 1994).

### Abattoirs

Red meat abattoirs process large numbers of animals for human consumption and identify some diseases during meat inspection. Only clinically healthy animals usually are presented for slaughter, therefore the majority of diseases that are diagnosed at meat inspection are subclinical. Most reports relate to helminth diseases and internal lesions such as hepatic abscesses.

The objective of meat inspection is to safeguard the health of the human population. Traditionally this is practised by preventing the sale of meat and offal that are **obviously** unfit for human consumption. Therefore, most conditions are diagnosed only by macroscopic post-mortem examination; experience has shown that this approach is adequate.

A secondary objective is to record details of abnormalities that are found, because these findings may be of

<sup>8</sup> For accounts of assessment of the quality of data, see also Canner *et al.* (1983), Neaton *et al.* (1990), Roos *et al.* (1989) and Willeberg (1986).

epidemiological value, for example in associating outbreaks of disease in man with infections in animals (Watson, 1982). Thus, an increase in the prevalence of tuberculosis lesions in cattle at slaughter was the first indication of a human tuberculosis epidemic in Barbados (Wilson and Howes, 1980).

Abattoirs therefore can be primary sources of data for disease surveillance for conditions for which other diagnostic methods are not appropriate. In Europe, for example, clinical signs are not reliable indicators of contagious bovine pleuropneumonia, and the probably low prevalence of antibodies makes serological screening inefficient. Thus, in Switzerland, examination of lungs at slaughter was proposed as the basis of a surveillance system for this disease (Stärk *et al.*, 1994). Additionally, abattoirs may be targeted for specific surveys (e.g., of *Escherichia coli* O157: Chapman, 2000).

Epidemiological investigations are essentially a subordinate goal of meat inspection at abattoirs, although it is possible to conduct auxiliary investigations of blood, sputum, lymph nodes and other tissues for specific surveys and studies. Thus, in Ireland, bovine kidneys condemned at meat inspection by the usual macroscopic techniques have been subjected to electron-microscopic examination to determine the nature of the lesions (Monaghan and Hannan, 1983). This is an example of using auxiliary aids to increase refinement of a diagnosis. Similarly, a survey of *Cysticercus tenuicollis* infection of sheep in Britain has been undertaken (Stallbaumer, 1983). This was necessary because the condition was not routinely recorded separately but was included in the 'coarse grained' category: 'other conditions'.

Animals examined at meat inspection do not originate from the abattoir; they have travelled there. Trace-back is therefore desirable if the diseases that are identified are to be associated with their farm or area of origin. This is relatively easy in countries that have a simple marketing system. In Denmark, for example, pigs are shipped directly from producers to cooperative slaughterhouses from which data are collectively pooled, thereby allowing rapid trace-back and surveillance of disease (Willeberg, 1980a; Willeberg *et al.*, 1984).

Even when trace-back from the abattoir is possible, improper identification of viscera can be a further problem in some countries. Carcasses may be identified by ear tag or tattoo, but viscera containing lesions may not be labelled adequately and it may therefore be impossible to associate them with the carcasses from which they were removed.

Some countries publish routine meat inspection findings. These include Australia, Cyprus, Denmark, India, Luxembourg, New Zealand, Nigeria, Norway, the UK and the US. The published data may originate from the majority of abattoirs (e.g., in Denmark);

from a sample (e.g., in Britain: Blamire *et al.*, 1970, 1980); or from only a single abattoir (e.g., in India: Prabhakaran *et al.*, 1980). These sources have been used for epidemiological surveys; for instance, surveys of reasons for condemnation of sheep at Scottish abattoirs (Cuthbertson, 1983) and of numerous diseases identified in animals in English abattoirs (Blamire *et al.*, 1970, 1980).

Abattoir investigations can also be used to indicate faults in husbandry. A survey of hoof and pedal horn lesions in sows at a Budapest abattoir has assisted in the identification of defects in floor construction in pig houses (Kovacs and Beer, 1979).

### Poultry slaughterhouses

In several countries, poultry are slaughtered separately from the larger food animals in poultry slaughterhouses. Post-mortem examination results from these premises constitute another source of information. Most clinically diseased and dead birds are excluded before slaughter.

### Knacker yards

In some countries, animals that are ill or have died, and are therefore unfit for human consumption, are sent for slaughter to premises other than abattoirs. These premises are called 'knacker yards'. The carcasses may be fed to animals. In Europe, dogs kennelled for hunting are often supplied with flesh from these sources. Knacker yards also handle horses in countries in which horse flesh is not routinely eaten by man.

Data from knacker yards are biased, but in quite a different way from those obtained from abattoirs: animals sent to knacker yards usually are either dead or ill – not alive and healthy. Data from this source are difficult and costly to acquire; they are distributed over many premises and would require professional veterinary inspection of lesions to ensure accuracy.

### Registries

A registry is a reference list (more commonly, the word describes the building in which the list is kept). In human medicine, registries of diseases (notably of tumours) are maintained using hospital and death certificate data as numerators and census data as denominators in morbidity and mortality rates. There are some veterinary tumour registries but these usually lack census data and so the denominators tend to be biased by non-response. For instance, when using estimates of population size based on the enumeration of licensed or vaccinated dogs (e.g., Cohen *et al.*, 1959), the denominator will tend to be underestimated because of a low public response to licensing and

vaccination. In the UK, mandatory reporting of all tumours in cattle (except haemangiomata and papillomata) at abattoirs, linked to records of abattoir throughput, provides both numerators and denominators for tumour morbidity values.

Some registries reduce the non-response bias by utilizing demographic surveys in specified areas. A Californian tumour registry (Dorn, 1966) defined a 'veterinarian using' reference population, counted by household survey, as the denominator. The Tulsa (US) *Registry of Canine and Feline Neoplasms* (MacVean *et al.*, 1978) defined a 'veterinarian using' reference population, enumerated by a census of all veterinary practices in the Tulsa area, which included not only sick animals but also healthy animals presented for routine examination, vaccination and elective surgery; the numerator comprised diagnoses made by registry pathologists from specimens submitted by practitioners. Although these registries reduce the selection bias inherent in specialized populations (e.g., of clinical cases), the true population at risk may not be estimated. In the previous example, animals may not attend veterinary practices and therefore would be undetected, and some animals may attend more than one practice, one animal therefore counting twice in the denominator. The extent of these inaccuracies is difficult to assess, but is probably small.

### Pharmaceutical and agricultural sales

The sales records of pharmaceutical companies provide an indirect means of assessing the amount of disease, as well as monitoring drug use. The sale of antibiotics, for example, is a rough guide to the prevalence of bacterial diseases, although estimates made from this information may be inaccurate. Antibiotics may be used without isolating specific bacteria – indeed, without even positively incriminating a bacterium – and so may be used when a bacterial infection is not present. They may also be used prophylactically; for example, following routine surgery. Similarly, they may be used for a purpose other than that for which they were intended: some small animal practitioners, for instance, sometimes use bovine intramammary antibiotics to treat otitis externa. The extent of unjustifiable and unusual use of some drugs is difficult to estimate.

Pharmaceutical sales can be linked with other sources of data. In Denmark, for example, where pharmacies supply 95% of the weight of antimicrobial compounds, the VETSTAT surveillance system integrates data from pharmacies, veterinarians and feed mills to provide a picture of the use of drugs at farm level, to promote prudent use of drugs in the context of resistance to antimicrobial compounds (Stege *et al.*, 2003).

### Zoological gardens

Most zoos maintain detailed records of animals and their diseases (e.g., Griner, 1980; Pugsley, 1981). Several zoos send their data to a central registry in Geneva as part of an international database: the *International Veterinary Record of Zoo Animals* (Roth *et al.*, 1973). Some computerized recording systems focus on particular species (e.g., Bailey *et al.*, 2003), and there is a general awareness of the need for recording systems in the surveillance of diseases in captive species (Cook *et al.*, 1993b; Munson and Cook, 1993).

### Agricultural organizations

There are many agricultural bodies associated with the livestock industry that record information on animal production, such as liveweight gain, food conversion and milk yield. Although these data are not related directly to disease, they can provide information on the composition and distribution of populations that can be of value in defining populations that can be studied. For example, the British National Milk Records File was used to locate Friesian herds for a survey of reasons for culling and wastage in dairy cows (Young *et al.*, 1983).

### Commercial livestock enterprises

The intensification of animal industries mentioned in Chapter 1 has resulted in the establishment of commercial enterprises, particularly in the pig and poultry sector, where large units are common (see *Table 1.11*). Many of these enterprises have their own recording systems, although again some data may be confidential. These sources have been utilized in some surveys; for example, mortality in broiler chickens in Australia (Reece and Beddome, 1983), losses in commercially reared rabbits (Hugh-Jones *et al.*, 1975), unthriftiness in weaned pigs (Jackson and Baker, 1981) and lesions associated with the movement of weaners (Walters, 1978).

### Non-veterinary government departments

There are non-veterinary government departments that collect data relating to animals. These include economic and statistical units. The latter record the numbers and distribution of animals in Britain, enabling the drawing of choroplethic density maps of cattle, sheep and pigs in England and Wales (MAFF/ADAS, 1976a,b,c).

### Farm records

Many farmers, particularly those keeping dairy cattle

and pigs, routinely record production data. Some record information on disease. The recorded data may be computerized, and computerized schemes operated by bureaux, universities and veterinary practices have already been discussed above (see 'Veterinary Practices').

### Veterinary schools

Veterinary schools have clinics that record the results of consultations. Many have established databases, often using computerized techniques that allow rapid access to records, for instance the Florida (Burrige and McCarthy, 1979), Edinburgh (Stone and Thrusfield, 1989), Liverpool (Williams and Ward, 1989b) and Glasgow (Knox *et al.*, 1996) schools. Some veterinary schools also pool records to form composite databases (e.g., the *Veterinary Medical Database* in the US: see Chapter 11). The study population is frequently biased, especially when clinicians have specialist interests resulting in a high proportion of referred cases.

### Feral animal organizations

Wildlife and animal conservation organizations and pest control centres record data on feral animals, particularly relating to the size of populations. Wildlife can be important sources of infection to domestic animals and man, for example, of rabies (in skunks in the US and foxes in Europe) and may be potential sources of infection (e.g., if hares were infected with *Brucella suis* in the UK). Routine monitoring of disease in these animals would be expensive, although they are increasingly the focus of sentinel surveillance (see above). However, *ad hoc* surveys can be undertaken. Demographic data also are valuable when investigating the actual and potential spread of infection (see, for example, the discussion of potential fox rabies in Britain in Chapter 19).

### Research laboratories

Research laboratories record data on primates, lagomorphs, rodents and caviae that are used in experiments. These sources are very specialized, closed communities, and therefore are obviously biased.

### Pet-food manufacturers

Manufacturers of pet food sometimes collect animal demographic data as part of their market research (e.g., Anderson, 1983), although commercial interests may prevent release of all of these data.

### Certification schemes

Schemes certifying freedom from disease involve compulsory and often regular examination of animals belonging to participating owners, and can therefore provide morbidity figures for a range of diseases. For example, under the *British Veterinary Association/Kennel Club* eye examination scheme, certificates attesting to freedom from canine hereditary eye disease are issued for one year and are subject to renewal throughout a dog's life. This scheme therefore guarantees routine examination of dogs, and has facilitated estimation of the incidence of cataracts (Curtis and Barnett, 1989).

### Pet shops

Pet shops are potential sources of information on conditions of young animals, such as congenital lesions (Ruble and Hird, 1993), but trace-back (e.g., for genetic studies) is difficult or impossible.

### Breed societies

Companion-animal and pedigree livestock breed societies have information on breed numbers and distribution. The extent of co-operation can vary. If a survey could highlight a certain problem in a particular breed, then that breed's society may be unwilling to help. This fear is real, although it is based on the false notion that epidemiological investigations just produce incriminating morbidity figures. The main goal of these investigations, however, is to detect causes, with a view to developing beneficial preventive strategies.

### Serum banks

A serum bank is 'a planned catalogued collection of serum forming a random sample that is as representative as possible of a population and that is stored to preserve its immunological and biochemical characteristics' (Moorhouse and Hugh-Jones, 1981, after Timbs, 1980). Serum samples may be collected routinely during mandatory control and eradication campaigns in which serological tests are used to diagnose infection (e.g., brucellosis eradication where, in the UK, samples were also screened for warble fly and enzootic bovine leucosis). They may also be collected during specific surveys. For example, in a serological survey of warble fly infestation of cattle in England and Wales (Sinclair *et al.*, 1989), over 74 000 specimens, from over 3000 farms, were collected. Much of the serum is not used, particularly now that diagnostic techniques using very small volumes of serum are available, and so the unused serum is usually discarded.



**Table 10.2** Potential sources of samples for serum banks and some of their characteristics. (From Moorhouse and Hugh-Jones, 1981.)

Source	Potential no. of samples	Selection bias in study population	Cost to serum bank	Ease of collection	Standard of documentation
Ad hoc field visits	High	Low	High	Low	High
Other field visits	High	Low-high	Low	High	Moderate-high
Slaughter houses	High	High	Low	High	Low
Livestock marketing chain	High	High	Low-moderate	Moderate	Low
Veterinary diagnostic laboratories	Low	High	Low	High	Moderate-high
Private individuals	Low	High	Low	Moderate	Moderate-high
Existing collection	Low-high	Low-high	Low	High	Low-high

**Applications of serum banks** Serum samples can provide useful epidemiological information on infectious diseases, notably:

- identification of major health problems;
- establishment of vaccination priorities;
- demarcation of the distribution of diseases;
- investigation of newly discovered diseases;
- determination of epidemic periodicity;
- an increase in the knowledge of disease aetiology;
- evaluation of vaccination campaigns;
- assessment of economic losses due to disease.

**Sources of serum** Table 10.2 lists the potential sources of serum and some of their characteristics. This indicates that each source has its own advantages and disadvantages. The validity of results obtained from a serum bank depends on:

- the sensitivity and specificity (see Chapters 9 and 17) of the test performed on the serum;
- the quality of the survey design used in collecting the serum;
- the degree of degradation that has occurred in the serum during storage.

The first component is an inherent characteristic of the tests that are employed. The second factor hinges on appropriate sampling strategy (see Chapter 13). The third component is related directly to the means of storage.

**Collection and storage of serum** Samples should be taken aseptically. Blood should be allowed to clot for 1–2 hours at room temperature, stored horizontally overnight at 4°C, and then the serum should be separated by centrifugation at 2000–3000 rpm for 10–15 minutes. Blood can also be collected on filter paper discs; the serum can then be eluted later, although the amount of serum that is stored is small and may only allow semi-quantitative investigations.

Two storage techniques are available: **deep freezing** and **lyophilization (freeze-drying)**. Four options are available for the former:

1. liquid phase of liquid nitrogen: –196°C;
2. vapour phase of liquid nitrogen: –110°C;
3. ultra-deep freeze: –70°C to –90°C;
4. standard deep freeze: –20°C to –40°C.

Prolonged storage at –20°C may allow deterioration of antibodies. Refrigeration at 4°C is satisfactory for short-term storage. Lyophilization is a better technique than deep freezing, but is relatively expensive and technically complex. The following facts should be remembered in relation to freezing:

- the degree of deterioration at –20°C depends on the type and quantity of immunoglobulins; sera with high IgM levels may be expected to lose specific activity more rapidly than those with high IgG levels, due to fragmentation (Moorhouse and Hugh-Jones, 1983); this is particularly salient to chronic infections in which levels of IgM decline relative to IgG levels (Tizard, 2000);
- repeated thawing and refreezing can be deleterious; this is apparently not due to the thawing/freezing process *per se* (Cecchini *et al.*, 1992), but may result from the bacterial and enzymatic contents of non-sterile samples (see below); samples should therefore be refrozen as soon as possible;
- the use of cryoprotectants and/or enzyme inhibitors will reduce or eliminate deterioration;
- uninterrupted storage at –20°C appears to be a satisfactory procedure with very little loss of specific activity for at least 2 years; however, precise indications of the longevity of whole serum stored under serum bank conditions are not available;
- rapid freezing of samples is required;
- sterility is important;
- samples should be tested immediately after being thawed;
- delays will lead to increased rates of proteolysis.

Despite a recommendation, over 45 years ago, for the establishment of veterinary and medical serum banks (WHO, 1959) this recommendation has not been heeded widely, particularly in veterinary medicine. Established veterinary banks include one in Canada,

using serum collected during the bovine brucellosis eradication campaign (Kellar, 1983) and others in New Zealand (Timbs, 1980) and in Louisiana, US (Moorhouse and Hugh-Jones, 1981; Hugh-Jones, 1986). The latter includes serum samples salvaged from previous studies, which have provided information on diseases in domesticated and wild animals (leptospirosis in horses and leprosy in armadillos).

Several countries maintain national medical serum banks; for example, for influenza surveillance in the UK (Zambon and Joseph, 2001) and, in Scandinavia, for recording nutritional, biochemical, immunological or other changes that might be indicative of cancer development at early stages (Jellum *et al.*, 1995; Tuohimaa *et al.*, 2004). However, World Health Organization funding for some international medical serum banks was withdrawn in the late 1980s (Lederberg *et al.*, 1992).

The general principles of serum banks are discussed in two World Health Organization Technical Reports (WHO, 1959, 1970), and by Moorhouse and Hugh-Jones (1981). Additionally, the last two authors describe a computerized database for storing serum bank information.

## Mechanisms of surveillance

There are six main mechanisms of surveillance

1. voluntary notification;
2. mandatory notification;
3. outbreak investigation;
4. sentinel surveillance;
5. structured surveys;
6. censuses.

These and their characteristics, with examples from the UK, are presented in *Table 10.3*. One or more mechanisms may be used in a surveillance strategy. For example, surveillance of porcine brucellosis in the US involves mandatory reporting, active and passive routine surveillance, outbreak surveillance, and sentinel surveillance (NCAHP, 2004).

## Surveillance networks

The institutional infrastructure and personnel assembled to conduct surveillance of one or more diseases is termed a **surveillance network** (Dufour and Audigé, 1997)<sup>9</sup>. Such networks are usually centralized (i.e., data

are managed at a specific centre). The objectives, remit and mechanisms of surveillance that are applied permit a classification of surveillance networks (outlined by Dufour and Audigé, 1997) that assists understanding of the scope of contemporary veterinary surveillance:

- type of disease addressed (endemic vs exotic);
- numbers of diseases involved (scanning vs targeted surveillance);
- geographical scope of the network (e.g., regional or national);
- sampling strategy (censuses vs random sampling/voluntary submissions/sentinel surveillance);
- methods of data collection (passive vs active);
- management of the network (integrated: using data collected in the context of disease control or prevention; vs. autonomous: i.e., developed independently).

There is now a substantial number of surveillance networks and systems operating throughout the world, some of the latter as components of veterinary information systems (see Chapter 11). Examples of French surveillance networks are given in *Table 10.4*.

The national and international aspects of surveillance are reviewed by Blajan (1979), Davies (1980, 1993), Ellis (1980), Blajan and Welte (1988), Bernardo *et al.* (1994) and Dufour and Audigé (1997).

## Surveillance in developing countries: participatory epidemiology

A major constraint to veterinary surveillance and consequent disease control in developing countries has been the lack of information on disease morbidity. Data collection may be thwarted by poor laboratory diagnostic support, insufficient manpower, and difficult terrain (Broadbent, 1979). There also may be a general failure of conventional veterinary services (Swift *et al.*, 1990). This has given impetus to the elaboration of alternative methods of data collection as part of the wider goal of improving the delivery of veterinary services in the context of closer participation in disease control by rural communities<sup>10</sup>.

The need for methods of data collection and analysis that are powerful, quick, careful and cheap led to a

<sup>9</sup> A distinction is sometimes drawn between networks and systems (see Chapter 11) on the grounds that the latter have broader based objectives (e.g., servicing epidemiological studies, as well as surveillance), and may therefore comprise several networks.

<sup>10</sup> Appreciation of the need for community participation in the wider agricultural theatre originated in the US during the 1950s and 1960s, when Roosevelt's Country Life Commission encouraged self-reliance among deprived communities (Christenson and Robinson, 1980). This concept spread to developing countries after decolonization (Rifkin *et al.*, 1998). Hitherto, underdevelopment had been associated with a lack of technology, which could be remedied merely by passive adoption of Western technologies (Cohen and Uphof, 1980).

**Table 10.3** Mechanisms of surveillance. (Modified from DEFRA, 2002c.)

Mechanism	Description	Advantages	Disadvantages	Comment	Relative cost
Voluntary notification	Observation of event of interest (e.g., welfare infringement, unusual clinical syndrome) is reported to federal/state veterinary services either directly or through routinely reviewed publications or other sources	Provides a route for new syndromes to be identified Can be effective if the sources of data are motivated (e.g., university veterinary schools) Useful for recording unusual events of limited consequence (e.g., <i>Babesia canis</i> in dogs in the UK)	Will miss cases due to under-reporting Hard to define or measure the population at risk (i.e., the denominator in measures of morbidity) and so trends and changes cannot be measured	Reports are received when the observed event is recognized as being of interest and the observer is aware of the route by which a report can be made Can be improved by increasing awareness (e.g., by specific campaigns) and by offering financial incentives, but these will increase cost	Low
Mandatory notification	Legal obligation for observer to report events of interest (e.g., outbreaks of foot-and-mouth disease, salmonellosis in certain species) to defined government official or department	Good for syndromes with easily recognized clinical signs, particularly if awareness is raised (e.g., bovine spongiform encephalopathy) Requirement to notify is universal across the country Notification facilitates the swift implementation of investigation and control measures Clinical notification enables action to be taken in respect of diseases that are not rapidly or routinely confirmed in a laboratory Location data are supplied with notifications, which may enable population-based morbidity values to be calculated, and comparisons over time and geographical area to be made	Under-reporting is likely, unless training in awareness of clinical signs and route of reporting is maintained among the appropriate people The level of under-reporting of a particular disease is often biased; there are many reasons why a report may not be made, and these can be different for different areas or types of livestock owner Reduced sensitivity for syndromes with similar presentation to endemic syndromes (e.g., classical swine fever and post-weaning multisystemic wasting syndrome) Events with non-specific signs (e.g., Aujeszky's disease) may be missed Adverse consequences to the owner may act as disincentives and can increase under-reporting (e.g., a scrapie case on a holding in the previous 2 years prevents export) It may not be possible to estimate the size of the population to which the disease report relates, and so incidence or prevalence cannot be calculated	Reports are received when the observed event is recognized or suspected of being 'notifiable', and the observer is aware of route by which a report should be made Can be improved with incentives such as compensation	Low when prevalence is low
Outbreak investigation (see Chapter 22)	Veterinarians with appropriate expertise are recruited to investigate outbreaks of unusual disease syndromes; investigation of apparent association of human disease with exposures to animals	'Syndromic surveillance' provides a route for novel conditions to be identified	Depends on clear, agreed definition of an 'outbreak' (see Chapter 4) and agreed 'intervention levels' (e.g., bovine abortion rate >1% per year) Depends upon existing relationship between primary veterinarian and owner and therefore may omit farms that lack this relationship.	Variety of observation points may trigger investigations (e.g., mortality statistics from carcass disposal system; information from the public health authorities; lesions observed at meat inspection)	Can be high if intervention levels not appropriate

Sentinel surveillance (Primary and secondary data sources*)	Key observers are recruited to provide routine returns listing the type, number and other specified details of specified events if observed. Events of interest are defined and may differ in different time periods Sentinels can be either primary data sources (e.g., as farmers) or secondary sources (e.g., veterinary practitioners)	<p>Can be trained for the purpose</p> <p>Specialized and trained sentinels (e.g., veterinary practices) can provide estimates of level of defined events in the population surveyed</p> <p>Flexible: once the network is recruited and established, events surveyed and data collected can be varied in response to changing needs</p> <p>Can provide data on common conditions that are not notifiable, and for which laboratory diagnosis is not routine</p> <p>An estimate of the population size under surveillance may be available and so population-based morbidity values can be calculated</p> <p>If sentinel sites are representative, estimates can be generalized to a wider population</p> <p>Additional information that enables interpretation of trends can be collected</p> <p>Can monitor the reason for, and outcome of, particular laboratory tests or other health event, thus improving interpretation of other surveillance data</p>	<p>Such farms may be 'high risk' (i.e., more likely to have disease problems) because there is less veterinary involvement, and they are less likely to report or investigate problems</p> <p>Not useful for rare events because (due to cost) sentinels usually form a very small proportion of the population surveyed</p> <p>Can be hard to recruit sentinels that are representative of the population of interest, and so results may be biased</p>	<p>Observers are recruited appropriate to the event(s) to be detected and recorded</p> <p>Diagnostic specificity can be improved by linking with diagnostic laboratories</p> <p>To be effective, contact must be maintained and regular feedback provided, so as to retain the commitment of the data source</p>	Moderate or high
Sentinel surveillance (tertiary data sources)	Contributing data sources (e.g., diagnostic laboratories) report the number of diagnoses made of particular diseases, with a variable amount of supporting information (e.g., species affected, date of diagnosis, geographical location, specimen type). These are collated to give national statistics, which can indicate long-term trends and the effects of interventions	<p>Efficient surveillance method for indicators that cannot be confirmed by primary or secondary data sources (e.g., diseases with non-specific clinical signs)</p> <p>Can be universal, involving all sources, with a broad range of indicators reported, and so it is sensitive enough to detect rare but important changes at an early stage (e.g., emergence of new diseases)</p> <p>Can provide information on relative morbidity due to particular indicators (e.g., causes of abortion) and so guide the setting of priorities</p>	<p>Under-reporting is likely (because one is dependent on both primary and secondary data sources for material) and so it is impossible to calculate the total number of cases of disease</p> <p>May not be universal. Distribution of contributing laboratories may not be comprehensive, leading to geographical 'blind spots'</p> <p>Cases that are easily diagnosed at primary and secondary level will not contribute to the data set because there is no need to refer cases or diagnostic material</p>	Variable	

**Table 10.3** (cont'd)

<i>Mechanism</i>	<i>Description</i>	<i>Advantages</i>	<i>Disadvantages</i>	<i>Comment</i>	<i>Relative cost</i>
		<p>Highly specific if accredited data sources used, so links between cases reported from different areas can be recognized</p> <p>Provides a mechanism for identifying cases which can contribute to further study of priority diseases about which more information is required (e.g., first case-series study of bovine spongiform encephalopathy)</p> <p>Data on some indicators are not available routinely by any other means</p>	<p>The frequency of diagnosis is biased by the rate at which cases or specimens are referred; however, if the same factors affect all groups (e.g. economic hardship), relative morbidities will still be valid</p> <p>There is no tertiary diagnostic support (e.g., suitable laboratory test) for some diseases</p>		
Structured surveys (see Chapter 13)	A selected sample of the population of interest is surveyed for the presence of the indicator of interest	<p>The population of interest and the information needed can be defined</p> <p>Provided a sampling frame exists, the data can, and must, be collected from a representative sample of the population, ensuring unbiased estimates of morbidity</p> <p>The survey can be repeated over time</p> <p>A range of surveys can be carried out targeted at different populations to define the overall level and distribution of disease (e.g., fallen stock and casualty slaughter surveys for bovine spongiform encephalopathy are targeted at animals at particular risk with non-specific clinical signs) This contributes to defining the level of disease in that population, which may otherwise be missed</p> <p>Cost can be controlled by restricting the precision of the estimate</p>	<p>Targeted, and so can only measure that which is defined; cannot respond to new information or measure diseases that are new or unexpected</p> <p>Differences in diagnostic methods, or changes over time, can limit the comparability of surveys that set out to measure the same thing</p> <p>Can have problems of non-participation</p> <p>Denominator data sets may be incomplete or unavailable</p> <p>Very expensive if large sample sizes are prescribed</p>	<p>Surveys with small sample size can give useful results if the indicator is not very rare</p> <p>Surveys of animals at slaughter can measure the level of sub-clinical disease in animals of different ages</p> <p>Cost depends on disease characteristics and precision required</p>	Variable
Censuses	Measurement of an indicator in all members of a defined population (e.g., tuberculosis testing in all cattle of a defined age, or meat inspection of all animals slaughtered for human consumption)	All members of the defined population contribute information and so true prevalence or incidence values (rather than sample estimates) can be measured	<p>Requires a mechanism for identifying all members of the population to be counted</p> <p>Expensive</p>		High

\* The particular definition of primary, secondary and tertiary data sources in this table refers to the 'closeness' of relationship between the affected animals and the source of data relating to them. For example, farmers have regular and direct contact with livestock and so are primary sources; veterinarians may only have contact with selected clinical cases and so are secondary sources; and diagnostic laboratories have only indirect contact with animals through laboratory submissions. It is therefore sub-dividing primary data, as generally defined (see Chapter 11).

**Table 10.4** Animal epidemiological surveillance networks operating in France in 1997. (Modified and reduced from Dufour and La Vieille, 2000.)

<i>Name of network</i>	<i>Aims</i>	<i>Type of surveillance</i>	<i>Scope of surveillance</i>	<i>Sample or all animals</i>	<i>Data collection</i>	<i>Operation</i>
Rabies	To detect cases	Targeted	National	All	Passive	Integrated
Tuberculosis	To monitor disease control	Targeted	National	All	Active	Integrated
Brucellosis	To monitor disease control	Targeted	National	All	Active	Integrated
Bovine leukosis	To monitor disease control	Targeted	National	All	Active	Integrated
BSE (bovine spongiform encephalopathy)	To detect cases	Targeted	National	All	Passive	Integrated
Scrapie	To evaluate prevalence	Targeted	National	All	Passive	Integrated
SAGIR (wildlife surveillance network)	To estimate causes of death in game	Scanning	National	Sample (by hunters, on a voluntary basis)	Passive	Autonomous
RENESA (national poultry epidemiological surveillance network)	To monitor contamination of poultry flocks with <i>Salmonella</i> spp.	Targeted ( <i>Salmonella</i> spp. and mycoplasma)	National	Sample (by voluntary farmers, on a voluntary basis)	Active	Integrated
RNOEA (national network for monitoring poultry production)	To monitor diseases in poultry flocks	Scanning	National	Sample (by veterinarians, on a voluntary basis)	Active	Integrated
RESAN (beekeeping epidemiological surveillance network)	To monitor bee diseases in apiaries	Targeted (five diseases)	National	Representative sample	Passive	Autonomous
REPHI (phytosanitary surveillance network for shellfish)	To monitor toxicology contamination in shellfish	Targeted	National	Representative sample	Active	Autonomous
REMI (microbiological surveillance network for shellfish)	To monitor bacteriological contamination in shellfish	Targeted	National	Representative sample	Active	Autonomous
RESABO (network for monitoring antibiotic resistance of the principal bacterial pathogens of cattle)	To monitor the development of antibiotic resistance in the main bacterial pathogens affecting cattle	Targeted	National	Sample (by laboratories, on a voluntary basis)	Passive	Integrated
CESAM (epidemiological surveillance network for contagious equine metritis)	To monitor changes in contagious equine metritis	Targeted	National	Sample (by breeders, on a voluntary basis)	Passive	Integrated
<i>Salmonella</i> network	To monitor changes in <i>Salmonella</i> serotypes	Targeted	National	Sample (by laboratories, on a voluntary basis)	Passive	Partly integrated and partly autonomous
RESSAB (epidemiological surveillance network for suspected cases of bovine salmonellosis)	To monitor suspected cases of salmonellosis in adult cattle	Targeted	National	Sample (by veterinarians, on a voluntary basis)	Passive	Partly integrated and partly autonomous
OPA (network for monitoring bovine pasteurellosis)	To monitor bovine pasteurellosis	Targeted	National	Sample (by veterinarians, on a voluntary basis)	Passive	Autonomous
VEGA*	To monitor the main diseases of cattle and sheep	Scanning	Regional	Sample (by veterinarians, on a voluntary basis)	Active	Partly integrated and partly autonomous
VIALINE*	To monitor changes in infectious diseases of cattle (infectious bovine rhinotracheitis; paratuberculosis; listeriosis)	Scanning	Regional	Sample (by livestock farmers, on a voluntary basis)	Passive	Integrated

\* Name of regional network.

range of **rapid rural appraisal** techniques, using multi-disciplinary teams, both in the agricultural sector generally (McCracken *et al.*, 1988) and specifically in relation to animal health issues (Ghirotti, 1992). Involvement of communities in data-gathering resulted in the term **participatory appraisal** being applied to this mainly qualitative approach (Pretty, 1995). More recently, **participatory epidemiology** has been coined to describe community participation in data collection and disease control (Mariner, 1996; Catley and Mariner, 2001). It is important to note that the technique therefore is not merely a data-gathering procedure, but is an integral part of animal-disease intervention strategies, of which surveillance is only a part. The active inclusion of local community-based animal health workers in disease control represents the maturing of a process that had begun in colonial times, when, for example, herders were used as 'vetscouts' and vaccinators (Jack, 1961).

## Techniques of data collection

Participatory epidemiology relies heavily on indigenous knowledge and terminology. This is known to be extensive. Thus, the Maasai were the first to suggest that wildebeest were associated with bovine malignant catarrhal fever<sup>11</sup> (see Chapter 2), and nomadic cattle-owners can competently diagnose rinderpest (Plowright, 1998). Moreover, local diagnosis often compares favourably with conventional scientific investigation (Baumann, 1990; Edelsten, 1995; Mariner and Roeder, 2003; Catley *et al.*, 2004). It therefore has a useful role to play in the timely identification of disease in the field, and to confirm the absence of clinical disease.

Two key features of participatory data collection (Mariner, 2000) are:

1. **triangulation:** information is gained from several intentionally different perspectives; and:
2. **flexibility:** appraisals are not rigidly pre-planned and executed without deviation; techniques and questions may be changed during the investigation.

The main methods for collecting information are by **semi-structured interviews, scoring and ranking, and visualization.**

### Semi-structured interviews

Interviewing is a major participatory method, being used in circumstances that render questionnaires impracticable (e.g., because of illiteracy). In contrast to

the structured design of interviews used in developed countries (see Chapter 11), interviews should have only a basic structure, and the interviewer should improvise, depending on the responses and interests of the informant (Slim and Thomson, 1994). The interviewer also should be willing to make culturally appropriate gestures of understanding, sympathy, or encouragement.

### Scoring and ranking methods

Two methods are commonly used: **matrix scoring** and **proportional piling**. Matrix scoring involves the creation of a matrix, with different diseases on the horizontal axis, and characteristics associated with the diseases (e.g., clinical signs) on the vertical axis. Piles of counters (e.g., stones) are then used to complete the cells of the matrix, indicating the relative magnitude of the relationships. An example, relating to diseases in the Upper Nile region of southern Sudan occupied by the Nuer, is given in *Figure 10.2*. Three Nuer conditions, *liei*, *maguar* and *macueny*, are associated with chronic wasting. Two other conditions, *dat* and *doop*, had already been identified as foot-and-mouth disease and contagious bovine pleuropneumonia, respectively. Matrix scoring of the signs of *dat* and *doop* (e.g., salivation and coughing for the two respective diseases) suggested that the pastoralists could effectively

Signs	Diseases				
	<i>Liei</i>	<i>Dat</i>	<i>Maguar</i>	<i>Doop</i>	<i>Macueny</i>
Chronic weight loss	•••••	•	••	•	•
Animal seeks shade		•••••			
Diarrhoea	••		•••••		••
Reduced milk yield	••	•••••	••	•	
Coughing				•••••	
Reduced appetite		•••••		••	
Loss of tail hair	•••••				
Tearing	•••	••	••		••
Salivation	••	•••••	••	•	

**Fig. 10.2** Matrix scoring of disease signs for diseases of adult cattle in Nyal, southern Sudan. (Nuer names in italics.) (Simplified from Catley, 2004.)

<sup>11</sup> The Maasai use the same word for 'wildebeest' and 'malignant catarrhal fever' (Barnard *et al.*, 1994).

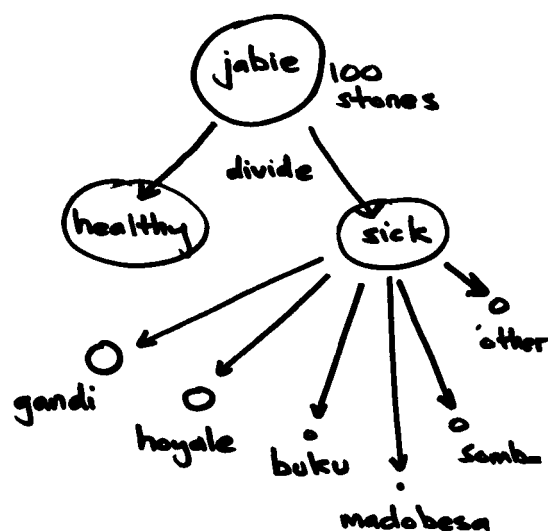

*jabie*: calves  
*gandi*: trypanosomiasis  
*hoyale*: foot-and-mouth disease  
*buku*: acute trypanosomiasis due to *Trypanosoma vivax*  
*madobesa*: rinderpest  
*somba*: contagious bovine pleuropneumonia

**Fig. 10.3** Proportional piling: method for incidence estimates for diseases of calves in Orma communities, Kenya. (Number of stones in each pile indicated by sizes of circles.) (Figure provided by Andrew Catley, African Union/Interafrican Bureau for Animal Resources, Nairobi, Kenya.)

monitor the occurrence of these specific diseases. The three other conditions posed a more thorny diagnostic issue. Further matrix scoring of these conditions against putative causal factors (e.g., liver flukes, exposure to snails or biting flies), supported by conventional laboratory investigations, suggested that *macueny* and *maguar* involved helminths, with fascioliasis predominating in the former, and gastrointestinal parasites in the latter. *Liei* was more complex, including fascioliasis, gastrointestinal parasites, trypanosomiasis and schistosomiasis. Thus, the local monitoring of *liei*, *macueny* and *maguar* indicates only a broad range of conventional potential diseases, rather than specific ones. However, for a syndrome with non-specific clinical signs, herders were able to sub-classify three 'local diseases', based on seasonality and causal factors, better than veterinarians, who tended to diagnose *liei* cases as trypanosomiasis *per se*.

Matrix scoring is also a useful means of confirming verbal descriptions given in interviews (i.e., triangulation).

Proportional piling uses stones or similar counters to indicate the relative frequencies of diseases or disease-associated characteristics. *Figure 10.3*, for example, depicts the relative annual incidence of various diseases in calves in Orma communities in Kenya.

Confidence in scoring and ranking methods is increased if there is a high degree of agreement

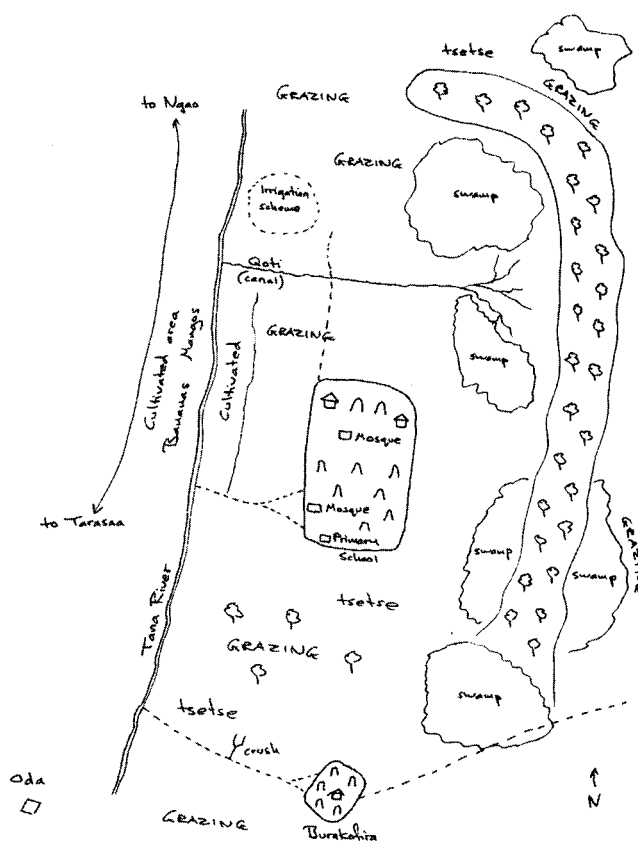

**Fig. 10.4** Participatory map of Kipao village, Tana River District, Kenya. (From Catley, 2004.)

(see Chapters 9 and 17) between different groups of informants<sup>12</sup>.

### Visualization methods

A variety of methods to present events pictorially may be used. These include maps, time lines (see Chapter 4), flow charts and seasonal calendars. **Participatory mapping** is used to explore local perceptions of the spatial distribution of disease and risk factors. *Figure 10.4* is a map of a village in the Tana River District of Kenya, inhabited by Orma pastoralists. The map was originally drawn on the ground using branches, leaves and stones. Key features, such as rivers, the school, the mosque, grazing, cultivation and water resources are depicted. This allowed villagers to indicate proximity of cattle to tsetse-infested areas, and the information was triangulated against matrix scoring to substantiate villagers' perception of high-risk areas with respect to transmission of trypanosomiasis (*gandi*).

<sup>12</sup> In the studies from which the examples in this section are drawn, agreement was quantified using the Kendal coefficient of concordance (see *Table 14.2*) and was found to be generally good.



	Orma seasons														
	Hageiya			Bona hageiya			Gana			Shur-icha		Bona adolesa			
	O	N	D	J	F	M	A	M	J	J	A	S			
Gregorian calendar															
Rainfall	•••						••••			••					
Trypanosomiasis	••••			••••			•			•		••			
Foot-and-mouth disease	••			••••			••			••		••			
Haemorrhagic form <i>T. vivax</i> <i>Buka</i>	••••			••••••						•		••			
Contagious bovine pleuropneumonia <i>Somba</i>				•			••			••••		••••			
Contact with tsetse <i>Gandi</i>	••••			••••			••			••••		••			
Contact with Tabanids <i>Kobabe</i>	••••••			••			••								
Contact with ticks <i>Shilmi</i>	••••			••••			•			•		••			
Contact with buffalo <i>Gadarsi</i>	••			••••								••••			

Fig. 10.5 Seasonal calendar for livestock diseases and disease-related factors in Tana River District, Kenya. (Simplified from Catley *et al.*, 2002b.)

A **seasonal calendar** again uses counters to indicate the relative occurrence of diseases. Figure 10.5 is an example relating to several diseases and disease-related factors, also in the Tana River District. Thus, *gandi* was common in the hot and wet seasons, Hageiya and Bona hageiya (Gregorian-calendar months October–March), and is therefore consistent with the observations of contact with tsetse. This information was triangulated with two other participatory methods: (1) matrix scoring of disease signs indicated that herders characterised *gandi* using similar clinical signs and causal factors to those described by veterinarians; (2) mapping showed that herders identified tsetse habitats and considered these areas to be high-risk areas for *gandi*.

### Strengths and weaknesses of participatory epidemiology

Conventional survey methods (especially questionnaires) are subject to several particular types of bias when used in developing countries (Chambers, 1983):

- **spatial bias:** investigators are more likely to travel on better roads; therefore farms in more remote areas may be under-represented (i.e., sampling is by convenience: see Chapter 13);

- **project bias:** researchers may be channelled to areas considered to be important;
- **person bias:** only influential, rich people may be interviewed, and they may be ignorant of the circumstances of the poor, and therefore of their animals;
- **dry-season bias:** malnutrition and high levels of morbidity and mortality are more common in the dry season; surveys conducted at other times may therefore underestimate problems;
- **'diplomatic' bias:** 'politeness' and 'diplomacy' may try to hide poverty and its attendant problems.

Participatory approaches can help to overcome some of these biases; for example, by reaching places away from main roads, meeting all kinds of people (rich and poor), visiting areas beyond project areas, and understanding seasonality (e.g., by using seasonal calendars). They also may be the only alternative when sample surveys are precluded (Carruthers and Chambers, 1981); notably if the target population is scattered over a wide and remote area, if there is no base for a sampling frame, and if a study aims to look at many variables, rendering choice of which variable on which to base sample-size calculations (see Chapter 13) difficult.

Participatory epidemiology, however, also has weaknesses, some of which are the result of impressions (Catley, 2000; Mariner, 2000):

- there are negative perceptions of qualitative approaches among some veterinary epidemiologists, who focus on numerical methods;
- there is a need for good training to ensure best practice and to correct misconceptions (e.g., that questionnaires are participatory methods);
- success depends on indigenous knowledge; this is good amongst pastoralists, but may be less developed in communities that are less dependent on livestock.

### Some examples of participatory epidemiology

Examples of successful participatory initiatives include delivery of rinderpest vaccination to remote areas of Ethiopia, Sudan and Uganda (Catley and Leyland, 2001); identification of mild rinderpest resulting from transhumance in East Africa (Mariner and Roeder, 2003; OIE, 2003); description of contagious bovine pleuropneumonia in Sudan and Tanzania (Mariner *et al.*, 2002) and trypanosomiasis in camels in Kenya (Mochabo *et al.*, 2005); exploration of the association between heat intolerance syndrome and foot-and-mouth disease (Catley *et al.*, 2004) and general improvement in animal health (Mugunieri *et al.*, 2004).

Participatory methods are described in detail by Catley (1999), Mariner (2000) and Catley *et al.* (2002a).

## Further reading

- Blancou, J. (2003) *History of the Surveillance and Control of Transmissible Animal Diseases*. Office International des Epizooties, Paris
- Curtis, C.R. and Farrar, J.A. (Eds) (1990) The National Animal Health Monitoring System in the United States. *Preventive Veterinary Medicine*, **8**, 87–225
- DEFRA (2002) *Partnership, Priorities and Professionalism. A Proposed Strategy for Enhancing Veterinary Surveillance in the UK*. Department for Environment, Food and Rural Affairs, London
- DEFRA (2003) *A Strategy for Enhancing Veterinary Surveillance in the UK*. Department for Environment, Food and Rural Affairs, London
- Doherr, M.G. and Audigé, L. (2001) Monitoring and surveillance for rare health-related events: a review from the veterinary perspective. *Philosophical Transactions of the Royal Society of London, Series B*, **356**, 1097–1106
- Dufour, B., Pouillot, R. and Toma, B. (2001) Proposed criteria to determine whether a territory is free of a given animal disease. *Veterinary Research*, **32**, 545–563
- FAO (1999) *Manual on Livestock Disease Surveillance and Information Systems*. FAO Animal Health Manual No. 8. Food and Agriculture Organization of the United Nations, Rome
- Geering, W.A. (1992) Some epidemiological principles in disease surveillance and reporting. *Office International des Epizooties Quarterly Report (Asian and Pacific Region)*, **1**, 31–35. (A brief discussion of information requirements for disease surveillance systems)
- Hinman, A.R. (1977) Analysis, interpretation, use and dissemination of surveillance information. *Bulletin of the Pan American Health Organization*, **11** (4), 338–343
- Hutton, N.E. and Halvorson, L.C. (1974) *A Nationwide System for Animal Health Surveillance*. National Academy of Sciences, Washington, DC
- Jebara, K.B. (2004) Surveillance, detection and response: managing emerging diseases at national and international levels. *Revue Scientifique et Technique, Office International des Epizooties*, **23**, 709–715
- Kellar, J.A. (2005) Portrait of the national veterinary service as a surveillance continuum. *Preventive Veterinary Medicine*, **67**, 109–115
- Konigshofer, H.O. (1972) *The Organisation of Surveillance of Animal Diseases*. World Health Organization inter-regional seminar on methods of epidemiological surveillance of communicable diseases including zoonoses and food-borne diseases, Nairobi, 9–20 October, 1972. Working Paper No. 8
- MacDaniel, H.A. and Sheridan, M.K. (Coordinators) (2001) Traceability of animals and animal products. *Revue Scientifique et Technique, Office International des Epizooties*, **20**, 359–661
- MAFF (1976) *Animal Disease Surveillance in Great Britain*. Report of a Ministry of Agriculture, Fisheries and Food Working Party. Ministry of Agriculture, Fisheries and Food, London
- Martinez, T.A., Kaneene, J.B., Lloyd, J.W. and Brown, M.I. (1992) Potential users and user requirements of an animal health monitoring system in a developing country: case study of Honduras. *Preventive Veterinary Medicine*, **13**, 1–11
- Meah, M.N. and Lewis, G.A. (2000) *Veterinary Surveillance in England and Wales – A Review*. Ministry of Agriculture, Fisheries and Food Publications, London
- Moorhouse, P.D. and Hugh-Jones, M.E. (1981) Serum banks. *Veterinary Bulletin*, **51**, 277–290
- Mörner, T., Obendorf, D.L., Artois, M. and Woodford, M.H. (2002) Surveillance and monitoring of wildlife diseases. *Revue Scientifique et Technique, Office International des Epizooties*, **21**, 67–76
- PAHO/WHO (1999) Third Meeting of the Task Force on Surveillance for Emerging and Reemerging Infectious Diseases, Mexico City, Mexico, 16–17 November 1998. Final Report. Pan American Health Organization/World Health Organization Communicable Diseases Program, Division of Disease Prevention and Control. PAHO/HCP/HCT/141/99. Pan American Health Organization, Washington, DC
- Pini, A., Parodi, P., Demeneghi, D., Belemu, U., Kabilika, H. and Ghiretti, M. (Eds) (1994) *Basic Procedures for Diagnostic Veterinary Laboratories in Developing Countries* World Health Organization/Food and Agriculture Organization of the United Nations, Rome. (A guide to the selection and handling of appropriate tissue samples to identify animal diseases in developing countries)
- Poppensiek, G.C., Budd, D.E. and Scholtens, R.G. (1966) *A Historical Survey of Animal-Disease Morbidity and Mortality Reporting*. National Academy of Sciences, Washington, DC. Publication No. 1346
- Radunz, B. (2006) Surveillance and risk management during the later stages of eradication. Experiences from Australia. *Veterinary Microbiology*, **112**, 283–290
- Saatkamp, H.W., Huirne, R.B.M., Dijkhuizen, A.A., Geers, R., Noordhuizen, J.P.T.M. and Goedseels, V. (1994) The potential value of identification and recording systems in contagious disease control. In: Proceedings of the seventh International Symposium on Veterinary Epidemiology and Economics, Nairobi, 15–19 August 1994. Eds Rowlands, G.J., Kyule, M.N. and Perry, B.D. *The Kenya Veterinarian*, **18** (2), 391–393
- Salman, M.D. (Ed.) (2003) *Animal Disease Surveillance and Survey Systems: Methods and Applications*. Iowa State Press, Ames
- Schilf, B.A. (1975) Meat inspection service as an element of epidemiologic surveillance and a component of animal disease control programmes. Seventh Inter-American Meeting on Disease and Zoonosis Control, April 1974, pp. 149–153. Pan American Health Organization/World Health Organization Scientific Publication No. 295
- USDA (1982) *International Directory of Animal Health and Disease Data Banks*. National Agriculture Library, United States Department of Agriculture, Miscellaneous Publication No. 1423

# 11

## Data collection and management

The previous chapter outlined some sources of veterinary data in the context of disease surveillance. This chapter focuses on some principles and methods of data collection, storage and distribution as useful information<sup>1</sup>. Emphasis will be placed on the suitability of the techniques to epidemiological studies, although some of the standard methods of clinical case recording will be outlined. Finally, some examples of veterinary information systems will be given.

### Data collection

#### Methods of data collection

Data are collected in three main ways, by:

1. **observation** (e.g., clinical examination, diagnostic imaging and post-mortem examination);
2. completing **questionnaires** (either directly or by interview);
3. use of **documentary sources** (e.g., clinical records, and records of diagnostic laboratory results), with an increasing use of data sets generated by other workers.

Data derived from the first two methods are **primary**, whereas data obtained by the third method are **secondary**.

Observation is central to the practice of clinical veterinary medicine, and is also important in many epidemiological investigations (e.g., outbreak investigation: see Chapter 22). Additionally, surveillance

(Chapter 10), surveys (Chapter 13) and observational studies (Chapter 15) may use secondary data. However, there are occasions when the appropriate information is not readily available, in which case it must be collected using questionnaires.

### Questionnaires

A questionnaire is a set of written questions. The person who answers the questionnaire is termed the **respondent**.

#### Structure of a questionnaire

The questionnaire is designed to record information:

- in a standard format;
- with a means of checking and editing recorded data;
- by a standardized method of questioning;
- with a means of coding.

Questions may be either **open-ended** or **closed**.

**Open-ended questions** These allow the respondent freedom to answer in his or her own words; for example, 'What is your opinion of intramammary preparation X?'. The chief advantage of the open question is the freedom of expression that it permits: the respondent is allowed to comment, pass opinions and discuss other events that are related to the question's topic. The disadvantages are, first, that open questions can increase the length of time taken to complete a questionnaire and, secondly, that the answers cannot be coded (see Chapter 9) when the questionnaire is designed, because the full range of answers is not

---

<sup>1</sup> Methods of physically storing and ordering records have been described in detail elsewhere (Duppong and Ettinger, 1983; Thrusfield, 1985b; Nelson and White, 1990).

known. A range of answers may be difficult to categorize and code. Continuous variables can be grouped into intervals (e.g., 0.0–1.9 kg, 2.0–2.9 kg) for coding.

**Closed questions** Closed questions have a fixed number of options of answers. The questions may be **dichotomous**; that is, with two possible answers, such as ‘Do you use intramammary tube X for dry cow therapy (answer yes or no)? Alternatively, the questions may be **multiple choice**; for example ‘When did your dog last have a litter? – Within the last 3 months, 4–6 months, 7–11 months, 1–5 years?’

Closed questions are useful for ascertaining categorical, discrete data, such as breed and sex. The advantages of the closed question are ease of analysis and coding because of the limited, fixed response that is allowed. Codes can be allocated when the questionnaire is designed. The closed question is also quick to answer. A major disadvantage is that, because the options of answers are fixed, the answers may not reveal related events that may be significant.

### Coding

It is now unthinkable not to store the results of a questionnaire in a computerized database (described below). Therefore, questionnaires are frequently coded to facilitate transcription to such databases. Each question and each possible answer is coded. For example, in the question:

26. What is the sex of your animal?  
Enter 1 if male and 2 if female,

the question is coded as number 26, and the options to the answers to the dichotomous question are coded as either 1 or 2. The name of the respondent may be coded if confidentiality is required. It is also desirable to justify numeric answers to the right for transcription to computerized systems. For example, the date 8 March 2004 is coded as:

0	8	0	3	0	4
---	---	---	---	---	---

not

8	3	4		
---	---	---	--	--

to allow for 31 days in the month, 12 months in the year, and 100 years (00–99) in a century.

Many computerized systems automatically code data from text that is entered

### Designing a questionnaire

The success of a questionnaire depends on careful design. Ideally, everyone who is issued with a questionnaire should complete it. The proportion of those

who respond is the **response rate** (usually expressed as a percentage). The **non-response rate** is therefore 100 – response rate (%); for example, a response rate of 70% represents a non-response rate of 30%. Non-response from a respondent may be either total, in which the questionnaire is not returned, or partial, in which some questions are not answered but the partially answered questionnaire is returned. Good questionnaire design decreases both types of non-response.

**Initial presentation** The title of the questionnaire should be brief and accurate. A polite letter, explaining the reason for producing the questionnaire, and the value of the results deriving from its completion, should be enclosed (*Figure 11.1*). The inclusion of a reply-paid envelope should increase the response rate. Initial questions should be particularly interesting, to generate immediate enthusiasm.

**Wording** Wording should be unambiguous, brief, polite, unemotional, and non-technical. If technical terms are used, then they should be defined simply. Common ambiguous terms include ‘often’, ‘occasionally’, ‘severe’, ‘mild’, ‘heavy’ and ‘light’. Double negatives should be avoided. Each question should contain only one idea. Sensitive, emotive and emotional questions should be avoided<sup>2</sup>. The questionnaire should be as short as possible, whilst obtaining the required information. Brevity is particularly important in developing countries (Gill, 1993), where translation may also require attention (Lee *et al.*, 1999).

**Question sequence** Related questions may need to be separated because the answer given to one question may influence that given to the succeeding question producing the phenomenon termed ‘carry over’. General questions should be presented first, and specific ones later. The questionnaire can be made more interesting by ‘branching out’ from one question to another; for example ‘If you answer yes to question 2, then move to question 8’. However, the number of questions should be as small as possible, while achieving the objectives of the survey.

**Question structure** Closed questions must be mutually exclusive and exhaustive. For example, the age of animals may be expressed as:

<sup>2</sup> Sensitive *subjects*, however, may be addressed. For example, Munro and Thrusfield (2001d) studied sexual abuse of animals (a sensitive issue) using a questionnaire (comprising both open-ended and closed questions) distributed to veterinary general practitioners in the UK. The questions did not specifically address the issue, but related to a purely factual description of the site and type of suspected non-accidental injuries. Only after the questionnaires had been returned were cases of a sexual nature identified, either from characteristics of the site and type of injury (in the completed closed questions) or from comments of the respondents (in open-ended responses).

This survey is supported by



and

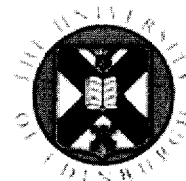

FACULTY of VETERINARY MEDICINE  
Royal (Dick) School of Veterinary Studies  
The University of Edinburgh  
Summerhall  
Edinburgh EH19 1QH

## Non-accidental injury in the dog and cat

Dear Colleague

**Please help us with this survey.**

**What is this survey about?**

The survey is about **non-accidental injury (NAI)** in the dog and cat. Non-accidental injury is also sometimes known as **physical abuse**. In children, you may also know it as the '**Battered Child Syndrome**'. In dogs and cats it therefore can be called the '**Battered Pet Syndrome**'.

**Why study NAI?**

**First:** although non-accidental injury is known to occur in companion animals, recognition and diagnosis can be very difficult for veterinary surgeons. There is no published comprehensive account of the circumstances, clinical signs and pathology of the 'battered pet'. In **child** physical abuse, which has been recognised for over 30 years, guidelines are available for recognising the condition and for helping to **differentiate** between **accidental** and **non-accidental** injury. For example, unexplained subdural haematomata and retinal haemorrhages are highly suggestive of NAI and a torn frenulum is virtually diagnostic.

The experiences of veterinary surgeons who complete this questionnaire will help to ascertain the extent of NAI in the dog and cat, as seen in clinical practice, and to formulate guidelines to differentiate between accidental and non-accidental injury.

**Secondly:** a diagnosis of NAI is important because there is evidence that the occurrence of physical abuse to animals may indicate that similar abuse is being directed against other family members, such as the children. It may also be an early indicator of future violent behaviour by the perpetrator<sup>1</sup>.

**Will your answers be anonymous?**

Yes. Your name and address are not requested.



† Arkow, P. (1994) Child abuse, animal abuse and the veterinarian. *Journal of the American Veterinary Medical Association*, **204**, 1004–1007

**Fig. 11.1** A letter introducing a questionnaire on non-accidental injuries in dogs and cats. (Black-and-white reproduction of a three-colour original.) (Study reported in Munro and Thrusfield, 2002a,b,c,d).

Age (please tick):    under 6 months      
                               6–12 months          
                               over 12 months     

In this case, there is no overlap of ages between categories (they are **mutually exclusive**) and all possible ages are included (the options are **exhaustive**). To ensure exhaustiveness, it may be necessary to include **dumping categories**, which accommodate all possibilities remaining after the specified options are considered. For example, 'other' is a dumping category in:

Against what infections has your dog been vaccinated (please tick):

distemper        parvovirus        hepatitis      
 leptospirosis        other           

Lack of confidentiality may increase the non-response rate. Total anonymity (e.g., *Figure 11.1*) ensures confidentiality but prevents the tracing back of information. A limited degree of confidentiality can be ensured by preventing identification of respondents by the majority of the data-processing staff. Three ways of doing this are:

1. by having a separate sheet of paper for the respondent's name and address, with a code identifying the respondent on the questionnaire;
2. by using a coded strip down one side of the questionnaire, which can be detached;
3. by using carbon-impregnated paper (NCR paper), allowing duplicates to be produced, but with the respondent's name masked off most of the copies.

Figures 11.2 and 11.3 are two examples of questionnaires. In the first example (a survey of John's disease in vaccinated herds), the following concepts are demonstrated:

- closed questions (e.g., No. 2);
- open-ended questions (e.g., No. 19);
- mutual exclusiveness and exhaustiveness (e.g., No. 17);
- a clear title, with a statement of confidentiality;
- a polite presentation (e.g., the last portion of the questionnaire that thanks the respondent for his or her co-operation).

In the second example (a lameness survey in cattle), these additional concepts are illustrated:

- a dumping category (the inclusion of '6. other' in description of breeds);
- confidential coding of the veterinary practice and veterinarian (2 digits) and farm (3 digits);
- a clear description and definition of terms that are used (sites and nature of lesions in this example).

Questionnaires can either be completed by respondents after having been delivered to them (frequently by mail), or completed by an interviewer who presents the questions, verbally (either in person or by telephone), to the respondents. Respondents can also complete questionnaires directly via the Internet (see below, and Gobar *et al.*, 1998), in which circumstance the results may be automatically stored directly in a computer, thereby preventing transcription errors.

### Mailed and self-completed questionnaires

**Requirements** The main requirements for a mailed or self-completed questionnaire are:

- a list of respondents to act as the sampling frame (see Chapter 13) (e.g., a register of veterinarians);
- great clarity: no one will be present to cope with any difficulties that may arise;
- a covering letter politely explaining the reason for sending the questionnaire (e.g., Figure 11.1).

**Advantages** The main advantages of this type of questionnaire are that:

- it is relatively cheap with potential for wide coverage;

- it is quick and easy to organize;
- it avoids interviewer bias (see below);
- it allows a highly motivated respondent to 'check the facts' over a period of time;
- respondents have the opportunity to reply anonymously, which may produce a high response rate.

**Disadvantages** The disadvantages of this type of questionnaire are that:

- clarity of question may be difficult to achieve;
- the questionnaire cannot prevent reviewing of questions, which may lead to undesirable modification of previously answered questions.

**Response rate** In mailed and self-completed questionnaires, response rates tend to be low – 50% is not uncommon, and the value can be as low as 10% (Edwards, 1990). The issuing of reminders or more questionnaires usually does not increase the response rate much (Thrusfield *et al.*, 1998; Barnett, 2003).

Factors influencing the response rate are:

- the sponsor – a respected sponsor should enhance the likelihood of obtaining a high response rate (e.g., Figure 11.1);
- the nature of the respondent population – a well-educated group should produce a higher response rate than a poorly educated group; similarly, a group with a specialist interest in the subject of the questionnaire should generate a high response rate;
- the subject and aim of the study – if the study is of obvious direct relevance and value to the respondent, then he or she is likely to reply (e.g., the response of woolgrowers to mailed questionnaires on blowfly strike: Ward, 2000);
- appearance and length of the questionnaire – if it is attractive and concise, then response should be good;
- confidentiality.

The results of questionnaires should be treated with caution when response rates are lower than about 70% because there may be systematic differences between those who do, and those who do not, respond (**response bias**). For example, in a questionnaire survey of scrapie in the UK, the average sheep flock size was larger on farms whose owners responded than on those whose owners did not respond (Wooldridge *et al.*, 1992).

### Interviews

A personal interview can overcome some of the disadvantages of mailed and self-completed questionnaires, and is particularly useful if many of the questions are

**INVESTIGATION OF JOHNE'S VACCINATED HERDS**

Conducted by: The Epidemiology Unit, Central Veterinary Laboratory, Weybridge, Surrey.

*PLEASE NOTE ALL INFORMATION WILL BE TREATED AS STRICTLY CONFIDENTIAL*

Herd Owner \_\_\_\_\_ 1. Herd Code \_\_\_\_\_

Address \_\_\_\_\_

2. Present herd type: Dairy  Beef  Mixed
3. Replacement policy. Entirely home reared. Please write YES or NO \_\_\_\_\_
4. % breed composition of present adult herd \_\_\_\_\_
5. Present adult herd size \_\_\_\_\_
6. Present system of winter housing: Cowshed  Cubicles  Loose  Outwintered
7. Method of pasture utilization: Intensive  Extensive
8. Date of approval for use \_\_\_\_\_/\_\_\_\_\_/19\_\_\_\_
9. Year in which vaccination started. 19\_\_\_\_
10. If vaccination has been intermittent please give the years in which either vaccine was not used or in which only some of the animals retained for breeding were vaccinated \_\_\_\_\_
11. Year in which vaccination ceased. 19\_\_\_\_ Write NA if not applicable \_\_\_\_\_
12. Average number of clinical cases of Johne's disease per year prior to vaccination \_\_\_\_\_ cases
13. Adult herd size at start of vaccination \_\_\_\_\_

14. Number of clinical cases occurring in each year since vaccination started:

Years since start of vaccination	Number of clinical cases	Years since start of vaccination	Number of clinical cases
1		5	
2		6	
3		7	
4		8	

If clinical cases occurred 9 years or more after start of vaccination please specify which year(s)

15. Have there been any major changes in breed since vaccination started? Please write YES or NO \_\_\_\_\_  
If 'YES', please specify change with approximate date from \_\_\_\_\_ to \_\_\_\_\_ in 19\_\_\_\_
16. Have there been any changes in herd type since vaccination started? Please write YES or NO \_\_\_\_\_  
If 'YES', please specify change with approximate date from \_\_\_\_\_ to \_\_\_\_\_ in 19\_\_\_\_
17. Have any attempts been made to identify latently infected animals? Please write YES or NO \_\_\_\_\_  
If 'YES', please specify diagnostic methods used: CFT  Johnin  Microsc. Exam  Faeces Culture   
and whether positive animals were called: Always  Sometimes  Never
18. Please indicate which of the following control measures are practised on the farm:

Please write YES or NO

- (a) prompt removal of confirmed clinical cases \_\_\_\_\_
- (b) only 'bucket' rearing of calves (in dairy herds) \_\_\_\_\_
- (c) adequate separation of calves from adults (in dairy herds) \_\_\_\_\_
- (d) removal from herd of calves born of infected dams \_\_\_\_\_

---

(e) adequate hygiene of food and water supplies to housed animals \_\_\_\_\_

(f) piped water supplies to all cattle at pasture \_\_\_\_\_

(g) prevention of access to ponds and ditches etc. \_\_\_\_\_

(h) calves grazed on pastures not used by adult cattle \_\_\_\_\_

19. Have any other changes in management been instituted to control the disease?

\_\_\_\_\_

\_\_\_\_\_

\_\_\_\_\_

20. Do you think the vaccine has had a valuable part to play in the control of Johne's disease in this herd? Please write YES or NO

\_\_\_\_\_

GENERAL COMMENTS

*THANK YOU FOR YOUR CO-OPERATION IN THIS INVESTIGATION.*

The completed questionnaire should be sent to:

J. W. Wilesmith, B.V.Sc., M.R.C.V.S.  
Epidemiology Unit,  
Central Veterinary Laboratory,  
New Haw,  
Weybridge,  
Surrey KT14 3NB.

**Fig. 11.2** A questionnaire survey of Johne's disease (paratuberculosis) in vaccinated cattle in Great Britain. (A questionnaire produced by John Wilesmith of the Central Veterinary Laboratory, UK, 1977.)



Practice  
Vet  
Farm  
Management System

If 1.  
1 up to 100 yds  
2 100-200 yds  
3 200-400 yds  
4 400-800 yds  
5 over 800 yds

road  
hardcore

Date of Visit  
D  
M  
Y

Hours per day when feet are wet

1 0-3 hrs  
2 3-6 hrs  
3 6-12 hrs  
4 12-18 hrs  
5 18-24 hrs

Is cow  
1 Dry.  
2 Dry, pregnant  
3 Dry non-pregnant  
4 Lactating

No of cows on farm

Calving date  
if 2, expected  
if 4, last  
D  
M  
Y

Heart girth (cm)

Age (yr)

Predominant breed  
1 Fresian  
2 Ayrshire  
3 Shorthorn  
4 Guernsey  
5 Jersey  
6 Other

Origin  
1 Homebred  
2 Bought

LEG  
1  
2  
3  
4  
5  
6  
7  
8  
9

distance from pasture to parour on grass

1 Bone  
2 Muscle  
3 Joint and ligaments  
4 Tendon, sheath and bursa  
6 Other

ARC I.R.A.D. 1977  
LAMENESS SURVEY

1 Infection  
2 Trauma  
3 Both infection and trauma  
4 Other

Tissue most affected

Site above foot

1 RF  
2 RH  
3 LH  
4 LF

Foot/Leg

Lesion 1 2 3

1 Inner  
2 Outer

Claw

Foot lesion

Site in claw

Condition of claw  
1 Normal  
2 Overgrown  
3 Axial rotation  
4 Unequal

Anterior  
Abaxial  
Axial  
Posterior

1  
2  
3  
4  
5

FOOT  
01 - Sole ulcer  
02 - White line separation  
03 - White line abscess  
04 - Punctured sole and pus  
05 - Foreign body in sole  
06 - Overworn sole  
07 - Foul of the foot  
08 - Interdigital hyperplasia  
09 - Interdigital foreign body  
10 - Under run heel  
11 - Sandcrack  
12 - Aseptic laminitis  
13 - Deep sepsis  
14 - Other

Code	Term	Description
01	Sole ulcer	Circumscribed pododermatitis at sole-heel junction, with or without protrusion of granulation tissue through horn defect
02	White line separation	Breakdown of integument of white line, usually abaxially, and impaction of foreign material into crack
03	White line abscess	Breakdown of integument of white line, usually abaxially, and occurrence of septic laminitis of wall
04	Punctured sole and pus	Traumatic penetration of solar horn with infection of laminae and pus production
05	Foreign body in sole	Self-explanatory
06	Overworn sole	Sole which is obviously flexible, horn usually not more than 3 mm thick, often discoloured laminae due to haemorrhagic bruising
07	Foul of the foot	Interdigital necrosis affecting skin and, or, subcutaneous tissues
08	Interdigital hyperplasia	Thick interdigital skin fold, often with localised areas of pressure necrosis or ulceration as secondary feature
09	Interdigital foreign body	Self-explanatory
10	Underrun heel	Separation of heel horn axially towards sole-heel junction, usually with some exposure and infection of sensitive laminae; erosion of heel horn
11	Sandcrack	Vertical split in wall horn at coronet or lower down, involving sensitive tissues
12	Aseptic laminitis	Generalised digital pain and heat, often involving more than one foot, and without break in integument
13	Deep sepsis	Self-explanatory
14	Other	

Fig. 11.3 A questionnaire survey of lameness in cattle in Great Britain. Respondents were requested to indicate which categories were appropriate to their farm and cattle. (From Russell *et al.*, 1982.)

open-ended, and where illiteracy of the respondent is a problem. The tone of the interviewer's voice may, however, bias the respondent's answer, by implying a desirable answer (**interviewer bias**). Questionnaires can be longer than self-completed ones, and response rates of 90% can sometimes be achieved (Edwards, 1990). However, personal interviews can be costly to organize, involving training, payment and travelling expenses of interviewers.

Telephone interviews (Groves *et al.*, 1988; Frey, 1989) also generally have high response rates, and can produce results more quickly and cheaply than personal interviews and mailed questionnaires. However, questions need to be short to reduce conversation time to a minimum. Telephone interviews can be used to follow up non-responders in surveys that are initially based on mailed and self-completed questionnaires, in an attempt to reduce response bias.

A general introduction to interviewing technique is provided by Oppenheim (1992) and Kvale (1996). The use of veterinary interviews is discussed by Ruppanner (1972) and, in developing countries, by Perry and McCauley (1984). Examples of their use include surveys of schistosomiasis in the Sudan (McCauley *et al.*, 1983b), swine fever in Honduras (McCauley, 1985), bovine health and productivity in Zambia (Perry *et al.*, 1984a) and sheep diseases in New Zealand (Simpson and Wright, 1980).

### Testing questionnaires

Several drafts of a questionnaire are usually required following testing. There are normally two stages to testing: **informal** and **formal**.

**Informal testing** Informal testing is carried out on colleagues who can detect trivia, ambiguities and defects in questionnaire design.

**Formal testing** Formal testing is undertaken on a small random sample of the population on which the full survey will be conducted. This testing is called a **pilot survey**. The size of the sample is chosen using the guidelines for sample size-determination in surveys (see Chapter 13). The pilot survey exposes further defects in questionnaire design. This survey should never be used as part of the full survey, and respondents used in the pilot survey should never be used again in the full one.

### Criteria for success of questionnaires

The two main criteria for the success of a questionnaire are **reliability** and **validity** (Chapter 9).

**Reliability** A questionnaire, like a diagnostic test, is reliable if it produces consistent results (see *Figure 9.6*). Reliability can be assessed by issuing the same questions to the same respondents more than once (e.g., French *et al.*, 1992; Slater *et al.*, 1992; Reeves *et al.*, 1996a) and assessing the agreement between the responses. The method of assessment depends on the scale of measurement (see Chapters 9 and 17). Slater (1997) reviews measures of reliability for questionnaires.

**Validity** Validity is a measure of the degree to which answers, on average, reflect the truth (see *Figure 9.6*). Validity is therefore achieved by comparing the results of the questionnaire with an independent reliable criterion. For example, Selby *et al.* (1973, 1976) compared the results of a mailed questionnaire with information derived from farm records and diaries, when investigating congenital abnormalities in pigs; Perry *et al.* (1983), in a survey of several animal diseases in

Zambia, compared the results obtained from an owner interview survey with those obtained from an investigation of sentinel herds; the results of a telephone interview on diet and exercise in dogs were compared with subsequent written dietary records (Slater *et al.*, 1991); the results of a personal interview on pig production were compared with validated production records (Deen *et al.*, 1995); and farmers' diagnoses of John's disease were compared with veterinary and diagnostic-laboratory diagnoses (Çetinkaya *et al.*, 1998). Sensitivity and specificity (see Chapters 9 and 17) can be calculated for questions with either a positive or negative ('yes'/'no') outcome; continuous and ordinal data require other techniques (Maclure and Willett, 1987).

Unreliability often means invalidity. However, reliable questions may not always be valid (see *Figure 9.6b*).

Further details of veterinary questionnaires can be found in Waltner-Toews (1983), Edwards (1990) and Vaillancourt *et al.* (1991). Pfeiffer (1996) discusses the use of veterinary questionnaires and interviews in developing countries

### Quality control of data

'Quality control' refers to the checks that are conducted during and after the collection of data, to ensure that data are accurate.

### Sources of data

There are several ways of maintaining the quality of primary sources. If observations are recorded by the data analyst, then he or she should ensure that they are carefully documented. If observations are recorded by another person, or if the data are recorded on a self-completed questionnaire or by an interview, then the criteria for assessing the success of a questionnaire, above, provide the quality-control guidelines.

Secondary data may be harder to assess. If documentation is recent, then the data may be cross-checked by issuing a questionnaire, or by interview. For example, during the 2001 foot-and-mouth disease epidemic in the UK, details of stock location were recorded by the veterinarian visiting each infected farm. Sometimes details were inadequate, and it was also noted that the data were recorded at a stressful time. Therefore, a postal questionnaire was distributed to owners of affected farms with deficient data, and remaining deficiencies corrected by personal interview, followed up by telephone interview, if necessary (Thrusfield *et al.*, 2005a).

Documentary sources dating back many years may be hard or impossible to validate.

## Data entry

Ideally, two people should be involved in data entry, to reduce the likelihood of transcription errors. Coding of data should also allow software to detect inconsistencies or 'illegal' values, and detect 'finger trouble' (see Chapter 9), and is therefore particularly useful if only one person is available for data entry. Some quantitative values may appear to be extreme in the context of other values in the data set, and it may not be possible to verify their authenticity. Armitage *et al.* (2002) describe how to explore and manage such values.

## Missing values

It is not uncommon for data to be incomplete; for example, if there is partial non-response in a questionnaire. There are two ways of tackling this issue. First, attempts can be made to complete that data (e.g., by telephoning respondents); this is therefore a quality-control issue.

Secondly, the data can be recorded in an incomplete form, and the problem addressed at the stage of data analysis. There are then two approaches. First, all records with incomplete data are excluded from data, and therefore only complete records included: this is **complete-subject analysis**. This is a simple approach, but is only valid if the records with complete data are a random sample of the records of all subjects in a study, or of subjects within complete categories (Little and Rubin, 2002). However, data are lost (particularly when many records are incomplete) and the conditions under which the approach is valid are limited. Alternatively, incomplete records can be included in analysis. The two main methods involve (1) predicting missing values based on the patterns of values in complete records; or (2) assigning weights to missing data (Little and Rubin, 2002). Note, however, that creating categories for missing variables, for subsequent analysis, is not valid (Vach and Blettner, 1991; Greenland and Finkle, 1995).

## Data storage

After data have been collected, they should be saved in a **database**; that is, a structured collection of data, which is the basis of an organized data storage and retrieval system.

## Database models

A database containing animal records includes different types of data that comprise different components of the records. The data consist of several categories

(**specifier types**), for example, breed, sex, age and clinical signs, that are attributes (**features**) of the animal (**item**). Some of these are permanent attributes and therefore are **case-specific**, for example, breed and date of birth. Others, such as diagnoses and signs, change from one consultation (and therefore record of consultation) to another, thus being **record-specific**.

The association between the various components of a record can be viewed in several ways, depending on the way in which the data are stored, producing four models of a database.

### The 'record' model

The **record** model is the traditional way of structuring data. The central component is the individual record, which contains case- and record-specific data. This is a useful approach for the clinician concerned mainly with individual patient care. However, it is difficult to correlate specifier types between records. Correlation is very useful in epidemiological studies, for example, correlation of breed, age and sex with disease.

### The 'hierarchic' model

The **hierarchic** model and the two that follow are used to explain how data can be stored and handled in computerized systems. In this model, data components are stored in **nodes** which are arranged in a tree-like structure (Figure 11.4). The uppermost level of the hierarchy has only one node; it is called a **root**. With the exception of the root, every node has one node related to it at a higher level; the latter is called the former's **parent**. No component can have more than one parent. Each component can have one or more components related

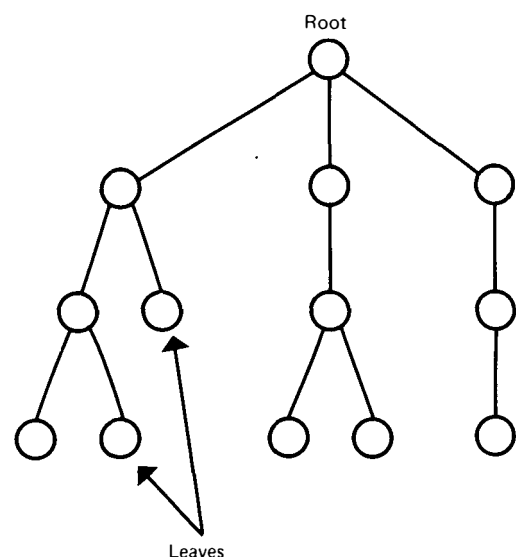

Fig. 11.4 The 'tree' structure of a hierarchic database.

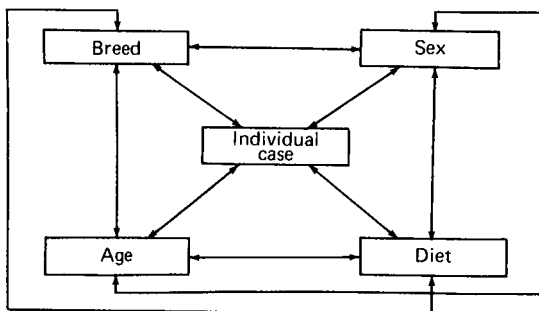

Fig. 11.5 An example of some possible relations in a simple 'network' database. (From Thrusfield, 1983a.)

Table 11.1 The structure of data components in a simple 'relational' database.

Animal's name	Age	Sex
Patch	7	M
Sally	5	F
Thor	13	M
.	.	.
.	.	.
Arthur	4	M
Liz	15	F
Brenda	9	F
.	.	.
.	.	.

- each row of the table is unique and the order of the rows is immaterial.

An example is given in *Table 11.1*.

The relational approach is different from that of the hierarchical and network models. The principal difference is that, in the hierarchical and network models, relationships are expressed explicitly and are predefined. In the relational model, the basic data structure is predefined but record relationships are not defined until they are used. This ability to dynamically reflect relationships, combined with the simplicity of the relational model, makes it potentially more flexible than the other models, which it can also represent. The main disadvantage of the relational model is its inefficiency relative to the other two, because, although the model is simple, it is complex to implement on computers. However, the increasing sophistication of computer technology has now made this model the basis of most computerized databases.

## Non-computerized recording techniques

### Longhand recording techniques

The recording of data in long hand is still used in general veterinary practices where computerized storage methods are not available.

**Day books** The day book is a long-established type of longhand record. It is an 'open' record of cases examined during the day; that is, it allows any data to be recorded in any form, usually as a narrative description. This type of record is of limited epidemiological value because it is bulky and does not allow either an animal's previous consultations to be located rapidly or correlation of components of different records.

to it at a lower level; these are called **children**. Components at the end of the branches (i.e., with no children) are called **leaves**. *Figure 11.4* shows a hierarchy with four levels. An example of a hierarchy with only two levels would be one with 'veterinary practice' (the root) and 'veterinary surgeons in the practice' (the children).

### The 'network' model<sup>3</sup>

Using the terminology of tree structures, if a child in a data relationship has more than one parent, then the relationship cannot be a strict hierarchic one. In these circumstances, the structure is described as a **network**. The network model therefore includes and extends the hierarchic model. An example is illustrated in *Figure 11.5*. This model allows relationships to occur between many data components and is therefore of considerable epidemiological value because it allows correlation of determinants (e.g., age and sex) with disease if the determinants and diseases are stored as components of the network.

### The 'relational' model

In the relational model, all data are represented by two-dimensional tables, which have the following properties:

- entries in the table are single-valued; neither repeating groups nor arrays are allowable;
- the entries in any one column must all be of the same kind (e.g., one column might contain animals' sexes, and another contain animals' ages);
- each column has a unique name and the order of columns is immaterial;

<sup>3</sup> The term 'network' model, in this context, should not be confused with mathematical network models of infectious disease, described in Chapter 19, or with communications networks, described later in this chapter.

**Record cards** Cards, stored in drawers or boxes, were a common means of storing clinical records, and are still used in some veterinary practices. They use a 'record' model of a database, each card often referring to one animal. They are usually stored alphabetically according to owners' names. The record-specific data are ordered chronologically on each card, providing a complete history of the patient. Cards may be blank, in which case they can be used to provide an 'open' record. Alternatively, they can be printed as a 'closed' record, that is, with a fixed number of options (see 'Questionnaires' above). These options commonly include details of specifier types such as breed, sex and date of birth. They are usually partially closed, consisting of a closed section, but with a blank area for the 'open' recording of additional details.

**Pro-formas** A pro-forma is an extension of the partially closed record. It is a mainly closed record, comprising a check list of many features (*Figure 11.6*). This can produce a very detailed record of observational and interpretative data. However, the merits of producing a comprehensive record must be weighed against the unwillingness of busy clinicians to complete them, and against the value of the data. Completion of all components of the record, especially if a 'mandatory' part of the running of a clinic or laboratory, can rapidly lead to rejection of the system (Darke, 1982). Pro-formas should always have an open section to accommodate any salient details that are not included in the closed part. The closed section can be coded and therefore readily entered into a computer.

### Punched card recording techniques

Record cards can have their items (patients) and features coded by associating these with circular or rectangular holes punched in the cards. This facilitates correlation of features and items. There are two main types of punched card: **item** and **feature** (Jolley, 1968).

**Item cards** Each item card represents an animal. The features (attributes) of the patient are associated with circular holes around the edge of the card. A hole is converted to a notch when the item concerned has the relevant feature. For example, if a dog is male, then the hole corresponding to male on the dog's item card will be changed to a notch. To search for all items with a particular feature, the cards are held in a register and a needle is passed through the appropriate hole. The cards representing items possessing the feature will have been notched in this position so that when the needle is lifted the notched cards fall from the pack. Eighty-column cards, with rectangular holes corresponding to relevant features, punched over the face of

the card, were common in the 1960s and 1970s because they were 'readable' by early computers.

**Feature cards** In a feature card system, one card is allocated to a single feature. All patients with this feature are each allocated unique reference numbers that are part of a matrix of numbers printed on the card. The corresponding numbers are centre-punched out of the card when animals possess that feature. The search is usually made by laying the cards on an illuminated screen. Eighty-column cards were also adapted for use as feature cards.

Punched card recording has been applied to veterinary data storage and retrieval in veterinary schools, government diagnostic laboratories (Hugh-Jones *et al.*, 1969) and zoos (Griner, 1980), but is now of mainly historical interest because it has been superseded by computerized recording techniques.

### Computerized recording techniques

Computers are now an efficient and commonplace – rapidly approaching universal – means of storing, analysing and retrieving data, in addition to acting as complex calculators. The invention and subsequent development of silicon microchips has decreased the size and cost of computers, thereby making them readily available to a wide range of users including general veterinary practitioners. Although the initial reason for a practitioner's acquiring a computer may be as an aid to practice management (e.g., Pinney, 1981), the machine can also manipulate clinical data very efficiently.

There are two types of computer: **digital** and **analogue**. They allow alternatives to be asked, such as this **and that, either or, neither nor**. The digital computer stores data in a discrete fashion, usually in the binary scale (i.e., 0 or 1: 'on' or 'off'). The analogue computer allows quantities to be represented as infinitely variable physical measurements, rather like a slide rule. Most modern computers are digital.

### Hardware

The physical parts of a computer are termed **hardware**. This comprises **peripheral units** and the **central processing unit** (CPU). The peripheral units include the **input units** and the **output units**.

Data enter through the input unit. If they are textual or numerical data, they are entered using a **keyboard**. Additionally, **scanners** may be used; these interpret ordinary printed paper in much the same way as a photocopier. A **mark sense document reader** is used to interpret marks on completed questionnaires. Pictorial information (e.g., maps) can be transferred to

ROYAL (DICK) SCHOOL OF VETERINARY STUDIES									
UNIVERSITY OF EDINBURGH							100,008		
OWNER	Mr. Surname Mrs. Miss <b>CAMPBELL, Mrs.</b>			Initials <b>H.</b>		Address <b>42, Glenayre Place</b>			
	Phone home business			clinician <b>A.B. Jones</b>		student		animals name <b>Petra</b>	
ANIMAL	species <b>Doa</b>	breed <b>Shetland Collie</b>		sex <b>F.</b>	age <b>4yrs.</b>	colour <b>Champagne/White</b>		weight <b>9kg</b>	
ATTENDANCE	date <b>1/6/77</b> hour		ADMITTANCE <input type="checkbox"/>		DISCHARGE <input type="checkbox"/>		date hour		
PRIMARY COMPLAINT	<b>Pruritus</b>								
REFERRED BY	Name			reply sent		admitting clinician			
	Address			phone No.		attending clinician			
<b>MEDICAL HISTORY</b>									
IMMUNISATION: state age, none or ? Initial: C.D. <span style="float: right;">C.V.H.</span>									
Repeats: C.D. <span style="float: right;">C.V.H.</span>									
Initial: Lep. can/ict. <span style="float: right;">Other</span>									
Repeats: Lep. can/ict.									
PREVIOUS ILLNESS, injury or surgery (specify +age, or none)									
DURATION OF ILLNESS <b>1 Month</b> Length of time owned <b>4 Years</b>									
APPETITE: anorexia variable fair good <input checked="" type="checkbox"/> excessive deprived									duration
THIRST: normal <input checked="" type="checkbox"/> decreased increased excessive									
RESPIRATION: normal <input checked="" type="checkbox"/> shallow dyspnoeic abdominal painful									
SNEEZING: Nasal discharge (nature)									Salivation (nature)
COUGH: none dry soft persistent paroxysmal									
VOMITION: none occasional frequent persistent haematemesis retching only									
Vomitus: character and when occurs									
FAECES: none normal <input checked="" type="checkbox"/> soft (not formed) fluid blood mucus other									
Defaecation: normal <input checked="" type="checkbox"/> difficult painful frequency colour									
URINATION: none normal <input checked="" type="checkbox"/> frequent difficult painful incontinent haematuria									
Volume: normal <input checked="" type="checkbox"/> decreased increased colour:									
TEMPERAMENT: normal listless depressed cantankerous restless excitable <input checked="" type="checkbox"/> neurotic									
NERVOUS: normal <input checked="" type="checkbox"/> excitement hysteria convulsions chorea nystagmus ataxia paraplegia									
Paralysis (define)									
SKIN: normal inflamed pruritus <input checked="" type="checkbox"/> loss of hair alopecia pigmentation hyperkeratosis Licking rubbing									
Biting (site)									Ectoparasites:
Wounds (site)									
Tumour (site)									Other lesions:
MUSCULO-SKELETAL: normal <input checked="" type="checkbox"/> Lameness (limb)									Injuries (site):
Swellings (site):									Deformities (site)
SEXUAL: Fertility: proven apparently infertile unknown									
Libido: normal none excessive unknown									
OESTRUS: age of onset last oestrus normal abnormal (define)									
intervals false preg. Last litter No. of litters									
Any discharge (define)									
EYES: normal <input checked="" type="checkbox"/> discharge (specify)									Blindness Other lesions
EARS: normal <input checked="" type="checkbox"/> rubbing ear head shaking smell discharge other									
DIET: Daily amount Meat (specify)									Fish
Carbohydrate									Vegetables Other
OTHER RELEVANT INFORMATION: <b>Synthetic fibre bedding</b>									
<b>MEDICAL HISTORY</b>									

Fig. 11.6 An example of a clinical case record pro-forma. (From Thrusfield, 1983a.)

a computer using **digitizers** and **graphics tablets**, which convert the images to a binary form. Commonly, a **mouse** can also be used to input pictorial information.

Data leave the computer through the output unit. This may be a **video display unit** (a cathode ray tube

or, increasingly, flat-screen technology), **graph plotter**, or **printer**.

The CPU includes:

- a **storage (memory) unit**, which records the instructions (program) and data;

- the **arithmetic unit**, which performs operations (additions, multiplications, comparisons) on data that the program selects from the storage unit;
- the **control unit**, which examines the storage unit's instructions sequentially and interprets them.

The capacity of a computer's databank depends on the size of the memory unit, which gives immediate access to data, and the size of any **auxiliary storage units**, which store data that can be fed into the main memory bank.

**Handling capacity** A computer's storage and handling capacity are measured in **bits** and **bytes**. A bit holds either of the basic binary digits, 0 or 1. Bits are formed into bytes. Contiguous bytes are grouped together to form **words** (normally 2 or 4 bytes, depending on the particular computer). A word can be used to store a simple integer or a real number (two words for the latter in the case of a 2-byte word). Complex numbers thus will require either four 2-byte words or two 4-byte words. For the purposes of storing data in auxiliary stores and transferring data between auxiliary storage and the CPU's memory unit, words are formed into **blocks**. The size of a block varies from one computer system to another. In a small computer, typically, there are in the order of 500 bytes (i.e., 250 2-byte words) in one block. Two such blocks therefore constitute 1 kilobyte, abbreviated to 1 Kb. There are 1000 Kb in 1 Megabyte (Mb), and 1000 Mb in 1 Gigabyte (Gb).

**Auxiliary storage** There are several types of auxiliary storage. Some common ones are magnetic tape, fixed or removable hard magnetic discs, 3½-inch 'floppy' magnetic discs, laser discs, small memory cards and memory sticks. (Early methods involved punched paper tape and cards, magnetic drums, and 5¼-inch floppy discs, but these are now obsolescent.)

The rapid advances in storage technology are continually increasing storage capacity. For example, at the time of writing, 140 Gb hard disks are common in computers, external hard disks approach 500 Gb, and 4 Gb memory sticks are available, with floppy disks (with a capacity of only 2 Mb) likely soon to be obsolescent. Tapes are currently usually used only for 'archiving' and producing secure backup copies of data.

Data stored in auxiliary storage are permanent (i.e., persist after the computer is switched off), in contrast to data stored in the memory unit, which are 'volatile' (i.e., are lost when the computer is not powered).

### Types of computer

There are currently three main types of computer. Their classification originally was based on their

physical size, although, with increasing miniaturization, this is no longer a valid criterion; the distinction now relates to the number of users who can access the computer simultaneously.

1. The **mainframe** computer has one or more large capacity CPUs and an auxiliary store. It can be used simultaneously by many people, often over 100, and usually can run many programs simultaneously. The CPU is usually distant from the many input and output units to which it is connected by electrical or fibre-optic cables. Mainframes use hard discs and magnetic tapes as auxiliary stores.
2. The **minicomputer** is similar to the mainframe, but usually supports fewer users simultaneously. Auxiliary storage is similar to that of the mainframe.
3. The **microcomputer** is a self-contained unit, with CPU and input and output units (usually a keyboard and video display unit, respectively) located together (*Figure 11.7*). The microcomputer is now widely used in veterinary medicine, including general practice, because of its relatively low cost and increasing power. Its capacity is sometimes described in terms of **RAM** (Random Access Memory) which corresponds to the immediate access memory of the mainframe, into which data can be put, and from which they can be extracted. Additionally, it has **ROM** (Read-only Memory), which contains fixed information (e.g., the sequence of instructions which have to be carried out when the microcomputer is switched on). Floppy discs, hard discs, CDs, memory cards and memory sticks are used for auxiliary storage. A **modem** (modulator–demodulator) device converts the computer's digital data to analogue signals for transmission to other linked computers down

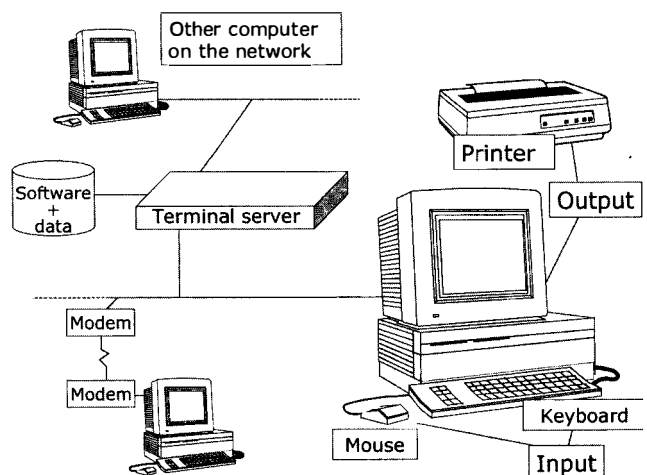

**Fig. 11.7** The components and 'environment' of a modern microcomputer.

telephone lines, either on 'voicebands' typically used for sound, or on 'broadband' with high-speed transmission via telephone lines, cable networks, or satellites.

### Software

A computer cannot learn; it lacks intelligence. Therefore it must be supplied with a complete set of unambiguous instructions that cause it to perform more or less intelligently. The set of instructions is called a **program**. Programs constitute a computer's **software** (cf. hardware). Problems must be broken down into a form with which the computer will be able to deal, usually by producing a step-by-step sequence of unambiguous rules for the computer to follow. The complete set of rules for solving a problem is called an **algorithm**. This is the basis of a computer program.

**Languages** Programs have to be written in a machine-readable **language**. The most fundamental language, similar to the binary coding, is called **machine code**. In order to avoid the awkwardness of humans reading and writing binary coding, most computers use a fundamental language system similar to the machine codes, but representing the binary notation by mnemonics or acronyms, and numerals in decimal notation, so that the instructions are understood more readily. This type of language is **low level**; a common example is Assembler.

However, to allow programs to be written more quickly, languages with a more intelligible and powerful syntax have been devised. These are called **high level** languages. Some of them accept ordinary sentences. These languages must be translated into the machine code, and so a translation program, called either an Interpreter or a Compiler, must be used. Interpreters translate the program line by line as it is executed and are therefore slow to run; translation is performed each time that the program is run. Compilers translate the whole program once, and the machine code is kept to run rapidly whenever required.

There are several types of high-level language, many of which are designed for use in particular applications. These include FORTRAN 90, which is used by scientists and mathematicians; Visual Basic, which is used on many home computers; HTML, a language for marking-up data to be displayed by an Internet browser (see below: 'The Internet'); and C and Java, which are multi-purpose languages.

**Operating systems** It is necessary to communicate with the computer via a resident program, called an **operating system**, which does 'house-keeping' jobs such as remembering the location of data and arranging for programs to be loaded and run, with access

to appropriate input and output units. The operating system comprises:

- a **user interface** which allows the user to 'converse' with the computer either by typing simple **commands** or using a mouse;
- a file system for recording bodies of information (files) on storage devices, and naming them;
- **language systems** using some of the languages described above.

A current common operating system for microcomputers is Microsoft™ *Windows XP*. Others, including UNIX and VMS, are used on mainframe computers, minicomputers and some microcomputers.

**Applications software** Applications software carries out tasks for the user (in contrast to the programs which comprise the operating system and which direct the working of the computer), and many ready-written programs, designed for specific tasks, are now available. These are software **packages**, which are aimed at the ordinary user with little or no knowledge of computer languages. Geographical information systems (see Chapter 4), word-processing packages, network and relational database management systems (DBMSs), graphics packages, expert systems (see Chapter 2) and statistical packages are examples. Some modern packages combine different tasks (e.g., statistical, word-processing and graphics packages), providing the user with comprehensive data-analysis and presentation facilities. Some packages are also designed so that data can be easily 'exported' from them and 'imported' to other packages. Packages may also be tailored to specific groups of users (e.g., the veterinary databases and information systems outlined at the end of this chapter).

Appendix III lists some useful packages for data storage and analysis in epidemiological studies.

## Data management

Stored data need to be managed. This includes efficient means of querying databases, and sharing information. These tasks have been subject to rapid development over the last three decades, paralleling the evolution of computer technology.

### Changing approaches to computing

Since the 1950s, when computers were initially developed, the way in which data are stored and handled inside a computer, and the ways by which data can be accessed, have changed.



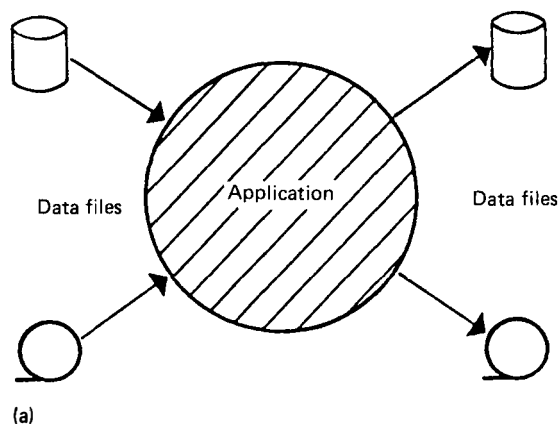

(a)

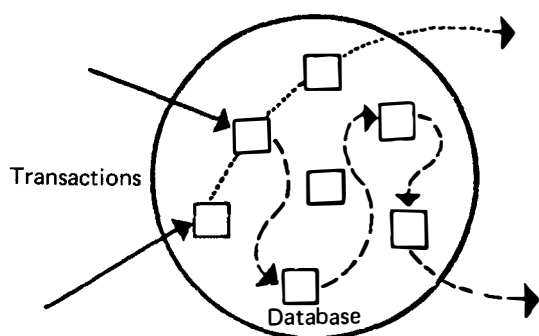

(b)

**Fig. 11.8** Approaches to data storage and manipulation: (a) the 'systems analysis' approach; (b) the 'database' approach. (From Thrusfield, 1983a.)

### Storing and manipulating data

Initially, programs were written to perform one particular purpose (e.g. 'extract all data about Hereford cows from the database'); the programs (applications) were considered central to the system, with the data merely passing through the application in a convenient form (Figure 11.8a). This 'systems analysis' approach has several disadvantages. The main one is the rigidity of the program. If a new application (e.g., 'extract all data about Charolais cows from the database') is required, then a new program may have to be written. This means that different correlations often require new programs.

The current approach – the 'database' approach – is more flexible. The data are considered central, and the applications can constantly change (Figure 11.8b). This enables flexible querying and correlation of data. This approach is used in constructing relational computerized databases, and many of these DBMSs, usually with their own special languages for querying data (e.g., SQL), are now available on mainframes and microcomputers. Most DBMSs facilitate the design of applications as well as controlling the storage

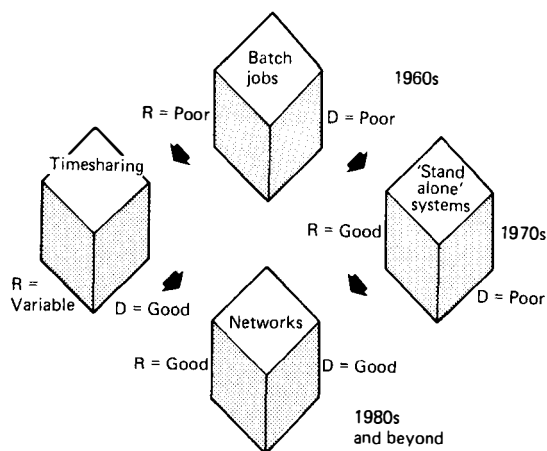

**Fig. 11.9** Changing approaches to computerized data access. D = resource and data sharing; R = responsiveness. (From Thrusfield, 1983b.)

and access of data. Additionally, standardization of database languages and software for linking computers allows data stored on a mainframe or minicomputer to be easily accessed locally by microcomputers.

### Accessing computerized data

Figure 11.9 illustrates how the approach to computing has developed, and how it affects access to data. In the 1960s, work was run on mainframe computers, usually by inputting work on paper tapes or punched cards to be run overnight as batch jobs. Response was poor (i.e., the process was slow) and it was very difficult for users to share their data and resources.

In the 1970s, a division took place. Mainframe users began to share time on computers and it was possible to share data and resources, although response varied according to the number of users and the tasks being performed at any one time. Separate 'stand-alone' microcomputer systems developed with good response, but data and resources could not be shared because the systems were not linked.

The 1980s saw developments in communications technology that allowed data to be accessed rapidly from several places. Initially, computers could be linked using acoustic signals sent via conventional telephone handsets. However, the rate of data transfer was slow. Now, using communications 'networks', direct cable, fibre-optic and satellite links between computers (mainframes and microcomputers) are available, operating at up to 100 million characters per second. Thus, in Japan, emergency reports of outbreaks of infectious diseases, and routine reports, are sent electronically from local animal health centres to a central, national database (Tanaka, 1992), and many of the veterinary information systems described later in this chapter share data over such networks.

Network connection requires an extra piece of hardware called a **network card**. The computer also requires some extra network software in order for it to communicate on the network. Today, many systems include this software as part of the operating system. Most large organizations provide networking software via a licence from a software supplier. However, it is possible to use 'public domain' software. While this has the advantage of being free, it may not be fully supported in the way that commercial software is, and no documentation may be available.

## The Internet

The sharing of data and resources is most clearly demonstrated in the Internet, which traces its origins to the late 1950s when the US Department of Defense formed the Advanced Research Projects Agency (ARPA) to expand science and technology. This resulted in the development, in the late 1960s, of the ARPANET, linking several universities in the US. The first international link (to University College, London) in 1973 marked the development of an international connection of networked computers, following the computing trends of the time (*Figure 11.9*). This became the Internet, which had replaced the ARPANET by the early 1990s. The Internet is now made up of many thousands of national, regional, governmental, academic and commercial networks, which link together to form a global network. It used to be primarily an educational and research network, but it is now becoming much more commercially orientated.

### Connecting to the Internet

Connection to the Internet may be achieved in two ways: either 'permanently' or via 'dial up'. Large organisations typically have a permanent connection to the Internet, which is available all the time. For those requiring domestic access to the Internet, this can be achieved using a modem and either a dial-up (temporary) or broadband (permanent) connection to commercial **Internet Service Providers (ISPs)**, many of which are now free.

### Data transfer across the Internet

All connected networks use the **Internet Protocol**, which is a set of rules that allow the computers that are connected to a network to communicate with one other, whatever their operating systems may be. Any network can join the Internet as long as it uses the Internet Protocol. No one controls the Internet; it works because these smaller networks co-operate with one another.

There are many different ways of transferring information across the Internet. **File Transfer Protocol (FTP)** and **Telnet** are basic tools used for file transfer and remote login, respectively. However, the **World Wide Web (WWW)** has become the most popular Internet information retrieval tool. It is:

- **distributed:** the information that can be accessed is held on many thousands of Web servers around the world;
- **multimedia:** the Web copes well with formatted documents and graphics. It is increasingly being used to deliver animation, sound and video;
- **HyperText:** words that are highlighted in some way within a document can be selected to retrieve further information about that topic; this further information can come from anywhere on the Internet.

Any user connected to the WWW can request a copy of a document or other Web object (e.g., an image or a sound file) to be delivered to their computer. To do this, the user's computer must 'know' where to send the request, how to phrase the request, and how to present or 'render' the document on the user's computer screen. The user's software (or machine) is known as the **client**, and the computer that is being asked for the document is known as the **server**. Client software that can access the WWW and display files is termed a **browser**. Common browsers are Netscape™ and Internet Explorer™. When the user clicks on a HyperText link, the browser extracts from the link the address of the server to which it should make the request, as well as information to tell the server where it should look for the document within its filesystem. The link also contains information to tell the browser how to phrase the request in a way that the server will understand. When the server responds, the client software decides how to present the document, or any other message from the server. The server handles requests from clients worldwide by serving them copies of the original document. This means that the clients cannot make changes to the original document held on the server.

As well as providing access to WWW-based information, WWW clients can also access other Internet services such as FTP, and **electronic mail (email)**.

### Internet addresses

Internet resources are located using a standard address format, termed a **Uniform Resource Locator (URL)**. This indicates the:

- method of access;
- location of the server;
- server.

For example the URL, <http://www.edinburgh.ac.uk/index.html>, has the following components:

http	= means of access ( <i>HyperText Transfer Protocol</i> , indicating that it is a WWW server)
://	= separators of the type of service from the location part of the URL
www.edinburgh.ac.uk	= the location: the unique name of the server ( <i>.ac.uk</i> indicating an <i>academic institution</i> in the <i>UK</i> )
index.html	= the file to be accessed ( <i>html</i> is the language used to write WWW documents).

Other URLs could include *ftp* (rather than *http*), indicating FTP as the means of access.

Searching the Internet when URLs are not known is facilitated by the use of **search engines**. These are software (e.g., **GOOGLE™**) that allow searches to be conducted over the entire Internet by typing in key words (e.g., the key words 'veterinary epidemiology' will locate many servers containing information on veterinary epidemiology).

Further information about the WWW may be found at the URL: <http://www.w3.org/>.

### Veterinary epidemiology and the Internet

The veterinary profession has benefited generally from the Internet; for example, in the development of computer-based learning (Short, 2002), and the general sharing of professional information that the Internet facilitates. Additionally and specifically, veterinary epidemiologists can now share data, statistical software, and the results of research and disease surveillance (e.g., the *Office International des Epizooties* reporting system) (Table 11.2). The URLs of some Internet resources of value to veterinary epidemiology are listed in Appendix IV.

### Veterinary recording schemes

#### Scales of recording

The types of veterinary recording scheme were classified by Hugh-Jones (1975):

- microscale schemes (Figure 11.10a) concerned with internal disease problems in separated populations such as those on farms and research institutes;
- mesoscale schemes (Figure 11.10b) involved with more widely distributed disease problems, for

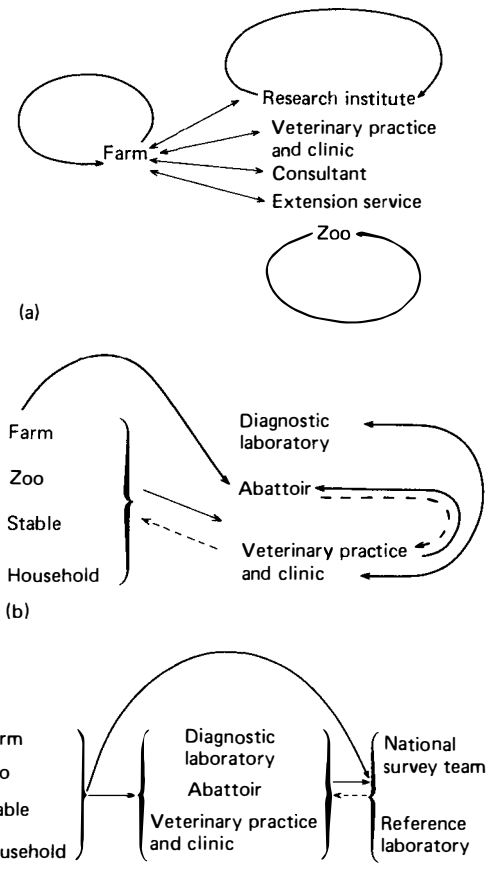

**Fig. 11.10** Veterinary data recording schemes defined according to flow of data: (a) microscale schemes; (b) mesoscale schemes; (c) macroscale schemes. Solid arrows indicate main paths of data flow. Broken arrows indicate paths of limited or no data flow. (From Thrusfield, 1983b, after Hugh-Jones, 1975.)

example, data collection at abattoirs, diagnostic laboratories and clinics;

- macroscale schemes (Figure 11.10c) designed to collect data with the purpose of gaining an international or national view of disease.

#### Microscale schemes

In the microscale scheme, information is transferred from the farm to the practice or consulting organization where it is analysed and the results are necessarily fed back to the farm to effect health improvement. With an 'on-farm' system, data may be manipulated and analysed without leaving the farm's confines. Herd health and productivity schemes are typically microscale. Essentially, they record individual and herd performance and productivity and sometimes disease occurrence, and relate productivity to disease in an attempt to improve the former. These will be considered in greater detail in Chapter 21.

### Mesoscale schemes

In the mesoscale scheme, data are transmitted from their source to the organizations responsible for analysis. The data are usually of more direct value to the analysing institution than to their source. Therefore, feedback of data is a less important component of the system (although still desirable). Small-animal practice records are an example of this type of recording system.

### Macroscale schemes

Macroscale schemes are designed to gain a global, globally regional, national, or nationally regional picture, and therefore are not designed primarily to help specific animal units. There is thus little flow of data back to their origin. National and international monitoring and surveillance programmes are typically macroscale.

Several contemporary recording projects now have various combinations of macroscale, mesoscale and microscale elements. For example, the Canadian *Animal Productivity and Health Information Network*, APHIN (see Table 11.2, and further details below), includes on-farm microcomputers that record herd health and productivity (microscale), but these are also linked to a central database, which can provide a regional view of animal health (macroscale). This triple classification, however, still provides a useful focus on the broad objectives, flow of data and general geographical scope of a recording scheme.

### Veterinary information systems

Databases themselves only have limited value. Maximum benefit from the data is obtained only when they are converted to **information**. Data and information are not synonymous, and, when they are treated as such, confusingly similar terms like 'information processing' and 'data processing' arise. **Information** comprises data that have been processed and organized for some purpose so that someone can extract **meaning** from them. A **system** is generally defined as an entity comprising at least two related components (Ackoff, 1971). A precise definition of an **information system** is difficult to achieve (Avgerou and Cornford, 1993) but, in a practical veterinary context, may be considered as collections of disease-related data that are integrated to satisfy the informational requirements of its users (e.g., farmers, veterinary practitioners, epidemiologists and administrators). The borderline between a simple database and an information system is also indistinct because stored data, even before they are processed, can have value as information. However,

an important characteristic of an information system is its ability to deal with large, complex issues (e.g., the national control of epidemics). *Figure 11.11* is a general outline of a national veterinary information system, in which data flow from their source on farms to the scientific (i.e., veterinary) community and to other salient sectors of society. During the transmission of data down the information system's 'conveyor belt', data are 'distilled' to generate useful information.

An extension of the information system is the **decision support system** (Sprague and Carlson, 1982). Its two key components are:

1. a focus on decision makers – at both policy and implementation levels – rather than on the system itself;
2. 'seamless integration' of all components of the system so that all features can be accessed via a single user interface without regard to which component of the system is providing the answers; this represents a logical development from the simple database where data analysis may be handled quite separately from data entry and storage – often not even on the same computer.

Decision support systems have these characteristics (Morris *et al.*, 1993):

- they tend to be directed at relatively unstructured, poorly specified problems;
- they combine models and analytical techniques with traditional data storage and retrieval functions;
- they focus on features that make them easy to use by people whose computer 'literacy' is low;
- they emphasize flexibility and adaptability to accommodate changing circumstances (e.g., changes in approaches to decision making) and therefore can be valuable parts of a national animal health information system.

Decision support systems do not, themselves, produce unequivocal answers, but offer guidance to policy-makers, who may need to enlist other views. They also provide a useful audit of policies.

### Data collection

Data may be collected either **passively** or **actively** (see Chapter 10), and the passively collected data are prone to selection bias (see Chapters 9 and 10). However, the use of passively collected data involves little extra cost. Actively collected data, in contrast, are gathered specifically to fulfil the requirements of the information system, are not available from pre-existing sets of data, and therefore have a cost attached to them. Therefore, the technical and economic feasibility of active collection needs to be considered.

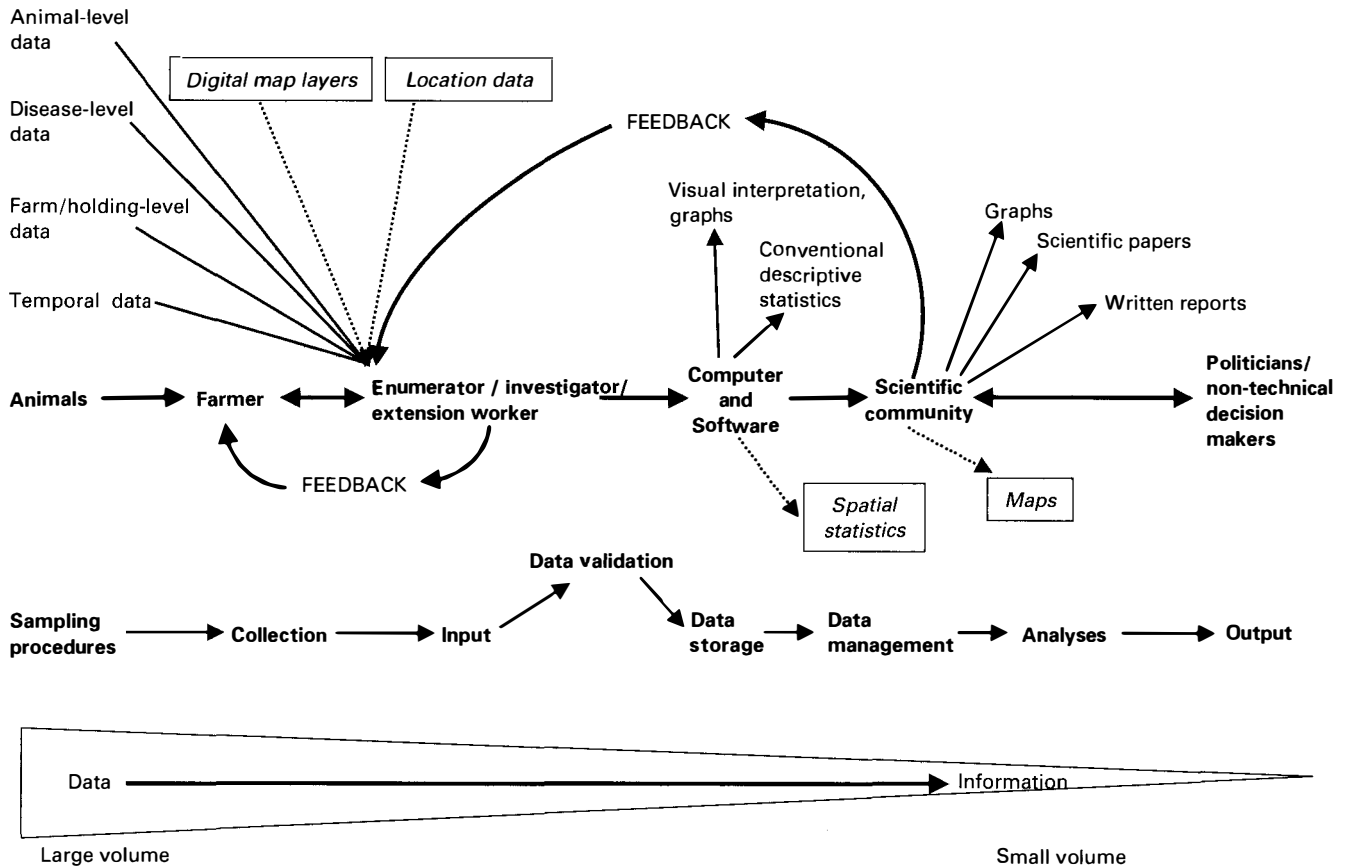

Fig. 11.11 The structure of a national veterinary information system. Input from geographical information systems (see Chapter 4) is indicated by dotted lines and italicized text in boxes. (From an idea by Andrew Paterson, Department for Environment, Food and Rural Affairs, London.)

Many epidemiological studies require details of the population at risk, as well as diseased animals (e.g., for calculation of morbidity and mortality values). Thus, census data may also be an important part of an information system. These data are collected routinely in many countries and therefore are passively available for use in information systems. However, the accuracy of these data needs to be assessed before they are used.

### The value of collected data

The value of collected data needs to be judged in terms of the objectives of the information system. Some pitfalls associated with inappropriate data collection are summarized by **Finagle's 'Laws'** (Opit, 1987):

- the information one **has** is not what one **wants**;
- the information one **wants** is not what one **needs**;
- the information one **needs** is not what one **can get**;
- the information one **can get** costs more than one **wants to pay**.

Thus, the objectives of an information system should be clearly defined **before** the system is designed, and

**before** active data collection begins. This necessitates discussion with **all** potential users of the system **before** it is designed.

### Objectives

There are several objectives of a comprehensive information system:

- surveillance of endemic diseases;
- fulfilling international reporting needs;
- monitoring productivity;
- identifying new syndromes;
- supporting and monitoring the technical efficacy of control programmes;
- managing laboratory data;
- providing information for the economic assessment of disease and its control.

These objectives can be fulfilled at three levels: **farm**, **national** and **international**, and the information required at each level therefore needs to be identified. The **flow** of information in the information system can then be defined.

**Farm level** This includes individual producers, producer groups (e.g., farm co-operatives), and product processors. Individual producers generally need records of diseases on their farms, and details of productivity (e.g., milk production and reproductive efficiency). Producer groups require similar information on productivity, although it may be prudent to keep details of an individual farm's disease problems confidential. Product processors need details of hazards such as zoonotic diseases and residues (e.g., for milk processors, details of milk-borne infections and antibiotic contamination).

**National level** At this level, several organizations have different information requirements. Departments of agriculture utilize aggregated data on farm productivity. Veterinary services need a national view of animal disease, including the monitoring of zoonoses, and a log of veterinary activity. The agricultural industry needs details of product sales. National banks may require information on productivity potential before awarding loans; similar information also may be needed by insurance companies.

**International level** Various regional and global agencies utilize information on animal health and productivity. Examples of the former are the European Union, the *Pan-American Health Organization (PAHO)*, the *South Asian Association for Regional Cooperation (SAARC)* and the *Animal Production and Health Commission for Asia (APHCA)*. The latter include the *World Health Organization (WHO)* and the *Food and Agriculture Organization (FAO)* of the United Nations. The Internet URLs of several of these are listed in Appendix IV.

The United Nations also has several regional and global agencies which are particularly concerned with funding agricultural projects in **developing countries**, and for which information on animal health and productivity therefore is valuable. These include the *World Bank*, the *International Fund for Agricultural Development (IFAD)*, the *Economic Commission for Latin America and the Caribbean (ECLAC)*, the *United Nations Development Programme (UNDP)*, and the *Inter-American Development Bank (IDB)*.

### Information system implementation

Implementation of an information system is undertaken in several stages:

- definition of the data requirements and flow of information;
- identification of areas where passive and active data collection are appropriate;
- identification of areas where computerization is

desirable, and of standards for exchange of data between other integrated systems;

- construction of a work plan, including any incremental steps in computerization (e.g., national centres first, followed by local centres) and in fulfilling information requirements (e.g., international needs may need to be supplied before national or local needs);
- training;
- assessment of progress;
- modification of the system, if necessary.

Each stage must be considered in the context of the availability of data generated by existing data-collection procedures, and the circumstances of the country or region in which the system is to be implemented. For example, a developing country may have greater restrictions on manpower and financial and technical resources than a developed one.

Attention needs to be given to the selection of appropriate hardware and software. Servicing and maintenance of the former should be available locally, and it should have sufficient RAM and auxiliary storage to run the software and store the amount of data that is anticipated. Additionally, in developing countries, an uninterrupted power supply unit (UPS) is desirable to prevent damage to hardware and loss of data during power fluctuations and interruptions.

Various types of software may be required, and should be well supported by suppliers. A DBMS is suitable for storing, handling, and extracting data, and for generating reports. Statistical packages also may be required for the analysis of data (Appendix III); and a word-processing package is invaluable for producing reports and other communications. A geographical information system (see Chapter 4) may also be useful. The portability of files between packages is an important consideration, and so packages should not be selected in isolation but in relation to one another. Ideally, all components should be 'seamlessly integrated'. Finally, data should be regularly 'backed-up' (i.e., extra copies stored on auxiliary storage or servers).

### Some examples of veterinary databases and information systems

Computerized veterinary information systems have a history dating back to the mid 1960s (Tjalma *et al.*, 1964; Hutton and Seaton, 1966; Griner and Hutton, 1968; Hutton, 1969). *Table 11.2* lists some examples of veterinary databases and information systems. A brief outline of some of them will indicate their scope and the techniques employed in updating and using them.

**Table 11.2** Some veterinary databases and information systems, past and present.

<i>Macroscale</i>	<i>Mesoscale</i>	<i>Microscale</i> *†
ANADIS (Roe, 1980; Andrews, 1988; Cannon, 1993)	Australian slaughter check scheme (Pointon and Hueston, 1990)	APHIN [cattle, pigs] (Dohoo, 1988, 1992)
APHIN (Dohoo, 1988, 1992)	Danish pig health and production surveillance system (Christensen <i>et al.</i> , 1994)	Australian slaughter check scheme [pigs] (Pointon and Hueston, 1990)
Australian national animal health information system (Garner and Nunn, 1995)	Danish swine slaughter inspection bank (Willeberg, 1979)	Bristol sheep health and productivity scheme [sheep] (Morgan and Tuppen, 1988)
Australian State animal disease information systems (Andrews, 1988)	Edinburgh SAPTU clinical record summary system (Stone and Thrusfield, 1989)	Checkmate [dairy cattle] (Booth and Warren, 1984)
BENCHMARK (Martin <i>et al.</i> , 1990)	FAHRMX (Bartlett <i>et al.</i> , 1982, 1985, 1986; FAHRMX, 1984)	CHESS [pigs] (Huime and Dijkhuizen, 1994)
Californian turkey flock monitoring system (Hird and Christiansen, 1991)	Florida teaching hospital data retrieval system (Burrige and McCarthy, 1979)	COSREEL [cattle, sheep, pigs] (Russell and Rowlands, 1983)
Danish pig health and production surveillance system (Christensen <i>et al.</i> , 1994)	Liverpool clinical recording and herd health system (Williams and Ward, 1989b)	DairyCHAMP [dairy cattle] (Udomprasert and Williamson, 1990)
Danish pig health scheme (Willeberg <i>et al.</i> , 1984; Mousing, 1988; Willeberg, 1992)	Minnesota disease recording system (Diesch, 1979)	Danish pig efficiency control system [pigs] (Herløv and Vedel, 1992)
Danish swine slaughter inspection data bank (Willeberg, 1979; Willeberg <i>et al.</i> , 1984)	Parasitology diagnostic data program (Slocombe, 1975)	Danish pig health and production surveillance system [pigs] (Christensen <i>et al.</i> , 1994)
Japanese disease reporting system (Tanaka, 1992)	Queensland veterinary diagnostic data recording system (Elder, 1976)	DAISY [dairy cattle] (Pharo, 1983; Esslemont <i>et al.</i> , 1991; Esslemont, 1993b)
Management and disease information retrieval system for broiler chickens in Northern Ireland (McIlroy <i>et al.</i> , 1988; Goodall <i>et al.</i> , 1997)	Slovakian Veterinary Service management system (Haladej and Hurcik, 1988)	DairyCHAMP [dairy cattle] (Marsh <i>et al.</i> , 1993)
Management and disease information retrieval system for farmed Atlantic salmon in Northern Ireland (Menzies <i>et al.</i> , 1992)	Veterinary Recording of Zoo Animals (Roth <i>et al.</i> , 1973)	Edinburgh DHHPS [dairy cattle] (Kelly and Whitaker, 2001)
NAHIS (Morley, 1988)	VIDA II (Hall <i>et al.</i> , 1980)	FAHRMX [dairy cattle] (Bartlett <i>et al.</i> , 1982, 1985, 1986; FAHRMX, 1984)
NAHMS (King, 1985; Glosser, 1988; Curtis and Farrar, 1990; Bush and Gardner, 1995; Wineland and Dargatz, 1998)	VMDB/VMDP (Priester, 1975; Warble, 1994; VMDB, 2004)	InterHerd [dairy and beef cattle, and mixed enterprises] (InterAGRI, 2004)
Namibian veterinary information system (Biggs and Hare, 1994; Hare and Biggs, 1996)		Liverpool clinical recording and herd health system [dairy cattle] (Williams and Ward, 1989b)
New South Wales animal disease information system (Rolfe, 1986)		Ontario dairy monitoring and analysis program [dairy cattle] (Kelton <i>et al.</i> , 1992)
New Zealand national livestock database (Ryan and Yates, 1994)		PigCHAMP [pigs] (Stein, 1988; PigCHAMP, 2004a)
New Zealand laboratory management and disease surveillance information system (Christiansen, 1980)		SIRO [dairy cattle] (Goodall <i>et al.</i> , 1984)
Nigerian animal health information system (Ogundipe <i>et al.</i> , 1989)		VAMP [dairy cattle] (Noordhuizen and Buurman, 1984)
Northern Ireland Animal and Public Health Information System (Houston, 2001)		VIRUS [dairy cattle] (Martin <i>et al.</i> , 1982a)
OIE international disease reporting system (Blajan and Chillaud, 1991)		
Ontario dairy monitoring and analysis program (Kelton <i>et al.</i> , 1992)		
Slovakian Veterinary Service management system (Haladej and Hurcik, 1988)		
Swiss national animal health information system (Riggenbach, 1988)		
Taiwanese disease reporting system (Sung, 1992)		

\* These systems are health and productivity schemes. They may also function to varying degrees as mesoscale and macroscale systems.

† The type of livestock recorded in each system is in square brackets.

### The Office International des Epizooties international disease reporting system

The Paris-based *Office International des Epizooties (OIE)* is an international organization concerned with the global control of animal disease. It was founded in Paris in 1924 following an outbreak of rinderpest in Belgium in 1920, and has a macroscale reporting system that records data on the major infectious epidemic diseases of animals throughout the world.

The objectives of OIE are:

- to alert countries threatened by an epidemic;
- to strengthen international co-operation on animal disease control;
- to facilitate international trade.

It is therefore necessary to know the natural history of diseases relevant to trade, the risk of transmission, and the biological and economic consequences of introduction of a pathogen. Two categories of disease currently<sup>4</sup> are defined (OIE, 1987):

1. 'List A': communicable diseases which have the potential for very serious and rapid spread, irrespective of national borders, which are of serious socio-economic or public health consequence, and which are of major importance in the international trade of animals and animal products (e.g., African horse sickness, contagious bovine pleuropneumonia, foot-and-mouth disease, highly pathogenic avian influenza, Newcastle disease, rinderpest, sheep pox and swine vesicular disease);
2. 'List B': communicable diseases which are considered to be of socio-economic and/or public health importance within countries and which are significant in the international trade of animals and animal products (e.g., anthrax, contagious equine metritis, fowl pox, glanders, John's disease (paratuberculosis), leptospirosis and rabies).

Collaborating countries are required to submit 'alert' messages for outbreaks of List A diseases and 'exceptionally important' List B and unlisted diseases. These messages comprise:

- an initial report of the event (on form SR1);
- additional information on the event and control measures (on form SR2).

Additionally, a standard monthly report (form SR3) and an annual report are requested. The *Office* issues

an *International Animal Health Code* in an attempt to standardize reporting procedures (OIE, 1992). It also defines minimum health guarantees required of trading partners to avoid the risk of spreading animal disease.

### NAHMS

NAHMS (*National Animal Health Monitoring System*) is a macroscale system, designed to measure the incidence, prevalence and cost of health-related events in livestock in the US, and to identify determinants of disease in modern production systems. It has evolved in response to calls in the US for a national surveillance system for endemic conditions of livestock, which began in the 1920s and continued during the 1960s and 1970s (Poppensiek *et al.*, 1966; Hutton and Halvorson, 1974).

An important requirement is that farm enterprises are randomly selected so that representative, unbiased results are obtained (see Chapter 13). Following early random selection schemes (e.g., the Minnesota disease recording system: *Table 11.2*), a pilot project involving pig producers, called NADS (*National Animal Disease Surveillance System*), began in the States of Ohio and Tennessee in 1983, and NAHMS is now being extended over the country to cover the full range of livestock species. Data relating to disease occurrence, demography, and costs (e.g., of preventive measures) are collected from the selected farms. Samples of blood, faeces, feed and water are collected from some participating farms to validate clinical diagnoses and producers' observations. Following local data collection and analysis, records are forwarded to a national co-ordinating centre for aggregation and regional and national analysis. Individual-producer and State summary reports are also produced.

### APHIN

APHIN (*Animal Productivity and Health Information Network*) was established in the late 1980s at the Atlantic Veterinary College, Prince Edward Island, Canada, to provide pig, beef and dairy farmers on Prince Edward Island with information to increase production efficiency. It comprises microcomputers situated on farms and in veterinary practices, the processing industry, government agricultural laboratories and the veterinary college. Microscale health and productivity packages (e.g., PigCHAMP: *Table 11.2*) record data on individual farms. Other data sources, at varying stages of incorporation into APHIN, include abattoir records, diagnostic and nutritional laboratory records, and milk quality data.

The separate microcomputers usually operate independently, providing local users with the information that they require. Additionally, relevant data are

<sup>4</sup> It is intended that Lists A and B will soon be replaced by a single list, with the main criterion for inclusion being the potential for international spread; other criteria include the capacity for significant spread within naïve populations and zoonotic potential. The aim in drawing up a single list is to be in line with the terminology of the Sanitary and Phytosanitary Agreement of the World Trade Organization, by classifying diseases as specific hazards and giving all listed diseases the same degree of importance in international trade.



transferred on floppy disks (proposed developments include electronic transmission) to a central mainframe relational database on which the data are collated, analyses conducted, and summaries produced for participating farmers.

### Danish swine slaughter inspection data bank

This database comprises post-mortem information on pigs collected at slaughter. Most Danish fattening pigs are recorded in the database and so not only does the database act as a mesoscale scheme but also it performs the function of a national macroscale monitoring scheme.

### VMDB

The VMDB (*Veterinary Medical Database*) is a collaborative mesoscale database involving most veterinary schools in North America. It is located at Purdue University's School of Veterinary Medicine, and has three subsidiaries: *Equine Eye Registration Foundation* (a registry and research database of horses unaffected by the major heritable eye diseases); *Canine Eye Registration Foundation* (a registry and research database of purebred dogs unaffected by the major heritable eye diseases); and *DNA* (a registry of Irish setters that have passed a DNA test for progressive retinal atrophy or canine leukocyte adhesion deficiency). Data were coded using *SNVDO* codes, but *SNOMED* codes (see Chapter 9) are now used (Folk *et al.*, 2002). The VMDB data sources, like many of the others that have been described (see Chapter 10), demonstrate selection bias, but the database (which dates back to 1964, and contains several million records) has provided a considerable amount of material for epidemiological investigations, including observational studies (see Chapter 15).

### VIDA II

VIDA II (*Veterinary Investigation Diagnosis Analyses*) is a mesoscale database comprising records of specimen submissions to veterinary investigation laboratories in Great Britain. These submissions are voluntary and constitute only a proportion of all post-mortem and laboratory specimens. The individual laboratories code diagnostic data, which are then submitted electronically to a central server for storage in a relational database.

### DairyCHAMP

DairyCHAMP is a microcomputerized dairy herd health and productivity scheme to assist daily animal management, herd performance monitoring, and

problem analysis. It is therefore a microscale scheme. Events related to individual cows are recorded in relation to reproductive and lactation cycles and health records (e.g., records of service, pregnancy diagnosis, and mastitis). There is also a bull record and a record of farm-related data such as type of housing, and feed and drug inventories and use. Three categories of report are generated: management aids, performance monitors (e.g., conception rate and heifer growth charts), and problem analysis reports which are used in conjunction with the performance monitors to detect problems such as excessive calving to conception intervals.

DairyCHAMP can be fully integrated with a decision support system, DairyORACLE (Marsh *et al.*, 1987). A similar degree of 'seamless integration' is also possible between other dairy herd health and productivity schemes and decision support systems (e.g., Esslemont, 1993b; Williams and Esslemont, 1993), and the pig herd health and productivity scheme, PigCHAMP; a decision support system for pig breeding enterprises, PigORACLE; an economic expert system for assessing breeding herd performance, CHERS (Computerized Herd Evaluation System for Sows: Huirne *et al.*, 1992); and an expert system for evaluating herd culling and replacement policy, PorkCHOP (Dijkhuizen *et al.*, 1986; Huirne *et al.*, 1991).

### EpiMAN

EpiMAN (Morris *et al.*, 1992, 1993; Stärk *et al.*, 1998; Sanson *et al.*, 1999) is a decision support system for the control of diseases that require national control or eradication procedures. It was developed in New Zealand, initially for the control of exotic diseases. The system is mounted on microcomputers that can be linked by communications networks, and is portable so that it can be moved easily to required locations. For example, it was used in the UK during the 2001 foot-and-mouth disease epidemic (Morris *et al.*, 2001).

The main components of EpiMAN, applied to foot-and-mouth disease control, are illustrated in Figure 11.12. Spatial and textual data relating to infected areas are stored in a relational DBMS. The spatial data are handled by a geographical information system. There is provision to store information on all farms in a country in which the system is used (the 'Agribase': Sanson and Pearson, 1997). A Monte Carlo model (see Chapter 19) simulates spread of infection on individual farms; airborne transmission is modelled using the Gaussian plume dispersion model (see Chapter 6); and a third model predicts spread between farms, using parameters such as the size of infected areas, contact slaughter and 'ring' vaccination (vaccinating animals in a ring around an infected area).

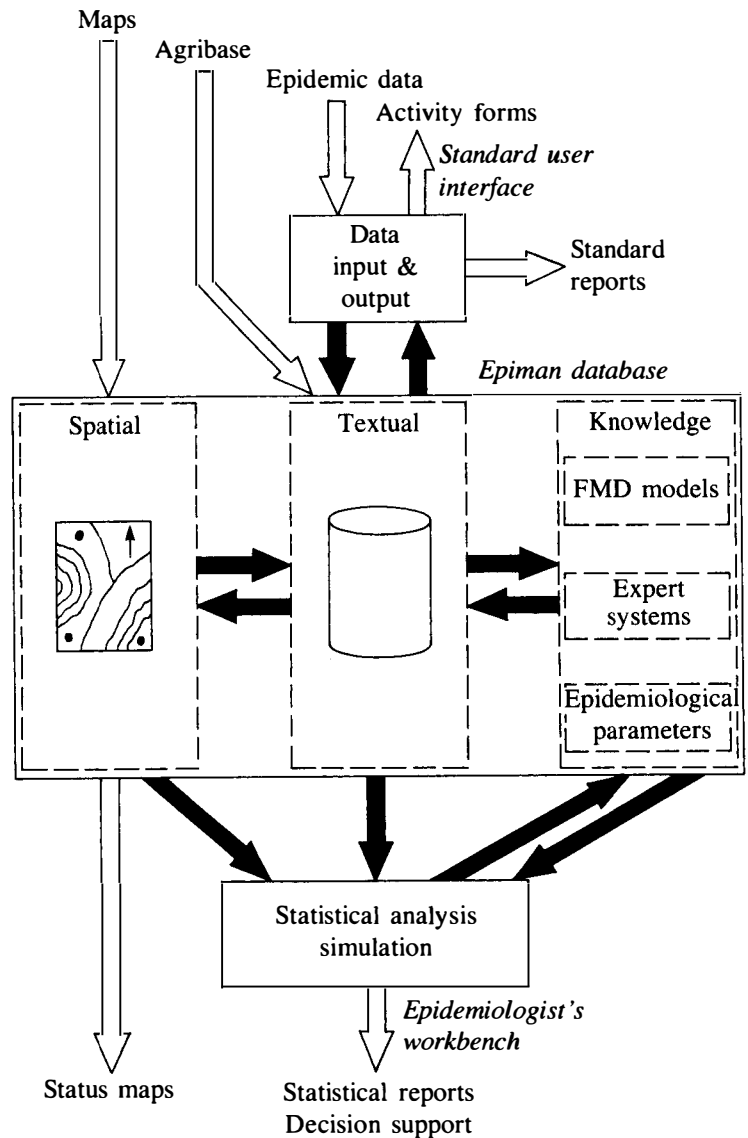

**Fig. 11.12** The structure of the EpiMAN decision support system. (Redrawn from Morris *et al.*, 1993.)

Finally, expert systems assign priorities to tracing animals and people who moved on to or off infected premises prior to diagnosis of the disease, and rate the risk of infection on unaffected farms so that daily patrol schedules can be planned.

**DCS**

Disease Control System (DCS) (Figure 11.13) is a Web-accessed database, which was developed to assist during an outbreak of a notifiable disease (i.e., a disease for which there is a legal requirement for reporting) in Great Britain; notably, the foot-and-mouth disease epidemic in 2001. It is managed by the UK government's Department for Environment Food and Rural Affairs (DEFRA), and records data on premises, including disease status, movement restrictions and visits conducted through all stages of the epidemic.

In addition, details of blood or tissue samples taken, slaughter and disposal, cleansing of premises and equipment, and the progress of restocking are recorded. It is linked to both Vetnet<sup>5</sup> and the DEFRA national geographical information system (GIS), and draws data from existing systems, including databases of agricultural holdings and census records.

Access to the system is provided through a Web browser, with the Web Site located on an existing internal network (*Intranet*), enabling use by large numbers of staff at the Disease Emergency Control Centres that were established to control the epidemic, without

<sup>5</sup> Vetnet is Great Britain's main Animal Health Information Technology system. It also includes a tracing and verification system (VTVS), which was developed to provide a generic animal tracing system to give users the ability to trace individual cattle (commonly relating to tuberculosis) or whole/part herds/flocks/batches of other animals (sheep, goats, pigs).

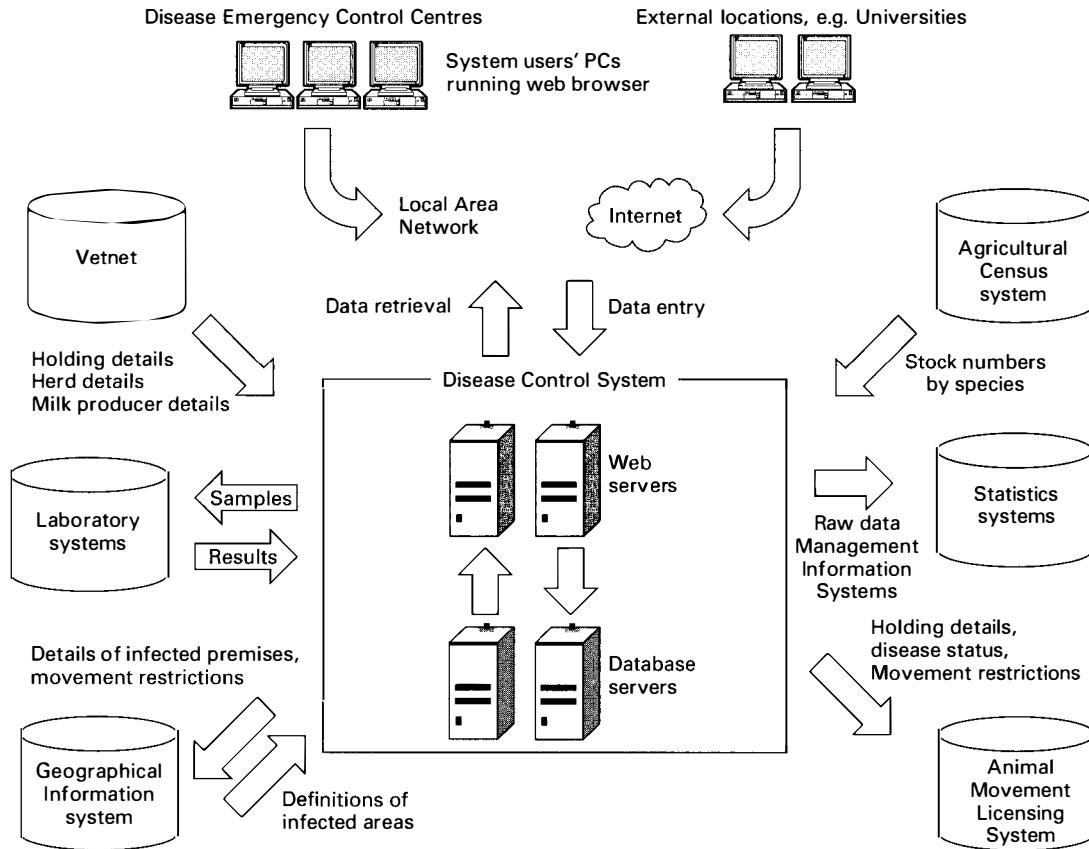

**Fig. 11.13** The structure of the Disease Control System information system. (Modified from a figure supplied by R. Muggeridge, Department for Environment, Food and Rural Affairs, London.)

having to install and administer specialized software on hundreds of microcomputers. Multiple Web and database servers are used to guard against failure, and to spread the processing load to avoid performance bottlenecks.

Outbreak-specific data, such as details of suspected and confirmed cases, records of documents served on premises, visits made, cases of slaughter and carcass disposal, are recorded in the DCS database. Data entry screens and a wide variety of predefined reports and queries allow outbreak data to be exported to other DEFRA systems in a variety of formats. Exchange of data between DCS and GISs enable outbreak data to be plotted, and definitions of infected and at-risk areas, which change with the spread of the disease and the progress of work to eradicate it. Exchanges between DEFRA's laboratory systems serve to update DCS with results of sample testing; and export of data to financial systems validates compensation payments.

The DCS database includes details of over 400 000 agricultural holdings and other relevant business locations. Details of over 80 000 further locations, including rented land and common grazing together with links between holdings such as common ownership of stock, are also recorded.

The use of DCS during the 2001 epidemic is a valuable example of the need to continually modify information systems in the light of experience. For example, Vetnet's tracing and verification system (VTVS) could only effectively trace cattle (all of which have an ear tag number), whereas sheep (which do not have individual ear tag numbers) could only be traced in batches and, when broken up, became progressively more difficult to trace. In addition, initially, vehicles and personnel could not be traced (exemplifying the third of Finagle's 'Laws': the information one **needs** is not what one **can get**), yet tracing is a key component of outbreak investigation and control (see Chapter 22). Moreover, at the beginning of the 2001 epidemic, both DCS and VTVS were fledgling systems, the former still being developed following its initial use during the 2000 UK swine fever epidemic. Although training in the use of DCS commenced relatively early in the epidemic, it was difficult for the full complement of staff to attend training sessions because of the massive additional workload on permanent administrative staff induced by the epidemic<sup>6</sup>. This therefore also

<sup>6</sup> Permanent staff of necessity were supplemented by temporary staff (see Figure 22.1).

emphasizes the need for adequate training and staffing before an information system can be effectively utilized.

## Further Reading

- Association for Veterinary Informatics Newsletter. <http://www.avinformatics.org>
- Atkinson, I. (1971) *Handbook for Interviewers*. Great Britain Office of Population Census and Surveys. Social Survey Division, Her Majesty's Stationery Office, London
- Bennett, A.E. and Ritchie, K. (1975) *Questionnaires in Medicine: a Guide to Their Design and Use*. Oxford University Press, London
- Blood, D.C. and Brightling, P. (1988) *Veterinary Information Management*. Baillière Tindall, London
- Boynton, P.M. (2004) Administering, analysing, and reporting your questionnaire. *British Medical Journal*, **328**, 1372–1375
- Cimino, J.J. (1998) Desiderata for controlled medical vocabularies in the twenty-first century. *Methods of Information in Medicine*, **37**, 394–403. (A review of medical terminology, with particular reference to computerized data recording and retrieval)
- Clements, A.C.A., Pfeiffer, D.U., Otte, M.J., Morteo, K. and Chen, L. (2002) A global livestock production and health atlas (GLiPHA) for interactive presentation, integration and analysis of livestock data. *Preventive Veterinary Medicine*, **56**, 19–32
- Date, C.J. (2000) *An Introduction to Database Systems*, 7th edn. Addison-Wesley Publishing, Reading, Massachusetts
- Dillman, D.A. (1978) *Mail and Telephone Surveys: the Total Design Method*. John Wiley, New York
- Dohoo, I.R. (1994) Specific issues concerning the application of information systems in developing countries. *World Animal Review*, **3**, 19–24
- Ellis, P.R. (1993) Information systems in disease control programs. In: *Diagnosis and Epidemiology of Foot-and-Mouth Disease in Southeast Asia*. Eds Copland, J.W., Gleeson, L.J. and Chamnanpood, C., pp. 111–115. Australian Centre for International Agricultural Research, Canberra
- FAO (1999) *Manual on Livestock Disease Surveillance and Information Systems*. FAO Animal Health Manual No. 8. Food and Agriculture Organization of the United Nations, Rome
- Featherston, R.H. (1997) Benefits of a national database for patient medical records. *Journal of the American Veterinary Medical Association*, **210**, 173–174
- Frerichs, R.R. and Selwyn, B.J. (2002) Microcomputers, the Internet, and epidemiology. In: *Oxford Textbook of Public Health*, 4th edn. Vol. 2. Eds Detels, R., McEwen, J., Beaglehole, R. and Tanaka, H., pp. 745–758. Oxford University Press, Oxford
- Menzies, P.I., Meek, A.H., Stahlbaum, B.W. and Etherington, W.G. (1988) An assessment of the utility of microcomputers and dairy herd management software for dairy farms and veterinary practices. *Canadian Veterinary Journal*, **29**, 287–293
- Morris, R.S. (Ed.) (1991) Epidemiological information systems. *Revue Scientifique et Technique, Office International des Epizooties*, **10**, 1–231
- Morris, R.S., Nimis, G. and Stein, T.E. (1986) The computer as a tool in epidemiological studies – an appraisal of trends. In: *Proceedings of the 4th International Symposium on Veterinary Epidemiology and Economics*, Singapore, 18–22 November 1985, pp. 34–39. (A discussion of data collection, storage and analysis with microcomputers)
- Moser, C.A. and Kalton, G. (1971) *Survey Methods in Social Investigation*, 2nd edn. Heinemann Educational Books, London
- Payne, S.L. (1951) *The Art of Asking Questions*. Princeton University Press, Princeton
- Pollari, F.L., Bonnett, B.N., Allen, D.G., Bamsey, S.C. and Martin, S.W. (1996) Quality of computerized medical record abstract data at a veterinary teaching hospital. *Preventive Veterinary Medicine*, **27**, 141–154
- Revie, C.W., McKendrick, I., Irwin, T., Gu, Y., Reid, S.J.W. and Gettinby, G. (1996) The application of hybrid information systems to decision support in the veterinary and agricultural domains. In: *Society for Veterinary Epidemiology and Preventive Medicine, Proceedings*, Glasgow, 27–29 March 1996, Eds Thrusfield, M.V. and Goodall, E.A., pp. 48–57
- Smith, R.D. (2003) The application of information technology to the teaching of veterinary epidemiology and public health. *Journal of Veterinary Medical Education*, **30** (4), 344–350
- United States Department of Agriculture (1982) *International Directory of Animal Health and Disease Data Banks*. National Agriculture Library, United States Department of Agriculture, Miscellaneous Publication No. 1423

# 12

## Presenting numerical data

The epidemiologist makes inferences from data collected from groups of animals. The data are frequently quantitative, comprising numerical values. A fundamental characteristic of numerical biological data is their inherent **variability**. The weights of 100 Friesian cows, for example, will not be identical; there will be a range of values. If the 100 cows were a sample of a much larger group – say the national herd – then a different sample of 100, drawn from the same national herd, is almost certain to have a different set of weight values.

Variability is of importance to the epidemiologist in two circumstances: when a **sample** is taken and when different groups of animals are being **compared**. In the first circumstance, it is necessary to assess to what extent the sample's values are representative of those in the larger population from which the sample was drawn. This is relevant to surveys, which are discussed in the next chapter. In the second circumstance, it is often necessary to decide whether or not a difference between two groups can be attributed to a particular factor. In epidemiology this frequently involves detecting an association between disease and hypothesized causal factors, and is discussed in Chapters 14 and 15. For example, if the effect of ketosis on milk yield were being investigated, then two groups of cows – one comprising cows with ketosis and one consisting of cows without ketosis – could be compared with respect to milk yield.

A detected difference in yield could be due to:

- the effect of ketosis;
- inherent natural variation in milk yield between the two groups;
- confounding variables (see Chapter 3) such as breed: cows of different breeds may be present in different proportions in each group, when the different breeds produce different milk yields.

In this example, the second and third reasons for the difference can confuse the investigation by contributing to differences in the milk yields of the two groups.

Statistical methods exist to separate the effects of the factors that are being investigated from random variation and confounding. Essentially, these involve estimating the **probability** of an event taking place. Probability is a numerical measure taking values between zero and 1. An event that is impossible has a probability of zero, whereas an event that is certain has a probability of 1. Probability also may be thought of as the frequency of certain events relative to the total number of events that can occur. Thus, the probability of throwing a 'head' with an unbiased coin is  $1/2$  (0.5). The probability of throwing either a 'head' or a 'tail' (i.e., the total probability) is 1. Similarly, prevalence (see Chapter 4) is a measure of probability. A specific prevalence value is an estimation of **conditional probability**; a male sex-specific prevalence of 30% means that there is a probability of 0.3 of any one animal having a disease at a given point in time, conditional on its being male.

This chapter deals with the probability distributions of numerical data that are the basis of many statistical tests (some of which are described in Chapter 13) and with the methods of displaying numerical values. The statistical content of this book is not comprehensive; it is designed to give the reader a basic knowledge of some relevant concepts and techniques. The reader who is unfamiliar with elementary mathematical notation should first consult Appendix II.

### Some basic definitions

**Variable** Any observable event that can vary. Variables may be either continuous or discrete (see

Chapter 9). An example of a continuous variable is the weight of an animal. An example of a discrete variable is the number of cases of disease. In some circumstances, the numerical values of the variable are called **variates**.

**Study variable** Any variable that is being considered in an investigation.

**Response and explanatory variables** A response variable is one that is affected by another (explanatory) variable; for instance, an animal's weight may be a response variable and food intake an explanatory variable, because weight is assumed to depend on the amount of food consumed. In epidemiological investigations, disease often is considered as the response variable; for example, when studying the effects of dry cat food (the explanatory variable) on the incidence of feline urolithiasis. There may also be circumstances in which disease is considered as the explanatory variable, for instance when studying the effect of disease on weight. Response variables are sometimes called **dependent variables** and explanatory variables are called **independent variables**.

**Parameter** A quantity that can differ in different circumstances, but is constant in the case that is being considered. It may be a **constant** in a mathematical formula or model. For example, a survey may be designed to detect a minimum disease prevalence, such as 20%. Although prevalence can vary, the minimum detectable prevalence is defined for the objectives of the survey as a single unvarying value, and is therefore a parameter of the survey, which is incorporated in the appropriate formula to detect the specified minimum disease prevalence (see Chapter 13). A parameter may also be a **measurable characteristic** of a population such as the average milk yield of a herd of dairy cows.

**Data set** A collection of data.

**Raw data** The initial measurements that form the basis of analyses.

## Some descriptive statistics

Table 12.1 lists sample weights of two groups (A and B) of piglets, when weaned at 3 weeks of age. These can be considered as random samples of a much larger group of piglets; namely, all piglets at 3 weeks of age. The inherent variability is obvious. The number of piglets with weights within defined intervals (i.e., the group **frequency distribution** of the weights) for

**Table 12.1** Specimen 3-week weaning weights (kg) of two groups (A and B) of piglets.

Group A				
4.2	5.3	5.6	6.0	6.4
4.6	5.3	5.7	6.0	6.4
4.7	5.4**	5.7	6.1	6.4
4.8	5.4	5.7	6.1	6.5
4.9	5.4	5.9*	6.1	6.5
5.1	5.4	5.9	6.1	6.5
5.2	5.4	5.9	6.1**	6.8
5.2	5.5	5.9	6.2	6.8
5.2	5.5	6.0	6.3	6.8
5.3	5.5	6.0	6.4	
$n = 49$ ; $\bar{x} = 5.76$ kg; $s = 0.60$ kg; $Q_2 = 5.9$ kg; $SIR = 0.35$ kg.				
Group B				
2.6	4.3	4.6	4.8	5.3
3.4	4.3	4.6	5.0	5.5
3.6	4.3**	4.6	5.0	5.5
3.8	4.4	4.6	5.0	5.6
3.9	4.4	4.7*	5.0	5.6
4.0	4.4	4.7	5.1	5.6
4.0	4.4	4.7	5.1**	5.6
4.1	4.5	4.8	5.2	5.7
4.1	4.5	4.8	5.2	6.3
4.2	4.5	4.8	5.2	
$n = 49$ ; $\bar{x} = 4.69$ kg; $s = 0.67$ kg; $Q_2 = 4.7$ kg; $SIR = 0.40$ kg.				

\* Median

\*\* Quartiles

**Table 12.2** Grouped frequency distribution for the 3-week weaning weights of piglets in Group B of Table 12.1.

Weight (kg)	Number of piglets
2.6–3.0	1
3.1–3.5	1
3.6–4.0	5
4.1–4.5	13
4.6–5.0	15
5.1–5.5	8
5.6–6.0	5
6.1–6.5	1

Group B is recorded in Table 12.2 and depicted in Figure 12.1. This figure, which summarizes the data, is called a **histogram**. The intervals on the horizontal axis are 0.5 kg wide. The number of piglets within each interval is proportional to the area of the vertical bars. If the intervals on the horizontal axis are equal, as in this example, then the number of piglets within each interval is also proportional to the height of the bars. Alternatively, the vertical plots and the mid-points of the horizontal intervals can be joined, rather than constructing bars, in which case a **frequency polygon** is constructed. These data can be summarized further by the use of descriptive statistics that are measures of **position** and **spread** of the histogram.

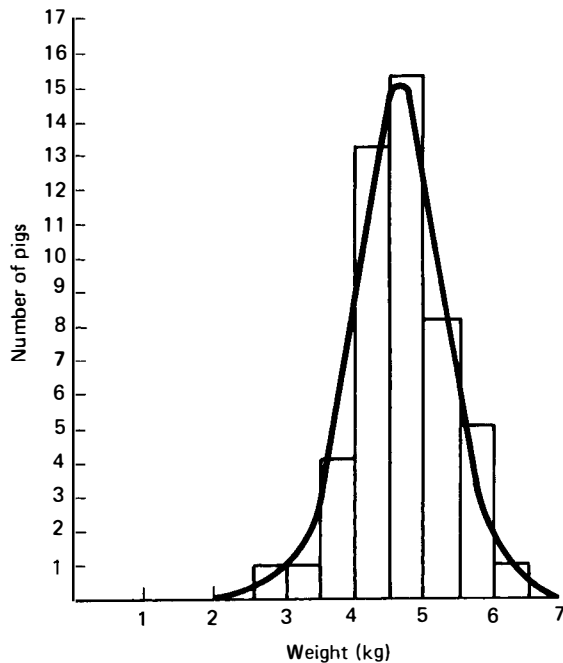

**Fig. 12.1** Observed distribution of the weights of the 49 piglets in Group B depicted as a histogram (rectangles) and fitted 'Normal' curve (smooth curve). (Data from *Table 12.1*.)

## Measures of position

A commonly adopted measure of position is the **mean** of the sample, denoted by  $\bar{x}$  (pronounced 'x-bar'). It is calculated using:

$$\bar{x} = \frac{\sum x}{n}$$

where  $n$  is the number of values in the random sample. In *Table 12.1*,  $n = 49$  in each group, and  $\bar{x} = 5.76$  kg in Group A, and 4.69 kg in Group B.

Each sample has been assumed, implicitly, to have been drawn from a much larger population; thus, the mean of the sample is only an **estimate** of the true population mean,  $\mu$ . Only if all the population is investigated can the parameter  $\mu$  be known. As the sample size increases,  $\bar{x}$  will be a better estimator of  $\mu$ ; that is, the precision of  $\bar{x}$  as an estimator of  $\mu$  will increase.

The **median** of the sample, sometimes denoted by  $Q_2$ , is another measure of position. It is the value below which half, and therefore above which half, of the observations lie. It divides the distribution into equal, ordered subgroups and is termed a **quantile**. Quantiles that divide the distribution into hundredths are centiles (percentiles). The median therefore is the 50th centile (percentile).

The median values in *Table 12.1* for Groups A and B, respectively, are marked with an asterisk, '\*'. Again, the sample median is an estimator of the true population median.

The lower and upper **quartiles**,  $Q_1$  and  $Q_3$ , respectively, are defined as the two values that are mid-way between the lower and upper extreme values and the median. For Groups A and B they are marked with two asterisks, '\*\*'. Thus, 25% of values fall below  $Q_1$ , and 75% of values lie above it;  $Q_1$  is therefore the 25th centile. Similarly, 75% of values fall below  $Q_3$  and 25% of values lie above it;  $Q_3$  is therefore the 75th centile.

Quartiles may be located between two values; notably, when there is an even number of observations. Interpolation is then required. If there are  $n$  observations, the first quartile ( $Q_1$ ) is the observation at position  $(n + 1)/4$ ; the second quartile (median:  $Q_2$ ) is the observation at position  $2(n + 1)/4$ ; and the third quartile ( $Q_3$ ) is the observation at position  $3(n + 1)/4$ . For example, suppose  $n = 10$ . Then  $(10 + 1)/4 = 2.75$ , and  $Q_1$  is between the second and third observations (call them  $x_2$  and  $x_3$ ), three-quarters of the way up. Thus,  $Q_1 = x_2 + 0.75(x_3 - x_2)$ . Similarly,  $(10 + 1)/2 = 5.5$ , and  $Q_2$  is between the fifth and sixth observations, half-way up. Thus,  $Q_2 = x_5 + 0.5(x_6 - x_5)$ , where  $x_5$  and  $x_6$  are the fifth and sixth observations. Again, since  $3(10 + 1)/4 = 8.25$ ,  $Q_3 = x_8 + 0.25(x_9 - x_8)$ , where  $x_8$  and  $x_9$  are the eighth and ninth observations.

Consider this data set, comprising six observations: 9, 12, 16, 22, 27, 31.

The first quartile ( $Q_1$ ) is the observation at position  $(n + 1)/4 = 7/4 = 1.75$ .  $Q_1$  is between the first and second observations, three-quarters of the way up:

$$9 + 0.75(12 - 9) = 9 + 2.25 = 11.25.$$

The median ( $Q_2$ ) is the observation at position  $2(n + 1)/4 = 14/4 = 3.5$ .  $Q_2$  is between the third and fourth observations, half of the way up:

$$16 + 0.5(22 - 16) = 16 + 3 = 19.$$

The third quartile ( $Q_3$ ) is the observation at position  $3(n + 1)/4 = 21/4 = 5.25$ .  $Q_3$  is between the fifth and sixth observations, one-quarter of the way up:

$$27 + 0.25(31 - 27) = 27 + 1 = 28.$$

## Measures of spread

Measures of spread are a little more difficult to calculate than those of position. Two examples of simple measures of spread are the range and the mean of the absolute deviations of the individual values from the mean. However, these measures often do not distinguish different sets of data.

A commonly adopted measure is the **sample variance**,  $s^2$ , which is calculated by:

$$s^2 = \frac{\sum(x - \bar{x})^2}{n - 1}.$$

This formula may be rewritten in a form that is more easily calculated with small calculators, namely:

$$s^2 = \frac{\sum x^2 - \{(\sum x)^2/n\}}{n-1}$$

The square root of the sample variance is called the sample **standard deviation**. Using the values from Table 12.1, Group B, and the formula for  $s^2$  above, the sample standard deviation,  $s$ , is given by:

$$\begin{aligned} &= \sqrt{\frac{\sum x^2 - \{(\sum x)^2/n\}}{n-1}} \\ &= \sqrt{\frac{1100.27 - (229.8^2/49)}{48}} \\ &= \sqrt{21.62/48} \\ &= 0.67 \text{ kg.} \end{aligned}$$

Just as the sample mean is an estimate of the population mean, so the sample variance and sample standard deviation are estimates of the **population variance**,  $\sigma^2$  and the **population standard deviation**,  $\sigma$  (sigma).

When summary statistics are presented, the sample standard deviation should be presented as well as the sample mean in order to indicate the variability within the population.

A measure of spread that often accompanies the median is the **semi-interquartile range (SIR)**. This is half of the range between the quartiles,  $Q_1$  and  $Q_3$ :

$$SIR = \frac{Q_3 - Q_1}{2}$$

This is an estimator for the **population semi-interquartile range**.

Alternatively, and increasingly, a sample may be summarized by a **five-point summary** consisting of the minimum, lower quartile, median, upper quartile and maximum.

## Statistical distributions

### The Normal distribution

If many piglets were weighed, rather than just the 49 in the data set shown in Table 12.1, and if the intervals used in the histogram in Figure 12.1 were reduced, then the bars would become narrower. Eventually, the corresponding frequency polygon would trace a smooth curve. One such curve has been fitted over the bars in Figure 12.1, using a computer program, which identifies the curve, using the weights in Table 12.1. The curve has one peak in the middle and is symmetrical.

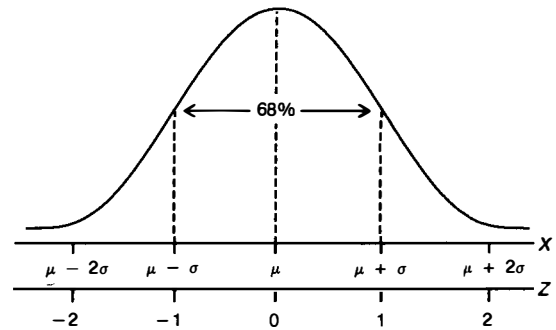

Fig. 12.2 A Normal density curve showing the relationship between  $\mu$ ,  $\sigma$ ,  $z$  and the proportion of observations for Normally distributed data.

This bell shape is typical of a family of frequency distributions known as the **Normal** family of distributions. It is better spelled with an upper case N to avoid confusion with other meanings of the word. Another name for this distribution is the **Gaussian** distribution. This distribution is described by two parameters: its mean,  $\mu$ , and its standard deviation,  $\sigma$ .

The Normal curve can be used as a smooth approximation to a histogram based on a sample of values, as in Figure 12.1, or as the paradigm of the population distribution of a variable. The latter can be described mathematically as a **density function** (Samuels, 1989), and plotted graphically as a **density curve**, which can be interpreted quantitatively in terms of areas under the curve (Figure 12.2). All Normal curves can be made equivalent with respect to areas under them by rescaling the horizontal axis. The rescaled variable is denoted by  $z$ , the **standardized Normal deviate**:

$$z = \frac{x - \mu}{\sigma}$$

The values  $z = 0, 1, 2, 3$  therefore correspond to  $x = \mu, \mu + \sigma, \mu + 2\sigma$  and  $\mu + 3\sigma$ , respectively, derived thus:

$$\text{if } x = \mu, z = \frac{\mu - \mu}{\sigma} = 0;$$

$$\text{if } x = \mu + \sigma, z = \frac{\mu + \sigma - \mu}{\sigma} = \sigma/\sigma = 1;$$

$$\text{if } x = \mu + 2\sigma, z = \frac{\mu + 2\sigma - \mu}{\sigma} = 2\sigma/\sigma = 2;$$

$$\text{if } x = \mu + 3\sigma, z = \frac{\mu + 3\sigma - \mu}{\sigma} = 3\sigma/\sigma = 3.$$

The  $z$  scale can be used to ascertain the proportion of observations that fall within a specified range of values. Approximately 68% of all Normally distributed values lie within one standard deviation of the mean of the population from which they were sampled ( $\mu - \sigma$  to  $\mu + \sigma$ ;  $z = -1$  to  $z = 1$ ), and 95% within approximately



**Table 12.3** Possible series of calves born to a cow during three successive uniparous gestations (M = male; F = female).

First gestation	Second gestation	Third gestation	Total male	Total female
M	M	M	3	0
M	M	F	2	1
M	F	M	2	1
M	F	F	1	2
F	M	M	2	1
F	M	F	1	2
F	F	M	1	2
F	F	F	0	3

two standard deviations of the mean (precisely:  $\mu - 1.96\sigma$  to  $\mu + 1.96\sigma$ ;  $z = -1.96$  to  $z = 1.96$ ) (Figure 12.2).

In many cases, the Normal distribution provides a workable approximation to the distribution of biological variables; for this reason it is a very important distribution. However, this distribution cannot be applied to all variables. Measurements to which Normality does not apply (although it can do as an approximation for large samples) are counts and ordinal data that only have a small number of intervals on the scale (Figure 9.1). Visual analogue measurements also may not be Normally distributed.

## The binomial distribution

This distribution relates to discrete data when there are only two possible outcomes on each occasion; for instance, the sex of a calf at birth can only be either male or female. An example is given in Table 12.3. The two outcomes may be of any kind but, for convenience, here are termed 'success' and 'failure'. On  $n$  occasions, the probability  $Pr(r)$  of  $r$  successes out of  $n$  trials is found to be:

$$Pr(r) = \frac{n!}{r!(n-r)!} p^r(1-p)^{n-r} \quad [r=0,1,2 \dots n; 0 < p < 1]$$

where  $p$  = probability of success on a single occasion assuming **no association** between the outcomes occurring on different occasions. In this example, two males (outcomes,  $r = 2$ ) may be born during three pregnancies (occasions,  $n = 3$ ). If it is assumed that the sex of the first calf does not affect the sex of future calves, and  $p = 0.52$ , then the probability,  $Pr(2)$ , will be:

$$Pr(2) = \frac{3!}{2!1!} (0.52)^2 (0.48) \quad [\text{Note: } n - r = 1] \\ = 0.39.$$

The value of  $p$  can vary considerably between 0 and 1; for example, in some genetically determined diseases.

## The Poisson distribution

The Poisson distribution<sup>1</sup> is concerned with counts. It is applicable when events occur randomly in space or time. Some commonly quoted examples are the distribution of blood cells in a haemocytometer and the distribution of virus particles infecting cells in tissue culture. This distribution is important in epidemiology because it relates to the spatial and temporal distribution of disease. The random occurrence of cases of disease in unit time or in unit area can follow a Poisson distribution. A significant departure from this distribution therefore indicates temporal and geographical departures from randomness (see Chapter 8).

The distribution is characterized by one parameter,  $\lambda$  (lambda): the average count per unit area or per unit time.

The probability of counts of  $r = 0, 1, 2, 3, 4$ , and so on, is given by the formula:

$$Pr(r) = \frac{e^{-\lambda} \lambda^r}{r!} \quad [\lambda > 0, r = 0, 1, 2 \dots]$$

where  $e$  is a constant: the base of natural (Napierian) logarithms = 2.718 28. The value of  $e^{-\lambda}$  can be found in published tables and is determined on many pocket calculators.

For example, suppose that a tissue culture monolayer is being infected with virus particles. If there are  $1 \times 10^6$  cells to which are added  $3 \times 10^6$  virus particles, then the average count/cell ( $\lambda$ ) is 3. The proportion of cells expected to be infected with, for example, two particles can be calculated using the formula above, with  $\lambda = 3$  and  $r = 2$ . Substituting in the formula:

$$Pr(2) = e^{-3} 3^2 / 2!$$

From tables or a calculator,  $e^{-3} = 0.0498$ .

$$\text{Thus: } Pr(2) = 0.0498 \times 3^2 / 2! \\ = 0.2241.$$

This means that the expected proportion of cells infected with two virus particles is 22.41%.

## Other distributions

There are many other statistical distributions. Some deviate from Normality; some of these deviations are illustrated in Figure 12.3. The mean and median are equal when a variable is symmetrically distributed; and the mean and standard deviation provide good measures of position and spread. However, when frequency distributions deviate from Normality, this

<sup>1</sup> The distribution is eponymously named after the 19th century French mathematician, Siméon-Denis Poisson.

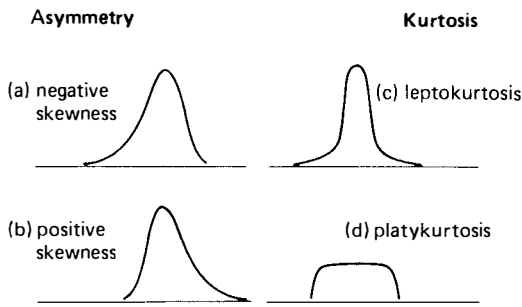

Fig. 12.3 Some deviations from the Normal distribution. (From Sard, 1979.)

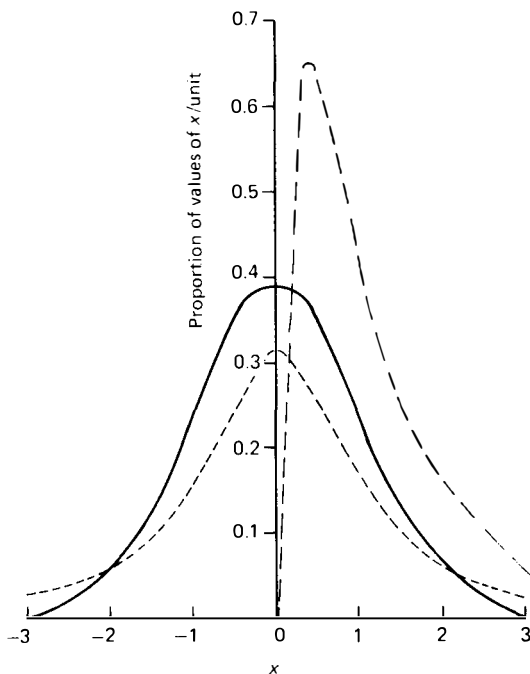

Fig. 12.4 Two non-Normal distributions compared with the Normal distribution.  
 — Normal distribution; ---- *t*-distribution;  
 - · - · - lognormal distribution.

may not be true. Thus, with a positive skew the mean is located to the right of the peak of the frequency distribution. In such cases, the median and semi-interquartile range are better measures of position and location. Some distributions are neither Normal nor binomial nor Poisson. Two other distributions are compared with the Normal in Figure 12.4. If unusual distributions are suspected, then expert statistical advice should always be obtained.

### Transformations

Natural scales of measurement are not always the simplest to analyse and interpret because they may produce non-Normal distributions. However, it is

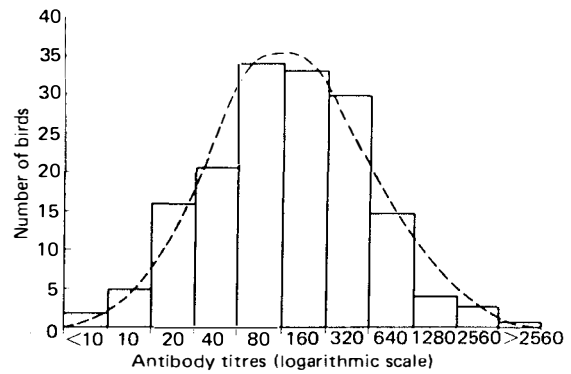

Fig. 12.5 An example of a transformed lognormal distribution. Distribution of the haemagglutination-inhibiting antibody titres of a group of 165 domestic fowls, 6 weeks after having been inoculated with a single dose of an inactivated Newcastle disease virus vaccine. The broken line shows a Normal curve fitted to these results. (From Herbert, 1970.)

sometimes possible to transform these distributions to approximate Normality by changing the way in which the variables are expressed – usually by raising the variables to a simple power or by converting them to logarithms (Zar, 1996). The distribution for which the logarithms of the data are Normally distributed is called the **lognormal distribution** (Figure 12.4). This distribution occurs in biology. It is characterized by a positive skew similar to, but not necessarily the same as, that depicted in Figure 12.3b. An example is given in Figure 12.5, which shows the frequency distribution of antibody titres to Newcastle disease virus in vaccinated birds, plotted on a logarithmic scale. In this case, a transformation was performed by diluting serum samples logarithmically before the titration was performed, initially to base 10 (1/10) and thereafter to base 2 (1/20, 1/40, 1/80, etc.). The application of logarithmic scales to serological investigations is discussed in Chapter 17. Epidemic curves (see Chapter 8) and incubation periods are often lognormal (Sartwell, 1950, 1966; Armenian and Lilienfeld, 1974). In the case of epidemic curves, the data (numbers of new cases) are discrete, but are treated as continuous measurements, because the numbers are frequently large.

### Normal approximations to the binomial and Poisson distributions

When samples are large, and *p* is not too close to 0 or 1, the binomial distribution can be approximated to the Normal. The approximation is better when a ‘continuity correction’ is applied to binomial data, to allow for the discrete nature of the data, while the Normal distribution relates to continuous data. Similarly, when samples are large, the Normal distribution provides a

good approximation to the Poisson distribution. Therefore techniques that are used to analyse Normally distributed data can sometimes be applied to the binomial and Poisson distributions. Such techniques, which become more accurate as sample size increases, are termed **asymptotic (large-sample)** methods.

## Estimation of confidence intervals

### The mean

The sample mean gives a single estimate for the population parameter  $\mu$  and is therefore called a **point estimate**. Repeated sampling of the population will produce different sample means as estimates of the population mean. The sample mean has a distribution; the mean of this distribution is equal to the population mean, but its variance is  $\sigma^2/n$ , the population variance divided by the sample size. The square root of the variance of the sample mean is termed the **standard error of the mean** (s.e.m.) to avoid confusion with the standard deviation of the individual values. It is given by:

$$\text{s.e.m.} = \sigma/\sqrt{n}.$$

This may be estimated by what is termed the **estimated standard error of the mean** (e.s.e.m.), obtained by replacing  $\sigma$  by  $s$ :

$$\text{e.s.e.m.} = s/\sqrt{n}.$$

The e.s.e.m. is an indication of the **precision** (see Chapter 9) of the sample's estimate of the population mean: the smaller the e.s.e.m., the greater the precision.

It is sometimes more useful to quote a range within which one is reasonably confident that the true mean will lie. This range is known as a **confidence interval**. It combines a measure of location (the mean) with a measure of spread (the s.e.m.). For example, on 95% of occasions that samples are taken from a population of Normally distributed values, the confidence interval given by the sample mean  $\bar{x} \pm 1.96$  s.e.m. will contain the true population mean. For a single sample, the interval  $\bar{x} \pm 1.96$  is known as the **95% confidence interval**. The upper and lower points of a confidence interval are **confidence limits**.

When the s.e.m. is estimated by the e.s.e.m. (which is nearly always the case), the multiplier 1.96 must be replaced by an appropriate value to take account of sampling variability. The value is obtained from tables (Student's<sup>2</sup>  $t$ -distribution: Appendix V). It depends on

the required level of confidence, the sample size and a related figure known as the **degrees of freedom**. If a sample consists of  $n$  **independent** observations (the value of one observation does not influence the value of another), then there are, in a sense,  $n$  independent 'pieces of information'. Calculating the mean uses one piece of information, leaving  $(n - 1)$  for the variance. This is because knowledge of  $(n - 1)$  observations and the mean fixes the value of the remaining observation. The number  $(n - 1)$  is the number of degrees of freedom.

Using the values from Group B (Table 12.1):

$$\begin{aligned} \text{e.s.e.m.} &= s/\sqrt{n} \\ &= \frac{0.67}{\sqrt{49}} \\ &= 0.096. \end{aligned}$$

To select the value of the appropriate multiplier for a 95% confidence interval from Appendix V, the column headed '0.05' ( $1 - 95/100$ ) is chosen. There are 48 degrees of freedom ( $49 - 1$ ). This number is not represented in the table, and so the highest value, not greater than 48, which is represented in the table, is picked: 40. The appropriate multiplier is therefore 2.021, and the 95% confidence interval is

$$\begin{aligned} \bar{x} \pm 2.02 \text{ e.s.e.m.} &= 4.69 \pm 0.194 \text{ kg} \\ &= 4.496, 4.884 \text{ kg.} \end{aligned}$$

assuming that the 3-week weaning weights are Normally distributed. (A comma conventionally separates the lower and upper limits of a confidence interval.)

Other confidence intervals can be estimated. To select the value of the appropriate multiplier for a 90% confidence interval from Appendix V, the column headed '0.10' ( $1 - 90/100$ ) is chosen, and the appropriate multiplier is 1.684. The 90% confidence interval therefore is:

$$\begin{aligned} \bar{x} \pm 1.68 \text{ e.s.e.m.} &= 4.69 \pm 0.161 \text{ kg} \\ &= 4.529, 4.851 \text{ kg.} \end{aligned}$$

The appropriate multiplier for a 99% confidence interval is 2.704 (selected from the column headed '0.01':  $1 - 99/100$ ).

Note that, with a given data set, greater confidence is associated with a wider confidence interval.

When samples are large, the Normal distribution provides a good approximation to Student's  $t$ -distribution, and techniques that are used to analyse Normally distributed data can be applied. Such techniques, which become more accurate as sample size increases, are termed **asymptotic (large-sample)** methods. The multipliers used in calculating asymptotic confidence intervals correspond to those for the Normal distribution (e.g., 1.960 for 95%, 2.576 for 99%, as in

<sup>2</sup> 'Student' is the pseudonym of William Gosset, a chemist at the Guinness Brewery in Dublin, who discovered the class of  $t$ -distributions in 1908. He considered himself a student, still learning statistics, and so authored papers under that pseudonym.

Appendix VI). These correspond to the values given for Student's *t*-distribution when the number of degrees of freedom is infinite (the last row in Appendix V).

### The median

An approximate 95% confidence interval for the median is estimated by first calculating:

$$r = \frac{n}{2} - \left(1.96 \times \frac{\sqrt{n}}{2}\right) \quad \text{and} \quad s = 1 + \frac{n}{2} + \left(1.96 \times \frac{\sqrt{n}}{2}\right),$$

where *r* = the ordered observation corresponding to the lower limit, *s* = the ordered observation corresponding to the upper limit, and *n* = the sample size (Altman *et al.*, 2000).

Using the values from Group B (Table 12.1), *n* = 49; thus:

$$r = \frac{49}{2} - \left(1.96 \times \frac{\sqrt{49}}{2}\right) \quad \text{and} \quad s = 1 + \frac{49}{2} + \left(1.96 \times \frac{\sqrt{49}}{2}\right);$$

Thus, *r* = 24.5 – 6.86, and *s* = 1 + 24.5 + 6.86.

That is, *r* = 17.6, and *s* = 32.4.

The closest observation to 17.6 is observation 18; that is, 4.5 kg; whereas the closest observation to 32.4 is observation 32; that is, 5.0 kg. The approximate 95% confidence interval for the median is therefore 4.5, 5.0 kg. (Note the similarity to the 95% confidence interval for the mean, arising because the values in Group B are symmetrically distributed, and so the mean and median are similar.)

If other confidence intervals are required, the appropriate multipliers are obtained from Appendix VI.

This approximate method is acceptable for most sample sizes (Hill, 1987). The exact method is given by Altman *et al.* (2000), who also describe interval estimation of other quantiles. However, as noted by Conover (1999), the estimate of the confidence limits may be affected when the data have 'tied observations' (i.e., observations with identical values).

### A proportion

Using the notation in the discussion of the binomial distribution, above, in a single sample the estimate of a proportion, *p*, is  $\hat{p} = r/n$ , where *r* is the observed number of successes. (Note the 'hat' on the letter *p*, as a reminder that it is an estimate of the true proportion.) This sample proportion has a distribution; the mean of the distribution is equal to *p*, and its variance to  $p(1 - p)/n$ . The standard deviation of the distribution is termed its **standard error**:

$$\sqrt{\frac{p(1 - p)}{n}}$$

which may be estimated thus:

$$= \sqrt{\frac{\frac{r}{n} \left(1 - \frac{r}{n}\right)}{n}}$$

For large samples (say *n* > 30), the distribution is approximately Normal, and so, if *p* also is not near to 0 or 1, an approximate 95% confidence interval for the true proportion, *p*, is given by:

$$\frac{r}{n} \pm 1.96 \sqrt{\frac{\frac{r}{n} \left(1 - \frac{r}{n}\right)}{n}},$$

and, if other confidence intervals are required, the appropriate multipliers are again obtained from Appendix VI.

For smaller samples, the calculation is more complex, but the requisite confidence limits can be read directly from tables (Appendix VII). Thus, if five male calves, *r*, and seven female calves are born to 12 cows, *n*, the sample estimate of the probability of a calf being male,  $\hat{p}$ , is 5/12 = 0.4167. Consulting Appendix VII (which defines *r* as *x*), with *x* = 5 and *n* = 12, and *n* – *x* = 7, the 95% confidence interval is = 0.151, 0.723. Note the wide interval (i.e., imprecise estimate), resulting from the small sample size.

### The Poisson distribution

Table 12.4 lists the observed distribution of yeast cells in a sample, *n*, of 400 haemocytometer cells (column 2), and the expected frequencies according to the Poisson distribution (column 3). Using the notation in the discussion of the Poisson distribution, above,  $\lambda$  can be estimated by the mean of the observed frequencies in column 2,  $\bar{x} = (1 \times 20 + 2 \times 43 + 3 \times 53 \dots + 12 \times 2)/n = 4.68$ . When  $\lambda$  is large, the Poisson distribution tends to Normality, and, even when  $\lambda$  is not large,  $\bar{x}$  may be approximately Normal, provided the sample size is large. If  $n\bar{x} > 30$  (as in this example), a standard error can be estimated thus:

$$\sqrt{\frac{\bar{x}}{n}}$$

An approximate 95% confidence interval for  $\lambda$  is then:

$$\bar{x} \pm 1.96 \sqrt{\frac{\bar{x}}{n}};$$



small dogs. (The reader may wish to complete the other rows.)

The proportion of small dogs, expressed as a percentage, is:

$$\frac{1634}{5250} = 31.1\%.$$

The 95% confidence limits are expressed, as probabilities, in columns [10] and [11] of Table 12.5: 0.2919, 0.3312. Thus, the confidence interval for the proportion of small dogs in the general population is 29.2%, 33.1%.

### Incidence rate

Confidence intervals for incidence rates require a different approach, because the denominator comprises the complex unit, 'animal-time at risk'. A suitable method is based on the Poisson distribution. The numerator in the sample estimate of the incidence rate (i.e. the number of diseased animals), only, is used in the computation.

If the number of cases is greater than 100, a 95% interval is calculated thus:

$$\text{the lower limit, } \lambda_L = \left( \frac{1.96}{2} - \sqrt{x} \right)^2$$

$$\text{and the upper limit, } \lambda_U = \left( \frac{1.96}{2} + \sqrt{x} \right)^2,$$

where  $x$  = the observed number of cases (Altman *et al.*, 2000).

For instance, if a sample generated an incidence rate of 108 cases per 757 animal-months at risk:

$$\begin{aligned} \lambda_L &= \left( \frac{1.96}{2} - \sqrt{108} \right)^2 \\ &= (0.98 - 10.39)^2 \\ &= 88.6; \end{aligned}$$

$$\begin{aligned} \lambda_U &= \left( \frac{1.96}{2} + \sqrt{108} \right)^2 \\ &= (0.98 + 10.39)^2 \\ &= 129.3. \end{aligned}$$

The point estimate of the incidence rate per animal-year is therefore  $(108/757) \times 12 = 1.71$  cases per animal-year. The 95% interval estimate is  $(88.6/757) \times 12$ ,  $(129.3/757) \times 12 = 1.41, 2.05$  cases per animal-year.

If other confidence intervals are required, the appropriate multipliers are selected from Appendix VI.

If the number of cases is less than 100, Appendix VIII should be used.

### Other parameters

Confidence intervals can be estimated for many parameters whose point estimates have already been described in Chapter 4, including survival computed in survival analyses and adjusted (standardized) measures (Altman *et al.*, 2000). Calculation of confidence intervals for other parameters is discussed in the succeeding chapters in which they are encountered.

### Bootstrap estimates

The standard methods for calculating confidence intervals for population parameters or attributes are based on assumptions about the distribution of samples selected from a population. Large samples generally guarantee that the distribution of the estimates is Normal. However, small samples may require other distributional assumptions; for example – when calculating a confidence interval for the mean, and when the standard deviation has to be calculated – that samples from a population whose distribution is Normal will follow Student's  $t$ -distribution. However, this may not be the case, in which circumstance the estimate of the confidence interval for the mean will be inaccurate. This problem can be overcome by using computers to generate 'bootstrap'<sup>3</sup> estimates.

The technique is based on the principle that a single sample provides information on the distribution of the population from which it was drawn. Software can repeatedly randomly select individual values from the sample, one a time, replacing each value immediately after it is selected, so that it is a position to be randomly selected again (so-called 'sampling with replacement'; see also Chapter 13), until a sample with the same number of observations as the original is produced. This procedure is then repeated many times (50–200 times for interval estimation of the mean, but more than 1000 repetitions may be required for some parameters). The variability between the many samples that are generated reflects the standard error that would be derived from sampling the population many times. Therefore, if a confidence interval for the mean was being estimated, and 200 repetitions were conducted, there would be 200 values for the sample mean<sup>4</sup>. The **percentile method** then involves sorting these values in order. A 95% confidence interval would then have

<sup>3</sup> The term is derived from the saying 'pulling oneself up by one's bootstraps'.

<sup>4</sup> Clearly, sampling *without* replacement would be no value: it would merely generate the values in the original sample, but in a different order. Therefore, the mean and standard deviation would be the same for all repetitions.

the 2.5 centile (the fifth value if 200 repetitions are conducted) as its lower limit, and the 97.5 centile (the 195th value) as its upper limit. Similarly, a 90% confidence interval would then have the fifth centile (the tenth value) as its lower limit, and the 95th centile (the 190th value) as its upper limit. In practice, the percentile method is subject to bias, but this can be estimated and corrected.

The accuracy of a bootstrap estimate depends on the extent to which the distribution of values in the original sample reflects a variable's distribution in the population from which the sample was drawn. The number of bootstrap repetitions will not increase the accuracy of the method if the original sample is unrepresentative (Good, 1993).

Full details of appropriate bootstrap techniques are presented by Efron and Tibshirani (1993) and Davison and Hinckley (1997).

## Displaying numerical data

Data should be represented in a form that is easy to interpret and to analyse in detail. This presentation may reveal interesting facts about the data and their distributions. Some of the methods of displaying data have, of necessity, been described (see Chapter 4). These include tables, bar charts, graphs and frequency polygons. A further method is the histogram, already depicted in *Figure 12.1*. The histogram is used for continuous variables whereas the bar chart is used for discrete data.

### 'Pie' charts

A 'pie chart' is a circle (the 'pie') in which individual characteristics are represented as 'slices', the angle of a segment being proportional to the relative frequency of the corresponding characteristic. An example is given in *Figure 12.6*. Modern computer software facilitates depiction of the 'pies' with a three-dimensional appearance (*Figure 12.7*).

### 'Box and whisker' plots

Frequency distributions can be compared visually using a 'box and whisker' plot (Tukey, 1977; Erickson and Nosanchuk, 1979), which is based on a 5-point summary, described earlier. An example is shown in *Figure 12.8* using the data in *Table 12.1*. The central horizontal line indicates the median; the upper and lower extremities of the vertical lines (the 'whiskers') mark the maximum and minimum values of the data set; the horizontal sides of the large rectangles (the 'boxes') represent the quartiles.

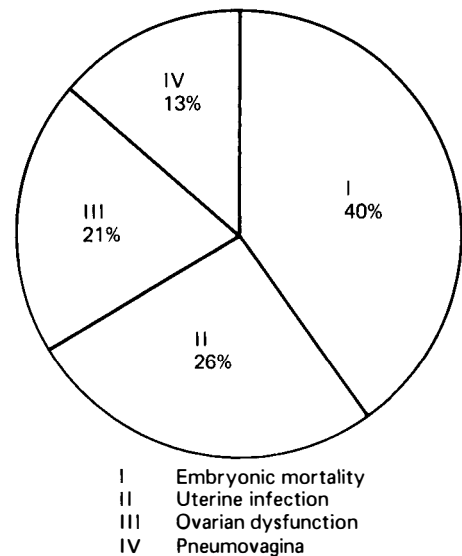

**Fig. 12.6** An example of a 'pie' chart: proportions of principal mare infertilities detected in over 100 clinical cases reported and presented. (From Fraser, 1976.)

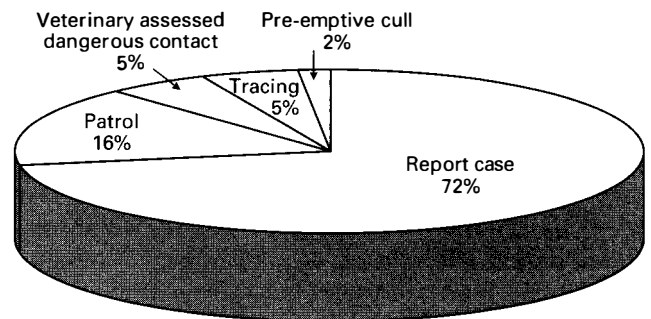

**Fig. 12.7** An example of a 'three-dimensional' 'pie' chart: methods of identification of infected premises in the foot-and-mouth disease epidemic in Dumfries and Galloway, UK, 2001. (Redrawn from Thrusfield *et al.*, 2005b.)

## Monitoring performance: control charts

It is sometimes desirable to monitor aspects of live-stock production, such as mean litter size in a herd of pigs, so that any significant negative or undesirable deviations in the values from a **predefined standard** or **acceptable range** can be detected. It is then possible to undertake appropriate remedial action. When data are recorded in tables, it is often difficult to appreciate the full significance of values or of their differences from one another. A suitable technique for monitoring data when they accrue sequentially is the use of **control charts**, which are graphs on which successive results are plotted in sequence while production is proceeding. These charts are important in modern Statistical Process Control methods (Owen, 1989). The significance of changes can then be evaluated, and

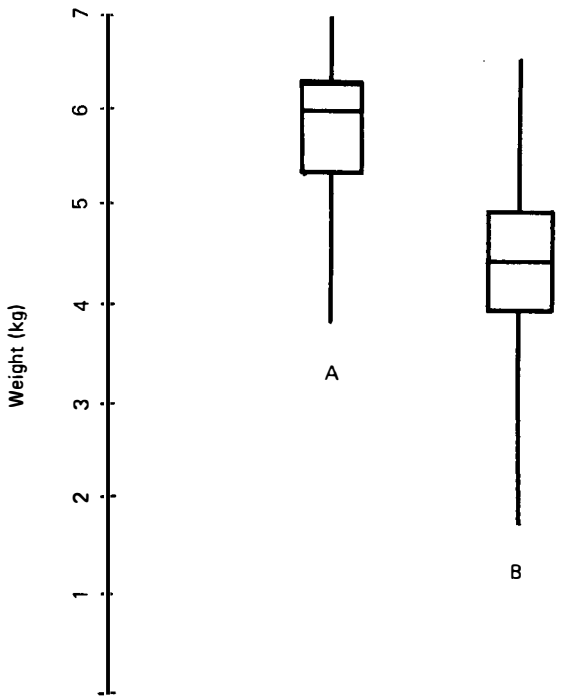

**Fig. 12.8** 'Box and whisker' plots of three weaning weights (kg) of two groups (A and B) of piglets. The central horizontal line indicates the median. The upper and lower extremities of the vertical lines (the 'whiskers') mark the maximum and minimum values of the data set. The horizontal sides of the large rectangles (the 'boxes') represent the quartiles. (Data from *Table 12.1*.)

corrective action taken at the earliest possible moment, thereby ensuring a smooth level of production.

**Shewhart charts**

The change in a variable's value can be monitored easily over a period of time by plotting values on squared graph paper (or, more likely nowadays, displaying the data graphically, using computer software), with 'time' as the horizontal axis. This technique was developed by Shewhart (1931) to control the quality of manufactured articles, and an example is given in

*Figure 12.9*, which charts the mean of the number of piglets born alive/litter in a herd of pigs over a 2-year period (Wrathall and Hebert, 1982).

Before the results are plotted, a **standard or reference value** is ruled as a horizontal line on the chart. This value is derived from the average of (ideally, at least 100) previous observations of the plotted variable in the herd. Alternatively, a composite value from other herds of a similar type in the national population may be used.

**Decision boundaries** (also termed **action levels** or **interference levels**: see Chapter 21) are also ruled on the chart, and remedial action is taken if a value of the variable crosses these boundaries. A mathematically derived decision boundary is based on the e.s.e.m. of a typical sample. It requires knowledge not only of the standard deviation of the reference figure but also of the average batch size. In some applications, two decision boundaries above and two below the target level may be used. The inner pair give 'warning' and the outer pair indicate 'action'. Selection of boundaries is discussed by Goulden (1952).

In *Figure 12.9* (with only one pair of decision boundaries) the decision boundary is set at 2 e.s.e.m. (2 here used as an approximation to 1.96; visually the difference should be of little consequence). A problem was detected in September 1977, and another, more severe problem was detected 6 months later. Such a problem may have been caused by reproductive disease in the sow, and subsequent microbiological investigations identified parvovirus in mummified fetuses.

If two standard errors are selected, it is expected that 2.5% of observations from the population will lie outside each boundary by chance alone. Therefore, remedial action will be taken on 2.5% of occasions when it is not justified. Similarly, if 2.33 standard errors are chosen as the boundary, then action will be unjustifiably taken on approximately 2% of occasions; if three standard errors are chosen, then unjustifiable action will be taken on approximately 0.28% of occasions. While an interval of three standard errors may

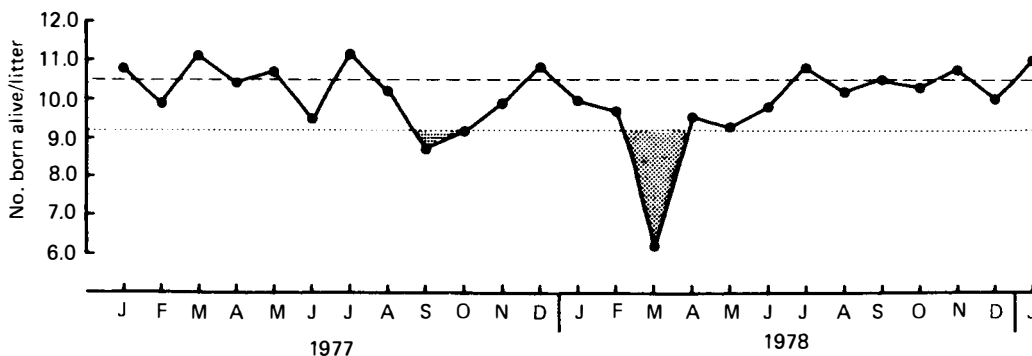

**Fig. 12.9** Shewhart chart: number of piglets born alive/litter in a herd of pigs, 1977 and 1978. --- Reference value; ..... decision boundary. (From Wrathall and Hebert, 1982; data from *Table 12.6*.)



seem attractive, this is accompanied by a greater probability of failing to take action, when desirable, than if a smaller number of standard errors had been chosen.

Although a decision boundary based on the e.s.e.m. is valuable, rigid adherence to such boundaries is not always valid because batch sizes tend to vary over time and so the e.s.e.m. will vary. However, average batch sizes can be used in calculating the e.s.e.m.; and this approach is more valuable than the arbitrary selection of a boundary level where individual values may cross the boundary level purely at random.

Note that the use of Shewhart charts for monitoring performance is only appropriate for stable processes or processes in control.

### Cusum charts

The Shewhart chart is effective for detecting large, abrupt changes in the value of a monitored variable. However, it is less effective when the change is small and results from a slight shift or 'drift' away from the reference or standard value over a period of time. The 'cumulative sum' technique is a more sensitive method for detecting such trends, and control charts incorporating this technique are known as **cusum charts** (Woodward and Goldsmith, 1964). The technique is useful for detecting changes in average levels, determining the point of onset of these changes, obtaining reliable estimates of current average values, and making short-term predictions of future average levels.

A cusum chart consists of a continuous plot (usually against time) of deviations of the cumulative value of the monitored variable from its reference value,  $k$ . Table 12.6 lists the mean monthly number of piglets born alive in a pig herd over a 2-year period. The selected reference value (obtained, for example, from previous production data on the farm) is 10.5.

In each successive time period, as values  $x_1, x_2, \dots$  for the batches become known, the cumulative sums,  $C_1, C_2, \dots$  are calculated thus:

$$\begin{aligned} \text{Period 1: } C_1 &= x_1 - k \\ &= 10.9 - 10.5 \\ &= 0.4; \end{aligned}$$

$$\begin{aligned} \text{Period 2: } C_2 &= (x_1 - k) + (x_2 - k) \\ &= C_1 + (x_2 - k) \\ &= 0.4 - 0.6 \\ &= -0.2; \end{aligned}$$

$$\begin{aligned} \text{Period 3: } C_3 &= C_2 + (x_3 - k) \\ &= -0.2 + 0.6 \\ &= 0.4; \end{aligned}$$

and so on (see the last column in Table 12.6).

The cusum is plotted in Figure 12.10. So long as the mean for a series of batch values remains close to the reference value,  $k$ , some of the individual cusum

**Table 12.6** Mean monthly values for piglets born alive per litter in a 125-sow herd, January 1977 – December 1978. (From Wrathall and Hebert, 1982; raw data supplied by the authors.) The reference value,  $k=10.5$ ; the cumulative sum,  $C_j = C_{j-1} + (x_j - k)$ . (See text for explanation.)

$j$	Month	Mean number of piglets born alive/litter ( $x_j$ )	$x_j - k$	$C_j$
1	1977 Jan	10.9	0.4	0.4
2	Feb	9.9	-0.6	-0.2
3	Mar	11.1	0.6	0.4
4	Apr	10.5	0.0	0.4
5	May	10.7	0.2	0.6
6	June	9.4	-1.1	-0.5
7	July	11.0	0.5	0.0
8	Aug	10.3	-0.2	-0.2
9	Sept	8.7	-1.8	-2.0
10	Oct	9.2	-1.3	-3.3
11	Nov	9.9	-0.6	-3.9
12	Dec	10.7	0.2	-3.7
13	1978 Jan	9.8	-0.7	-4.4
14	Feb	9.6	-0.9	-5.3
15	Mar	6.5	-4.0	-9.3
16	Apr	9.4	-1.1	-10.4
17	May	9.3	-1.2	-11.6
18	June	9.6	-0.9	-12.5
19	July	10.7	0.2	-12.3
20	Aug	10.1	-0.4	-12.7
21	Sept	10.5	0.0	-12.7
22	Oct	10.3	-0.2	-12.9
23	Nov	10.7	0.2	-12.7
24	Dec	10.1	-0.4	-13.1

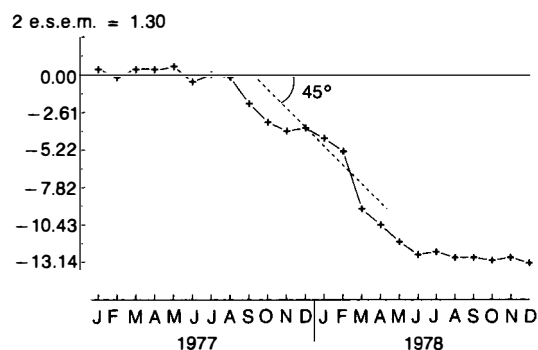

**Fig. 12.10** Plot of the cumulative sum values (cusum) for the mean monthly number of piglets born alive per litter in a herd of pigs in a 125-sow herd, January 1977–December 1978. (Data from Table 12.6.)

values will be positive, and some negative, and so they will tend to cancel each other out. The cusum plot will then be essentially horizontal, indicating that the monitored variable is in a state of control.

Important indicators of abnormality on the cusum chart are changes in direction and slope of the plotted line. The scales of the horizontal and vertical axes must therefore be chosen carefully. If one time period equals one unit on the horizontal axis, and 2 e.s.e.m. of cusum are equal to one unit on the vertical axis (the e.s.e.m.

being obtained from previous production data), then a plot's slope of  $45^\circ$  or more will indicate a change which is significant at the 2.5% level (see Chapter 14). Often, the slope is examined over a period of 10 time points (Owen, 1989). Thus (Figure 12.10), it can be seen that in the 10 months preceeding May 1978, the slope is approximately  $45^\circ$ . Consequently, this cusum analysis suggests a drift from the reference value. If smaller changes are of interest – and this is quite likely – then techniques such as the use of a 'V-mask' (Barnard, 1959) and a decision interval scheme (Wetherill, 1969) are available. Page (1961), Davies and Goldsmith (1972) and Wrathall and Hebert (1982) discuss this topic in detail.

Cusum charts do not detect steady trends and regular cyclical variations. These can be detected by other techniques such as time-series analysis (see Chapter 8).

## Further reading

- Altman, D.G., Machin, D., Bryant, T.N. and Gardner, M.J. (Eds) (2000) *Statistics with Confidence*, 2nd edn. BMJ Books, London. (*Estimation of confidence intervals and statistical guidelines*)
- Essex-Sorlie, D. (1995) *Medical Biostatistics and Epidemiology*. Appleton and Lange, East Norwalk
- Kaye, D.H. and Freedman, D.A. (2000) Reference guide on statistics. In: *Reference Manual on Scientific Evidence*, 2nd edn, pp. 83–178. Federal Judicial Center, Washington. (*A general guide to statistical methods, with emphasis on interpretation*)
- Mead, R., Curnow, R.N. and Hasted, A.M. (2003) *Statistical Methods in Agriculture and Experimental Biology*, 3rd edn. Chapman and Hall, Boca Raton and London
- Petrie, A. and Watson, P. (1999) *Statistics for Veterinary and Animal Science*. Blackwell Science, Oxford
- Sard, D.M. (1979) *Dealing with Data. The Practical Use of Numerical Information*. BVA Publications, London

# 13

## Surveys

---

Information on disease and associated events, such as productivity, can be obtained from **surveys** (introduced in Chapter 2). These involve **counting** members of an aggregate of units and measuring their characteristics. They may be conducted to estimate either a continuous variable such as weight and milk yield, or discrete events such as diseased animals. An important application of surveys in epidemiology is estimation of the **prevalence** of clinical disease, infection, or seropositive animals from samples of an animal population.

A survey of prevalence can involve:

- a single sample, either to determine prevalence or to determine whether or not disease is present in a group of animals;
- two samples, to compare prevalence;
- three or more samples.

The first situation commonly is encountered in epidemiological investigations and is the main subject of this chapter; the statistical methods are those used in estimating proportions<sup>1</sup>. Comparisons between two samples are described in the next chapter.

### Censuses and sample surveys

If all animals in a population are investigated, the survey is a **census**. Demographic censuses of human and animal populations are conducted regularly in many countries to determine the size and structure of the

populations. A census is the only means of measuring **exactly** the distribution of a variable in a population. Some prevalence surveys that are 'almost' censuses have been conducted. For example, Jasper *et al.* (1979) surveyed 2400 out of 2800 farms in California to determine the prevalence of mycoplasmal mastitis in dairy cows. Censuses can be expensive and may be difficult or impossible to conduct. However, if a survey is designed well, then a reasonably accurate and acceptable estimate of a variable can be made by examining some of the animals in the relevant population; that is, a **sample**. This involves analysis of the inherent variation in values of a variable that occurs in a population, which is reflected in samples, leading to differences between sample results and the value of the population characteristic that is being estimated (the **sampling error**).

### Sampling: some basic concepts

The validity of sampling theory is based on the assumption that an aggregate of units can be divided into representative subunits, and that characteristics of the aggregate can be estimated from the subunits.

### Some definitions

The **target population** is the total population about which information is required. Ideally, this should be the population at risk. The **study population** is the population from which a sample is drawn. These two populations should be the same. However, for reasons of practicality, this may not be possible. For instance, if an investigation of periodontitis in Maltese terriers were to be undertaken, then, ideally, all Maltese

---

<sup>1</sup> Surveys of continuous variables are not discussed here; suitable methods are described in the general texts on survey methods listed at the end of this chapter. Similarly surveys to determine the size of animal populations are not discussed; Levy and Lemeshow (1999) give appropriate formulae.

terriers (the target population) should be sampled, although it may only be possible to investigate animals at dog shows or attending veterinary practices (the study population). If the study population is not 'representative' of the target population, then results should not be generalized beyond the study population.

The study population consists of **elementary units**, which cannot be divided further. In veterinary surveys, these are usually individual animals.

A collection of elementary units, grouped according to a common characteristic, is a **stratum**. Thus, a dairy farm is a stratum comprising cows.

Before a sample is taken, members of the study population must be identified by constructing a list; this is the **sampling frame**. Each member of the sampling frame is a **sampling unit**. Thus, a list of hunting licence receipts was used as the sampling frame to identify hunters in an investigation of the recreational importance of feral pigs in relation to the possible control of African swine fever in the US (Degner *et al.*, 1983). A register of veterinarians can provide a sampling frame for sampling veterinary practices.

In areas in which telephone ownership is widespread, a sampling frame can be constructed from the list of names and numbers in telephone directories. Alternatively, all possible numbers can be used as the basis of sample selection. This second approach uses **random-digit dialling** (Waksberg, 1978) and is preferred to the first because it can include unlisted numbers and therefore reduces the likelihood of selection bias (Roslow and Roslow, 1972). It is a useful sampling method for surveys of pet populations (e.g., Lengerich *et al.*, 1992; Teclaw *et al.*, 1992; Slater, 1996a).

The **sampling fraction** is the ratio of sample size to study population size. Thus, if 10 animals were chosen from 1000, the sampling fraction would be 1%.

Veterinary sampling frames include lists of abattoirs, farms and veterinary practices, and can be constructed from some of the other sources of data described in Chapter 10. The objective of sampling is to provide an unbiased estimate of the variable that is being measured in the population. Many veterinary sampling frames (e.g., abattoirs) themselves relate to biased sectors of the total animal population and so caution must be exercised when extrapolating results to other sectors (e.g., farms). However, biased estimates also can be produced **within** a sampling frame when:

- lists of members of the frame are incomplete;
- information is obsolescent;
- segments of the frame are untraceable;
- there is lack of co-operation by some members of the frame;
- sampling procedures are not random (see 'Types of sampling').

These sources of bias are **non-compensating errors** because they cannot be reduced by increasing the size of the sample. They are part of a larger group of **non-sampling errors** (Groves, 1989), such as interviewer errors and poor response to questionnaires (see Chapter 11), which, although difficult to quantify, can have a large impact on the overall error (Zarkovich, 1966).

### The nature of sampling units

Sampling units may be individual animals (i.e., elementary units) or they may be aggregates such as herds, farms, or administrative regions, and prevalence may be calculated in relation to these different units. Thus, individual animal prevalence (the proportion of affected animals) may be quoted, or herd prevalence (the proportion of affected herds) may be cited<sup>2</sup>.

It is important to distinguish between the 'epidemiological unit' and the 'sampling unit' when dealing with infectious diseases (Tyler, 1991). The former unit is the group of animals that is of epidemiological significance in terms of the transmission and maintenance of infection, and therefore of disease control. It is convenient if the two units are identical. Thus, sheep 'hefts'<sup>3</sup>, and large herds that are managed independently, constitute different epidemiological units that may be considered as separate sampling units. In contrast, in developing countries, several small village herds that are put together and are herded on common grazing constitute a single epidemiological unit, and the village could be considered as the sampling unit.

## Types of sampling

There are two main types of sampling:

1. **non-probability sampling** in which the choice of the sample is left to the investigator;
2. **probability sampling** in which the selection of the sample is made using a **deliberate, unbiased** process, so that **each sampling unit in a group has an equal probability of being selected**; this is the basis of **random sampling**.

<sup>2</sup> Exceptionally, the herd may be the sampling unit, but a prediction can be made about individual-animal prevalence: Hartmann *et al.* (1997), for example, discuss the use of ELISA testing of bulk milk samples to predict within-herd prevalence of bovine herpesvirus 1. Cowling *et al.* (1999) describe methods for estimation of individual-animal prevalence based on pooled samples, which are eased by the use of appropriate software (Animal Health Services, 2004).

<sup>3</sup> Populations of sheep, resident on extensive hills or mountains, the populations often retaining themselves within a localized area without fences.

## Selecting a random sample

There are several ways of selecting a random sample. For instance, each animal in the study population could be represented by a numbered piece of paper in a hat. The desired number of pieces of paper, corresponding to the sample size, could then be drawn from the hat to identify the sample's members. This method assumes that selection is random, and could be laborious for large study populations. A more convenient and less haphazard way of random selection uses random numbers. These are listed in published tables, one of which is given in Appendix X, which also includes an example of random number selection.

Random numbers can also be generated by pocket calculators and computers. The former generate random numbers between 0 and 1. These values can be multiplied by the study population size to produce the required numbers. For example, if a random sample of 50 animals were required from a population of 2000 animals, then the calculator's random number generator might produce the values:

0.969, 0.519, 0.670 and 0.164, . . . ,

which, when multiplied by 2000, produce the sample numbers:

1938, 1038, 1340 and 328, . . . ,

respectively; and so on, until 50 animals are selected.

## Non-probability sampling methods

### Convenience sampling

Convenience sampling is the collection of easily accessible sampling units. When convenience is the main criterion for selecting a sample, it is very unlikely that the sample will be truly representative of the study population, resulting in biased estimates. For instance, if a survey were undertaken to estimate the prevalence of lameness in cattle, and if a sample were selected by choosing the first 10 out of 100 animals that entered a milking parlour, the sample probably would underestimate the prevalence because the leading animals would be less likely to be lame than those who entered the parlour last. In other cases, the selection procedure may not induce bias as obviously as in this example, but bias may nevertheless occur.

### Purposive selection

Purposive (judgemental) selection is the choice of a sample, the averages of whose quantitative characteristics (e.g., weight) or distribution of whose qualitative characteristics (e.g., sex and breed) are similar to those of the target population. The object is to select a sample

where characteristics are **balanced** with those of the target population. For example, a veterinarian who is undertaking a tuberculosis test on several herds may be asked to take blood samples from a 'representative' (i.e., balanced) sample for titration of antibodies against various bacteria and viruses. Purposive selection of so-called 'average' samples can produce a sample, none of whose members is far from the population mean. This sample therefore will only be representative of those collections of sampling units for which none of the members is far from the population mean. The sample will not be representative of all the possible samples that may be taken from the population, some of which will have means far from the population mean. Therefore the variability of the population that is being sampled may be underestimated. Additionally, experience and experimental evidence have demonstrated that consciously selected 'representative' samples are always biased. Yates (1981) discusses the disadvantages of purposive selection in detail.

## Probability sampling methods

### Simple random sampling

A simple random sample is selected by drawing up a list of all animals or other relevant sampling units (e.g., herds) in the study population, and then selecting the sampling units randomly, as described above.

### Systematic sampling

Systematic sampling involves selection of sampling units at equal intervals, the first animal being selected randomly. For example, if one animal in every 100 were required, then the first animal would be selected randomly from the first 100. If this were animal 63, then the sample would comprise animals, 63, 163, 263, 363 and so on. Systematic sampling is used frequently in industrial quality control, such as selecting samples of goods on a conveyor belt.

### Simple random versus systematic sampling

A systematic sample does not require knowledge of the total size of the study population. A simple random sample, however, can only be selected when all of the animals in the study population are identified. If lists are available with which to compile the sampling frame (e.g., lists of farms), then the random sample can be selected relatively easily. However, if lists are not available, it may be difficult – even impossible – to draw up the sampling frame and therefore to select the random sample.

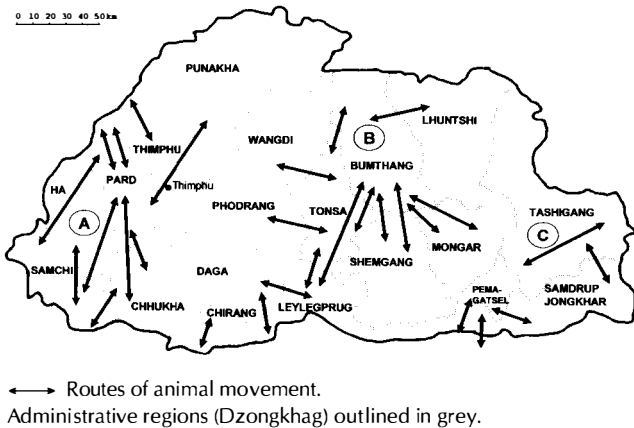

Fig. 13.1 The Kingdom of Bhutan, showing the main routes of livestock movement.

Systematic samples tend to be more evenly spread in the population than random samples, but in practice give results similar to simple random samples (Armitage *et al.*, 2002). However, the technique can be dangerous if there is periodicity in the sampling frame. For example, if a farmer only sends his animals to slaughter on Tuesdays, and abattoir samples are only selected on Wednesdays, then that farmer's animals cannot be represented in the samples.

### Stratified sampling

A stratified random sample is obtained by dividing the study population into exclusive groups (**strata**), then randomly sampling units from all of the individual strata. For example, the strata may be different ranges of herd or flock size, or different geographical regions. The latter may need to be identified after a detailed scrutiny of topography and livestock distribution. Thus, the Kingdom of Bhutan, lying in the Himalayas, has three main routes of livestock movement, separated by mountainous spurs (Figure 13.1). This suggests that the three regions, A, B and C, should be treated as separate strata.

Stratification can improve the accuracy of a sample because it overcomes the tendency of a simple random sample to either over-represent or under-represent some sections of the sampling frame. Thus, if a simple random sample of animals in all herds in a country were selected, it is possible that no animals in very small herds would be chosen. Stratification, which ensures that each group in the population is represented, overcomes this problem.

The number of sampling units selected from each stratum can be determined by several methods. A common method is **proportional allocation**, where the number of sampling units selected is proportional to the number in each stratum. For instance, if a sample of

Table 13.1 An example of stratification: selection of a stratified random sample of cows from different regions of Great Britain based on a 5% sample of all cows (147 000). (Data extracted from Wilson *et al.*, 1983.)

Region	Number of cows	Number sampled
Devon and Cornwall	302 647	$302\ 647 \times 0.05 = 15\ 132$
SW England other than Devon and Cornwall	469 486	$469\ 486 \times 0.05 = 23\ 474$
S England	271 225	$271\ 225 \times 0.05 = 13\ 561$
E England	119 835	$119\ 835 \times 0.05 = 5\ 992$
East Midlands	189 817	$189\ 817 \times 0.05 = 9\ 491$
West Midlands	462 826	$462\ 826 \times 0.05 = 23\ 141$
Wales	342 346	$342\ 346 \times 0.05 = 17\ 117$
Yorkshire/Lancashire	255 626	$255\ 626 \times 0.05 = 12\ 781$
N England	273 838	$273\ 838 \times 0.05 = 13\ 692$
Scotland	260 366	$260\ 366 \times 0.05 = 13\ 018$
Totals	2 948 012	147 399

cows were required from the British dairy herd by region, the number of cows selected from each region would be proportional to the number of cows in each region, to ensure that cows in regions with large numbers of dairy cattle are not under-represented. Table 13.1 illustrates this method of selection based on a 5% sampling fraction. Proportional allocation is the most efficient method of selection if there is equal cost in sampling each stratum. If this assumption is not true, then other, more complex, allocation methods should be used (Levy and Lemeshow, 1999).

### Cluster sampling

Sometimes, strata are defined by geographical locations, such as different countries, shires, parishes and villages, or by other categories such as veterinary practices or periods of time during which samples are selected. The strata are then termed **clusters**. Sampling from all of these clusters can be time-consuming and costly. This disadvantage can be overcome by selecting a few clusters, and sampling the animals only in these clusters; for example, animals in a few villages or herds could be sampled. This is **cluster sampling**. Commonly, **all** animals in each selected cluster are sampled; this is **one-stage cluster sampling**.

A sample also may be selected in more than one stage. Thus, a sample of clusters can be selected, followed by sub-sampling of **some** animals in the clusters (in contrast to **all** animals in one-stage cluster sampling). This procedure is therefore called **two-stage cluster sampling**; the clusters are the **primary units**, and the selected members of the sub-samples are the **secondary units**.

If the secondary units are the individual members of the study population, there is no point in going further.

However, if they consist of **groups** of population members, either all of their constituent members could be sampled or further stages of sampling could be undertaken, corresponding to progressively higher levels of sub-sampling; for example, sampling regions, then dairy farms in each selected region, then cows on each selected farm. This is **multistage cluster sampling**. The sampling technique at each stage is usually simple random sampling.

Cluster sampling is sometimes used when there is an incomplete list of all members of a population: a list of primary units is required, but secondary units need only be listed within the selected primary units. The technique is therefore convenient and relatively cheap because resources can be concentrated on limited parts of the full sampling frame. However, information is less precise than if either a systematic or random sample comprising the same number of animals were selected, because disease prevalence tends to be more variable **between** groups than **within** them – particularly with contagious diseases where herds are likely to have either high or low levels of infection.

Sometimes it is impossible to construct a sampling frame because reliable demographic data are not available. In such circumstances clusters can be defined using coordinates of a map grid. Grids may need to be constructed on maps that lack them, and grid lines identified by letters should be relabelled with numbers. *Figure 13.2* is an example. The co-ordinates 37 ('latitude') and 34 ('longitude') are chosen randomly (e.g., using random number tables). If herds are being selected, all herds within a defined radius of the selected coordinates should be sampled, the radius depending on the density of herds. If no herds are present within the radius, then no animals are sampled. The nearest herd to selected co-ordinates should **not** be the only herd sampled because this would bias the result by including too many herds from sparsely populated areas, and too few from densely populated ones.

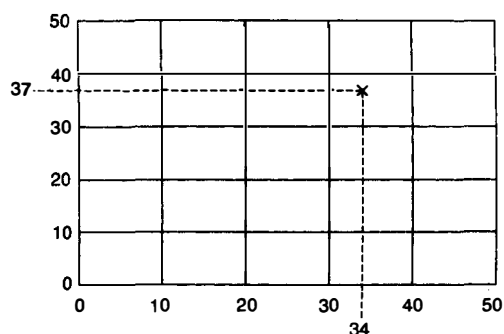

**Fig. 13.2** An example of sampling using map grids.

## What sample size should be selected?

The question that should be answered in all sample surveys is 'How many animals should be chosen for the survey?' An answer cannot be given without considering the objectives and circumstances of the investigation.

The choosing of sample size depends on non-statistical and statistical considerations. The former include the availability of manpower and sampling frames. The latter are the desired **precision** of the estimate of prevalence and the **expected prevalence** of the disease.

### Precision of the estimate of prevalence

The ability of an estimator to determine the true population value of a variable (i.e., the estimator's precision) can be expressed in terms of the bound on the error of estimation that can be tolerated. The error can be defined either absolutely or relatively. For example, an acceptable absolute error of  $\pm 2\%$  of a prevalence of 40% represents an acceptable range of 38–42%. A relative error of  $\pm 2\%$  of the same prevalence corresponds to 2% of 40%, that is 40%  $\pm 0.8\%$ , representing an acceptable range of 39.2–40.8%.

### Expected prevalence of the disease

It may appear paradoxical to suggest that some idea of disease prevalence is necessary before a survey is undertaken, because the objective of the survey is to determine the prevalence. However, a general notion is required; if the prevalence is thought to be close to either 0% or 100%, then the confidence interval for a given sample size will be narrower than if the prevalence were close to 50% (*Table 13.2*), that is, fewer animals will be required in the sample to achieve a stipulated width of confidence interval in the former case. Information on prevalence might be obtained from other related surveys. However, frequently this information is not available and so estimates have to be made that may be little more than informed guesses ('guestimates').

## Estimation of disease prevalence

### Simple random sampling

The approximate sample size required to estimate prevalence in a large (theoretically 'infinite') population can be determined for a defined precision and level of confidence. The limits of the associated interval indicate the specified bounds within which the estimate will lie with the defined level of

**Table 13.2** The approximate sample size required to estimate prevalence in a large population with the desired fixed width confidence limits. (Modified from Cannon and Roe, 1982.)

Expected prevalence	Level of confidence								
	90%			95%			99%		
	Desired absolute precision			Desired absolute precision			Desired absolute precision		
	10%	5%	1%	10%	5%	1%	10%	5%	1%
10%	24	97	2435	35	138	3457	60	239	5971
20%	43	173	4329	61	246	6147	106	425	10 616
30%	57	227	5682	81	323	8067	139	557	13 933
40%	65	260	6494	92	369	9220	159	637	15 923
50%	68	271	6764	96	384	9604	166	663	16 587
60%	65	260	6494	92	369	9220	159	637	15 923
70%	57	227	5682	81	323	8067	139	557	13 933
80%	43	173	4329	61	246	6147	106	425	10 616
90%	24	97	2435	35	138	3457	60	239	5971

confidence. The relevant formula for a 95% confidence interval is:

$$n = \frac{1.96^2 P_{exp}(1 - P_{exp})}{d^2}$$

where:  $n$  = required sample size;  
 $P_{exp}$  = expected prevalence;  
 $d$  = desired absolute precision.

For example, if an expected prevalence of 30% is to be estimated with a desired absolute precision of ±5% (i.e., the limits of the associated 95% interval are 25% and 35%), then:

$$P_{exp} = 0.30,$$

and

$$d = 0.05.$$

Substituting these values in the formula:

$$\begin{aligned} n &= \frac{1.96^2 \cdot 0.30(1 - 0.30)}{0.05^2} \\ &= \frac{3.84 \times 0.21}{0.0025} \\ &= 323. \end{aligned}$$

If other confidence intervals are required, then 1.96 is replaced by the appropriate multiplier (Appendix VI).

Table 13.2 can also be used. This table lists expected prevalence values and the desired absolute precision of ±10%, 5% and 1% for three levels of confidence (90%, 95% and 99%). Thus, if the expected prevalence is again thought to be about 30%, and it is desired to estimate this with an absolute precision of ±5% for a 95% confidence interval, then 323 animals are required – the same value as that given by the formula.

In this example, the use of 30% might be based on

prior evidence. In other circumstances the approximate prevalence might not be known. A suitable procedure would be either to choose the 50% figure to give the maximum sample size, or to select the 20% figure and take more samples, if necessary.

Appendix XI can also be used. The figures in this Appendix give the sample sizes required to attain either a 95% or 99% confidence interval for various prevalence values at various values of absolute precision. Using the same example of a 30% expected prevalence and absolute precision of ±5%, the sample would be selected using Figure 4 of the appendix, giving a sample size of approximately 400 (judged by eye from the curve) at the 95% level of confidence.

The formula and Table 13.2 are based on the Normal approximation to the binomial distribution (see Chapter 12). This is acceptable if the size of the study population is large in relation to the sample. However, as the size of the sample relative to the study population increases, the variance of the estimator of the mean of the study population is decreased and the width of the confidence interval is reduced accordingly. Therefore, in relatively small populations, it is possible to select a smaller sample than one from a theoretically infinite population to achieve the same degree of precision.

The required sample size,  $n_{adj}$ , is given by the following formula:

$$n_{adj} = \frac{N \times n}{N + n}$$

where  $n$  is the sample size, based on an infinite population (obtained from the formula above or Table 13.2) and  $N$  is the size of the study population.

For example, if prevalence were to be estimated using values similar to those in the example above, but in a small study population, say 900 animals, then:



$$n = 323,$$

$$N = 900.$$

Therefore:

$$\begin{aligned} n_{\text{adj}} &= \frac{900 \times 323}{900 + 323} \\ &= \frac{290\,700}{1223} \\ &= 238. \end{aligned}$$

Thus, the number of animals required to estimate the prevalence to the same absolute precision as the example above (which was based on an infinite population) is 238.

It is difficult to give a strict rule regarding application of this formula. It will always give the correct sample size, but  $n_{\text{adj}}$  will be very close to  $n$  if adjustment is unnecessary. A rough guideline is to calculate  $n_{\text{adj}}$  if  $n$  is 5% or more of  $N$ .

These approximate methods are usually sufficient, but, if the more complex exact methods are required, Levy and Lemeshow (1999) should be consulted.

**Imperfect tests** Frequently, surveys utilize diagnostic tests to identify disease, and such tests are not 'perfect'; that is, they have a diagnostic sensitivity and diagnostic specificity less than 100% (see Chapters 9 and 17), thereby generating false-negative and false-positive results, respectively, and therefore producing estimates of *test* prevalence, rather than *true* prevalence.

The relevant formula for determining sample size in a large population, for a 95% confidence interval, accommodating test imperfections (derived from Humphry *et al.*, 2004), is:

$$n = \left( \frac{1.96}{d} \right)^2 \times \frac{[(Se \times P_{\text{exp}}) + (1 - Sp)(1 - P_{\text{exp}})][(1 - Se \times P_{\text{exp}}) - (1 - Sp)(1 - P_{\text{exp}})]}{(Se + Sp - 1)^2},$$

where  $n$ ,  $P_{\text{exp}}$  and  $d$  follow the same notation as before,  $Se$  = sensitivity, and  $Sp$  = specificity.

For example, if an expected prevalence of 30% again is to be estimated with a desired absolute precision of  $\pm 5\%$ , with 95% confidence, and the test used has a sensitivity and specificity of 90% and 80%, respectively, then:

$$P_{\text{exp}} = 0.30,$$

$$d = 0.05,$$

$$Se = 0.90,$$

$$Sp = 0.80.$$

and:

$$n = \left( \frac{1.96}{0.05} \right)^2 \times$$

$$\frac{[(0.90 \times 0.30) + (1 - 0.80)(1 - 0.30)][(1 - 0.90 \times 0.30) - (1 - 0.80)(1 - 0.30)]}{(0.90 + 0.80 - 1)^2}$$

$$= 1536.64 \times \frac{(0.27 + 0.14)(0.73 - 0.14)}{0.49}$$

$$= 1536.64 \times \frac{(0.41)(0.59)}{0.49}$$

$$= 1536.64 \times \frac{0.2419}{0.49}$$

$$= 758.6;$$

that is, 759 animals are required.

Note that more animals are required than if the test were assumed to be perfect (which only requires 323 animals), and the number will increase as values of sensitivity and specificity decrease.

Again, in relatively small populations, a smaller sample,  $n_{\text{adj}}$ , can be selected, using the formula given above.

The formula for determining sample size using an imperfect test also can be used when aggregates of animals (e.g., herds or flocks) are the sampling units. This issue is addressed later in this chapter, at the end of the section 'Detecting the presence of disease', where the relevant statistical theory is presented.

### Systematic sampling

If it is reasonable to assume that a systematic sample is as representative as a simple random sample, then sample size can be calculated using the same formulae as those used above for calculating sizes of simple random samples. However, if periodicity is likely to be present in the sampling frame, more sophisticated formulae should be applied (Levy and Lemeshow, 1999).

### Stratified sampling

Sample sizes for proportionally allocated stratified samples again can be calculated using the methods appropriate to simple random samples. However, if more complex methods of allocation are adopted, then other formulae should be used (Levy and Lemeshow, 1999).

### Cluster sampling

The formulae for sample size determination for simple random samples cannot be applied to cluster samples because they do not take account of the potentially

large variation that can occur **between** clusters, and different methods therefore need to be applied.

An indication of the between-cluster variance component,  $V_c$ , is first needed. This is the variation expected between clusters if all animals in the clusters were sampled (i.e., there is no sampling variation within the clusters). If previous cluster sample data are available, then the between-cluster variance can be approximately calculated:

$$V_c = c \left\{ \frac{K_1 c V}{T^2(c-1)} - \frac{K_2 \hat{P}(1-\hat{P})}{T} \right\},$$

where:

- $c$  = number of clusters in the sample;
- $T$  = total number of animals sampled;
- $K_1 = (C - c)/C$ ,

where:

- $C$  = number of clusters in the population;
- $K_2 = (N - T)/N$ ,

where:

- $N$  = total number of animals in the population; and:
- $V = \hat{P}^2(\sum n^2) - 2\hat{P}(\sum nm) + (\sum m^2)$ ;

- where:  $\hat{P}$  = sample estimate of overall prevalence;
- $n$  = number of animals sampled in each cluster;
- $m$  = number of diseased animals sampled in each cluster.

Table 13.3 presents information from 14 farms selected as clusters from a total of 865 farms, all animals in each cluster being sampled (i.e., one-stage

**Table 13.3** An example of cluster sampling: a survey of 14 farms selected randomly from 865 farms; all animals in the selected farms investigated.

Farm	Total number of animals	Number of diseased animals	Farm prevalence
1	272	17	0.063
2	87	15	0.172
3	322	71	0.221
4	176	17	0.097
5	94	9	0.096
6	387	23	0.059
7	279	78	0.280
8	194	59	0.304
9	65	37	0.569
10	110	34	0.309
11	266	23	0.087
12	397	57	0.144
13	152	19	0.125
14	231	17	0.074
Total	3032	476	

cluster sampling). If such data are available, they can be used to determine between-cluster variance for determination of sample size for a subsequent cluster sample.

The sample estimate,  $\hat{P}$ , of overall prevalence =  $476/3032 = 0.157$ . (It would be misleading to calculate the overall prevalence by taking the mean of the individual cluster prevalences. In this example, such a calculation would give a value of  $0.186$ , i.e.  $[0.063 + 0.172 + \dots + 0.074]/14$  – somewhat higher than the actual overall prevalence.)

In this example,  $C = 865$  and  $c = 14$ . Thus,  $K_1$  is approximately equal to 1 and so  $K_1$  can be omitted from subsequent calculations. Similarly,  $N$  is assumed to be large, compared with  $T$ , and so  $K_2$  is approximately equal to 1 and so can also be omitted from the calculations.

Calculate  $V$  thus:

$$\sum n^2 = 272^2 + 87^2 + \dots + 231^2, \\ = 811\,450.$$

$$\sum nm = (272 \times 17) + (87 \times 15) + \dots + (231 \times 17) \\ = 116\,445.$$

$$\sum m^2 = 17^2 + 15^2 + \dots + 17^2 \\ = 22\,972.$$

Thus:

$$V = (0.157^2 \times 811\,450) - \{(2 \times 0.157) \times 116\,445\} + 22\,972 \\ = 20\,001 - 36\,564 + 22\,972, \\ = 6409.$$

Now substitute the values  $c = 14$ ,  $T = 3032$  and  $V = 6409$  into the formula:

$$V_c = 14 \left\{ \frac{14 \times 6409}{3032^2 \times 13} - \frac{0.157 \times (1 - 0.157)}{3032} \right\}, \\ = 14 \times 0.000\,707, \\ = 0.009\,90.$$

This value of  $V_c$  can be used to determine sample size for a subsequent cluster sample if the expected prevalence,  $P_{exp}$ , in the latter is assumed to be the same as that in the previous sample,  $\hat{P}$  (15.7%). However, if the expected prevalence is different, then an adjustment must be made:

$$V_{c,adj} = \frac{V_c P_{exp}(1 - P_{exp})}{\hat{P}(1 - \hat{P})}.$$

For example, if the expected prevalence in the new survey is 30%, then  $P_{exp} = 0.30$ ,  $\hat{P} = 0.157$ , and:

$$V_{c,adj} = \frac{0.009\,90 \times 0.30(1 - 0.30)}{0.157(1 - 0.157)}, \\ = 0.0157.$$

(Note that this value is only **coincidentally** one-tenth the value of the prevalence in the previous cluster sample.)

This value is then used for  $V_c$ .

**One-stage cluster sampling** The first step in determining sample size in one-stage cluster sampling is prediction of the average number of animals per cluster. The appropriate formula for a 95% confidence interval is then:

$$g = \frac{1.96^2 \{nV_c + P_{\text{exp}}(1 - P_{\text{exp}})\}}{nd^2},$$

where:

- $g$  = number of clusters to be sampled;
- $n$  = predicted average number of animals per cluster;
- $P_{\text{exp}}$  = expected prevalence;
- $d$  = desired absolute precision;
- $V_c$  = between-cluster variance.

For example, if an expected prevalence of 30% is to be estimated with a desired absolute precision of  $\pm 5\%$ , and the predicted average number of animals per cluster is 20:

$$\begin{aligned} n &= 20, \\ P_{\text{exp}} &= 0.30, \\ d &= 0.05, \\ V_c &= 0.0157. \end{aligned}$$

Thus:

$$g = \frac{1.96^2 \{20 \times 0.0157 + 0.30(1 - 0.30)\}}{20 \times 0.05^2} = 40.3.$$

Therefore, rounding up, 41 clusters should be sampled.

If the population of clusters from which the sample is to be drawn is small, the estimated number of clusters should be adjusted by:

$$g_{\text{adj}} = \frac{G \times g}{G + g},$$

where  $G$  is the total number of clusters in the population.

For instance, if the sample was to be selected from a population containing only 150 clusters:

$$\begin{aligned} g &= 40.3, \\ G &= 150, \end{aligned}$$

and:

$$\begin{aligned} g_{\text{adj}} &= \frac{150 \times 40.3}{150 + 40.3} \\ &= 31.8; \end{aligned}$$

thus, 32 clusters are required.

If the subsequent sampling results in a value for the average number of animals in each cluster that is less than the predicted value,  $n$ , then more clusters should be sampled until the value  $gn$  is attained.

If other confidence intervals are required, the appropriate multipliers should be used in place of 1.96 (Appendix VI).

**Two-stage clustersampling** Determination of sample size for two-stage cluster sampling depends on whether:

- the total sample size is fixed, and the number of clusters to be sampled is required; or
- the number of clusters is fixed, and the number of animals to be sampled is required.

(If neither the number of clusters nor the total sample size is fixed, then the optimum sample size can only be determined in terms of the cost of sampling from different clusters relative to the cost of sampling animals in the clusters. The relevant method is described by Levy and Lemeshow, 1999.)

(1) *Number of clusters to be sampled when the total sample size is fixed:* If the population of clusters is large compared with the number to be sampled, and the total number of animals is also large (which is the usual circumstance), the relevant formula for a 95% confidence interval is:

$$g = \frac{1.96^2 T_s V_c}{d^2 T_s - 1.96^2 P_{\text{exp}}(1 - P_{\text{exp}})},$$

where:  $g$  = number of clusters to be sampled;  
 $P_{\text{exp}}$  = expected prevalence;  
 $d$  = desired absolute precision;  
 $T_s$  = total number of animals to be sampled;  
 $V_c$  = between-cluster variance.

For example, if an expected prevalence of 30% is to be estimated with a desired absolute precision of  $\pm 5\%$ , 1000 animals are to be sampled, and the between-cluster variance is assumed to be 0.0157 (estimated from the previous cluster sample data in Table 13.3 with an adjustment for the difference between the prevalence in the previous cluster sample and the expected prevalence in the proposed sample):

$$\begin{aligned} P_{\text{exp}} &= 0.30, \\ d &= 0.05, \\ T_s &= 1000, \\ V_c &= 0.0157. \end{aligned}$$

Thus:

$$\begin{aligned} g &= \frac{1.96^2 \times 1000 \times 0.0157}{(0.05^2 \times 1000) - 1.96^2 \times 0.30(1 - 0.30)} \\ &= 35.6. \end{aligned}$$

Thus, 36 clusters need to be sampled, each sample ideally containing 28 animals ( $36 \times 28 \approx 1000 = T_s$ ). The selection of unequal numbers of animals from each cluster should not affect the result materially, unless there are major disparities. However, if fewer than 28 animals, on average, are sampled (i.e.,  $T_s < 1000$ ), then the desired level of precision may not be attained.

If the number of clusters to be sampled is negative, then it is not possible to obtain the desired absolute precision, even with a very large number of clusters. It would therefore be necessary to increase the total sample size,  $T_s$ , or decrease precision (i.e., increase the value of  $d$ ). If  $g$  is unrealistically high, it can be reduced by increasing  $d$  and/or increasing  $T_s$ , and then recalculating  $g$ .

If the population of clusters from which the sample is to be drawn is small, the adjustment formula,  $g_{adj} = Gg/(G + g)$ , should again be applied.

Thus, if the cluster sample designed above involved selection from a population of only 100 clusters, then  $G = 100, g = 35.6$ , and:

$$g_{adj} = \frac{100 \times 35.6}{100 + 35.6} = 26.3.$$

Therefore, rounding up, 27 clusters are required, each sample containing approximately 37 animals.

If the total number of animals in the population,  $N$ , is not large compared with  $T_s$ , then, for a 95% confidence interval, the number of clusters is approximately:

$$g = \frac{1.96^2 N T_s V_c}{d^2 N T_s - 1.96^2 (N - T_s) P_{exp} (1 - P_{exp})},$$

where  $N$  = total number of animals in the population, and  $P_{exp}, g, d, T_s$  and  $V_c$  follow the same notation as before.

For example, if 1000 animals are to be sampled from a total population of 10 000 animals to estimate a prevalence of 30% with an absolute precision of  $\pm 5\%$ , then  $N = 10\ 000, T_s = 1000, d = 0.05$  and, for a 95% confidence interval:

$$g = \frac{1.96^2 \times 10\ 000 \times 1000 \times 0.0157}{0.05^2 \times 10\ 000 \times 1000 - 1.96^2 (10\ 000 - 1000) \times 0.30 (1 - 0.30)} = \frac{603\ 131}{25\ 000 - 7261} = 34.0.$$

Therefore, 34 clusters are required, each containing, on average, 30 animals.

If the total number of animals and clusters in the population are both small, then the value of  $g$  obtained should be adjusted using the formula for  $g_{adj}$  given

above. Thus, if the total population of 10 000 animals were contained in 100 herds:

$$G = 100, \\ g = 34,$$

and:

$$g_{adj} = \frac{100 \times 34.0}{100 + 34.0} = 25.4.$$

Therefore, 26 clusters are required, each sample containing approximately 39 animals.

Again, the appropriate multipliers (Appendix VI) should be used if other confidence intervals are required.

(2) *Number of animals to be sampled when the number of clusters is fixed:* To determine the number of animals to be sampled when the number of clusters is fixed, the appropriate formula for a 95% confidence interval is:

$$T_s = \frac{1.96^2 g P_{exp} (1 - P_{exp})}{g d^2 - 1.96^2 V_c},$$

using the same notation as before.

If the total number of clusters in the population,  $G$ , is not large compared with  $g$ , then:

$$T_s = \frac{1.96^2 G g P_{exp} (1 - P_{exp})}{G g d^2 - 1.96^2 V_c (G - g)},$$

and if the total number of animals in the population,  $N$ , is not large compared with  $T_s$ , then adjust  $T_s$  thus:

$$T_{s,adj} = \frac{N \times T_s}{N + T_s}.$$

For example, if  $V_c = 0.0157, P_{exp} = 0.30, g = 30, d = 0.05$ , and the total population of clusters is large compared with  $g$ , then:

$$T_s = \frac{1.96^2 \times 30 \times 0.30 \times 0.70}{30 \times 0.05^2 - 1.96^2 \times 0.0157} = 1648;$$

that is, 55 animals per cluster.

If there are only 50 clusters in the total population, then:

$$T_s = \frac{1.96^2 \times 50 \times 30 \times 0.30 \times 0.70}{50 \times 30 \times 0.05^2 - 1.96^2 \times 0.0157 (50 - 30)} = 476;$$

that is, 16 animals per cluster.

If there are only 2000 animals in the total population, but a large number of clusters, then:

$$T_{s,adj} = \frac{2000 \times 1648}{2000 + 1648} = 904;$$

that is, 30 animals per cluster.

If there are only 2000 animals and 50 clusters in the total population, then:

$$T_{s,adj} = \frac{2000 \times 476}{2000 + 476} \\ = 385;$$

that is, 13 animals per cluster.

If the number of animals to be sampled is negative, it would be necessary to decrease precision (i.e., increase the value of  $d$ ) or to sample from more clusters. If  $T_s$  is unrealistically high, it can be reduced by increasing  $d$  and/or  $g$ , and then recalculating  $T_s$ .

Information derived from previous cluster samples often is not available. In such circumstances, a small random sample of clusters can be selected to provide a rough idea of the between-cluster variance before a full study is undertaken. Alternatively, the between-cluster variance component can be guessed. This is most easily done by guessing the standard deviation (i.e., the average difference expected between an individual cluster prevalence and the overall mean cluster prevalence), and then squaring it to give the between-cluster variance component. Thus, if an overall mean cluster prevalence of 0.30 (30%) is anticipated, and the average difference between this and the individual-cluster prevalence is guessed to be 0.09 (9%), then the between-cluster variance component would be  $0.09^2 = 0.0081$ . There is potential for error in determining the most appropriate sample size when there is greater variability between clusters than is guessed. It may therefore be prudent to assume a larger standard deviation than is guessed; for example 20%, giving a between-cluster variance component of 0.04 ( $0.2^2$ ).

There are no simple formulae for sample size estimation involving three or more stages. If the simple random sample formula is applied, it is likely to produce conservative estimates. (Some authorities recommend applying the simple random sampling formula and then, for all types of cluster sampling, multiplying the estimated sample size by between 2 and 4. This approach is empirical and can be inaccurate.)

Bennett *et al.* (1991) and Otte and Gumm (1997) discuss cluster sampling further.

## Detecting the presence of disease

If an investigator only wishes to know whether or not a disease is present in a group of animals (rather than determining the prevalence), a suitable sample size can be selected using the formula:

$$n = \{1 - (1 - p_1)^{1/d}\} \{N - d/2\} + 1,$$

where:

$N$  = population size;

$d$  = minimum number of affected animals expected in the population;

$n$  = required sample size;

$p_1$  = probability of finding at least one case in the sample.

For example, in the Pan-African Rinderpest Campaign, at the stage of serological surveillance, it was necessary to sample herds to ascertain if unvaccinated animals had seroconverted (i.e., had been exposed to natural infection)<sup>4</sup>. It is unlikely that only a small number of animals would have seroconverted in infected herds, and it was considered reasonable to assume that at least 5% of animals in such herds would be seropositive; that is, a *minimum* seroprevalence could be postulated in affected herds<sup>5</sup>. Therefore, the sampling protocol was designed to detect a seroprevalence of at least 5%. Thus, if  $p_1$  is set at 0.95, and if a herd containing 200 animals is to be sampled, then, substituting these values into the formula:

$$N = 200,$$

$$d = 10 \text{ (5\% of 200),}$$

$$p_1 = 0.95.$$

Therefore:

$$n = \{1 - (1 - 0.95)^{1/10}\} \{200 - 10/2\} + 1 \\ = (1 - 0.05^{1/10}) \times 195 + 1 \\ = (1 - 0.74113) \times 195 + 1 \\ = 0.2589 \times 195 + 1 \\ = 50 + 1 \\ = 51.$$

Thus, if the seroprevalence is 5%, 51 animals need to be sampled to detect at least one seropositive animal with probability 0.95. The probability of missing infection is therefore  $1 - 0.95 = 0.05$ , and, colloquially, one is '95% confident' that the disease is absent if 51 animals are sampled and no seropositive animals are detected<sup>6</sup>. Note that  $p_1$  is also the *aggregate sensitivity* (see Chapter 17), for a test with sensitivity and specificity = 100%, because it is also the proportion of affected herds that will be detected. Therefore, the formula above also can be used to calculate the sample size needed to attain

<sup>4</sup> Serological tests are often used to certify freedom from infection. This is because antibodies generally persist longer than clinical disease, and so are present at a higher prevalence than clinical cases, thereby necessitating a smaller sample size for detection.

<sup>5</sup> Surveys of diseases that are not highly contagious are generally concerned with the maximum amount of disease that can be tolerated (lower levels being considered acceptable). Accordingly, the same formula can be used, but a *maximum* prevalence is specified.

<sup>6</sup> This expression may aid understanding, but should not be confused with confidence intervals, which indicate the range of values within which a population parameter lies (see Chapter 12).

**Table 13.4** (i) Sample size required for detecting disease where the probability of finding at least one case in the sample is 0.95; (ii) upper 95% confidence limits for number of cases. (From Cannon and Roe, 1982.)

Population size (N)	(i) Percentage of diseased animals in population (d/N) OR (ii) Percentage sampled and found clean (n/N)											
	50%	40%	30%	25%	20%	15%	10%	5%	2%	1%	0.5%	0.1%
10	4	5	6	7	8	10	10	10	10	10	10	10
20	4	6	7	9	10	12	16	19	20	20	20	20
30	4	6	8	9	11	14	19	26	30	30	30	30
40	5	6	8	10	12	15	21	31	40	40	40	40
50	5	6	8	10	12	16	22	35	48	50	50	50
60	5	6	8	10	12	16	23	38	55	60	60	60
70	5	6	8	10	13	17	24	40	62	70	70	70
80	5	6	8	10	13	17	24	42	68	79	80	80
90	5	6	8	10	13	17	25	43	73	87	90	90
100	5	6	9	10	13	17	25	45	78	96	100	100
120	5	6	9	10	13	18	26	47	86	111	120	120
140	5	6	9	11	13	18	26	48	92	124	139	140
160	5	6	9	11	13	18	27	49	97	136	157	160
180	5	6	9	11	13	18	27	50	101	146	174	180
200	5	6	9	11	13	18	27	51	105	155	190	200
250	5	6	9	11	14	18	27	53	112	175	228	250
300	5	6	9	11	14	18	28	54	117	189	260	300
350	5	6	9	11	14	18	28	54	121	201	287	350
400	5	6	9	11	14	19	28	55	124	211	311	400
450	5	6	9	11	14	19	28	55	127	218	331	450
500	5	6	9	11	14	19	28	56	129	225	349	500
600	5	6	9	11	14	19	28	56	132	235	379	597
700	5	6	9	11	14	19	28	57	134	243	402	691
800	5	6	9	11	14	19	28	57	136	249	421	782
900	5	6	9	11	14	19	28	57	137	254	437	868
1000	5	6	9	11	14	19	29	57	138	258	450	950
1200	5	6	9	11	14	19	29	57	140	264	471	1102
1400	5	6	9	11	14	19	29	58	141	269	487	1236
1600	5	6	9	11	14	19	29	58	142	272	499	1354
1800	5	6	9	11	14	19	29	58	143	275	509	1459
2000	5	6	9	11	14	19	29	58	143	277	517	1553
3000	5	6	9	11	14	19	29	58	145	284	542	1895
4000	5	6	9	11	14	19	29	58	146	268	556	2108
5000	5	6	9	11	14	19	29	59	147	290	564	2253
6000	5	6	9	11	14	19	29	59	147	291	569	2358
7000	5	6	9	11	14	19	29	59	147	292	573	2437
8000	5	6	9	11	14	19	29	59	147	293	576	2498
9000	5	6	9	11	14	19	29	59	148	294	579	2548
10 000	5	6	9	11	14	19	29	59	148	294	581	2588
∞	5	6	9	11	14	19	29	59	149	299	598	2995

The table gives:

- (i) the sample size ( $n$ ) such that the probability ( $p_1$ ) of including at least one positive if the disease is present at the specified level is 0.95;
- (ii) the upper 95% confidence limit ( $u$ ) to the number of diseased animals in a population, given that the specified proportion were tested and found to be negative.

Examples:

- (i) expected proportion of positives is 2%; the population size is 480 – use 500; from the table, a sample of 129 is required to detect at least one positive with probability 0.95;
- (ii) for a population of 1000, a sample of 10% were all found to be negative; from the table, the upper 95% confidence limit for the number of positives is 29.

a desired aggregate sensitivity. More complicated formulae are required when sensitivity and specificity  $\neq 100\%$  (see below 'Imperfect tests').

Table 13.4 can also be used. This lists the sample sizes, with  $p_1$  set at 0.95, for detecting at least one

case of disease for various prevalence values and population sizes, offering a rapid means of determining sample size, rather than working the formula given above. For example, if the anticipated prevalence is 25%, and the population size is 120, then 10 animals

need to be sampled to detect at least one case with probability 0.95.

Some protocols involve sampling in more than one stage. For example, following the foot-and-mouth disease epidemic in the UK in 2001, demonstration of freedom from the infection required that samples were taken from as many small-ruminant holdings within the perimeters of the 10 km surveillance zones surrounding previously infected premises to detect, serologically, with probability 0.95, at least one infected holding if the estimated **flock seroprevalence** of disease was 2% (European Commission decision 2001/295/EC). The holdings thus identified were then subjected to second-stage sampling to detect a minimum within-flock/herd prevalence (i.e., **animal seroprevalence**) of 5%, again with probability 0.95<sup>7</sup>.

If a sample of size  $n$  has been selected from a population of size  $N$  and no cases have been detected, then the upper 100 $\xi$ % confidence limit,  $u$ , to the number of cases that may be present can be estimated from:

$$u = \{1 - (1 - \xi)^{1/n}\} \{N - n/2\} + 1.$$

( $\xi$  is the Greek letter 'xi'.)

For example, if  $N = 400$ ,  $n = 50$  and  $\xi = 0.95$ , then the upper 95% confidence limit,  $u = 23$ .

Again, *Table 13.4* can be used for this estimation. For instance, if 25% of 1400 animals were sampled and found to be disease-free, the upper 95% confidence limit of diseased animals is 11. Similar tables, constructed for 90% and 99% confidence limits, are listed in Cannon and Roe (1982).

The probability of detecting at least one positive animal, with various sampling fractions, is given in Appendix XII. The probability of **failing** to detect positive animals for various sample sizes and prevalence values is given in Appendix XIII.

### Imperfect tests

The formulae above assume that the diagnostic tests applied to samples have a sensitivity and specificity of 100%<sup>8</sup>. Thus, consideration is not given to the possibility that a seropositive animal detected in a sample is a false-positive (arising from a specificity less than 100%), in which circumstance the population may actually be disease-free. Similarly, a test-negative

sampled animal may be a false-negative (arising from a sensitivity of less than 100%), in which circumstance disease may be missed. The consequences of such errors could be serious: in the first instance, a healthy herd or flock may be slaughtered, whereas, in the second situation, an infected population may remain free to infect others.

Sensitivity and specificity can be included in sample size calculations for detecting disease, facilitating a more informed interpretation of any positive results that occur in samples (Cameron and Baldock, 1998a), and can be applied to two-stage sampling protocols (Cameron and Baldock, 1998b). The formulae (which include sampling without replacement) are complex, but are incorporated in software (*Freecalc*: see Appendix III).

The input parameters for the calculation are:

- the minimum expected prevalence, if disease is present;
- the probability of detecting disease at the minimum prevalence,  $p_1$ ;
- the probability of incorrectly concluding that disease is present, when it is absent,  $p_0$ ;
- the population size.

The output includes two numbers:

- the number of animals to be sampled;
- an upper 'threshold number' of test-positive animals that can occur in the sample, whilst still inferring that disease is absent at the minimum specified prevalence (the assumption being that this number of test-positives comprises false-positives).

*Table 13.5* lists the sample sizes and threshold numbers, with  $p_1$  again set at 0.95, for various prevalence values, and values of  $p_0$ , using a test with a sensitivity and specificity both equal to 98%. For instance, if the minimum prevalence is assumed to be 5%, then 121 animals need to be sampled from a population of 300, if  $p_0$  is set at 0.10. Moreover, up to four of these animals can test positive, while still being able to conclude, with '95% confidence', that disease is absent from the population at the specified minimum prevalence. Again, there is a probability,  $1 - p_1$  (i.e., 0.05) of missing disease. This is the probability of observing four or fewer test-positive animals in a sample of 121 animals drawn from a population of 300 animals in which the prevalence is 5%, and, again,  $p_1$  is also the aggregate sensitivity.

The interpretation of  $p_0$  is most easily understood in the context of the number of test positives that are detected in the sample, and the consequent value of  $p_1$ . First, the threshold number may be exceeded. For example, five test positives may be identified in the sample of 121 animals. Using the appropriate formula

<sup>7</sup> Sheep flocks that existed as hefts had each heft treated as a separate epidemiological unit, with the sampling procedure applied individually to each unit.

<sup>8</sup> A further assumption is that animals are sampled 'with replacement', that is, are placed back into the herd or flock immediately after sampling, and may therefore be selected again during sampling. In practice, this is usually not the case: sampling 'without replacement' (also see Appendix X). However, the practical violation of this assumption is usually of little consequence.

**Table 13.5** Sample size required for detecting disease, with probability,  $p_1 = 0.95$ , and threshold number of positives (in brackets), according to prevalence, and probability of incorrectly concluding that a healthy population is diseased [in square brackets]. Sensitivity = 98%; specificity = 98%.

Population size	Prevalence											
	10%			5%			2%			1%		
	[0.10]	[0.05]	[0.01]	[0.10]	[0.05]	[0.01]	[0.10]	[0.05]	[0.01]	[0.10]	[0.05]	[0.01]
30	26 (1)	30 (2)	*	*	*	*	*	*	*	*	*	*
50	39 (2)	39 (2)	45 (3)	48 (1)	*	*	*	*	*	*	*	*
100	45 (2)	55 (3)	64 (4)	85 (3)	*	*	*	*	*	*	*	*
150	48 (2)	58 (3)	78 (5)	105 (4)	119 (5)	*	*	*	*	*	*	*
200	49 (2)	60 (3)	80 (5)	115 (4)	131 (5)	173 (8)	*	*	*	*	*	*
300	50 (2)	62 (3)	83 (5)	121 (4)	155 (6)	202 (9)	*	*	*	*	*	*
500	51 (2)	63 (3)	85 (5)	144 (5)	162 (6)	229 (10)	469 (13)	*	*	*	*	*
1000	52 (2)	64 (3)	87 (5)	148 (5)	185 (7)	238 (10)	555 (15)	693 (20)	931 (29)	*	*	*
5000	52 (2)	65 (3)	88 (5)	151 (5)	190 (7)	263 (11)	640 (17)	788 (22)	1133 (34)	2100 (50)	2575 (63)	-
10 000	53 (2)	65 (3)	88 (5)	152 (5)	191 (7)	265 (11)	677 (18)	827 (23)	1178 (35)	2244 (53)	2841 (69)	-

\* = Required accuracy cannot be achieved, even by sampling all in the population. - = Too large a number to compute.

(Cameron and Baldock, 1998a), the value of  $p_1$  is calculated to be 0.88, in which circumstance the probability of concluding that the population is not diseased when it actually is ( $1 - p_1$ ) rises to 0.12: one is only '88% confident' that disease is absent at a minimum prevalence of 5%. The value of  $p_0$  is calculated to be 0.10; this is the probability of observing five reactors or more in a sample of 121 animals drawn from a *disease-free* population. (In setting the value of  $p_0$  at 0.10 in the sample size calculation, it is this value that is achieved if the threshold number is exceeded by one.) Thus, one can be '90% confident' that the population is diseased. Moreover, because  $p_0$  is the probability of incorrectly classifying a healthy population as being diseased,  $1 - p_0$  (0.90) is the probability of correctly classifying a healthy population being healthy; that is, the *aggregate specificity* (see Chapter 17).

Secondly, fewer reactors than the threshold number may be identified. Thus, if only three reactors were detected in the sample of 121 animals,  $p_1$  and  $p_0$  are computed to be 0.98 and 0.44, respectively. Therefore, it is now possible to conclude that disease is absent, at a prevalence of 5%, with an increased probability of 0.98 ('98% confidence'), and there is now only '56% confidence' that disease is present. (A high value of  $p_1$  and a low value of  $p_0$  would indicate that the population was not free from disease, but that the prevalence was less than the expected level.)

The value of  $p_1$  that is used in sample size determination dictates the aggregate sensitivity and level of confidence attached to declaring freedom from disease (a high value of  $p_1$  specifies a high degree of confidence), whereas the value of  $p_0$  decides aggregate specificity and level of confidence attached to identify-

ing a diseased population (a low value of  $p_0$  specifies a high degree of confidence). The selected values are governed by the goal of the survey. If a herd or flock is to be certified free from disease as part of an eradication campaign, then  $p_1$  should be set quite high (conventionally at 0.95). However, the value of  $p_0$  could be lower, because the consequences of, say, quarantining a false-positive herd or flock are not severe. High values of  $p_1$  linked to low values of  $p_0$  demand large sample sizes. This is indicated in Table 13.5 and Appendix XIV, which tabulates sample sizes and threshold numbers for various values of  $p_1$ ,  $p_0$ , population size, and prevalence. Accordingly, a compromise between  $p_1$  and  $p_0$  is usually sought.

### Sample-size calculation for aggregate-level prevalence surveys

The method for determining sample size for detecting the presence of disease using imperfect tests that has just been described is also of relevance to sample-size calculations for prevalence surveys when herds, flocks or other aggregates of animals are the sampling units.

The sample-size calculation, accommodating imperfect tests, is a two-stage procedure, involving determination of the number of aggregates to be sampled, and the number of animals to be sampled in each aggregate.

First, the number of herds or flocks to be sampled is determined using the formula for determining sample size for estimation of prevalence, using an imperfect test, but the sensitivity and specificity are now the *aggregate sensitivity* ( $Se_{agg}$ ) and *aggregate specificity* ( $Sp_{agg}$ ), which must be *pre-specified* by the investigator:



$$n = \left( \frac{1.96}{d} \right)^2 \times$$

$$\frac{[(Se_{agg} \times P_{exp}) + (1 - Sp_{agg})(1 - P_{exp})][(1 - Se_{agg} \times P_{exp}) - (1 - Sp_{agg})(1 - P_{exp})]}{(Se_{agg} + Sp_{agg} - 1)^2}$$

where:  $n$  = required number of herds or flocks to be sampled;

$P_{exp}$  = expected herd or flock prevalence;

$d$  = desired absolute precision.

For example, if an expected herd or flock prevalence of 20% is to be estimated with a desired absolute precision of  $\pm 5\%$ , and aggregate sensitivity and aggregate specificity have the prespecified values, 95% and 90%, respectively, then:

$$P_{exp} = 0.20,$$

$$d = 0.05,$$

$$Se_{agg} = 0.95,$$

$$Sp_{agg} = 0.90,$$

and:

$$n = \left( \frac{1.96}{0.05} \right)^2 \times$$

$$\frac{[(0.95 \times 0.20) + (1 - 0.90)(1 - 0.20)][(1 - 0.95 \times 0.20) - (1 - 0.90)(1 - 0.20)]}{(0.95 + 0.90 - 1)^2}$$

$$= 419 \text{ herds}^9.$$

Secondly, the number of animals in each herd or flock that is required to achieve the prespecified values of aggregate sensitivity and aggregate specificity needs to be calculated. The value of  $Se_{agg}$  is determined by the individual-animal sensitivity, the number of animals sampled in the aggregate, and disease prevalence within the aggregate; whereas the value of  $Sp_{agg}$  is dictated by the individual-animal specificity and the number of animals sampled in the aggregate (see Chapter 17). It is therefore necessary to postulate the minimum prevalence of disease likely to obtain in an aggregate, as well as having estimates of individual-animal sensitivity and specificity.

For example, if individual-animal sensitivity and specificity are each estimated as being 98%, the minimum within-herd prevalence is 10%, and  $Se_{agg}$  and  $Sp_{agg}$  are prespecified as 95% and 90%, respectively, Table 13.5 can be used to determine the number of animals that need to be sampled. The table lists sample sizes for  $Se_{agg} = 0.95$  ( $p_1$  set at 0.95), and various values of  $Sp_{agg}(1 - p_0)$ , where values of  $p_0$  are given in square brackets). Thus, to determine how many animals need to be sampled from a herd of 200 animals, the column

headed [0.10], representing  $Sp_{agg}(1 - p_0) = 0.90$  (i.e.,  $p_0 = 0.10$ ) is scrutinized, and 49 animals are required; if the threshold number (2) is not exceeded, the herd is interpreted as diseased, and if the threshold number is not exceeded, the herd is interpreted as unaffected.

Appendix XIV (or the *FreeCalc* software) is used for other values of sensitivity, specificity,  $p_1$  and  $p_0$ .

In pre-specifying  $Se_{agg}$  and  $Sp_{agg}$  it should be noted that the larger the values, the smaller the number of herds or flocks that are required. However, scrutiny of Table 13.5 and Appendix XIV reveals that large values of  $Se_{agg}$  and  $Sp_{agg}$  require more animals to be sampled from each aggregate, and there may be insufficient animals in small herds to achieve such values. Thus, a trade-off may be required between the number of animals within each aggregate (i.e.,  $Se_{agg}$  and  $Sp_{agg}$ ) and the number of aggregates that need to be selected. However, high levels of precision and confidence for aggregate-level prevalence require large numbers of herds, particularly when individual-animal sensitivity and specificity are poor<sup>10</sup> (Table 13.6).

The design of surveys based on imperfect tests is discussed further by Audigé *et al.* (2001), Cannon (2001), Humphry *et al.* (2004) and Huzurbazar *et al.* (2004).

## The cost of surveys

Sampling the study population incurs a cost. For example, sampling of cows to determine the prevalence of mastitis by bacteriological examination of milk specimens involves a laboratory cost. The most economic sample size can be determined with defined precision. Alternatively, if a fixed amount of money is available, then the sample size can be determined to maximize precision. Scheaffer *et al.* (1979) and Levy and Lemeshow (1999) describe techniques for estimating sample size for simple random, stratified, systematic and cluster sampling that include cost functions in the estimations. An example of estimation of optimum sample size for a fixed cost, relating to a national British bovine mastitis survey, is given by Wilson *et al.* (1983).

## Calculation of confidence intervals

There may be occasions when sample size is predetermined (e.g., by the availability of animals). Moreover, even when an appropriate sample size has been selected before a survey is undertaken, it is unlikely that the

<sup>9</sup> Again, this should be adjusted ( $n_{adj}$ ) if the population of herds or flocks from which the sample is drawn is not large.

<sup>10</sup> For example, tests for Johne's disease (paratuberculosis) have been reported to have an individual-animal sensitivity as low as 35% (Whitlock *et al.*, 2000).

**Table 13.6** The approximate number of herds required to estimate an aggregate-level (herd) prevalence of 10% in a large population with the desired fixed width confidence limits for various values of aggregate sensitivity and specificity. (Modified from *Preventive Veterinary Medicine*, 65, Humphry, R.W., Cameron, A. and Gunn, G.J. A practical approach to calculate sample size for herd prevalence surveys, 173–188. © (2004), with permission from Elsevier.)

Desired absolute precision (%)	Level of confidence (%)	Aggregate specificity (%)	Aggregate sensitivity (%)			
			55	70	85	90
5	95	55	38 169	6 131	2 400	1 897
5	95	70	5 394	2 156	1 164	984
5	95	85	1 479	828	539	477
5	95	90	941	574	395	355
5	90	55	26 883	4 319	1 691	1 336
5	90	70	3 799	1 518	820	693
5	90	85	1 041	584	379	336
5	90	90	663	405	278	250
7.5	95	55	16 964	2 725	1 067	844
7.5	95	70	2 398	958	517	438
7.5	95	85	657	368	240	212
7.5	95	90	419	255	176	158
7.5	90	55	11 948	1 920	752	594
7.5	90	70	1 689	675	365	308
7.5	90	85	463	260	169	150
7.5	90	90	295	180	124	111

prevalence will be exactly what is anticipated, and that the specified number of animals will be sampled. Thus, in all circumstances, a confidence interval should be calculated from the sample that is available.

**Simple random sampling**

A 95% confidence interval can be calculated from a simple random sample for a given sample size, *n*, and estimated prevalence,  $\hat{P}$ , using the formula for calculation of a confidence interval for a proportion, based on the Normal approximation to the binomial distribution, introduced in Chapter 12, and expressed in this chapter in terms of  $\hat{P}$ :

$$\hat{P} - 1.96 \sqrt{\frac{\hat{P}(1 - \hat{P})}{n}}, \hat{P} + 1.96 \sqrt{\frac{\hat{P}(1 - \hat{P})}{n}}$$

For example, if 200 animals were sampled, and 80 were found to be diseased, then the estimated prevalence would be 40%, and:

$$\hat{P} = 0.4, \\ n = 200.$$

Thus, the 95% confidence interval is:

$$0.40 - 1.96 \sqrt{\frac{0.40(1 - 0.40)}{200}}, 0.40 + 1.96 \sqrt{\frac{0.40(1 - 0.40)}{200}} \\ = 0.40 - 0.068, 0.40 + 0.068 \\ = 0.332, 0.468; \\ \text{that is, } 33.2\%, 46.8\%.$$

If other confidence intervals are required, then 1.96 is replaced by the appropriate multiplier (Appendix VI).

This formula assumes that the population from which the sample is drawn is large, and therefore that the sampling fraction, *f*, is small, which is usually the case. If, however, the sampling fraction is large (greater than 10%), then the numerator,  $\hat{P}(1 - \hat{P})$  needs to be multiplied by  $(1 - f)$ . Thus, if the sample of 200 animals were drawn from population of 1000 animals,  $f = 0.2$ ,  $(1 - f) = 0.8$ , and the confidence interval is:

$$0.40 - 1.96 \sqrt{\frac{0.80 \times 0.40(1 - 0.40)}{200}}, 0.40 + 1.96 \sqrt{\frac{0.80 \times 0.40(1 - 0.40)}{200}} \\ = 0.40 - 0.061, 0.40 + 0.061 \\ = 0.339, 0.461;$$

that is, 33.9%, 46.1% (slightly narrower – i.e., more precise – than if the large-population formula had been applied).

The formula also assumes that:

- $P \geq 0.05$ , and  $\leq 0.95$ ,
- $nP$  and  $n(1 - P) \geq 5$ ,

where *n* = sample size, and *P* = prevalence in the study population.

In the example just given, *P* is replaced by its estimate from the sample,  $\hat{P}$ :

$$\begin{aligned}\hat{P} &= 0.40, \\ n\hat{P} &= 200 \times 0.4 \\ &= 80; \\ n(1 - \hat{P}) &= 200(1 - 0.4) \\ &= 120.\end{aligned}$$

and so the formula may be applied.

If  $P < 0.05$  or (most unlikely)  $> 0.95$ , an appropriate formula can be found in Chapter 17 ('Confidence intervals for sensitivity and specificity').

**Small sample size** If only a small-sized sample is available, then  $nP$  and  $n(1 - P)$  may be less than 5. It is then necessary to calculate exact confidence intervals, based on the binomial distribution (Altman *et al.*, 2000). The values also can be obtained conveniently by consulting Appendix VII.

**Diseases of low prevalence** Some diseases (e.g., tumours) may be rare. If the Normal approximation to the binomial distribution is applied, then a very large sample would be required to estimate a confidence interval accurately. Moreover, Appendix VII can only be used for prevalence values greater than 0.02%. Therefore, if the estimated prevalence is lower than this, an alternative method, utilizing the Poisson distribution (see Chapter 12) should be used. For example, a random sample of 2000 dogs may yield two cases of osteosarcoma. The point estimate of the prevalence per 100 000 animals is therefore  $2/2000 \times 100\,000 = 100$  cases per 100 000 dogs. To construct a 95% confidence interval, consult columns 4 and 5 of Appendix VIII. The lower limit for two cases ( $x = 2$ ) is derived from the value of  $x_L = 0.242$  thus:  $0.242/2000 \times 100\,000 = 12$  cases per 100 000 animals. The upper limit is derived from the value of  $x_U = 7.225$ , thus:  $7.225/2000 \times 100\,000 = 361$  cases per 100 000 animals.

**Imperfect tests** If prevalence is being estimated with a diagnostic test whose sensitivity and specificity are known, then a corrected estimate of the true prevalence,  $P$ , can be made by:

$$P = \frac{P^T + \text{specificity} - 1}{\text{sensitivity} + \text{specificity} - 1},$$

where  $P^T$  is the test prevalence (Rogan and Gladen, 1978). (The value of 1 is replaced by 100 if the parameters are quoted as percentages.)

For example, if  $P^T = 0.20$ , sensitivity ( $Se$ ) = 0.90 (90%), and specificity ( $Sp$ ) = 0.95 (95%), then:

$$\begin{aligned}P &= \frac{0.20 + 0.95 - 1}{0.90 + 0.95 - 1} \\ &= 0.1765.\end{aligned}$$

An approximate 95% confidence interval for the true prevalence can be calculated thus:

$$\hat{P} - 1.96\sqrt{\text{var } \hat{P}}, \hat{P} + 1.96\sqrt{\text{var } \hat{P}}$$

where:

$\text{var } \hat{P}$  = the variance of the true prevalence

$$= \frac{\hat{P}^T(1 - \hat{P}^T)}{n(Se + Sp - 1)^2}$$

where  $n$  = sample size.

Thus, if the test prevalence, above, was estimated from a sample of 400 animals,  $n = 400$ , and:

$$\begin{aligned}\text{var } \hat{P} &= \frac{0.20(1 - 0.20)}{400 \times (0.90 + 0.95 - 1)^2} \\ &= \frac{0.20 \times 0.80}{400 \times 0.85^2} \\ &= 0.000\,553\,63.\end{aligned}$$

Thus, the approximate 95% confidence interval for the true prevalence is:

$$\begin{aligned}0.1765 - 1.96\sqrt{0.000\,553\,63}, 0.1765 + 1.96\sqrt{0.000\,553\,63} \\ = 0.1765 - 0.0461, 0.1765 + 0.0461 \\ = 0.1304, 0.2226;\end{aligned}$$

that is, 13.0%, 22.3%.

If other confidence intervals are required, then 1.96 is replaced by the appropriate multiplier (Appendix VI).

If the sampling fraction,  $f$ , is large (greater than 10%), then the numerator of the variance formula,  $\hat{P}^T(1 - \hat{P}^T)$  again should be multiplied by  $(1 - f)$ .

This formula also can be applied when herds or flocks (rather than individual animals) are the sampling units, in which circumstance sensitivity and specificity are replaced by aggregate sensitivity and aggregate specificity (see Chapter 17 and 'Detecting the presence of disease: Imperfect tests', above).

### Systematic sampling

Confidence intervals for prevalence can be calculated for systematic samples using the formulae applied to simple random samples, assuming that there is no periodicity in the samples. More complex formulae should be applied if the latter may be present (Levy and Lemeshow, 1999).

### Stratified sampling

The simple random sample formulae also are satisfactory for proportionally allocated stratified samples. However, if other methods of allocation are

undertaken, more complex formulae are required (Levy and Lemeshow, 1999).

**Cluster sampling**

Confidence intervals for cluster samples need to be calculated differently from those for simple random samples, to take account of the variability that is likely to exist between the groups that constitute the clusters.

The data in Table 13.3 will again be used to illustrate how confidence intervals are calculated. The sample estimate,  $\hat{P}$ , has already been calculated in the preceding section on sample size determination for cluster samples, and was found to be 0.157.

An approximate 95% confidence interval may be calculated using the formula<sup>11</sup>:

$$\hat{P} - 1.96 \left\{ \frac{c}{T} \sqrt{\frac{V}{c(c-1)}} \right\}, \hat{P} + 1.96 \left\{ \frac{c}{T} \sqrt{\frac{V}{c(c-1)}} \right\},$$

where:

- $c$  = number of clusters in the sample;
- $T$  = total number of animals in the sample;

and:

$$V = \hat{P}^2(\sum n^2) - 2\hat{P}(\sum nm) + (\sum m^2),$$

where:

- $n$  = number of animals sampled in each cluster;
- $m$  = number of diseased animals sampled in each cluster.

Now, substitute the values  $c = 14$ ,  $T = 3032$  and  $V = 6409$  (derived in the preceding section on sample size determination for cluster samples) into the formula:

$$\begin{aligned} &0.157 - 1.96 \left\{ \frac{14}{3032} \sqrt{\frac{6409}{14(14-1)}} \right\}, 0.157 + \\ &1.96 \left\{ \frac{14}{3032} \sqrt{\frac{6409}{14(14-1)}} \right\} \\ &= 0.157 - (1.96 \times 0.0046 \times \sqrt{35.214}), 0.157 + \\ &\quad (1.96 \times 0.0046 \times \sqrt{35.214}) \\ &= (0.157 - 0.0535), (0.157 + 0.0535) \\ &= 0.1035, 0.2105; \\ &\text{that is, } 10.35\%, 21.05\%. \end{aligned}$$

<sup>11</sup> Again, this formula assumes that the fraction of clusters sampled ( $f$ ) is small (less than 10%). If the fraction is not small, the value  $V/c(c-1)$  needs to be multiplied by  $(1-f)$ . In this example,  $f = 14/865 = 0.016$ ; thus  $(1-f)$  is small and so can be omitted from the formula without affecting the result materially.

Again, if other confidence intervals are required, the appropriate multipliers should be used (Appendix VI).

Note that the value for the confidence interval is much wider than that which would have been obtained if the formula for simple random sampling had been inappropriately used (14.4%, 17.0% for a 95% confidence interval), illustrating that, for a given sample size, cluster samples usually produce less precise estimates than simple random samples<sup>12</sup>.

This formula can be used for both one-stage and two-stage cluster samples. In the former,  $n$  = all animals in each cluster, whereas, in the latter,  $n$  is a sample of animals in each cluster.

A simple rule stating when this Normal-approximation method for calculating confidence intervals may be applied does not exist. This is because the distribution of a cluster sample proportion is complex due to the presence of the two variance components (between clusters and between animals within clusters)<sup>13</sup>. An indication of the validity of the method can be obtained by plotting the frequency distribution of the individual cluster prevalence values. If this has a smooth, symmetric distribution, the Normal-approximation method is likely to be valid. Otherwise, the calculated confidence intervals may only be approximate, particularly if a small number of clusters has been sampled. Thus, a plot of the individual cluster prevalence values in Table 13.3 does not show a smooth distribution, and so the confidence intervals should be regarded as approximate. In such circumstances, an alternative approach to presenting precision would be to simply state the standard error of the cluster sample's overall prevalence (i.e., the value derived in the worked example above before being multiplied by the multiplier 1.96: 0.0273). More complex methods of calculating exact confidence intervals are also available (Thomas, 1989), but would require the use of a computer program.

Samples with three or more stages require more complicated methods (Levy and Lemeshow, 1999).

<sup>12</sup> This is because the variance of the prevalence (i.e., the square of the standard error of a proportion: see Chapter 12) derived by cluster sampling, when there is variability between clusters, is larger than the variance derived when the data are treated as a simple random sample. The ratio of the former variance to the latter is one definition of the **design effect**. (For other ways of determining the design effect, see Donner and Klar, 2000.)

<sup>13</sup> This means that it is unclear when the *central limit theorem* holds. This theorem states that, as more observations are included, eventually the mean of any distribution will tend towards a Normal distribution, providing its variance is finite. (See also Chapter 12, 'Normal approximations to the binomial and Poisson distributions'.) The central limit theorem should hold before Normal-approximation methods are used with complete trust. In cluster sampling, the larger the number of clusters and the number of animals, the more likely that the theorem will hold.

## Further reading

- Abramson, J.H. and Abramson, Z.H. (1999) *Survey Methods in Community Medicine*, 5th edn. Churchill Livingstone
- Barnett, V. (2002) *Sample Survey: Principles and Methods*, 3rd edn. Arnold, London
- Bennett, S., Woods, T., Liyanage, W.M. and Smith, D.L. (1991) A simplified general method for cluster sampling surveys of health in developing countries. *World Health Statistics Quarterly*, **44**, 98–106
- Casley, J.D. and Lury, D.A. (1981) *Data Collection in Developing Countries*. Clarendon Press, Oxford
- Cochran, W.R. (1977) *Sampling Techniques*, 3rd edn. John Wiley, New York
- Condon, J., Kelly, G., Bradshaw, B. and Leonard, N. (2004) Estimation of infection prevalence from correlated binomial samples. *Preventive Veterinary Medicine*, **64**, 1–14
- Donner, A. and Klar, N. (2000) *Design and Analysis of Cluster Randomization Trials in Health Research*. Arnold, London
- Dufour, B., Pouillot, R. and Toma, B. (2001) Proposed criteria to determine whether a territory is free of a given animal disease. *Veterinary Research*, **32**, 545–563
- Farver, T.B. (1987) Disease prevalence estimation in animal populations using two-stage sample designs. *Preventive Veterinary Medicine*, **5**, 1–20
- Farver, T.B., Holt, D., Lehenbauer, T. and Greenley, W.M. (1997) Application of composite estimation in studies of animal population production with two-stage repeated sample designs. *Preventive Veterinary Medicine*, **30**, 109–119
- Hadorn, D.C., Rüfenacht, J., Hauser, R. and Stärk, K. (2002) Risk-based design of repeated surveys for the documentation of freedom from non-highly contagious diseases. *Preventive Veterinary Medicine*, **56**, 179–192
- Humphry, R.W., Cameron, A. and Gunn, G.J. (2004) A practical approach to calculate sample size for herd prevalence surveys. *Preventive Veterinary Medicine*, **65**, 173–188
- Kish, L. (1995) *Survey Sampling*. John Wiley, New York
- Leech, F.B. and Sellers, K.C. (1979) *Statistical Epidemiology in Veterinary Science*. Charles Griffin, London and High Wycombe
- Levy, P.S. and Lemeshow, S. (1999) *Sampling of Populations: Methods and Applications*, 3rd edn. John Wiley, New York
- Lwanga, S.K. and Lemeshow, S. (1991) *Sample Size Determination in Health Studies: a Practical Manual*. World Health Organization, Geneva
- Moser, C.A. and Kalton, G. (1971) *Survey Methods in Social Investigation*, 2nd edn. Heinemann Educational Books, London
- Salman, M.D. (Ed.) (2003) *Animal Disease Surveillance and Survey Systems: Methods and Applications*. Iowa State Press, Ames
- Sergeant, E. and Toribio, J.-A. (2004) *Estimation of Animal-Level Prevalence from Testing of Pooled Samples*. AusVet Animal Health Services, PO Box 3180, South Brisbane, QLD 4101, Australia
- Slater, M.R. (1996) Methods and issues in conducting breed-specific canine health surveys. *Preventive Veterinary Medicine*, **28**, 69–79
- Tryfos, P. (1996) *Sampling Methods for Applied Research*. John Wiley, New York
- Woods, A.J. (1985) Sampling in animal health surveys. In: Society for Veterinary Epidemiology and Preventive Medicine, Proceedings, Reading, 27–29 March 1985, Ed. Thrusfield, M.V., pp. 36–54
- Yates, F. (1981) *Sampling Methods for Censuses and Surveys*, 4th edn. Charles Griffin, London and High Wycombe
- Ziller, M., Selhorst, T., Teuffert, J., Kramer, M. and Schlüter, H. (2001) Analysis of sampling strategies to substantiate freedom from disease in large areas. *Preventive Veterinary Medicine*, **52**, 333–343

# 14

## Demonstrating association

---

A valuable step in the identification of the cause of a disease is the detection of a **statistically significant** association between the disease and hypothesized causal factors; this is the basis of the first three of Evans' postulates (see Chapter 3).

### Some basic principles

Demonstration of association can be approached in three ways.

1. The difference, under two different circumstances, between the mean of the probability distribution of a set of values of a variable can be measured. If there is a significant difference between the means in the two circumstances, the different circumstances may lead to an explanation that reflects a causal association. For example, the weights of two groups of piglets, one group of which has developed neonatal diarrhoea and one group of which has not, can be measured. The effect of diarrhoea on weight can then be assessed by analysing the difference between the mean weights of the two groups. A similar approach can be adopted when comparing medians.
2. Variables can be categorized, and a significant association sought between various categories. Thus, bitches can be categorized according to whether or not they have physiological urinary incontinence and whether or not they are neutered. Evidence of an association between the syndrome and neutering can then be sought.
3. A correlation between variables can be sought. For instance, the incidence of lameness in cattle and the amount of rainfall can be recorded to investigate whether increased rainfall is signi-

ficantly associated with an increased incidence of lameness.

Although approaches 1 and 2 are introduced in this chapter in the context of causal studies, they can be applied in any circumstance in which two groups are being **compared**.

Many of the statistical techniques that adopt these three approaches were developed for use in agricultural science. Their use is confined to epidemiological investigations in this book, but they also have a wide application to experimental and observational biological and social sciences, and therefore are described in most general statistics textbooks.

### The principle of a significance test

The bell shape of the Normal distribution (see *Figure 12.1*) reveals that there is a probability, albeit a small one, of an observation occurring at the extreme tails of the distribution. This distribution may be used to describe the frequency distribution not only of the values of a continuous variable that has a Normal distribution but also of the means of repeated samples taken from that population (here termed the 'reference population'). This also includes means of parameters of other distributions, such as the binomial, when Normal approximations are applied. There is, therefore, a high probability of the mean of a sample being under the peak, and a much lower probability of this mean being close to either of the two tails. If the mean is close to a tail, this indicates either that the sample is one of those improbable samples taken from the reference population, or, more likely, that it has been drawn from a population with a different population mean.

It is necessary to decide when it is improbable that a sample mean has come from the reference population. This decision is taken when the probability,  $P$ , of obtaining a value for the sample mean at least as extreme as the one observed, **assuming that the sample is drawn from the reference population**, is less than a value corresponding to the **level of significance**. This level is represented by a probability called  $\alpha$  ('alpha'). Conventionally, in biological sciences,  $\alpha$  is taken to be 0.05, representing the 5% significance level. In the event of  $P < 0.05$ , the result is reported as 'significant  $P < 0.05$ ' and supports the claim that the sample was not drawn from the reference population. The 5% significance level is purely conventional. If more caution in inferring a difference were necessary, the 1% level ( $P < 0.01$ ) or 0.1% level ( $P < 0.001$ ) could be chosen. Some reporting procedures use \*, \*\*, and \*\*\* to record significance at these 'critical' levels of 5%, 1% and 0.1%, respectively. This decision-making procedure is the principle of a significance test.

Significance tests were originally conducted in conjunction with tables that presented only a limited number of significance levels, including the critical ones, and this practice is still common. However, many statistical software packages (see Appendix III) calculate exact  $P$  values, and these should always be quoted, if available, in preference to the relevant critical levels.

## The null hypothesis

In the previous discussion, a statistical test was undertaken on the basis that the sample came from a population with a mean no different from that of the reference population. This constitutes the **null hypothesis**; the null hypothesis thus is one of *no difference*. A significant result indicates that the null hypothesis is rejected in favour of an alternative one which states that the sample has been drawn from a population with characteristics that are different from the reference population. Demonstration of a significant difference implies rejection of the null hypothesis.

Notice that confidence intervals (see Chapter 12) and the outcomes of significance tests are closely related. For example, suppose that the null hypothesis states a particular value for the mean of a Normal distribution. A sample is taken and the significance test rejects the null hypothesis at the 5% level. The corresponding 95% confidence interval (sample mean  $\pm 2$  e.s.e.m.) then will **not** contain the value of the mean specified by the null hypothesis. Conversely, if the significance test does not reject the null hypothesis at the 5% level, the corresponding 95% confidence interval will contain the value of the mean specified by the null hypothesis.

## Errors of inference

Five per cent of samples from the reference population lie within the region that would lead to rejection of the null hypothesis at the 5% level. If this happens, it constitutes a rejection of the null hypothesis when the hypothesis is true. This error is an example of a **Type I error**: false rejection of a true null hypothesis. The probability of a Type I error is just the level of significance discussed above<sup>1</sup>.

A **Type II error** is a failure to reject the null hypothesis when it is untrue. The probability of committing this error is called  $\beta$  ('beta'). Ideally, both  $\alpha$  and  $\beta$  should be known by the investigator before the study begins.

Depending on the alternative hypothesis,  $\beta$  may or may not be determinable. In the previous discussion, if the alternative hypothesis specified the mean of the population from which the sample was drawn, then  $\beta$  could be determined for a stated value of  $\alpha$  and sample size. However, if the alternative hypothesis only hypothesized that the mean of the population from which the sample was drawn took one of several values, then  $\beta$  cannot be calculated. It is known that  $\beta$  can be kept small by increasing either  $\alpha$  or the sample size. The probabilities of Type I and II errors decrease as sample size increases. For a fixed sample size, the larger the probability of a Type I error is chosen to be, the smaller the probability of a Type II error will be, and vice versa.

Two remaining alternative decisions are possible. These represent correct inferences, rather than errors. The first inference is not rejecting the null hypothesis when it is true. The second is rejecting the null hypothesis when it is false (i.e., demonstrating a significant difference). The probability of the latter is called the '**power of a test**'; it is denoted by  $1 - \beta$ .

Most tests are calibrated by prescribing the significance level,  $\alpha$ , and the power,  $1 - \beta$ .

## One- and two-tailed tests

The previous discussion has been concerned with demonstrating any differences between a sample and

<sup>1</sup> There is a subtle difference between the probability of a Type I error and a  $P$  value, which is not usually addressed in introductory texts because elementary statistical practice is usually unaffected by the difference. Moreover, the statistical approach described here, which focusses on error rates and is termed 'frequentist statistics', attempts to draw a conclusion about the truth of a hypothesis based on the results of a single study. Some statisticians prefer to define probability in the context of ideal populations, in which, in principle, there is an indefinite repetition of measurements, and prefer to focus on the probability distributions of unknowns, given available information: a 'Bayesian' approach (see Chapter 3). Bayesian methods are introduced in Chapter 17 in the context of predictive values and likelihood ratios. For a detailed discussion of these issues, including statistical inference in the context of inductive and deductive reasoning, see Hacking (1975), Casella and Berger (1987) and Goodman (1999a,b).

a reference population, irrespective of the 'direction' of the difference; that is, whether the sample differs because it comes from a distribution with a mean to the left or right of the mean of the reference population. In this case, the investigator is concerned with significant departures towards either of the two tails of the distribution. A test that considers these departures is therefore called a **two-tailed test**.

Sometimes, an investigator may be reasonably certain that significant departures only occur in one direction. An example would be investigating whether diarrhoea depressed weight gain in piglets, rather than either depressed or increased it (the latter is very unlikely). This investigation requires a **one-tailed test**. The 5% significance level in a two-tailed test represents approximately two standard errors to either side of the mean. If the same criterion of approximately two standard errors were used in a one-tailed test, then the actual significance level would only be 2.5% (corresponding to the tail with which the investigator is concerned). Therefore, rejection of the null hypothesis at the 5% level in a one-tailed test requires a deviation corresponding to that required for rejection at the 10% level in a two-tailed test.

Significance tests involving other distributions, and conducted on large samples for which Normal approximations to these distributions are valid, often compute values of the standardized Normal deviate,  $z$  (see Chapter 12). These are then compared with tabulated values using values of mean and variance specified by the null hypothesis (Appendix XV). Some examples are given later.

## Independent and related samples

Groups (samples) that are compared may be **independent** or **related**, and different statistical techniques are required for these two circumstances. Independent samples require **unpaired tests**, whereas related samples require **paired tests**.

Samples are related when:

- comparisons are made between repeated measurements on the same individuals;
- they are matched for other variables.

An example of the first situation is the measuring of the weights of individual calves one week, and then a week later. Similarly, the completion of two similar questionnaires by the same respondents constitutes related samples.

Matching is a feature of some observational studies (see Chapter 15) and clinical trials (see Chapter 16).

Pairing can have the benefit of removing a source of variation, therefore providing a more sensitive test than its unpaired counterpart.

## Parametric and non-parametric techniques

### Parametric tests

Some tests are **parametric** because they are concerned with the mean, which is one of the parameters of the Normal distribution. Parametric techniques make the following assumptions of the data that are to be analysed:

- the distribution is Normal;
- the variables are measured on the interval or ratio scale; that is, they are continuous (see Chapter 9)<sup>2</sup>.

Additionally:

- some tests require that the two populations being compared have equal variances; if this is not the case, then these tests must be modified.

Table 14.1 lists some commonly used parametric techniques that test hypotheses relating to the mean. This chapter focusses on comparing two populations (i.e., two-sample methods) and correlation.

### Non-parametric tests

If the assumptions of a parametric test cannot be met, then **non-parametric** techniques should be used. These can be applied to nominal and ordinal data, as well as interval and ratio data. Most of these tests are distribution-free, that is, they do not require assumptions such as the underlying distribution being Normal, but they do assume symmetry.

Table 14.2 lists some commonly used non-parametric techniques. These are described fully by Siegel and Castellan (1988).

Parametric tests are more powerful than non-parametric tests if the distributional assumptions hold; that is, the former require a smaller sample size than the latter to detect a significant difference of a given size. Moreover, parametric tests are more robust to deviations from Normality than are non-parametric tests to deviations from symmetry.

## Hypothesis testing versus estimation

Comparisons have traditionally been made by **testing** the null hypothesis using an appropriate significance test. However, such tests do not indicate the *magnitude* of the difference between groups that are being compared, with defined *precision*, and it is the magnitude that may be of interest (e.g., when assessing the

<sup>2</sup> Although visual analogue measurements are subjective, they can be treated as continuous data for the purpose of analysis.



**Table 14.1** Summary of some parametric statistical techniques for testing hypotheses relating to means of Normally distributed data.

Level of measurement	Variance	Parametric statistical test				Parametric measure of association	
		One-sample case	Two-sample case		Case with three or more samples		
			Related samples	Independent samples	Related samples		Independent samples
Interval and ratio	Known	Normal test	Normal test	Normal test		Correlation coefficient, $\rho^*$	
Interval and ratio	Unknown	t-test	t-test	t-test* (equal variance)	F-test (equal variance)	F-test (equal variance)	Correlation coefficient, $\rho^*$
				Welch t-test* (unequal variances)	Welch F-test (unequal variances)	Welch F-test (unequal variances)	

\* Indicates a technique that is exemplified in this book.

prophylactic or therapeutic impact of a compound in a clinical trial). An alternative approach, which **estimates** the difference with defined precision, therefore conveys more information, and is frequently preferred (Altman *et al.*, 2000). This involves calculating confidence intervals for the parameters that are being considered. Both approaches are outlined in this chapter.

### Sample size determination

The importance of determining appropriate sample sizes before undertaking an investigation was introduced in relation to surveys (Chapter 13). It is also desirable to determine sample sizes before two groups are compared. This ensures that results will be obtained according to specified parameters. These are:

- the acceptable level of Type I error,  $\alpha$  (the probability of inferring a difference between the groups when one does not exist);
- test power,  $1 - \beta$  (the probability of correctly inferring a difference);
- the magnitude of the difference to be detected (i.e., the difference between means, medians or proportions);
- the choice of alternative hypothesis: one-tailed or two-tailed;

and, additionally, for ordinal, interval and ratio response variables:

- the variability of the response variable between the two groups.

Conventionally,  $\alpha$  is set at 0.05 and  $\beta$  at 0.20 (power = 0.80), but these values may be different, depending

on inferential requirements. Unless there is strong evidence that a one-tailed test is justifiable, it is prudent to estimate sample sizes for two-tailed conditions because the latter require a larger sample size than the former for a specified value of  $\alpha$ , power and magnitude of the difference to be detected.

### Statistical versus clinical (biological) significance

Statistical significance tests give an indication of the probability that observed differences between groups are due to chance. **Clinical (biological)** significance, however, concerns the relevance of findings to clinical veterinary practice. Because statistical significance is partly dependent on sample size, it is possible that small and clinically unimportant differences may become statistically significant. It is also possible that clinically important results may be overlooked because a study's sample size is too small to allow sound conclusions to be drawn. For example, in a clinical study to compare the effect of diet on bilirubin levels in two groups of dogs, the sample sizes may be large enough to indicate statistical significance when the difference in means between the two groups is 2  $\mu\text{mol/l}$ . However, an investigator may judge a 2  $\mu\text{mol/l}$  change in means to be of no clinical relevance. In contrast, if the investigator considers a 1  $\mu\text{mol/l}$  change in means to be important to health, the sample sizes may not be large enough to conclude that the difference is significant. In this case, there is a serious risk of failing to recognize a genuine dietary effect. This is why the sample sizes for prospective studies should be justified (Lipsey, 1990).

**Table 14.2** Summary of some non-parametric statistical techniques.

Level of measurement	One-sample case	Non-parametric statistical test				Non-parametric measure of correlation
		Two-sample case		Case with three or more samples		
		Related/matched samples	Independent samples	Related samples	Independent samples	
Nominal	Binomial test	McNemar change test	Fisher exact test for $2 \times 2$ contingency tables*	Cochran $Q$ test	$\chi^2$ test for $r \times k$ tables	Cramer coefficient, $C$ Phi coefficient, $r_\phi$ The kappa coefficient of agreement, $K^*$
	$\chi^2$ goodness-of-fit test		$\chi^2$ test for: $2 \times 2$ contingency tables* $r \times 2$ contingency tables			Asymmetrical association, the lambda statistic, $L_B$
Ordinal	Kolmogorov–Smirnov one-sample test, $D_{m,n}$	Sign test	Median test		Extension of the median test	Spearman rank-order correlation coefficient, $r_s$
	One-sample runs test	Wilcoxon signed ranks test, $T^{**}$	Wilcoxon–Mann–Whitney test, $W_x^*$	Friedman two-way analysis of variance by ranks, $F_r$	Kruskal–Wallis one-way analysis of variance, $KW$	Kendall rank-order correlation coefficient, $T$
	Change-point test		Robust rank-order test, $U$	Page test for ordered alternatives, $L$	Jonckheere test for ordered alternatives, $J$	Kendall partial rank-order correlation coefficient, $T_{xy,z}$
			Kolmogorov–Smirnov two-sample test, $D_{m,n}$ Siegel–Tukey test for scale differences			Kendall coefficient of concordance, $W$ Kendall coefficient of agreement, $U$ Correlation between $k$ judges and a criterion, $T_c$
Interval and ratio	Test for distributional symmetry	Permutation test for paired replicates	Permutation test for two independent samples Moses rank-like test for scale differences			Gamma statistic, $G$ Somers' index of asymmetric association, $d_{BA}$

Each column lists, cumulatively downwards, the tests applicable for the given level of measurement. For example, in the case of three or more related samples, when the variables are measured on the ordinal scale, both the Friedman two-way analysis of variance and the Cochran  $Q$  test are applicable.

\* Indicates a technique that is exemplified in this book.

(Reprinted, with modifications, from Siegel, S. and Castellan, N.J., *Nonparametric Statistics for the Behavioral Sciences*, 2nd edn. Copyright © 1988 McGraw-Hill Inc., New York)

## Interval and ratio data: comparing means

### Hypothesis testing

#### Independent samples: Student's *t*-test

Student's *t*-test is a parametric significance test, commonly used for small samples. This involves calculation of a test statistic called *t*, which measures departures from the mean that is specified by the null hypothesis. The distribution of this test statistic follows a *t*-distribution (illustrated in Figure 12.4) – hence the name of the test.

Student's *t*-test can be applied to samples from different populations and a hypothesis that the data come from Normal distributions with a known difference  $\mu_1 - \mu_2 = \delta$  ('delta') between the two population means,  $\mu_1$  and  $\mu_2$ , and common unknown variance,  $\sigma^2$ . If  $n_1, \bar{x}_1, s_1^2$  are the sample size, sample mean and sample variance from the first population, and  $n_2, \bar{x}_2, s_2^2$  are similar statistics from the second population, then the estimate of the common unknown variance,  $\sigma^2$ , is:

$$\sigma^2 = \{(n_1 - 1)s_1^2 + (n_2 - 1)s_2^2\} / (n_1 + n_2 - 2).$$

The test statistic, *t*, is:

$$t = (\bar{x}_1 - \bar{x}_2 - \delta) / \sqrt{\{s^2(1/n_1 + 1/n_2)\}},$$

and there are  $n_1 + n_2 - 2$  degrees of freedom (see Chapter 12). (In this two-sample case, with sample sizes of  $n_1$  and  $n_2$ , two means are evaluated. There are thus  $n_1 + n_2 - 2$  'pieces' of information for calculation of the variance.)

This test is exemplified using the data in Table 12.1:

$$n_1 = 49; \bar{x}_1 = 5.76 \text{ kg}; s_1 = 0.60 \text{ kg};$$

$$n_2 = 49; \bar{x}_2 = 4.69 \text{ kg}; s_2 = 0.67 \text{ kg}.$$

The hypothesis to be tested is that there is no difference in 3-week weaning weights between the two groups of piglets; that is,  $\delta = 0$ .

$$\begin{aligned} s^2 &= \{(48 \times 0.60^2) + (48 \times 0.67^2)\} / 96 \\ &= (17.280 + 21.547) / 96 \\ &= 0.404. \end{aligned}$$

$$\begin{aligned} t &= (5.76 - 4.69 - 0) / \sqrt{\{0.404(1/49 + 1/49)\}} \\ &= 1.07 / \sqrt{0.0165} \\ &= 8.33. \end{aligned}$$

There are 96 degrees of freedom ( $49 + 49 - 2$ ). Appendix V is consulted. It does not have a row corresponding to 96 degrees of freedom, and so the row with the greatest number of degrees of freedom less than 96 is chosen (60 in this instance). This is a conservative procedure. The 0.1% value for 60 degrees of freedom is 3.460. This is considerably less than 8.33. Therefore, in this example, the two groups (A and B) of piglets have mean values that differ significantly at the

0.1% level. This is a two-tailed test for which Appendix V is directly applicable. However, if a one-tailed test is being conducted, the probability should be halved (the probability of a figure falling outside a certain value of *t* at one end, only, of a distribution is only half as great as the probability of it falling at either end).

Often, when sample sizes are large, the e.s.e.m.s are regarded as the true s.e.m.s and the *t*-test is conducted with degrees of freedom corresponding to infinity ( $\infty$ ). The test then becomes a **two-sample z-test**.

If the variances of the two samples are not equal, the test is modified as the **Welch *t*-test**, an example of which is presented in Chapter 17.

#### Related samples: Student's *t*-test

Student's *t*-test can also be applied to comparisons in which the observations between the two samples are related<sup>3</sup>. The test assumes that the difference between the members of each pair is Normally distributed with mean,  $\delta$  (usually zero), and an unknown variance,  $\sigma^2$ . If  $\bar{d}$  and  $s^2$  are the sample mean and variance of the **differences**, respectively, then the test statistic is:

$$t = (\bar{d} - \delta) / \sqrt{s^2/n},$$

where *n* is the sample size. There are (*n* - 1) degrees of freedom.

## Calculation of confidence intervals

### Independent samples

Confidence intervals can be calculated for the difference  $\mu_1 - \mu_2$  between the true population means for independent samples. The *t*-distribution is again used if the data have an approximately Normal distribution.

First, an estimate of the common standard deviation, *s*, is calculated:

$$s = \sqrt{\frac{(n_1 - 1)s_1^2 + (n_2 - 1)s_2^2}{n_1 + n_2 - 2}}$$

using the notation of Student's *t*-test.

The standard error of the difference between the two sample means,  $SE_{\text{diff}}$ , is then:

$$SE_{\text{diff}} = s \sqrt{1/n_1 + 1/n_2}.$$

Using the data in Table 12.1:

<sup>3</sup> Note, however, that the use of multiple *t*-tests to assess differences arising from serial measurements on the same individuals (e.g., blood glucose concentrations recorded several times after feeding) is incorrect, and other methods therefore should be used (Matthews *et al.*, 1990).

$$\begin{aligned}
 s &= \sqrt{\frac{(49-1)0.60^2 + (49-1)0.67^2}{49 + 49 - 2}} \\
 &= \sqrt{0.404} \\
 &= 0.636
 \end{aligned}$$

Therefore:

$$\begin{aligned}
 SE_{\text{diff}} &= 0.636\sqrt{1/49 + 1/49}, \\
 &= 0.128.
 \end{aligned}$$

A 95% confidence interval is calculated thus:

$$\bar{x}_1 - \bar{x}_2 \pm (t_{v(0.95)} \times SE_{\text{diff}}),$$

where  $t_{v(0.95)}$  is the 95% point of the  $t$ -distribution with  $v$  ('nu') degrees of freedom. This may be alternatively expressed as  $t_{v(1-\alpha)}$ , where  $\alpha$  is the level of significance. Consulting Appendix V, there are 96 degrees of freedom, and 60 is again chosen conservatively;  $t_{v(0.95)}$  is located in the column headed '0.05' ( $\alpha = 0.05$ ); this is 2.000 for 60 degrees of freedom.

$$\bar{x}_1 = 5.76,$$

$$\bar{x}_2 = 4.69.$$

The 95% confidence interval is therefore:

$$\begin{aligned}
 &(5.76 - 4.69) \pm (2.000 \times 0.128) \\
 &= 1.07 \pm 0.256 \\
 &= 0.81, 1.33.
 \end{aligned}$$

If the 95% confidence interval includes zero, the two means are not significantly different at the 5% level. In this example, the confidence interval **excludes** zero, and so a significant difference can be inferred at the 5% level. This result is consistent with the results of Student's  $t$ -test, which indicated a significant difference at the 1% (and therefore 5%) level.

Confidence intervals of 90%, 99% and 99.9% (corresponding to respective values of  $\alpha$  of 0.10, 0.01 and 0.001) can be calculated utilizing values of  $t_v$  of 1.671, 2.660 and 3.460.

Note that the confidence interval conveys more information than the result of the  $t$ -test. It gives an indication of the **precision** of the **magnitude** of the difference between the two means of the populations from which the samples were selected.

This method is not appropriate when the standard deviations of the two samples differ considerably; more complex methods must then be used (Armitage *et al.*, 2002).

### Related samples

Confidence intervals for related samples are calculated in the same way as those for a single sample (see Chapter 12), but  $\bar{x}$  and  $s$  are now the mean and standard

deviation of the individual **differences** between the first and second samples (Altman *et al.*, 2000).

### What sample size should be selected?

The approximate sample size required to detect the difference between the true means of two populations, using a two-tailed test at significance level  $\alpha$ , can be determined thus:

$$n = 2 \left\{ \frac{\sigma(M_{\alpha/2} + M_{\beta})}{\mu_1 - \mu_2} \right\}^2$$

where:

$n$  = sample size for each population;

$\mu_1$  = true mean in population 1;

$\mu_2$  = true mean in population 2;

$\sigma$  = common standard deviation of the two populations;

$M_{\alpha/2}$  = multiplier associated with the required significance level,  $\alpha$ ;

$M_{\beta}$  = multiplier associated with  $\beta$ , the probability of a Type II error.

For example, suppose that an investigator wishes to identify a difference in the mean day at which bacon pigs reach slaughter weight under two different systems of management, and that this difference is specified as a change of 5 days (i.e., the alternative hypothesis is two-tailed). An estimate of the mean day under the first system of management is required: say, day 160. Next, an estimate of the standard deviation is required. Previous production data indicates that this is approximately 7 days, and so this value is used as an estimate of the common standard deviation,  $\sigma$ . These estimates are then applied to the formula.

The two multipliers,  $M_{\alpha/2}$  and  $M_{\beta}$ , are obtained from Appendix XV. If the level of significance is set at 5%,  $\alpha = 0.05$ . The value of  $z$  corresponding to  $P = 0.025$  is 1.96; this is therefore chosen as the multiplier,  $M_{\alpha/2}$ . If the investigator wishes to be 80% confident of detecting this difference, test power  $(1 - \beta) = 0.80$ , and  $\beta = 0.20$ <sup>†</sup>. Consulting the Appendix again, the value of  $z$  corresponding to a probability of 0.20 is 0.84, and this is used as the multiplier  $M_{\beta}$ .

Therefore:

$$\begin{aligned}
 n &= 2\{7(1.96 + 0.84)/(160 - 165)\}^2 \\
 &= 2\{(7 \times 2.80)/-5\}^2 \\
 &= 2 \times 15.37 \\
 &= 30.7.
 \end{aligned}$$

Under the given error criteria, 62 pigs are therefore required: 31 under each system of management.

<sup>†</sup> Recall that  $\beta$  is conventionally set at four times the value of  $\alpha$ .

If one specific group were expected to have an *increase* over the other of 5 days in the mean day to slaughter, the alternative hypothesis would be one-tailed. The multiplier  $M_{\alpha/2}$  should then be replaced by  $M_{\alpha}$  in the appropriate formula. Thus, from the Appendix XV,  $z = 1.64$ , and  $M_{\alpha} = 1.64$ . This would require 50 pigs: 25 under each system of management. This exemplifies that two-tailed tests require a **larger** sample size than their one-tailed counterparts.

Note that, in addition to the nature of the alternative hypothesis, the sample size is determined by the difference between the two means, not their absolute values: the smaller the difference to be detected, the larger the required sample size. Additionally, a large common standard deviation (indicating considerable variability within the two groups) results in a large sample size.

This formula will slightly underestimate sample sizes for independent samples, and overestimate sample sizes for related samples.

## Ordinal data: comparing medians

### Hypothesis testing

#### Independent samples: the Wilcoxon–Mann–Whitney test

The **Wilcoxon–Mann–Whitney** test is used to compare two independent groups when at least ordinal measurement has been achieved for the study variables. It is also an appropriate test for interval and ratio data that are not Normally distributed.

Table 14.3a lists the summer body condition scores from samples of two groups of ponies on Assateague Island off the coast of Maryland, US. One group lives on the north of the island, and the other group lives on the south. The medians of the two samples are 2.5 and 3.5, respectively. The question posed is: ‘Do the body condition scores of north-end and south-end ponies differ significantly?’ (i.e., the test is two-tailed). Body condition score is an ordinal measurement, and the two groups of ponies are independent; therefore the Wilcoxon–Mann–Whitney test is appropriate.

The test is based on **ranking** of the scores, and tests the null hypothesis that the median values of each group are the same; the alternative hypothesis being that either (1) the median of one group is greater than the other, or vice versa (a two-tailed test), or (2) the median of one specified group is greater than the other (a one-tailed test).

First, the smallest group,  $X$ , of size  $m$ , is selected. If both groups are of equal size, as in this example, then either can be chosen (say, the north-end ponies). The

**Table 14.3** Summer body condition scores of feral ponies on the northern and southern parts of Assateague Island, 1988: (a) scores for 10 ponies; (b) scores and ranks for 44 ponies. (From Rudman and Keiper, 1991; raw data supplied by the authors.)

(a)

North-end ponies Score	South-end ponies Score
1	2
2.5	3.5
3	4
2.5	3.5
4	3

(b)

North-end ponies		South-end ponies	
Score	Rank	Score	Rank
3	35	4	44
3	35	3	35
2.5	22	3	35
2.5	22	3.5	43
1	2.5	1	2.5
2.5	22	3	35
2	11	1	2.5
2	11	3	35
2	11	3	35
2.5	22	3	35
2.5	22	2.5	22
2	11	2	11
2	11	2.5	22
2	11	2.5	22
1.5	5	2.5	22
3	35	2.5	22
2	11	2	11
3	35	2.5	22
		2.5	22
		2.5	22
Total	$W_x = 367.5$		$W_y = 622.5$

value of the statistic used in the test,  $W_x$ , is the sum of the ranks in this group.

The scores in group  $X$  and the other group,  $Y$  of size  $n$  (south-end ponies), are then ranked in order of increasing size, retaining their identity. Scores are relatively crude measures, usually with a limited range, and so samples may include two or more individuals with the same scores. Identical scores constitute **ties**. The rank given to such ties is the average of the tied ranks that would have been assigned if the scores had differed slightly. For example, if three individuals are given the lowest score, then they are each assigned the rank of 2, that is,  $(1 + 2 + 3)/3$ . The next score would

then be ranked 4. If the lowest score was shared by two individuals, they would each be ranked 1.5  $([1 + 2]/2)$  and the next score would be ranked 3.

The scores and ranks of the ponies are therefore:

Score:	1	2	2.5	2.5	3	3	3.5	3.5	4	4
Group:	X	Y	X	X	X	Y	Y	Y	X	Y
Rank:	1	2	3.5	3.5	5.5	5.5	7.5	7.5	9.5	9.5

The sum of the ranks is then calculated for the first group:

$$W_x = 1 + 3.5 + 3.5 + 5.5 + 9.5 = 23;$$

and similarly for the second group:

$$W_y = 2 + 5.5 + 7.5 + 7.5 + 9.5 = 32.$$

The total sample size,  $N = m + n = 10$ .

If there were no difference between the two groups, then the average ranks of each group would be about the same. However, if there were a difference, then the average ranks would not be the same. In this example, the average rank of group X is  $23/5 = 4.6$ , and the average rank of group Y is  $32/5 = 6.4$ , and so there is reason to suspect a difference.

The sampling distribution of  $W_x$  under the null hypothesis is given in Appendix XVI. This is used to determine the significance of the result, using the values  $W_x$ ,  $m$  and  $n$ . The lower limit is used for observations at the lower end of the distribution. The table appropriate to the values  $m = 5$  and  $n = 5$  is selected, and the probability of observing a value of  $W_x < 23$  when the null hypothesis is true is located by finding the entry to the right of the lower critical limit,  $c_L$ , with a value equal to  $W_x$  (i.e., 23). This (one-tailed) probability is 0.2103. Thus, in a two-tailed test (as in this example), the probability is doubled (0.420); this is considerably greater than 0.05 and so the result is not significant at the 5% level.

If  $W_y$  had been chosen to determine the significance of the results, the upper limit is used for observations at the upper end of the distribution. Thus, the probability of observing a value of  $W_y > 32$  is similarly 0.2103, and the same conclusion is reached.

**Large samples** Appendix XVI can only be used when  $m$  and  $n$  are less than 11 ( $n < 13$  if  $m = 3$  or 4). For larger values of  $m$  and  $n$ , however, the sampling distribution of  $W_x$  is approximately Normal. It is therefore possible to use Appendix XV to assess the significance of any observed differences between large samples.

A value of the standardized Normal deviate,  $z$ , can be calculated using the formula:

$$z = \frac{W_x + 0.5 - m(N + 1)/2}{\sqrt{mn(N + 1)/12}}$$

using the same notation as above.

The value 0.5 is added when looking at the lower end of the distribution, and subtracted when considering the upper end.

Table 14.3b lists a larger number of records of scores of ponies on Assateague Island than Table 14.3a. The median score values for north-end and south-end ponies are 2.5 and 3.0, respectively, and the significance of this sample difference can again be assessed. The total number is too great to be accommodated by Appendix XVI and so Appendix XV should be used. There are also ties, which are accommodated by the ranking given in the table.

The average of the ranks for the north-end ponies is  $367.5/20 = 18.4$ , whereas the average for the south-end ponies is 25.9, also suggesting that the latter are in better condition in the summer than the former.

$$W_x = 367.5,$$

$$m \text{ (north-end ponies)} = 20,$$

$$n \text{ (south-end ponies)} = 24,$$

$$N = m + n = 44.$$

These values are substituted into the formula, adding the value 0.5 (because  $W_x$  is associated with the average rank of the smaller group, hence the lower end of the distribution is being considered), and the alternative hypothesis is again two-tailed:

$$\begin{aligned} z &= \frac{367.5 + 0.5 - 20(44 + 1)/2}{\sqrt{20 \times 24(44 + 1)/12}} \\ &= \frac{367.5 + 0.5 - 450}{\sqrt{1800}} \\ &= -1.93. \end{aligned}$$

The calculated value of  $z$  is negative, corresponding to the lower tail of the Normal distribution. Appendix XV tabulates only the upper tail, and so the sign is ignored. The value 1.93 corresponds to a one-tailed  $P$  value of 0.0268 (a two-tailed  $P$  value of 0.0536), and indicates that the observed condition scores between the two groups are not significantly different at the 5% level ( $P > 0.05$ ). Note, however, the prudence of quoting the  $P$  value in view of it being so close to the 5% significance level.

### Related samples: the Wilcoxon signed ranks test

Related samples can be compared using the **Wilcoxon signed ranks test**. This tests a similar hypothesis to its unpaired analogue, described above.

Table 14.4a lists the body condition scores of a group of seven sheep recorded in the summer and then again in the winter. These therefore constitute related samples. The median summer and winter scores are

**Table 14.4** Winter and summer body condition scores of sheep: (a) scores and ranks for seven sheep; (b) scores and ranks for 25 sheep. (Hypothetical data.)

(a)

Sheep no.	Winter score	Summer score	Difference in scores (summer–winter)	Rank of difference
1	3.5	5	1.5	5.5
2	3.5	4	0.5	2
3	3	4	1	4
4	3.5	4	0.5	2
5	3.5	3.5	0	–
6	3.5	3	–0.5	–2
7	3.5	5	1.5	5.5

(b)

Sheep no.	Winter score	Summer score	Difference in scores (summer–winter)	Rank of difference
1	4.5	3	–1.5	–19
2	4	3.5	–0.5	–6.5
3	2.5	3.5	1	15
4	3	3.5	0.5	6.5
5	3	3	0	–
6	3	3.5	–0.5	–6.5
7	5	4	–1	–15
8	4.5	5	0.5	6.5
9	2	2.5	0.5	6.5
10	4.5	5	0.5	6.5
11	2	3.5	1.5	19
12	2.5	3	0.5	6.5
13	4	4.5	0.5	6.5
14	4	4	0	–
15	2.5	3.5	1	15
16	3	3.5	0.5	6.5
17	2	4.5	2.5	22
18	2.5	2.5	0	–
19	3.5	4.5	1	15
20	4	4.5	0.5	6.5
21	3.5	4.5	1	15
22	2.5	4.5	2	21
23	4	4.5	0.5	6.5
24	3	4.5	1.5	19
25	3.5	4	0.5	6.5

$T^+ = 212.0$

4.0 and 3.5, respectively. It is reasonable to assume that scores are likely to be higher in the summer than the winter – not vice versa – and so the alternative hypothesis is one-tailed. To perform a Wilcoxon signed ranks test to assess the significance of these sample differences, the *differences* between the paired observations are determined; then the differences are ranked, without reference to sign. If there is no difference between a pair, that is, there is a tie with the value zero (e.g., sheep number 5 in *Table 14.4a*), the pair is excluded from further analysis. Ties not taking the value zero are ranked in the same way as in the Wilcoxon–Mann–Whitney test. The sign (+ or –) that the differ-

ence represents is then attached to each rank. Next, the sum of the positive ranks,  $T^+$ , is calculated. The ranking of the differences in the sheep body condition scores is listed in *Table 14.4a*, and:

$$T^+ = 5.5 + 2 + 4 + 2 + 5.5 \\ = 19.$$

Appendix XVII is then consulted. This gives the corresponding one-tailed significance levels for  $T^+$  and the sample size,  $N$ , for pairs with non-zero differences. In this example,  $N = 6$  and  $T^+ = 19$ . The table entry for this combination is 0.0469. This is less than 0.05, indicating that there is a significant difference between median

summer and winter condition scores. (If the alternative hypothesis were two-tailed, the significance level would be 0.094, and the difference would not be significant at the 5% level.)

**Large samples** Appendix XVII cannot be used when  $N$  is larger than 15, but the sampling distribution of  $T^+$  is then approximately Normally distributed, and:

$$z = \frac{T^+ - N(N + 1)/4}{\sqrt{N(N + 1)(2N + 1)/24}}$$

Table 14.4b lists the winter and summer condition scores for 25 sheep, with medians of 3.0 and 4.0, respectively. Sheep 5, 14 and 18 have no difference in winter and summer scores and so are not considered further; thus  $N = 22$ , and  $T^+ = 212.0$ .

Thus:

$$\begin{aligned} z &= \frac{212.0 - 22(22 + 1)/4}{\sqrt{22(22 + 1)(2 \times 22 + 1)/24}} \\ &= \frac{85.5}{\sqrt{948.75}} = 2.78. \end{aligned}$$

Appendix XV is consulted, and the alternative hypothesis is again one-tailed. The probability of obtaining a value of 2.78 if the null hypothesis were true is 0.0027. Thus, a significant difference between the summer and winter median condition scores can be inferred.

### Calculation of confidence intervals

Confidence intervals for the difference between two medians can be calculated on the assumption that the two samples have frequency distributions that are identical in shape, but differ in location.

### Independent samples

If there are  $n_1$  and  $n_2$  observations in the two respective samples, the difference between the two medians is first estimated as the median of all possible  $n_1 \times n_2$  differences. The differences for the data in Table 14.3a are given in Table 14.5.

**Table 14.5** Difference in condition scores of two groups of ponies. (Data from Table 14.3a.)

South-end ponies	North-end ponies				
	1	2.5	2.5	3	4
2	-1	0.5	0.5	1	2
3	-2	-0.5	-0.5	0	1
3.5	-2.5	-1	-1	-0.5	0.5
4	-3	-1.5	-1.5	-1	0

The differences are then sorted:

-3 -2.5 -2.5 -2 -1.5 -1.5 -1 -1 -1 -1 -1 -1 -0.5 -0.5 -0.5 -0.5 0 0 0.5 0.5 0.5 0.5 1 1 2.

The point estimate of the median is thus -0.5.

A parameter,  $K$ , based on the Wilcoxon–Mann–Whitney test statistic, is then calculated (Altman *et al.*, 2000). This is tabulated for 95% confidence limits in Appendix XVIII for sample sizes between 5 and 25. The value of  $K$  for appropriate values of  $n_1 = 5$  (north-end ponies) and  $n_2 = 5$  (south-end ponies) is identified; this is 3. The approximate 95% limits are then the **third** smallest and **third** largest difference: -2.5 and 1, respectively. The 95% confidence interval therefore contains the value zero, and so a significant difference between condition scores cannot be inferred at the 5% level. This is in accord with the result of Wilcoxon–Mann–Whitney test.

Altman *et al.* (2000) give appropriate values of  $K$  for determining 90% and 99% confidence intervals.

**Large samples** When each sample size is greater than 25, an approximate value of  $K$  for a 95% confidence interval, based on the Normal-approximation multiplier, is:

$$K = \frac{n_1 n_2}{2} - \left\{ 1.96 \sqrt{\frac{n_1 n_2 (n_1 + n_2 + 1)}{12}} \right\}$$

rounding  $K$  up to the nearest integer.

### Related samples

Confidence intervals for related samples are calculated in a similar way to those for unrelated samples. If there are  $n$  differences for all matched pairs, the averages of all possible differences are calculated, including each difference with itself. For example, in Table 14.4b, the average of the difference of sheep number 1 with itself is  $(-1.5 - 1.5)/2 = -1.5$ ; the average of the difference of sheep number 1 with sheep number 2 is  $(-1.5 - 0.5)/2 = -1$ ; and so on:

	Change			
Change	-1.5	-0.5	1	0.5
-1.5	-1.5	-1	-0.25	-0.5
-0.5		-0.5	0.25	0
1			1	0.75
0.5				0.5

These differences are again sorted, and the point estimate of the median identified. A parameter,  $K^*$ , based on the Wilcoxon signed ranks test statistic, is then calculated (Altman *et al.*, 2000). This is tabulated in Appendix XIX for 95% confidence limits for sample sizes,  $n$ , between 6 and 50. The value of  $K^*$  is applied to



the sorted differences in the same way as  $K$ , previously. Altman *et al.* (2000) give appropriate values of  $K^*$  for determining 90% and 99% confidence intervals.

**Large samples** When each sample size is greater than 50, an approximate value of  $K^*$  for a 95% confidence interval is:

$$K^* = \frac{n(n+1)}{4} - \left\{ 1.96 \sqrt{\frac{n(n+1)(2n+1)}{24}} \right\}$$

rounding  $K^*$  up to the nearest integer.

What sample size should be selected?

The calculation of sample sizes for the comparison of two sets of ordinal data is not simple (Campbell *et al.*, 1995). One method, involving some pragmatic simplification, will be described and exemplified.

First, an indication of the frequency distribution of the scores in each of the two groups is needed. This requires data from an earlier study (e.g., a 'pilot' study). The values in the two unrelated samples in *Table 14.3b* will be used in the worked example that follows.

A sufficiently large 'pilot' sample and number of score categories may allow the data to be considered as Normally distributed. Therefore, sample size can be computed using the formula for comparing two means, described earlier, but with an increase in sample size to account for the inefficiency of the Wilcoxon–Mann–Whitney test, relative to Student's  $t$ -test ( $3/\pi$ , i.e., about 95%: Lehmann and D'Abrera, 1975). The two histograms of the north-end ponies and south-end ponies in *Table 14.3b* reveal distributions that are approximately Normal. The means and standard deviations of the two groups are 2.275, 0.525 and 2.583, 0.761, respectively. Using the formula for determining sample size for detecting a difference between two means, described earlier in this chapter, with:  $\mu_1 = 2.275$ ,  $\mu_2 = 2.583$ ,

$$\begin{aligned} \sigma &= \sqrt{\frac{0.525^2 + 0.761^2}{2}} \\ &= 0.654 \end{aligned}$$

(the standard deviation based on the average of the two variances),  $\alpha = 5\%$ , and power = 80%, the required sample size is 73 animals in each group. This is multiplied by  $\pi/3$ , to compensate for the inefficiency of the Wilcoxon–Mann–Whitney test, giving 77 animals in each group.

A second, more precise, method, considers the difference between the two samples in relative, rather than absolute, terms (Campbell *et al.*, 1995; Julious and

Campbell, 1998). However, the calculations are more detailed, and are not suitable for all data sets. (The calculations are eased, however, by the availability of appropriate software such as *nQuery Advisor*: see Appendix III<sup>4</sup>.)

## Nominal data: comparing proportions

Counts of nominal data are the basis of comparison of proportions and are commonly encountered in observational studies. Some general methods are outlined in this chapter. Additional techniques, particularly relevant to observational studies, are described in the next chapter.

## Hypothesis testing

### Independent samples: the $\chi^2$ test of association

The results of an investigation of physiological urinary incontinence (PUI) in bitches are recorded in *Table 14.6*. The question being asked was 'Does an association exist between the development of PUI and spaying?' The investigators categorized dogs into those with the PUI that were spayed, those with PUI that were not spayed, those without PUI that were spayed and those without PUI that were not spayed. These four permutations allow the construction of a two-way table with four 'cells' in it, called a  $2 \times 2$  contingency table.

The values in the table need to be assessed. A simple method of assessment would be to express the values in each row as percentages of the total of each row. If each row showed similar percentages, this would imply that the row classification did not affect the column classification – that there was no association between the two classifications. This reasoning is sound, but requires large numbers, otherwise sampling variation could affect the result. Taking the data in *Table 14.6*, the percentage of those animals that were spayed and have PUI is 4.3% (34/791); the percentage of those that were not spayed and have PUI is 0.3% (7/2434). This difference could be significant, but it could also merely result from the variation induced by selection of a relatively small sample of the total population at risk.

A common way of conducting a test on these data is to calculate a non-parametric test statistic for independent samples called  $\chi^2$  ( $\chi$  is the Greek letter chi).

<sup>4</sup> Indeed, most sample-size calculations can be routinely undertaken using software. Many statistical packages offer limited sample-size options (see Appendix III), and some dedicated software packages, such as *nQuery Advisor*, offer comprehensive facilities. In many studies (e.g., clinical trials: see Chapter 16), it is regarded as good practice to consult such software.

**Table 14.6** Cumulative incidence of physiological urinary incontinence (excluding congenital incontinence) in spayed and entire bitches 6 months of age and older (period of observation = 7 years; the numbers in each cell reflect the proportions of continent and incontinent animals, and spayed and entire animals, in the population from which the sample was drawn.) (Hypothetical data.)

	Urinary incontinence present	Urinary incontinence absent	Totals
Spayed	34 (a)	757 (b)	791 (a + b)
Entire	7 (c)	2427 (d)	2434 (c + d)
Totals	41 (a + c)	3184 (b + d)	3225 (n)

The distribution followed by this statistic is known as the  $\chi^2$ -distribution. This statistic indicates the extent to which the observed values in the cells diverge from the values that would be expected if there were no association between row and column categories. A table of the  $\chi^2$ -distribution is then consulted to decide whether the observed  $\chi^2$  value is larger than that which would be expected, based on a null hypothesis postulating no association.

This example involves only a 2 × 2 contingency table, and the  $\chi^2$  equation below is simplified to refer only to this type of table. The test can also be performed on contingency tables with several rows and columns, that is, with several categories (Bailey, 1995).

The  $\chi^2$  statistic is given by:

$$\chi^2 = \frac{n(|ad - bc| - n/2)^2}{(a + b)(c + d)(a + c)(b + d)}$$

where  $n/2$  is a continuity correction for 2 × 2 contingency tables, to improve the approximation, because  $\chi^2$  is a continuous distribution, yet the data (numbers of animals), and therefore the test statistic, are discrete. The vertical bars, | |, are **moduli**. They indicate the absolute value of  $ad - bc$ ; that is, the positive value of the difference is always used.

Using the values in Table 14.6:

$$\begin{aligned} \chi^2 &= \frac{3225(|82\,518 - 5299| - (3255/2))^2}{791 \times 2434 \times 41 \times 3184} \\ &= 73.35. \end{aligned}$$

Percentage points of the  $\chi^2$  distribution are given in Appendix IX for various significance levels and degrees of freedom. As a rule, the degrees of freedom,  $\nu$ , (upsilon) to be selected are given by:

$$\nu = (\text{number of rows} - 1) \times (\text{number of columns} - 1)$$

which, in this example, is:

$$(2 - 1) \times (2 - 1) = 1.$$

In a 2 × 2 table, where the row and column totals are all known, knowledge of **one** of the values in the four

cells in the body of the table immediately implies knowledge of the values in the other three cells. Similarly in a table with  $r$  rows and  $k$  columns, with the row and column totals all known, the knowledge of  $(r - 1) \times (k - 1)$  of the values in the  $rk$  cells in the body of the table implies knowledge of the values in the other cells. This is the idea behind degrees of freedom in contingency tables; namely, the freedom to choose the values in the body of a contingency table when the row and column totals are fixed.

Consulting row 1 (1 degree of freedom) of Appendix IX, the observed value, 73.35, is greater than the tabulated statistic at the 5% level of significance (3.841) and so an association can be inferred between spaying and PUI. Note that, in this example, the result is also significant at the 1% and 0.1% levels.

**Independent samples: Fisher’s exact test**

Sometimes sample sizes are limited, resulting in small numbers in some of the cells of a 2 × 2 contingency table. If, on the assumption that there is no difference between the groups being compared, one expected cell value is less than 5, the  $\chi^2$ -test is not reliable, and a different test – **Fisher’s exact test** – should be used. (Note that the  $\chi^2$ -test can be applied when some observed values are less than 5, as long as all *expected* values exceed 5.)

Table 14.7 presents the same disease/factor relationship as that presented in Table 14.6, but with smaller numbers. The expected values are calculated, on the assumption that there is no difference between the two groups, by considering the marginal totals. The proportion of animals with PUI is then:

$$\begin{aligned} &(a + c)/n, \\ &= \frac{9}{772} \\ &= 0.0117. \end{aligned}$$

This proportion can then be applied to each row separately to estimate the expected cell values. For spayed animals, the expected number of animals with PUI is  $0.0117 \times 128 = 1.5$ .

**Table 14.7** Cumulative incidence of physiological urinary incontinence (excluding congenital incontinence) in spayed and entire bitches 6 months of age and older (period of observation = 7 years). (Hypothetical data.)

	Urinary incontinence present	Urinary incontinence absent	Total
Spayed	7 (a)	121 (b)	128 (a + b = $r_1$ )
Entire	2 (c)	642 (d)	644 (c + d = $r_2$ )
Total	9 (a + c = $n_1$ )	763 (b + d = $n_2$ )	772 (n)

For entire animals, the expected number of animals with PUI is  $0.0117 \times 644 = 7.5$ .

The first expected value is less than 5, indicating that the  $\chi^2$ -test is inappropriate and that Fisher's exact test should therefore be used.

Fisher's exact test calculates the  $P$  value associated with the observed contingency table on the hypothesis that there is no difference between the two population proportions. This is performed by summing the probability of occurrence of the observed table and of all tables that have the same marginal totals ( $r_1, r_2, n_1$  and  $n_2$ ), but are as extreme as, or more extreme than, it is. This is a one-tailed formulation.

First, choose the cell entry over which to sum to be the smallest of the four entries,  $c^*$ . In this example,  $c^* = c = 2$ . The formula for  $P$  is then:

$$\sum_{c=0}^{c^*} \left\{ \frac{r_1! r_2! n_1! n_2!}{n_1! a! b! c! d!} \right\}$$

Similar expressions can be derived if  $a, b$ , or  $d$  is the smallest entry.

As  $c^*$  varies from 0 to 2, the other values ( $a, b$  and  $d$ ) vary also:

$c^*$	$a$	$b$	$d$
2	$a + c - 2$	$b - c + 2$	$c + d - 2$
1	$a + c - 1$	$b - c + 2$	$c + d - 1$
0	$a + c$	$b - c$	$c + d$

Thus, when  $c^* = 2$ , the contribution to  $P$  is:

$$\frac{(7 + 121)!(2 + 642)!(7 + 2)!(121 + 642)!}{772! \times 7! \times 121! \times 2! \times 642!}$$

Most pocket calculators will compute factorials up to about 70!, but, for larger values (as in this example), calculations are best performed using logarithms. Logarithms of factorials up to 999! are given in Appendix XX. From this appendix:

$$\begin{aligned} & (\log 128! + \log 644! + \log 9! + \log 763!) \\ & - (\log 772! + \log 7! + \log 121! + \log 2! + \log 642!) \\ & = (215.586\ 16 + 1531.040\ 44 + 5.559\ 76 + 1869.839\ 94) \\ & - (1895.808\ 16 + 3.702\ 43 + 200.908\ 18 + 0.301\ 03 \\ & + 1525.423\ 34) \\ & = 3622.0263 - 3626.143\ 14 \\ & = -4.116\ 84. \end{aligned}$$

Thus, the contribution to  $P = \text{antilog}^{\dagger} - 4.116\ 84 = 0.000\ 076$ .

<sup>†</sup> Antilogarithms can be obtained from a pocket calculator.  $\text{Antilog}_{10} x = 10^x$ . Most calculators have a '10<sup>x</sup>' function key, which therefore can be used to compute antilogarithms to the base 10. Thus,  $\text{antilog}_{10} -4.116\ 84 = 10^{-4.116\ 84} = 1/10^{4.116\ 84} = 0.000\ 076\ 41$ .

When  $c^* = 1$ , the contribution to  $P$  is:

$$\frac{(7 + 121)!(2 + 642)!(7 + 2)!(121 + 642)!}{772! \times 8! \times 120! \times 1! \times 643} = 0.000\ 003\ 6.$$

When  $c^* = 0$ , the contribution to  $P$  is:

$$\frac{(7 + 121)!(2 + 642)!(7 + 2)!(121 + 642)!}{772! \times 9! \times 119! \times 0! \times 644!} = 0.000\ 000\ 074.$$

The  $P$  value is therefore:

$$0.000\ 076 + 0.000\ 003\ 6 + 0.000\ 000\ 074 = 0.000\ 079\ 7.$$

The result therefore is significant at the 0.01% level ( $P < 0.0001$ ), and again indicates that an association can be inferred between spaying and PUI.

There is also a two-tailed formulation of Fisher's exact text (Siegel and Castellan, 1988), but many authors advocate simply doubling the one-tailed  $P$  value (Armitage *et al.*, 2002). The test can also be generalized to tables with more than two rows and columns (Mehta and Patel, 1983).

### Related samples: McNemar's change test

A modification of the  $\chi^2$  test – **McNemar's change test** – can be applied to related samples. *Table 14.8* summarizes the possible results of two related samples, '+' denoting presence of a characteristic, and '-' its absence. This table could be generated, for example, by matching spayed (sample 1) and entire (sample 2) bitches with respect to breed and age, and then recording the cumulative incidence of PUI. The two samples would then comprise matched pairs of dogs.

The modified  $\chi^2$  formula only uses the values that are not in agreement between the two tests, that is, values from discordant pairs:

$$\chi^2 = \frac{(|s + t| - 1)^2}{s + t}$$

with one degree of freedom. The value of  $\chi^2$  obtained is interpreted by consulting Appendix IX.

**Table 14.8** Possible outcomes of two related samples: (+) feature present, (-) feature absent.

Sample 1	Sample 2	Number of individuals
+	+	$r$
+	-	$s$
-	+	$t$
-	-	$u$
<i>Total</i>		$n$

## Calculation of confidence intervals

### Independent samples

Confidence intervals can be calculated for the difference between two unrelated proportions, and the interpretation is similar to that of confidence intervals for the difference between two means and two medians, which have already been described.

First, the standard error of the difference,  $SE_{\text{diff}}$ , is calculated:

$$SE_{\text{diff}} = \sqrt{\frac{\hat{p}_1(1 - \hat{p}_1)}{n_1} + \frac{\hat{p}_2(1 - \hat{p}_2)}{n_2}}$$

where:

$\hat{p}_1$  = estimated proportion of individuals with a feature in group 1;

$\hat{p}_2$  = estimated proportion of individuals with a feature in group 2;

$n_1$  = number of individuals in group 1;

$n_2$  = number of individuals in group 2.

Applying this formula to the data in *Table 4.10a* relating to the crude leptospiral seroprevalence in samples of dogs in Glasgow and Edinburgh:

$\hat{p}_1$  = estimated proportion of seropositive dogs in Glasgow  
= 69/251,  
= 0.275.

$\hat{p}_2$  = estimated proportion of seropositive dogs in Edinburgh  
= 61/260,  
= 0.235.

$n_1$  = 251.

$n_2$  = 260.

Thus:

$$\hat{p}_1 - \hat{p}_2 = 0.275 - 0.235 = 0.04;$$

and:

$$\begin{aligned} SE_{\text{diff}} &= \sqrt{\frac{0.275(1 - 0.275)}{251} + \frac{0.235(1 - 0.235)}{260}} \\ &= \sqrt{0.00079 + 0.00069} \\ &= 0.038. \end{aligned}$$

A 95% confidence interval can then be calculated:

$$\begin{aligned} &(\hat{p}_1 - \hat{p}_2) \pm 1.96 \times SE_{\text{diff}} \\ &= 0.04 \pm 1.96 \times 0.038 \\ &= -0.034, 0.115. \end{aligned}$$

This confidence interval includes zero; thus a significant difference cannot be inferred at the 5% level.

This formula is based on the Normal approximation

to the binomial distribution, and only gives approximate values when the sizes of each group are less than 30, and  $p$  is greater than 0.9 or less than 0.1. (For this reason, this formula should not, for example, be applied to the data in *Table 14.6*, where the two values of  $p$  are 0.043 and 0.003.) If exact confidence intervals are required, more complex methods should be used (Armitage *et al.*, 2002).

### Related samples

Confidence intervals can be calculated for related samples. Using the notation in *Table 14.8*:

proportion positive in the first sample,  $\hat{p}_1 = (r + s)/n$ ;

proportion positive in the second sample,  $\hat{p}_2 = (r + t)/n$ .

The difference between  $\hat{p}_1$  and  $\hat{p}_2 = (s - t)/n$ .

The standard error of this difference is then:

$$SE_{\text{diff}} = \frac{1}{n} \sqrt{s + t - \frac{(s - t)^2}{n}}$$

and the 95% confidence interval is  $(\hat{p}_1 - \hat{p}_2) \pm 1.96 \times SE_{\text{diff}}$ .

Exact methods should again be employed if sample sizes are small (Armitage *et al.*, 2002).

### What sample size should be selected?

The approximate sample size required to detect a difference between two proportions (i.e., a two-tailed test) is obtained from the formula:

$$n = \frac{\{M_{\alpha/2} \sqrt{2p(1-p)} + M_{\beta} \sqrt{\hat{p}_1(1-\hat{p}_1) + \hat{p}_2(1-\hat{p}_2)}\}^2}{(\hat{p}_2 - \hat{p}_1)^2}$$

where:

$n$  = sample size for each population;

$p_1$  = true proportion in population 1;

$p_2$  = true proportion in population 2;

$p$  =  $(p_1 + p_2)/2$ ;

$M_{\alpha/2}$  = multiplier associated with the required significance level,  $\alpha$ ;

$M_{\beta}$  = multiplier associated with  $\beta$ , the probability of a Type II error.

A common one-tailed situation is demonstration that a specified group responds better than another; for example, when a vaccinated group is compared with an unvaccinated one. For instance, suppose that the annual prevalence of foot-rot in sheep is expected to be approximately 20%, and an investigator wishes to examine the performance of a new vaccine by demonstrating that it can reduce the prevalence by 5%. A flock of sheep is divided into two groups, one of which is vaccinated, and one of which is not vaccinated. Therefore,  $p_1 = 0.20$  and  $p_2 = 0.15$  (the value for the

**Table 14.9** Numbers of dairy herds affected by bovine spongiform encephalopathy according to herd size, Northern Ireland, 1988–90. (From Denny *et al.*, 1992. Crown Copyright 1992. Produced by the Central Veterinary Laboratory.)

Herd size (number of adult cows)	Number of affected herds	Number of herds at risk	Percentage of affected herds
1–49	47	4802	1.0
50–99	49	1627	3.0
100–199	24	346	6.9
≥200	5	28	17.9
Total	125	6803	

anticipated prevalence if there is a 5% reduction). If the level of significance is set at 5%,  $\alpha = 0.05$  and, from Appendix XV,  $M_\alpha = 1.64$  (because the hypothesis is one-tailed). If the investigator wishes to be 80% confident of detecting this difference, test power  $(1 - \beta) = 0.80$ ,  $\beta = 0.20$ , and  $M_\beta = 0.84$ .

Therefore  $p = (0.20 + 0.15)/2 = 0.175$ ; and:

$$n = \frac{\{1.64\sqrt{2 \times 0.175(1 - 0.175)} + 0.84\sqrt{0.20(1 - 0.20) + 0.15(1 - 0.15)}\}^2}{(0.15 - 0.20)^2}$$

$$= \frac{(1.64\sqrt{0.289} + 0.84\sqrt{0.16 + 0.128})^2}{-0.05^2}$$

$$= 710.8.$$

Thus, a total of 1422 animals is required: 711 in each group.

The sample size depends on the magnitude of the difference to be detected; the greater the magnitude, the smaller the sample size. Thus, the sample of 711 animals per group will detect a difference in annual prevalence of 5% or greater between the two groups.

This formula will slightly underestimate sample sizes for independent samples, and overestimate sample sizes for related samples.

## $\chi^2$ test for trend

Sometimes a hypothesized causal factor may have a **number** of ordered categories. For instance, herd size may be the factor under consideration, and herds may be divided into several categories according their size. In such circumstances, the 'method of concomitant variation' (see Chapter 3) can be used to infer an association, and an appropriate technique for assessing the statistical significance of the association is **the  $\chi^2$  test for trend** (Mantel, 1963). This test yields a  $\chi^2$  statistic on one degree of freedom, which tests for a linear trend over the ordered categories. The categories may be represented by scores which can be numbers taken as the mid-point of each category (e.g., representing a

herd size of 100–200 animals by '150'), by a variation of it, such as its logarithm, or by imprecisely defined, but ordered, arbitrary values, such as 0, 1, 2, . . .

The test statistic is:

$$\chi^2 = \frac{T^2(T-1)\{\sum x(a-E)\}^2}{M_1 M_0 \{T \sum x^2 N - (\sum x N)^2\}}$$

where:

$T$  = total number of individuals in all score categories;

$x$  = score value;

$a$  = observed number of affected individuals in each score category;

$M_1$  = total number of affected individuals;

$M_0$  = total number of unaffected individuals;

$N$  = number of individuals in each score category;

$E$  = expected number of affected individuals in each score category =  $NM_1/T$ .

Table 14.9 presents the results of a study of bovine spongiform encephalopathy (BSE) in Northern Ireland. The percentage of affected herds increases with herd size. The  $\chi^2$  test for trend can be applied to these results to assess the statistical significance of this apparent trend. (Note that in this example **herds**, not single animals, are the units of concern<sup>5</sup>.)

The herd sizes 1–49, 50–99, 100–199 ( $x_1 \dots x_3$ ) are scored as their mid-point values, 25, 75 and 150, respectively. The herd size, >200 ( $x_4$ ), is arbitrarily scored as 250.

$$T = 6803,$$

$$M_1 = 125,$$

$$M_0 = 6803 - 125, \\ = 6678.$$

For  $x_1$ , the expected value of the number of affected individuals,  $E_1 = 4802 \times 125/6803 = 88.23$ ; and for  $x_2, \dots x_4$ ,  $E_2, \dots E_4 = 29.90, 6.36, 0.52$ , respectively.

<sup>5</sup> For a further example of a herd-level analysis, see Martin *et al.* (1997), who assess the relationship between bovine tuberculosis status and distance of herds from badger setts.

Thus:

$$T^2(T-1) = 6803^2 \times 6802, \\ = 3.15 \times 10^{11}.$$

$$\{\sum x(a-E)\}^2 = \{25(47-88.23) + 75(49-29.90) \\ + 150(24-6.36) + 250(5-0.52)\}^2 \\ = (-1030.75 + 1432.50 + 2646.00 + 1120.00)^2 \\ = 4167.75^2 \\ = 1.74 \times 10^7.$$

$$T \sum x^2 N = 6803\{25^2 \times 4802 + (75^2 \times 1627) \\ + (150^2 \times 346) + (250^2 \times 28)\}, \\ = 6803(3.00 \times 10^6 + 9.15 \times 10^6 + 7.79 \times 10^6 + 1.75 \times 10^6) \\ = 6803 \times 2.17 \times 10^7 \\ = 1.48 \times 10^{11}.$$

$$(\sum xN)^2 = \{(25 \times 4802) + (75 \times 1627) + (150 \times 346) \\ + (250 \times 28)\}^2 \\ = (1.20 \times 10^5 + 1.22 \times 10^5 + 5.19 \times 10^4 + 7000)^2 \\ = (3.01 \times 10^5)^2 \\ = 9.06 \times 10^{10}.$$

Thus:

$$\chi^2 = \frac{(3.15 \times 10^{11}) \times (1.74 \times 10^7)}{(125 \times 6678)(1.48 \times 10^{11} - 9.06 \times 10^{10})} \\ = \frac{5.48 \times 10^{18}}{8.35 \times 10^5 \times 5.74 \times 10^{10}} \\ = \frac{5.48 \times 10^{18}}{4.79 \times 10^{16}} \\ = 114.4.$$

Consulting Appendix IX, row 1 (one degree of freedom), the observed value, 114.4, is greater than the tabulated statistic at the 0.1% level of significance, and so a linear trend can be inferred between the proportion of affected herds and herd size. There is considerable evidence that bovine spongiform encephalopathy is transmitted in meat and bone meal (see Chapters 2, 3 and 4) and so the trend can be explained by the larger number of animals at risk in large herds and therefore the greater probability of purchasing a contaminated batch of food.

A continuity correction should be applied to this test if the  $x$  scores are one unit apart (e.g., scores of 0, 1, 2 etc.):

$$\{\sum x(a-E)\}^2 \text{ should be replaced by } \{\sum x(a-E) - 1/2\}^2.$$

This test should be used with caution because a trend may be fitted and may be significant even if inspection of the data does not reveal a regular pattern over the ordered categories. The test therefore is appropriate only if there is a reasonable hypothesis of a linear relationship, as in the example above.

**Table 14.10** The joint distribution of fortnightly lameness incidence and rainfall on a farm in south-west England for a one-year period (1977). (Data supplied by the Institute for Research on Animal Diseases, Compton, UK.)

Fortnight	Number of lameness incidents (x)	Fortnightly rainfall totals (mm) (y)
1	40	37.2
2	38	48.8
3	55	72.0
4	38	76.8
5	45	14.8
6	42	53.2
7	51	23.9
8	45	11.0
9	41	79.9
10	23	21.0
11	10	2.3
12	29	81.1
13	19	7.4
14	11	31.5
15	11	33.2
16	19	31.1
17	33	109.2
18	47	25.0
19	42	1.9
20	34	28.8
21	17	24.4
22	30	51.3
23	48	38.2
24	59	18.0
25	41	57.2
26	26	33.2

## Correlation

Table 14.10 records the number of cases of lameness in cattle in relation to rainfall for a one-year period on a farm in south-west England. The question to be answered is: 'Does the amount of rainfall have an effect on the incidence of lameness?' This is a reasonable question; wet feet could be a causal factor. The values in Table 14.10 are plotted graphically in Figure 14.1, each point being a lameness-rainfall pair. Lameness is measured on the horizontal ( $x$ ) axis and rainfall on the vertical ( $y$ ) axis.

If there were a positive association between increased rainfall (the explanatory variable) and incidence of lameness (the response variable), most entries would be concentrated in a line from the bottom left to the top right of the figure. If there were no association, the pairs would be randomly scattered over the figure. Visually, the results give a slight impression of concentrating along the diagonal, but it is necessary to know whether this clustering is significant.

A useful measure of correlation between  $x$  and  $y$  for data that fulfil parametric requirements, when

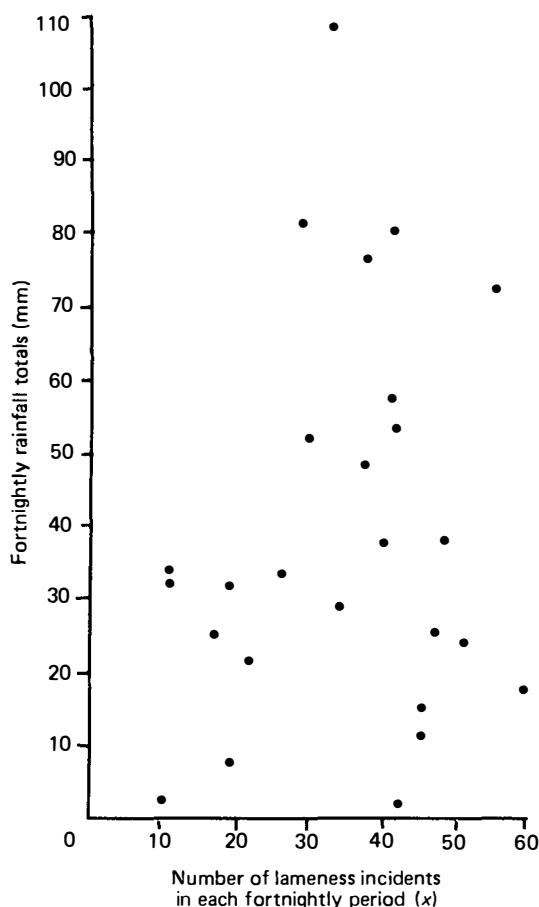

**Fig. 14.1** Plot of the joint distribution of fortnightly lameness incidence and rainfall on a farm in south-west England for a one-year period (1977). (Data from Table 14.10)

successive observations are **independent** of others, is the **correlation coefficient**,  $\rho$ , (rho). This ranges from +1, representing a complete positive association, to -1, representing a complete negative association.

In this example, lameness incidence is assumed to be Normally distributed because lameness is fairly common. (If it were rare, then it would more likely have a Poisson distribution.) Similarly, because there are many incidents of lameness, the data are considered to be continuous, although, technically, they are discrete. It also is assumed that the successive fortnightly observations of rainfall are independent, that is, the rainfall of one fortnight does not influence the rainfall of succeeding fortnights.

The correlation coefficient,  $\rho$ , refers to the total population; these measurements come from a sample and so can be used only to estimate the sample's correlation coefficient,  $r$ . Estimation involves calculating the means of the two variables and then estimating  $r$ , using the equation:

$$r = \frac{\sum(x - \bar{x})(y - \bar{y})}{\sqrt{\{\sum(x - \bar{x})^2 \sum(y - \bar{y})^2\}}}$$

This can be written alternatively in a form that is easier to handle during calculation:

$$r = \frac{\{\sum xy - (\sum x)(\sum y)/n\}}{\sqrt{[\sum x^2 - (\sum x)^2/n][\sum y^2 - (\sum y)^2/n]}}$$

Using the data from Table 14.10:

$$\begin{aligned} \sum x &= 894 & \sum y &= 1012.4 \\ \sum x^2 &= 35\,592 & \sum y^2 &= 57\,880.04 \\ \sum xy &= 36\,307.5 \\ n &= 26 \end{aligned}$$

$$\begin{aligned} \{\sum xy - (\sum x)(\sum y)/n\} &= 36\,307.5 - (894)(1012.4)/26 \\ &= 1496.52, \end{aligned}$$

$$\begin{aligned} \{\sum x^2 - (\sum x)^2/n\} &= 35\,592 - 894^2/26 \\ &= 4852.15, \end{aligned}$$

$$\begin{aligned} \{\sum y^2 - (\sum y)^2/n\} &= 57\,880.04 - 1012.4^2/26 \\ &= 18\,458.742. \end{aligned}$$

Thus:

$$\begin{aligned} r &= \frac{1496.52}{\sqrt{4852.15 \times 18\,458.742}} \\ &= \frac{1496.52}{9463.86} \\ &= 0.158. \end{aligned}$$

The significance of this value is obtained by consulting Appendix XXI. If the value is **greater** in absolute terms (i.e. ignoring sign) than the tabulated value, at a defined significance level, then a significant association is demonstrated. In this example, the value (0.158) is less than the tabulated value at the 5% level, which is 0.381. This value is chosen from the table by selecting the number of degrees of freedom, which is  $n - 2 = 24$ . This is one degree of freedom less than might be expected because the calculation of the correlation coefficient uses up one further degree of freedom. The most appropriate row therefore is 25 degrees of freedom. In this example, therefore, there is not a significant association between lameness incidence and rainfall, interpreted at the conventional level ( $P > 0.05$ ). Confidence intervals can also be calculated for  $r$  (Altman *et al.*, 2000).

If parametric assumptions are not met by data, an appropriate non-parametric measure of correlation can be calculated (Table 14.2).

## Multivariate analysis

The analytical techniques that have been described concern the study of relationships between two variables. In some cases it is necessary to assess the relationship

between a response variable and many explanatory variables. This requires statistical techniques that investigate multiple variables; these are therefore called **multivariate techniques**. They include cluster analysis, factor analysis, path analysis, discriminant analysis, analysis of principal components and multiple regression analysis. An introduction is provided in the next chapter, but most of these methods are beyond the scope of this book, and are described in detail elsewhere (e.g., Everitt and Dunn, 2001).

## Statistical packages

There is now a wide range of applications software packages that perform statistical calculations including those of the mean, median, standard deviation and standard error, confidence limits, the tests of association, sample-size calculations (briefly mentioned earlier), time series analysis, multivariate analyses and other statistical procedures relevant to epidemiology. Some of these packages are listed in Appendix III.

Such packages enable data to be managed and analysed efficiently and quickly. However, they can be dangerous. They facilitate easy analysis of data and so tend to encourage the collection of masses of data without a clear objective. It is also easy to try many of the different tests that are available, without a knowledge of the tests' underlying principles and assumptions. These remarks are equally relevant to the use of those pocket calculators that have built-in programs for simple statistical tests.

Expert statistical advice therefore should always be sought if there is any doubt about the analytical

technique that should be used in an investigation. This advice should be obtained **before** the investigation begins, not after it is completed; otherwise, time may be spent collecting data, only to discover that they cannot be used to solve the problem that is being posed.

## Further reading

- Altman, D.G., Machin, D., Bryant, T.N. and Gardner, M.J. (Eds) (2000) *Statistics with Confidence*, 2nd edn. BMJ Books, London. (*Estimation of confidence intervals and statistical guidelines*)
- Armitage, P., Berry, G. and Matthews, J.N.S. (2002) *Statistical Methods in Medical Research*, 4th edn. Blackwell Science, Malden
- Bailey, N.T.J. (1995) *Statistical Methods in Biology*, 3rd edn. Cambridge University Press, Cambridge. (*An introduction to elementary statistics*)
- Bland, M. (2000) *An Introduction to Medical Statistics*, 3rd edn. Oxford University Press, Oxford
- Essex-Sorlie, D. (1995) *Medical Biostatistics and Epidemiology*. Appleton and Lange, East Norwalk
- Fleiss, J.L., Levin, B. and Paik, M.C. (2003) *Statistical Methods for Rates and Proportions*, 3rd edn. John Wiley, Hoboken
- Leech, F.B. and Sellers, K.C. (1979) *Statistical Epidemiology in Veterinary Science*. Charles Griffin and Company, London and High Wycombe
- Mead, R., Curnow, R.N. and Hasted, A.M. (2003) *Statistical Methods in Agriculture and Experimental Biology*, 3rd edn. Chapman and Hall, Boca Raton and London
- Petrie, A. and Watson, P. (1999) *Statistics for Veterinary and Animal Science*. Blackwell Science, Oxford
- Siegel, S. and Castellan, N.J. (1988) *Nonparametric Statistics for the Behavioral Sciences*, 2nd edn. McGraw-Hill, New York



# 15

## Observational studies

Observational studies are used to identify risk factors, and to estimate the quantitative effects of the various component causes that contribute to the occurrence of disease. The investigations are based on analysis of natural disease occurrence in populations by **comparing** groups of individuals<sup>1</sup> with respect to disease occurrence and exposure to hypothesized risk factors.

Observational studies differ from experimental studies. In the former the investigator is not free to randomly allocate factors (disease and hypothesized risk factors) to individuals, whereas in the latter the investigator is free to allocate factors to individuals at random.

Risk factors may be categorical (e.g., breed and sex) or quantitative, continuous measurements (e.g. weight, age and rainfall). This chapter focusses on categorical data, which are commonly the subject of observational studies. Continuous data can also be analysed using categorical methods by grouping the data into discrete categories (e.g., age intervals).

### Types of observational study

#### Cohort, case-control and cross-sectional studies

There are three main types of observational study: **cohort, case-control and cross-sectional**. Each classifies animals into those with and without disease, and those

exposed and unexposed to hypothesized risk factors. Therefore, they each generate a  $2 \times 2$  contingency table for each disease/factor relationship (*Table 15.1*). However, the methods of generation differ between the types of study.

#### Cohort studies

In a cohort study, a group (cohort) of animals exposed to an hypothesized risk factor, and a group not exposed to the factor are selected and observed to record development of disease in each group. For example, if spaying were considered to be a risk factor for physiological urinary incontinence (PUI) in bitches, a suitable cohort study would comprise a group of spayed ('exposed') puppies and a group of entire ('unexposed') puppies, each of which would be monitored for the development of PUI. Therefore, incidence is measured, and  $a + b$  and  $c + d$  in *Table 15.1* are predetermined.

**Table 15.1** The  $2 \times 2$  contingency table constructed in observational studies.

	<i>Diseased animals</i>	<i>Non-diseased animals</i>	<i>Total</i>
Hypothesized risk factor present	<i>a</i>	<i>b</i>	<i>a + b</i>
Hypothesized risk factor absent	<i>c</i>	<i>d</i>	<i>c + d</i>
<i>Total</i>	<i>a + c</i>	<i>b + d</i>	<i>a + b + c + d = n</i>

In **cohort studies** ( $a + b$ ) and ( $c + d$ ) are predetermined.

In **case-control studies** ( $a + c$ ) and ( $b + d$ ) are predetermined.

In **cross-sectional studies** only  $n$  can be predetermined.

<sup>1</sup> Individuals are commonly, but not exclusively, the sampling units in observational studies. Herds, flocks, or other aggregates can also be studied.

### Case-control studies

In a case-control study, a group of diseased animals (cases) and a group of non-diseased animals (controls) are selected and compared with respect to presence of the hypothesized risk factor. Thus, a case-control study of PUI would involve identification of cases of PUI and comparison of the sexual status (spayed versus entire) of these cases with a control group of bitches that were not incontinent. Therefore  $a + c$  and  $b + d$  are predetermined. Case-control studies may be conducted with incident (new) cases or existing cases and therefore may utilize incidence or prevalence values.

### Cross-sectional studies

The cross-sectional study involves the selection of a sample of  $n$  individuals from a larger population, and then the determination, for each individual, of the **simultaneous** presence or absence of disease and hypothesized risk factor; prevalence is therefore recorded. For example, in a cross-sectional study of PUI, a sample of bitches would be selected and classified according to sexual status and whether or not the animals were incontinent. At the beginning of a cross-sectional study, only the total number of animals ( $n$  in Table 15.1) is predetermined. The numbers of animals with and without disease, and possessing or not possessing the risk factor, are not known initially.

### Nomenclature

A variety of alternative names have been applied to case-control and cohort studies. Both of these studies consider two events – exposure to a hypothesized causal factor or factors and development of disease – that are separated by a period of time. Because of this temporal separation of the two events, each of these studies is sometimes termed **longitudinal**.

The case-control study compares diseased animals (cases) with non-diseased animals (controls) and therefore has variously been called a **case-comparison**, **case-referent** or **case history** study. This study selects groups according to presence or absence of disease and **looks back** to possible causes; it has therefore sometimes been described as a **retrospective study** (looking back from effect to cause).

A cohort study selects groups according to presence or absence of exposure to hypothesized causal factors, and then **looks forward** to the development of disease. It has therefore sometimes been called a **prospective study** (looking forward, from cause to effect). Table 15.2 lists the types of observational study and their synonyms.

The groups may be selected as 'exposed' and 'unexposed' now, and then observed over a period of time

**Table 15.2** Nomenclature of observational studies.

Cross-sectional	Longitudinal	
	Case-control	Cohort
Synonym:	Synonyms:	Synonyms:
Prevalence	Retrospective Case-referent Case-comparison Case-compeer Case history Trohoc	Prospective Incidence Longitudinal Follow-up

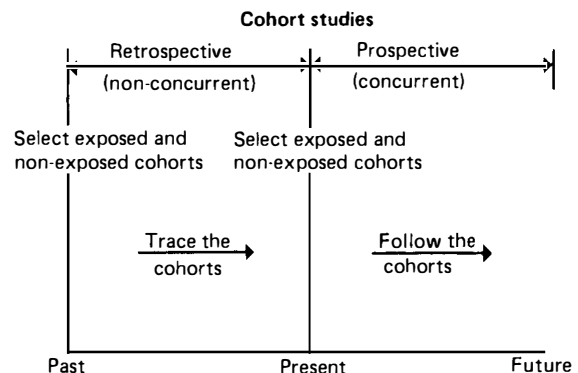

**Fig. 15.1** The selection of cohorts in concurrent and non-concurrent cohort studies ('retrospective' and 'prospective' used in the temporal sense.) (Modified from Lilienfeld and Lilienfeld, 1980.)

to identify cases; such a cohort study is termed **concurrent** (Figure 15.1). Alternatively, if reliable records relating to exposure are available (e.g., by tracing animals via adoption records from cat and dog homes/shelters: Spain *et al.*, 2004a,b) then groups may be selected according to presence or absence of previous exposure, and traced to the present to determine disease status; this constitutes a **non-concurrent** study.

Some investigators use 'retrospective' to refer to any study that records data from the past, and 'prospective' to refer to any study designed to collect future data. Therefore a non-concurrent cohort (prospective, in the causal sense) study alternatively may be termed a retrospective (in the temporal sense) cohort study. Similarly, a concurrent cohort study also can be called a prospective (in the temporal sense) cohort study (Figure 15.1).

Some studies show characteristics of more than one of the three main types. The range of such 'hybrid' studies, and their nomenclature, are described by Kleinbaum *et al.* (1982).

### Causal inference

The three types of study attempt to identify a cause by applying the first three of Evans' postulates (see

Chapter 3; postulates 1 and 3, rephrased here, using 'prevalence' and 'incidence' in their definitions):

1. the prevalence of a disease should be significantly higher in individuals exposed to the supposed cause than in those who are not (evidence supplied by a cross-sectional study);
2. exposure to the supposed cause should be present more commonly in those with than those without the disease, when all other risk factors are held constant (evidence supplied by a case-control study);
3. the incidence of disease should be significantly higher in those exposed to the supposed cause than in those not so exposed (evidence supplied by a cohort study).

The credibility of cause is strengthened by fulfilling Evans' other postulates. Thus, Jarrett's (1980) demonstration of an association between exposure to bracken and the development of intestinal cancer in cattle is more credible because a carcinogen has been isolated from bracken (Wang *et al.*, 1976) (Evans' postulate 10).

Causal inference is also strengthened if associations are detected in different circumstances (see Chapter 3) or in several studies, enabling results to be generalized more confidently. Thus, an association between spaying and PUI in bitches has been demonstrated in primary-care cases in Scotland and in referred cases in the south-west of England (Holt and Thrusfield, 1993), and demonstrated again in a subsequent national cohort study in the UK (Thrusfield *et al.*, 1998); this strengthens the inference that the association holds in the general dog population. In contrast, a predisposition to valvular heart disease has been demonstrated in cocker spaniels in North America, but not in Scotland (see Chapter 5), suggesting that the breed predisposition is not universal.

### Comparison of the types of study

A comparison of cohort, case-control and cross-sectional studies is given in *Table 15.3*.

Case-control studies can be conducted relatively quickly and are a useful means of initially 'trawling'

**Table 15.3** Comparison of the advantages and disadvantages of cohort, case-control and cross-sectional studies. (Based on Schlesselman, 1982, and Clayton and McKeigue, 2001.)

	Advantages	Disadvantages
Cohort studies	<ol style="list-style-type: none"> <li>1. Incidence in exposed and unexposed individuals can be calculated</li> <li>2. Permit flexibility in choosing variables to be systematically recorded</li> </ol>	<ol style="list-style-type: none"> <li>1. Exposed and unexposed proportions in target population cannot be estimated</li> <li>2. Large numbers of subjects are required to study rare diseases</li> <li>3. Potentially long duration for follow-up</li> <li>4. Relatively expensive to conduct</li> <li>5. Maintaining follow-up is difficult</li> <li>6. Control of extraneous variables may be incomplete</li> </ol>
Case-control studies	<ol style="list-style-type: none"> <li>1. Well suited to the study of rare diseases or of those with long incubation periods</li> <li>2. Relatively quick to mount and conduct</li> <li>3. Relatively inexpensive</li> <li>4. Requires comparatively few subjects</li> <li>5. Existing records occasionally can be used</li> <li>6. No risk to subjects</li> <li>7. Allow study of multiple potential causes of a disease</li> <li>8. Suited to the study of interaction between genotype and environmental factors</li> </ol>	<ol style="list-style-type: none"> <li>1. Exposed and unexposed proportions in target populations cannot be estimated</li> <li>2. Rely on recall or records for information on past exposures</li> <li>3. Validation of information is difficult or sometimes impossible</li> <li>4. Control of extraneous variables may be incomplete</li> <li>5. Selection of an appropriate comparison group may be difficult</li> <li>6. Incidence in exposed and unexposed individuals cannot be estimated</li> </ol>
Cross-sectional studies	<ol style="list-style-type: none"> <li>1. When a random sample of the target population is selected, disease prevalence, and proportions exposed and unexposed in the target population, can be estimated</li> <li>2. Relatively quick to mount and conduct</li> <li>3. Relatively inexpensive</li> <li>4. Current records occasionally can be used</li> <li>5. No risk to subjects</li> <li>6. Allow study of multiple potential causes of disease</li> </ol>	<ol style="list-style-type: none"> <li>1. Unsited to the study of rare diseases</li> <li>2. Unsited to the study of diseases of short duration</li> <li>3. Control of extraneous variables may be incomplete</li> <li>4. Incidence in exposed and unexposed individuals cannot be estimated</li> <li>5. Temporal sequence of cause and effect cannot necessarily be determined</li> </ol>

for risk factors. Cohort studies, in contrast, may have a long duration (particularly those of diseases with lengthy incubation and latent periods such as cancer) and often focus on a specific risk factor.

A logical requirement of demonstration of cause is that an animal is exposed to a causal factor **before** disease develops (see Chapter 3). The design of cohort studies, which resembles an experiment, ensures that this temporal sequence is detected. However, cross-sectional and case-control studies may not detect the sequence. For example, if the association between spaying and PUI in female dogs were being investigated using a cross-sectional study (spaying being the hypothesized risk factor), then spayed bitches with PUI may be identified; however, incontinence may have developed **before** spaying in some of the cases, in which instance spaying could not have been a component cause in those animals. For this reason, and the reason that a cohort study measures incidence, the cohort study therefore is a better technique for assessing risk and identifying causes than the other two types of study.

## Ecological studies

In each of the three types of study just described, it is necessary to know the exposure and disease status of all **individuals**. Sometimes this information is not available. Characteristics of **groups** may then be studied, although an inference may still be required at the level of the individual. Such studies are **ecological studies**<sup>2</sup>. For example, in The Netherlands, the highest human lung cancer mortality rate between 1969 and 1984 was found in the North Brabant region. Most pet bird keepers and bird clubs are also located in this region. Moreover, people who keep birds inhale allergens and dust particles, which impair the function of lung macrophages, resulting in reduced protection of the bronchial epithelium (Voisin *et al.*, 1983). It is therefore tempting to speculate that bird-keeping is a risk factor for lung cancer, although the exposure and disease status of individuals is not known. This inference is logically defective because it is based on the erroneous assumption that group and individual characteristics are always the same; this logical error is termed the **ecological fallacy** (Selvin, 1958). The correlation between group (i.e., ecological) variables is often considerably different from the individual correlation in the same populations (Robinson, 1950);

<sup>2</sup> Some authors use the term **spatial correlation study**, when the relationship between geographical variation in morbidity and putative explanatory variables, measured at the areal level, is assessed (Durr *et al.*, 2000).

although the lung cancer rate was highest in the region where bird-keeping was predominant, the cases may have occurred in people who **did not** keep birds.

Ecological studies therefore should be interpreted with caution, but are useful preliminary indicators to causal hypotheses that should be tested more thoroughly. Thus, a subsequent case-control study demonstrated an association between bird-keeping and lung cancer (Holst *et al.*, 1988), supporting a causal hypothesis at the level of the individual.

Piantadosi *et al.* (1988) discuss the ecological fallacy in detail, and Kleinbaum *et al.* (1982) describe ways of strengthening causal inferences from ecological studies.

## Measures of association

An hypothesis of association between disease and a factor can be tested using the  $\chi^2$  test (see Chapter 14). However, this test cannot be used to measure the **degree** of association. This is because  $\chi^2$  is a function of the proportions in the various cells and of the total sample size, whereas the degree of association is only really a function of the cell proportions; the sample size has a role to play in detecting significance but not in determining the extent of association. It is also desirable to provide a more informative **measure** of the impact of a factor on disease occurrence. This can be expressed by the absolute **difference** between disease occurrence in 'exposed' and 'unexposed' groups, estimated by determining the difference between the two proportions (see 'Attributable risk', below). Alternatively, the **ratio** of disease occurrence between the two groups can be calculated. Ratios are relative measures, and two are widely used: the **relative risk** and the **odds ratio**.

### Relative risk

The **relative risk**, *RR*, is the ratio of the incidence of disease in exposed animals to the incidence in unexposed animals<sup>3</sup>. Using the notation of Table 15.1:

$$\text{incidence}_{\text{exposed}} = a/(a + b),$$

$$\text{incidence}_{\text{unexposed}} = c/(c + d);$$

$$\text{therefore, } RR = \{a/(a + b)\}/\{c/(c + d)\}.$$

A *RR* greater than one indicates a positive statistical association between factor and disease. Thus, a *RR* of

<sup>3</sup> This is more fully termed the relative risk in **exposed** animals,  $RR_{\text{exp}}$  to distinguish it from the less frequently derived **population** relative risk,  $RR_{\text{pop}} = \{(a + c)/n\}/\{c/(c + d)\}$ . (See footnote p. 271.)

two indicates that the incidence of disease in exposed animals is twice that in unexposed animals. A *RR* less than one indicates a negative statistical association: possession of the factor may be said to have a protective effect against the disease. A *RR* of one suggests no association.

The *RR* can be derived either from cumulative incidence, when it is also termed the **risk ratio**, or from incidence rates, when it is also called the **rate ratio**. (Some authorities use relative risk as a synonym only for risk ratio.) The *RR* can only be estimated directly in a cohort study.

### Calculation of confidence intervals

The *RR* is estimated from a sample of the study population. Therefore, the significance of the result needs to be assessed. The hypothesis that the *RR* is significantly greater (or less) than one can be tested (Fleiss *et al.*, 2003). Alternatively, confidence intervals can be estimated. The latter approach is adopted in this chapter because it also indicates the precision of the measure of association (see Chapter 14). However, care needs to be exercised because the relative risk statistic is not Normally distributed.

**Logarithmic-based method** An approximate 95% confidence interval for the relative risk for large samples can be calculated, based on a transformation of the limits for the natural logarithm ( $\log_e$ ) of the *RR* (Katz *et al.*, 1978).

Using the data in *Table 14.6* relating to PUI; first the sample (point) estimate of the *RR* is calculated:

$$\begin{aligned}\widehat{RR} &= \{a/(a+b)\}/\{c/(c+d)\} \\ &= (34/791)/(7/2434) \\ &= 14.95.\end{aligned}$$

The variance (var) of  $\log_e \widehat{RR}$  is approximately equal to:

$$\begin{aligned}& \{(b/a)/(a+b)\} + \{(d/c)/(c+d)\} \\ &= \{(757/34)/(34+757)\} + \{(2427/7)/(7+2427)\} \\ &= 0.028 + 0.142 \\ &= 0.170.\end{aligned}$$

The 95% confidence interval is:

$$\begin{aligned}& \widehat{RR} \exp(-1.96\sqrt{\text{var}}), \widehat{RR} \exp(+1.96\sqrt{\text{var}}) \\ &= 14.95 \exp(-0.8081), 14.95 \exp(0.8081) \\ &= 14.95 \times 2.72^{-0.8081}, 14.95 \times 2.72^{0.8081} \\ &= 14.95 \times 1/(2.72^{0.8081}), 14.95 \times 2.72^{0.8081} \\ &= 14.95 \times 0.45, 14.95 \times 2.24 \\ &= 6.73, 33.49.\end{aligned}$$

Thus, the relative risk is significantly greater than one at the 5% level, suggesting an association between spaying (the risk factor) and PUI. Note that this result is in accord with the result of the  $\chi^2$  test conducted in

Chapter 14, but also gives a **measure** of the association with defined **precision**.

**Test-based method** An alternative method for calculating approximate confidence intervals for the relative risk utilizes the appropriate test statistic:  $\chi^2$ .

A 95% confidence interval for the *RR* can be derived thus:

$$\widehat{RR}^{1 \pm 1.96/\chi}.$$

(Note that  $\chi$ , not  $\chi^2$ , is used.)

Using the data in *Table 14.6*:

the estimated *RR* = 14.95.

The value of  $\chi^2$  has been derived on page 259, and is 73.35.<sup>†</sup>

Thus  $\chi = \sqrt{73.35} = 8.564$ ,

And the 95% confidence interval is:

$$\begin{aligned}& 14.95^{1-1.96/8.564}, 14.95^{1+1.96/8.564} \\ &= 14.95^{0.771}, 14.95^{1.229} \\ &= 8.05, 27.80.\end{aligned}$$

Compare this with the logarithmic approximation, 6.73, 33.49, which is less precise.

Other confidence intervals can be constructed using appropriate multipliers (Appendix VI).

Exact intervals can be computed<sup>4</sup>, and point and interval estimates based on animal-(person)-years at risk, can also be calculated (Kahn and Sempos, 1989). Such incidence rate estimations are appropriate when the period of observation of individuals varies (e.g., when animals are enlisted over a period of time and when there are many censored observations).

### Odds ratio

The **odds ratio (relative odds)**,  $\psi$  (psi), is another relative measure based on 'odds': the ratio of the probability of an event occurring to the probability of it not occurring (a ratio little used outside betting circles). Thus, the probability of throwing a head with a coin is  $\frac{1}{2}$  (i.e., 0.5), whereas the odds are 'even', 1:1

<sup>†</sup> This value is computed using a continuity correction. There is debate as to whether this should be applied, and some authors suggest that another derivation of  $\chi^2$  – the Mantel–Haenszel  $\chi^2$  – is used in computing confidence intervals – see Sahai and Kurshid (1995) for a discussion. For large samples, the differences are trivial.

<sup>4</sup> The availability of computers has fostered the development of alternative methods for calculating confidence intervals for many parameters, and for computing *P* values, when the exact method proves to be too lengthy. The main methods involve **bootstrap estimation** (see Chapter 12) or **Monte Carlo simulation** (see Chapter 19). One method is not uniformly better than the other, each having merit, depending on the problem to be solved. Consideration of these methods is beyond the scope of this text; Efron and Tibshirani (1993) and the User Manual to *StatXact* (see Appendix III) should be consulted for a full discussion.

**Table 15.4** Derivation of odds ratios in observational studies.*Cohort study*

$$\text{Probability of disease}_{\text{exposed}} = a/(a + b)$$

$$\text{Probability of no disease}_{\text{exposed}} = b/(a + b)$$

$$\text{Odds of disease}_{\text{exposed}} = [a/(a + b)]/[b/(a + b)].$$

$(a + b)$  cancels out from the numerator and denominator, leaving  $a/b$ .

$$\text{Probability of disease}_{\text{unexposed}} = c/(c + d)$$

$$\text{Probability of no disease}_{\text{unexposed}} = d/(c + d)$$

$$\text{Odds of disease}_{\text{unexposed}} = [c/(c + d)]/[d/(c + d)].$$

$(c + d)$  cancels out from the numerator and denominator, leaving  $c/d$ .

The *disease odds ratio*,  $\psi_d$ , is the ratio of the odds of disease<sub>exposed</sub> to the odds of disease<sub>unexposed</sub>:  $(a/b)/(c/d) = ad/bc$ .

*Case-control study*

$$\text{Probability of exposure}_{\text{diseased}} = a/(a + c)$$

$$\text{Probability of no exposure}_{\text{diseased}} = c/(a + c)$$

$$\text{Odds of exposure}_{\text{diseased}} = [a/(a + c)]/[c/(a + c)].$$

$(a + c)$  cancels out from numerator and denominator, leaving  $a/c$ .

$$\text{Probability of exposure}_{\text{controls}} = b/(b + d)$$

$$\text{Probability of no exposure}_{\text{controls}} = d/(b + d)$$

$$\text{Odds of exposure}_{\text{controls}} = [b/(b + d)]/[d/(b + d)].$$

$(b + d)$  cancels out from the numerator and denominator, leaving  $b/d$ .

The *exposure odds ratio*,  $\psi_e$ , is the ratio of the odds of exposure<sub>diseased</sub> to the odds of exposure<sub>controls</sub>:  $(a/c)/(b/d) = ad/bc$ .

*Cross-sectional study*

Both  $\psi_d$  (based on prevalence) and  $\psi_e$  can be computed =  $ad/bc$  (prevalence odds ratio,  $\psi_p$ ).

(0.5/(1 - 0.5)). Similarly, the probability of throwing a specified number with a six-sided dice is  $\frac{1}{6}$  (0.167), whereas the odds are 1:5 (0.167/(1 - 0.167)). Note that the odds are larger than the probability.

In a cohort study, a disease odds ratio,  $\psi_d$ , is estimated; this is the ratio of the odds of disease in exposed individuals to the odds in those unexposed (Table 15.4). This simplifies to  $ad/bc$ , the **cross-product ratio**, which therefore is a synonym for the odds ratio.

In a case-control study, a different odds ratio, the exposure odds ratio,  $\psi_e$ , is determined. It is the ratio of the odds of exposure to the factor in cases to the odds of exposure in controls. Note, however, that this also simplifies to  $ad/bc$ .

A prevalence odds ratio,  $\psi_p$ , is derived in a cross-sectional study, thus:  $ad/bc$ .

In a cohort study, when disease is rare, the incidence of disease in exposed animals approximately equals the odds of disease because  $a$  is small relative to  $b$ ; thus  $a/(a + b) \approx a/b$ . Similarly,  $c/(c + d) \approx c/d$ . Thus, the values of the odds ratio and relative risk are similar. Moreover, since  $\psi_e$ ,  $\psi_d$  and  $\psi_p$  are equivalent ( $ad/bc$ ), odds

ratios derived in case-control and cross-sectional studies give indirect estimates of the relative risk (Cornfield, 1951). Additionally, with appropriate sampling protocols, an estimate of the relative risk can be obtained from case-control studies without the assumption of rarity of disease (Rodrigues and Kirkwood, 1990)<sup>5</sup>.

**Calculation of confidence intervals**

**Logarithmic-based method** An approximate 95% confidence interval for the odds ratio can be calculated, based on a transformation of the limits for the natural logarithm ( $\log_e$ ) of  $\psi$  (Woolf, 1955).

The method is exemplified using the data in Table 15.5a relating to the association between type of ventilation and respiratory disease (specifically enzootic pneumonia) in pigs. In this example, herds – not individuals – are the sampling units. ‘Cases’ are herds with a high prevalence of pneumonia (a three-year average >5%), whereas ‘controls’ are herds with a low prevalence.

First, the sample estimate of  $\psi$  is calculated:

$$\begin{aligned}\hat{\psi} &= ad/bc \\ &= (91 \times 60)/(73 \times 25) \\ &= 2.99.\end{aligned}$$

The variance (var) of  $\log_e \hat{\psi}$  is approximately equal to:

$$\begin{aligned}&(1/a + 1/b + 1/c + 1/d) \\ &= 0.01099 + 0.01370 + 0.04000 + 0.01667 \\ &= 0.08137.\end{aligned}$$

The 95% confidence interval is:

$$\begin{aligned}&\hat{\psi} \exp(-1.96\sqrt{\text{var}}), \hat{\psi} \exp(+1.96\sqrt{\text{var}}) \\ &= 2.99 \exp(-0.5591), 2.99 \exp(0.5591) \\ &= 2.99 \times 2.72^{-0.5591}, 2.99 \times 2.72^{0.5591} \\ &= 2.99 \times 1/(2.72^{0.5591}), 2.99 \times 2.72^{0.5591} \\ &= 2.99 \times 0.572, 2.99 \times 1.749 \\ &= 1.71, 5.23.\end{aligned}$$

The odds ratio is therefore significantly greater than 1 at the 5% level, suggesting an association between

<sup>5</sup> Strictly, case-control and cross-sectional studies produce estimates of the ‘relative risk’ of *being* diseased, whereas cohort studies estimate the relative risk of *becoming* diseased. The former relative risk is more properly termed the **prevalence ratio** (Kleinbaum *et al.*, 1982). This can also be calculated directly in a cross-sectional study, using the same formulae as those for the point and interval estimates of the relative risk. Cross-sectional studies also allow calculation of a *population prevalence ratio*, which is commonly termed the population ‘relative risk’,  $RR_{\text{pop}} = \{(a + c)/n\}/\{c/(c + d)\}$ . This adjusts the standard prevalence ratio (‘relative risk’) for the prevalence of the factor in the population (Martin *et al.*, 1987). A *population odds ratio*,  $\psi_{\text{pop}}$ , can also be calculated in cross-sectional and case-control studies (if controls are representative of non-diseased animals in the study population), and is interpreted in the same way as  $RR_{\text{pop}}$ ,  $\psi_{\text{pop}} = \{d/(a + c)\}/\{c/(b + d)\}$  (Martin *et al.*, 1987).

**Table 15.5** The relationship between type of ventilation system and porcine enzootic pneumonia. (Data from Willeberg, 1980b.)

(a) Crude relationships

	Cases* (No. of herds)	Controls** (No. of herds)	Total
Fan ventilation	91 (a)	73 (b)	164
No fan ventilation	25 (c)	60 (d)	85
Total	116	133	249

\* Herds with a high prevalence of porcine enzootic pneumonia.

\*\* Herds with a low prevalence of porcine enzootic pneumonia.

(b) Relationships according to herd size

	Herd size									
	≤200		201–300		301–400		401–500		>500	
	+	-	+	-	+	-	+	-	+	-
Fan ventilation	2	7	15	30	13	19	7	5	54	12
No fan ventilation	4	27	8	18	7	10	2	4	4	1

‘+’ = high prevalence of porcine enzootic pneumonia (disease ‘present’);

‘-’ = low prevalence of porcine enzootic pneumonia (disease ‘absent’).

$\hat{\psi}_i = 1.93$	$\hat{\psi}_i = 1.13$	$\hat{\psi}_i = 0.98$	$\hat{\psi}_i = 2.80$	$\hat{\psi}_i = 1.13$
$n_i = 40$	$n_i = 71$	$n_i = 49$	$n_i = 18$	$n_i = 71$
$w_i = 0.70$	$w_i = 3.38$	$w_i = 2.71$	$w_i = 0.56$	$w_i = 0.68$
$v_i = 0.93$	$v_i = 0.28$	$v_i = 0.37$	$v_i = 0.45$	$v_i = 1.35$
$w_i^2 v_i = 0.49$	$w_i^2 v_i = 11.42$	$w_i^2 v_i = 7.34$	$w_i^2 v_i = 0.31$	$w_i^2 v_i = 0.46$
$w_i^2 v_i = 0.46$	$w_i^2 v_i = 3.20$	$w_i^2 v_i = 2.72$	$w_i^2 v_i = 0.14$	$w_i^2 v_i = 0.62$

fan ventilation and pneumonia, based on these crude data.

A more precise method of estimating confidence intervals is described by Cornfield (1956), but in large studies the difference between this and Woolf’s method is trivial.

**Test-based method** The test-based formula for an approximate 95% confidence interval is simply:

$$\hat{\psi}^{1 \pm 1.96/\chi}$$

Exact confidence intervals can be calculated (Mehta *et al.*, 1985); the method requires an appropriate computer program.

An odds ratio cannot be calculated when a contingency table cell contains the value zero. This problem can be overcome by the addition of 1/2 to the values in each cell of the table before calculating the odds ratio and its associated confidence interval (Fleiss *et al.*, 2003). However, if a study involves 2 × 2 tables with cell totals of zero, or with cell totals so small that adding 1/2 will substantially affect the calculation, then its precision is likely to be too low to contribute much to knowledge. Alternatively, if a cell has a zero value, the  $\chi^2$  test can be applied, or a confidence

interval can be calculated for the difference between the two proportions (see Chapter 14).

**Attributable risk**

The terms ‘attributable risk’ and ‘attributable proportion’ have been used to denote a number of different concepts, often with several inconsistently used synonyms (Last, 2001). The first describes absolute differences; whereas the second expresses these differences in relative terms. Each can relate either to animals exposed to the risk factor or to the total population.

**Attributable risk (exposed)**

Table 14.6 shows that although the incidence of urinary incontinence in spayed (exposed) dogs,  $a/(a + b)$ , is greater than the incidence in entire (unexposed) dogs,  $(c/c + d)$ , the spayed dogs are still susceptible to a ‘background’ risk, corresponding to  $(c/c + d)$ . Put another way, if some of the spayed dogs had not been neutered, then they may still, as entire dogs, have developed urinary incontinence. The extent of the risk associated with spaying is the **attributable risk (risk**

**difference or attributable rate) in exposed animals,  $\delta_{\text{exp}}$**  (delta): the difference between the incidence of disease in exposed animals and the incidence in unexposed animals:

$$\delta_{\text{exp}} = \{a/(a+b)\} - \{c/(c+d)\}.$$

Thus, in this example:

$$\begin{aligned}\delta_{\text{exp}} &= (34/791) - (7/2434) \\ &= 0.043 - 0.003 \\ &= 0.040.\end{aligned}$$

This represents an incidence of incontinence in spayed dogs, attributable to spaying, of 4.0 per 100 during the period of observation. The attributable risk therefore indicates the extent to which the incidence of disease in exposed animals would be reduced if they had not been exposed to the risk factor, **assuming that the risk factor is causal.**

This attributable risk can be expressed in terms of the relative risk:

$$\begin{aligned}\delta_{\text{exp}} &= \{a/(a+b)\} - \{c/(c+d)\} \\ &= [\{a/(a+b)\}/\{c/(c+d)\} - 1] \times \{c/(c+d)\}.\end{aligned}$$

Since  $\{a/(a+b)\}/\{c/(c+d)\} = RR$ , then  $\delta_{\text{exp}} = (RR - 1) \times \{c/(c+d)\}$ .

Note that the incidence in unexposed animals is required to calculate  $\delta_{\text{exp}}$ .

An attributable risk, based on prevalence values, can be estimated in cross-sectional studies because the prevalence in unexposed animals is known. However, this is not known in a case-control study, and so  $\delta_{\text{exp}}$  cannot be determined in this type of study, unless information from other sources is available on the baseline incidence.

It is clear that ratios  $\{a/(a+b)\}/\{c/(c+d)\}$  of 0.02/0.01 and 0.0002/0.0001 give the same relative risk, even though they represent vastly different incidence ratios. The attributable risk, however, includes the baseline incidence rate, and therefore gives an indication of the magnitude of the effect of a causal factor in the population. Thus, the attributable risk gives a better indication than the relative risk of the effect of a preventive campaign that removes the factor (MacMahon and Trichopoulos, 1996). However, the use of 'attributable' in the former term is dangerous because it implies a *causal* relationship, whereas the parameter is based only on *statistical associations*. Its practical application in reducing disease incidence therefore depends on strong evidence of a causal relationship between risk factor and disease, which may need to be determined by other means (see Chapter 3).

The main advantage of the relative risk is the empirical finding that the relative risk for a particular disease/factor relationship is fairly consistent in a wide range of populations (Elwood, 1998) and, in contrast to the attributable risk, is therefore independent

of the background incidence. This property of consistency makes the relative risk more valuable than the attributable risk in evaluating whether a relationship is likely to be causal. Moreover, the relative risk, or an approximation of it, can be derived from any of the main types of study.

An approximate confidence interval for  $\delta_{\text{exp}}$  can be calculated using the formula for the difference between two unrelated proportions (see Chapter 14). Rothman and Greenland (1998) give a formula based on incidence rates. (These authors also argue a distinction between attributable risk and attributable rate, depending on whether cumulative incidence or incidence rate, respectively, are used.)

### Population attributable risk

The **population attributable risk (population attributable rate)**,  $\delta_{\text{pop}}$ , is the difference between the incidence of disease in the total population and the incidence of disease in the unexposed group:

$$\begin{aligned}\delta_{\text{pop}} &= \{(a+c)/n\} - \{c/(c+d)\} \\ &= \{(a+b)/n\} \times \delta_{\text{exp}}.\end{aligned}$$

This gives a direct indication of the amount of disease in the total population attributable to the risk factor.

Using the data in *Table 14.6*:

$$\begin{aligned}\delta_{\text{pop}} &= (41/3225) - (7/2434) \\ &= 0.013 - 0.003 \\ &= 0.010.\end{aligned}$$

Thus, the incidence of incontinence in the total population during the period of observation, attributable to spaying, is 1 per 100, and, if bitches were not spayed, the incidence in the population could be expected to be reduced by 1 per 100.

The population attributable risk can only be calculated when disease morbidity in the total population is known.

Again, a population attributable 'risk', based on prevalence values, can be estimated directly in a cross-sectional study.

Kahn and Sempos (1989) describe methods for calculating a confidence interval for  $\delta_{\text{pop}}$ .

### Attributable proportion

#### Attributable proportion (exposed)

The **attributable proportion (exposed)**,  $\lambda_{\text{exp}}$  (Elwood, 1998), also termed the **aetiological fraction (exposed)** (Last, 2001), **attributable fraction (exposed)** (Martin *et al.*, 1987) and **attributable risk (exposed)** (Kahn and Sempos, 1989), is the proportion of incidence in



exposed animals attributable to exposure to a risk factor.

$$\lambda_{\text{exp}} = (RR - 1)/RR.$$

Using the data in *Table 14.6*:

$$\begin{aligned}\lambda_{\text{exp}} &= (14.95 - 1)/14.95, \\ &= 0.93.\end{aligned}$$

That is, 93% of cases of incontinence in spayed bitches are attributable to spaying, assuming that spaying is causal.

Alternatively:

$$\begin{aligned}\lambda_{\text{exp}} &= (\text{incidence}_{\text{exposed}} - \text{incidence}_{\text{unexposed}}) / \\ &\quad (\text{incidence}_{\text{exposed}}) \\ &\text{i.e., } \delta_{\text{exposed}} / (\text{incidence}_{\text{exposed}}) \\ &= \{a/(a+b) - c/(c+d)\} / \{a/(a+b)\}.\end{aligned}$$

It is estimated directly in a cohort study, and can be estimated indirectly in case-control studies, using the odds ratio approximation to the relative risk:

$$\lambda_{\text{exp}} = (\psi - 1)/\psi.$$

### Population attributable proportion

The **population attributable proportion**,  $\lambda_{\text{pop}}$  (Elwood, 1998), also termed the **population aetiological fraction** (Schlesselman, 1982), **aetiological fraction** (Last, 2001), **attributable fraction** (Ouelett *et al.*, 1979), **population attributable fraction** (Martin *et al.*, 1987), **attributable risk** (Lilienfeld and Lilienfeld, 1980), **attributable risk percent** (Cole and MacMahon, 1971), and **population attributable risk** (Kahn and Sempos, 1989) is the proportion of the incidence in the population attributable to exposure to a risk factor. Therefore, it represents the proportion of disease occurrence that would be eliminated if the group exposed to a causal factor has its incidence reduced to the level of the unexposed group.

$$\lambda_{\text{pop}} = \{(RR - 1)/RR\} \times f,$$

where  $f$  is the proportion of diseased individuals exposed to the causal factor,  $a/(a+c)$ .

Using the figures in *Table 14.6*:

$$\begin{aligned}RR &= 14.95 \\ f &= 34/41 \\ &= 0.829.\end{aligned}$$

Thus:

$$\begin{aligned}\lambda_{\text{pop}} &= \{(14.95 - 1)/14.95\} \times 0.829 \\ &= 0.77.\end{aligned}$$

Thus, if spaying is causal, 77% of cases of PUI in the population are attributable to spaying.

The population attributable proportion, like the population attributable risk, therefore is an indication

of the impact that removal of a causal factor would have on overall reduction in incidence in the population<sup>6</sup>. In terms of causal model 1 (see Chapter 3), the sum of the population attributable proportions of all sufficient causes is 1 (100%).

Other formulae for calculating  $\lambda_{\text{pop}}$  are:

- $\lambda_{\text{pop}} = (\text{incidence}_{\text{pop}} - \text{incidence}_{\text{unexposed}}) / (\text{incidence}_{\text{pop}})$   
i.e.,  $\delta_{\text{pop}} / (\text{incidence}_{\text{pop}})$   
 $= \{(a+c)/n - c/(c+d)\} / \{(a+c)/n\}$ ;
- $\lambda_{\text{pop}} = \{p(RR - 1)\} / \{p(RR - 1) + 1\}$ ,  
where  $p$  = proportion of population exposed,  $(a+b)/n$ ;
- $\lambda_{\text{pop}} = \delta_{\text{pop}} / \{(a+c)/n\}$ ;
- $\lambda_{\text{pop}} = (RR_{\text{pop}} - 1) / RR_{\text{pop}}$ .

The population attributable proportion can only be calculated directly when disease morbidity in the total population is known. However, it can also be estimated indirectly in case-control studies (if controls are representative of the healthy population):

$$\lambda_{\text{pop}} = 1 - \{[c(b+d)] / [d(a+c)]\}.$$

Again, a value of  $\lambda_{\text{pop}}$ , based on prevalence values, can be estimated directly in cross-sectional studies.

The derivation of confidence intervals for  $\lambda_{\text{exp}}$  and  $\lambda_{\text{pop}}$  is described by Kahn and Sempos (1989).

Forrow *et al.* (1992) and Bucher *et al.* (1994) discuss the influence of the type of parameter quoted (absolute versus relative) on clinical decisions.

### Interaction

Interaction was introduced in Chapter 5 as occurring between two or more factors when the frequency of disease is either in excess of or less than that expected from the combined effects of each factor. If there is a plausible biological mechanism for the interaction, then **synergism** is said to occur when the frequency is in excess of the anticipated value, and **antagonism** when the frequency is less than the anticipated value.

Two models of interaction were also introduced in Chapter 5: **additive** and **multiplicative**. The choice of model depends on the measure of disease frequency. Generally, the additive model is most appropriate in indicating the impact of interaction on incidence (Kleinbaum *et al.*, 1982)<sup>7</sup>. Therefore, an additive model will now be described (details of both types of model

<sup>6</sup> For example, it has been applied to assess the impact of endemic helminth infections on disease morbidity, and therefore the extent to which helminth control will improve community health (Booth, 1998).

<sup>7</sup> For a discussion of the appropriateness of additive and multiplicative models, see Thompson (1991).

**Table 15.6** Number of cases of the feline urological syndrome and controls, and estimated relative risk values for combinations of categories within the factors, sex, diet and activity. (From Willeberg, 1976.)

Sex	Categories		No. of cats		Estimated relative risk ( $\widehat{RR}_m$ )
	Level of dry cat food	Level of outdoor activity	Cases	Controls	
Entire male	Low	High	1	12	1
	Low	Low	2	7	3.43 (a)
	High	High	4	11	4.36 (b)
	High	Low	2	4	6.00 (d)
Castrated male	Low	High	5	12	5.00
	Low	Low	3	5	7.20
	High	High	14	5	33.60***
	High	Low	28	2	168.00***
Total no. of male cats			59	58	12.2**

\*\* Significant at the 1% level; \*\*\* significant at the 0.1% level, by the  $\chi^2$  method.

† Odds ratio approximation, relative to unexposed group = entire cats with high levels of outdoor activity and receiving low levels of dry cat food.

are given by Kleinbaum *et al.* (1982) and Schlesselman (1982)). The model is based on additivity of excess risks.

$$RR_m = 1 + \sum_{i=1}^j (RR_i - 1)$$

### The additive model

Consider two factors,  $x$  and  $y$ . If  $p_{00}$  is the incidence rate when neither factor is present,  $p_{10}$  is the incidence rate when  $x$  alone is present,  $p_{01}$  is the incidence rate when  $y$  alone is present, and  $p_{11}$  is the incidence rate when both are present, then:

$$p_{10} - p_{00} = \text{risk attributable to } x,$$

$$p_{01} - p_{00} = \text{risk attributable to } y.$$

If the combined effect of  $x$  and  $y$  equals the sum of their individual effects, then:

$$(p_{11} - p_{00}) = (p_{10} - p_{00}) + (p_{01} - p_{00}),$$

and there is no interaction.

Lack of interaction can be expressed in terms of the excess relative risk, by dividing the formula above by  $p_{00}$ :

$$(p_{11}/p_{00} - 1) = (p_{10}/p_{00} - 1) + (p_{01}/p_{00} - 1).$$

The relative risk when both factors are present is denoted by  $RR_{xy} = p_{11}/p_{00}$ ; the relative risks when  $x$  or  $y$  is present alone are denoted by  $RR_x = p_{10}/p_{00}$  and  $RR_y = p_{01}/p_{00}$ , respectively.

Thus:

$$(RR_{xy} - 1) = (RR_x - 1) + (RR_y - 1),$$

that is:

$$RR_{xy} = 1 + (RR_x - 1) + (RR_y - 1).$$

If more than two factors,  $j$  say, are being considered, then the combined relative risk,  $RR_m$ , for these is given by:

where  $RR_1, \dots, RR_j$  denote the individual relative risks.

Examples of positive interaction, based on an additive model, are given in Table 15.7, using the raw data in Table 15.6 relating to the feline urological syndrome (Willeberg, 1976).

Hypothesized causal factors in males are feeding high levels of dry cat food, castration, and low levels of outdoor activity. The background risk, ( $RR = 1$ ), therefore is represented by entire male cats consuming low levels of dry cat food, and with high levels of outdoor activity.

Consider the two factors: low levels of outdoor activity and high levels of dry cat food intake. The estimated relative risk associated with low levels of outdoor activity and low levels of dry cat food intake in entire males is 3.43 (a in Table 15.6). The relative risk associated with high levels of dry cat food and high levels of outdoor activity is 4.36 (b in Table 15.6). Therefore, applying the additive model for these two factors (Table 15.7):

$$\widehat{RR}_m = 1 + (3.43 - 1) + (4.36 - 1) = 6.79 \text{ (c in Table 15.7).}$$

The estimated combined relative risk for these two factors is 6.00 (d in Tables 15.6 and 15.7).

Thus, there is no evidence for interaction between high levels of dry cat food and low levels of outdoor activity because the estimated combined relative risk (6.00) is similar to the expected combined relative risk, assuming no interaction (6.79). Similarly, there is no evidence of interaction between castration and low levels of outdoor activity. However, there is evidence

**Table 15.7** Comparison of estimated and expected relative risk values of the feline urological syndrome for male cats for multiple excess risk category combinations, based on an additive interaction model. (Adapted from Willeberg, 1976.)

Sexual status	Categories		Estimated relative risk ( $\hat{RR}$ )	Expected relative risk based on additive model ( $\hat{RR}_m$ )
	Level of dry cat food	Level of outdoor activity		
Entire	High	Low	6.00 (d)	6.79 (c)
Castrated	Low	Low	7.20	7.43
Castrated	High	High	33.60	8.36
Castrated	High	Low	168.00	10.67

of positive interaction between castration and high levels of dry cat food, and between castration, high levels of dry cat food and low levels of outdoor activity: in each case the estimated combined relative risk is greater than the expected combined relative risk, using the additive model.

A plausible biological mechanism for the interaction should be posited; that is, synergism should be explained. Thus, castration and high levels of dry cat food intake (usually associated with overfeeding) may both result in inactivity, thereby reducing blood flow to the kidneys, impairing kidney function, and therefore possibly promoting changes in the urine that are conducive to the formation of uroliths; this constitutes a possible common causal pathway.

Estimation of confidence intervals for interaction is discussed by Hosmer and Lemeshow (1992).

## Bias

Observational studies are subject to **bias** (see Chapter 9). Although many types of bias can occur in observational studies (Sackett, 1979), three are particularly pertinent to observational studies:

1. selection bias;
2. misclassification;
3. confounding.

### Selection bias

Selection bias results from systematic differences between characteristics of the study population and the target population from which it was drawn. Most observational studies use data gathered from convenient populations such as veterinary clinics, abattoirs and particular farms. Willeberg's investigation of the feline urological syndrome in Denmark (Willeberg, 1977), for instance, utilized data collected at a veterinary school's clinic. Ideally, a sample should be selected from the target population (all cats in Denmark in this

example), but this is rarely possible. It was stated in Chapter 13 that the inferences from investigations that might be biased by selection need to be made with care if they are to be extrapolated to the target population. Consideration should be given to the likelihood of the study population being biased with respect to the disease and factors that are being investigated. Selection bias is unlikely if:

- exposure to a factor does not increase the likelihood of an animal being present in the study population;
- the likelihood of inclusion of cases and controls in the study population is the same.

For example, Darke *et al.* (1985) investigated the association between the presence of an entire tail (the hypothesized causal factor) and tail injuries (the disease) in a veterinary clinic population to determine whether docking reduces the risk of tail damage. It is improbable that docking or otherwise affects attendance at a veterinary clinic and so selection bias was unlikely in this study.

### Misclassification

Misclassification is a type of measurement bias; it occurs when either diseased animals are classified as non-diseased, or animals without a particular disease are classified as possessing it. The likelihood of misclassification depends on the frequency of disease, the frequency of exposure to the hypothesized causal factor, and the sensitivity and specificity of the diagnostic criteria used in the study (Table 9.4 and Figure 9.5). For example, Thrusfield *et al.* (1985) studied the association between breed, sex and degenerative heart valve disease in dogs. Animals were classified as being diseased if they had either audible cardiac murmurs or signs of congestive cardiac failure. However, murmurs and cardiac failure can be produced by lesions other than heart valve incompetence – cardiomyopathy and anaemia are examples. Therefore, in order to prevent dogs with the latter two lesions being incorrectly

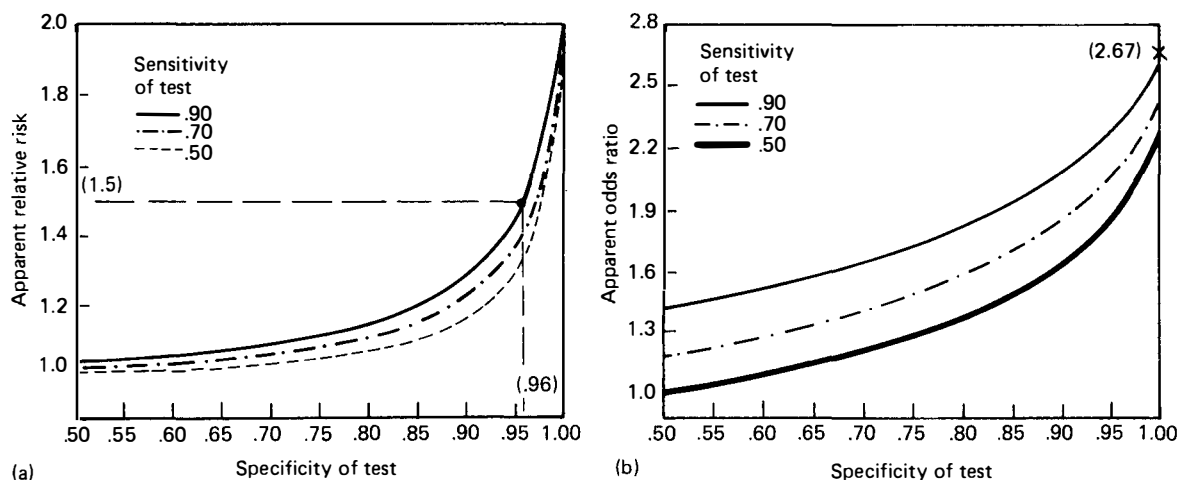

**Fig. 15.2** (a) Cohort study: bias in the estimation of the relative risk as a function of sensitivity and specificity. Disease incidence (cumulative) in exposed and unexposed cohorts is 0.10 and 0.05, respectively. True relative risk (exposed and unexposed) equals 2.0. (b) Case-control study: bias in the estimation of the odds ratio as a function of sensitivity and specificity. Exposure in cases and controls is 40% and 20%, respectively. The true odds ratio equals 2.67. (From Copeland *et al.*, 1977.)

classified as having heart valve incompetence (in which case they would constitute 'false positives'), their case records were scrutinized in detail to ascertain the exact nature of their murmurs. Similarly, early degenerative heart valve disease may not produce audible murmurs, and clinicians may miss the murmurs, in which circumstance animals would be classified incorrectly as disease-free (i.e., 'false negatives').

Two types of misclassification can occur: **non-differential** and **differential**. The former occurs if the magnitude and direction of misclassification are similar in the two groups that are being compared (i.e., either cases and controls, or exposed and unexposed individuals). Non-differential misclassification produces a shift in the estimated relative risk and odds ratio towards zero (Copeland *et al.*, 1977) depicted in *Figures 15.2a* and *15.2b*; respectively. *Figure 15.2a* illustrates that specificity is more important than sensitivity in determining bias in the estimate of relative risk. Even when sensitivity and specificity are seemingly acceptable (90% and 96% respectively, exemplified in *Figure 15.2a*), the relative risk can be severely biased. However, sensitivity plays a more important part as a source of bias in estimation of the odds ratio (*Figure 15.2b*).

Differential misclassification occurs when the magnitude or direction of misclassification is different between the two groups that are being compared. In this case, the odds ratio and relative risk may be biased in either direction (see Copeland *et al.*, 1977, for numerical examples). Therefore, misclassification can not only weaken an apparent association but also strengthen it.

If a simple, valid (i.e., highly specific and sensitive) test is not available, there can be difficulty in defining a case in the absence of a rigorous definition. For example, in an investigation of the relationship between enzootic bovine leucosis (EBL) and human leukaemia (Donham *et al.*, 1980), cattle were defined as being exposed to EBL virus when post-mortem examination revealed alimentary lymphosarcoma, even though this lesion may develop without exposure to the virus, and exposure to the virus may not produce alimentary tumours.

Similarly, it may be difficult to define and quantify a hypothesized causal factor to which an animal is exposed. For example, if 'inadequate feeding' were the factor, then the investigator may have to rely on an opinion based on owners' descriptions of diet, rather than using the more rigorous results of an examination by a nutritionist.

### Confounding

Confounding was introduced in Chapter 3, where its effect on the inferring of causal associations was exemplified. In reiteration, a confounding variable (confounder) is any factor that is either positively or negatively correlated with both the disease and hypothesized causal factors that are being considered. For example, size of herd is a confounding variable in relation to porcine respiratory disease (see *Figure 3.4b*). If fan ventilation were being considered as the factor under study, then the results would be confounded (biased, confused, rendered unrepresentative) if the herds that were fan ventilated and that had respiratory

disease comprised all large herds (which are likely to develop the disease), and the herds that were not fan ventilated and were non-diseased comprised all small herds (which are much less likely to develop the disease). The uneven proportion of large and small herds in each group therefore will confound the association between fan ventilation and disease, therefore distorting the estimation of the odds ratio and relative risk.

Confounding is particularly important in case-control studies because animals are chosen according to presence and absence of disease: therefore cases may have a whole range of factors in common, some of which may be causal, and some of which may be statistically significant but non-causal because of an association with a confounder.

Confounding is not an 'all-or-none' event, but occurs to varying degrees, and can be accompanied by interaction, from which it should be distinguished. A pictorial representation of confounding is given by Rothman (1975). Identification of confounding and interaction are discussed by Miettinen (1972), Ejigou and McHugh (1977), Breslow and Day (1980), Kleinbaum *et al.* (1982), Schlesselman (1982) and Rothman and Greenland (1998), and described briefly below (see 'The Mantel–Haenszel procedure').

These three causes of bias (selection bias, misclassification and confounding) should not be considered in isolation but as an interconnected complex that can distort results.

## Controlling bias

### Selection bias

It is often not possible to control selection bias; this results from inherent characteristics of the study population, and a less biased study population may not be available.

Control can be attempted during either the design or analysis of the investigation. The former essentially involves avoiding the bias by selecting animals from a population that will not produce the bias. This may be impractical and obviously depends on the investigator being aware of the potential bias.

Control during analysis requires knowledge of the probability of selection in the study population and the target population. Kleinbaum *et al.* (1982) provide formulae for this correction.

### Misclassification

The control of non-differential and differential misclassification is described by Barron (1977) and Greenland and Kleinbaum (1983), respectively. Essentially control is effected by algebraic manipulation during analysis, although this is never as satisfactory as using

a highly sensitive and specific test to determine diseased and non-diseased cases.

### Confounding

There are two simple methods of dealing with confounding:

1. by **adjusting** for the confounding variable in the analysis, for example, by using adjusted rates specific to the confounder (see Chapter 4), or by producing a summary odds ratio for the combined odds ratios of each confounder (Mantel and Haenszel, 1959);
2. by **'matching'** the two groups during the design of the study.

Additionally, more complex multivariate methods may be employed (see below). The control of confounding is discussed mainly in the context of case-control studies in this chapter. Breslow and Day (1987) discuss control in cohort studies.

#### *The Mantel–Haenszel procedure*

This technique produces a summary odds ratio, which is the weighted average of individual odds ratios derived by stratifying data with respect to potential confounders. This approach is exemplified using the data in Table 15.5. The crude estimate of the odds ratio has already been calculated (2.99). The 95% confidence interval is 1.71, 5.23, suggesting an association between fan ventilation and pneumonia. However, herd size is also known to be associated with the prevalence of pneumonia **and** type of ventilation (Aalund *et al.*, 1976). Thus, herd size could be confounding the association between fan ventilation and pneumonia that was identified in the crude data (Table 15.5a). The first step in adjusting for this potential confounding is construction of a series of sub-tables, according to herd size (Table 15.5b).

The Mantel–Haenszel summary odds ratio,  $\psi_{mh}$ , is given by:

$$\psi_{mh} = \{\sum(a_i d_i / n_i)\} / \{\sum(b_i c_i / n_i)\},$$

where  $a$ ,  $b$ ,  $c$ ,  $d$  and  $n$  follow the same notation as Table 15.1.

$\sum(a_i d_i / n_i)$  and  $\sum(b_i c_i / n_i)$  are calculated by summing the values of  $ad/n$  and  $bc/n$ , respectively, for each stratum. Thus, for the 'herd size  $\leq 200$ ' stratum,  $a_i d_i / n_i = (2 \times 27) / 40 = 1.35$ , and  $b_i c_i / n_i = (7 \times 4) / 40 = 0.70$ , and the stratum-specific odds ratio,  $\psi_r$ , is 1.93, and so on.

Thus:

$$\begin{aligned} \hat{\psi}_{mh} &= \frac{1.35 + 3.80 + 2.65 + 1.56 + 0.76}{0.70 + 3.38 + 2.71 + 0.56 + 0.68} \\ &= 10.12 / 8.03 \\ &= 1.26. \end{aligned}$$

An approximate 95% confidence interval is given by:

$$\hat{\psi} \exp(-1.96\sqrt{\text{var}}), \hat{\psi} \exp(+1.96\sqrt{\text{var}}),$$

where  $\text{var} =$  the variance of  $\log_e \hat{\psi}_{mh}$

$$= \sum (w_i^2 v_i) / (\sum w_i)^2,$$

where  $w_i = b_i c_i / n_i$ ,

and  $v_i = (a_i + c_i) / a_i c_i + (b_i + d_i) / b_i d_i$ .

Thus, for the 'herd size = 200' stratum:

$$w_i = (7 \times 4) / 40 \\ = 0.70$$

and  $v_i = (2 + 4) / (2 \times 4) + (7 + 27) / (7 \times 27)$   
 $= 0.75 + 0.180$   
 $= 0.93,$

and so on.

$$\sum (w_i^2 v_i) = 0.46 + 3.20 + 2.72 + 0.14 + 0.62 \\ = 7.14.$$

$$(\sum w_i)^2 = (0.70 + 3.38 + 2.71 + 0.56 + 0.68)^2 \\ = 8.03^2 \\ = 64.48.$$

Thus  $\text{var} \log_e \hat{\psi}_{mh} = 7.14 / 64.48,$   
 $= 0.1107.$

Therefore:

$$\hat{\psi} \exp(-1.96\sqrt{\text{var}}), \hat{\psi} \exp(+1.96\sqrt{\text{var}}) \\ = 1.26 \exp(-0.6521), 1.26 \exp(0.6521) \\ = 1.26 \times 0.521, 1.26 \times 1.920 \\ = 0.66, 2.42.$$

The adjusted odds ratio, 1.26, is much less than the crude odds ratio, 2.99, indicating that confounding may be occurring.

The calculation of a summary, adjusted odds ratio implies that it adequately describes the data; that is, that the odds ratios in the different strata are *similar* (homogeneous). If there are major discrepancies in the stratum-specific values, either in the same or opposite direction (i.e., some values being greater than one, and others clearly less than one), then the Mantel-Haenszel procedure should **not** be used. The summary statistic may disguise important real variation, suggesting that *interaction* is present; that is, the effect of the hypothesized causal factor is modified by the potential confounder<sup>8</sup>. This may indicate a biological mechanism for the interaction (i.e., synergism; see the example above relating to the feline urological syndrome) and so should be identified, quantified, reported and explained. Some means of distinguishing between confounding and interaction is therefore needed, and this is fulfilled by testing for homogeneity of the odds ratios across the strata. A simple method<sup>9</sup>, which

can be conducted on a pocket calculator, computes **Woolf's statistic** (Woolf, 1955):

$$\sum_{i=1}^k \left[ \frac{\{\log_e(\hat{\psi}_i) - \log_e(\hat{\psi})\}^2}{\text{var}\{\log_e(\hat{\psi}_i)\}} \right],$$

where, following the notation in *Table 15.5*:

$$\hat{\psi}_i = \text{odds ratio in the } i\text{th stratum,}$$

$$\hat{\psi} = \text{summary odds ratio} = \hat{\psi}_{mh},$$

$$\text{var}\{\log_e(\hat{\psi}_i)\} = v_i.$$

Thus, for the first stratum (herd size  $\leq 200$ ):

$$\frac{\{\log_e(\hat{\psi}_{i=1}) - \log_e(\hat{\psi})\}^2}{\text{var}\{\log_e(\hat{\psi}_{i=1})\}} = \frac{(\log_e 1.93 - \log_e 1.26)^2}{0.93} \\ = \frac{(0.6575 - 0.2311)^2}{0.93} \\ = \frac{0.1818}{0.93} \\ = 0.196;$$

and for the second to fifth strata, the values are 0.042, 0.055, 1.417 and 0.009, respectively.

Therefore:

$$\sum_{i=1}^k \left[ \frac{\{\log_e(\hat{\psi}_i) - \log_e(\hat{\psi})\}^2}{\text{var}\{\log_e(\hat{\psi}_i)\}} \right] \\ = 0.196 + 0.042 + 0.055 + 1.417 + 0.009 = 1.719.$$

Woolf's statistic has a  $\chi^2$  distribution, with  $k - 1$  degrees of freedom, where  $k =$  the number of strata. There are five strata, and so, consulting row 4 of Appendix IX, the value of 1.719 is less than the tabulated value for  $P = 0.05$  (9.488); thus, there is *insufficient* evidence, at the 5% level of significance<sup>10</sup>, that the stratum-specific odds ratios are not homogeneous, and so it is concluded that the difference between the crude and adjusted odds ratios is the result of the confounding effect of herd size, rather than interaction. The sub-tables may therefore be collapsed legitimately to produce a summary adjusted odds ratio.

Note that the confidence interval for the adjusted odds ratio (0.66, 2.42) includes one, indicating that there is not a significant association between fan

<sup>8</sup> *Effect modification* is therefore also sometimes used to describe this interaction between factors (Miettinen, 1974).

<sup>9</sup> The method was devised in the context of the 'logit method' for estimating the summary odds ratio (which is not described in this book; see Sahai and Kurshid (1995) for details), but generally performs acceptably with other methods of estimation.

<sup>10</sup> Tests for homogeneity have low power, and so some authorities advocate conservative interpretation; say, at the 10% level of significance.

ventilation and pneumonia when the confounding effect of herd size has been removed.

A widely used alternative test for homogeneity, which is too cumbersome to compute on a pocket calculator, is the **Breslow–Day test** (Breslow and Day, 1980). Fortunately, it can be undertaken by some statistical packages (e.g., *WINEPISCOPE*: Appendix III). The Breslow–Day statistic also has a  $\chi^2$  distribution, with  $k - 1$  degrees of freedom. Using appropriate software, the Breslow–Day statistic has a value of 1.02 – somewhat lower than Woolf’s statistic. Consulting Appendix IX, the same conclusion is reached:  $P > 0.05$ , and the summary odds ratio may therefore be quoted.

In summary, assessment of confounding therefore includes these steps:

- calculate the crude odds ratio;
- calculate the adjusted odds ratio;
- decide whether the difference between the crude and the adjusted values is ‘big’ (this is somewhat arbitrary); if the answer is ‘yes’, then there is confounding and the adjusted odds ratio should be used, if *there is no interaction*;
- assess if the stratum-specific odds ratios are homogeneously distributed across the strata (e.g., using either Woolf’s statistic or the Breslow–Day statistic); if not, there is interaction, and the subtables should not be collapsed.

The Mantel–Haenszel procedure is applicable to estimation of summary odds ratios for all three types of study, and there is also a modification for summary relative risk estimation in cohort studies based on animal-(person)-years at risk (Kahn and Sempos, 1989).

**Matching** Matching is the process of making the groups that are being compared comparable with respect to a potential confounder. It can be undertaken in case-control and cohort studies, and can be performed in two ways:

1. **frequency matching**, in which the groups to be sampled are divided so as to contain the same proportion of the potentially confounding variable; for example, if there are four times as many males as females in the case group, then the control group also should be selected to contain four times as many males as females; this technique therefore is a form of stratification (see Chapter 13);
2. **individual matching**, a more precise form of matching in which each case is matched with a control with respect to the variable; for example, a 6-year-old dog with bladder cancer is paired with a 6-year-old dog without bladder cancer (matching for age).

Matching is useful when potential confounders are complex and difficult to measure or define (e.g., farm environments). Additionally, it can ensure comparability in terms of the information that is collected. However, it is cumbersome to match for many possible confounding variables. It is usual to match for the main possible ones: age, sex and breed (i.e., common determinants: see Chapter 5). As a general rule, if the confounding variable is unevenly distributed in the population (e.g., age in relation to chronic nephritis), then it is better to match cases or controls when the study is designed, rather than correct for them in the analysis (all young control animals would, in a sense, be wasted when considering chronic nephritis). Unnecessary matching (‘overmatching’) should be avoided (Miettinen, 1970). If the effect of a factor is in doubt, then it is best not to match but to control it in subsequent analysis; **when a factor is matched, it cannot be studied separately.**

Matching is used to prevent confounding in cohort studies. However, in case-control studies, the main value of matching is the enhanced efficiency in controlling confounding in subsequent stratified analysis (Rothman and Greenland, 1998). (Matching can in itself be a source of confounding in case-control studies, notably when the matched factor is correlated with the exposure factor but not with disease.)

Matched studies should be analysed as such. The simplest matched study involves 1:1 matching, where one matched control is chosen for each case (Table 15.8). Matching results in the two groups being **related**; thus, McNemar’s change test (see Chapter 14), rather than the  $\chi^2$  test, can be used to assess the significance of observed differences between exposure status in cases and controls. The formula for the odds ratio uses just discordant pairs:

$$\hat{\psi} = s/t.$$

The variance (var) of  $\log_e \hat{\psi}$  is approximately equal to  $(1/s + 1/t)$ , and an approximate 95% confidence interval for large samples is again:

$$\hat{\psi} \exp(-1.96\sqrt{\text{var}}), \hat{\psi} \exp(+1.96\sqrt{\text{var}})$$

Calculation of exact intervals is described by Schlesselman (1982).

The analysis of studies where the matching ratio is not 1:1, and where further stratification is also practised during analysis, is more complex (Elwood, 1998).

**Table 15.8** Format for a 1:1 matched case-control study: numbers of pairs.

	Controls exposed	Controls unexposed
Cases exposed	$r$	$s$
Cases unexposed	$t$	$u$

## What sample size should be selected?

Appropriate sample sizes can be determined for cohort and case-control studies. The principles relating to sample size determination, outlined in Chapter 14, are followed. The examples below are conservatively based on two-tailed tests.

### Cohort studies

Four values should be specified to determine optimum sample size in a cohort study:

1. the desired level of significance ( $\alpha$ : the probability of a Type I error – claiming that exposure to a factor is associated with a disease when, in fact, it is not);
2. the power of the test ( $1 - \beta$ : the probability of claiming correctly that exposure to a factor is associated with disease, where  $\beta$  is the probability of a Type II error);
3. the anticipated incidence of disease<sup>11</sup> in unexposed animals in the target population;
4. a hypothesized relative risk that is considered important enough, from the point of view of the health of the animal population.

The formula, for an unmatched study in which exposed and unexposed cohorts of equal size, and the hypothesis is conservatively two-tailed, is:

$$n = \frac{(p_1q_1 + p_2q_2)K}{(p_1 - p_2)^2},$$

where:

- $n$  = number required in **each** cohort;
- $p_1$  = anticipated incidence in unexposed animals;
- $q_1 = 1 - p_1$ ;
- $p_2$  = minimum incidence to be detected in exposed animals;
- $q_2 = 1 - p_2$ ;
- $K = (M_{\alpha/2} - M_{\beta})^2$  where  $M_{\alpha/2}$  and  $M_{\beta}$  are the respective multipliers associated with  $\alpha$  and  $\beta$ .

For example, if a relative risk of three or more is to be detected, the anticipated incidence in unexposed animals during the period of the study is one per 100, and significance level and test power are set at 0.05 and 0.80 ( $\beta = 0.20$ ), respectively, then:

$$p_1 = 0.01, \\ q_1 = 0.99,$$

$$p_2 = 0.03 \text{ (because the relative risk is set at three),} \\ q_2 = 0.97.$$

From Appendix XV,

$$M_{\alpha/2} = 1.96,$$

$$M_{\beta} = 0.84.$$

Therefore:

$$K = (1.96 + 0.84)^2 \\ = 7.84.$$

Thus:

$$n = \frac{(0.01 \times 0.99 + 0.03 \times 0.97) \times 7.84}{(0.01 - 0.03)^2} \\ = 0.306 / 0.0004 \\ = 765.$$

Therefore, a total of 1530 animals is needed for the study.

If a disease is rare, a cohort study requires a considerable number of animals in the exposed and unexposed groups to detect a significant difference, especially when the relative risk is small.

If the cohort sizes are different, a matched study is conducted, or a confounding factor is to be addressed, modifications of this formula are used (Breslow and Day, 1987; Elwood, 1998).

### Case-control studies

Four values should be specified to determine optimum sample size in a case-control study:

1. the desired level of significance;
2. the power of the test;
3. the proportion of controls exposed to the risk factor;
4. a hypothesized odds ratio that is considered important enough, from the point of view of the health of the animal population.

The formula used to determine cohort sample sizes is used, but:

$p_1$  = proportion of cases exposed to the risk factor;

$p_2$  = proportion of controls exposed to the risk factor.

The value of  $p_1$  is estimated from  $p_2$ , given the specified odds ratio:

$$p_1 = \frac{p_2 \times \psi}{1 + p_2(\psi - 1)}.$$

For example, if an odds ratio of four or more is to be detected, the anticipated proportion of controls exposed to the risk factor is 0.05 (5%), and significance

<sup>11</sup> Cumulative incidence must be specified. There is no simple method for sample-size calculation using incidence rates (i.e., based on animal-years at risk).



and test power are set at 0.05 and 0.80, respectively, (two-tailed hypothesis) first estimate  $p_1$ :

$$\begin{aligned} p_1 &= \frac{0.05 \times 4}{1 + 0.05(4 - 1)} \\ &= 0.2/1.15 \\ &= 0.174. \end{aligned}$$

Again,  $K = 7.84$ .

Thus:

$$\begin{aligned} n &= \frac{(0.174 \times 0.826 + 0.05 \times 0.95) \times 7.84}{(0.174 - 0.05)^2} \\ &= 1.499/0.015 \\ &= 100. \end{aligned}$$

Therefore, a total of 200 animals is needed for the study.

If exposure to the risk factor is rare in the target population, a case-control study requires a considerable number of animals in the case and control groups to detect a significant difference, especially when the odds ratio is small.

If the case and control group sizes are different, a matched study is conducted, or a confounder is to be addressed when the study is designed, modifications of this formula are used (Breslow and Day, 1987; Elwood, 1998). Matching criteria and stratum sizes are discussed by Greenland *et al.* (1981).

Tables of the smallest and largest detectable relative risks and odds ratios, for different values of specified parameters, are given by Walter (1977). Sample size estimations that include cost functions are described by Pike and Casagrande (1979).

## Calculating the power of a study

The number of animals available for inclusion in a study may be limited (e.g., by financial constraints, availability or time). Additionally, a study may not detect a significant association between a risk factor and disease. In such circumstances, the investigation may have had insufficient **power**, and it may be useful to know the value of the study's power in detecting various levels of increased risk.

First, the value of  $M_\beta$  appropriate to the study is calculated. For a case-control study with groups of equal size, and a two-tailed test:

$$M_\beta = \sqrt{\frac{(p_1 - p_2)^2 n}{p_1 q_1 + p_2 q_2}} - M_{\alpha/2}$$

where  $p_1$ ,  $q_1$ ,  $p_2$  and  $q_2$  follow the same notation as that used in the formula for calculation of sample sizes

in case-control studies, and  $n$  = number of animals studied in each group.

For example, suppose that a case-control study was conducted to investigate the association between urinary incontinence and spaying in bitches, and that only 50 dogs were studied in each group. If 40% of control dogs were spayed, then  $p_2 = 0.40$ . If a twofold increase in risk in spayed bitches is to be detected, then  $\psi = 2$ , and:

$$\begin{aligned} p_1 &= \frac{p_2 \times \psi}{1 + p_2(\psi - 1)} \\ &= \frac{0.40 \times 2}{1 + 0.40(2 - 1)} \\ &= 0.80/1.40 \\ &= 0.57. \end{aligned}$$

Thus:

$$\begin{aligned} q_1 &= 1 - 0.57 \\ &= 0.43; \\ q_2 &= 1 - 0.40 \\ &= 0.60; \\ n &= 50. \end{aligned}$$

If the level of significance is 0.05,  $M_{\alpha/2} = 1.96$ , and:

$$\begin{aligned} M_\beta &= \sqrt{\frac{(0.57 - 0.40)^2 \times 50}{(0.57 \times 0.43) + (0.40 \times 0.60)}} - 1.96 \\ &= \sqrt{\frac{1.455}{0.481}} - 1.96 \\ &= 1.73 - 1.96 \\ &= -0.23. \end{aligned}$$

Appendix XV is now consulted. Note, though, that the value of  $M_\beta$  is *negative*<sup>12</sup> in this example, but, for brevity, the appendix only tabulates  $\beta$  for *positive* values of  $M_\beta$ . However, the appendix can still be used because the value of  $\beta$  for a negative  $M_\beta$  is one minus the value of  $\beta$  for a positive  $M_\beta$ . Thus, when  $M_\beta$  is negative, using the appendix as if  $M_\beta$  is positive directly provides the power (because power =  $1 - \beta$ ). The value of  $\beta$  corresponding to  $M_\beta = 0.23$  is 0.4090, and this is therefore the power of the study. Thus, if the odds ratio in the target population were two, a study comprising 50 cases and 50 controls would only have a 41% chance of finding that the sample estimate will be significantly ( $\alpha = 0.05$ ) greater than one.

<sup>12</sup> Negative values of  $M_\beta$  indicate a power of less than 50%, whereas positive values point to a value greater than 50%.

**Table 15.9** Association between progestin treatment and pyometra in nulliparous dogs in Finland: odds ratio ( $\psi$ ) and its 95% confidence interval. (From Niskanen and Thrusfield, 1998.)

	Cases	Controls	Odds ratio $\psi$	95% confidence interval for $\psi$
Progestin treated	6	47	1.36	0.47, 3.20
Untreated	925	9865		

$P = 0.457$  (Fisher's two-tailed test)

$\alpha = 0.05$ :

$\psi = 2$ ; power = 0.41; likelihood = 0.19

$\psi = 3$ ; power = 0.83; likelihood = 0.04

Schlesselman (1982) gives an appropriate formula for determining power when case and control groups are of unequal size.

A similar calculation of power can be made for cohort studies based on cumulative incidence, with:

- $p_1$  = anticipated incidence in unexposed animals;
- $p_2$  = minimum incidence to be detected in exposed animals.

The formula can also be applied for power calculations in clinical trials (see Chapter 16) when outcome is measured as a proportion.

Elwood (1998) gives an appropriate formula for determining power when exposed and unexposed cohorts are of unequal size.

If incidence rates are used in calculating the relative risk, then the power, with a two-tailed hypothesis, is calculated thus (Thrusfield *et al.*, 1998):

$$M_\beta = \frac{(N_2 \times RR \times p_1) - (N_1 \times p_1) - (M_{\alpha/2} \times \sqrt{N_1 \times p_1}) - 1}{\sqrt{N_2 \times RR \times p_1}}$$

where:

- $p_1$  = incidence rate in the unexposed cohort;
- $N_1$  = animal time at risk in the unexposed cohort;
- $N_2$  = animal time at risk in the exposed cohort;
- $RR$  = relative risk to be detected;

and  $M_{\alpha/2}$  and  $M_\beta$  follow the usual notation.

Lipsey (1990) discusses power calculations for continuous response variables.

### Calculating upper confidence limits

Some authors suggest that calculation of power after a study has been completed is uninformative because it does not utilize information acquired during the study (notably, an estimate of the relative risk/odds ratio, and its variance), and can be misleading (Smith and Bates, 1992; Goodman and Berlin, 1994).

Consider the results of a case-control study of the relationship between progestin treatment and canine pyometra (Table 15.9). A significant association at the 5% level was not detected ( $P > 0.05$ ), and the 95% confidence interval for the odds ratio therefore included one. Post-study power calculation (as described above) revealed that the power of the study to detect an odds ratio of two and three was 0.41 and 0.83, respectively ( $\alpha = 0.05$ ). However, this does not incorporate the information that has been gleaned about the likely value of the odds ratio, which the sample estimate of 1.36 reveals. It may therefore be argued that there is little value in computing the power of the study to detect an odds ratio of three when the study suggests that the value is somewhat lower.

An alternative approach involves calculation of the upper confidence limit that just 'touches' the value of interest, and therefore the likelihood of the odds ratio exceeding this value. The following formula is used:

$$\hat{z}_\alpha = \frac{-\log_e(U/\hat{\psi})}{\text{var}^{1/2}}$$

where:

- $\hat{z}_\alpha$  = estimate of the standardized Normal deviate;
- $U$  = the value of the odds ratio of interest;
- $\hat{\psi}$  = study estimate of the odds ratio;
- var = variance of the Natural logarithm of this estimate.

For example, considering the data in Table 15.9:

$$\hat{\psi} = 1.36;$$

$$\text{var} = 1/6 + 1/47 + 1/925 + 1/9865 = 0.1891.$$

If the odds ratio of interest is two,  $U = 2$ , and:

$$\begin{aligned} \hat{z}_\alpha &= \frac{-\log_e(2/1.36)}{0.1891^{1/2}} \\ &= \frac{-0.3857}{0.4349} \\ &= -0.8869. \end{aligned}$$

Appendix XV is then consulted. The negative sign is ignored<sup>13</sup>, and the nearest tabulated value of  $z_\alpha$  is 0.89, with a related  $P$  value of 0.1867. This corresponds to a confidence interval of  $\{1 - (2 \times 0.1867)\}\%$  (because the tabulated probabilities are one-tailed); that is, a 62.66% confidence interval. Therefore, the upper 62.66% confidence limit just touches an odds ratio of two. The interval is symmetric, and so the likelihood of the odds ratio being greater than two is  $(1 - 0.6266)/2 = 0.1867$ . (Note that, for negative values of  $\hat{z}_\alpha$ , the likelihood can therefore be read directly from the tabulated  $P$  value.)

If the procedure is repeated for  $U = 3$ , the likelihood is 0.0351.

Thus, although the power of the study to detect an odds ratio of two or greater is 0.41 (i.e., approaching 50%), the likelihood of the odds ratio actually being two or more is only 0.19 ('19%'). More strikingly, the power to detect an odds ratio of at least three is impressive (0.83), but the likelihood of the odds ratio actually being that high is very low (0.04).

The same formula can be applied in cohort studies, with the relative risk replacing the odds ratio.

## Multivariate techniques

In case-control studies, if matching is practised to adjust for confounding, there may be many  $2 \times 2$  contingency tables, for example for different combinations of age, sex, breed and management practices. The number of animals in each cell may then be small (even zero), resulting in inestimable or large confidence intervals that are statistically insignificant. Similarly, if the odds ratio varies considerably between each contingency table, calculation of a summary adjusted odds ratio is inappropriate. These problems can be overcome by using multivariate techniques, which can simultaneously consider the individual and joint effects of many factors, the number of which can be substantial (Dohoo *et al.*, 1996). These techniques (which are essentially mathematical models) also provide 'smoothed' estimates of the effects of factors by depressing variation induced by unimportant variables. Common methods use a **logistic model** for discrete and continuous variables and a **loglinear model** for discrete variables and stratified continuous data (Schlesselman, 1982). The former model is applicable to cohort and case-control studies, and is easily interpretable in terms of the relative risk and odds ratio. It is, however, more complex than the analytical

methods described above, and therefore requires more intense study. In practice, appropriate computer programs are usually needed to 'fit' the model to data. It is presented formally below, with an example. Detailed descriptions of model building, including identification of interaction and confounding, are given in texts cited at the end of this chapter.

## The logistic model

The logistic model derives its name from its use of natural logarithms ( $\log_e$ ). It is based on a mathematical function that can be used to describe several biological phenomena including growth curves (see *Figure 7.4*) and dose-response relationships in biological assays.

It may be thought that a linear regression model (see Chapter 8) can represent the relationship between the probability of disease and the presence or absence of one or more risk factors, either alone or in combination. However, such a model may predict values that are outside the permitted range of 0 to 1. Also, when fitting a linear regression model, the variance of the response variable is assumed to be a constant, independent of the values of the explanatory variables. This is not the case with a binary response variable – presence or absence of disease in this context – where the variance is proportional to  $P(1 - P)$ , where  $P$  is the true, but unknown, probability of disease.

These problems are overcome by using a **logistic transformation**<sup>14</sup>. Let  $P$  be the probability of disease occurrence ( $0 < P < 1$ ). The logistic transformation of  $P$  is defined to be  $\log_e\{P/(1 - P)\}$ , where  $P/(1 - P)$  is the odds of developing disease. Define the transformed variable to be  $y$ , say, so that  $y = \log_e\{P/(1 - P)\}$ . This transformation can take values ranging from 'minus infinity' when  $P = 0$ , to 'plus infinity' when  $P = 1$  (i.e., it is unrestricted). Linear regression techniques may then be applied to this transformed variable. The function  $\log_e\{P/(1 - P)\}$  is known as the **logit** of  $P$ . Once a value of  $y$  has been predicted, the corresponding values for  $P = \exp(y)/\{1 + \exp(y)\}$ . (Note that this takes values in the range 0 to 1.)

Now consider the simple  $2 \times 2$  contingency table (*Table 15.1*). Suppose, in a cohort study, that a proportion,  $p$ , of animals was exposed at the beginning of the study. Denote by  $P_0$  the probability of an exposed animal developing disease, and by  $P_1$  the corresponding probability for an unexposed animal. Let  $Q_0$  and  $Q_1$  be  $1 - P_0$  and  $1 - P_1$ , respectively; and  $q = 1 - p$ . The expected proportions of animals falling into each of

<sup>13</sup> If the value of  $\hat{z}_\alpha$  is positive, one minus the tabulated probability is used: negative values yield likelihoods less than 0.5, whereas positive values give likelihoods greater than 0.5, but Appendix XV only tabulates  $P$  for negative values.

<sup>14</sup> Other transformations that have been suggested are the **probit** transformation (Finney, 1971) and the **complementary log-log** transformation (Collett, 2003).

**Table 15.10** The expected proportions of animals falling into each of the four cells of the  $2 \times 2$  contingency table constructed in observational studies, given the probabilities  $P_0$  ( $P_1$ ) of exposed (unexposed) animals developing disease, and the proportion,  $p$ , of animals exposed at the beginning of the study.

	Diseased animals	Non-diseased animals	Total
Animals exposed to the risk factor	$pP_0$	$pQ_0$	$p$
Animals not exposed to the risk factor	$qP_1$	$qQ_1$	$q$
Total	$pP_0 + qP_1$	$pQ_0 + qQ_1$	1

the four cells of the contingency table are given in Table 15.10.

The odds ratio  $\psi = (P_1 \times Q_0)/(P_0 \times Q_1)$ .

The logarithm of the odds ratio,  $\beta$ , may be expressed as:

$$\begin{aligned}\beta &= \log_e \psi \\ &= \text{logit}(P_0) - \text{logit}(P_1),\end{aligned}$$

the difference between the two logits.

This formulation is in the context of cohort studies; however, the same model can be applied to case-control studies, in which the interpretation of the parameters  $\beta_i$  is essentially the same.

#### An example of expansion of the logistic regression model: a case-control study of vaccinal efficacy against canine infectious tracheobronchitis (kennel cough)

Canine kennel cough is a multifactorial disease in which several infectious agents have been incriminated (Table 15.11). Vaccines are available for protection against *Bordetella bronchiseptica*, CPIV, CAV-1, CAV-2 and CDV. However, isolation of specific causal agents is rarely justified and frequently impractical in the field, and so direct assessment of the efficacy of the individual vaccines is impossible. However, an indirect assessment can be made by comparing the probability of disease in dogs vaccinated with various combinations of vaccine with the probability in unvaccinated dogs. Thus, several explanatory variables (the vaccines) are being considered simultaneously.

A suitable approach would be to conduct a case-control study of cases using data collected, by questionnaire, from general practices (Thrusfield *et al.*, 1989a). In this instance, the unvaccinated state constitutes a risk factor for developing kennel cough, and vaccinal efficacy therefore is defined in relation to a reduction in estimated relative risk, (approximated by  $\psi_e$  because this is a case-control study<sup>15</sup>).

Vaccinal status,  $x$ , is a dichotomous variable which needs to be coded '0' indicating absence of vaccination

**Table 15.11** Microorganisms incriminated in kennel cough. (Modified from Thrusfield, 1992.)

Major microorganisms	Minor microorganisms
<i>Bordetella bronchiseptica</i>	<i>Bacillus</i> spp.
Canine parainfluenza virus (CPIV)	Canine adenoviruses Type 1 (CAV-1) Type 2 (CAV-2)
	Canine distemper virus (CDV)
	<i>Corynebacterium pyogenes</i>
	<i>Mycoplasma</i> spp.
	<i>Pasteurella</i> spp.
	<i>Staphylococcus</i> spp.
	<i>Streptococcus</i> spp.

('exposed'), and '1' indicating its presence ('unexposed'). This type of variable is called a 'dummy' or 'indicator' variable because it has no numerical significance.

The derivation of the logistic regression model in this context is eased by the use of slightly different notation.

Thus, let  $P(x)$  be the probability of a dog developing kennel cough if its vaccinal status is  $x$ . Then:

$$P(1) = P_1,$$

$$P(0) = P_0.$$

Write:

$$r(x) = \frac{P(x)Q_0}{P_0Q(x)}.$$

Then  $\log_e r(x) = \log_e \{P(x)/Q(x)\} - \log_e \{P_0/Q_0\}$

and  $\text{logit}\{P(x)\} = \text{logit}\{P_0\} + \log_e \{r(x)\}$ .

Let  $\alpha = \text{logit}\{P_0\}$ .

Then  $\text{logit}\{P(x)\} = \alpha + \log_e \{r(x)\}$ .

When  $x = 0$ ,  $\text{logit}\{P(x)\} = \text{logit}\{P(0)\} = \alpha$ , by definition.

Thus,  $\log_e \{r(0)\} = 0$ .

Let  $\beta = \log_e \{r(1)\}$ .

Then  $\text{logit}\{P(x)\}$  may be written in the linear form  $\alpha + \beta x$ , where  $x$  is a dummy variable taking the values 0 (exposed) and 1 (unexposed).

Thus:

$$\text{logit}\{P(x)\} = \alpha + \beta x,$$

and a simple linear logistic model has been derived. There is one explanatory variable, which takes the values 0 (exposed; i.e., unvaccinated) or 1 (unexposed; i.e., vaccinated).

<sup>15</sup> For a discussion of transformation of odds ratios to relative risks in logistic regression, see Beaudeau and Fourichon (1998); and, for calculation of the population attributable proportion, see Bruzzi *et al.* (1985).

The two parameters,  $\alpha$  and  $\beta$ , in the model and the two risks correspond perfectly such that:

$$P_1 = P(1) = \exp(\alpha + \beta) / \{1 + \exp(\alpha + \beta)\};$$

and:

$$P_0 = \exp(\alpha) / \{1 + \exp(\alpha)\}.$$

In this example,  $\beta$  will be less than zero. A negative value of  $\beta$  indicates that dogs that have not been vaccinated have a higher risk of developing kennel cough than those that have been vaccinated.

This formulation extends naturally to the situation where there are two vaccines. Define the dichotomous 'dummy' variable  $x_i$  to be 1 or 0 according to a dog's vaccinal status against vaccine  $i$ , where  $i$  may take the value 1 or 2, corresponding to the two possible vaccines. Thus,  $x_1 = 1$  indicates that the dog was vaccinated with vaccine 1;  $x_1 = 0$  indicates that the dog was not vaccinated with vaccine 1;  $x_2 = 1$  indicates that the dog was vaccinated with vaccine 2;  $x_2 = 0$  indicates that the dog was not vaccinated with vaccine 2;  $(x_1, x_2)$  indicates the dog's vaccinal status with vaccines 1 and 2.

Define  $P(x_1, x_2)$  as the disease probability corresponding to vaccinal status  $(x_1, x_2)$ , and  $r(x_1, x_2)$  as the odds ratio of  $P(x_1, x_2)$  relative to the exposed (unvaccinated) category  $x_1 = x_2 = 0$ . (This represents the inverse of the usual ratio in observational studies, where the relative risk and odds ratio are relative to the *unexposed* category because exposure is usually in terms of presence, rather than absence, of a factor. Recall that exposure is defined as *absence* of vaccination.) These odds ratios and, equivalently, the probabilities, may be expressed using the model:

$$\log_e\{r(x_1, x_2)\} = (\beta_1 x_1) + (\beta_2 x_2) + (\gamma x_1 x_2),$$

or:

$$\text{logit}\{P(x_1, x_2)\} = \alpha + (\beta_1 x_1) + (\beta_2 x_2) + (\gamma x_1 x_2). \quad (\text{Equation 1})$$

In this example, there are four parameters,  $\alpha$ ,  $\beta_1$ ,  $\beta_2$  and  $\gamma$ , to describe four probabilities,  $P(0,0)$ ,  $P(0,1)$ ,  $P(1,0)$  and  $P(1,1)$  (summarized as  $P(x_1, x_2)$ ), and therefore the model is termed 'saturated'. The model makes no assumptions about the association between disease status and exposure status. The log odds ratios for the individual exposures are given by:

$$\beta_1 = \log_e\{r(1,0)\};$$

$$\beta_2 = \log_e\{r(0,1)\};$$

$$\begin{aligned} \gamma &= \log_e[\{r(1,1)\} / \{r(1,0) \times r(0,1)\}] \\ &= \text{logit}\{P(1,1)\} - \text{logit}\{P(1,0)\} - \text{logit}\{P(0,1)\} \\ &\quad + \text{logit}\{P(0,0)\}. \end{aligned}$$

The parameter,  $\gamma$ , is an **interaction** parameter, and the function,  $\exp(\gamma)$ , of  $\gamma$  is an indication of any statistical interaction between factors. In this model,

interaction is *multiplicative* and represents the multiplicative factor by which the odds ratio for those animals vaccinated with both vaccines differs from the product of the odds ratios for those receiving only one of the individual vaccines. If  $\gamma > 0$ , there is 'positive' interaction and the reduction in risk of developing kennel cough for dogs that have received both vaccines is not as great as that predicted by simply multiplying the effects, as measured by the corresponding odds ratios, of giving each vaccine separately (and the converse if  $\gamma < 0$ ). If  $\gamma = 0$  (no interaction), then the reduction in the risk of developing kennel cough for dogs that have received both vaccines is that predicted simply by multiplying the effects of giving each vaccine separately.

It is possible to test the hypothesis that  $\gamma = 0$  for a given data set and, if this hypothesis is not rejected, to fit the reduced model, which excludes the interaction parameter:

$$\text{logit}\{P(x_1, x_2)\} = \alpha + (\beta_1 x_1) + (\beta_2 x_2). \quad (\text{Equation 2})$$

In this circumstance,  $\beta_1$  now represents the  $\log_e \psi$  for vaccine 1 relative to not receiving vaccine 1, whether or not the dog has been vaccinated with vaccine 2. This is a different interpretation than that from the saturated model (Equation 1). In the saturated model,  $\beta_1$  represents the  $\log_e \psi$  for vaccine 1 at level 0 (not vaccinated) of vaccine 2 whereas, in the reduced model,  $\beta_1$  represents the  $\log_e \psi$  for vaccine 1 independent of the level of vaccine 2. Testing the hypothesis  $\beta_1 = 0$  in the reduced model is equivalent to testing the hypothesis that vaccine 1 has no effect on risk, against the alternative hypothesis that there is an effect, but one that does not depend on vaccine 2.

This approach can be easily generalized to incorporate the effects of more than two vaccines. Thus, for five vaccines, the extension to the reduced model (Equation 2) is given by:

$$\begin{aligned} \text{logit}\{P(x_1, x_2, x_3, x_4, x_5)\} &= \alpha + (\beta_1 x_1) + (\beta_2 x_2) + (\beta_3 x_3) \\ &\quad + (\beta_4 x_4) + (\beta_5 x_5). \end{aligned}$$

If a better fit is provided by a model that includes some interaction terms, it is important to assess the significance of the interaction.

The results of the case-control study are presented in Table 15.12. The background risk (equivalent to  $\alpha = \text{logit}(P_0)$ ) is represented by dogs vaccinated against CDV because all dogs in the study were vaccinated against this virus. Efficacy of CDV vaccine therefore was not considered.

The model was fitted to these data using an appropriate statistical package (*GLIM: Generalised Linear Interactive Modelling*; see Appendix III), the best fit being provided by one that included some interaction terms. The estimated values of the parameters for various vaccine combinations in the model, and their

**Table 15.12** Estimates and their associated standard errors of the log odds ratio\* in favour of a kennel cough case for each of five vaccines and their associated interactions relative to vaccination only with canine distemper virus vaccine. (From Thrusfield *et al.*, 1989a.)

Vaccine	Estimated log odds ratio ( $\log_e \psi$ )	Standard error of $\log_e \psi$
<i>B. bronchiseptica</i>	-0.3	0.48
CPIV	-2.0	0.53
CAV-1 (inactivated)	-0.7	0.21
CAV-1 ('live')	-2.8	0.84
CAV-2	-0.2	0.26
<i>B. bronchiseptica</i> + CPIV	1.3	0.42
<i>B. bronchiseptica</i> + CAV-1 (inactivated)	0.8	0.55
<i>B. bronchiseptica</i> + CAV-1 ('live')	-2.2	0.78
CPIV + CAV-1 (inactivated)	2.7	0.69
CPIV + CAV-1 ('live')	3.8	0.99
<i>B. bronchiseptica</i> + CAC-2	-1.5	0.56
CPIV + CAV-2	1.1	0.57

\* A reduction is indicated by a negative value, and an increase by a positive value.

**Table 15.13** The relationship between 'dummy' variables and vaccinal status. (From Thrusfield *et al.*, 1989a.)

'Dummy' variable	Value of 'dummy' variable	Vaccinal status
$x_1$	1	<i>B. bronchiseptica</i> given
	0	<i>B. bronchiseptica</i> not given
$x_2$	1	CPIV given
	0	CPIV not given
$x_3$	1	CAV-1 (inactivated) given
	0	CAV-1 (inactivated) not given
$x_4$	1	CAV-1 ('live') given
	0	CAV-1 ('live') not given
$x_5$	1	CAV-2 given
	0	CAV-2 not given

associated standard errors, are given in Table 15.12. The model that was fitted is thus:

$$\text{logit}\{P(x_1, x_2, x_3, x_4, x_5)\} = -0.3x_1 - 2.0x_2 - 0.7x_3 - 2.8x_4 - 0.2x_5 + 1.3x_1x_2 - 0.8x_1x_3 - 2.2x_1x_4 + 2.7x_2x_3 + 3.8x_2x_4 - 1.5x_1x_5 + 1.1x_2x_5,$$

where  $x_1, \dots, x_5$  are defined in Table 15.13.

The model may be used to predict the effect of various vaccine combinations. For example, the  $\log_e \psi$  for a dog vaccinated against CDV, *B. bronchiseptica* and CAV-2 (for which  $x_1 = 1, x_2 = x_3 = x_4 = 0, x_5 = 1$ ) is calculated from the results in Table 15.12 thus:  $-0.3 - 0.2 - 1.5 = -2.0$ .

This computation includes the main effects of the individual vaccines (the first two numbers) and the interaction (the third number).

Table 15.14 presents the results for the usual combinations of vaccines. Interactions are present, for example that between *B. bronchiseptica* and CPIV vaccines. This could be explained *biologically* by the potentiating effect of prior inapparent infection with *B. bronchiseptica* on CPIV infection (Wagener *et al.*, 1984). This could result in more CPIV infections being manifest clinically in dogs with both infections, and would therefore explain why *B. bordetella* vaccine could have a protective effect against CPIV-induced kennel cough. Equally, however, it could simply have resulted from combined vaccination with these two vaccines occurring in dogs that had an increased risk of infection (e.g., in dogs that were vaccinated electively against these two major microorganisms because they were being kennelled), in which circumstance the interaction is interpreted predictively.

The log odds ratio can be converted to the odds ratio by taking the antilog<sub>e</sub>. Thus, for the combination of CDV, CAV-1 ('live') and *B. bronchiseptica* vaccines, the  $\log_e \psi$  is -5.3, and antilog<sub>e</sub> -5.3 = 0.005.

The associated standard error of the  $\log_e \psi$  is 1.04. An approximate 95% confidence interval for  $\log_e \psi$  can be constructed using the Normal approximation:

**Table 15.14** Estimates and their associated standard errors of the log odds ratio\* in favour of a kennel cough case for common combinations of vaccine, relative to vaccination with canine distemper virus vaccine only. (From Thrusfield *et al.*, 1989a.)

Vaccine combination	Estimated log odds ratio ( $\log_e \psi$ )	Standard error of $\log_e \psi$
CDV + CAV-1 (inactivated) + <i>B. bronchiseptica</i>	-1.8	0.33
CDV + CAV-1 (inactivated) + CPIV	-0.1	0.50
CDV + CAV-1 (inactivated) + <i>B. bronchiseptica</i> + CPIV	0.1	0.61
CDV + CAV-1 ('live') + <i>B. bronchiseptica</i>	-5.3	1.04
CDV + CAV-1 ('live') + CPIV	-1.0	0.27
CDV + CAV-1 ('live') + <i>B. bronchiseptica</i> + CPIV	-2.3	0.45
CDV + CAV-2 + <i>B. bronchiseptica</i>	-2.0	0.32
CDV + CAV-2 + CPIV	-1.2	0.24
CDV + CAV-2 + <i>B. bronchiseptica</i> + CPIV	-1.7	0.85

\* A reduction is indicated by a negative value, and an increase by a positive value.

$$\begin{aligned}
 & -5.3 \pm (1.96 \times 1.04) \\
 & = -5.3 \pm 2.04 \\
 & = -7.34, -3.26.
 \end{aligned}$$

Thus, the 95% confidence interval for the odds ratio =  $e^{-7.43}$ ,  $e^{-3.26}$ , = 0.000 65, 0.038. This interval clearly excludes one and so the reduction in risk of kennel cough associated with this combination of vaccines is statistically significant at the 5% level. This multivariate model can therefore be used to identify which combinations of vaccines predict the greatest reductions in the risk of kennel cough in the field.

Comprehensive discussions of the application of these methods to observational studies are presented by Breslow and Day (1980, 1987), Kleinbaum *et al.* (1982), Schlesselman (1982) and Hosmer and Lemeshow (2000).

Some examples of observational studies, which include both simple and multivariate analyses, are listed in Appendix XXII.

## Further Reading

- Breslow, N.E. and Day, N.E. (1980) *Statistical Methods in Cancer Research, Vol.1: The Analysis of Case-Control Studies*. IARC Scientific Publications No. 32. International Agency on Cancer Research, Lyon
- Breslow, N.E. and Day, N.E. (1987) *Statistical Methods in Cancer Research, Vol.2: The Design and Analysis of Cohort Studies*. IARC Scientific Publications No. 82. International Agency on Cancer Research, Lyon
- Collett, D. (2003) *Modelling Binary Data*, 2nd edn. Chapman and Hall, London (*Describes the application of the logistic model to observational studies*)
- Elwood, J.M. (1998) *Critical Appraisal of Epidemiological Studies and Clinical Trials*, 2nd edn. Oxford University Press, Oxford
- Fleiss, J.L., Levin, B. and Paik, M.C. (2003) *Statistical Methods for Rates and Proportions*, 3rd edn. John Wiley, Hoboken
- Frankena, I. and Graat, E.A.M. (2001) Multivariate analysis: logistic regression. In: *Application of Quantitative Methods in Veterinary Epidemiology*, revised reprint. Eds Noordhuizen, J.P.T.M., Frankena, K., Thrusfield, M.V. and Graat, E.A.M., pp. 131–161. Wageningen Pers, Wageningen. (*A concise introduction to the logistic model*)
- Green, M.D., Freedman, D.M. and Gordis, L. (2000) Reference guide on epidemiology. In: *Reference Manual on Scientific Evidence*, 2nd edn, pp. 333–400. Federal Judicial Center, Washington. (*A general guide to analytical methods, with emphasis on interpretation*)
- Hosmer, D.W. and Lemeshow, S. (2000) *Applied Logistic Regression*, 2nd edn. John Wiley, New York
- Kelsey, J.L., Whittemore, A.S., Evans, A.S. and Thompson, W.D. (1996) *Methods in Observational Epidemiology*, 2nd edn. Oxford University Press, New York and Oxford
- Kleinbaum, D.G., Kupper, L.L. and Morgenstern, H. (1982) *Epidemiologic Research. Principles and Quantitative Measures*. Lifetime Learning Publications, Belmont
- Newman, S.C. (2001) *Biostatistical Methods in Epidemiology*. John Wiley, New York
- Rothman, K.J. and Greenland, S. (Eds) (1998) *Modern Epidemiology*, 2nd edn. Lippincott-Raven, Philadelphia
- Sahai, H. and Kurshid, A. (1995) *Statistics in Epidemiology: Methods, Techniques, and Applications*. CRC Press, Boca Raton. (*A comprehensive discussion of the variety of methods for deriving parameters in observational studies*)
- Schlesselman, J.J. (1982) *Case-Control Studies: Design, Conduct, Analysis*. Oxford University Press, New York and Oxford

# 16

## Clinical trials

---

The effects of some treatments are so marked that they are obvious; for instance, the intravenous administration of calcium to cases of acute bovine hypocalcaemia. However, this is not true for many prophylactic and therapeutic procedures, where, for example, the advantages of a new drug over an established one may be small. Moreover, the observations of individual veterinarians provide insufficient evidence for determining efficacy<sup>1</sup>. In the past, treatment was often based on beliefs that had never been scientifically assessed; and anecdotal or unattested cures entered the veterinary and medical literature. Indeed, it has been estimated that only about 20% of human medical procedures have been evaluated properly (Konner, 1993), and many veterinary procedures have also been poorly evaluated (Shott, 1985; Smith, 1988; Bording, 1990; Elbers and Schukken, 1995)<sup>2</sup>. Conclusive evidence of efficacy is provided by a **clinical trial**.

Clinical trials date back to the 18th century, when they provided clues to the cause of disease<sup>3</sup>. The provision of citrus fruits to English sailors prevented scurvy,

indicating that the cause (subsequently shown to be vitamin C deficiency) was nutritional (Lind, 1753). Similarly, at the beginning of the 20th century, improvement in the diet of inmates of some American orphanages and asylums cured and prevented pellagra, and suggested a nutritional cause of the disease, which hitherto had been considered to be infectious (Goldberger *et al.*, 1923).

### Definition of a clinical trial

A clinical trial is a systematic study in the species, or in particular categories of the species, for which a procedure is intended (the target species) in order to establish the procedure's **prophylactic** or **therapeutic** effects. In veterinary medicine, effects may include improvements in production as well as amelioration of clinical disease. The procedure may be a surgical technique, modification of management (e.g., diet), or prophylactic or therapeutic administration of a drug. If the latter is being assessed, a clinical trial would also include studies of its pattern of absorption, metabolism, distribution within the body and excretion of active substances.

With these aims in mind, the assessment of drugs can be classified chronologically into four categories, according to the purpose of the assessment (Friedman *et al.*, 1996):

1. **pharmacological and toxicity trials**, usually conducted on either the target species or laboratory animals to study the safety of a drug;
2. **initial trials of therapeutic effect and safety**, usually conducted on the target species on a small scale in a controlled environment (e.g., on research establishments), and often with the object

---

<sup>1</sup> A distinction is sometimes made between *effectiveness* and *efficacy* (Last, 2001). The former is the extent to which a procedure does what it is intended to do when applied in the day-to-day routine of medical or veterinary practice. The latter is the extent to which a procedure produces beneficial results under ideal conditions. A procedure may be efficacious but relatively ineffective if it is not taken up widely (e.g., if the owner's compliance with the advice of the veterinarian is low).

<sup>2</sup> See Wynne (1998) and Verdier *et al.* (2003) for a discussion of assessment of veterinary homeopathic remedies.

<sup>3</sup> The principle of making medical inferences from comparisons is much older. The earliest recorded example is probably the study of the diet of captive Jewish children in Babylon in the 6th century BC (documented in the Old Testament: *Daniel* 1: 3–16). Nebuchadnezzar, the Chaldaean ruler of Babylon, instructed Ashpenaz, his chief eunuch, to take some of the captive children into his court. They were offered the king's meat but refused it, eating vegetables instead. After ten days '*they looked healthier and were better nourished than all the young men who had lived on the food assigned them by the king*'.



- of selecting the potentially most attractive drugs from those that are available;
3. **clinical evaluation of efficacy**, undertaken on a larger scale **in the field**, that is, under **operational conditions**, where management and environment can affect the result of the trial;
  4. **post-authorization surveillance** of a drug after it has been licensed, to monitor adverse drug reactions.

This chapter focusses on the third category of trial: assessment of efficacy in the field, in which circumstance the term **field trial** is commonly used.

Hitherto, some authors have distinguished between a field trial and a clinical trial on the grounds that the former possesses two characteristics:

1. it is conducted under operational conditions;
2. it is frequently prophylactic, and therefore relies on natural challenge to the treatment that is being assessed (e.g., assessment of the efficacy of a bacterial pneumonia vaccine would rely on vaccinated animals being naturally exposed to infection with the relevant bacterium during the period of the trial).

However, these characteristics only represent related circumstances under which clinical trials may be conducted (2 is a logical consequence of 1), and so a distinction between clinical and field trials is not considered necessary on these grounds.

Some authors (e.g., Rothman and Greenland, 1998) draw the distinction more forcibly on the grounds that a clinical trial is undertaken on patients that are ill, and is therefore always therapeutic (this may include prevention of sequelae, though; see Chapter 22: Secondary and tertiary prevention); whereas a field trial is invariably conducted on clinically healthy individuals to determine prophylactic effect (primary prevention). Such a strong distinction is also not made in this chapter, where in addition, for brevity, all types of procedure are described as 'treatment'.

### Randomized controlled clinical trials

The clinical condition of sick animals can be compared before and after treatment. This is sometimes termed an **open trial** (Toma *et al.*, 1999). However, interpretation of such an **uncontrolled trial** may be difficult because any observed changes could result either from the treatment or from natural progression of the disease. An essential feature of a well designed clinical trial therefore is a comparison of a group receiving the treatment with a **control group** not receiving it; this is a **controlled clinical trial**.

The control group may be selected at the same time as the group receiving the treatment (a **concurrent**

control group) or generated using historical data (a **historical control group**). Early clinical trials, such as Lister's assessment of antiseptic surgery (Lister, 1870), utilized historical controls, but this approach is open to criticism because of the various factors, unrelated to treatment, that can produce observed differences over a period of time (e.g., improvements in husbandry, changes in diagnostic criteria, disease classification and selection of animals, alterations in virulence of infectious agents, and reduction in the severity of disease). The net result of these problems is that studies with historical controls tend to exaggerate the value of a new treatment (Pocock, 1983). Concurrent control groups are therefore usually advocated<sup>4</sup>.

The control group may receive another (standard) treatment with which the first treatment under trial is being compared (a 'positive' control group), no treatment (sometimes called a 'negative' control group), or a **placebo** (an inert substance that is visually similar to the treatment under trial, and therefore cannot be distinguished from the treatment by those administering and those receiving the treatment and placebo)<sup>5</sup>.

Bias (see Chapter 9) can occur in a trial if there is preferential assignment of subjects to treatment or control groups, differential management of the groups, or differential assessment of the groups. For example, a veterinarian may allocate animals only with a good prognosis to the treatment group. A central tenet of a controlled clinical trial is that subjects are assigned to treatment and control groups **randomly** (see Chapter 13) so that the likelihood of bias due to preferential allocation is reduced. This process of **randomization** should also balance the distribution of other variables that may be outcome-related (e.g., age), and guarantees the validity of the statistical tests used in the analysis of the trial (Altman, 1991b).

**Randomized controlled clinical trials** therefore adopt the experimental approach (see Chapter 2) and closely resemble cohort studies (see Chapter 15)<sup>6</sup>.

<sup>4</sup> A notable early example of the use of concurrent controls was Pasteur's trial of an anthrax vaccine in sheep (Descour, 1922).

<sup>5</sup> The first placebo-controlled clinical trial was probably undertaken by the English physician, John Haygarth, at the end of the 18th century (Haygarth, 1800). At that time, a popular treatment for many diseases was the application of metal rods, called 'Perkins' tractors', to the body to relieve symptoms by the supposed electromagnetic influence of the metal. Haygarth made wooden imitation tractors, and found that they were as efficacious as the metal ones. In so doing, he demonstrated the 'placebo effect': the expectation that a treatment will have an effect is sufficient to produce an improvement. A placebo was originally a substance with no known therapeutic effect which was administered in the hope that the power of suggestion, alone, would alleviate symptoms (Latin: *placebo* = I shall be pleasing).

<sup>6</sup> In the UK, randomized controlled trials were introduced in the mid-1940s by Bradford Hill: the first to test the efficacy of pertussis vaccine, and the second to test the efficacy of streptomycin in the treatment of pulmonary tuberculosis (Doll, 1992).

## Confirmatory and exploratory trials

Trials are also classified as **confirmatory** or **exploratory** (EAEMP, 2001). The former include randomized controlled clinical trials and controlled trials to determine appropriate dosage levels of drugs, both of which require strict protocols (discussed later in this chapter). These are often preceded by exploratory trials, the initial nature of which allows a less stringent protocol, which may be modified as analyses are undertaken; however, exploratory trials cannot be the sole basis of proof of efficacy. A trial that has both exploratory and confirmatory aspects is a **composite trial**.

## Community trials

A **community trial** is a trial in which the experimental unit (see below) is an entire community. Community trials have been undertaken in human medicine; for example, the fluoridation of the public water supply to prevent dental caries (Lennon, 2003)<sup>7</sup>.

## Multicentre trials

Pharmacological and toxicity trials, initial trials of therapeutic effect and safety, and exploratory trials are usually conducted either in a single laboratory or at a single field site. Confirmatory field trials, however, are often conducted at several sites, following a standard protocol. Such **multicentre trials** are conducted for two reasons:

1. they may be the only means of accruing sufficient animals within a reasonable period of time;
2. they allow a widely representative cross-section of the population of animals to be exposed to the therapy, increasing the validity of the trial (see below: The experimental population).

## Superiority, equivalence, and non-inferiority trials

**Superiority trials** are designed to detect a difference between a treated and a control group. Efficacy is established most convincingly in such trials. Sometimes, however, two treatments are compared without the goal of demonstrating superiority (e.g., comparing an inexpensive new drug with an established costly drug, with the objective of replacing the latter by the former). This may involve demonstrating that the effects of each treatment are the same (**equivalence trials**). A particular category of equivalence study is the **bioequivalence study**. This assesses the pharmacological kinetics of a new substance (e.g., the extent

to which an active substance reaches the tissues, and its tissue concentration) relative to a reference substance. This is the basis for concluding that preparations are therapeutically equivalent. Equivalence trials that assess if the effects of two treatments are the same may be more specifically termed 'full equivalence trials'.

A special case of an equivalence trial is the **non-inferiority trial**, in which the goal is to demonstrate that a therapy is no worse than an established one. This is common in initial trials of therapeutic effect, where it is often desirable to demonstrate that a new drug is no less effective than (i.e., is non-inferior to) an established preparation, although it could also be equivalent or better.

## Design, conduct and analysis

### The trial protocol

The goal and design of a clinical trial should be documented in a **trial protocol**. This is required by regulatory organizations, which assess the value and validity of the proposed trial, and also provides background information to veterinarians and owners who are asked to participate in the trial. The main components of a protocol are listed in *Table 16.1*<sup>8</sup>.

### The primary hypothesis

The first step in writing a protocol for a clinical trial is determination of its **major objective**, so that a **primary hypothesis** can be formulated. Thus, a primary hypothesis could be 'evening primrose oil has a beneficial effect against canine atopy' (Scarff and Lloyd, 1992). Several principal criteria of response might be assessed, but it is helpful if one particular response variable can be identified as the main criterion for testing the primary hypothesis; this is the **primary end point**. The following topics must be addressed in determining this end point:

- which end points are the most *clinically* and *economically* important?
- which of these can be measured in a reasonable manner?
- what practical constraints (e.g., budgetary limits) exist?

Thus, the primary end point in the evening primrose oil trial might be the level of pruritus. Other end points

<sup>7</sup> The application of a therapy to a whole community without its consent does, of course, raise ethical issues (Cross, 2003).

<sup>8</sup> A similar protocol is the basis of the standard for reporting veterinary (Begg *et al.*, 1996) and medical (Altman, 1996) clinical trials in scientific journals.

**Table 16.1** Components of a protocol for a clinical trial. (Modified from Noordhuizen *et al.*, 1993.)

<b>General information</b>	
Title of trial	
Names and addresses of investigators	
Name and address of sponsor(s)	
Identity of trial site(s)	
<b>Justification and objectives</b>	
Reason for execution of the trial	
Primary hypothesis to be tested;	
Primary end point	
Secondary hypotheses to be tested	
<b>Design</b>	
Response variables:	
Nature of response variables (level of measurement)	
Scoring system (for ordinal variables)	
Definition of efficacy (magnitude of the difference to be detected between treatment and control groups)	
Duration:	
Date of beginning	
Date of end	
Duration of disease under study	
Period for recruitment of cases	
Duration of treatment	
Drug withdrawal period (for food-producing animals)	
Decision rules for terminating a trial	
Experimental population:*	
The experimental unit	
Composition (e.g., age, sex, breed)	
Inclusion/exclusion criteria	
Post-admission withdrawal criteria	
Definition of cases/diagnostic criteria	
Case identification	
Selection of controls	
Sample size determination	
Owners' informed consent	
Therapeutic or prophylactic procedure:	
Dosage	
Product formulation and identification	
Placebo/standard treatment formulation and identification	
Method of administration	
Operators' safety	
Definition of stage at which administration stops	
Blinding technique	
Compliance monitoring	
Type of trial:	
Randomization	
Stratification variables	
Implementation of allocation process	
Data collection:	
Data to be collected	
Frequency of data collection	
Method for recording adverse drug reactions	
Identification of experimental units	
Training/standardization of data collection and recording	
Confidentiality	
Communication between participants	
Data analysis:	
Technique for 'unblinding'	
Description of statistical methods	
Interpretation of significance levels/confidence intervals	
Approach to withdrawals and animals 'lost to follow up'	

\* Some authorities refer to the experimental population as the study population. The latter term is not used, to avoid confusion with study population defined as the population from which a **sample** of animals is drawn (see Chapter 13).

could include the levels of oedema and erythema; these constitute **secondary end points**.

The response variables that are used to measure the end points (the **primary** and **secondary end point variables**) should adequately represent the effect that is being studied in the trial, and therefore address the primary hypothesis (**construct validity** and **content validity**: see Chapter 9). Thus, there is a relationship between plasma essential fatty acid levels and the inflammatory response (Horrobin, 1990), and so changes in plasma phospholipid levels could be monitored, but these are less clinically relevant than the actual clinical signs which may, therefore, be more appropriate response variables for ensuring construct validity. However, clinical signs are often measured subjectively on an ordinal or visual analogue scale (see Chapter 9), whereas fatty acid levels can be measured on the ratio scale. Thus, a compromise between strength of measurement and relevance (construct validity) may be necessary. If complex or subjective measures are used, their reliability should be assessed (see Chapter 9).

In exploratory trials, it may be desirable to use more than one primary end point variable, to cover the potential range of effects of a therapy, one of which may then be subsequently selected for a confirmatory trial.

### Defining efficacy

The primary end point defines the **outcome** that is assessed, and therefore the nature of the trial's response variables (Table 16.2), and efficacy is determined in terms of differences between treatment and control groups. The differences may be measured either absolutely or relatively (e.g., by the relative risk<sup>9</sup>).

Additionally, a useful measure of **vaccinal efficacy** is the attributable proportion (exposed),  $\lambda_{\text{exp}}$  (see Chapter 15), in which unvaccinated animals are defined as 'exposed' to the risk factor. Table 16.3 shows the results of a clinical trial of the efficacy of a *Bacteroides nodosus* vaccine against foot-rot in sheep. In this trial, prevalence figures are used instead of incidence figures; thus:

$$\begin{aligned}\lambda_{\text{exp}} &= (\text{prevalence}_{\text{exposed}} - \text{prevalence}_{\text{unexposed}}) / (\text{prevalence}_{\text{exposed}}) \\ &= (94/422 - 21/317) / (94/422) \\ &= 0.157/0.223 \\ &= 0.704.\end{aligned}$$

<sup>9</sup> Caution should be exercised in using the odds ratio in clinical trials. Recall (Chapter 15) that the odds ratio overestimates the relative risk, and this overestimation can be considerable if disease (outcome) is not rare. In clinical trials, the outcome of interest (e.g., recovery rate) may not be rare, in which circumstance the odds ratio will substantially overestimate the effect of treatment.

**Table 16.2** Response variables assessed in clinical trials.

Response variable		Efficacy	
Level of measurement	Examples	Definition	Description of method and sample size determination
Nominal	Mortality	Difference between two proportions Relative risk	Chapter 14
	Incidence		Chapter 15
	Prevalence		
Ordinal	Scores of clinical severity Condition scores	Difference between two medians	Chapter 14
Interval and ratio and the visual analogue scale	Liveweight gain Milk cell counts Visual analogue assessment of clinical severity	Difference between means (if the variables are Normally distributed)	Chapter 14

**Table 16.3** Efficacy of a *Bacteroides nodosus* vaccine against foot-rot (84 days after vaccination). (Raw data derived from Hindmarsh *et al.*, 1989.)

	Foot rot present	Foot rot absent	Total
Non-vaccinated sheep	94	328	422
Vaccinated sheep	21	296	317

Therefore, 70.4% of foot-rot in unvaccinated sheep is attributable to not being vaccinated; this is alternatively the percentage of disease prevented by the vaccine in vaccinated animals.

There is not always a fixed standard for acceptable therapeutic effect or efficacy. In the European Union, for example, the therapeutic effect of a veterinary medicinal product is generally understood by the relevant regulatory body to be the effect 'promised by the manufacturer' (Beechinor, 1993). European regulatory guidelines have attempted to define efficacy of ectoparasitic preparations (CVMP, 1993):

$$\% \text{ efficacy} = \frac{C - T}{C} \times 100,$$

where:

$C$  = mean number of ectoparasites/animal in the control group;<sup>10</sup>

$T$  = mean number of ectoparasites/animal in the treated group.

An approximate confidence interval can be calculated for this parameter by computing a confidence

interval for the difference between the two means,  $C$  and  $T$  (as described in Chapter 14), and then dividing each limit by  $C$ . (Note that this approximate approach ascribes no sampling variation to  $C$  in the denominator.)

Target levels of efficacy include 'approximately 100%' for flea and louse infestations; '80–100% (preferably more than 90%)' for infestations with Diptera; and 'more than 90%' for tick infestations. Note, however, that the value of a therapeutic effect lies ultimately in its clinical and economic impact.

## The experimental unit

The **experimental unit** is the smallest *independent* unit to which the treatment is randomly allocated. It may be elementary units (usually individual animals) or aggregates such as pens or herds. Most companion-animal and human clinical trials involve allocation to individuals. Some trials in livestock, in contrast, may involve allocation of treatments to groups (e.g., Gill, 1987). In contrast, the experimental unit may be the udder quarter when locally administered intramammary preparations are being assessed; the elementary unit is then the quarter, not the animal.

The experimental unit may be a group because events at the individual level cannot be measured, even though they are of interest. For instance, in trials of in-feed compounds likely to affect weight gain in poultry and pigs, either the amount eaten by, or the weight increase of, individuals within a house or pen is not recorded. This often arises because it is not practical to identify individual animals at weighing. Consequently, liveweight gain per house or pen is the response variable. Moreover, when animals are penned together, external factors (e.g., farm hygiene) may affect the group, and such 'group effects' cannot be separated from individual treatment effects;

<sup>10</sup> The mean may be the arithmetic mean, geometric mean, or other appropriate transformation (see Chapters 12 and 17); noting, however, that transformations have less meaning to clinicians than the original scales.

therefore the group must be identified as the experimental unit (Donner, 1993; Speare *et al.*, 1995).

Thus, the efficacy of in-feed antibiotic medication in reducing the incidence of streptococcal meningitis in pigs could be assessed by dividing a herd into pens containing a specified number of animals (Johnston *et al.*, 1992). The treatment is then randomly allocated to the pens, and medicated and 'placebo' diets supplied to pigs in the respective treatment and control pens. In this circumstance, each pen only contributes the value 1 in sample size determination for the trial because variability can only be legitimately assessed between pens, rather than between individuals.

A particular problem arises with trials involving some infectious diseases. If the treatment could reduce excretion of infectious agents (e.g., vaccination in poultry houses or anthelmintic trials on farms), then treated and control animals should not be kept together because any reduction in infection 'pressure' will benefit treated and control animals; similarly, control animals constitute a source of infection to treated animals. This can lead to similar results in both categories (Thurber *et al.*, 1977), therefore reducing the likelihood of detecting beneficial therapeutic effects. The practice of mixing animals in each group is therefore unacceptable when herd immunity or group immunity is being assessed. In these circumstances, an appropriate independent unit must be identified. Thus, separate houses could be used on an intensive poultry enterprise, or separate tanks on a fish farm. Dairy farms, in contrast, usually have a continuous production policy with mixing of animals, and so the herd may become the experimental unit.

## The experimental population

The population in which a trial is conducted is the **experimental population**. This should be representative of the target population (see also Chapter 13). Differences between experimental and target populations may result in the trial not being generalizable (**externally valid**); that is, unbiased inferences regarding the target population cannot be made. For example, findings from a trial of an anaesthetic drug conducted only on thoroughbred horses may not be relevant to the general horse population because of differences in level of fitness between thoroughbreds and other types of horse (Short, 1987). External validity (which is facilitated by conducting trials 'in the field') contrasts with **internal validity**, which indicates that observed differences between treatment and control groups in the **experimental population** can be legitimately attributed to the treatment. Internal validity is obtained by good trial design (e.g., randomization). The evaluation of external validity usually requires

much more information than assessment of internal validity.

Prophylactic trials require selection of an experimental population that is at high risk of developing disease so that natural challenge can be anticipated during the period of the trial. Previous knowledge of disease on potential trial sites may be sufficient to identify candidate populations (Johnston *et al.*, 1992). However, the period of natural challenge may vary, reflecting complex patterns of infection. Many infections are seasonal (*Figure 8.14*); others may be poorly predictable (Clemens *et al.*, 1993).

## Admission and exclusion criteria

Criteria for inclusion of animals in a trial (**admission criteria, eligibility criteria**) must be defined. These should be listed in the protocol, and include:

- a precise **definition of the condition** on which the treatment is being assessed;
- the **criteria for diagnosis** of the condition.

For example, in the trial of the efficacy of evening primrose oil in the treatment of canine atopy, chronically pruritic dogs were included only if they conformed to a documented set of diagnostic criteria (Willemse, 1986) and reacted positively to the relevant intradermal skin tests. Similarly, specific types of mastitis may need to be defined in bovine mastitis trials; other admission criteria could include parity and stage of lactation.

**Exclusion criteria** are the corollaries of admission criteria. Thus, dogs with positive reactions to flea allergens were excluded from the trial of evening primrose oil. Cows might be excluded from a mastitis trial if they had been previously treated for mastitis during the relevant lactation, if they had multiple mammary infections, or if they also had other diseases that could affect treatment. Trials of non-steroidal anti-inflammatory drugs would require exclusion from the treatment group of animals to which corticosteroids were being administered. However, too many exclusion criteria should be avoided; otherwise external validity may be compromised. It may be prudent to accommodate factors either in the trial design by stratification, or during the analysis.

The objectives and general outline of a trial should be explained to owners of animals that are included in the trial, and then their willingness to participate documented. This is **informed consent**.

## Blinding

**Blinding (masking)** is a means of reducing bias. In this technique, those responsible for measurements or

**Table 16.4** Summary of types of blinding to assignment of treatment.

Type of blinding	Knowledge of assignment of treatment	
	Owner	Investigator
None	Yes	Yes
Single	No	Yes
Double (full)	No	No

clinical assessment are kept unaware of the treatment assigned to each group. The classification of blinding into **single** or **double (full)** is based on whether the owner or attendant (patient in human medicine) or investigator is 'blinded' (Table 16.4). 'The investigator' can be more than one category of person; for example, participating veterinary practitioners and the principal investigators that analyse the results (the term 'treble-blinding' has been advocated in this situation).

Blinding should be employed wherever possible, and is facilitated by the use of a placebo in the control group. However, there may be circumstances in which blinding is not feasible; for example, if two radically different treatments are being compared (e.g., comparing infiltration of local anaesthetic with bloodless castrators to reduce pain associated with castration and tail-docking of lambs: Kent *et al.*, 2004), or if formulation of visually identical 'trial' and 'standard' drugs is impracticable. Such unblinded studies are sometimes termed **open-label** trials (Everitt, 1995). Open-label trials can be avoided by partial blinding through denying personnel involved in clinical assessment access to details of treatment. If full blinding is infeasible, those that are blinded (sponsor, investigator, or owner) should be clearly documented, as should any intentional or unintentional breaking of blinding.

## Randomization

### Simple randomization

Simple randomization is the most basic type of randomization. When there are only two treatments, tossing a coin is an elementary method. However, it is usually more rigorous to randomize in advance using random numbers (Appendix X), allocating units identified by odd numbers to one group, and evenly numbered units to the other. Randomization should be applied *after* eligible units have been identified.

When comparing a new treatment with an established one, and there is evidence that the new treatment is superior, it can be allocated to twice the number of units as the established one (Peto, 1978).

This can increase the benefit to participating animals. For example, if a new treatment was expected to reduce mortality by 50%, 2:1 randomization would be expected to produce an equal number of deaths in the two groups. This randomization ratio can be obtained by using twice as many random numbers for allocation of the new treatment as those used to allocate the established one. There is no advantage in increasing the ratio further, because of the resultant loss of statistical power which can only be counteracted by increasing the total sample size.

### Block randomization

Simple randomization can produce grossly uneven totals in each group if a small trial is undertaken. This problem can be overcome using **block (restricted) randomization**. This limits randomization to blocks of units, and ensures that within a block equal numbers are allocated to each treatment. For example, if randomization is restricted to units of four animals, receiving either treatment A or treatment B, the numbers 1–6 are attached to the six possible treatment allocations in a block: AABB, ABBA, ABAB, BBAA, BAAB and BABA. One of these numbers is then selected from a random number table for the next block of four individuals entering the trial, and given its treatment allocation.

### Stratification

Some factors (e.g., age, parity or severity of disease) may be known to affect the outcome of a trial and may bias results if they are unevenly distributed between the treatment and control groups. This can be taken into account during initial randomization by **stratifying** (i.e., matching) both groups according to these confounding factors. The experimental units are then allocated to treatment and control groups within the strata, using simple or block randomization. The most extreme case is individual matching (see Chapter 15), with subjects in the matched pairs being randomly allocated to the treatment and control groups.

Stratification leads to related samples and therefore decreases the number of units that are required to detect a specified difference between treatment and control groups (see Chapter 14).

These and other methods of randomization are described in detail by Zelen (1974).

### Alternatives to randomization

Some alternatives to randomization include allocation according to date of entry (e.g., treatment on odd days, placebo on even days), clinic record number, wishes of the owner, and preceding results. An example of the

last method is the 'play-the-winner' approach (Zelen, 1969): if a treatment is followed by success, the next unit receives the same treatment; if it is followed by failure, the next unit receives the alternative treatment. This limits the number of animals receiving an inferior treatment. All of these techniques have disadvantages and should never be considered as acceptable alternatives to randomization (Bulpitt, 1983).

## Trial designs

There are four main trial designs:

1. parallel-group (standard);
2. cross-over;
3. sequential;
4. factorial.

### Parallel-group-design (standard) trials

The **parallel-group (standard)** design is commonly used in confirmatory trials. Experimental units are randomized to a single treatment group using either simple or block randomization, and each group receives a single treatment. A specified number of units enter the trial and are followed for a predetermined period of time, after which the treatment is stopped. The basic design can be refined by stratification.

The analytical techniques employed in a parallel trial involving two unstratified groups are listed in *Table 16.2*. Estimation of parameters with associated confidence intervals is preferred to hypothesis testing, for the reasons given in Chapter 14. Confidence intervals should also be quoted for negative, as well as positive, results.

Details of complex multivariate methods for stratified analyses are described by Meinert and Tonascia (1986) and Kleinbaum *et al.* (1982), but these are seldom used in veterinary product development.

### Cross-over-design trials

In a **cross-over trial**, subjects are exposed to more than one treatment consecutively, each treatment regimen being selected randomly (Hills and Armitage, 1979). Experimental units therefore serve as their own controls, and treatment and control groups are therefore matched. This design is useful when treatments are intended to alleviate a condition, rather than effect a cure, so that after the first treatment is withdrawn the subject is in a position to receive a second. Examples are comparisons of anti-inflammatory drugs in arthritis, and hypoglycaemics in diabetes. Moreover, a comparison on the same individuals is likely to be more precise than a comparison between subjects because

the responses are paired (see Chapter 14). The cross-over trial is therefore valuable if the number of experimental units is limited. However, analysis of results is complex if a treatment effect carries over into the next treatment period.

If treatment effects do not carry over into subsequent treatment periods, the techniques described in Chapter 14 for the analysis of related samples can be used. However, the absence of a carry-over effect may be difficult to prove. If there is any doubt, conclusions should be based only on the first period, using analyses of independent samples. Alternatively, more complex methods that identify interactions between treatment effect and period of treatment can be applied (Hills and Armitage, 1979).

### Sequential-design trials

A **sequential trial** is one whose conduct at any stage depends on the results so far obtained (Armitage, 1975). Two treatments are usually compared, and experimental units (usually individuals) enter the trial in pairs; one individual being given one treatment, and one the other. Results are then analysed sequentially according to the outcome in the pairs, and boundaries are drawn to define levels at which specified differences are obtained at the desired level of statistical significance. The trial may be terminated when these levels are reached. If the desired level is not reached, the investigator may decide to increase the sample size indefinitely until the former is reached; this is an **open**<sup>11</sup> trial. Alternatively, the trial may be terminated if a specified difference is not reached by a certain stage; this is a **closed** trial.

Sequential trials facilitate early detection of beneficial treatment effects and can require fewer experimental units. However, they may be difficult to plan because their duration is initially unknown. They are also unsuited to trials in which treatment response times are long because responses need to be analysed quickly so that a decision can be taken to enlist more subjects, if necessary.

A key feature of sequential trials therefore is that significance tests are conducted repeatedly on accumulating data. This tends to **increase** the overall significance level (Armitage *et al.*, 1969). For example, if five interim analyses, rather than one, are conducted, the chance of at least one analysis showing a treatment difference at the 5% level ( $\alpha = 0.05$ ) increases to 0.23 (i.e.,  $1 - [1 - \alpha]^5$ ); if 20 interim analyses are undertaken, it increases to 0.64 ( $1 - [1 - \alpha]^{20}$ ). The overall Type 1 error therefore increases if, for any single interim

<sup>11</sup> This should not be confused with open, uncontrolled trials (mentioned earlier in this chapter) in which the same animals are compared before, and after, treatment.

**Table 16.5** Nominal significance level required for repeated significance testing with an overall significance level,  $\alpha = 0.05$  or  $0.01$ , and various values of  $N$ , the maximum number of tests. (From Pocock, 1977.)

$N$	$\alpha = 0.05$	$\alpha = 0.01$
2	0.0294	0.0056
3	0.0221	0.0041
4	0.0182	0.0033
5	0.0158	0.0028
6	0.0142	0.0025
7	0.0130	0.0023
8	0.0120	0.0021
9	0.0112	0.0019
10	0.0106	0.0018
15	0.0086	0.0015
20	0.0075	0.0013

analysis,  $\alpha = 0.05$  is used as the trial's stopping criterion. If data are analysed frequently enough, a value of  $P < 0.05$  is likely, regardless of whether there is a treatment difference.

This problem can be overcome by choosing a more stringent *nominal* significance level for each repeated test, so that the overall significance level is kept at a reasonable value such as 0.05 or 0.01 (Pocock, 1983). Table 16.5 can be used for this purpose under two-tailed conditions. For example, if the overall significance level is set at  $\alpha = 0.05$ , and if a maximum of three analyses is anticipated,  $P < 0.022$  is used as the stopping rule for a treatment difference at each analysis; similarly, if a maximum of five analyses is anticipated,  $P < 0.016$  is used. Suitable values for one-sided tests are given by Demets and Ware (1980). Sample-size calculations should therefore be modified if more than one significance test is planned (Wittes, 2002).

Sequential trials are considered in detail by Armitage (1975) and Ellenberg *et al.* (2002).

### Factorial-design trials

If two factors, A and B, are to be investigated at  $a$  levels and  $b$  levels, respectively, this gives rise to  $ab$  experimental conditions, corresponding to all possible combinations of the levels of the two factors; this is a complete  $a \times b$  **factorial-design** study (Zar, 1996). Thus, in a  $2 \times 2$  factorial design where one factor is the absence or presence of treatment A ( $a = 2$ ) and the other factor is the absence or presence of treatment B ( $b = 2$ ), animals are randomly allocated to one of the four combinations of two treatments thus: A alone, B alone, A and B together, and neither A nor B. This is a powerful method of testing the effect of two factors in the same study, using the same experimental units. It can be used to explore any interactions that might occur between the two treatments and, in the absence of

interaction, enables groups to be combined to increase the power to detect the effects of treatment A and treatment B. The approach can be extended to any number of factors, and with each factor having a different number of levels.

What sample size should be selected?

### Superiority trials

The number of experimental units in treatment and control groups in a superiority trial should be determined using the techniques outlined in previous chapters (Table 16.2). In summary, the following parameters should be considered:

1. the acceptable level of type I error,  $\alpha$  (the probability of erroneously inferring a difference between treatment and control group);
2. test power,  $1 - \beta$  (the probability of correctly inferring a difference between treatment and control group) where  $\beta$  = the probability of type II error (the probability of erroneously missing a true difference between treatment and control group);
3. the magnitude of the treatment effect (i.e., the difference between proportions, medians or means);
4. the choice of alternative hypothesis: 'one-tailed' or 'two-tailed'.

There is no rule for defining parameters 1–3. Type I error is traditionally set at 0.05, but a value as low as 0.01 can be justified if a trial is unique and its findings are unlikely to be repeated in the future. Power can vary considerably (values between 0.50 and 0.95 have been quoted in human clinical trials; 0.80 is common when  $\alpha = 0.05$ , and 0.96 when  $\alpha = 0.01$ : see Chapter 14). The magnitude of the treatment effect depends on its clinical and economic relevance.

(In clinical trials in which treatment and control groups are matched, the formulae for sample size determination listed in previous chapters will tend to overestimate the number of units required.)

If a placebo or no treatment has been administered to the control group, and there is therefore intuitive evidence that the treatment can cause only an improvement in comparison with the control group, a one-tailed test (see Chapter 14) is justifiable, and the sample size can be determined accordingly. However, the use of placebos or 'negative' control groups is now ethically debatable; consequently many contemporary clinical trials use a 'positive' control group and it is therefore prudent to assume two-tailed conditions (i.e., the treatment under test may be either better, or worse, than the standard treatment). Additionally, the magnitude of the difference between treatment and 'positive' control groups may be small; thus large



sample sizes may be specified. These may be unattainable in practice. However, a knowledge of sample size determination is necessary to appreciate the inferential limitations that may be imposed by the number of experimental units included in a trial.

Wittes (2002) presents a general discussion of sample-size calculation in clinical trials, and Machin *et al.* (1997) tabulate sample sizes. Sample size determination for cross-over trials is discussed by Senn (1993). Sample size determination for sequential trials is discussed by Armitage (1975); the estimated sample size for a given Type I and Type II error is smaller than for a non-sequential trial. General guidelines are provided by Shuster (1992). Hallstrom and Trobaugh (1985) provide formulae that incorporate diagnostic sensitivity and specificity (see Chapters 9 and 17).

### Equivalence and non-inferiority trials

Determination of sample size to demonstrate equivalence focusses on the maximum difference that is tolerated – termed the **margin of clinical equivalence (M)**. This is the largest difference that is clinically acceptable, larger differences having unwelcome consequences; for example, a difference in mean blood glucose levels induced by a new hypoglycaemic, relative to an established drug, such that signs of diabetes recur. The common context is therefore of demonstrating non-inferiority.

Thus, for a dichotomous response variable, the sample-size formula to demonstrate a difference between two proportions (Chapter 14) is applied, but  $p_1 - p_2$  is now the margin of clinical tolerance, rather than the difference to be detected. Moreover, the values of  $\alpha$  and  $\beta$  are reversed because attention now focusses on the power of the comparison to detect any difference that may be present.

For example, a new foot-rot vaccine may be compared with the one listed in Table 16.3, which prevents disease in 296 of 317 sheep (93%). In determining equivalence of the two vaccines, it may be considered acceptable not to detect a difference as trivial as 5% or less *in favour* of the established vaccine (in which circumstance the vaccines are deemed to be equivalent), but desirable to detect a difference greater than 5% (in which circumstance they are identified as not being equivalent); thus  $M = 5\%$ . Note that this is a one-tailed situation, because if non-equivalence is demonstrated it is only in the direction of the new vaccine being inferior to the established one – not *either* inferior or superior.

Assume that the two vaccines are equivalent, with the proportion of disease in vaccinated sheep = 0.07 (i.e., 100% – 93%: the estimate for the established vaccine). Thus,  $p_1 = 0.07$ . If  $M = 5\%$ ,  $p_2 = 0.07 + 0.05 = 0.12$ , and  $(p_1 + p_2)/2 = (0.07 + 0.12)/2 = 0.095 = p$ . Set  $\beta$  at 0.05 (that

is, power = 0.95), and set  $\alpha$  at 0.20; thus, from Appendix XV,  $M_\beta = 1.64$ , and  $M_\alpha = 0.84$  (because the hypothesis is one-tailed). The number of animals required in each vaccinated group,  $n$ , is then derived thus:

$$n = \frac{[M_\alpha \sqrt{2p(1-p)} + M_\beta \sqrt{p_1(1-p_1) + p_2(1-p_2)}]^2}{(p_2 - p_1)^2}$$

$$= \frac{(0.84 \sqrt{0.19 \times 0.905} + 1.64 \sqrt{0.07 \times 0.93 + 0.12 \times 0.88})^2}{(0.12 - 0.07)^2}$$

$$= [(0.3483 + 0.6776)^2] / 0.0025 = 421.$$

Therefore, a trial comprising 421 animals vaccinated with the established vaccine, and 421 animals vaccinated with the new vaccine, will detect any difference between the performance of the two vaccines as small as an absolute difference in disease occurrence of 5%, but no smaller, with probability 0.95.

Alternatively, the requirement may be to show that a new vaccine is neither *inferior* nor *superior* to an established one (i.e., assessment of full equivalence). In this circumstance,  $M_\beta$  is obtained from Appendix XV using a  $\beta$  value obtained by setting  $1 - 2\beta$  equal to the overall power required for the two one-sided tests that need to be conducted. For example, if the overall power is to be 0.95, then  $M_\beta$  should be based on  $\beta$  being 0.025 (i.e.,  $M_\beta = 1.96$ ).

The same approach can be adopted for continuous and ordinal variables, using the relevant formulae for sample-size determination for differences between two means or two groups of ordinally ranked data (see Chapter 14).

### Losses to 'follow-up'

The outcome of a trial may not be recorded in some experimental units because they are lost to 'follow-up'. For example, owners may move house or refuse to continue with the trial. The extent of this loss to follow-up needs to be assessed, and is frequently based on the experience of the investigator. The sample size then needs to be increased by multiplying the sample size by  $1/(1-d)$ , where  $d$  is the anticipated proportion of experimental units lost. For example, if  $d = 10/100$ , the sample size would need to be multiplied by 1.11 ( $1/0.9$ ) to compensate. Losses to follow-up cannot be included in subsequent analyses.

### Compliance

The success of a trial depends on participants acting in accordance with the instructions of the trial's

designers; that is, **complying** with treatment. For example, they may decide to switch from the treatment under trial to an alternative treatment. Poor compliance will decrease the statistical power of the trial because the observed difference in outcome between treatment and control groups will be reduced, but it will not produce spurious differences between groups. Reasons for poor compliance include:

- unclear instructions;
- forgetfulness;
- inconvenience of participation;
- cost of participation;
- preference for alternative procedures;
- disappointment with results;
- side-effects.

Participants cannot be forced to comply, and so regular contact should be maintained with them so that they can be encouraged to comply, and the degree of compliance should be regularly assessed. For example, if a treatment is formulated as a tablet, the number of tablets remaining can be counted regularly by the veterinarian. Assessment may be difficult (e.g., with in-feed medication) but should, nevertheless, be attempted. Other methods of improving compliance include:

- enrolling motivated participants;
- assessing the willingness of participants to comply;
- providing incentives (e.g., free treatment);
- supplying simple, unambiguous instructions;
- limiting duration of the trial.

If non-compliance is substantial, the required sample size should again be modified in the same way as adjustment for loss to follow-up. If both losses to follow-up and non-compliance are anticipated, a composite value for  $d$  is required.

## Terminating a trial

The number of experimental units entering a trial and the duration of treatment are specified during the design of a trial; therefore a trial will usually last as long as it takes to enlist the units and for the last unit to complete the trial. However, it may be necessary to terminate a trial (particularly a long-term one) prematurely if there are serious adverse side-effects in the treatment group, and such a **decision rule** should be written into the trial's protocol. In sequential trials, another decision rule may be that a trial will be terminated when the specified difference is detected to the predetermined level of significance (see above).

Decision rules, and the advantages of early and late termination of trials, are discussed in detail by Bulpitt (1983).

## Interpretation of results

In Chapter 14, the use of statistical hypothesis testing as an approach to interpreting data was discussed. Increasingly, however, this is being replaced by estimation – in particular, by calculating confidence intervals (introduced in Chapter 12). Significance testing and confidence interval estimation are two ways of interpreting the same data. However, an advantage of confidence intervals is that they encourage the investigator to express results in terms of the size of any treatment effect or difference. The following discussion will therefore place particular emphasis on the interpretation of confidence intervals.

### Superiority trials

The goal of a superiority trial is to detect a difference between treated animals and controls. Evidence of a difference is provided, at the 5% level of significance, if the probability of a Type I error is less than 5% (exact values of  $P$  should always be quoted). The 95% confidence interval for the difference between the treatment effect will then exclude the null value (zero for differences; but 1 for ratio measures such as the relative risk and odds ratio, and ratios of geometric means). This is illustrated in *Figure 16.1a*. A 95% confidence interval with a lower bound clearly above the null value, and with a related value of  $P$  substantially lower than 0.05, provides strong evidence for superiority of the treated group over the control group. A 95% confidence interval with the lower limit touching the null value ( $P = 0.05$ ) provides adequate evidence of superiority at the 5% level of significance. In contrast, if the 95% confidence interval includes the null value ( $P > 0.05$ ), there is insufficient evidence to demonstrate superiority.

### Equivalence and non-inferiority trials

A full equivalence trial is intended to confirm the absence of a clinically relevant difference between treatments. This is best explored using confidence intervals. First, the margin of clinical equivalence,  $M$ , is selected. This margin should be chosen before a trial is undertaken to prevent bias, and therefore has been specified in the sample-size calculation undertaken before the study was conducted (see above). Two treatments (say, control and new treatment) are considered equivalent if the 95% confidence interval<sup>12</sup> lies entirely within the interval  $-M$  to  $+M$  (*Figure 16.1b*).

A non-inferiority trial aims to demonstrate that a new therapy is no less effective than (i.e., is

<sup>12</sup> In bioequivalence studies involving drug kinetics, 90% intervals are the accepted standard.

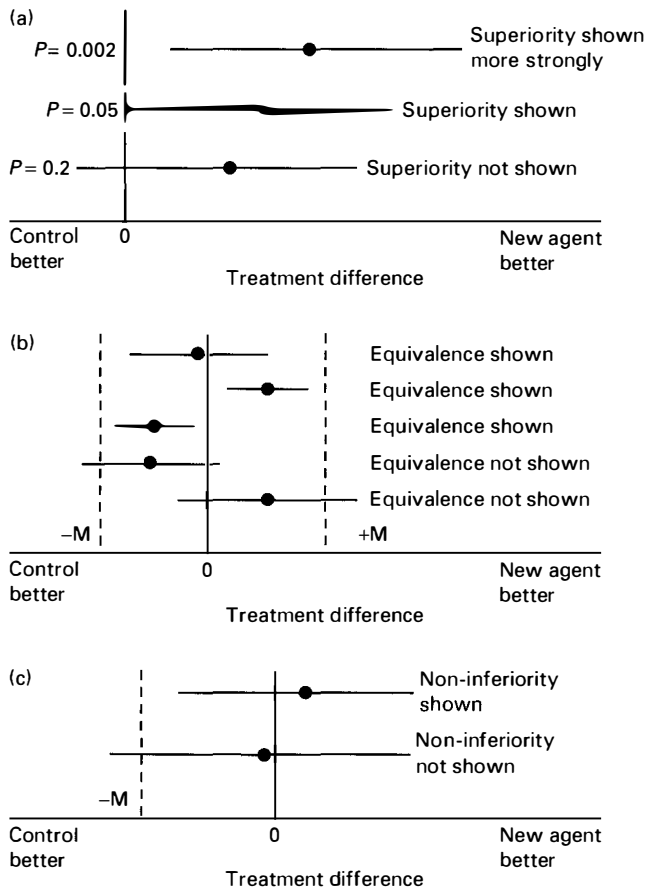

**Fig. 16.1** Significance levels and confidence intervals in clinical trials. Null value for treatment difference between treated animals and controls = 0. •: Point estimate of treatment difference; —: 95% interval estimate of treatment difference. (a) Superiority trials; (b) equivalence trials; (c) non-inferiority trials.

non-inferior to) an established preparation, although it could also be equivalent or better. Thus, concern lies with a difference only in one direction. The new preparation therefore is considered not to be inferior to the established (control) preparation only if the confidence interval lies entirely to the right of  $-M$  (Figure 16.1c). For example, a new foot-rot vaccine may be compared with an established one, with  $M$  set at a difference of 5% in the proportion of disease in sheep between the two groups in favour of the established vaccine (i.e., 5% less disease in sheep vaccinated with the established preparation than in sheep given the new vaccine). If the 95% confidence interval for the difference was  $-7\%$ ,  $-3\%$ , then it would cross the  $-M$  boundary (i.e., does *not* fall entirely to the right of  $-5\%$ ), and so it could *not* be concluded that the new vaccine was non-inferior to the established one.

Sometimes, the goal of a comparison may switch from a non-inferiority trial to a superiority trial, or vice versa. Results then have to be interpreted cautiously (EAEMP, 2000).

## Meta-analysis

Meta-analysis is the statistical analysis of data pooled from several studies to integrate findings<sup>13</sup>. The technique has its origins in educational research (Glass, 1976) and has been widely applied in the social sciences, where key texts have been published (Wolf, 1986; Hunter and Schmidt, 1989). More recently, it has been used in economics (van den Bergh *et al.*, 1997) and biology (e.g., to investigate parasite-induced behavioural changes: Poulin, 1994). In human and veterinary medicine, meta-analysis has been applied in several areas (Stangle and Berry, 2000), including the evaluation of diagnostic tests (e.g., Greiner *et al.*, 1997), observational studies (e.g., Willeberg, 1993; Fourichon *et al.*, 2000), cost-benefit analysis of diagnostic techniques and treatments, and assessment of the magnitude of health problems (e.g., Chesney, 2001; Dohoo *et al.*, 2003; Trotz-Williams and Trees, 2003). However, it has been used most extensively in the area of clinical trials (e.g., Srinand *et al.*, 1995; Peters *et al.*, 2000) and, for that reason, is discussed in this chapter.

## Goals of meta-analysis

The aims of meta-analysis (Sacks *et al.*, 1987; Dickersin and Berlin, 1992; Marubini and Valsecchi, 1995) are to:

- increase statistical power for primary end points;
- resolve uncertainty if there are conflicting results;
- improve estimates of therapeutic effect, and their precision<sup>14</sup>;
- answer questions not posed at the beginning of individual trials;
- give a 'state-of-the-art' literature review;
- facilitate analysis of subgroups when the power of individual analyses is low;
- guide researchers in planning new trials;
- offer rigorous support for generalization of a treatment (i.e., external validity);
- balance 'overflow of enthusiasm' which might accompany introduction of a new procedure following a single beneficial report.

Correctly conducted meta-analyses therefore offer strong evidence for efficacy of treatment (Table 16.6).

<sup>13</sup> The term is derived from the Greek preposition, *μετα-* (*meta-*) = 'alongside', 'among', 'in connection with'. A subsidiary meaning is 'after'. Meta-analysis is therefore either one that is done alongside/in conjunction with the normal analysis, or one that is done after the normal analysis, that is, at a later stage in the process. An alternative term – 'overviews' of research – has also been suggested (Peto, 1987).

<sup>14</sup> This includes not only revealing beneficial effects that are not identified in isolated studies, but also identification of 'false-positive' effects in individual studies: meta-analysis is designed to produce accurate results – not necessarily positive ones.

**Table 16.6** Hierarchy of strength of evidence concerning efficacy of treatment. (From Marubini and Valsecchi, 1995.)

1. Anecdotal case reports
2. Case series without controls
3. Series with literature controls
4. Analysis using computer databases
5. Case-control observational studies
6. Series based on historical control groups
7. Single randomized controlled clinical trials
8. Meta-analyses of randomized controlled clinical trials

The table lists the types of study used in medicine, suggested by Green and Byar (1984). The table can be considered as an eight-tiered pyramid. In the context of clinical trials, the base on which conclusions about efficacy can be built becomes broader as one moves downwards.

**Table 16.7** Advantages and disadvantages of meta-analysis. (Based on Meinert, 1989.)

*Advantages:*

Focusses attention on trials as an evaluation tool  
Increases the impact of trials on clinical practice  
Encourages good trial design and reporting

*Disadvantages:*

Current fashion for meta-analysis may discourage large definitive trials  
Tendency to unwittingly mix different trials and ignore differences  
Potential for tension between meta-analyst and conductors of original trials

The statistical procedures used are also applicable to the analysis of multicentre trials.

However, there are disadvantages, as well as advantages, to the technique (Table 16.7). Perhaps the major disadvantage is the seductive notion that combination of several small trials is a substitute for a well designed large one<sup>15</sup>.

In this section, the main issues associated with meta-analysis are outlined. For details of specific statistical procedures, the reader is directed to the standard texts mentioned above, and to the excellent reviews by Abramson (1991) and Dickersin and Berlin (1992).

## Components of meta-analysis

There are both **qualitative** and **quantitative** components to meta-analysis, listed in a scheme for meta-analysis of clinical trials (Naylor, 1989):

- selection of trials according to inclusion and exclusion criteria;
- evaluation of the quality of the trials;
- abstraction of key trial characteristics and data;

- analysis of similarity in design, execution and analysis, and exploration of differences between trials;
- aggregation of data, testing various combinations and interpretations;
- drawing of careful conclusions.

Note that the conventional, qualitative, review article has traditionally been accepted as the means of summarizing research data – usually by listing the individual results of several studies – and lacks objective rigorous analysis. A properly designed meta-analysis, in contrast, goes further, and uses quantitative analytical procedures to combine results from several sources, where possible, to produce an overall conclusion.

## Sources of data

Data for meta-analyses are usually obtained from published material, most of which is presented in refereed journals. This has the advantage of guaranteeing (at least theoretically) minimum standards with respect to the design, conduct and analysis of the component studies. However, there is a tendency for positive findings (beneficial treatment effects) to be more readily accepted for publication than results that either do not show significant effects or reveal only minor effects (Easterbrook *et al.*, 1991); this constitutes **publication bias**. This is a complex matter, though, and unpublished results can show larger effects than published ones (Detsky *et al.*, 1987). Assessment of the quality of *all* potential data is therefore desirable, so that useful material does not escape the analyst.

Various methods have been recommended for handling publication bias. A simple approach (Rosenthal, 1979) calculates an overall *P* value from the *P* values of the component studies, and then calculates a 'fail-safe *N*': the number of statistically non-significant studies that, if added, would increase the *P* value to a critical threshold level (say, 0.05).

## Comparability of sources

A key feature of component trials is the **variability (heterogeneity)** in their results. The latter may actually be contradictory, but this is generally due to differences in the design, conduct or analysis of the studies (Horwitz, 1987). Additionally, different trials may be measuring different response variables on different scales (e.g., median values or visual analogue measurements). Differences between old and recent studies may be ascribed to underlying health trends unrelated to the therapy in question – somewhat akin to the use of historical controls. If a meta-analysis intends to address general policy or efficacy of a class of drugs, then incorporation of trials with obvious differences can

<sup>15</sup> This may appear particularly attractive in the current academic climate where financial support is in short supply, and there is pressure to generate publications.

be condoned. However, a specific question will require selection of a relatively homogeneous set of trials.

Differences between the different studies that are included in an analysis prevent interpretation of pooled estimates as being precise<sup>16</sup>, and 99% confidence limits may therefore be more prudent than the conventional 95% limits.

## Data analysis

Analytical techniques treat each incorporated clinical trial as a **stratum**. The single treatment effects are estimated within each trial, and are then combined to produce a suitable summary, weighted treatment effect. Methods of weighting, and addressing variability in study results, vary. However, the tendency to simply pool the results of the trials and compute an average effect is avoided. This could be dangerously misleading; for example, a mean mortality rate computed from a series of separate mortality rates does not address differences in sample size between trials, and therefore the different precision of each trial's estimate.

A common approach for categorical data is to provide a weighted estimate, for example, of the odds ratio or relative risk. Standard methods include the Mantel-Haenszel procedure (see Chapter 15); Westwood *et al.* (2003) give an example relating to the effects of monensin treatment on lameness in dairy cattle. More sophisticated procedures allow pooling of parameters that have been adjusted for confounding (Greenland, 1987).

Continuous explanatory variables require different procedures. A commonly used measure is the **effect size**. This is the difference between the mean values of the treatment and control groups divided by the standard deviation in the control group (or in both groups combined) (Glass *et al.*, 1981). This can be interpreted with reference to tables of probabilities associated with the upper tail of the Normal distribution (Appendix XV). For example, an effect size of 2.9 means that 99.8% of controls have values below the mean value of treated individuals. Consulting Appendix XV, this percentage is obtained by identifying the one-tailed probability,  $P$ , in the body of the table for which the effect size equals  $z$ . The percentage then equals  $(1 - P) \times 100$ . Thus, if the effect size = 2.9,  $P = 0.0019$ , and  $(1 - P) \times 100 = (1 - 0.0019) \times 100 = 99.81\%$ . Similarly, for an effect size of 1.0, the corresponding percentage is 84% ( $(1 - 0.1587) \times 100$ ).

Effect size has no units, and so allows the combination of results expressed in different units. However, it should be interpreted with caution because it depends not only on differences in the effect itself, but also on differences in standard deviations. The use of effect size is therefore particularly dubious if sample sizes are small.

## Heterogeneity

The heterogeneity between studies must always be addressed. Commonly, tests for homogeneity are based on  $\chi^2$  or  $F$  statistics for categorical (Schlesselman, 1982) and continuous data (Fleiss, 1986), respectively. These are usually interpreted liberally at the 10% level because of the relatively low power of such tests (Breslow and Day, 1980). A sensitivity analysis (see Chapter 19) can also be conducted to determine if exclusion of one or more trials materially affects the heterogeneity. If the heterogeneity is larger than can be inferred from the results of significance tests, a summary measure is questionable, and the reason for the heterogeneity should be explored<sup>17</sup>. Note, however, that a high  $P$  value does not unequivocally indicate that the results are homogeneous, and the data should be explored by other means, such as graphical representation. Examples include a vertical two-tiered plot of results (e.g., odds ratios, relative risks<sup>18</sup> or effect size) with their 95% and 70% confidence intervals, for ease of comparison around the point estimates (Pocock and Hughes, 1990). A 'funnel display' plots results against a measure of precision (e.g., sample size or the reciprocal of the variance); if all studies are estimating a similar value, the spread of results should become narrow as precision increases, producing a funnel shape (Greenland, 1987).

## Fixed-effects and random-effects models

Most of the analytical procedures that have been employed in meta-analyses are based on a **fixed-effects** model, which assumes that all clinical trials included in the meta-analysis are estimating the *same* treatment effect. They therefore ignore any variability between different studies when producing a summary estimate. An alternative approach, based on a **random-effects** model (e.g., DerSimonian and Laird, 1986), assumes that treatment effects may be *different*, and each study represents a random sample of a (theoretically infinite) number of studies. The variability between studies is then an integral part of the analysis (Bailey, 1987), and the variations in the observed treatment effects can then result from two sources: (1) the sampling variation in each study (the within-study variance), and (2) the variation of the true study effects about their mean (the between-study variance). The net result of such an analysis is that the interval estimate of treatment effect is generally widened relative to the fixed-effect estimate, particularly if there is clear heterogeneity between studies (Dickersin and Berlin, 1992).

<sup>16</sup> The confidence limit is strictly a limit on the expected results, based on what was done in the studies, rather than on future trials.

<sup>17</sup> For example, different dosage levels (analogous to different exposure levels in observational studies: e.g., Frumkin and Berlin, 1988) may induce heterogeneity.

<sup>18</sup> Odds ratios and relative risks are best plotted on a logarithmic scale.



some results (Figure 16.2a: Studies 3, 4, 5, 7, 8, 9, 11 and 13) providing no evidence of a treatment effect (the upper 95% confidence limits for the odds ratios being greater than one). This variability is masked in the analysis of the accumulating data (Figure 16.2b), which consistently demonstrates a beneficial effect. The pooled results of the random-effects model and the final analysis of accumulating data, in this example, generate similar point and interval estimates of the odds ratio, demonstrating a significant treatment effect.

Meta-analysis is more advanced in human than in veterinary medicine, but is still a contentious issue. Responses to a meta-analysis of over 3000 randomized controlled clinical trials of preventive care in human pregnancy and childbirth (Chalmers *et al.*, 1989) ranged from describing it as 'arguably the most important publication in obstetrics since William Smellie wrote his *A Treatise on the Theory and Practice of Midwifery* in 1752' to describing its authors as 'an obstetrical Baader–Meinhof gang' (quoted by Abramson, 1991). However, meta-analysis is a powerful technique, which is likely to be applied more in veterinary science, and veterinarians should profit from the experience of their medical counterparts.

## Further reading

- Bulpitt, C.J. (1983) *Randomised Controlled Clinical Trials*. Martinus Nijhoff Publishers, The Hague
- Chalmers, I. and Altman, D.G. (Eds) (1995) *Systematic Reviews*. BMJ Publishing Group, London. (A concise introduction to medical meta-analysis)
- Code of Practice for the Conduct of Clinical Trials on Veterinary Medicinal Products in the European Community*. Fédération Européenne de la Santé Animale (FEDESA), 1993. Rue Defacqz, 1/Bte 8, B-1050, Brussels
- Conduct of Clinical Trials of Veterinary Medicinal Products* (1990) Committee of Veterinary Medicinal Products, Commission of the European Communities, Brussels. Document III/3775/90
- Dent, N. and Visanji, R. (Eds) (2001) *Veterinary Clinical Trials from Concept to Completion*. CRC Press, Boca Raton
- Duncan, J.L., Abbott, E.M., Arundel, J.H., Eysker, M., Klei, T.R., Krecek, R.C., Lyons, E.T., Reinemeyer, C. and Slocombe, J.O.D. (2002) World association for the advancement of veterinary parasitology (WAAVP): second edition of guidelines for evaluating the efficacy of equine anthelmintics. *Veterinary Parasitology*, **103**, 1–18
- Elbers, A.R.W. and Schukken, Y.H. (1995) Critical features of veterinary field trials. *Veterinary Record*, **136**, 187–192
- Friedman, L.M., Furburg, C. and DeMets, D.L. (1996) *Fundamentals of Clinical Trials*, 3rd edn. Mosby, St Louis
- Guidelines for Clinical Trials* (1988) Questionnaire 1088/A. International Dairy Federation, Brussels. (Guidelines with specific reference to mastitis)
- Guidelines for the Conduct of Bioequivalence Studies for Veterinary Medicinal Products* (2001) The European Agency for the Evaluation of Medicinal Products, EMEA/CVMP016/00-corr-FINAL
- Hunt, M. (1997) *How Science Takes Stock: The Story of Meta-Analysis*. Russell Sage Foundation, New York. (A general description of the application of meta-analysis, with examples from numerous scientific disciplines)
- Meinert, C.L. and Tonascia, S. (1986) *Clinical Trials: Design, Conduct, and Analysis*. Oxford University Press, New York
- Moher, D., Cook, D.J., Eastwood, S., Olkin, I., Rennie, D. and Stroup, D.F. (1999) Improving the quality of reports of meta-analyses of randomised controlled trials: the QUOROM statement. *The Lancet*, **354**, 1896–1900. (Recommended guidelines for reporting meta-analyses of clinical trials)
- Moher, D., Schultz, K.F. and Altman, D.G. (2001) The CONSORT statement: revised recommendations for improving the quality of reports of parallel-group randomised trials. *The Lancet*, **357**, 1191–1194; *Journal of the American Medical Association*, **285**, 1987–1991; *Annals of Internal Medicine*, **134**, 657–662. (Recommended guidelines for reporting clinical trials)
- Noordhuizen, J.P.T.M., Frankena, K., Ploeger, H. and Nell, T. (Eds) (1993) *Field Trial and Error*. Proceedings of the international seminar with workshops on the design, conduct and interpretation of field trials, Berg en Dal, Netherlands, 27 and 28 April 1993. Epidecon, Wageningen
- Note for Guidance on Statistical Principles for Clinical Trials* (1998) The European Agency for the Evaluation of Medicinal Products, CPMP/ICH/363/96
- Note for Guidance on Statistical Principles for Veterinary Clinical Trials* (2001) The European Agency for the Evaluation of Medicinal Products EMEA/CVMP/816/00-Consultation
- Perino, L.J. and Apley, M.D. (1998) Clinical trial design in feedlots. *Veterinary Clinics of North America, Food Animal Practice*, **14**, 343–365
- Pocock, S.J. (1983) *Clinical Trials: A Practical Approach*. John Wiley, Chichester and New York
- Proceedings of the First European Symposium on the Demonstration of Efficacy of Veterinary Medicinal Products*, Toulouse, 19–22 May 1992
- Schukken, Y.H. and Deluyker, H. (1995) Design of field trials for the evaluation of antibacterial products for therapy of bovine mastitis. *Journal of Veterinary Pharmacology and Therapeutics*, **18**, 274–283
- Senn, S. (1993) *Cross-over Trials in Clinical Research*. John Wiley, Chichester and New York
- Spriet, A. and Dupin-Spriet, T. (1997) *Good Practice of Clinical Drug Trials*, 2nd edn. Karger, Basel

# 17

## Diagnostic testing

---

The range of diagnostic techniques that are currently available for the diagnosis of infectious and non-infectious diseases is wide, and includes clinical and pathological examination; microbiological, biochemical and immunological investigation; and diagnostic imaging (e.g., radiography and ultrasound). These techniques may be used either to diagnose disease in the individual animal, or to investigate disease in populations. This chapter focusses primarily on the assessment and performance of diagnostic tests when applied to populations<sup>1</sup>. Diagnosis of infectious diseases using **serological** methods is addressed first. This is followed by a more general discussion of diagnostic testing.

### Serological epidemiology

**Serological epidemiology** is the investigation of disease and infection in populations by the measurement of variables present in serum. A range of constituents of serum can be measured, including minerals, trace elements, enzymes and hormones. One of the main constituents that is frequently measured is the specific antibody activity of immunoglobulins, and it is investigation of antibodies that is commonly understood to comprise serology. Alternative terms for antibody measurement are 'titration' and 'assay'. Antibodies provide evidence of current and previous exposure to infectious agents; their assay is commonly employed in veterinary medicine as a relatively efficient and cheap means of detecting this exposure in both individual animals and populations.

The statistical methods employed to analyse antibody levels are equally applicable to other serological

tests, such as those that detect enzymes and minerals, in which case, however, results can be compared with normal reference ranges. These commonly include: (1) the mean  $\pm$  2 standard deviations for Normally distributed data, selected from a normal (i.e., reference) population, and (2) the middle 95% of values (i.e., from the 2.5th to 97.5th percentile: see Chapter 12) from a reference population for data that are not Normally distributed (Hutchison *et al.*, 1991). Although values for reference levels are available in published tables (e.g., Kaneko *et al.*, 1997), each laboratory should establish its own norms. If the values are Normally distributed, or can be transformed to Normality, then a one-sample *t*-test (see *Table 14.1*) can be applied to compare a sample's values with those of a reference population; otherwise one-sample non-parametric methods may be appropriate (see *Table 14.2*).

The serological diagnosis of disease based on the detection of circulating antibodies is one of the techniques available for the identification of current and previous exposure to infectious agents. This and other methods are listed in *Table 17.1*. A range of tests to

**Table 17.1** Methods of diagnosing infectious disease.

---

<i>Evidence of current infection</i>
Isolation of agent
Identification of agent's genes (molecular epidemiology)
Clinical signs
Pathognomonic (characteristic) changes
Biochemical changes
Demonstration of an immune response: detection of antigens and antibodies (serological epidemiology)
<i>Evidence of past infection</i>
Clinical history
Pathognomonic changes
Demonstration of an immune response: detection of antibodies

---

<sup>1</sup> A detailed discussion of diagnostic testing applied to the individual in clinical practice is presented by Sackett *et al.* (1991).



detect antigen/antibody reactions has been developed over the last 100 years, and more are being added to the range. Descriptions of these techniques are found in standard immunology texts (e.g., Hudson and Hay, 1989; Paraf and Peltre, 1991; Roitt, 1994; Tizard, 2000), and a basic knowledge of them is assumed. Emphasis is now generally shifting towards the detection of antigens, rather than antibodies, in current infections.

## Assaying antibodies

### Methods of expressing amounts of antibody

The concentration of antibody is expressed as a **titre**. This is the highest dilution of serum that produces a test reaction. Thus, if the highest dilution that produces a test reaction is 1 in 32, then the titre is 1/32. Alternatively, the reciprocal, 32, can be quoted, indicating that the undiluted serum contains 32 times the antibody for the reaction. Animals with detectable antibody titres are **seropositive**; animals with no detectable antibodies are **seronegative**. Animals previously seronegative and now seropositive have **seroconverted**. However, classification of an animal as seropositive often is based on the titre being above a certain **threshold level (cut-off point)** (see below: 'Evaluation of diagnostic tests'). For example, animals with titres  $>1/32$  may be classed as positive, whereas animals with titres  $\leq 1/32$  may be classified as negative.

### Logarithmic transformation of titres

Serum is usually diluted in a geometric series, that is, with a constant ratio between successive dilutions. The commonest ratio is 2. Thus, serum is diluted 1/2, 1/4, 1/8, 1/16, 1/32 and so on. This suggests that the titres should be measured on a logarithmic scale. There are two reasons for this measurement:

1. the frequency distribution of titres often is approximately lognormal (see *Figure 12.5*); statistical tests that assume Normality may therefore be applied;
2. geometric dilution series are equally spaced on a logarithmic scale; thus serum may be diluted geometrically 1/2, 1/4, 1/8, 1/16 and so on, corresponding to log transformation to base 2, the respective logs to base 2 of the reciprocals of the dilutions being 1, 2, 3, 4, and so on; the dilution can be coded as the value of these logarithms to base 2 (*Table 17.2*).

In some cases, high concentrations of serum that react non-specifically are avoided by initially diluting by  $\log_{10}$ , and then continuing in  $\log_2$  dilutions, thus: 1/10, 1/20, 1/40, 1/80.

**Table 17.2** Antibody titres expressed as reciprocal dilutions ( $X$ ) and coded titres ( $\log_2 X$ ).

Reciprocal dilution ( $X$ )	Coded titre ( $\log_2 X$ )
1 (undiluted serum)	0
2	1
4	2
8	3
16	4
32	5
64	6

### Mean titres

If several coded (i.e.,  $\log_2$  transformed) titres are recorded, their **arithmetic mean** can be calculated. This is simply the sum of the coded titres divided by the number of titres. For example, if five titres are 1/2, 1/4, 1/2, 1/8, and 1/4, then the coded titres are 1, 2, 1, 3, and 2, respectively. The arithmetic mean therefore is  $(1 + 2 + 1 + 3 + 2)/5 = 1.8$ .

The **geometric mean titre (GMT)** is the antilog<sub>2</sub> of the arithmetic mean. This can be obtained from a pocket calculator with an 'x<sup>y</sup>' function key on it. For instance, if the arithmetic mean of several coded titres is 1.8, then  $\log_2 \text{GMT} = 1.8$ ; thus  $\text{GMT} = 2^{1.8} = 3.5$ .

If an initial  $\log_{10}$  dilution has been carried out, subsequently followed by  $\log_2$  dilutions, values are divided by 10 before taking logarithms to base 2. For example, dilutions of 1/10, 1/20, 1/40, 1/80 would be coded as 0, 1, 2, 3 (1/10 is coded 0 because it is equivalent to undiluted serum), giving a mean of 1.5. Then:  $\text{GMT}/10 = 2^{1.5} = 2.8$ . Thus,  $\text{GMT} = 28$ .

The logarithm of zero cannot be expressed because it is 'minus infinity'. Therefore, when calculating means of coded titres, seronegative animals have to be excluded because their reciprocal titres are zero and therefore cannot be coded; *mean titres can be calculated only for seropositive animals*. Thus, when comparing coded antibody titres in populations, two parameters must be considered before inferences are made: the relative proportion of seropositive animals, irrespective of titre, and the GMTs of the seropositive populations. For instance, it might be found that in two dairy herds approximately 20% of cows in each herd were seropositive to *Leptospira*, serovar *pomona*, but that the GMT in one herd was 40 while in the other it was 640. Such circumstances might indicate a recent epidemic in the second herd and merely the persistence of antibodies in convalescent animals in the first. Conversely, a serological survey of workers in two different abattoirs might reveal similar GMTs of complement fixing antibodies to *Coxiella burnetii* in each group of seropositive workers, but at one abattoir 30% of workers

had titres, while at the other only 3% were seropositive. Such results would indicate a much greater probability of infection at the first abattoir, although the GMTs of the groups were similar.

## Quantal assay

A quantal assay measures an 'all-or-none' response; for example, agglutination or no agglutination, infected or non-infected. Two systems frequently are used:

1. single serial dilution assay;
2. multiple serial dilution assay.

The first is the commoner. Both techniques utilize geometric (logarithmic) dilutions, the range of dilution depending on the sensitivity of the test. Sensitivity here refers to the ability of the system to detect amounts of antibody and antigen: the more sensitive the test, the smaller the amount of antibody and antigen it will detect. This is sometimes more fully termed **analytical sensitivity**, to avoid confusion with sensitivity as a validity parameter of a diagnostic test – more fully termed **diagnostic sensitivity** (Stites *et al.*, 1997).

### Single serial dilution assay

In a single serial dilution assay, each dilution is tested once. For instance, in a virus haemagglutination-inhibition test, the highest dilution that prevents agglutination of erythrocytes on a test plate is the antibody's haemagglutination-inhibition titre. This is a relatively 'weak' form of measurement. If the titre is 1/32 it implies that 1/33 would not produce the effect. However, since 1/64 is the next highest dilution that is tested, the actual titre could lie between 1/63 and 1/32. Thus, this type of titration, which tests only dilution intervals, actually divides the dilutions into blocks. The blocking is more marked when titres are expressed as 'less than' or 'greater than' (e.g. <1/8 or >1/256). The data therefore are essentially **ordinal** (see Chapter 9).

## Multiple serial dilution assay

In a multiple serial dilution assay, each dilution is tested several (preferably at least five) times. The object is to achieve a 'strong' measure. The end point is the dilution of a substance at which a specified number of members of a test group show a defined effect, such as death or disease. The most frequently used and statistically useful end point is 50% (Gaddum, 1933). Thus, in pharmacology, the toxicity of a drug can be expressed as an LD<sub>50</sub> (lethal dose<sub>50</sub>): the amount of drug that will kill 50% of test animals. An amount of drug therefore can be expressed in terms of the number of LD<sub>50</sub>s that it contains.

Fifty per cent end-point titrations can also be used to estimate antibody concentrations, in which case antibody titres are expressed in terms of the dilution of serum that *prevents* an effect in 50% of members of a test group, the effect being produced by the infectious agent responsible for induction of the antibodies that are being titrated. For example, the dilution of serum that prevents infection of 50% of cell culture monolayers with a standard concentration of virus can be estimated: an 'effective dose<sub>50</sub>' (ED<sub>50</sub>). Several methods of calculating 50% end points are available, including the Reed–Muench and Spearman–Kärber methods, and moving averages. The Reed–Muench method is not recommended because precision cannot be assessed, there is no validity test, and the method is less efficient than some of the alternatives (Finney, 1978). The second method (Spearman, 1908; Kärber, 1931), which involves relatively simple calculations, is described below.

**Example of a Spearman–Kärber titration** The antibody titre to a virus is required. The defined measured response is a cytopathic effect (CPE) in cell culture monolayers. The test serum is diluted (usually in twofold geometric increments). One-tenth of 1 ml of each dilution is inoculated into groups of five cell culture monolayers, each of which has been inoculated with a fixed, potentially lethal, dose of the virus. *Table 17.3* depicts the results. The 50% end point is the

**Table 17.3** Example of a 50% end-point titration (Spearman–Kärber method).

Serum dilution	Log <sub>10</sub> dilution	Monolayers showing cytopathic effect	Intact monolayers	Proportion 'positive' (intact) P	1 – P
1/1	0.0	0	5	1.00	0.00
1/2	-0.3	0	5	1.00	0.00
1/4	-0.6	0	5	1.00	0.00
1/8	-0.9	1	4	0.80	0.20
1/16	-1.2	1	4	0.80	0.20
1/32	-1.5	3	2	0.40	0.60
1/64	-1.8	4	1	0.20	0.80
1/128	-2.1	5	0	0.00	1.00

dilution of serum that prevents a CPE in 50% of the monolayers in a group, that is, in two and a half monolayers (note that this is clearly a statistical estimation).

According to the Spearman–Kärber formula:

$$\log ED_{50} = L - d(\sum P - 0.5)$$

where:

$L$  = log highest dilution at which all monolayers survive intact;

$d$  = log of the dilution factor (i.e., the difference between the log dilution intervals);

$\sum P$  = sum of the proportion of 'positive' tests (i.e., intact monolayers), from the highest dilution showing a positive result to the highest dilution showing all results positive (i.e.,  $P = 1$ ).

From Table 17.3:

$$L = -0.6$$

$$d = \log_{10} 2 \\ = 0.3$$

$$\sum P = 0.20 + 0.40 + 0.80 + 0.80 + 1.00 \\ = 3.2.$$

Thus:

$$\log_{10} ED_{50} = -0.6 - \{0.3(3.2 - 0.5)\} \\ = -0.6 - (0.3 \times 2.7) \\ = -0.6 - 0.8 \\ = -1.4.$$

Therefore,  $ED_{50}$  = antilog (-1.4)  
= 1/antilog 1.4  
= 1/25.1.

Thus 0.1 ml of serum contains 25.1  $ED_{50}$ s, and 1 ml contains 251  $ED_{50}$ s.

The estimated standard error (e.s.e.) is calculated using:

$$\text{e.s.e.}(\log_{10} ED_{50}) = d \sqrt{\sum \{P(1 - P)\} / (n - 1)}$$

where  $n$  = number of animals in each group.

Substituting the values from Table 17.3:

$$\log_{10} \text{e.s.e.} = \\ 0.3 \sqrt{\{(0.2 \times 0.8) + (0.4 \times 0.6) + (0.8 \times 0.2) + (0.8 \times 0.2)\} / (5 - 1)} \\ = 0.3 \sqrt{(0.16 + 0.24 + 0.16 + 0.16) / 4} \\ = 0.13.$$

Multiple serial dilution assays are now less common than previously because they are more expensive and slower than single serial dilution assays, and titrations conducted on single dilutions – notably the enzyme-linked immunosorbent assay (ELISA). However, they still have a role in measuring vaccinal potency.

## Serological estimations and comparisons in populations

### Antibody prevalence

The presence of detectable antibody indicates that an animal or its dam has been exposed to the antigen that stimulates the antibody's production. In the absence of further challenge, the antibody level will decline. The rate of decline, usually measured in terms of the antibody's **half-life** (the time taken for its level to halve), varies between antibodies. Titres to some antibodies persist because the antibodies have a long half-life or there is persistent infection or repeated challenge. The possession of a long half-life explains why some vaccines can produce lifelong immunity after a single course. The half-life of vaccinal antibodies therefore is an important aspect of vaccinal efficacy (see also Chapter 16) and of passively acquired immunity in young animals. The half-life of antibodies following natural infection, however, is rarely estimated.

If the amount of antibody in an animal population is to be estimated, without particular regard to the frequency distribution of antibody titres, animals are categorized as either 'positive' or 'negative', and the prevalence of antibodies in the population (i.e., seroprevalence), with its associated confidence interval, can be calculated using the methods described in Chapter 13. A titre cut-off point, below which animals are considered to be negative, and above which animals are categorized as positive, is often defined (see below).

The prevalence of detectable antibody depends on the rate of infection, the rate of antibody loss and the time at which these rates have been effective. A high prevalence therefore may reflect not a high rate of infection but a low rate of antibody loss; recall (Chapter 4) that prevalence,  $P$ , is related to incidence,  $I$ , and duration,  $D$ :

$$P \propto I \times D.$$

It follows that not only the prevalence of detectable antibody in a population but also the titre in the individual is related to the half-life of the antibody.

If the frequency distribution of antibodies is required, then, if the scale of measurement is 'strong' (e.g., an  $ED_{50}$ ), the mean and standard deviation can be quoted and confidence intervals can be calculated (see Chapter 12).

The much more common single-serial dilution assays, which define a titre as the highest dilution producing a test reaction, produce ordinal data; this is particularly evident when a large proportion of the titres are expressed as 'less than' or 'greater than' a particular dilution. If there are not any 'less than' or 'greater than' titres, and there is a reasonable spread of

titres, then the log titres can be regarded as crude approximations to Normally distributed measurements, and the mean, standard deviation and confidence intervals can again be quoted. However, if these assumptions are not met, the median and semi-interquartile range should be quoted. Confidence intervals for the median can also be calculated (see Chapter 12).

### Rate of seroconversion

If a population is susceptible to infection at birth, the duration of antibodies following infection is lifelong, and mortality due to infection is negligible, a simple mathematical model can be used to describe the age distribution of antibodies for various rates of seroconversion (Lilienfeld and Lilienfeld, 1980).

If  $p$  = probability of becoming infected in one year (i.e., rate of seroconversion);  $y$  = age in years;  $(1 - p)^y$  = probability of not having become infected by age  $y$  (i.e., in  $y$  years);  $P_y$  = proportion of population that have become infected by age  $y$  (i.e., seroprevalence at age  $y$ ), then:

$$P_y = 1 - (1 - p)^y.$$

It is also possible to estimate the rate of seroconversion from age-specific seroprevalence values by inversion of the formula:

$$\log(1 - p) = \{\log(1 - P_y)\}/y.$$

Therefore:

$$(1 - p) = \text{antilog}\{\{\log(1 - P_y)\}/y\},$$

and:

$$p = 1 - \text{antilog}\{\{\log(1 - P_y)\}/y\}.$$

A series of age-specific seroprevalence values can therefore produce estimates of rates of seroconversion, and changes in these can provide information on the patterns and effects of infection in a herd. Table 17.4 lists the age-specific seroprevalence values for antibodies against bovine leucosis virus in a random sample of beef cattle. There is a slow increase in seroprevalence with age, up to and including 10 years. This infection produces chronic latent infections with persistent antibodies, and so the rate of seroconversion can be calculated.

Thus, for one-year-old animals ( $y = 1$ ):

$$\begin{aligned} p &= 1 - \text{antilog}\{\{\log(1 - 0.15)\}/1\} \\ &= 1 - \text{antilog}(-0.0706/1) \\ &= 1 - 0.850 \\ &= 0.150; \end{aligned}$$

for two-year-old animals ( $y = 2$ ):

**Table 17.4** Age-specific seroprevalence and annual mean seroconversion rates for bovine leucosis virus reactors in a sample of Louisiana beef cattle, 1982–1984. (Modified from Hugh-Jones and Hubbert, 1988.)

Age (years)	Number of cattle tested	Seroprevalence ( $P_y$ )	Annual mean seroconversion rates ( $p$ )
1	67	0.15	0.150
2	191	0.21	0.111
3	105	0.23	0.083
4	143	0.39	0.116
5	167	0.40	0.097
6	137	0.47	0.100
7	98	0.53	0.102
8	92	0.55	0.095
9	32	0.63	0.105
10	53	0.60	0.088
>10*	19	0.37	0.036

\* Average age used in calculating  $p = 12.5$ .

$$\begin{aligned} p &= 1 - \text{antilog}\{\{\log(1 - 0.21)\}/2\} \\ &= 1 - \text{antilog}(-0.1024/2) \\ &= 1 - 0.889 \\ &= 0.111; \end{aligned}$$

and so on.

There is a steady estimated rate of seroconversion in animals up to 10 years of age, suggesting that the disease is having little impact on the herd: if diseased animals were being culled, a reduction in estimated seroconversion rates (because of the removal of seropositive animals) could be expected from about 6 years of age. The relatively high seroconversion rate in animals 12–23 months of age could (speculatively) be due to the curiosity of young heifers or persistent passive immunity. The low seroprevalence and seroconversion rate in animals greater than 10 suggests that preferential culling of affected animals is only taking place at that age.

Houe and Meyling (1991) and Houe *et al.* (1995) further exemplify calculation of rate of seroconversion in relation to bovine virus diarrhoea virus infection.

More complex models, which can be applied to infections in which antibodies decline during life, are reviewed by Muench (1959).

## Comparison of antibody levels

### Comparison of two different populations

If a comparison of two different populations in terms of presence and absence of antibody (i.e., ‘positive’ or ‘negative’ animals) is required, then the  $\chi^2$  test can be used; alternatively, confidence intervals for differences between two proportions for independent samples can be calculated (see Chapter 14).

**Table 17.5** Serum antibody titres (SN<sub>50</sub>: serum neutralizing dose<sub>50</sub>) of dogs, for two types of rabies vaccine, before and 60 days after vaccination. (From Merry and Kolar, 1984.)

Vaccine	Dog number	Pre-vaccination titre		Titre 60 days after vaccination	
		Reciprocal	log <sub>10</sub>	Reciprocal	log <sub>10</sub>
Killed vaccine feline cell origin	A653	3	0.48	214	2.33
	A616	3	0.48	182	2.26
	2C10	2	0.30	280	2.45
	2B39	2	0.30	267	2.43
	2B47	2	0.30	198	2.30
Mean:		2.4	0.372	228	2.354

$$\sum x_1 = 11.77; n_1 = 5; \sum x_1^2 = 27.7339; \bar{x}_1 = 2.354; s_1 = 0.083.$$

Killed vaccine porcine cell line origin	A603	3	0.48	10	1.00
	A654	2	0.30	51	1.71
	A618	2	0.30	9	0.95
	2C16	2	0.30	16	1.20
	2C3	2	0.30	38	1.58
Mean:		2.2	0.366	25	1.288

$$\sum x_2 = 6.44; n_2 = 5; \sum x_2^2 = 8.763; \bar{x}_2 = 1.288; s_2 = 0.342.$$

If the frequency distributions of antibodies in two populations are to be compared, then, if the scale of measurement is 'strong', a parametric test can be used. Moreover, since antibodies are usually lognormally distributed, standard tests that assume Normality can be used.

An ED<sub>50</sub>, calculated in multiple serial dilution assays, is a 'strong' measurement. The following example uses the data in *Table 17.5* relating to vaccination titres in two groups of five dogs, one group vaccinated with killed rabies virus of porcine origin, and the other with vaccine of feline origin. The comparison is between the titres in each group, 60 days after vaccination. Log titres are used; this transformation allows the assumption of Normality. Student's *t*-test for independent samples less than 30 can be used (see Chapter 14), assuming unknown variance. Using the same notation as that in Chapter 14,

$$n_1 = 5, \bar{x}_1 = 2.354, s_1 = 0.083,$$

$$n_2 = 5, \bar{x}_2 = 1.288, s_2 = 0.342.$$

The hypothesis to be tested is that there is no difference in 60-day antibody titres between the dogs vaccinated with killed rabies virus of porcine origin and dogs vaccinated with vaccine of feline origin.

Let  $\mu_1$  and  $\mu_2$  be the mean 60-day titres in the two groups, and let  $\delta = \mu_1 - \mu_2$ . The hypothesis then may be written as  $\delta = 0$ .

First it is necessary to check that  $s_1^2$  and  $s_2^2$  are estimates of a common population variance. This is done by calculating the ratio of the two variances, where

the numerator is the greater of the two. This ratio is then compared with the appropriate percentage points of an *F*-distribution (Appendix XXIII) with a pair of degrees of freedom, the first being one less than the sample size used in calculating the variance in the numerator, and the second being one less than the sample size used in calculating the variance in the denominator. In this particular case:

$$s_2^2/s_1^2 = 17.0$$

with (4,4) degrees of freedom.

The 1% point of the corresponding *F* distribution is 15.98. The sample value of 17.0 is greater than this value. The sample value therefore is significant at the 1% level and there is strong evidence to suggest that the variances of the log<sub>10</sub> of 60-day antibody titres differ between groups.

The test statistic in this situation is now:

$$t = (\bar{x}_1 - \bar{x}_2 - \delta) / \sqrt{(s_1^2/n_1) + (s_2^2/n_2)}$$

with approximate degrees of freedom,  $\nu$ , given by:

$$\nu = (v_1 + v_2)^2 / \{v_1^2/(n_1 - 1) + v_2^2/(n_2 - 1)\}$$

where:

$$v_1 = s_1^2/n_1$$

and:

$$v_2 = s_2^2/n_2$$

to take account of unequal variances (Snedecor and Cochran, 1989).

For this example:

$$\begin{aligned}
 t &= (2.354 - 1.288 - 0) / \sqrt{(0.083^2/5) + (0.342^2/5)} \\
 &= 1.066 / \sqrt{0.00138 + 0.02339} \\
 &= 6.773.
 \end{aligned}$$

Thus:

$$\begin{aligned}
 v &= (0.00137 + 0.02341)^2 / (0.00000466 + 0.00037) \\
 &= 4.47.
 \end{aligned}$$

Rounding down to the nearest whole number, when using the *t*-table (Appendix V) there are only 4 degrees of freedom because the variances differ significantly. From Appendix V, the 5% value for 4 degrees of freedom is 2.776, which is less than 6.773. Therefore, the two groups of dogs have significantly different mean titres at the 5% level. Note that the result is also significant at the 2% level and the 1% level.

An alternative approach is estimation of confidence intervals for the difference between the means of two independent samples, noting that the variances (and therefore the standard deviations) differ (see Chapter 14).

Single-serial dilution assays present a more difficult choice of statistical test because the titres are ordinal. Again, if there are not any 'less than' or 'greater than' titres, and there is a reasonable spread of titres, then the log titres can be regarded as crude approximations to Normally distributed measurements, and a *t*-test for independent samples can be used; otherwise the non-parametric Wilcoxon–Mann–Whitney test should be applied; alternatively, confidence intervals can be calculated for the difference between two medians for independent samples (see Chapter 14).

### Comparison of different estimates on the same population

If a population is sampled twice over a period of time, and animals are classified as positive or negative, then a suitable comparison can be made using McNemar's change test (see Chapter 14). If the frequency distribution of antibodies is to be compared, then a *t*-test for related samples should be applied – again using log titres to assume Normality (see Chapter 14). The test is described in standard statistical texts. The appropriate non-parametric equivalent is the Wilcoxon signed ranks test (see Chapter 14). Again, confidence intervals can be calculated for the difference between two means or two medians for related samples (see Chapter 14).

## Interpreting serological tests

### Refinement

Infectious agents have a variety of antigens on their surfaces and in their interiors. Additionally, non-structural

**Table 17.6** The classification of some influenza A viruses. (Mainly from Murphy and Webster, 1990; Zambon, 1998.)

Haemagglutinins (H) and neuraminidases (N)	Strains
H1 N1	PR/8/34
H1 N1	Sw/la/15/30
H2 N2	Sing/1/57
H3 N2	HK/1/68
H3 N2	Sw/Taiwan/70
H3 N8	Eq/Miami/1/63
H3 N8	A/Eq-2/Suffolk/89
H3 N8	A/Eq-2/Newmarket2/93
H3 N8	A/Eq-2/Newmarket2/95
H4 N6	Dk/Cz/56
H5 N3	Tern/S.A./61
H6 N2	Ty/Mass/3740/65
H7 N7	Eq/Prague/1/56
H7 N7	A/Bury/1239/94

antigens can be detected in the early stages of virus replication. Some of the antigens are shared by several groups of isolates and are the basis of division into broad categories. Other antigens are unique to a particular group of isolates. For instance, influenza type A viruses are distinguished from types B and C by their core nucleoproteins and matrix proteins. Influenza A viruses are divided into subtypes on the basis of their surface haemagglutinin and neuraminidase antigens. Similarly, subtypes are divided further into strains according to more refined differences in the antigenic composition of the haemagglutinins and neuraminidases (Table 17.6). This refinement in antigenic definition is also termed specificity. This is sometimes more fully termed **analytical specificity** (Stites *et al.*, 1997), to avoid confusion with specificity as a validity parameter of a diagnostic test – more fully termed **diagnostic specificity** (see below).

The epidemiological value of a serological test, for example when tracing the spread or origin of a particular infection, increases in relation to the test's ability to detect more refined antigenic differences. The new molecular diagnostic techniques are particularly valuable in this respect (see Chapter 2).

Serological tests vary in their ability to detect subtle antigenic differences. Table 17.7 illustrates varying refinement of serological tests for influenza A viruses. The complement fixation test (CFT), using virus extracted from chorioallantoic membranes as antigen, will detect antibody against virus nucleoprotein, and therefore is specific only to the level of virus type. However, the use of whole virus as antigen results in a CFT that is specific for subtypes because it will detect particular subtypes of haemagglutinins and neuraminidases. Identification of specific strains is possible if carefully selected reference strains are used

**Table 17.7** Summary of tests for influenza serology. (From Stuart-Harris and Schild, 1976.)

Test	Test antigens	Antibody detected	Recommended use <sup>B</sup>	
			Serosurvey	Serodiagnosis
HI	Whole virus	HA <sup>§</sup>	++++	++++
NI	Whole virus	NA <sup>§</sup>	++++	
CF	CAM extract	NP		++
SRD	Whole virus	HA, NA		+++
	Whole virus*	HA, NA	+++	++++
IDD	Disrupted virus*	NP, MP		+++
	Disrupted virus*	HA, NA	+	++
N-IHA	Disrupted virus*	NP, MP	+	++
	NA	NA	++++	

HI = haemagglutination inhibition

NI = neuraminidase inhibition

CF = complement fixation

SRD = single radial immunodiffusion

IDD = immuno-double-diffusion

N-IHA = neuraminidase-indirect haemagglutination

HA = haemagglutinin

NA = neuraminidase

NP = nucleoprotein

MP = matrix protein

CAM = chorioallantoic membrane

<sup>B</sup> The usefulness of the test for the indicated purpose is expressed on a scale of + (least useful) to ++++ (most useful).

<sup>§</sup> Serum containing high antibody titre to the second surface antigen (HA or NA) may at low dilutions and under certain conditions cause inhibition.

\* Test refinement (specificity) achieved by selecting viruses or recombinant viruses with the required antigenic composition.

as antigens; the titre of antibodies to haemagglutinins and neuraminidases is highest when the antibodies are directed against the strain-specific antigens. It should be emphasized that one type of test is not always more refined than another (e.g., radial immunodiffusion versus complement fixation) for all antigen/antibody reactions; the refinement also depends on the nature of the antigen that is used in the test.

## Accuracy

In common with other diagnostic tests, 'false positives' and 'false negatives' can occur (see Chapter 9). Table 17.8 lists the reasons for positive and negative results in serological tests.

### Positive results

A true positive result derives from actual infection.

False positive results occur for a variety of reasons.

**Group cross-reactions** can occur between an infectious agent and antibodies to different organisms with similar antigens. For example, infection with *Yersinia enterocolitica*, O:9, can produce antibodies that cross-react with *Brucella abortus* antigens (Kittelberger *et al.*, 1995). Similarly, cases of paratuberculosis (Johne's

**Table 17.8** Reasons for positive and negative results in serological tests. (From Stites *et al.*, 1982.)

<i>Positive results</i>		
Actual infection		true +ve
Group cross-reactions	}	false +ve
Non-specific inhibitors		
Non-specific agglutinins		
<i>Negative results</i>		
Absence of infection	}	false -ve
Natural or induced tolerance		
Improper timing		
Improper selection of test		
Non-specific inhibitors e.g. anticomplementary serum; tissue culture toxic substances		
Antibiotic induced immunoglobulin suppression		
Incomplete or blocking antibody		
Insensitive tests		

disease) can produce positive reactions to mammalian and avian tuberculin (Körmendy, 1988).

**Non-specific inhibitors** present in serum may inhibit reactions that normally are associated with the action of intact antigens that are not specifically bound to antibody. These inhibitors therefore mimic the effects of antibody in the latter's absence. An example is non-specific inhibitors in haemagglutination tests

against influenza viruses. Agglutination of antigen by **non-specific agglutinins** similarly mimics the effect of antibodies that are agglutinins.

### Negative results

A true negative result indicates absence of infection.

Again, false negative results can occur for several reasons. Some animals show **natural** or **induced tolerance** to antigens and therefore do not produce antibodies when challenged with the agent. Thus, exposure of the bovine fetus to bovine virus diarrhoea in the first half of gestation results in offspring that do not produce detectable antibodies when challenged with the same strain of virus (Coria and McClurkin, 1978).

**Improper timing** may result in a test's failure to detect infection. For instance, sampling of some cows before abortion, using the CFT, may not detect *Br. abortus* because detectable complement fixing antibodies may not appear until after abortion (e.g., Robertson, 1971).

Some tests may be **unsuitable** for detecting infection. Thus, infection by African swine fever virus cannot be detected using a serum neutralization test because infected pigs do not produce detectable levels of neutralizing antibodies (De Boer, 1967); an immunofluorescence test will, however, detect antibodies.

Some **non-specific inhibitors** will produce false negative results by their mode of action (c.f. those above that produce false positive results). Some sera, notably contaminated and haemolysed specimens, are anticomplementary; thus complement cannot be fixed in the CFT and the test is therefore assumed to be negative although antibodies may be present. This can occur with CFTs for *Br. abortus* infections (Worthington, 1982). Similarly, substances that are toxic to tissue culture monolayers may mimic the effects of un-neutralized virus, giving the impression that neutralizing antibodies are absent when they may be present.

Some antibodies are **incomplete** and so cannot take part in antigen/antibody test reactions. A common type of canine autoimmune haemolytic anaemia is characterized by incomplete antibodies on the surface of red blood cells, which can only be detected by an antiglobulin test (Halliwell, 1978). Occasionally **blocking antibodies** prevent antigen/antibody reactions occurring. This occurs sometimes when conducting CFTs for bovine *Br. abortus* infection (Plackett and Alton, 1975), as a result of excess IgG<sub>1</sub> blocking IgG<sub>2</sub> (the latter being responsible for complement fixation) at low concentrations: this is the 'prozone' effect.

Finally, a serological test may be too **insensitive** to detect antibody. Sensitivity in this context again refers to the ability of a test to detect amounts of antibody or

**Table 17.9** Relative analytical sensitivity of assays for antigens and antibodies. (From Stites *et al.*, 1997.)

Technique	Approximate sensitivity (per dl)
Total serum proteins (by biuret or refractometry)	100 mg
Serum protein electrophoresis (zone electrophoresis)	100 mg
Analytical ultracentrifugation	100 mg
Immuno-electrophoresis	5–10 mg
Immunofixation	5–10 mg
Single radial diffusion	<1–2 mg
Double diffusion in agar (Ouchterlony)	<1 mg
Electroimmunodiffusion (rocket electrophoresis)	<0.5 mg
One-dimensional double electroimmunodiffusion (counterimmunoelectrophoresis)	<0.1 mg
Nephelometry	0.1 mg
Complement fixation	1 µg
Agglutination	1 µg
Enzyme immunoassay (ELISA)	<1 µg
Quantitative immunofluorescence	<1 pg
Radioimmunoassay	<1 pg

antigen (i.e., **analytical sensitivity**). Table 17.9 lists some common serological tests and their approximate analytical sensitivities. Some of the new molecular techniques (e.g., the polymerase chain reaction) are extremely analytically sensitive (Belák and Ballagi-Pordány, 1993) and therefore compare favourably with serological tests in detecting infection (Kitchin *et al.*, 1990).

## Evaluation and interpretation of diagnostic tests

The second part of this chapter describes the procedures for evaluating diagnostic tests in general, and relates test characteristics to the performance of various testing strategies.

### Sensitivity and specificity

**Diagnostic sensitivity** and **diagnostic specificity** were introduced in Chapter 9 as indicators of the **validity** of diagnostic tests; and, for brevity, were just termed sensitivity and specificity; this convention will be followed in the remainder of this chapter. Although the discussion is largely in the context of serological investigations, it is equally relevant to other types of diagnostic test and their application (e.g., in genetic screening), as well as to the evaluation of questionnaires. To



reiterate: the **sensitivity** of a diagnostic method is the proportion of true positives that are detected by the method; the **specificity** of the method is the proportion of true negatives that are detected.

### Continuous and ordinal test variables

Sensitivity and specificity can be calculated for tests in which the variable that is measured is nominal and dichotomous, for example presence or absence of tapeworms (Table 9.4). However, in many tests, the test variables are continuous (e.g.,  $\alpha$ -mannosidase levels: see Chapter 22), or are measured on the ordinal scale (e.g., single-serial dilution antibody titres). Although methods for evaluating such tests are available (e.g., estimating the mean and standard deviation of the difference between the test measurement and a valid reference measurement: Bland and Altman, 1986), it is common practice to dichotomize measurements into 'positive' or 'negative'. This requires definition of a **cut-off point**.

When a cut-off point is identified, there is then clearly an inverse relationship between sensitivity and specificity in a particular test. This is illustrated in Figure 17.1 in which the upper graph represents the frequency distribution of a variable in a healthy population and the lower graph represents its fre-

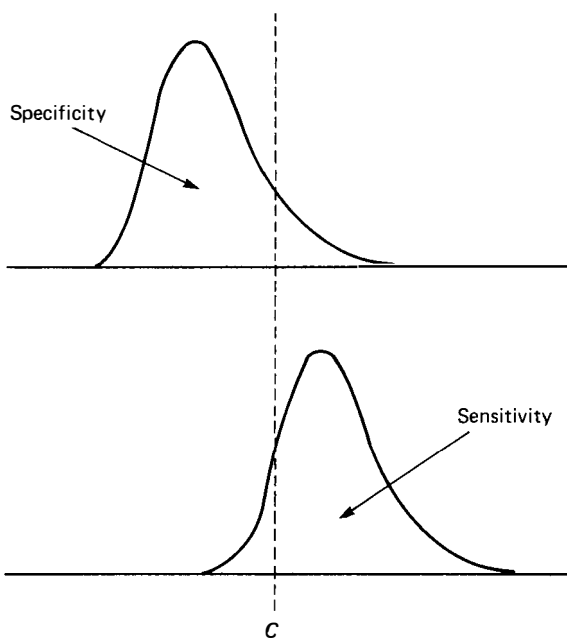

**Fig. 17.1** The relationship between sensitivity and specificity for continuous test variables (see text for explanation). Upper graph = frequency distribution of a variable in a healthy population; lower graph = frequency distribution of the variable in a diseased population; C = cut-off point defining the boundary between healthy and diseased individuals.

quency distribution in a diseased population. Individuals for whom the variable's value is to the right of the cut-off point, C, are classified as test-positive; individuals for whom the variable's value is to the left of the cut-off point are classified as test-negative. Animals with values to the right of the cut-off point in the upper graph are false positives; animals with values to the left of the cut-off point in the lower graph are false negatives. If the area under each curve represents 100%, then the marked area to the right of the cut-off point corresponds to the test's sensitivity, whereas the marked area to the left of the cut-off point corresponds to the test's specificity. If fewer false positives are required, C is moved to the right: specificity increases and sensitivity decreases. However, if fewer false negatives are required, C is moved to the left: sensitivity increases and specificity decreases.

Table 17.10 also illustrates the inverse relationship between sensitivity and specificity in the ELISA for antibody to *Brucella abortus*. As the cut-off point (positive threshold) increases, sensitivity decreases and specificity increases.

**Defining the cut-off point** Cut-off points have been determined in several ways. They have been arbitrarily defined as two (e.g., Coker-Vann *et al.*, 1984) or three (e.g., Gottstein, 1984) standard deviations greater than the mean of the test values of the unaffected individuals. Alternatively, the value that minimizes the total number (Cummings and Richard, 1988) or total cost (Anderson, 1958) of misdiagnoses can be selected. The optimum cut-off point also depends on the frequency distribution of the test variable in the healthy and diseased populations, which may be complicated. This topic is discussed in detail by Weinstein and Fineberg (1980) and Vizard *et al.* (1990). Although these sophisticated methods are required for optimum selection of the ideal cut-off point, some relatively simple techniques can be used as guides to selection. Two of these – calculation of **likelihood ratios**, and construction of **ROC curves** – are introduced later in this chapter.

When a large cross-section of the population is initially tested to detect disease (e.g., in screening), interpretation of the test is generally directed towards increased sensitivity at the expense of specificity. This is because initial tests are not usually intended to provide definitive diagnoses, but are designed to detect as many cases as possible. Therefore, a high proportion of false positives (resulting from increased sensitivity) is not as critical as a high proportion of false negatives (resulting from increased specificity), and the cut-off point is shifted accordingly.

**Table 17.10** Effect of various positive thresholds on the serodiagnostic interpretation of the enzyme immunoassay (ELISA) for the detection of bovine antibody to *Brucella abortus*. (From Agriculture Canada, 1984.)

Positive <sup>a</sup> threshold	Sensitivity <sup>b</sup>	Specificity <sup>c</sup>		Prevalence <sup>e</sup> of disease (%)	Predictive value		
		Non-vac	Vac <sup>d</sup>		+ve test		-ve test
					Non-vac	Vac <sup>c</sup>	Either
≥0.220	0.960	0.990	0.852	10	0.92	0.42	1.00
				1	0.50	0.06	1.00
				0.1	0.09	0.01	1.00
≥0.260	0.943	0.995	0.930	10	0.95	0.60	0.99
				1	0.64	0.12	1.00
				0.1	0.15	0.01	1.00
≥0.300	0.937	0.998	0.948	10	0.98	0.67	0.99
				1	0.84	0.15	1.00
				0.1	0.34	0.02	1.00
≥0.340	0.920	0.999	0.969	10	0.99	0.77	0.99
				1	0.90	0.23	1.00
				0.1	0.48	0.03	1.00

<sup>a</sup> Minimum reactivity (expressed as Absorbance<sup>414</sup>) considered to be antibody positive.

<sup>b</sup> Sensitivity based on 175 sera from *Brucella* culture-positive cattle.

<sup>c</sup> Specificity (non-vaccinates) based on 1128 sera from *Brucella*-free herds; specificity (vaccinates) based on 1079 sera from field vaccinated cattle.

<sup>d</sup> *B. abortus* strain 19 vaccination status.

<sup>e</sup> Theoretical disease prevalence.

### Ascertaining true status

Calculation of sensitivity and specificity requires an independent, valid criterion – also termed a ‘gold standard’ – by which to define an animal’s true disease status. Thus, when evaluating the centrifugation/flotation technique for diagnosing equine cestodiasis (Table 9.4), post-mortem examination of the intestinal tract was the gold standard. Similarly, in the evaluation of the ELISA for brucellosis, bacterial culture was used to define true positives, whereas true negative animals were selected from herds known to be *Brucella*-free (Table 17.10). A battery of alternative tests may also be used as a gold standard, animals being defined as true positives if they are simultaneously positive to several tests, and categorized as true negatives if they are simultaneously negative to the tests (Mateu-de-Antonio *et al.*, 1993). Sometimes, several standards may be used. For example, the sensitivity of the caudal-fold tuberculin test has been estimated as being between 80.4% and 84.4%, using one or more of four standards: positive on bacteriological culture alone; positive on histological examination alone; simultaneously positive to bacterial culture and histological examination; and positive to either bacteriological culture or histological examination (Whipple *et al.*, 1995).

The diseased and healthy animals to which the gold standard is applied should be representative of the

population in which the test is to be applied. Thus, a screening test is conducted in the general population, and so the gold standard should be applied to a sample of diseased and healthy animals drawn from this population. In contrast, a clinical diagnostic test is run on animals for which there is usually already evidence of disease, and the test needs to distinguish between animals with the relevant condition (the ‘diseased’ animals) and those animals with diseases that are similar to the condition (these therefore constitute the ‘healthy’ animals). It follows that the sensitivity and specificity of a test may be different when it is applied as a screening test than when it is used as a diagnostic test in a veterinary clinic. Martin and Bonnett (1987) describe the derivation of sensitivity and specificity in a clinical setting.

### Confidence intervals for sensitivity and specificity

Confidence intervals for sensitivity and specificity can be calculated using the formula for interval estimation of a proportion (see Chapter 12). Recall, however (Chapter 13), that this should not be used for very low (<5%), or very high (>95%), values of a proportion. Values of sensitivity and specificity may exceed 95%, and application of this formula can then lead to anomalies (e.g., an upper confidence limit greater than 100%). In such circumstances, Appendix VII may be

**Table 17.11** Possible results of a diagnostic test.

Test status	True status		Totals
	Diseased	Not diseased	
Diseased	a	b	a + b
Not diseased	c	d	c + d
Totals	a + c	b + d	a + b + c + d

used, if the sample size is small. However, the method of Wilson (1927) is now generally recommended. This involves calculating three values,  $A$ ,  $B$  and  $C$ , where, for a 95% interval:

$$A = 2r + 1.96^2;$$

$$B = 1.96\sqrt{1.96^2 + 4r(1 - P)};$$

$$C = 2(n + 1.96^2);$$

where:

$r$  = number of individuals with the feature of interest;

$n$  = number in the sample;

$P$  = observed proportion.

The confidence interval is then  $(A - B)/C$ ,  $(A + B)/C$ .

For example, if 130 known negative animals are tested, and 128 are test-negative ( $d$  in Table 17.11), the point estimate of specificity =  $d/b + d = 128/130 = 98.5\%$ , and the 95% confidence interval is derived thus:

$$\begin{aligned} A &= 2 \times 128 + 1.96^2 \\ &= 256 + 3.84 \\ &= 259.84; \end{aligned}$$

$$\begin{aligned} B &= 1.96\sqrt{1.96^2 + 4 \times 128 \times (1 - 0.985)} \\ &= 1.96\sqrt{3.84 + (512 \times 0.015)} \\ &= 1.96\sqrt{11.52} \\ &= 6.65; \end{aligned}$$

$$\begin{aligned} C &= 2(130 + 1.96^2) \\ &= 267.68. \end{aligned}$$

$$\text{Thus } (A - B)/C = (259.84 - 6.65)/267.68 = 0.946,$$

$$\text{and } (A + B)/C = (259.84 + 6.65)/267.68 = 0.996.$$

That is, the 95% confidence interval = 94.6%, 99.6%.

(Note that the inappropriate application of the formula for interval estimation of a proportion described in Chapter 12 would have generated a lower interval of 96.3%, but an impossible upper interval of 100.6%.)

If other confidence intervals are required, then 1.96 is replaced by the appropriate multiplier (Appendix VI).

Another approach to estimation of the precision of sensitivity and specificity involves modelling the most likely mean, minimum and maximum values from a series of point estimates from several studies. A common method uses the beta-pert distribution<sup>2</sup>. An example, relating to diagnostic tests for bovine brucellosis, is given by Jones *et al.* (2004b). Alternatively, the two extreme percentiles and the median may be modelled (Johnson, 1997).

### Youden's index

Youden's index,  $J$ , combines sensitivity and specificity in a single value of test performance:  $J = \text{sensitivity} + \text{specificity} - 1$ ; or, using the notation in Table 17.11:

$$J = \frac{a}{a + c} + \frac{d}{b + d} - 1.$$

It can take values between 1 (when sensitivity and specificity each equal 100%) and -1 (when sensitivity and specificity each equal 0%: an unlikely situation).

An approximate 95% confidence interval is given by:

$$\begin{aligned} J - 1.96\sqrt{\frac{ac}{(a + c)^3} + \frac{bd}{(b + d)^3}}, \\ J + 1.96\sqrt{\frac{ac}{(a + c)^3} + \frac{bd}{(b + d)^3}}. \end{aligned}$$

This index assumes that sensitivity and specificity are of equal importance, which, as has already been noted, is not usually the case. Its value in judging the value of a test to a disease control programme is therefore limited.

### Predictive value

When using either serological or other screening tests to determine the presence of disease in a population, it is important to know the probability that an animal, 'positive' according to the test, is actually positive; alternatively that a test-negative animal is a true negative. These probabilities are the **predictive values** of the test. The parameter most often quoted as the predictive value of a test is the predictive value of a positive (as opposed to negative) test result.

<sup>2</sup> The beta distribution is a basic distribution of statistics for variables bounded at both sides (Snell, 1987). 'Pert' (Pleguezuelo *et al.*, 2003) is an acronym for Project Evaluation and Review Techniques (originally developed in the context of the *Polaris* missile system), which are stochastic modelling techniques for estimating probability distributions (see Chapter 19).

The predictive value depends on specificity and sensitivity and prevalence. Sensitivity and specificity are innate characteristics of a test for a given reference population, and (for a defined cut-off point) are relatively stable<sup>3</sup>, but the prevalence of a disease in a population being tested will affect the proportion of test positive animals,  $P^T$ , that are actually diseased.

There are two components to  $P^T$ :

1. the true positives;
2. the false positives.

The proportion of animals,  $P^T$ , is then:

$$\{P \times \text{sensitivity}\} + \{(1 - P) \times (1 - \text{specificity})\}.$$

For example, if  $P = 0.01$  (1%), sensitivity = 0.99 (99%) and specificity = 0.99 (99%), then:

$$P^T = \{0.01 \times 0.99\} + \{(1 - 0.01) \times (1 - 0.99)\} \\ = 0.02.$$

This represents an overestimation of 100% (the actual prevalence is 0.01 and the estimated prevalence is 0.02). The smaller the prevalence, the larger the proportional overestimation, that is, the lower the predictive value (positive test result).

The predictive value (positive test result) is given by:

$$\frac{P \times \text{sensitivity}}{\{P \times \text{sensitivity}\} + \{(1 - P) \times (1 - \text{specificity})\}},$$

and the predictive value (negative test result) is given by:

$$\frac{(1 - P) \times \text{specificity}}{\{(1 - P) \times \text{specificity}\} + \{P \times (1 - \text{sensitivity})\}}$$

(Galen, 1982). (Again, if these parameters are quoted as percentages, 1 is replaced by 100 in the formulae.)

Alternatively, the calculation can be expressed more simply in terms of the values in Table 17.11:

- Sensitivity =  $a/(a + c)$ .
- Specificity =  $d/(b + d)$ .
- The predictive value (positive test result) =  $a/(a + b)$ .
- The predictive value (negative test result) =  $d/(c + d)$ .

<sup>3</sup> Variations in sensitivity and specificity, however, can occur. For example, they may be related to differences in severity of lesions, and host characteristics such as body condition (Sergeant *et al.*, 2003). The underlying continuous traits on which tests are usually based have frequency distributions that vary between populations, and so the distribution of these traits, relative to the cut-off point, also varies. Since the distribution also determines prevalence, and misclassification of individuals is more likely when they have values close to the cut-off point, sensitivity and specificity can vary with prevalence (Brenner and Gefeller, 1997). The term 'spectrum bias' has been used to describe the variation in sensitivity and specificity with the distribution of the traits (Ransohoff and Feinstein, 1978).

**Table 17.12** Sensitivity and specificity of four screening tests for bovine brucellosis.

	Sensitivity (%)	Specificity (%)
Tube agglutination test	62.0	99.5
Complement fixation test	97.5	99.0
Brewer card test	95.2	98.5
ELISA*	96.0	99.0

\* Positive threshold  $\geq 0.220$ ; specificity in non-vaccinated cattle (see Table 17.10).

Predictive values are proportions, and so confidence intervals can be calculated in similar fashion to those for sensitivity and specificity.

Five screening tests (or modifications of them) are available for brucellosis testing: the tube agglutination test (TAT), the CFT, the Brewer card test, the ELISA, and the milk ring test. Sufficient data are available to estimate the sensitivity and specificity of the first four (MAF, 1977; Agriculture Canada, 1984). These are summarized in Table 17.12.

Assume that the TAT will be applied to 100 000 cattle in three different areas in which the prevalence of brucellosis is 3%, 0.1% and 0.01% respectively. From these data, and the figures in Table 17.12, the sensitivity, specificity and predictive value (of a positive test result) of the test can be calculated for the populations in each of the three areas.

The results are given in Tables 17.13a, b and c, respectively. As the prevalence of disease declines, so does the predictive value of the test, which could result in an increasing proportion of healthy animals being destroyed in a test and slaughter programme. This is also demonstrated in Table 17.10.

At low prevalence levels, even relatively 'good' tests (sensitivity = 99%; specificity = 99%) have a low predictive value (Figure 17.2). If a test with a sensitivity of 0.990 (99%) and a specificity of 0.999 (99.9%) were used in a disease eradication campaign, then, if the prevalence were 0.1 (10%), a single test conducted on 10 million animals would record 990 000 true positives and 9000 false positives. The test therefore would be acceptable at the beginning of the campaign. However, as the campaign proceeded, the prevalence would fall. When the prevalence was reduced to 0.0001 (0.01%), the test would record 9900 true positives and 9990 false positives. *The number of false positives would be unchanged after the disease was eradicated.* Therefore acceptable levels of sensitivity and specificity depend on the stage of a control or eradication campaign. Ideally, towards the end of an eradication campaign, a more sensitive and specific test is required if the campaign depends only upon a single serological test. In practice, other techniques are used, such as serial

**Table 17.13** Predictive value (positive test result) of the tube agglutination test for bovine brucellosis at three different prevalence levels (sensitivity = 62%; specificity = 99.5%).

Test status	True status		Total
	Brucellosis present	Brucellosis absent	
<i>(a) Prevalence of brucellosis: 3%</i>			
Brucellosis present	1860 (a)	485 (b)	2345
Brucellosis absent	1140 (c)	96 515 (d)	97 655
Total	3000	97 000	100 000
Predictive value (positive result) = $a/(a + b) = 79.3\%$			
<i>(b) Prevalence of brucellosis: 0.1%</i>			
Brucellosis present	62	500	562
Brucellosis absent	38	99 400	99 438
Total	100	99 900	100 000
Predictive value (positive result) = 11.0%			
<i>(c) Prevalence of brucellosis: 0.01%</i>			
Brucellosis present	6	500	506
Brucellosis absent	4	99 490	99 494
Total	10	99 990	100 000
Predictive value (positive result) = 1.2%			

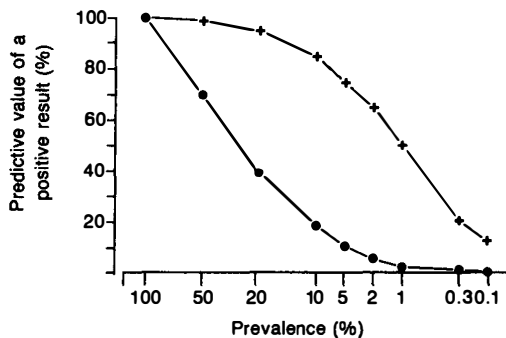
**Fig. 17.2** The relationship between prevalence and predictive value of a positive test result. +: Sensitivity = 99%; specificity = 99%. •: Sensitivity = 70%; specificity = 70%.

testing (see below), isolation of infected farms and maintenance of disease-free areas.

In some tests there are *no false positives*, for example, when identifying blood parasites by microscopic examination of blood films. Estimation of true prevalence in this circumstance is discussed by Waltner-Toews *et al.* (1986c).

Further discussion of the predictive value of serological and other diagnostic tests is provided by Vecchio (1966), Galen and Gambino (1975) and Rogan and Gladen (1978).

### Likelihood ratios

The dependence of predictive values on prevalence is a major disadvantage when a summary measure of

a test's performance, when the test is applied in a population, is required. The **likelihood ratio** provides a suitable summary measure, which is independent of prevalence. It compares the proportion of animals with and without disease, in relation to their test results.

The **likelihood ratio of a positive test result ( $LR+$ )** is the ratio of the proportion of affected individuals that test positive, and the proportion of healthy individuals that test positive. Using the notation and data of Table 17.13a:

$$\begin{aligned} LR+ &= [a/(a + c)]/[b/(b + d)] \\ &= (1860/3000)/(485/97\,000) \\ &= 0.620\,00/0.005\,00 \\ &= 124. \end{aligned}$$

Thus, a positive result is 124 times as likely to come from an animal with brucellosis, as from an animal without the disease. The  $LR+$  is therefore a quantitative indication of the *strength* of a positive result. The perfect diagnostic test would have an  $LR+$  equal to infinity (detecting all true positives, and generating no false positives), and the best test for ruling in a disease is therefore the one with the highest  $LR+$ .

Note that the above formula comprises  $a/(a + c)$ , that is, the sensitivity (the true-positive rate); and  $b/(b + d)$ , that is,  $1 - \text{specificity}$  (the false-positive rate). It may therefore be expressed, alternatively, as:

$$LR+ = \text{sensitivity}/(1 - \text{specificity}).$$

The **likelihood ratio of a negative test result ( $LR-$ )** is the ratio of the proportion of affected individuals

that test negative, and healthy individuals that test negative; that is:

$$\begin{aligned}
 LR- &= [c/(a + c)]/[d/(b + d)] \\
 &= (1140/3000)/(96\,515/97\,000) \\
 &= 0.380\,00/0.995\,00 \\
 &= 0.382.
 \end{aligned}$$

Thus, a negative result is approximately only 0.4 times as likely to come from an animal with brucellosis, as from an animal without the disease. The perfect diagnostic test would have an  $LR-$  equal to zero (producing no false negatives, but detecting all true negatives), and the best test for ruling out a disease is therefore the one with the lowest  $LR-$ .

Note, again, that the above formula comprises  $c/(a + c)$ , that is,  $1 - \text{sensitivity}$  (the false-negative rate) and  $d/(b + d)$ , that is, the specificity (the true-negative rate). It may therefore be expressed, alternatively, as:

$$LR- = (1 - \text{sensitivity})/\text{specificity}.$$

The above formulae for the  $LR+$  and  $LR-$  indicate that these parameters are a function only of sensitivity and specificity. It is for this reason that they are relatively stable.

The likelihood ratio is the ratio of two proportions, and approximate confidence intervals can be calculated via a logarithmic transformation using the formulae for computing approximate confidence intervals for the relative risk, based on cumulative incidence (see Chapter 15). The calculation is not possible with zero values in either cells  $a$  or  $b$ . Altman *et al.* (2000) recommend the addition of 0.5 to each of the four cells to facilitate the calculation in this circumstance. Nam (1995) describes a more complex method, which is reputed to perform better than the previous method.

### Relationship between likelihood ratios and odds

Further characteristics of the likelihood ratio can be explored when the parameter is considered in the context of *odds*: the ratio of the probability of an event occurring to the probability of it not occurring (introduced in Chapter 15). Four new terms may now be introduced, exemplified using data in *Table 17.13a*.

First, the **pre-test probability** (Bayes' 'prior probability': see Chapter 3) of disease is the proportion of animals in a population that have a disease before a test is applied; this is simply the prevalence of disease (0.03).

Secondly, the **post-test probability** (Bayes' 'posterior probability') of disease is the proportion of test-positive animals that are diseased. This has been introduced earlier as the predictive value of a positive test result (0.793).

Thirdly, the **pre-test odds of disease** is the ratio of the pre-test probability of disease and the pre-test probability of not being diseased:

$$\begin{aligned}
 &(3000/100\,000)/(97\,000/100\,000) \\
 &= 0.0300/0.9700 \\
 &= 0.030\,93.
 \end{aligned}$$

Finally, the **post-test odds of disease** is the ratio of the post-test probability of disease and the post-test probability of not being diseased:

$$\begin{aligned}
 &(1860/2345)/(485/2345) \\
 &= 0.7932/0.2068 \\
 &= 3.8356.
 \end{aligned}$$

The  $LR+$  is also the ratio of the post-test odds of disease to the pre-test odds of disease; that is,  $3.8356/0.030\,93 = 124$ .

The pre-test, and post-test, odds of disease are therefore related through the  $LR+$ :

$$\text{pre-test odds of disease} \times LR+ = \text{post-test odds of disease}.$$

Probability, however, is a more familiar quantity than odds, and so may be considered a more 'user-friendly' value with which to work. The two quantities are related thus:

$$\frac{\text{pre-test probability}}{1 - (\text{pre-test probability})} = \text{pre-test odds},$$

and

$$\frac{\text{post-test odds}}{(\text{post-test odds}) + 1} = \text{post-test probability}.$$

For example, using the data in *Table 17.13a*:

$$\begin{aligned}
 \text{pre-test probability (i.e., prevalence)} &= 0.03, LR+ = 124. \\
 \text{Therefore, pre-test odds} &= 0.03/(1 - 0.03) = 0.030\,93, \\
 \text{post-test odds} &= 0.030\,93 \times 124 = 3.84, \\
 \text{and post-test probability} &= 3.84/(3.84 + 1) = 0.793 \text{ (i.e.,} \\
 &\text{the positive predictive value)}.
 \end{aligned}$$

These calculations can be obviated by using a nomogram<sup>4</sup> (*Figure 17.3*). For example, if the pre-test probability is 0.30 (30%), and the  $LR+$  is 20, a ruler is placed through the 0.30 point on the left-hand vertical line and through the value 20 on the middle line. A post-test probability of 0.90 (90%) is then identified on the right-hand line.

### Likelihood ratios in clinical practice

A major advantage of likelihood ratios over sensitivity and specificity is that they can be computed for different **ranges** of values of continuous or ordinal test

<sup>4</sup> A nomogram is a graphical representation of the relationship between more than two quantities.

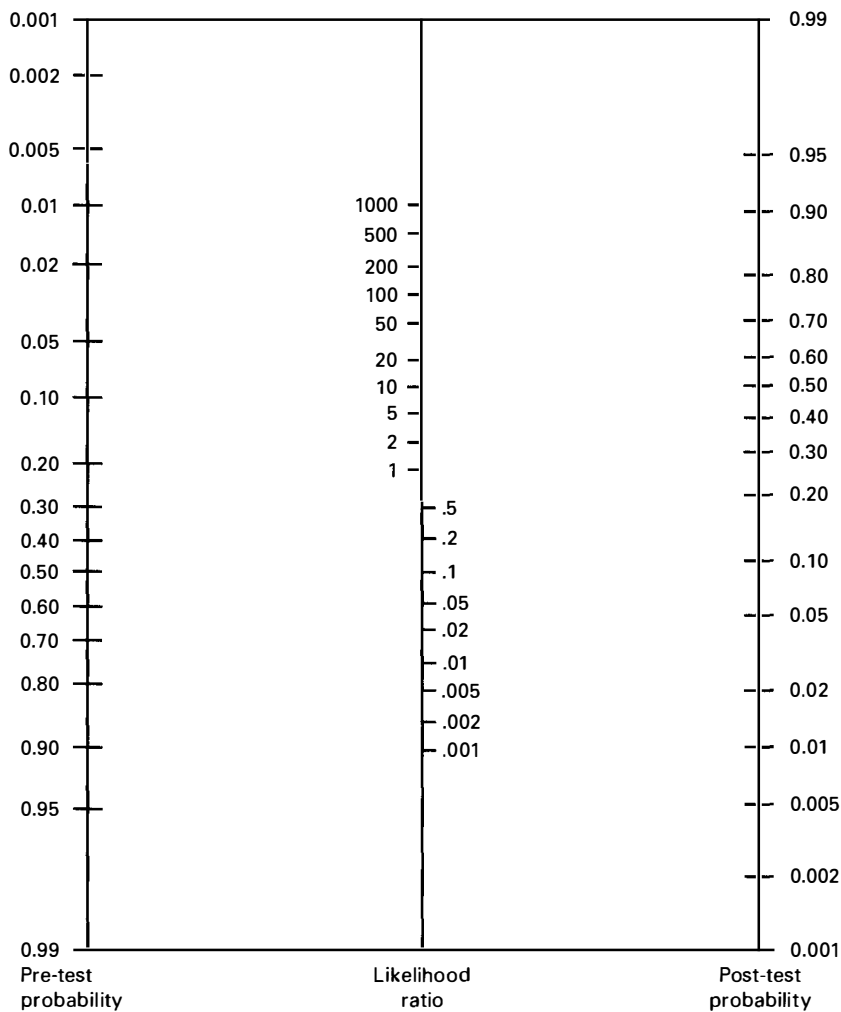

**Fig. 17.3** Nomogram depicting the relationship between pre-test probability of disease, likelihood ratios, and post-test probability of disease. (Modified from Fagan, 1975.)

**Table 17.14** Likelihood ratios of a positive test result (LR+) for hip dysplasia in dogs, using a dorsolateral subluxation score (DLS). (Data from Lust *et al.*, 2001.)

DLS	Hip dysplasia present	Hip dysplasia absent	LR+ for different cut-offs		LR+ for different ranges	
			DLS cut-off	LR+	DLS range	LR+
<45	14	6	<45	8.0	<45	8.0
45–55	6	8	≤55	4.9	45–55	2.6
>55	4	68			>55	0.2
Totals	24	82				

variables. This is of particular benefit in assisting diagnosis in the individual patient in the veterinary clinic<sup>5</sup>.

Table 17.14 lists likelihood ratios of a positive test result for hip dysplasia in dogs. The diagnostic test involves radiographing dogs' hips and recording a dorsolateral subluxation score (DLS), based on the

percentage of overlap between the femoral head and the acetabulum. A *low* score is more likely in affected dogs. The presence of dysplasia is confirmed at post-mortem examination.

The likelihood ratios are computed for two cut-off values (<45 and >55). Thus, for the ≤55 cut-off, true-positive rate =  $(14 + 6)/24 = 0.8333$ ; false-positive rate =  $(6 + 8)/82 = 0.1707$ ;  $LR+ = 0.8333/0.1707 = 4.9$ . They are also computed for the three 'bands' of DLS scores. Thus, for the 45–55 band, true-positive rate =  $6/24 = 0.2500$ ;

<sup>5</sup> Variables used in the clinical environment may involve composite measurement scales (see Chapter 9), including, for example, aggregates of clinical signs and history (Cockroft, 2002).

false-positive rate =  $8/82 = 0.0976$ ;  $LR+ = 0.2500/0.0976 = 2.6$ . The use of a single cut-off value of  $\leq 55$  ( $LR+ = 4.9$ ) does not describe the performance of the test over the full spectrum of results, which clearly varies ( $<45$ :  $LR+ = 8.0$ ;  $45-55$ :  $LR+ = 2.6$ ). Similarly, selection of  $<45$  as the cut-off point (with affected animals with values  $\geq 45$  therefore being classified as healthy) disregards the strength of the positive result in the  $45-55$  band ( $LR+ = 2.6$ ).

The values of likelihood ratios, over the full range of test results, can assist the clinician in deciding on a diagnosis. First, an indication of the pre-test probability of disease is required. This is quite different from the value obtained when a diagnostic test is applied to screen the general population, where most animals are assumed to be healthy (exemplified in *Table 17.13*), and where this probability is simply the prevalence of disease in the population. Animals presented at a veterinary clinic are a highly restricted sector of the population with clinical histories and signs that have driven the owners to present them for examination. The pre-test probability, in this circumstance, is the probability that they have a given condition, and is usually based on the judgement of the clinician. If the latter considers that the animal is just as likely to have the condition as not to be affected, then the pre-test probability is 0.5 (50%). Thus, if hip dysplasia is the putative condition, and the animal has a DLS between 45 and 55, then the  $LR+$  is 2.6 and the post-test probability, read from the nomogram, is approximately 0.75 (75%). In contrast, if the animal's DLS score is  $<45$ , the  $LR+$  is 8.0 and the post-test probability increases to approximately 0.90 (90%). (The exact values can be calculated using the formula, above, for converting probability to odds, and vice versa.)

Thus, knowledge of the likelihood ratios for the full range of intervals for ordinal or continuous test variables, coupled with measurement of the variable's value in a specific patient, is a powerful aid in narrowing down the diagnostic options in that patient.

## ROC curves

The  $LR+$  for various cut-off values for continuous or ordinal test variables can be presented graphically by drawing a **receiver-operating characteristic (ROC) curve** (*Figure 17.4*)<sup>6</sup>. This depicts the relationship between pairs of true positive rates (sensitivity), on the vertical axis, and false-positive rates ( $1 - \text{specificity}$ ), on the horizontal axis, for a range of cut-off values. The perfect test, which discriminates perfectly between

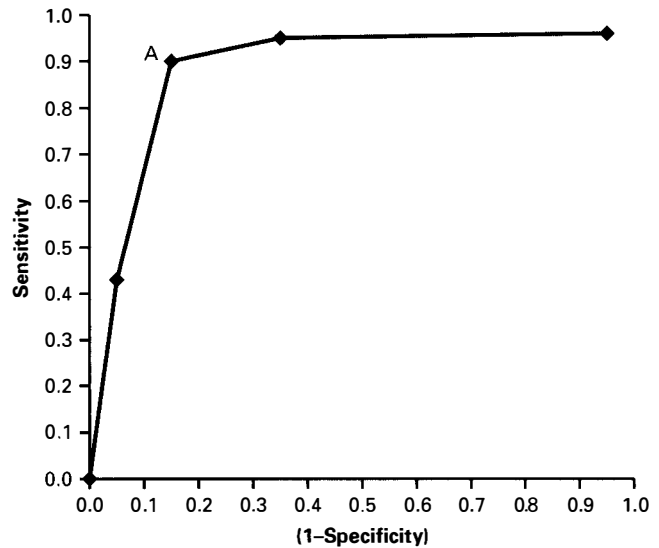

**Fig. 17.4** A ROC curve of an enzyme-linked immunosorbent assay for *Neospora caninum*. (Data from *Table 17.16*.)

diseased and healthy animals, would generate a 'curve' that coincided with the left side and top of the plot. A nugatory test, in contrast, would produce a straight-line plot, from bottom left to top right. Thus, tests with the ROC curves furthest into the top left-hand corner are the better tests. The 'best' cut-off for a given test – in terms of minimizing the proportions of animals that are misclassified (i.e., producing the largest value of  $(\text{sensitivity} + \text{specificity})/2$ ) – is the point on the ROC closest to the top left-hand corner. Moreover, when prevalence is 50%, this results in the minimum number of animals that are misclassified.

The ROC curve depicted in *Figure 17.4* is plotted from the results of an ELISA for *Neospora caninum*, a major infectious cause of bovine abortion in many countries (*Table 17.15*). The ELISA values are expressed as '% positivity' (PP)<sup>7</sup>, and five cut-off values have been tabulated. Thus, classifying animals with a  $PP > 20\%$  as affected:

$$\text{sensitivity} = (4 + 5 + 98)/114 = 0.9386,$$

$$\text{specificity} = (170 + 18 + 2)/199 = 0.9548;$$

and so on, for the other cut-off values.

Likelihood ratios can now be computed for each cut-off. Thus at the  $>20\%$  PP point:

$$\begin{aligned} LR+ &= \text{sensitivity}/(1 - \text{specificity}) \\ &= 0.9386/(1 - 0.9548) \\ &= 21, \end{aligned}$$

and:

<sup>6</sup> ROC curves were developed in the 1950s to assess the detection of radar signals, and became established in medicine in the early 1980s (Hanley and McNeill, 1982).

<sup>7</sup> In common with other ELISA tests, the test for *N. caninum* generates an ELISA value by comparison with positive reference serum; this can lead to PP values in excess of 100%.



**Table 17.15** Estimates of sensitivity and specificity, and likelihood ratios, for different bands of percentage positivity values for an ELISA for *Neospora caninum* infection in dairy cattle. (Study reported in Davison *et al.* (1999); raw data supplied by Helen Davison, Veterinary Laboratories Agency, New Haw, UK.)

% positivity	Known positives	Known negatives	Cut-off	Sensitivity	Specificity	LR+	LR-
0–10	0	170	–	–	–	–	–
>10–15	3	18	>10	1.000	0.8543	6.9	0.00
>15–20	4	2	>15	0.9737	0.9447	18	0.03
>20–25	4	3	>20	0.9386	0.9548	21	0.06
>25–30	5	0	>25	0.9035	0.9648	30	0.10
>30–107	98	6	>30	0.8596	0.9648	29.9	0.15
Totals	114	199					

LR+ = likelihood ratio of a positive test result.

LR- = likelihood ratio of a negative test result.

**Table 17.16** Calculation of the area under the ROC curve. (Data from Table 17.15.)

% positivity	Number of times known-positive values > known-negative values	Total scores: number known-positive values > known negative values (A)	Number of ties	Total scores: ties (number of ties × 0.5): (B)	Total score (A + B)
0–10	0 × 170	–	0	–	–
>10–15	3 × 170	510	3 × 18	27	537
>15–20	(4 × 170) + (4 × 18)	752	4 × 2	4	756
>20–25	(4 × 170) + (4 × 18) + (4 × 2)	760	4 × 3	6	766
>25–30	(5 × 170) + (5 × 18) + (5 × 2) + (5 × 3)	965	0	–	965
>30–107	(98 × 170) + (98 × 18) + (98 × 2) + (98 × 3)	18 914	98 × 6	294	19 208
Total	21 901			331	22 232

$$LR- = (1 - \text{sensitivity}) / \text{specificity} \\ = (1 - 0.9386) / 0.9548 \\ = 0.06;$$

and so on, for other cut-off values.

The curve is close to the top left-hand corner, suggesting that the test is a good one. Moreover, the PP cut-off point that maximizes sensitivity and specificity is >15 ( $(\text{sensitivity} + \text{specificity}) / 2 = 0.9592$  – the largest value obtainable from Table 17.15).

Altman *et al.* (2000) describe computation of confidence intervals for the ROC curve.

### Area under the curve

**The area under the curve (AUC)** – also termed **diagnostic accuracy** – is a global assessment of a test's performance. This area equals the probability that a random individual with disease has a higher value of the test variable than a random healthy individual (if the variable is raised in sick individuals). A perfect test thus yields an AUC of 1, whereas an uninformative test gives a value of 0.5.

Calculation of the AUC is related to the Mann-Whitney statistic (see Chapter 14), and is based on every comparison of individuals in the known-positive and known-negative groups. A score is attached to each comparison pair: the value, one, is

awarded when the known-positive value is greater than the known negative value; 0.5 is scored when the two values are equal ('ties'); and zero is allotted when the known-positive value is less than the known-negative value. The scores are then summed, and divided by the number of comparisons.

This calculation is exemplified in Table 17.16, using the data in Table 17.15. Thus, in the >10–15 PP class, three known-positive animals have values greater than 170 known-negative animals (those with PP values 0–10), and so there are 3 × 170 such comparisons, each with a score of one, resulting in a total score value of 510. Additionally, in this class, there are three known-positive animals and 18 known negatives, constituting 3 × 18 ties, each with a score value of 0.5, that is, a sum of (3 × 18) × 0.5 = 27. Thus, the total score attributed to this class is 510 + 27 = 537, and so on for the other classes. (Score values of zero need not be tabulated because they do not contribute to the score total.) The final score total is therefore 22 232, and there are 22 686 comparisons (114 known positive animals multiplied by 199 known negative animals). The AUC is thus 22 332 / 22 686 = 0.984. This value is high (the perfect test having a value of one), again providing evidence that the ELISA test is a good one.

Confidence intervals can be calculated for the AUC (Altman *et al.*, 2000).

Greiner *et al.* (2000) present a fuller discussion of ROC curves.

### Aggregate-level testing

Tests may also be applied to **aggregates of animals** (e.g., pens and herds) with the object of classifying the aggregate, rather than its individual members, as either diseased or healthy. If there is one biological sample (e.g., a bulk milk sample or a pooled faeces sample) from each aggregate, the formulae for sensitivity, specificity and predictive value, described above, may be applied. Assessment of the aggregate's status is also uncomplicated if the true status of test-positive animals can be ascertained quickly using a gold standard. However, if only a **sample** of animals is tested in each aggregate, sensitivity and specificity at the aggregate level are affected not only by the sensitivity and specificity at the individual level but also by the sample size. The overall effect is that, for a defined sensitivity and specificity at the individual level, aggregate-level sensitivity increases and aggregate-level specificity decreases as the sample size increases.

**Aggregate sensitivity**,  $Se_{agg}$  (the proportion of affected herds that test positive), depends on individual-animal sensitivity, specificity and prevalence, and the number of animals sampled:

$$Se_{agg} = 1 - (1 - P^T)^n$$

where:

- $P^T$  = test prevalence;
- $n$  = number of animals sampled.

For example, if the true prevalence,  $P$ , is 0.25 in each of several herds, sensitivity = 0.97, specificity = 0.98, and four animals are selected from each herd, then:

$$\begin{aligned} P^T &= \{P \times \text{sensitivity}\} + \{(1 - P) \times (1 - \text{specificity})\} \\ &= \{0.25 \times 0.97\} + \{(1 - 0.25) \times (1 - 0.98)\} \\ &= 0.2575. \end{aligned}$$

Thus:

$$\begin{aligned} Se_{agg} &= 1 - (1 - 0.2575)^4 \\ &= 1 - 0.7425^4 \\ &= 1 - 0.3039 \\ &= 0.70. \end{aligned}$$

That is, 70% of all affected herds have one or more test-positive animals in the sample of four animals that are tested in each herd; alternatively, 30% of affected herds will not be detected.

**Aggregate specificity**,  $Sp_{agg}$  (the proportion of unaffected herds that test negative), depends on individual-animal specificity and the number of animals sampled:

$$Sp_{agg} = (\text{specificity})^n$$

For example, if a test of specificity 0.98 is applied to samples of four animals from several herds, then:

$$\begin{aligned} Sp_{agg} &= 0.98^4 \\ &= 0.92. \end{aligned}$$

Therefore, 92% of all unaffected herds will have no test-positive animals in the samples of four animals that are tested in each herd; alternatively, 8% of disease-free herds will be scored as affected.

Note that the formula for  $Se_{agg}$  and  $Sp_{agg}$  above, should only be applied when the sampling fraction in each aggregate is less than approximately 5%.

Martin (1988) and Jordan and McEwen (1998) discuss this topic in detail.

### Multiple testing

Multiple testing involves the use of more than one test, and is commonly encountered in clinical diagnosis and herd testing. Two main approaches can be adopted (Fletcher *et al.*, 1982): **parallel testing** and **serial testing**;

#### Parallel testing

Parallel testing involves conducting two or more tests on animals at the same time, and animals are considered to be affected if they are positive to *any* of the tests. For example, during brucellosis eradication in the UK, cows that aborted were tested routinely for brucellosis by means of bacterial culture from a vaginal swab, the Rose Bengal Test on serum and the milk ring test on milk, and animals were defined as affected if they were positive to any test. Parallel testing is often undertaken when animals are admitted to clinics, and an assessment is required quickly. In comparison with each individual test, parallel testing increases sensitivity and therefore the predictive value of a negative test result, but reduces specificity and positive predictive value. A disease is therefore less likely to be missed; however, false positive diagnoses are more likely. Parallel testing effectively asks the animal to 'prove' that it is healthy.

The sensitivity of two tests, A and B, applied in parallel, is calculated thus:

$$1 - [(1 - Se_A) \times (1 - Se_B)]$$

where  $Se_A$  = sensitivity of test A;  
and  $Se_B$  = sensitivity of test B.

The parallel specificity is derived thus:

$$Sp_A \times Sp_B$$

where  $Sp_A$  = specificity of test A;  
and  $Sp_B$  = specificity of test B.

**Table 17.17** The effect of parallel and serial testing on sensitivity, specificity and predictive value for two tests (A and B). (Modified from Fletcher *et al.*, 1988.)

Test	Sensitivity (%)	Specificity (%)	Predictive value (positive result)(%)*	Predictive value (negative result)(%)*
A	80	60	33	92
B	90	90	69	97
A and B (parallel)	98	54	35	99
A and B (serial)	72	96	82	93

\* For 20% prevalence.

The derivation of parallel values may be better understood by a numerical example. Consider two tests, A and B (Table 17.17), applied to a population in which disease prevalence is 0.20 (20%).

Test A detects 80%, leaving 20% undetected (i.e., sensitivity = 0.80).

Test B detects 90% of the remaining 20% = 18% (i.e., sensitivity = 0.90).

Therefore, *parallel* sensitivity (proportion positive to either test) = 80% + 18%  
= 98%.

Applying the appropriate formula:

$$\begin{aligned} \text{parallel sensitivity} &= 1 - [(1 - Se_A) \times (1 - Se_B)] \\ &= 1 - [(1 - 0.80) \times (1 - 0.90)] \\ &= 1 - (0.20 \times 0.10) \\ &= 0.98 (98\%) \end{aligned}$$

Test A categorizes 60% of true negatives as negative (i.e., specificity = 0.60).

Test B categorizes only 90% of these as negative (i.e., specificity = 0.90).

Therefore, *parallel* specificity (proportion negative to both tests) = 90% × 60%  
= 54%.

Applying the appropriate formula:

$$\begin{aligned} \text{parallel specificity} &= Sp_A \times Sp_B \\ &= 0.90 \times 0.60 \\ &= 0.54 (54\%) \end{aligned}$$

These parallel values can now be used to complete a contingency table, and compute predictive values (Table 17.18).

$$\begin{aligned} \text{Positive predictive value} &= 19.6/56.4 \\ &= 35\% \end{aligned}$$

$$\begin{aligned} \text{Negative predictive value} &= 43.2/43.6 \\ &= 99\% \end{aligned}$$

### Serial testing

In serial testing, tests are conducted **sequentially** (i.e., consecutively), based on the results of a previous test.

**Table 17.18** Relationships (test status and true status) under parallel testing, derived from Table 17.17.

	True+ (%)	True- (%)	Totals (%)
Test+ (either) (%)	19.6	36.8	56.4
Test- (both) (%)	0.4	43.2	43.6
Totals (%)	20	80	100

Conventionally, only those animals that are **positive** to an initial test are tested again; therefore only animals that are positive to **all** tests are considered to be affected. Thus, *Serpulina hyodysenteriae* infection (see Chapter 5) is initially diagnosed by a fluorescent antibody test performed on faecal or gut mucosal smears; the status of positive animals is then confirmed by bacterial culture. Serial testing maximizes specificity and the predictive value of a positive test result, but lowers sensitivity and negative predictive value. More credence therefore can be attached to positive test results, but there is an increased risk that disease will be missed. Serial testing effectively asks the animal to 'prove' that it is affected by the condition that is being investigated. The test with the highest specificity should be used first to decrease the number of animals that are tested again.

The sensitivity and specificity of two tests, A and B, applied in series, are calculated thus:

$$\begin{aligned} \text{Sensitivity} &= Se_A \times Se_B \\ \text{Specificity} &= 1 - [(1 - Sp_A) \times (1 - Sp_B)] \end{aligned}$$

using the same notation as above.

Employing the values in Table 17.17:

$$\begin{aligned} \text{Test A detects} &= 80\% \\ \text{Test B defines} &= 90\% \text{ of these as positive.} \end{aligned}$$

Therefore, *serial* sensitivity (proportion positive to both tests) = 80% × 90%  
= 72%;

that is,  $Se_A \times Se_B = 0.80 \times 0.90 = 0.72$  (72%).

Test A correctly categorizes 60% of true negatives, leaving 40%.

Test B categorizes 90% of these as negative = 90% × 40% = 36%.

**Table 17.19** Relationships (test status and true status) under serial testing, derived from Table 17.17.

	True+ (%)	True- (%)	Totals (%)
Test + (both) (%)	14.4	3.2	17.6
Test - (either) (%)	5.6	76.8	82.4
Totals (%)	30	80	100

Therefore, serial specificity (proportion negative to either test) = 60% + 36%  
= 96%;

that is,  $1 - [(1 - Sp_A) \times (1 - Sp_B)] = 1 - [(1 - 0.60) \times (1 - 0.90)] = 1 - 0.40 \times 0.10 = 0.96$  (96%).

These serial values can again be used to complete a contingency table, and predictive values computed (Table 17.19).

$$\begin{aligned} \text{Positive predictive value} &= 14.4/17.6 \\ &= 82\%. \end{aligned}$$

$$\begin{aligned} \text{Negative predictive value} &= 76.8/82.4 \\ &= 93\%. \end{aligned}$$

Serial testing is an important part of disease eradication campaigns in which positive animals are culled from herds (see Chapter 22). Animals defined as diseased by an initial screening test<sup>8</sup> are subjected to further tests to confirm their status, so that false positives are not unnecessarily removed.

The formulae for calculating parallel and serial sensitivity and specificity assume that the tests are independent, that is, measure different manifestations of disease (e.g., antibodies or presence of microbes identified microscopically). If tests are not independent (e.g., two variations of an antibody-detection test), then the parallel and serial sensitivity can only be obtained empirically.

### Negative-herd retesting

Testing can also be conducted only on animals that are negative to an initial test. This is usually applied at herd level, and involves periodically retesting animals in previously test-negative herds with the same test.

Negative-herd retesting is an important component of eradication campaigns. It improves aggregate-level sensitivity; that is, it increases the likelihood of detecting on a premises an infectious agent that eluded detection earlier (e.g., because antibodies had not yet been produced, or the infection was subsequently reintroduced). It therefore asks a herd to 'prove' that it is free from the condition that is being investigated.

For instance, in tuberculosis eradication in the UK, using the comparative intradermal test, reactors are culled, and inconclusive reactors retested after 42–60 days, with usually up to two retests allowed. If visible lesions of tuberculosis are found at post-mortem examination, or laboratory testing of pooled lymph nodes gives a positive result, the whole herd is subjected to two 'short-interval' tests 60 days apart. If post-mortem examination fails to find lesions, and pooled lymph nodes yield negative results, only one 60-day test is required. If the short-interval tests are clear, movement restrictions are lifted, and a further test is carried out in 6 months; if still clear, a further check is conducted in another 12 months' time. If the latter whole-herd test is clear, the herd is returned to a less stringent 4-year testing cycle, or to a routine testing interval for the area<sup>9</sup>.

The important characteristics of multiple test strategies are listed in Table 17.20. Multiple testing is discussed in more detail by Smith (2005).

### Diagnostic tests in import risk assessment

Knowledge of a test's sensitivity and specificity enables predictions to be made about the risk of importing infected animals or products with various importation rules. The probability of missing an infected individual using a given diagnostic test is (1 – sensitivity); this probability would therefore be 0.05 if a test with a sensitivity of 0.95 (95%) were being applied. Recall, however, that the predictive value of a diagnostic test also depends on disease prevalence. The probability of an animal that is negative to a test being actually infected,  $p_n$ , is:

$$\frac{P(1 - Se)}{P(1 - Se) + (1 - P) \times Sp}$$

where  $P$  is the true prevalence,  $Se$  = sensitivity, and  $Sp$  = specificity (Marchevsky *et al.*, 1989).

If animals were being quarantined, exclusion of false positive animals is of little concern, and so specificity can be assumed to be 1. Table 17.21 lists the values of  $p_n$  for various values of  $P$  when a test with a sensitivity of 0.95 is used. The probability of any test-negative animal being infected increases when the prevalence in the source population increases.

Moreover, at a given prevalence, the probability of including even one test-negative infected animal in a group of imported animals,  $p_c$ , increases as the number of animals in the group increases ((Marchevsky *et al.*, 1989):

<sup>8</sup> Ideally, the first test should detect all cases.

<sup>9</sup> There are some parishes in England and Wales where disease levels are high enough to warrant a 2-year routine testing interval.

**Table 17.20** Characteristics of multiple test strategies. (Modified from Smith, 1995.)

Consideration	Test strategy		
	Parallel	Serial	Negative-herd retesting
Effect of strategy	Increase sensitivity	Increase specificity	Increase sensitivity at aggregate level
Greatest predictive value	Negative test result	Positive test result	Negative test result at aggregate level
Purpose	Rule out a disease	Rule in a disease	Rule out a disease
Application and setting	Rapid assessment of individual patients; emergencies	Diagnosis when time is not crucial; test and removal programmes	Test and removal programmes
Comments	Useful when there is an important penalty for missing a disease (i.e., false negative results)	Useful when there is an important penalty for false positive results	Useful when there is an important penalty for missing a disease (i.e., false negative results)

**Table 17.21** The probability that a test-negative animal is actually infected, when sensitivity = 0.95 and specificity = 1. (From MacDiarmid, 1991.)

Prevalence	Probability ( $P_n$ )
0.01	$5.05 \times 10^{-4}$
0.05	$2.63 \times 10^{-3}$
0.10	$5.52 \times 10^{-3}$
0.20	$1.23 \times 10^{-2}$

**Table 17.22** The probability that a test-negative, infected animal will be included in a group destined for import when only reactor animals are excluded (prevalence = 0.01, sensitivity = 0.95 and specificity = 1). (From MacDiarmid, 1991.)

Group size	Probability ( $P_c$ )
10	$5.04 \times 10^{-3}$
20	$1.00 \times 10^{-2}$
30	$1.50 \times 10^{-2}$
50	$2.49 \times 10^{-2}$
100	$4.92 \times 10^{-2}$
500	$2.23 \times 10^{-1}$

$$p_c = 1 - \left\{ \frac{(1 - P) \times Sp}{(1 - P) \times Sp + P(1 - Se)} \right\}^n$$

where  $n$  is the group size.

If a policy dictates that a positive test result only disqualifies the *individual* animal that reacts positively, then the risks associated with such a policy are  $p_n$  (Table 17.21) and  $P_c$  (Table 17.22). Alternatively, it may be decided that a positive test result in any one animal will disqualify the entire group (e.g., tests for OIE List A diseases: see Chapter 11), in which circumstance the probability of disqualifying an infected *group* increases as the prevalence and/or group size increases. The probability of a test failing to detect at least one test-

**Table 17.23** The probability that a test-negative, infected animal will be included in a group destined for import (prevalence = 0.01, sensitivity = 0.95 and specificity = 1; entire group tested.) (Modified from OIE Scientific and Technical Review, 12(4), December 1993.)

Group size	Probability (if reactor animal <b>only</b> excluded) ( $P_c$ )	Probability (if a single reactor <b>disqualifies</b> <b>group</b> ): probability of no test-positives ( $\beta$ )
100	$4.92 \times 10^{-2}$	$5.00 \times 10^{-2}$
200	$9.61 \times 10^{-2}$	$2.50 \times 10^{-3}$
300	$1.41 \times 10^{-1}$	$1.25 \times 10^{-4}$
400	$1.83 \times 10^{-1}$	$6.25 \times 10^{-6}$
500	$2.23 \times 10^{-1}$	$3.13 \times 10^{-7}$

positive animal in an infected group,  $\beta$ , thus identifying the group as infected, can be calculated (MacDiarmid, 1987):

$$\beta = \{1 - (t \times Se) / n\}^{pn}$$

where  $t$  = the number of animals that are tested in the group,  $n$  = group size,  $p$  = group prevalence.

Thus, the difference in risk between these two policies can be compared (Table 17.23). The risk of an infected animal being imported is considerably reduced when a single reactor disqualifies the entire group, rather than only the test-positive individual.

Jones *et al.* (2004b) develop this approach for serial testing strategies in the context of the risk of importing brucellosis-infected cattle from Ireland into the UK, where surveillance for infection in the exporting countries involves an initial screening test using either the serum-agglutination test (Northern Ireland) or the micro-agglutination test (Republic of Ireland), followed by confirmation of test-positives by the complement-fixation test.

Import risk assessment is addressed comprehensively by Murray (2002) and OIE (2004).

**Table 17.24** Guidelines for validation of diagnostic tests. (Modified from *Preventive Veterinary Medicine*, 45, Greiner, M. and Gardner, I.D. Epidemiologic issues in the validation of veterinary diagnostic tests, 3–22. © (2000), with permission from Elsevier.)

#### General

- The test purpose and the analytical unit are described
- The test protocol is sufficiently described

#### Reference test (gold standard)

- The choice of the reference method is justified (a necessary condition is that it should be more accurate than the test that is being evaluated); and the method is fully described or referenced

#### Selection of reference populations

- The reference population is sufficiently described (time, location, and animal characteristics such as breed, age and gender)
- The reference population should reflect the target population (see Chapter 13) and include an appropriate spectrum of disease and spectrum of other conditions
- The sampling frame should be an unbiased representation of the reference population (see Chapter 13)
- Selection criteria must be stated and should reflect the testing situation

#### Sampling of the reference population

- The sampling procedure is described in detail
- Exclusion or inclusion criteria (if any) are described (see Chapter 16)
- Sample sizes must be stated and should reflect the degree of the required statistical precision
- Random and systematic sampling are the preferred option (see Chapter 13)

#### Performance of test and reference test

- The testing protocols are sufficiently described (including definition of negative and positive results)
- Results of test and reference test are evaluated independently (blinded) (see Chapter 16)

#### Presentation of results

- Methods of estimating parameters are explained by formulae; estimates are presented together with sample sizes and confidence intervals (exact confidence intervals are preferred to approximate); sensitivity and specificity are always required, additional parameters may be presented as necessary; the  $2 \times 2$  table used in generating estimates should be displayed
- ROC analysis should be presented for test outcomes measured on ordinal or continuous scales
- The number of intermediate results and results that cannot be interpreted (if any) and reasons for missing data are given

#### Discussion of results

- The test-performance parameters should be discussed in relation to the study design and the intended or current use of the test; if the gold standard is imperfect, this should be discussed in relation to the effect on the study results

## Guidelines for validating diagnostic tests

The components of a comprehensive protocol for validating a diagnostic test are summarized in *Table 17.24*. Some authorities recommend that at least 300 true positives and 1000 true negatives are used to determine sensitivity and specificity, respectively (Jacobson, 2000). Such values will dictate the precision with which the two parameters are estimated. The precision can be varied and predetermined by using the appropriate formula for estimation of sample size for a simple proportion (see Chapter 13: 'Estimation of disease prevalence: simple random sampling'). A review of sample size determination for various diagnostic test parameters is presented by Obuchowski (1998).

## Agreement between tests

### The kappa statistic

If a gold standard is not available, it may not be possible to assess easily a test's validity (i.e., sensitivity

and specificity)<sup>10</sup>, in which circumstance **agreement** between different tests may be assessed, without assuming that one test is the best<sup>11</sup>. The logic of using this approach, argued by some authorities, is that agreement between tests is evidence of validity, whereas disagreement suggests that the tests are untrustworthy (although it is possible that tests could agree by being consistently wrong).

*Table 17.25* presents the results of an examination of pigs' heads to identify atrophic rhinitis using two techniques: cross-sectional and longitudinal examination.

The observed proportion agreement between the two tests,  $OP = (a + d)/n$ , where  $n = (a + b + c + d)$ . Substituting the values in *Table 17.25*:

$$OP = (8 + 223)/248 \\ = 0.932.$$

<sup>10</sup> Some complex methods have been developed to assess validity when only an imperfect reference test is available (Hui and Zhou, 1998; Enøe *et al.*, 2000; Pouillot and Gerbier, 2001; Pouillot *et al.*, 2002; Frössling *et al.*, 2003), and are facilitated by appropriate software (AFSSA, 2000).

<sup>11</sup> The proportion of all test results on which two or more different tests agree is sometimes termed **concordance** (Smith, 2005).

**Table 17.25** Number of pigs' heads showing turbinate atrophy by cross-sectional and longitudinal examination of 248 heads. (Data derived from Visser *et al.*, 1988.)

Longitudinal examination	Cross-sectional examination	
	Atrophy present	Atrophy absent
Atrophy present	8 (a)	1 (b)
Atrophy absent	16 (c)	223 (d)

This comparison, however, does not consider the agreement between the two tests that could arise just by *chance*. A more rigorous comparison can be made by calculating a statistic, *kappa* (see Table 14.2), which takes account of chance agreement. First, the expected proportion of agreement by chance, *EP*, is calculated. This is simply the sum of the expected proportion of agreement for the positive and negative results.

Expected proportion agreement by chance (both positive),  $EP+ = \{(a+b)/n\} \times \{(a+c)/n\}$   
 $= \{(8+1)/248\} \times \{(8+16)/248\}$   
 $= 0.0363 \times 0.0968$   
 $= 0.00351$ .

Expected proportion agreement by chance (both negative),  $EP- = \{(c+d)/n\} \times \{(b+d)/n\}$   
 $= \{(16+223)/248\} \times \{(1+223)/248\}$   
 $= 0.964 \times 0.903$   
 $= 0.87049$ .

Thus:

$$EP = (EP+) + (EP-)$$

$$= 0.00351 + 0.87049$$

$$= 0.874$$

Observed agreement beyond chance, *OA*  
 $= OP - EP$   
 $= 0.932 - 0.874 = 0.058$ .

Maximum possible agreement beyond chance, *MA*  
 $= 1 - EP$   
 $= 1 - 0.874$   
 $= 0.126$ .

*Kappa* is the ratio of the observed agreement beyond chance to the maximum possible agreement beyond chance, that is:

$$kappa = OA/MA$$

$$= 0.058/0.126$$

$$= 0.46$$

*Kappa* ranges from 1 (complete agreement beyond chance) to 0 (agreement is equal to that expected by chance), whereas negative values indicate agreement less than is expected by chance. Arbitrary 'benchmarks' for evaluating observed *kappa* values have been recommended. Fleiss *et al.* (2003) suggest  $\geq 0.75$  indic-

ates excellent agreement, whereas  $\leq 0.40$  indicates poor agreement. Everitt (1989) suggests  $>0.81$ : almost perfect agreement; 0.61–0.80: substantial agreement; 0.41–0.60: moderate agreement; 0.21–0.40: fair agreement; 0–0.20: slight agreement; 0: poor agreement. Altman (1991a) suggests  $>0.80$ : very good agreement; 0.61–0.80: good agreement; 0.41–0.60: moderate agreement; 0.21–0.40: fair agreement; and  $\leq 0.2$ : poor agreement. Thus, the point estimate of *kappa*, 0.46, suggests moderate agreement between the two methods of examination of pigs' heads.

The same approach can be used to assess clinical agreement; *kappa* values between 0.5 and 0.6 being expected when comparing the results of a diagnosis made on the same animals by different clinicians.

Confidence intervals can be calculated for the observed proportion of agreement (Samsa, 1996) and for *kappa* (Everitt, 1989), in which circumstance the lower confidence limit should lie above 0.40 before at least moderate agreement can be inferred (Basu and Basu, 1995). Sim and Wright (2005) discuss sample size.

The *kappa* statistic can also be generalized to studies involving dichotomous nominal data with several ratings of subjects, to nominal data with several categories (Fleiss *et al.*, 2003), and to ordinal data (Cicchetti and Allison, 1971). However, it is not suitable for assessing agreement between tests based on continuous data, where other techniques are more appropriate (Bland and Altman, 1986; Maclure and Willett, 1987; Bland, 2000). *Kappa* may also be defined differently in the contexts of agreement and correlation (Bloch and Kraemer, 1989). Note, too, that the correlation coefficient (see Chapter 14) is *not* a valid indicator of agreement between two tests or measurement methods (Bland and Altman, 1986). Perfect correlation will exist between two methods if the points lie along any straight line; whereas perfect agreement is obtainable only if the points lie along the line of equality.

*Kappa* values need to be interpreted with caution. For instance, a low *kappa* value could indicate that only one test is good, or that both tests are bad, or that both tests are good but negatively correlated (which can occur with some antigen and antibody tests). Moreover, its value depends on the prevalence of the attribute of concern (Sargeant and Martin, 1998). Byrt *et al.* (1993) and Lantz and Nebenzahl (1996) discuss the bias that can occur in calculating *kappa*, and methods for correcting it.

## Reliability

The value of a diagnostic test is also judged by its **reliability** (see Figure 9.6), that is, the extent to which its results are *stable*. This can be explored by running the test two or more times on the same samples in the same laboratory under the same conditions, and assessing

the *repeatability* of the results (see Chapter 9). Tests that are used in several laboratories (e.g., those that are recognized as international standards) also require their *reproducibility* (see Chapter 9) to be determined.

The statistical procedures for assessing repeatability and reproducibility are based on agreement between results. Thus, calculation of a *kappa* is appropriate for nominal and ordinal data. An individual clinician's diagnoses made on the same animals on different occasions, for example, are likely to produce *kappa* values between 0.6 and 0.8. Again, appropriate methods must be sought for continuous data (Bland, 2000).

**Serological tests** The repeatability of serological tests depends on a variety of factors including the degree of standardization of test reagents and the expertise of the tester; similarly, reproducibility might be affected when the same serum sample is analysed by different laboratory technicians in different laboratories. Thus, a twofold difference in antibody titre between samples from the same animal, taken at different times, may reflect either a true change in titre or similar titres associated with low repeatability or reproducibility.

Generally, a geometric fourfold change in antibody titre (e.g., from 1/16 to 1/64) is assumed to reflect a real change; a twofold change is not considered to be significant. Table 17.26 illustrates the reasoning behind this decision. The table shows typical results when sera from 100 individuals are tested twice. Each of the two readings should be identical for a single serum sample. However, the table shows that this is true only for 62

samples. Of the remaining 38 samples, 34 show a twofold shift and four show a fourfold shift. The shift is caused by the value of the test's repeatability not being 100%. Note also that the fourfold shift in titres occurs with high dilutions. If these titres are typical of the test, then, when future samples are drawn from the study population, 4% of the animals might be expected to show a fourfold shift in titre, which does not represent a true change. Since this shift can be caused by the second sample showing either a higher or a lower titre than the first, then, when evidence of a rising titre is required from two samples taken from the same animal at different times, 2% of the animals can be expected to show spurious fourfold increases in titre. This degree of error is generally acceptable.

### Practical application of diagnostic tests

Diagnostic tests are applied to specific populations of animals (notably, herds and flocks) in the context of specific diseases. Thus, the characteristics of each disease should be known before either a testing strategy is developed or the results can be meaningfully interpreted. For example, lifelong infection with *Neospora caninum* is associated with bouts of waxing and waning antibody titres (Dannat, 1997). Therefore, infected animals may test positive on one occasion, and negative on another. Consequently, it may be necessary to test an animal more than once to determine its infection status. Similarly, antibodies are produced late in infection with paratuberculosis (Johne's disease), therefore limiting the value of screening tests at quarantine.

Table 17.27 lists some diseases, the circumstances in which they may be investigated, and appropriate testing strategies. It serves to emphasize that a thorough knowledge of the relevant diseases is required before tests can be applied and interpreted with confidence.

**Table 17.26** Typical titres of sera from 100 individuals tested twice. (From Paul and White, 1973.)

First reading (reciprocal titre)	Second reading (reciprocal titre)	Frequency
<8	<8	24
<8	8	2
8	16	2
16	8	2
16	32	3
32	16	3
32	32	8
32	64	6
64	32	4
64	64	16
64	128	1
128	64	3
128	128	6
128	256	2
128	512	2
256	128	4
256	256	6
256	1024	2
512	256	2
512	512	2

### Further reading

Alonzo, T.A. and Pepe, M.S. (1999) Using a combination of reference tests to assess the accuracy of a new diagnostic test. *Statistics in Medicine*, **18**, 2987–3003

Bossuyt, P.M., Reitsma, J.B., Bruns, D.E., Gatsonis, C.A., Glasziou, P.P., Irwig, L.M., Moher, D., Rennie, D., de Vet, H.C.W. and Lijmer, J.G. (2003) The STARD statement for reporting studies of diagnostic accuracy: explanation and elaboration. *Clinical Chemistry*, **49**, 7–18

Gardner, I.A. and Greiner, M. (Eds) (2000) Validation and application of diagnostic tests used in veterinary epidemiologic studies. *Preventive Veterinary Medicine*, **45**, 1–162

Halkin, A., Reichman, J., Schwaber, M., Paltiel, O. and Brezis, M. (1998) Likelihood ratios: getting diagnostic testing into perspective. *QJM*, **91**, 247–258



**Table 17.27** Recommended testing strategies for various diseases of cattle under different circumstances. (Extracted from Caldwell *et al.*, 2001.)

Circumstances	Disease	Strategy
<b>Screening herds</b>	<i>Bovine virus diarrhoea</i>	Active infection identified by sampling a small group (5–10 animals); assuming that seroprevalence will be high if a persistently infected animal is present, providing (1) maternal immunity has waned (animals tested are older than 9 months) and (2) the group has been together for a lengthy period.
	<i>Paratuberculosis</i>	All the herd needs to be tested because <i>Mycobacterium johnei</i> infection spreads slowly. Moreover, ELISA test sensitivity is no more than 50%. Thus, the level of prevalence to be detected would need to be set very low (say, 0.01), and aggregate testing is unsuitable.
<b>Testing animals added to herds</b> The imperfect nature of diagnostic tests, and the possibility of carrier animals testing negative during some periods, means that quarantine and testing will never obviate the risk of introduction of infection. Ideally, therefore, animals should be purchased from herds where certified programmes, testing several animals, demonstrate absence of infection. If certified animals are not available, imported animals should be tested on arrival to quarantine, then again 3 weeks later. Testing added animals is generally not required if infection is endemic.	<i>Bovine virus diarrhoea</i>	Screen for antigen. If seroconversion occurs, retain the affected animal in quarantine for a further month, and vaccinate in-contact seronegative animals.
	<i>Bovine herpes virus 1</i>	Antibody-positive animals remain potentially infectious for life, and therefore should be excluded from 'clean' herds.
	Leptospira hardjo	Agglutination titres may have fallen below detectable levels; accordingly, an ELISA test is preferred. If the initial test titres are inconclusive, repeat the test in 1 month. Treat with antibiotics if there is residual doubt.
	<i>Paratuberculosis</i>	Low test sensitivity and slow spread suggest that animals under 2 years of age will test negative. Faecal culture is preferred, but can take up to 4 months to reach a negative result. Quarantine screening is therefore impracticable. Annual testing by ELISA and faecal culture offer the best prospects for detection.
	<i>Neosporosis</i>	Test heifers on entry to the herd, and at calving (infected animals are most likely to test positive at calving).
	<i>Salmonellosis</i>	Serology not routinely used. Culture faeces on three occasions, at 14-day intervals.
	<i>Tuberculosis</i>	Tuberculin testing should be undertaken if animals are obtained from areas in which the infection is known to be a problem. However, animals will not react up to 6 weeks after infection, and sometimes around parturition.
<i>Venereal Campylobacter infection</i>	Serological tests are of no value, and bacteriological culture has poor sensitivity. Accordingly, detection is difficult. If a bull is imported into the herd (e.g., as an emergency replacement), the prepuce should be irrigated with antibiotics.	
<b>Monitoring progress</b> If bulk milk can be screened for antibodies (e.g., bovine virus diarrhoea), conduct 3-monthly tests. Alternatively, monitor sentinel groups of seronegative animals. Animals showing specific clinical signs should be tested (e.g., animals with diarrhoea and weight loss, for <i>M. johnei</i> ).		

Jacobson, R. (1997) Principles of validation of diagnostic assays for infectious diseases. In: *Manual of Standards for Diagnostic Tests and Vaccines*, 3rd edn., pp. 8–15. Office International des Epizooties, Paris

Kraemer, H.C. (1992) *Evaluating Medical Tests*. Sage Publications, Newbury Park. (A comprehensive guide to test evaluation, particularly in a clinical setting)

Martin, S.W. and Bonnett, B. (1987) Clinical epidemiology. *Canadian Veterinary Journal*, **28**, 318–325. (A discussion of the application of diagnostic tests in clinical practice)

Meier, K.L. (2002) Reporting results from studies evaluating diagnostic tests. *Clinical Microbiology Newsletter*, **24**, 60–63

Paul, J.R. and White, C. (Eds) (1973) *Serological Epidemiology*. Academic Press, New York and London

Smith, R.D. and Slenning, B.D. (2000) Decision analysis: dealing with uncertainty in diagnostic testing. *Preventive Veterinary Medicine*, **45**, 139–162

Worthington, R.W. (1982) Serology as an aid to diagnosis: uses and abuses. *New Zealand Veterinary Journal*, **30**, 93–97

# 18

## Comparative epidemiology

Investigations of disease in one species of animal can provide valuable insights into the cause and pathogenesis of disease in another, and are an important part of **comparative medicine**. These investigations often use animals as biological models of diseases in man.

### Types of biological model

There are traditionally four types of biological model (Frenkel, 1969)<sup>1</sup>:

1. experimental (induced);
2. negative (non-reactive);
3. orphan;
4. spontaneous (natural).

### Experimental (induced) models

Many models are attempts to reproduce experimentally, in one species of animal, diseases, pathological conditions and impaired functions that occur in other species, notably man. For example, cigarette smoke has been administered via nasal catheters to donkeys to study the effects of long-term smoking on tracheo-bronchial mucociliary activity (Albert *et al.*, 1971), ovariectomized sheep have been used to study responses to new therapies for post-menopausal osteoporosis (Turner, 2002), and pharmacological models have been developed to improve extrapolation from animals to man (Travis, 1987)<sup>2</sup>. This approach is particularly meaningful when causal factors can be

manipulated easily, such as nutritional deficiencies and excesses, endocrine disorders, and some microbial diseases, for which there are guidelines for therapeutic trials (Reeve-Johnson, 1998; Zak and Sande, 1999). However, if pathogenesis depends on several factors, or the causal effect is 'weak', results may differ between animal species and man. For instance, teratogenic defects may depend on maternal susceptibility to virus infection or absorption of chemicals during a brief but critical period of pregnancy, and many animal species may need to be tested before a suitable model is found.

### Negative (non-reactive) models

A negative model represents the counterpart to an induced model, and can be useful in studying why disease does not occur. Thus, normal mink may be studied to discover why they are resistant to the pathogenic effects of the virus that causes disease in Aleutian mink. Such 'non-models' are relatively rare.

### Orphan models

Orphan models are diseases in animals which currently have no known natural analogue in man, but which may subsequently prove to be valuable in changing thinking on human disease. An historical example is Rous sarcoma virus of chickens (see Chapter 1), which revolutionized thinking on the cause of cancer.

### Spontaneous (natural) models

Spontaneous models utilize the natural occurrence of disease in animals in order to increase understanding of human diseases. For example, comparative radiological, histological and serological investigations of

<sup>1</sup> Recently, developments in genetic engineering and embryo manipulation have given rise to a fifth type: **gene-modified** disease models (Wilson, 1996).

<sup>2</sup> In veterinary medicine, circumstances are more complex, sometimes requiring extrapolation from laboratory animals to several different species of animal (Nebbia, 2001).

sheep with and without periodontitis have revealed features similar to those of rapidly destructive forms of human periodontal disease, suggesting that the disease in sheep may be a suitable model for similar diseases in man (Ismail *et al.*, 1989). Similarly, the genetic disease muscular dystrophy has been identified in mice as a suitable animal model for human Duchenne muscular dystrophy (Bulfield *et al.*, 1984; Wells and Wells, 2002); Spontaneous models may also be based on epidemiological investigations (notably, observational studies of diseases of companion animals) and constitute **comparative epidemiology**, which is the subject of this chapter.

### Spontaneous versus experimental models

Companion animal spontaneous disease models have several advantages over experimental models. First, companion animals share similar environments with man, rather than living in the 'protected' environment of the laboratory. Secondly, their diseases occur in natural circumstances, where interactions between a variety of causal factors may occur; experimental induction of disease may not accommodate such interactions. Thirdly, companion animals are phylogenetically more closely related to man than are the species commonly used in the laboratory (rats, mice, etc.<sup>3</sup>). Fourthly, companion animals are more likely than inbred laboratory animals to display the heterogeneity of response to some causal factors (e.g., toxic agents and carcinogens) that is characteristic of man (Calabrese, 1986). Finally, the ethical objection to animal experimentation cannot be levelled against studies of spontaneously occurring diseases.

The value of comparative epidemiological studies may be either the coincidental product of investigations directed mainly at improving the health of animals, or may stem directly from the use of animals as surrogates for man (Schwabe, 1984). Several areas of interest have developed, frequently using the surrogate approach.

### Cancer

A major field of comparative epidemiology has been the study of cancer. Cancers in dogs and cats are more akin to human cancers than laboratory-animal tumours. Additionally there are similarities in cancer size relative to patient size and cell kinetics; and the

<sup>3</sup> However, approximately 80% of the mouse genome is organized similarly to the human genome, which therefore still renders the mouse a valuable animal for genetic research; notably, for the location of DNA segments that influence human traits (Copeland *et al.*, 1993); alcoholism is an example (Grisel, 2000).

**Table 18.1** Crude estimated annual rates for all cancers in man, ox, horse, cat and dog, and lifespan-adjusted equivalents\* (data from the US). (Simplified from Dorn and Priester, 1987.)

Species	Estimated rate of malignancy/100 000/year	
	Crude	Lifespan-adjusted
Man	287.3**	287.3**
Ox	177.2	53.2
Horse	256.3	117.9
Cat	257.4	72.1
Dog	828.3	165.7

\* Method of adjustment outlined in Table 18.5.

\*\* All cancers except those of skin (other than melanoma).

Approximately 150 non-melanoma skin cancers/100 000 should be added to make comparison with other species more accurate.

weight and surface area of dogs are sufficient to allow extrapolation to man, with modest adjustment, in therapeutic trials (Gillette, 1982; Hahn *et al.*, 1994)<sup>4</sup>. Moreover, small animals live long enough to determine potential delayed effects of therapy (Withrow, 2001).

Established veterinary databases, especially the Veterinary Medical Database (VMDB: see Chapter 11) and the California Animal Neoplasm Registry, have provided much of the data used in comparative epidemiological studies, and the value of these databases to the studies was realized shortly after the databases were developed (Tjalma, 1968). The incidence of spontaneous tumours (notably cancers) is sufficiently high – particularly in the dog – to compile a large series of cases for study (Gobar *et al.*, 1998; Vail and MacEwen, 2000, and Table 18.1).

### Monitoring environmental carcinogens

The ageing process in dogs and other animals is more rapid than in man (Kirkwood, 1985). Tumours in dogs are seen most frequently between the ages of 9 and 11 years (Dorn *et al.*, 1968) – much earlier than in man. Thus, it is possible to assess the effects of possible environmental carcinogens more quickly in dogs than in man. For example, the latent period of bladder cancer is as little as 4 years in the dog (Hayes, 1976) in contrast to at least 20 years in man (Hoover and Cole, 1973).

<sup>4</sup> Early radiologists used spontaneous tumours in animals to provide guidelines for human radiation therapy (Gillette, 1979), and canine tumours have been used to evaluate whole body irradiation for lymphomas (Johnson *et al.*, 1968a,b). More recently, interest has focussed on osteosarcoma, mammary carcinoma, oral melanoma, oral squamous cell carcinoma, nasal tumours, pulmonary carcinoma, and soft-tissue sarcomas, with lymphomas receiving continued attention (MacEwen, 1990); whereas leukaemia, lymphoma and mammary tumours have been the subjects of investigation in cats (Jeglum, 1982).

**Table 18.2** Proportions of canine oropharyngeal cancers that are tonsillar squamous cell carcinomas, by geographical location. (Modified from Bostock and Curtis, 1984.)

Location	Year	Proportion (%)	Number of cases	Total (all malignant oropharyngeal neoplasms)
London	1950–53	46	35	76
US (non-industrial)	1959	6	8	124
	1964–74	7	31	469
Philadelphia	1952–58	22	29	130
South-east England	1978–81	13	19	152
Melbourne	1978–81	3	2	75

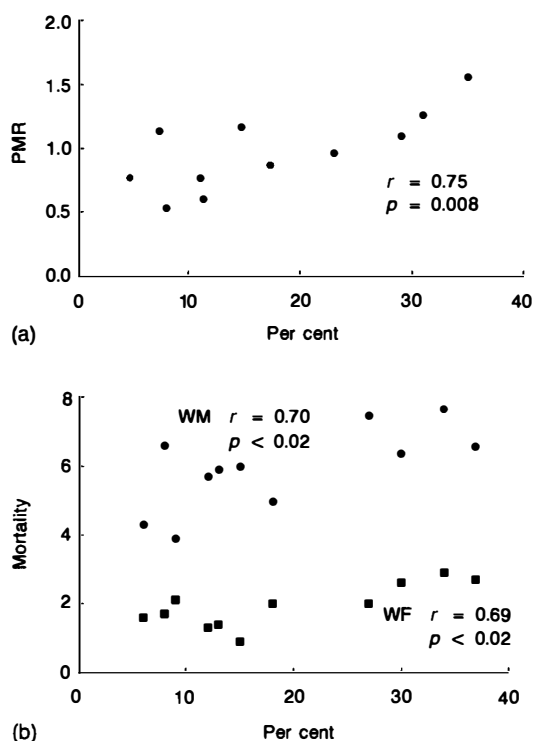

\* Standardized ratios based on proportional morbidity rates (Hayes *et al.*, 1981).

**Fig. 18.1** (a) Proportional morbidity ratios (PMRs)\* of bladder cancer among dogs living in a 25-mile radius of their veterinary clinic in the US, plotted against the percentage of men employed in manufacturing industries in the counties with the veterinary clinic.  $r$  = Correlation coefficient (see Chapter 14). (b) Human age-adjusted mortality/100 000 for bladder cancer (1950–1969) in white men (WM) and white women (WF) living in the counties with the surveyed veterinary clinics, plotted against the percentage of men employed in manufacturing industries in 1970.  $r$  = Correlation coefficient. (From Hayes *et al.*, 1981.)

There is an association between canine bladder cancer and exposure to insecticides (Glickman *et al.*, 1989). There is also a significant positive correlation between the overall level of industrial activity and both canine bladder cancer morbidity (Figure 18.1a), and human bladder cancer mortality rates (Figure 18.1b). These correlations suggest a causal relationship (reasoning by the ‘method of concomitant variation’; see Chapter

3). Similarly, the proportion of canine oropharyngeal cancers that are tonsillar squamous cell carcinomas is much higher in polluted industrial locations than in non-industrial areas (Reif and Cohen, 1971; also Table 18.2). These results suggest that carcinogens, probably airborne, may be present in industrial areas, and that dogs and their tumours can act as **sentinels**, facilitating early identification of environmental carcinogens.

Negative findings can also be useful. For instance, increased incidence rates of neoplasia have not been demonstrated in dogs environmentally exposed to uranium products following their use in the building industry (Reif *et al.*, 1983). This provides evidence that uranium waste does not constitute a health hazard to dogs, and probably not to man either.

### Identifying causes

Veterinary observational studies can provide clues to the causes of human cancer. For example, an association has been found between canine mesothelioma and exposure to both asbestos (which is a risk factor for human mesothelioma) and pesticides, notably flea preparations (Table 18.3). Some of the latter contain asbestos-like compounds, which could thus be risk factors for human mesothelioma and other tumours. Similar compounds are found in talc, and an association has been demonstrated between ovarian cancer in women and use of cosmetic talc (Cramer *et al.*, 1982). The latent period of human mesothelioma following occupational exposure to asbestos is long, nearly

**Table 18.3** Odds ratios and associated 95% confidence intervals for two risk factors for canine mesothelioma. (Simplified from Glickman *et al.*, 1983.)

Risk factor	Estimated odds ratio ( $\hat{\psi}$ )	95% confidence interval for $\psi$
Probable exposure of owner to asbestos by occupation or hobby	8.0	1.4, 10.6
Exposure to pesticide	11.0	1.5, 82.1

always greater than 20 years, with most cases occurring after 30 years (Selikoff *et al.*, 1979). In contrast, the greatest risk of development of canine mesothelioma is between 5 and 9 years of age. Thus, mesothelioma in dogs may be a useful sentinel for unrecognized human exposure to asbestos.

Comparison of site-specific cancer rates can also offer clues to aetiology. Human cancer rates are at least three times greater than canine and feline rates for six major cancer sites: the digestive, respiratory and urinary systems, and the uterus, ovary and prostate gland (Schneider, 1976). These disparities provide indirect evidence of possible causes. For instance, the high rate of human ovarian cancer may be related to the regular menstrual cycle. Female cats have a similar oestrus cycle to women (cats are seasonally polyoestrous; women are polyoestrous; each with cycles of 3–4 weeks) but have a much lower rate of ovarian cancer, even with compensation for the proportion of neutered cats. However, pregnancy is much more frequent in cats than in women. Thus, pregnancy may protect against the cancer, implying that hormonal status may be a determinant.

The age-specific incidence rates of mammary cancer in bitches and women are compared in Figure 18.2, after calculating a canine equivalent of human age (see 'Comparing ages', below). The rates are similar until the human menopause, when ovarian activity decreases and the human rate tends to stabilize, suggesting an hormonal determinant. This suggestion

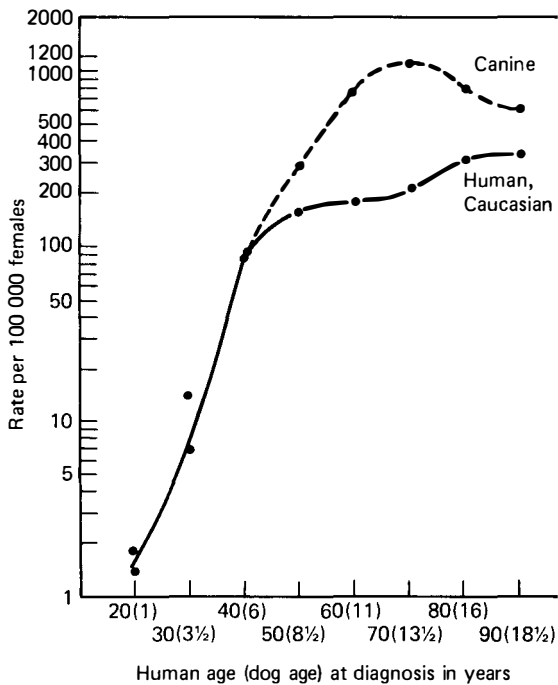

Fig. 18.2 Annual female human (Caucasian) and canine age-specific incidence rates for mammary cancer. (Modified from Schneider, 1970.)

is supported by the demonstration of receptors for steroid hormones in the cytosol fractions from canine mammary carcinomas (Martin *et al.*, 1984), and also by the reduction in their growth rate by the anti-oestrogen, tamoxifen, or by ovariectomy, after transplantation into nude mice (Pierrepont *et al.*, 1984).

Epidemiological studies in both dogs and cats (Misdorp, 1991) have demonstrated a dose-dependent relationship between progestagen therapy and the development of mammary tumours; and some human studies have identified a similar relationship associated with oral contraceptives (McPherson *et al.*, 1987; Miller *et al.*, 1989; Olsson *et al.*, 1989; UK National Case-control Study Group, 1989). This suggests that similar causal mechanisms are operating in companion animals and humans, and therefore that the former may be appropriate models for further study.

Animals are not exposed to some factors that may act as confounders in human studies. Investigations in animal populations, therefore, can avoid these potential confounders. For instance, smoking is a risk factor for human mesothelioma. The significant association between canine mesothelioma and exposure to asbestos, described above, is demonstrated in the absence of active smoking, and therefore is not confounded by it.

Potential risk factors may also be easier to quantify accurately in animals than in man. The diet of dogs, for example, is relatively constant, particularly when proprietary foods are consumed. An investigation of the role of diet in the development of canine mammary cancer has not demonstrated an association between a high-fat diet and the disease, although similar human studies, with the attendant difficulties in estimating fat intake precisely, have produced conflicting results (Sonnenschein *et al.*, 1991).

### Comparing ages

The lifespans of animals are different from that of man (Figure 18.3). Thus, as a calendar and a 'biological' year are the same for man, a correction should be made for the majority of species that have several 'biological'

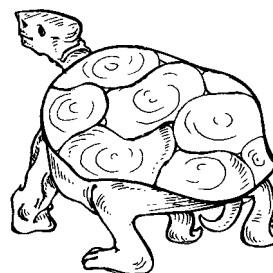

Animal	Years
Tortoise	150
Man	113
Asian elephant	60
Horse	40
Domestic cat	30
Rhesus monkey	24
Dog	20
Rat	4
Mouse	3.5

Fig. 18.3 The maximum verifiable lifespans of several animals.

**Table 18.4** Examples of comparative ages between humans, dogs and cats. (From Schneider, 1976.)

Human age (years)	Canine age equivalent (years)*	Feline age equivalent (years)*
24	2	1-1/2
32-35	4	4
52-55	9	10
72-75	14	16
>91	>18	>21

\* Based on the age when maturity is reached and on survival that excludes euthanasia of animals because of human-related reasons (e.g., if animals are unwanted).

years during one calendar year, so that more meaningful comparisons of morbidity and mortality can be made. Two techniques are used (Kirkwood, 1985). First, anatomical and physiological characteristics that correlate with age can be sought (e.g., adult brain weight, onset of puberty and reproductive senescence). Secondly, the survival pattern of different species can be compared mathematically using an equation based on Gompertz's law (Johnson and Kotz, 1970), which defines a relationship between probability of death and age. The two techniques are frequently combined (Table 18.4).

The lifespan-adjustment method of Lebeau (1953) also amalgamates these two approaches and is illustrated in Figure 18.4. Lebeau argued that, once maturity is reached, ageing occurs at a constant rate in dogs and man. A 1-year-old dog is equivalent in age to a 15-year-old person; a 2-year-old dog to a 24-year-old person; and, above the age of 2 years, each year of a dog's life is equivalent to four human years. Thus, a 10-year-old dog is equivalent to a 56-year-old person (24 years, plus four years for each canine year from 3 years old onwards). The coefficients necessary to calculate human age equivalents for various ages of

**Table 18.5** Canine age, equivalence coefficient, and human age equivalent. (From Anon, 1954.)

Canine age	Coefficient	Human age
6 months	20.0	10 years
7 months	20.0	11 years 8 months
8 months	19.0	12 years 8 months
9 months	18.0	13 years 6 months
10 months	17.0	14 years 2 months
11 months	16.0	14 years 8 months
12 months (1 year)	15.0	15 years
14 months	14.5	16 years 11 months
16 months	14.0	18 years 8 months
18 months	13.5	20 years 3 months
20 months	13.0	21 years 8 months
22 months	12.5	22 years 9 months
24 months (2 years)	12.0	24 years
3 years	9.3	28 years
4 years	8.0	32 years
5 years	7.2	36 years
6 years	6.6	40 years
7 years	6.3	44 years
8 years	6.0	48 years
9 years	5.8	52 years
10 years	5.6	56 years
11 years	5.4	60 years
12 years	5.3	64 years
13 years	5.2	68 years
14 years	5.1	72 years
15 years	5.06	76 years
16 years	5.0	80 years
17 years	4.9	84 years
18 years	4.87	88 years
19 years	4.84	92 years
20 years	4.80	96 years
21 years	4.76	100 years

dog are listed in Table 18.5. Lebeau's technique is utilized in Figure 18.2. However, Reif (1983) emphasizes the problems associated with such a conversion, because large breeds of dog tend to live shorter lives than small breeds.

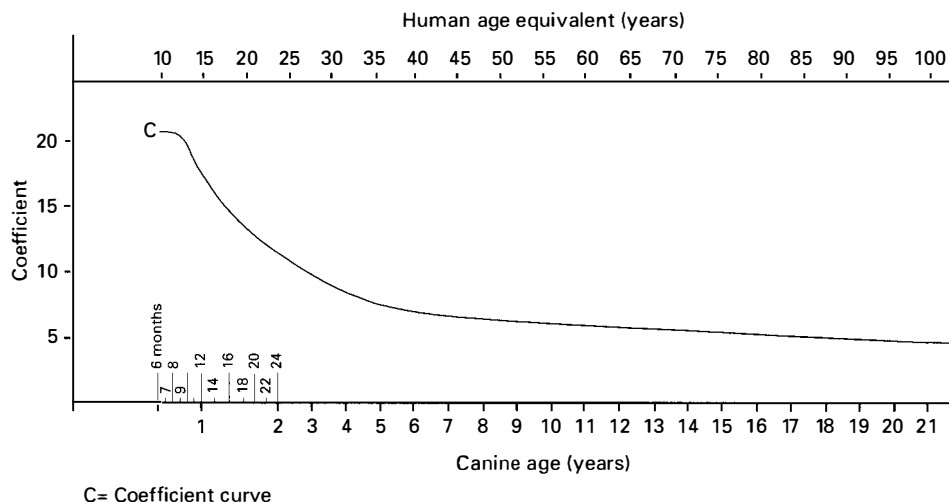
**Fig. 18.4** Conversion of canine age to its human age equivalent. (Redrawn from Anon., 1954; after Lebeau, 1953.)

**Table 18.6** Lifespan correction factors derived from the lifespan of several species. (From Dorn and Priester, 1987.)

Species	Recorded maximum lifespan (RML)	Correction factor (RML/100)
Man	100*	1
Ox	30	0.30
Horse	46	0.46
Pig	26	0.27
Sheep	20	0.20
Dog	20	0.20
Cat	28	0.28

\* Arbitrary.

Other criteria for age equivalence are based on the mean age of populations and correction factors related to recorded maximum lifespans such as those presented in *Figure 18.3*. Thus, using the correction factors in *Table 18.6*, the estimated bovine rate of malignancy in *Table 18.1* (177.2/100 000/year) is lifespan-adjusted by multiplying the value by 0.30, giving a lifespan-adjusted value of 53.2/100 000/year.

Another correction, in addition to lifespan adjustment, should also be made when comparing human and companion-animal populations because of the different proportions of individuals of various ages in each population. If canine populations (*Figures 5.4a* and *5.4b*) are compared with human populations, it can be noted that the shape of the canine population pyramid is similar to that of human populations with high fecundity and a low proportion of individuals surviving to old age; for example, 19th cen-

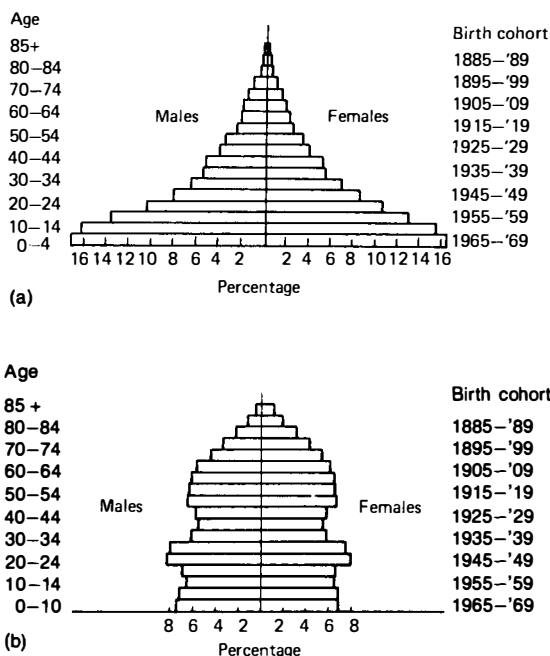
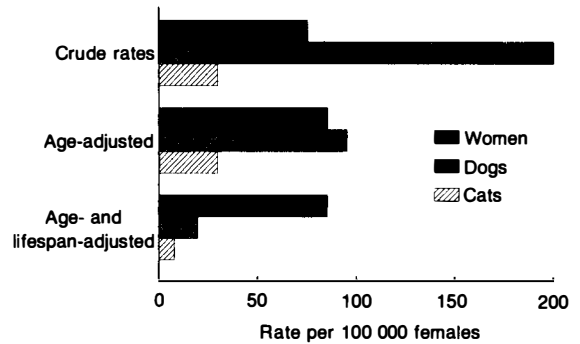
**Fig. 18.5** Human population pyramids. (a) Mexico, 1970; (b) Sweden, 1970. (From Ewbank and Wray, 1980.)**Fig. 18.6** Estimated annual incidence rates of mammary cancer in women, dogs and cats: crude rates and two levels of rate adjustment (data from the US). (From Dorn and Priester, 1987.)

tury European and North American populations and contemporary populations in developing countries (*Figure 18.5a*). It contrasts with the pyramid of human populations with low fecundity and a high proportion of individuals surviving to old age, for example, in contemporary developed countries (*Figure 18.5b*). Most comparative studies are undertaken in developed countries, and so the lifespan-adjusted rates in the populations that are being compared should also be age-adjusted (see Chapter 4).

*Figure 18.6* presents crude rates, and age- and lifespan-adjusted rates, for mammary cancer in bitches and women, indicating the difference between the crude rates and the rates with two levels of adjustment. The crude rates suggest that cancer incidence is greater in bitches than in women. However, the age- and lifespan-adjusted rates, which reflect the comparative incidence best, demonstrate that women are more prone to the cancer than either bitches or cats.

## Some other diseases

### Diseases with a major genetic component

Comparative studies also provide evidence for genetic causal mechanisms. Thus, there is evidence, derived from epidemiological and family studies, of the importance of genetic factors in the aetiology of human congenital heart disease. Limited success has been achieved in identifying the anatomical defects that have significant genetic causal factors, and in determining the nature of the underlying genetic abnormality and the pathway from genetic defect to structural abnormality. However, studies on dogs have provided valuable insights into this type of disease. The inheritance of patent ductus arteriosus (PDA) in dogs is more complex than a simple autosomal dominant mode (Patterson *et al.*, 1971). There is evidence that inheritance of the condition is multifactorial (see

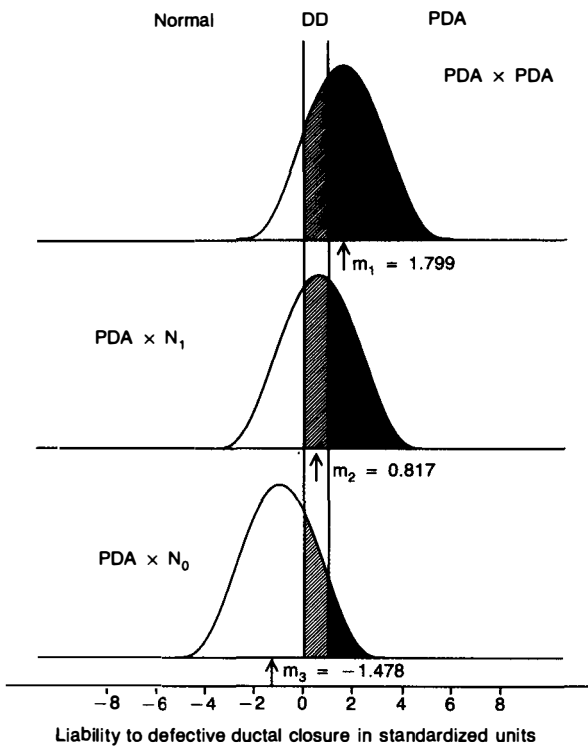

**Fig. 18.7** Two-threshold model of hereditary patent ductus arteriosus (PDA) in dogs. PDA: Patent ductus arteriosus;  $N_1$ : normal first-degree relatives;  $N_0$ : normal unrelated dogs;  $m$ : mean liability in offspring of crosses, expressed as standardized units for likely incidence of the condition (Falconer, 1989). Liability to defective ductal closure is depicted as a continuous variable, phenotypic discontinuities occurring at critical thresholds on the underlying scale. Below the lower threshold, the ductus closes throughout its length. Between the upper and the lower thresholds, the ductus closes at the end nearest the pulmonary artery, but remains open over the rest of its length, producing a ductus diverticulum. Beyond the upper threshold, the ductus remains open over its entire length, and PDA is present. The areas under the curves defined by the thresholds represent proportions of offspring observed in each phenotypic class. Mean liability of offspring from outcrosses of PDA-affected dogs to normal unrelated dogs ( $m_3$ ) lies below, but overlaps, both thresholds. Mean liability in crosses between two dogs with PDA ( $m_1$ ) lies above both thresholds. Crosses between PDA-affected dogs and normal first-degree relatives of PDA-affected dogs result in a distribution of offspring with a mean liability to defective ductal closure ( $m_2$ ) approximately halfway between the other two matings. (Modified from Patterson *et al.*, 1971.)

Chapter 5), and that there are different thresholds for expression of the less severe ductus diverticulum and the fully patent ductus arteriosus (Figure 18.7).

Histological studies on litters of poodles genetically predisposed to PDA subsequently demonstrated that PDA is the result of a genetically determined extension of the non-contractile wall of the aorta into the ductus arteriosus. The role of environmental factors (e.g., diet and season) in the cause of this disease is unclear, but such factors are known to influence other threshold traits (e.g., cleft palate in laboratory animals). Epidemiological studies in man, based on comparison

of disease rates in both siblings and offspring of affected individuals with rates in the general population (Figure 18.8), suggest a similar mode of inheritance to that in the dog (Zetterquist, 1972).

Other useful companion-animal models of genetic diseases are discussed by Patterson *et al.* (1982); they include those of lysosomal storage diseases and disorders of the immune system.

## Some non-infectious diseases

Congenital defects, which may have known genetic determinants, are common in man. Studies in companion animals can support or refute associated causal hypotheses. Hypospadias (a developmental abnormality of the urethral meatus) is relatively common in man but its cause is unclear. It occurs often with other developmental defects, is commoner in males than females, and has familial and seasonal associations. These characteristics suggest both genetic and environmental determinants. Using VMDB data, a breed predisposition has been demonstrated in Boston terriers (Hayes and Wilson, 1986), adding credence to genes as determinants.

## Diseases associated with environmental pollution

Several environmental factors, including air pollution and occupational hazards, have been implicated as causes of various types of non-neoplastic chronic pulmonary disease (e.g., bronchitis and emphysema) in man. Chronic pulmonary lesions also occur in the dog. These include interstitial fibrosis and chronic inflammation, emphysema and pleural fibrosis – collectively termed ‘chronic pulmonary disease’ (CPD).

The association between the prevalence of CPD, assessed radiographically, and age and environment (urban versus rural) has been studied in the US (Reif and Cohen, 1979). Results relating to Ithaca (rural) and Boston and Philadelphia (urban) showed a higher prevalence in dogs living in urban areas than in rural areas, but the difference was only identified in dogs over 7 years of age, indicating that, in the dog, this may be the latent period of the cumulative effects of environmental hazards. In Philadelphia, an urban/rural prevalence difference also has been identified (Figure 18.9a), and this correlated approximately with atmospheric air pollution (Figure 18.9b).

The effects of environmental toxic agents also have been first identified in animals (Buck, 1979). These include trichlorethylene (in cattle), chlorinated naphthalenes (in cattle), aflatoxins (in dogs, cattle and pigs) and organophosphorus nerve agents (in sheep).



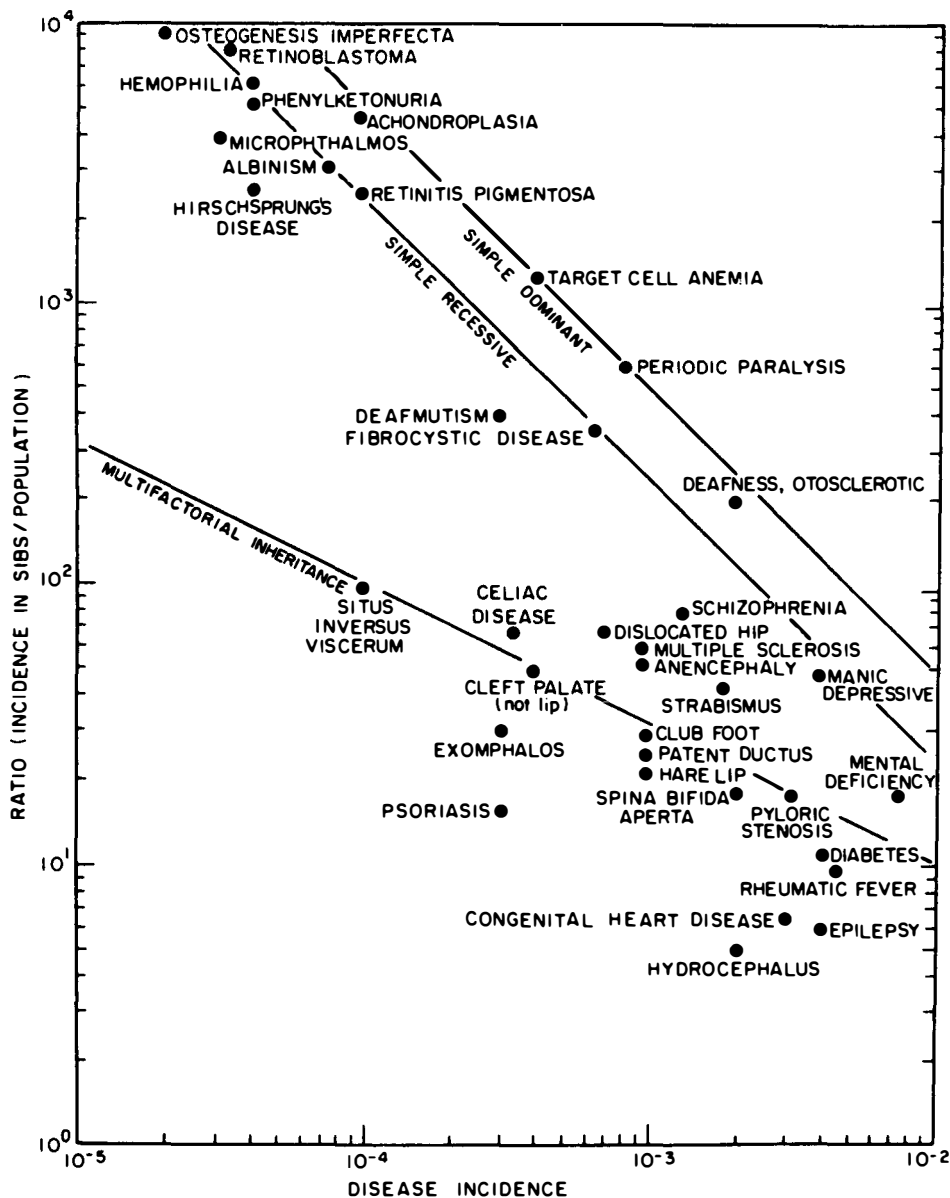

**Fig. 18.8** Comparison of the risk in siblings of human patients for single-gene traits with the risk in siblings of patients for multifactorial traits. On a  $\log_{10}$  scale, the incidence of each disease is plotted against the ratio of the incidence of the disease in siblings to the incidence in the general population. Single-gene and multifactorial conditions fall into two distinct clusters. The two-cluster effect is simply due to the reduced chance of individuals inheriting **all** necessary genes to show disease in multifactorial conditions. (From Newcombe, 1964.)

Animals can also be effective sentinels of environmental toxins. For example, beef cattle are sentinels of chlorinated hydrocarbon insecticides (Salman *et al.*, 1990). Similarly, dogs scavenging on shorelines are sentinels of cyanobacterial toxins occurring in littoral bacterial scum (Codd *et al.*, 1992), possibly because they are attracted by the taste and odour of the bacteria.

### Reasoning in comparative studies

Comparative studies involve reasoning by analogy, and the inferences can be wrong, exemplified by Snow's conclusion that cholera and yellow fever are transmitted by contaminated water because they both

occur in insanitary conditions (see Chapter 3). Such conclusions should therefore be treated with caution.

Inferences also should be tempered by the knowledge that many diseases are multifactorial, either because several factors are required to induce a single disease, or because several factors cause disease manifestations that cannot be distinguished at present (MacMahon, 1972). For instance, canine epileptiform seizures appear to be genetically determined in some circumstances, but environmentally induced in others (Bielfelt *et al.*, 1971); and there is evidence that diabetes mellitus is caused by chemicals, autoimmune reactions and virus infection (Yoon *et al.*, 1987).

Inference is less reliable between species, because similar manifestations in different species may be the

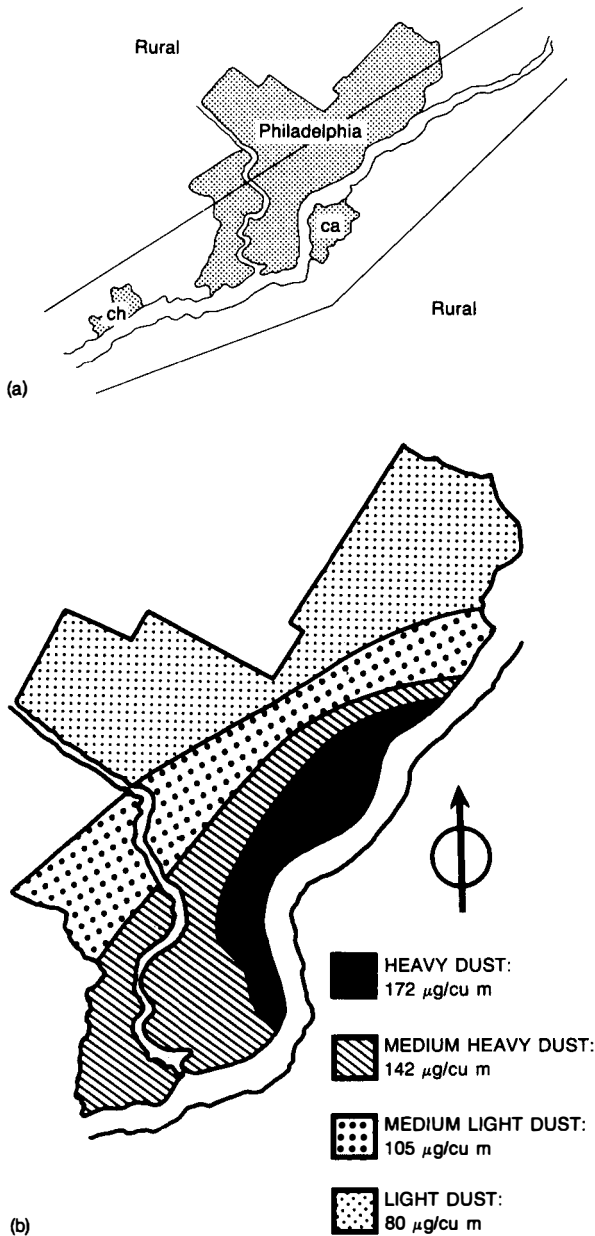

**Fig. 18.9** The relationship between the prevalence of canine chronic pulmonary disease (CPD) and location, Philadelphia, US. (a) Relative prevalence of CPD in dogs 7–12 years of age: the prevalence is high in the area between the two lines, and low outside these lines. (ca = Cambden; ch = Chester.) (b) Atmospheric dust concentration. (From Reif and Cohen, 1970.)

result of different pathological processes. For example, a variety of species are subject to epileptiform and experimental seizures (Biziere and Chambon, 1987), but the relationship of these conditions to human epilepsy is unclear. Part of the problem is taxonomic: diseases named by clinical signs (e.g., epilepsy) are more likely to be multifactorial than those named by a specific lesion, because the former may be produced by several lesions, each of which may have distinct sufficient causes (see Figure 9.3). Thus, the inferences drawn from comparative studies are strengthened when the studies are undertaken on specific structures

with similar lesions (e.g., the studies of bladder cancer described above), on the plausible assumption that similar lesions in identical structures are likely to have similar causes.

An important criterion for producing a convincing model is its ability to work in more than one situation (Davidson *et al.*, 1987). There are similarities in the modes of inheritance of several genetic diseases (e.g., canine and human haemophilia), and there are close similarities between the causes and, consequently, treatment of tumours in animals and man. Such similarities suggest that animal models of human genetic and neoplastic diseases are sound, and that there is practical value in using them, particularly when the diseases are much more common in animals than in man (e.g., canine osteosarcoma: Brodey, 1979).

### Further reading

- Anon. (1991) *Animals as Sentinels of Environmental Health Hazards*. Committee on Animals as Monitors of Environmental Hazards, Board of Environmental Studies and Toxicology, Commission on Life Sciences, National Research Council. National Academy Press, Washington, DC
- Bukowski, J.A. and Wartenberg, D. (1997) An alternative approach for investigating the carcinogenicity of indoor air pollution: pets as sentinels of environmental cancer risk. *Environmental Health Perspectives*, **105**, 1312–1319
- Bustad, L.K., Hegreberg, G.A. and Padgett, G.A. (1975) *Naturally Occurring Animal Models of Human Disease: A Bibliography*. Institute of Laboratory Animal Resources, National Academy of Sciences, Washington, DC
- Dorn, C.R. and Priester, W.A. (1987) Epidemiology. In: *Veterinary Cancer Medicine*, 2nd edn. Eds Theilen, G.H. and Madewell, B.R., pp. 27–52. Lea and Febiger, Philadelphia. (Includes a discussion of comparative oncology)
- Glickman, L.T. and Domanski, L.M. (1986) An alternative to laboratory animal experimentation for human health risk assessment: epidemiological studies of pet animals. *Alternatives to Laboratory Animals*, **13**, 267–285
- Hayes, H.M. (1978) The comparative epidemiology of selected neoplasms between dogs, cats and humans. A review. *European Journal of Cancer*, **14**, 1299–1308
- Kelsey, J.L., Moore, A.S. and Glickman, L.T. (1998) Epidemiologic studies of risk factors for cancer in pet dogs. *Epidemiologic Reviews*, **20**, 204–217
- Reif, J.S. (1986) Animal models for environmental epidemiology. In: *Practices in Veterinary Public Health and Preventive Medicine in the United States*. Ed. Woods, G.T., pp. 273–290. Iowa State University Press, Ames
- Richardson, R.C. (1983) Spontaneous canine and feline neoplasms as models of cancer in man. *Kal Kan Forum*, **2**, 89–94
- Scarpelli, D.G. (1997) Animal models of disease: utility and limitations. In: *Biological Aspects of Disease: Contributions from Animal Models*. Eds Iannaccone, P.M. and Scarpelli, D.G., pp. 1–13. Harwood Academic Publishers, Amsterdam
- Withrow, S.J. (2001) Why worry about cancer in pets? In: *Small Animal Clinical Oncology*, 3rd edn. Eds Withrow, S.J. and MacEwen, E.G., pp. 1–3. W.B. Saunders, Philadelphia. (Includes a brief discussion of comparative oncology)

# 19

## Modelling

---

Modelling is the representation of physical processes, designed to increase appreciation and understanding of them. Thus, two causal models were described in Chapter 3, and two models of interaction in Chapter 5. Similarly, the Normal distribution (see Chapter 12) is sometimes termed the Normal probability model. A more specific meaning of modelling is the representation of events in quantitative mathematical terms, which may allow predictions to be made about the events. Modelling, in this sense, is applied to many disciplines, including engineering, agriculture and medicine. In epidemiology, it provides a useful means of investigating diseases where experiments and field observations are impracticable. Models are constructed to attempt to explain and predict patterns of disease occurrence and what is likely to happen if various alternative control strategies are adopted. An introduction to this approach has already been given in Chapter 8 in which the Reed–Frost model of a propagating epidemic was described. Accurate models can be useful guides to choosing the most efficient disease control techniques as well as increasing understanding of the life-cycles of infectious agents. This chapter describes the main types of model, giving examples relating to infectious diseases.

Modelling dates back to the 18th century, when Daniel Bernoulli applied a simple life table to French smallpox data, which indicated that variolation<sup>1</sup> was efficacious and conferred lifelong immunity (Bernoulli, 1766). Records of human deaths were maintained in parish registers in the UK, a notable example being those of the 1665–66 epidemic of plague in the village of Eyam in Derbyshire (Creighton, 1965). John Graunt's compilation of 17th century English mortality

data, and the French Royal Society of Medicine's recording of 18th century statistical data on animal and human epidemics, have already been mentioned in Chapter 1. Friendly Societies, founded in the UK early in the 19th century, recorded information on disease and deaths among their members (Ratcliffe, 1850). Thus, morbidity and mortality data on diseases such as smallpox and plague were readily available by the middle of the 19th century, and mathematical models were proposed by medical statisticians to explain the observed mortality rates (Greenwood, 1943). William Farr fitted a lognormal curve (see Chapter 12) – initially enunciated by De Moivre in 1733 – to smallpox data in England and Wales (Farr, 1840), and predicted the course of the 1866 British rinderpest epidemic using a similar approach (Brownlee, 1915; Spinage, 2003)<sup>2</sup>.

The early models, which founded general theory, described natural epidemics of human infectious diseases. Only within the last 40 years has significant attention been paid to the modelling of animal diseases. Since the early work, there has been a division into the theoretical approach, which is concerned with epidemic theory, and the practical approach, which attempts to be of direct value to disease control campaigns. Successive models have attempted to become more realistic, incorporating the effects of control techniques, such as vaccination and administration of medicines, in order to evaluate alternative strategies for disease control. The effects of economic constraints and implications have, of necessity, been incorporated in the more recent formulations. Many techniques use

---

<sup>1</sup> Variolation is the obsolete process of inoculating a susceptible person with material from the vesicle of a patient with smallpox.

---

<sup>2</sup> Farr also studied cholera, and his quantitative investigations were in contrast to the qualitative observations of John Snow (see Chapter 3), the latter of which, however, provided a clearer explanation of the disease's cause than the former (Eyler, 2001).

computers to simulate situations, although they are not always necessary.

## Types of model

### Density and prevalence models

Veterinary modelling has been directed towards infectious diseases, although non-infectious ones can also be modelled. Infectious agents can be classified into two groups according to their generation dynamics: **micro-parasites** (e.g., viruses and bacteria) and **macroparasites** (e.g., helminths and arthropods) (see Chapter 7), and the two different dynamic patterns lend themselves to two different types of modelling.

**Density models** consider the absolute number of infectious agents in each host, and are commonly used in macroparasitic infections, where numbers of infectious agents can be estimated either in the host or in the environment. Microparasitic infections can also be modelled using density models when microparasite numbers can be enumerated, but are frequently studied using **prevalence models**, which consider the presence or absence of infection in various host cohorts; for example, young and mature, immune and susceptible. The density model is potentially the more refined of the two techniques because it attempts to enumerate the number of infectious agents with which a host is challenged.

### Deterministic and stochastic models

In many models, the values of input parameters can be fixed, and the results obtained do not take account of random variation (i.e. variability). Such mathematical descriptions are examples of **deterministic** models. In contrast, some models describe processes or events subject to random variation. Additionally, there may be uncertainty stemming from the modeller's lack of knowledge of the parameters (see also Appendix XXIV). Variability and uncertainty lead to outcomes with a probability. These models are **stochastic**, the word being derived from the Greek *stochastikos*, meaning 'skilful in aiming at, able to guess'. Stochastic models often enable probability distributions and confidence intervals to be associated with the outputs.

It may not always be clear whether a model is deterministic or stochastic. For example, the basic Reed–Frost model (see Table 8.1 and Figures 8.6 and 8.7) includes a probability of an animal infecting another, yet the predicted outcome has no measure of variation attached to it. This model is therefore deterministic.

Density and prevalence models often can be formulated deterministically or stochastically using a variety of approaches.

## Modelling approaches

### Deterministic differential calculus modelling

Differential calculus is a mathematical technique for finding small (theoretically infinitesimal) rates of change. Models based on this procedure generally establish equations in terms of the rate of change of either the number of parasites or the number of hosts, or subsets of these populations, with respect to time.

### Deterministic exponential decay paradigm

One of the earliest and simplest examples of differential calculus models is that of **exponential decay**. The instantaneous rate at which susceptibles in a population become infectious individuals, denoted by  $dx/dt$  (where  $dx$  is the change in the population in the small time interval  $dt$ ), is assumed to be directly proportional to  $x$  (the number of susceptibles in the population):

$$\frac{dx}{dt} = -\alpha x.$$

In the model,  $\alpha$  is a positive number that remains constant and is therefore a parameter of the model. It is preceded by a minus sign because the number of susceptibles decreases as they become infectives. If an input condition is known, such as the number of susceptibles in the population at time 0, then solving the equation leads to:

$$x_t = Ne^{-\alpha t}$$

where  $x_t$  and  $N$  are the numbers of susceptibles in the population at times  $t$  and 0 respectively and  $e$  is the universal exponential constant, 2.718. If  $x_t$  is plotted for different values of  $t$ , a curve is obtained showing  $x_t$  decreasing rapidly for small values of  $t$  and thereafter more slowly.

### Sheep vaccination paradigm

The following example demonstrates how immunity could be included in the simple exponential decay model. Suppose a flock of sheep is constantly under challenge from an infectious agent, infection with which usually causes death. The rate at which animals die is once again assumed to be in direct proportion to the number of animals that are under challenge and that are susceptible to infection. If a certain proportion of the animals show signs, and can be treated with a vaccine that provides temporary immunity, then these animals will not die. Once the protection of the vaccine ceases, these immune animals become susceptible again and risk mortality. The system is illustrated

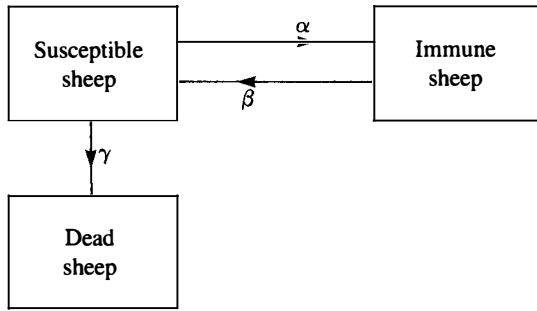

Fig. 19.1 Compartmental representation of a sheep vaccination model.

by the two-compartmental representation shown in Figure 19.1.

The left-hand compartment represents the susceptibles under challenge. Animals in this compartment may either die at rate  $\gamma$  or be identified for vaccine treatment and so become transferred at rate  $\alpha$  to the right-hand compartment, which represents the immune animals. When immunity ceases, these animals return to the susceptible group at rate  $\beta$ . The model consists of two equations, one for the rate of change of susceptible animals,  $dx/dt$ , and one for the rate of change of immune animals,  $dy/dt$ :

$$\frac{dx}{dt} = -\alpha x - \gamma x + \beta y,$$

and

$$\frac{dy}{dt} = \alpha x - \beta y.$$

Losses from the susceptible group due to mortality and vaccination are in proportion to the number in the group and are the terms  $-\alpha x$  and  $-\gamma x$  on the right-hand side of the equation for  $dx/dt$ . Animals returning to the susceptible group, however, lose immunity in proportion to the number in the immune group. This movement into the susceptible group is denoted by  $+\beta y$ . Similarly, the rate of change of animals in the immune group is the net result of the gain  $\alpha x$  and loss  $-\beta y$ . Standard methods of solution enable expressions for  $x$  and  $y$  to be obtained in terms of  $t$ :

$$x = \frac{N}{(a-b)} \{(\beta-b)e^{-bt} - (\beta-\alpha)e^{-at}\},$$

and

$$y = \frac{N\alpha}{(a-b)} (e^{-bt} - e^{-at}),$$

where

$$a = \frac{1}{2}[(\alpha + \beta + \gamma) + \{(\alpha + \beta + \gamma)^2 - 4\gamma\beta\}^{1/2}],$$

$$b = \frac{1}{2}[(\alpha + \beta + \gamma) - \{(\alpha + \beta + \gamma)^2 - 4\gamma\beta\}^{1/2}],$$

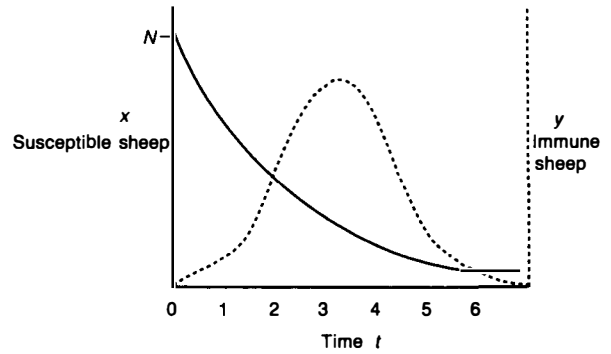

Fig. 19.2 Trends showing the changing number of sheep in the susceptible and immune groups in the sheep vaccination model paradigm.

and  $N$  is the size of the flock at time 0. Figure 19.2 shows the trends in the numbers of susceptible and immune animals. These are only general trends; the exact trend will depend on the values assigned to the parameters,  $\alpha$ ,  $\beta$  and  $\gamma$ . It can be seen that the numbers in the susceptible group decrease rapidly whereas the numbers in the immune group rise to a peak before falling. Eventually the numbers in both groups will be zero because all animals will die unless some other control action is undertaken.

The early models of simple epidemics were based on the differential calculus approach, and usually contained simplistic assumptions; for example, that no infectious individuals were removed from the population during the course of the epidemic. This assumption was incorporated into the Reed–Frost model, which formed the basis of many early models. Although this assumption may sometimes be valid in human epidemics, it is frequently untrue of animal epidemics: infectious animals are often removed by culling.

The early models assumed that a group was of a given size with homogeneous mixing and that a susceptible individual was infectious as soon as it was infected (i.e., the infection had no incubation or latent period). Most infectious diseases have latent periods and, in many situations, mixing is rarely homogeneous and individuals may become immune. Models have been produced which take account of these factors.

Additionally, only a few diseases are characterized by interepidemic periods when no cases of disease occur (e.g., rabies and foot-and-mouth disease in the UK). Most diseases are endemic to a varying degree, and it is possible to have recurrent epidemics, requiring different models.

The earlier models considered epidemics as processes that occur in continuous time; these were continuous time models. Discrete time models have been designed which portray disease patterns in fixed intervals of time. For example, if an epidemic starts with a

single individual or several simultaneously infected individuals, then new cases will occur in a series of stages separated by time intervals equal to the disease's incubation period. A further discrete time development has been of models that consider individuals as occurring in a variety of states (**multistate** models), for instance susceptible, immune, infected and dead. Models that consider how individuals can move from one state to another are called **state-transition** models. These are frequently prevalence models.

### Tuberculosis in badgers

Bovine tuberculosis continues to be a substantial problem in the south-west of England because infected badgers are considered to be a source of infection to cattle. A possible method of disease control is to reduce the badger population density to a level below the threshold level (see Chapter 8) for maintenance of the infection.

An early simple model of the dynamics of bovine tuberculosis in badgers used a deterministic, state-transition, differential calculus, prevalence model (Trehwella and Anderson, 1983) which includes three states: susceptible animals, animals incubating the disease, and infected animals (*Figure 19.3*). There is no need to include an immune state because badgers show no immunity to bovine tuberculosis. Parameters include density-dependent regulation of the badger population, natural and disease-induced death rates, the incubation period of the infection, and the rate of transmission.

The model predicts that prevalence increases with badger density, the predicted values being supported by field observations, and that prevalence oscillations occur with a periodicity of 18 years. The model suggests that, in areas of high badger density, considerable effort would be required to control the infec-

tion. Since then, many other proposed models have considered how best to control bovine tuberculosis. However, the mode of transmission is still unclear, and so such models cannot be fully exploited.

### Rabies in foxes

Foxes are hosts of rabies in North America and Europe, and constitute a serious obstacle to control of the disease. The infection became established in foxes in Poland towards the end of the Second World War. The epidemic spread slowly westwards at a rate of about 30 km/year. The standard method of control was slaughter of foxes, but results were disappointing. A mathematical model (Macdonald and Bacon, 1980) suggested that control, other than by slaughter of foxes, would be more successful. The model has two components:

1. prediction of the course of the disease in fox populations;
2. evaluation of different control policies.

The model of the disease in fox populations makes plausible assumptions about the host and parasite. Foxes breed once a year in the autumn, and fox mortality is highest in the winter, resulting in an annual fluctuation in fox numbers. The virus has a long incubation period and can therefore survive in hosts of high, changing and low densities (see *Figure 6.4*); in the last circumstance it can exist for a long time in individuals.

If rabies enters a fox population, the future of the host and parasite will be affected by the number of healthy foxes that are infected by rabid foxes; expressed as a ratio, this is the **contact rate**. If the disease is modelled for various contact rates, there are different predicted outcomes; these are shown in *Figure 19.4a*. The upper lines of the graphs represent the total fox population, the lower lines the healthy foxes, and the shaded areas the number of rabid foxes. The horizontal lines represent the number of foxes that, theoretically, can be carried by the habitat. A contact rate of 0.5 (one rabid fox infecting half a healthy fox) will, according to Kendall's Threshold Theorem (see Chapter 8), be insufficient to allow the infection to become established; the model supports this. Higher contact rates result in fluctuation in the fox population and in the number of rabid foxes. A contact rate of 1.4 allows the disease to persist, oscillating annually. A contact rate of 1.9 produces epidemics every 4 years that are severe enough to reduce the population to a level that will not support infection. The infection again becomes epidemic when the fox population recovers. Field surveys have shown that this periodicity is demonstrated in European foxes. Higher contact rates would lead to extinction of the fox population.

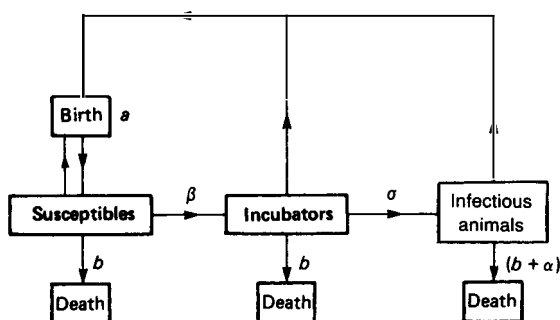

**Fig. 19.3** Flow chart of the deterministic model of bovine tuberculosis in badgers. The flow of individual hosts between states is controlled by the rate parameters:  $a$  = the per capita birth rate;  $b$  = the natural death rate;  $\beta$  = the disease transmission coefficient;  $\sigma$  = the rates at which incubating individuals become infected;  $\alpha$  = the disease induced death rate. (Modified from Trehwella and Anderson, 1983.)

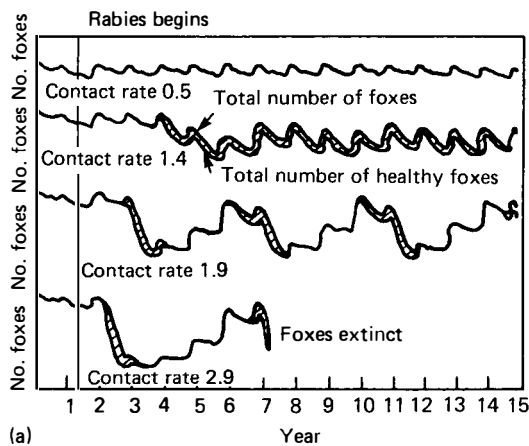

(a)

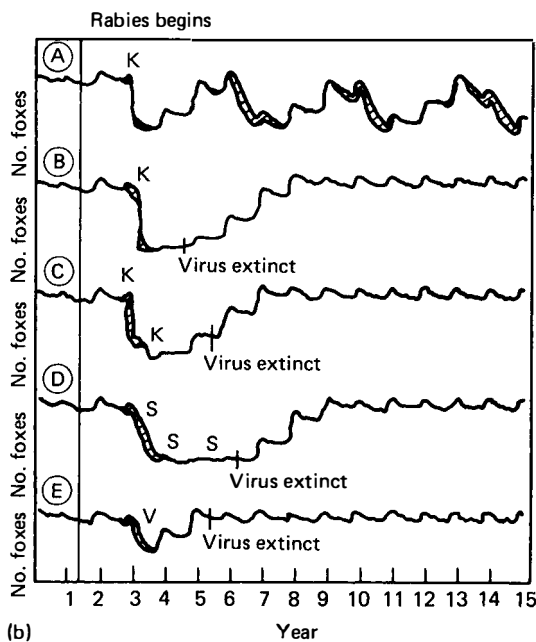

(b)

Control strategies:  
 K = controlled fox kill  
 S = temporary sterilization of foxes  
 V = bait vaccination of foxes

**Fig. 19.4** (a) Merlewood model of rabies in foxes; (b) Merlewood model of alternative control strategies for controlling rabies in foxes. In each graph, the initial level of the fox population is the same. (From Macdonald and Bacon, 1980.)

The second component of the model considers three control techniques (Figure 19.4b):

1. slaughter;
2. temporary sterilization;
3. bait vaccination of foxes.

In case A, a single cull is instituted when rabies is at its earliest detectable level. Although slaughter initially decreases the prevalence of the disease, the latter soon increases again and then follows a pattern similar to that in the graph in Figure 19.4a depicting a contact rate of 1.9.

In case B, killing takes place later, probably when rabies is more likely to have been detected. Paradoxically, although initially there are more cases, the disease and the kill work together because more of the foxes that are not killed are incubating rabies and therefore will die. The virus thus becomes extinct as the fox population is dramatically reduced.

Case C represents two killings, separated by 6 months. Again, the virus becomes extinct, but the fox population is reduced below the levels in A and B.

Three applications of temporary sterilizing agent are illustrated in case D. The virus again is extinguished, but the fox population is reduced further.

Vaccination of foxes using bait vaccine-laden bait, shown in case E, offers the best results: removing the virus from the population and maintaining the number of healthy foxes (with 60% of foxes assumed to be immunized).

This model therefore suggests a more efficient and ecologically acceptable way of controlling fox rabies than slaughter. This type of oral vaccination is being used successfully in Europe (Müller, 1991; Pastoret and Brochier, 1998), where it can be complemented by the control of fox populations (Aubert, 1994). Oral vaccination is also being applied to other sylvatic hosts in North America.

A criticism of simple models based on differential calculus is the common assumption that parameters remain constant throughout the period of operation; for example, that the survival rate of infective organisms does not change during a season, whereas, in reality, climatic variation may alter survival rates from day to day. Some models do have time-dependent parameters, but this may lead to a model for which a solution is unobtainable or make the operation of the model clumsy. A major feature of such models is that they enable the long-term behaviour of the parasite population to be studied. The population may either become extinct, or increase indefinitely, or reach a steady state. It is often whether or not a steady state exists and the nature of the steady state that is of interest, although for many diseases of production animals the initial progression may be of paramount importance if economic losses are to be minimized.

## Stochastic differential calculus modelling

The first epidemic models considered that *the course of an epidemic must depend on the number of susceptibles and the contact rate between susceptible and infectious individuals*; this is the basic assumption underlying deterministic models. In a deterministic model, the future state of an epidemic process can be predicted precisely if the initial number of susceptible and infectious individuals is known (e.g., Figures 8.6 and 8.7).

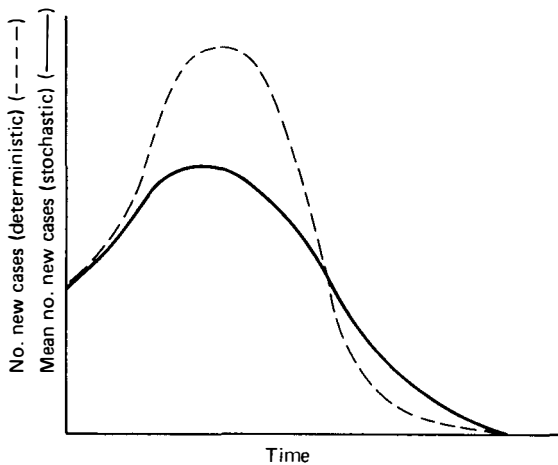
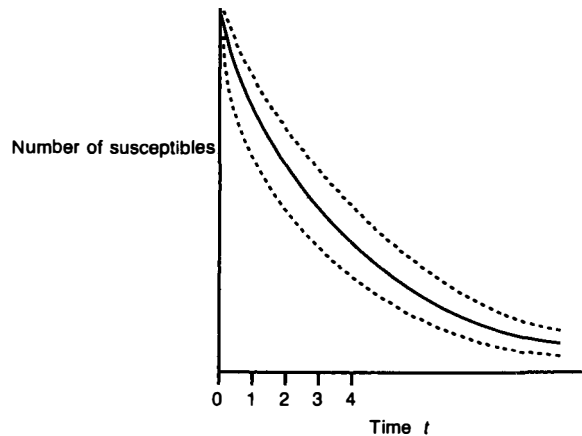

**Fig. 19.5** Deterministic and stochastic model curves for a simple infectious epidemic. (After Bailey, 1975.)

Later, it was realized that the deterministic approach was not always applicable: variation and choice (of contact between susceptible and infected individuals) should be considered as part of the epidemic process. **Stochastic** modelling, which includes the **probability of infection**, therefore evolved. This leads to results that have a probability distribution from which means, variances and probability intervals can be derived. The deterministic and stochastic approaches may produce a different result when modelling a simple epidemic (Figure 19.5); the deterministic curve represents the absolute point estimates. The stochastic curve represents the mean of all the values generated by the various probabilities.

### Stochastic exponential decay paradigm

A stochastic analogue of the deterministic model for the changing number of susceptibles in a population, described above, can be formulated. As before,  $x_t$  denotes the number of susceptibles in the population at time  $t$ , and  $N$  the number at time 0. It is now assumed that  $x_t$  is a random variable and the probability of  $r$  susceptibles at time  $t$  is denoted by  $p_r(t)$ . A differential calculus approach, similar to that used in the deterministic model, can be applied to obtain an expression for the rate of change of  $p_r(t)$ . This rate of change,  $dp_r(t)/dt$ , will be influenced by flows in from the state  $r + 1$  and flows out from the state  $r$ . For state  $r + 1$  to have a flow in, there must be two events: first, there must be  $r + 1$  susceptibles at time  $t$ ; secondly, one of these susceptibles must leave. The probability of these two events is  $\alpha(r + 1)p_{r+1}(t)$ . For state  $r$  to have a flow out, there must be  $r$  susceptibles at time  $t$  and one susceptible must leave. The probability of these two events is  $\alpha r p_r(t)$ . The instantaneous rate of change of  $p_r(t)$  is therefore:



**Fig. 19.6** Mean (—) and 95% probability interval (---) for the number of susceptibles in the stochastic exponential decay paradigm.

$$\frac{dp_r(t)}{dt} = \alpha(r + 1)p_{r+1}(t) - \alpha r p_r(t)$$

where  $\alpha$  is a parameter.

The solution to such a differential equation may not be easily obtained, but standard methods for solving are available. These methods lead to an expression for  $p_r(t)$  in terms of  $t$ :

$$p_r(t) = {}^N C_r (1 - e^{-\alpha t})^{N-r} e^{-\alpha t r}$$

where  ${}^N C_r$  is a mathematical shorthand notation for  $\frac{N!}{r!(N-r)!}$ .

The expression for  $p_r(t)$  is known as the time-dependent binomial probability distribution from which it can be deduced that  $x_t$  has mean value  $N e^{-\alpha t}$  and variance  $N e^{-\alpha t} (1 - e^{-\alpha t})$ . Comparing these results with those of the deterministic model, it can be seen that the mean value of  $x_t$  is identical to the solution obtained before. This is often, but not always (Figure 19.5), true of deterministic and stochastic models. However, an important distinction between the deterministic and stochastic model is that the latter provides a variance; therefore, the extent to which population susceptible numbers fluctuate at each point in time can be deduced. Figure 19.6 illustrates this point, where the mean of the number of susceptibles at each point is shown along with the 2.5th and 97.5th percentiles (see Chapter 12) of the distribution of the number of susceptibles. This provides a 95% probability interval for the number of susceptibles. The wider the probability interval, the greater is the range of observed deviations from the mean number of susceptibles.

### Empirical simulation modelling

The goal of this technique is **simulation** of the performance of parasites or diseases in relation to conditions



that change either deterministically or stochastically. Although simulation models do not always require a computer for implementation, their power and success have been closely linked to advances in computer technology. Many simulations undertaken today would have been impossible 50 years ago.

Successful simulation models have the potential to accurately forecast disease incidence. These forecasts, like those possible using time series analysis (see Chapter 8), are of value in selecting suitable prophylactic procedures.

Empirical models utilize indicators that are obtained by analysing the relationship between morbidity and any associated variables. Frequently used variables are those relating to climate. These models are not strictly mathematical models because they do not attempt to analyse the dynamics of agents' life-cycles, but simply quantify associated phenomena. They are sometimes referred to as 'black-box' models because the relationship between data that are fed into the model and the results that are generated cannot be satisfactorily explained.

### Fascioliasis

Fascioliasis has been modelled empirically in Britain (Ollerenshaw and Rowlands, 1959; Ollerenshaw, 1966; Gibson, 1978). The life-cycle of *Fasciola hepatica* is complex, involving stages inside a final and intermediate host, and on herbage. Two important meteorological factors in the development of the parasite are temperatures above 10°C and the presence of free water. In the late 1950s, Ollerenshaw suggested that development is therefore usually impossible during the winter (too cold) and that there may be insufficient water during some of the summer months (too dry). This is the basis of the 'Mt' forecasting system for fascioliasis. Mt is a monthly index of wetness given by:

$$(R - p + 5)n,$$

where, on a monthly basis:

- R = rainfall in inches,
- p = potential transpiration,
- n = number of rain days.

Observations suggested that, because parasite development is also temperature-dependent, the rate of development is similar in June, July, August and September, but is halved in May and October, when the Mt index should therefore be halved.

A seasonal summation of Mt indices ( $\Sigma Mt$ ) can be calculated by adding the Mt values for the 6-month period May to October. This sum simulates the progression of the disease in relation to changing meteorological conditions and so can be used to predict losses owing to fascioliasis, so that suitable prophylactic measures can be undertaken (Table 19.1).

**Table 19.1** Associations between  $\Sigma Mt$  values\* and losses owing to fascioliasis in England and Wales. (Data from Ollerenshaw, 1966.)

$\Sigma Mt$		Losses
North-west England, south-east England and north Wales	Other parts of England and Wales	
<300	<400	No losses
300–450	400–450	Some losses
>450	>450	Heavy losses

\* See text for explanation.

This prediction model is deterministic because no element of randomness is included in the formulation. Its simple approach enables its execution without a computer. The model was adapted for use in France (Leimbacher, 1978) and Northern Ireland (Ross, 1978).

### Process simulation modelling

Mathematical models that describe the dynamics (i.e., biological processes) of parasite and host populations have been formulated. These more refined techniques allow the course of a disease to be simulated. They include models for forecasting fluke morbidity (Hope-Cawdery *et al.*, 1978; Williamson and Wilson, 1978), the airborne spread of foot-and-mouth disease (Gloster *et al.*, 1981) and the occurrence of clinical ostertagiasis.

### Bovine ostertagiasis

The level of pasture contamination by infective *Ostertagia ostertagi* larvae can be predicted by simulating the course of events experienced by cohorts of parasite eggs deposited on pasture (Gettinby *et al.*, 1979). This involves estimating the proportion of eggs that proceed to the first, second and third larval stages using **development fractions**, which quantify the rate of development of the parasite from one stage to the next according to the temperatures that it experiences. In addition, parameters associated with infectivity, fecundity and migratory behaviour of the larvae must be included.

Thus, suppose a calf commences grazing on contaminated grass on 1 April. The number of infective larvae,  $L$ , ingested on 1 April can be estimated from known pasture contamination levels and the daily herbage intake of the calf. Not all larvae become established. The number of adult worms,  $A$ , to be expected in the abomasum of the calf 21 days later on 22 April is modelled using:

$$A = (K - A_0)(1 - e^{-\alpha t}) + A_0$$

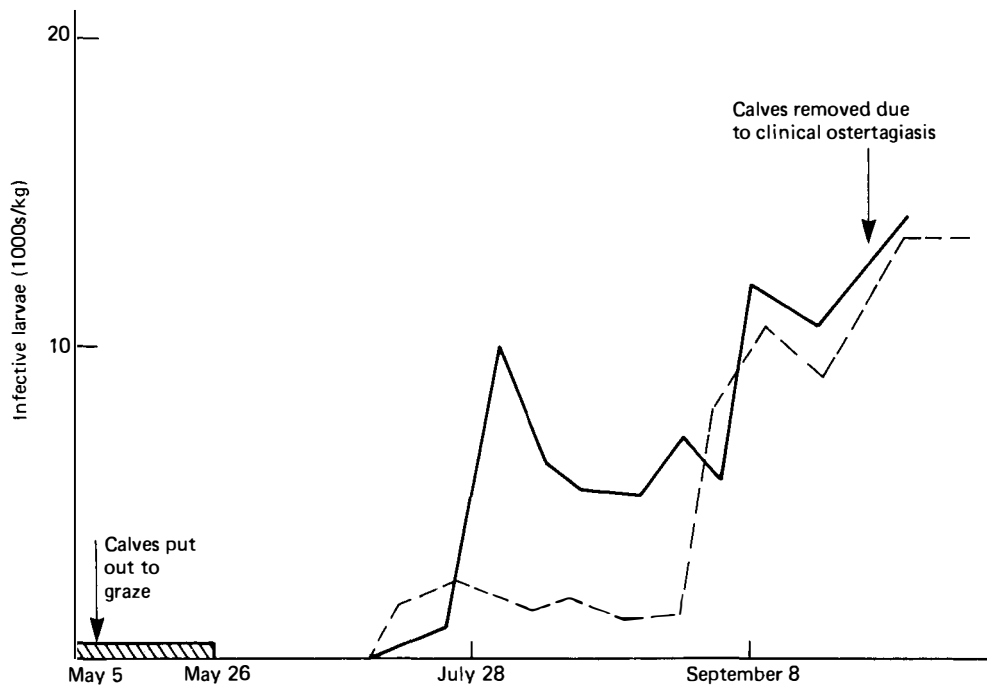

Fig. 19.7 Observed and predicted counts of infective *Ostertagia ostertagi* larvae on pasture in 1975. — Observed pasture count; --- predicted pasture count; ▨ overwintered infective larvae. (From Gettinby *et al.*, 1979.)

where  $A_0$  is the number of adults already in the abomasum. The curve of  $A$  for different values of  $L$  is sigmoidal, reflecting the assumed density-dependent relationship between larval challenge and establishment of adult worms (see also Figure 7.4). The parameters  $K$  and  $\alpha$  control the rate of establishment so that the proportion established is high for low levels of challenge and low for high levels of challenge. The adult worms will produce eggs on 1 April and thereafter. The number of eggs,  $E$ , produced on 22 April is estimated from empirical data relating egg output to adult worm burden. These eggs undergo development. The time to the appearance of infective larvae is estimated by calculating from daily temperatures the fraction of development to take place each day and summing these fractions until all development has occurred  $n$  days later:

$$\frac{1}{D_1} + \frac{1}{D_2} + \dots + \frac{1}{D_n} = 1$$

where the  $D$ s are the number of days that would be required to complete development under conditions of constant temperature. Adding  $n$  to 22 April gives the earliest day on which the infective larvae can appear. Not all developing eggs and larvae survive and so the number of eggs that avoid mortality is the proportion,  $p^n$ , of the egg output on 22 April. The parameter  $p$  is an estimate of the daily survival rate. If the values of  $n$  and  $p^n$  are determined for each day during which the calf grazes, then it is possible to estimate the expected

totals of infective larvae on pasture and the number of adult worms infecting the calf. This type of simulation requires iterative calculations, which can only be performed in a reasonable time by using a computer.

Figure 19.7 shows the results of such a simulation for calves that grazed on an experimental pasture from May to September 1975. Comparison of predicted and observed larval counts shows a high degree of similarity.

A prediction of herbage infective larval burdens using this type of simulation model can facilitate optimum use of anthelmintics, and movement of animals to safe pasture before challenge by large numbers of infective larvae, thereby preventing clinical ostertagiasis. A similar approach has been successfully applied to ovine ostertagiasis (Paton *et al.*, 1984) and tick infestations of sheep (Gardiner and Gettinby, 1983).

### Monte Carlo simulation modelling

In many cases deterministic and stochastic models can be formulated for which no analytical solution is known. Alternatively, finding the solution may be extremely difficult or tedious. In such circumstances, simulation methods are increasingly being undertaken. Since simulation studies attempt to mimic the physical process being modelled, they can be very informative and therefore are often preferred. In these methods, random processes are simulated using

**Table 19.2** Possible number of mated female *Ixodes ricinus* on one sheep, resulting from simulated attachment and sex distribution of the tick population.

Outcome from one throw of a ten-sided die	Simulated number of engorged ticks on a sheep	Simulated sex distribution of engorged ticks from coin tosses	Number of mated females
{1,2,3,4}	0	–	0
{5,6,7}	1	M	0
		F	0
{8,9}	2	MM	0
		MF	1
		FF	0
		FM	1
{10}	3	MMM	0
		MMF	1
		MFM	1
		FMM	1
		FFF	0
		FMF	1
		MFF	1
		FFM	1

random numbers in order to decide whether or not an event takes place. This is somewhat akin to gambling; hence the term **Monte Carlo** simulation.

### Sheep tick paradigm

Suppose a model is to be formulated for the outcome of adult ticks of the species *Ixodes ricinus* mating on the sheep host. In particular, a measure of the total number of female ticks is required so that future population numbers can be anticipated. Suppose a field study indicates that the total number of engorged ticks found on individual sheep is 0, 1, 2 or 3, and suppose that the respective probabilities are 0.4, 0.3, 0.2 and 0.1. The field study also suggests that male and female ticks are present in equal proportions. Using a fair ten-sided die with faces labelled 1 to 10, and a fair two-sided coin with faces labelled M for male and F for female, it is possible to simulate and obtain the number of mated female ticks on each sheep. The die is thrown and, depending on which of the sets {1,2,3,4}, {5,6,7}, {8,9} and {10} the outcome belongs to, the simulated number of adult engorged ticks on the sheep is taken to be 0, 1, 2 or 3, respectively. The above sets are chosen because the outcomes 0, 1, 2 and 3 will occur with probabilities 0.4, 0.3, 0.2 and 0.1, respectively, which is consistent with the results of the field study. Suppose the outcome of the throw of the die is a 10, the simulated number of adult engorged ticks on the sheep is then 3. The coin is now tossed three times and the outcomes used to simulate the sex of the three adult engorged ticks. In the event of all three ticks having the same sex (i.e., outcomes MMM or FFF), there will be no mated females. All other outcomes will lead to at least one male and one female on a sheep and, assuming that

one male mates only with one female, there will be only one mated female. Table 19.2 shows the possible combinations of the outcomes of the throw of the die and the coin tossing.

The procedure can be repeated for each sheep to obtain a series of 0s and 1s reflecting the outcomes of the attachment and sex distribution of the tick population on the sheep flock. To summarize the results of the simulation: the proportion of the flock with 1 or 0 mated female ticks could be reported. When the simulation is carried out, it is found that, on average, only 18 out of every 100 sheep are hosts to one mated female tick. A sensitivity analysis<sup>3</sup> could also be undertaken to test the effects of different assumptions or parameter estimates on the outcomes. For instance, if the ratio of male to female ticks was no longer 1:1 but biased towards females, in the ratio 1:2, then the study could be repeated using a biased coin that would give an M outcome with probability 0.33 (1/3) and an F outcome with probability 0.67 (2/3) when tossed. The simulation then leads to an average of 15 out of every 100 sheep hosting one mated female tick. Comparison of the results suggests that the analysis is not very sensitive to changes in the sex distribution; consequently further field studies to accurately determine the sex ratio are not warranted. Similarly, if it was thought that male ticks could mate with several females, then the simulation could be repeated. If, for example,

<sup>3</sup> The extent to which changes in values of an input parameter affect output parameters is assessed by **sensitivity analysis**. If minor changes in values of an input parameter induce major changes in output parameters, then the model is highly sensitive to that input parameter. Conversely, if major changes in an input parameter induce only minor changes in output parameters, then the model is relatively insensitive to the input parameter.

attachment led to the combination of one male and two female ticks on a sheep, then this would produce two, rather than one, mated females.

In modern simulation studies the computer takes over the role of the die and the coin. Thus, the results of these 'lotteries' are produced by replacing throws of a 10-sided die with an instruction to the computer to produce integer numbers from 1 to 10 in random order such that a large series of generated numbers would produce each of these numbers in equal proportions.

### Sheep tick control

Monte Carlo simulation can be used to investigate the behaviour of a stochastic model for the incidence of tick mating which could be of value to control strategies (Plowright and Paloheimo, 1977). Field investigations (Milne, 1950) revealed that tick occurrence was patchy: a pasture may have a heavy burden whereas an adjacent field separated from the first only by a fence may have no ticks. This suggested that ticks have problems with effective dispersal. One reason may be that at low densities tick population growth is inhibited by a low rate of mating. The model proposed makes several assumptions: that each adult only mates if it encounters an individual of the opposite sex on the sheep to which it is attached; that each adult only mates once; that each tick has an equal probability of attaching to a sheep; that all ticks have an equal probability of encountering one another. The last two assumptions are dubious but do not affect the model appreciably.

The total number of matings at various sheep densities, and with varying numbers of ticks on each sheep, can be modelled by applying a Poisson distribution (see Chapter 12). Table 19.3 lists the results and demonstrates the difference between the stochastic and deterministic output. By including a rate of survival in the model, it is possible to predict the growth rate of the tick population for different levels of tick population size and sheep density. When the sheep population is low, the rate of tick population increase is insensitive to changes in the size of the tick population, but highly sensitive to changes in the size of the sheep population. Conversely, when the tick population is low, the rate of tick population increase is relatively insensitive to changes in sheep numbers, but sensitive to changes in tick numbers. This supports the hypothesis that it is difficult for ticks to establish themselves in new pastures. It also suggests that a reduction in host density may not be an effective means of controlling tick infestation because the rate of tick population increase does not always depend on sheep density. The model also predicts that extinction of the tick population takes place over a narrow range of tick population sizes, corroborating field observations of patchy tick distribution.

**Table 19.3** Comparison of the results of deterministic and stochastic models of incidence of mating in *Ixodes ricinus* for various parameter values. (From Plowright and Paloheimo, 1977.)

$p$	Number of ticks	Number of sheep	Total number of matings	
			Deterministic model	Stochastic model (mean of 600 replications)
0.05	40	10	3.3357	3.4400
0.05	40	20	4.7532	4.7833
0.05	40	40	5.1271	5.1533
0.05	40	80	3.9683	3.8395
0.05	40	160	2.2143	2.2117
0.05	80	10	8.9590	9.0883
0.05	80	20	13.2866	13.4567
0.05	80	40	15.3686	15.5733
0.05	80	80	12.6488	12.8450
0.05	80	160	7.9323	8.0050
0.01	40	10	0.3021	0.2933
0.01	40	20	0.5528	0.5567
0.01	40	40	0.9282	0.9017
0.01	40	80	1.3279	1.2733
0.01	40	160	1.4345	1.4633
0.01	80	10	1.0342	1.0017
0.01	80	20	1.8993	1.9483
0.01	80	40	3.2270	3.0550
0.01	80	80	4.7108	4.5867
0.01	80	160	5.2683	5.3367

$p$  = probability of a tick attaching to a sheep.

### Matrix population modelling

The use of **matrices** to describe population changes became firmly established when Leslie (1945) first published his Leslie matrix. Matrices often take the form of a rectangular array containing numbers of hosts or parasites in a defined state or stage of development, known as the **state vector**, or containing reproduction and survival rates of hosts or parasites in different states or stages known as the **transition matrix**. In this way, it is possible to obtain the state of the system from one point in time to another.

### Fascioliasis

The life-cycle of *Fasciola hepatica* can be used to illustrate the formulation of a simple matrix model. The parameters have been estimated from field studies. It is assumed that eggs from the adult fluke develop to miracidia after 4 weeks, that miracidia that penetrate the molluscan host, *Limnea truncatula*, develop and emerge as metacercariae 8 weeks later, and that the metacercariae can survive up to 3 weeks before desiccation. The weekly survival rates of the adult flukes, the developing eggs, the stages in the snail, and the metacercariae are 0.95, 0.3, 0.5 and 0.8, respectively.



where  $n_i(t+1)$  is the number in the  $i$ th class at time  $t+1$ , and  $f_i$  and  $p_i$  are respectively the fecundity and survival rates for age class  $i$ .

The advantage of the matrix approach is that, once  $\underline{P}$  and the numbers for the state vector at time 0 are known, then the population sizes at any future time can be predicted. For example, the population numbers after four units of time could be obtained from the successive calculations:

$$\begin{aligned}x_1 &= \underline{P} x_0 \\x_2 &= \underline{P} x_1 \\x_3 &= \underline{P} x_2 \\x_4 &= \underline{P} x_3\end{aligned}$$

The matrix equations described above have many interesting properties from which the salient features of the population can be investigated. Details of these are given by Leslie (1945).

A more realistic matrix representation of the life-cycle of *F. hepatica* was discussed by Gettinby and McClean (1979). This is a state-transition model with five states: mature flukes (in sheep), eggs (on grass), rediae (in snails), metacercariae (on grass), immature flukes (in sheep). A mortality rate is attached to all stages, and fecundity to the adult fluke and redia, which reproduce sexually and asexually respectively. The matrix includes probabilities of transition from one stage to the next, and fecundity, based upon available field data. The first part of the model describes the natural infection in sheep in Britain and Ireland. The second part investigates and compares various control strategies: the use of flukicides, molluscicides and land drainage. There are three conclusions. Molluscicides are most effective when applied in early spring. Flukicides eradicate the infection when given monthly and control it when given at 2-monthly intervals. If dosing is only annual, then it is best given in August. Good drainage is an effective means of control. Again, the model only indicates possible outcomes, in the absence of accurate field data to support the values of the input parameters in the model.

## Network population modelling

The inability of many other models to cope with changing inputs during the period of operation of the model can be circumvented using a **network** representation of a parasite's life-cycle. Network models, although extensively exploited by control engineers, have been largely overlooked in the life sciences, with some exceptions (Pearl, 2000). The same problem often can be formulated using a network and a matrix approach. The network formulation is particularly attractive when time delays are a feature of the life-cycle being modelled, and when the output response of a

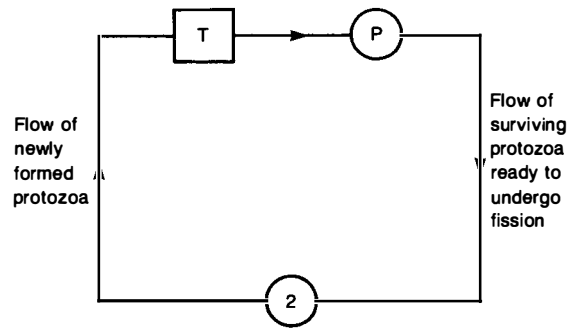

Fig. 19.8 Network representation in the protozoal paradigm.

biological system is to be measured for a given input. On the other hand, matrix formulations are attractive when the behaviour of several states of a population is of interest at successive points in time. Some elementary examples will demonstrate the symbolism used in the network approach.

### Protozoal paradigm

Consider a population of identical protozoa that reproduce by binary fission. A constant  $T$  units of time occurs between successive fissions. The probability that any one protozoon survives this time is  $P$ . To construct the network shown in Figure 19.8, which represents the life-cycle, consider the flow of newly formed protozoa in the population. After a time delay,  $T$ , only a proportion,  $P$ , of these survives. This results in the flow after the time delay being scaled by a factor  $P$ . This is immediately succeeded by fission, which results in the flow doubling and so a further scaling by a factor 2 is required. The network convention is to denote time delays by squares and scaling parameters by circles. Since the products of fission are newly formed cells, this flow is connected back into the time delay. This is a very simple network and consists of one loop and no alternative paths.

### Ostertagiasis

A network can be constructed for the life-cycle of *Ostertagia circumcincta*, an important parasite responsible for outbreaks of parasitic gastroenteritis in sheep (Paton and Gettinby, 1983). The network is shown in Figure 19.9. The unit of time is 1 week. Ewe and lamb egg inputs,  $X(i)$  and  $Z(i)$ , voided out to the pasture in week  $i$ , undergo a time delay of  $\Gamma_1$  (gamma) weeks before infective  $L_3$  larvae appear. The proportion that survive is  $a$ . During the following week, these  $L_3$  larvae, plus available over-wintered infective larvae  $Y(i)$ , either become ingested by the sheep to become adults at rate  $c$ , or accumulate on the pasture at rate  $1 - c$ .

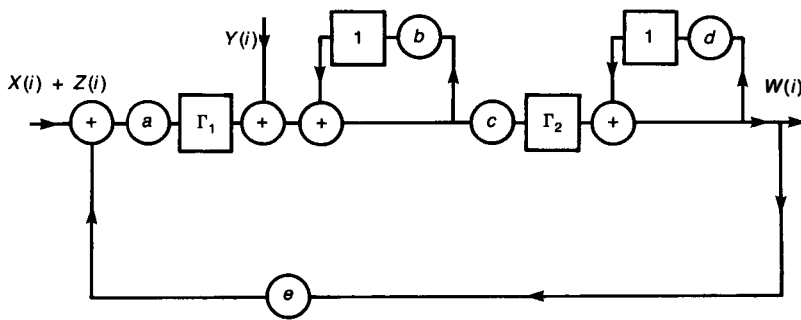

**Fig. 19.9** Network representation of the life-cycle of *Ostertagia circumcincta* showing adult parasite output,  $W$ , derived from ewe egg input,  $X$ , lamb egg input,  $Z$ , and overwintered infective larval input,  $Y$ . The constants  $a$ ,  $b$ ,  $c$ ,  $d$  and  $e$  are parameters of survival, infectivity and fecundity;  $\Gamma_1$  and  $\Gamma_2$  are time-delays representing parasitic development times on the pasture and in the lamb, respectively. (Modified from Paton and Gettinby, 1985.)

Those that accumulate are delayed for 1 week, during which their survival rate is  $b$ , before joining the flow of new infective larvae. The  $L_3$  larvae that were ingested are delayed for  $\Gamma_2$  weeks before reaching the adult egg-laying stage. Half of these adults will be females, which reproduce at a rate of  $e$  eggs per week. From successive egg cohorts, female adults will accumulate from week to week. To facilitate the accumulation, the existing females must enter a feedback loop in which the weekly survival rate is  $d$ , and which connects them with the flow of new female adult worms in the sheep. The network therefore consists of a forward loop and two feedback loops.

When the model is operated, the effects of various anthelmintic strategies can be investigated by altering components of the network that will be affected by the particular strategy. For example, dosing of lambs will reduce the lamb egg input, and dosing of ewes will decrease the ewe egg input. The simulation suggests that regular dosing of lambs at 4-weekly intervals for the first 6 months of life is very effective. Similarly, dosing lambs three times in July and August is effective. The single administration of an anthelmintic to ewes at lambing time is the least effective of the anthelmintic strategies.

## Systems modelling

'Modelling' now has a broad remit, including the conceptual representation of any real event in mathematical terms. Models that assess the cost of disease and its control have also been designed; some of these have been reviewed by Beal and McCallon (1983) and Dykhuizen (1993). Models of livestock feeding have been formulated (Theodorou and France, 2000), and Sørensen and Enevoldsen (1992) review models of herd health and production. Increasingly, models are being linked together to produce large-scale **systems models**. An example is EpiMAN (see Chapter 11).

A bibliography of veterinary models, including a discussion of model classification, is given by Hurd and Kaneene (1993).

## The rational basis of modelling for active disease control

Many veterinary models have been used to explore the dynamics of disease in order to produce options that might be selected to control disease (e.g., Medley, 2003). However, they may not have faced the critical test of being applied when disease actually occurs. In some cases, they *have* served as policy guides during actual outbreaks of disease. For example, the 2001 epidemic of foot-and-mouth disease in the UK was characterized by a policy to pre-emptively cull cattle on premises contiguous to infected premises, on the basis of model formulations that predicted that this would be an efficacious tactic for control (Ferguson *et al.*, 2001; MAFF, 2001). A consideration of the conditions under which the validity and appropriateness of a model may be judged is therefore a necessary complement to knowledge of the types of models that have been described.

## Available knowledge, and the functions of models

The validity of a model is determined by the level of **epidemiological knowledge** about a disease's natural history, and the **quality and quantity of data** relating to the disease (Graat and Frankena, 2001; Taylor, 2003). For example, models of airborne transmission of infection (see Chapter 6) require information on microbial output from hosts and host susceptibility (epidemiological knowledge), and details of stock distribution (data quality and quantity) in order to predict transmission accurately.

Levels of knowledge can be conveniently classified as 'poor' and 'good', so that a general framework for the application of models can be identified (Table 19.5). This defines four main applications of models:

1. development of hypotheses;
2. hypothesis testing;
3. elementary explanation of past events; and

**Table 19.5** Uses of models in the context of epidemiological knowledge and data quality and quantity. (Modified from Taylor, 2003; based on Holling, 1978.)

Epidemiological knowledge	Data quality and quantity	
	Poor	Good
Poor	Exploration of hypotheses	Hypothesis testing
Good	Simplified representation of past events, and <i>guarded</i> use for prediction of future events	Detailed representation of past events, and prediction of future events

#### 4. detailed representation of past events, and prediction.

The applications span not only the model formulations outlined in this chapter but also other numerical analytical procedures such as observational studies (Chapter 15). In reality, levels of knowledge are continua, and so a considerable degree of judgement may be required in assessing the particular role of a model.

### Development of hypotheses

Hypotheses can be developed when epidemiological knowledge is poor and good data are not available. For example, case-control studies using retrospective veterinary clinic data that cannot be validated might be used to explore possible intrinsic determinants of disease, such as breed, age and sex; these studies may then be succeeded by prospective studies with careful control over the quality of the data that are collected. However, this is an uncommon modelling strategy because most modellers usually begin at least with formulations that depend on an underlying hypothesis. For example, the sheep vaccination paradigm is based on the hypothesis that the number of susceptible sheep decays exponentially (Figure 19.2).

### Hypothesis testing

Availability of good data allows hypotheses to be tested by fitting observations to associations or relationships that are hypothesized to exist. Prospective observational studies frequently follow this approach, carefully validating data as they accrue.

### Elementary explanation of past events

A sound understanding of the natural history of disease may be attenuated by lack of high-quality data. For example, the vulpine rabies model described earlier incorporates the major characteristics of the transmis-

sion of the disease. However, accurate data on contact rates are not usually available. Thus, the model may be used to explain previous patterns of disease with assumptions about putative contact rates. However, its use to predict future disease patterns would need to be *very guarded* because of the lack of information on current parameter levels in the field.

### Detailed representation of past events, and prediction

The availability of high-quality data, linked to a detailed understanding of the functioning of a system, enables both the accurate representation of past events quantitatively, and sound predictions of future events to be made. A good non-veterinary example is the use of aircraft flight simulators to train pilots. However, this is an example from the physical sciences, which are subject to fewer laws and are usually less complex than biological systems, which display considerable variability. Notwithstanding the weaknesses of inductive reasoning, on which much of science is based (see Chapter 3), in practice the accurate prediction of future complex biological events (including disease occurrence) is difficult, although the past may be modelled accurately. The difference between theory, hypothesis and fact – with which models might be labelled – and the strength of evidence and criteria required to shift from theory to fact, should therefore be appreciated.

### From theory to fact<sup>4</sup>

#### Scientific theories

A theory is a supposition that explains something. It cannot be proved in the sense that propositions in logic and mathematics can. However, *certain* scientific theories are held with much more confidence than others. The confidence one has in any particular theory, such as the Second Law of Thermodynamics, the atomic theory of matter, or the microbial theory of the cause of infectious disease (see Chapter 1), depends on several factors, including how **well tested** the theory is, and how **often** and how seriously this testing has refuted the theory. For example, the theories behind weather forecasting – particularly long-range forecasting – are quite often refuted, thereby reducing the confidence held in future forecasts.

The ‘**testedness**’ of a theory is difficult to define closely: the concept implies more than just a large

<sup>4</sup> This section may be considered as a logical continuation of Chapter 3. Moreover, it is applicable to all areas of epidemiological investigation (e.g., observational studies and clinical trials). It is presented here because of its particular relevance to models that may claim to predict future events, and, in so doing, might be interpreted as factual descriptions of the future.



number of repetitive tests. For example, one might well make 10 000 observations of the Sun, and never observe an eclipse. Yet one would not hold with any confidence the theory that 'the path of the moon never lies between the Earth and the Sun'<sup>5</sup>. To be well tested, a theory should have given predictions of what should happen in a variety of different circumstances. If these predictions were extensively tested over a wide range of conditions (either in the field or experimentally), then the theory can be called well tested.

Besides 'testedness', a theory can be characterized by other attributes, although there is no general agreement on what these are. In addition to 'testedness', four have been listed (Davies, 1973):

1. **generality**: that is, the unification of existing concepts that is achieved; the greater the unification, the more 'fundamental' the theory is said to be;
2. **simplicity**: that is, the ability of a theory to be easily tested;
3. **precision**: that is, its ability to generate precise predictions;
4. **'refutedness'**: that is, the extent to which it is inconsistent with previous tests, or its inconsistency with established data<sup>6</sup>.

Bertrand Russell viewed 'refutedness' in terms of 'external confirmation': the theory must not contradict empirical facts. However evident this demand may appear in the first place, its application turns out to be quite delicate. For it is often – perhaps even always – possible to adhere to a general theoretical foundation by securing the adaptation of the theory to the facts by means of artificial additional assumptions. This point of view is concerned with the confirmation of the theory by the available empirical facts.

The confidence that one has in a theory clearly depends on the relative importance attached to these characteristics<sup>7</sup>. Karl Popper (Chapter 3), for example,

focused on 'testability' in situations of potential refutation. In epidemiology generally, emphasis has been placed on precision and 'refutedness', whereas some mathematical models might also suggest generality (e.g., the basic reproductive number: Chapter 8).

The relative importance of these characteristics may also be determined by the two broad functions of models: **strategic** or **tactical** (Holling, 1966). Strategic models explore general issues (e.g., the principles underlying spread of disease within populations), whereas tactical models address specific problems (e.g., the practical control of a specific epidemic). Strategic models sacrifice detail for generality (Levins, 1966), whereas tactical models may be loaded with so much detail that they become difficult to use and interpret (Thulke *et al.*, 1999). Moreover, the structure of strategic models may not assist the tactical modeller.

Thus, the value of a mathematical model, as a theory, should be judged in the context of these five attributes ('testedness', generality, simplicity, precision, 'refutedness') and its function. It is only after such judgement that a model may be deemed to be more than mere hypothesis.

### Hypotheses and laws

Hypotheses and scientific laws are special cases of theories. A **hypothesis** is a theory of low generality and low 'testedness'. Many initial formulations of models of specific diseases therefore involve hypotheses.

A scientific **law** is a theory that is reasonably general, simple, and well tested (and its 'inner perfection' therefore is consequently never low). Although some mathematical models may appear to fulfil the first two criteria (e.g., the exponential decay paradigm), they often fail the last criterion.

### Facts

A **fact** is held with very high confidence. Theories that are neither very general nor very precise can be held with great confidence if they are well tested but never refuted; they therefore are facts (e.g., the fact that the Earth is round). Theories therefore may become facts if, after much further testing, they were repeatedly confirmed but never refuted. Using these criteria, currently no mathematical models constitute facts.

### Model-building

Model-building requires several steps (Figure 19.10), detailed by Dent and Blackie (1979), Martin *et al.* (1987) and Taylor (2003).

First, the **objectives** of the model must be clearly specified. Thus, a model of the windborne transmission

<sup>5</sup> This is reminiscent of Russell's 'inductivist turkey' (see Chapter 3).

<sup>6</sup> There are other aspects of a theory, which tend to be somewhat abstract and more suited to pure science. Thus, Albert Einstein was concerned with the 'inner perfection' of a scientific theory: an intellectual elegance, which is aesthetic rather than utilitarian. Similarly, theories underpinned by Euclidian geometry, Newtonian dynamics and the mathematical form of Maxwell's electromagnetism are deemed to be 'beautiful' (Penrose, 2004). 'Testedness' and 'refutedness' are not involved in this idea of 'inner perfection'; however, generality and simplicity are. This is relevant to assessing if one theory is 'better' than another. The better one requires a high degree of confidence, and the 'inner perfection' should be as high as possible (i.e., the generality, simplicity and 'predictiveness' should be as high as possible). Thus, progress in pure science aims at an improvement of 'inner perfection', while also maintaining a reasonably high confidence in the theory. The goal of modern theoretical physics, for example, is to identify a 'Theory of Everything', which will rationalize the various Laws operating in the Universe in a simple, elegant unity (Laughlin and Pines, 2000).

<sup>7</sup> Formulations have been developed to 'measure' these attributes, and therefore the impact of their various combinations on a theory's merit (Davies, 1973).

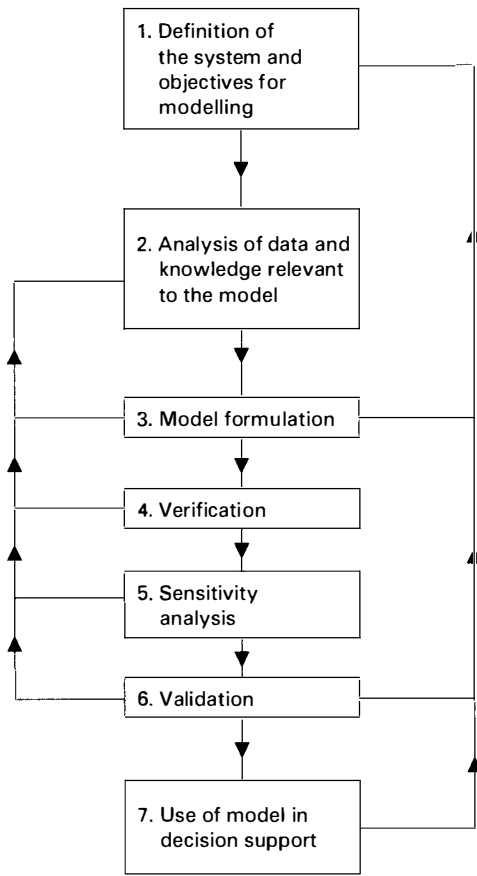

Fig. 19.10 Stages in model-building. (Modified from Taylor, 2003.)

of Aujeszky's disease may have as its goal prediction of the farms likely to be exposed to infective virus plumes.

Secondly, details of the **data** and **knowledge** to be included as input parameters to the model are needed. Meteorological variables determining conditions favourable to long-distance transmission of virus, levels of virus excretion from infected pigs, and location of susceptible pigs, for example, would be required in the Aujeszky's disease transmission model. This will then enable the main framework of the model, including the relationships between all of the parameters, to be determined. It is important at this preliminary stage for dialogue to occur between the modellers and those with expert biological knowledge of the candidate disease (e.g., microbiologists, field veterinarians, and epidemiologists)<sup>8</sup>.

Next, the model is **formulated**; for example, using some of the modelling approaches described earlier in this chapter.

Fourthly, the model is **verified** by undertaking checks to confirm that the type of output anticipated by its design is generated.

A **sensitivity analysis** is then undertaken (see earlier). This is particularly important if the model is sensitive to input variables based on data of doubtful quality, because they could lead to erroneous predictions. Additionally, sensitivity analysis is of benefit in determining the stability of the model in relation to the known variability of input parameters (e.g., the ratio of male to female ticks in the sheep tick paradigm, above).

The model then needs to be **validated**<sup>9</sup>. Initially, affirmative answers to four questions will support a model's validity:

1. Have all the known determinants that influence occurrence of the disease been included?
2. Can the value of these determinants be estimated with accuracy?
3. Does the model make biological 'common sense'?
4. Does the model behave in a mathematically reasonable way (i.e., is it sensitive to biologically relevant variables)?

Validation therefore involves establishing if the model behaves like the actual biological system that it is designed to mirror; for this, two conditions must be met (Spedding, 1988):

1. the model is assessed against data not used in its construction; and:
2. the precision of the model is specified in advance, noting that there is likely to be variability in the behaviour of the biological system.

The first condition may be difficult to fulfil; notably, when there is a paucity of data (e.g., if rare epidemics are being modelled). This will also limit its 'tested-ness'. The second condition is eased by stochastic formulations, which provide confidence intervals for outputs as measures of error bounds.

The validity of a model may be ultimately assessed in terms of its usefulness (Green and Medley, 2002; Hugh-Jones, quoted by Salman, 2004), the key feature being whether decisions made with the model are more correct than those made without it (Dent and Blackie, 1979).

If the model is deemed to be adequate, it can be used to **support decisions**, or become part of a larger decision support system (e.g., the EpiMAN: see Chapter 11), noting its suitability to particular roles (*Table 19.5*).

<sup>8</sup> A meeting of various experts, designed to produce a consensus on all available relevant knowledge, is sometimes termed a 'Delphi Conference' (named after the Classical Greek oracle at Delphi). Modern Delphi conferences usually have well defined rules of engagement for the purpose of knowledge elucidation.

<sup>9</sup> The importance of validation cannot be emphasized enough, particularly when models' consequences have a profound impact on society, as was the case with those relating to the 2001 foot-and-mouth disease epidemic in the UK (Kitching, 2004; Pfeiffer, 2004).

The model-building strategy addresses the main issues in assessment of a theory: generality, simplicity, precision, 'refutedness' and 'testedness'. The extent to which models perform against these criteria determines the degree to which they may be legitimately and widely applied.

Finally, models cannot stand alone in determining efficient control strategies, but should be used in conjunction with accurate field data and experimentally derived data relating to diseases' natural history. The dangers of applying modelling in isolation from traditional field observation have been noted, both in human epidemiology – in the context of a reappraisal of Snow's classical investigation of cholera (Cameron and Jones, 1983) – and in veterinary epidemiology (Hugh-Jones, 1983). Indeed, models should incorporate veterinary knowledge and experience, and, as such, should be a 'collective veterinary brain'. Otherwise, they may become exercises in mathematical sophistry.

### Further reading

- Ackerman, E., Elveback, L.R. and Fox, J.P. (1984) *Simulation of Infectious Disease Epidemics*. Charles C. Thomas, Springfield
- Anderson, R.M. and May, R.M. (1991) *Infectious Diseases of Humans: Dynamics and Control*. Oxford University Press, Oxford (Includes a comprehensive description of the basic models)
- Anderson, R.M. and Nokes, D.J. (1991) Mathematical models of transmission and control. In: *Oxford Textbook of Public Health*, 2nd edn. Vol. 2. Eds Holland, W.W., Detels, R. and Knox, G., pp. 225–252. Oxford University Press, Oxford (An introduction to mathematical modelling of infectious diseases and their control, with emphasis on human infections)
- Bailey, N.T.J. (1975) *The Mathematical Theory of Infectious Diseases and its Applications*, 2nd edn. Charles Griffin, London
- Barnes, B. and Fulford, G.N. (2002) *Mathematical Modelling with Case Studies*. Taylor and Francis, London and New York. (An introduction to modelling using differential equations, including some medical and veterinary examples)
- Becker, N.G. (1989) *Analysis of Infectious Disease Data*. Chapman and Hall, London. (An introduction to models of infectious diseases)
- Black, F.L. and Singer, B. (1987) Elaboration versus simplification in refining mathematical models of infectious disease. *Annual Review of Microbiology*, **41**, 677–701
- Caswell, H. (2000) *Matrix Population Models: Construction, Analysis, and Interpretation*, 2nd edn. Sinauer Associates, Sunderland
- De Jong, M.C.M. (1995) Mathematical modelling in veterinary epidemiology: why model building is important. *Preventive Veterinary Medicine*, **25**, 183–193
- Diekmann, O. and Heesterbeek, J.A.P. (2000) *Mathematical Epidemiology of Infectious Diseases. Model Building, Analysis and Interpretation*. John Wiley, Chichester
- Giordano, F.R., Weir, M.D. and Fox, W.P. (1997) *A First Course in Mathematical Modeling*, 2nd edn. Brookes/Cole Publishing Company, Pacific Grove. (A general introduction to mathematical modelling)
- Halloran, M.E. (1998) Concepts of infectious disease epidemiology. In: *Modern Epidemiology*, 2nd edn. Rothman, K.J. and Greenland, S., pp. 529–554. Lippincott-Raven, Philadelphia. (A quantitative introduction to the transmission of infectious disease)
- Hurd, H.S. and Kaneene, J.B. (1993) The application of simulation models and systems analysis in epidemiology: a review. *Preventive Veterinary Medicine*, **15**, 81–99
- Isham, V. (2005) Stochastic models for epidemics. In: *Celebrating Statistics. Papers in Honour of Sir David Cox on the Occasion of His 80th Birthday*. Eds Davison, A.C., Dodge, Y. and Wermuth, N., pp. 27–54. Oxford University Press, Oxford
- Kitching, R.P., Thrusfield, M.V. and Taylor, N.M. (2006) Use and abuse of mathematical models: an illustration from the 2001 foot and mouth disease epidemic in the United Kingdom. *Review Scientifique et Technique. Office International des Epizooties*, **25**, 293–311
- Manton, K.G. and Stallard, E. (1988) *Chronic Disease Modelling: Measurement and Evaluation of the Risks of Chronic Disease Processes*. Charles Griffin & Company, London/Oxford University Press, New York. (A comprehensive description of models of human chronic diseases and aging)
- Nunn, M., Garner, G. and White, D. (Eds) (1993) Animal health. *Agricultural Systems and Information Technology*, **5** (1) 4–43. (An overview of epidemiological modelling and examples of systems models)
- Proceedings of the Mathematical and Information Models for Veterinary Science Workshop, Wednesday 22 December 1993. Moredun Research Institute, Edinburgh, UK. Moredun Research Institute/University of Strathclyde/Scottish Agricultural Colleges Veterinary Services
- Scott, M.E. and Smith, G. (Eds) (1994) *Parasitic and Infectious Diseases: Epidemiology and Ecology*. Academic Press, San Diego. (An introduction to modelling, with case studies of infections in humans, livestock and wild animals)
- Squire, G.R. and Hamer, P.J.C. (Eds) (1990) *United Kingdom Register of Agricultural Models 1990*. AFRC Institute of Engineering Research, Wrest Park, Silsoe, Bedford. (A list and summary of agricultural models, including some veterinary ones)
- Thornley, J. and France, J. (2006) *Mathematical Models in Agriculture: Quantitative Methods for the Plant, Animal and Ecological Sciences*, 2nd edn. CABI Publishing, Wallingford. (Includes discussions of models of animal diseases, animal husbandry and animal products)

# 20

## The economics of animal disease

---

The importance of financial evaluations in intensive livestock enterprises has been partly responsible for the increased application of economic techniques to animal disease control at farm, national and international levels since the late 1960s, when the principles were first broadly outlined (Morris, 1969) and 'veterinary economics' ('animal health economics') emerged as a specific area of interest in veterinary medicine<sup>1</sup>. There has been a tendency to consider economic evaluations as separate, optional exercises, distinct from epidemiological investigations. However, this attitude is erroneous: economic assessments are integral parts of many epidemiological investigations (see *Figure 2.2*), providing a complementary perspective to that of biological (i.e., technical) studies with which the veterinarian is more familiar because of his professional training. This complementarity is explored by Howe (1989, 1992).

Other factors have also increased veterinary interest in economics (McInerney, 1988). First, in western countries, government veterinary services are increasingly required to justify budgets, as the role of the public sector diminishes. Secondly, as the relative importance of agricultural output declines in western countries, the economic justification for animal disease control is questioned more closely. Thirdly, diseases of farm livestock are barriers to international trade. This problem has become particularly acute with the harmonization of trade in the European Union (which requires free movement of commodities) and the global attempts to liberalize world trade through the World Trade Organization (WTO). Fourthly, rising incomes

and changing social values focus attention on qualitative aspects of food production, the welfare of animals, and diseases of companion animals. This necessitates a widening of economic perspectives from the initial, relatively narrow, evaluation of disease in farm livestock.

This chapter introduces basic economic concepts and principles, and outlines some economic approaches that are relevant to epidemiological investigations. Detailed analytical methods, which, for empirical economic analysis, frequently include a statistical approach – so-called 'econometrics' (Gujarati, 1999; Dougherty, 2002; Greene, 2003) – are not described because it is assumed that most veterinarians are not practising economists, and therefore do not need to apply the various techniques for which some formal training is recommended. Morris and Dijkhuizen (1997) should be consulted for a discussion of some of these methods.

### Popular misconceptions

Economics is commonly viewed as being focussed on *money*. This notion has been reinforced in veterinary medicine by the publication of 'economic' studies that quote the monetary costs of specific diseases such as rotavirus infection (House, 1978) and dermatophilosis (Edwards, 1985). Sometimes, a considerable degree of precision has been attached to the results of such studies (e.g., that the cost of fowl cholera in turkeys in Georgia is \$635 645; Morris and Fletcher, 1988), imbuing the studies with a certainty that may not be justified<sup>2</sup>.

Such an approach generally focusses on the obvious financial costs; for example, the loss calculated as the

---

<sup>1</sup> There was, therefore, a temptation to conclude that animal disease economics is a veterinary problem within the veterinarian's sphere of competence, rather than an economic issue to be addressed by economists (McInerney, 1996). A related temptation is to treat it as a distinct discipline – a view considered to be unsound (Howe and Christiansen, 2004).

---

<sup>2</sup> Recall, too (Chapter 1), that '*... all numbers pose as true*'.

difference between the monetary value to a farmer of a cow if it had remained healthy and productive, and its salvage value (perhaps zero) given the fact of its death. The 'healthy' valuation reflects the value of a cow's potential for producing milk and calves over its entire expected lifetime. In economic terms, its death actually represents the *value of lost output* (output foregone). This is different from, say, the *additional expenditures* made on veterinary services, medicines, and managerial effort (control expenditures) in an attempt to save the cow. Note that the terms 'costs' and 'losses' are often used interchangeably. This can be misleading. In the example, the economic costs are actually the sum total of lost output and additional expenditures.

As described, the financial costs accrue only to an individual farmer; that is, they are **private costs**. But economic analysis in its full sense is concerned with the well-being of either society as a whole, or different groups within society (including farmers) and with questions of who gains, and who loses, as a result of any change in circumstances (e.g., a disease outbreak). Thus, **social costs** must be taken into account. For instance, disease and mortality in animal populations deprive people of the opportunity to consume, say, milk, meat, eggs, wool, or the companionship of pets. These are all examples of *real* economic losses; that is, of people being deprived of the **economic welfare** that flows from using animals for their benefit.

Money values are not of interest in themselves. They derive from prices. In a market economy, prices are signals that show how much people value the things they consume, given that choices must be made about the allocation of various scarce resources with competing uses. Resources used up in production of one thing obviously cannot also be used to produce something else: there is an **opportunity cost** of a given decision – a benefit foregone as a result of doing one thing rather than another. There are different kinds of costs, and it is strictly meaningless to refer to *the* cost of disease. Also, when disease strikes in a substantial animal population, as opposed to an individual herd or flock, output losses may be so large that market prices increase as a result. Such changed valuations must be taken into account when computing the economic consequences of major disease outbreaks.

Sometimes the monetary approach is used to suggest that the larger the financial cost, the more important it is to find a solution. Thus, if mastitis in the UK causes annual output losses of £90 million, and lameness induces losses of £44 million, it might be argued that attention should be directed to mastitis first (Booth, 1989). However, this does not address the technical feasibility, costs or duration of control in each case. The relevant consideration for economic efficiency is by how much output losses are expected to fall for a unit increase in control expenditures. So long as the marginal benefit exceeds the marginal control costs, it pays to keep using more resources. The optimal point is found where the last unit of expenditure just pays for itself in terms of output loss reduction. In the example, although the highest absolute value of losses might be associated with mastitis, it could well be the case that lameness control is the rational choice on the **marginal criterion**. Marginal analysis is indispensable in economic analysis for defining optimal efficiency, and the marginal criterion appears in different forms according to the specific context. In fact, absolute figures such as those quoted are meaningless for guiding policy decisions.

## Economic concepts and principles

An economist's view of the world is based on a set of concepts and generalized abstractions about the nature of their interrelationship (i.e., a theory). The powerful simplicity of the theory means that it is applicable to a wide range of problems, including animal disease.

Economics is a social science that illuminates how people exercise choice in the allocation of scarce resources for production, in the distribution and consumption of products, and in the consequences of those decisions for individual and social benefit (Figure 20.1). Animal disease therefore has economic, as well as biological, impacts because it affects the well-being of people.

As noted above, economic analysis is frequently concerned with identification of the optimum level of output in relation to total resource use, and the

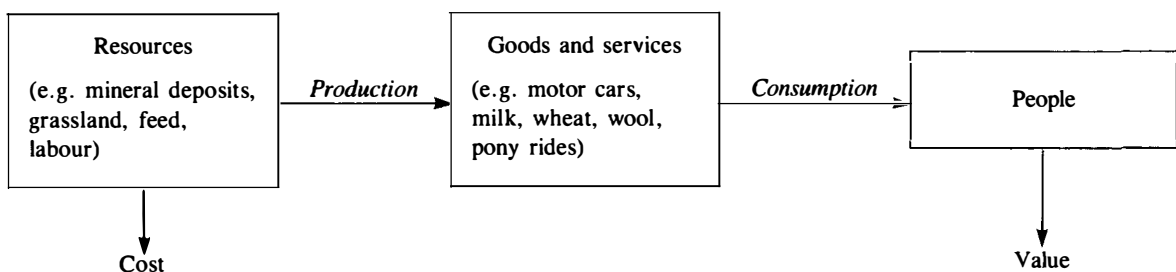

Fig. 20.1 The basic economic model.

most efficient combination of resources within that total. The criteria for efficiency are both economic and technical.

Generally, disease in domesticated (and sometimes undomesticated) livestock populations reduces the quantity and/or quality of livestock products available for human consumption (i.e. benefit). Examples of such products range from meat and milk to pony rides and the companionship of pets. To be more precise, disease causes production from a given quantity of resources to be of lower quantity and/or quality than could be obtained in its absence.

Disease increases costs in two ways. First, because resources are being used inefficiently, the products actually obtained are for an unnecessarily high resource cost: in the absence of disease, the same (or more) output could be obtained for a smaller (or the same) expenditure of resources. Secondly, there is a cost to people, who are deprived because they have fewer, or lower quality, products to consume; that is, they obtain lower benefits. In summary, disease increases expenditures (production costs) and decreases output (consumer benefits)<sup>3</sup>.

### Production functions

The relationship between the resources that provide the inputs to production and the goods and services that comprise the output is called a **production function** (Figure 20.2). The resources may be natural (e.g., land and mineral deposits) or man-made (e.g., buildings and machinery). Frequently, these undergo physical transformation (e.g., iron ore into steel, animal feed into body protein) or else facilitate a physical transformation process (e.g., manpower and managerial expertise). Empirical evidence shows that this

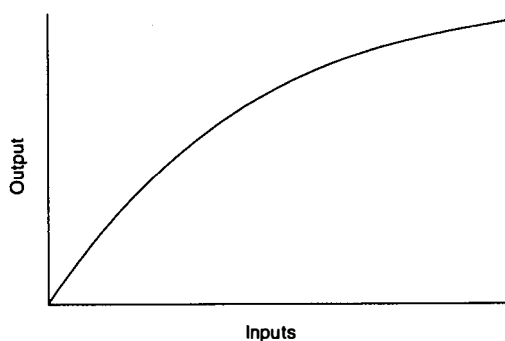

**Fig. 20.2** The shape of a general production function, plotting inputs against output.

<sup>3</sup> In rare cases, disease may *increase* benefits; for example, if it affects pests.

<sup>4</sup> A variable input is defined as an input whose use varies with the planned level of production.

relationship is typically non-linear because certain inputs are typically fixed, and so beyond a certain point an increase in variable input<sup>4</sup> is associated with a less than proportionate increase in output – the ‘law of diminishing returns’ (Heady and Dillon, 1961; Dillon and Anderson, 1990).

Although the idea initially may seem unusual, technical and economic efficiency are seldom synonymous. Under normal circumstances of diminishing physical returns, they are the same only if inputs are costless. For example, it is efficient in an economic sense for a dairy farmer to aim for maximum milk yield per cow only when the cow’s feed is free. If the farmer has to pay for the feed, which, of course, is invariably the case, then it can be shown that optimum economic efficiency is obtained when the yield per cow is less than the maximum technical potential. Furthermore, the overall economic optimum (maximum profits) will change with variations in relative prices of both output and inputs and with methods of production. This observation is important in the context of animal disease, because the incidence of disease that is acceptable from an economic point of view may well change with relative prices and techniques of production.

### Disease as an economic process

Livestock production is a specific example of a physical transformation process (Figure 20.3). Disease impairs this process (i.e., reduces output) in a variety of ways (McInerney, 1996):

- destruction of basic resources (death of breeding and productive animals);
- reduction of the physical output of a production process or its unit value (e.g., lowered milk yield or quality);
- lowering of the efficiency of the production process and the productivity of resources used (e.g., reduced rates of growth or feed conversion);

and has wider effects, including:

- lowering the suitability of livestock products for processing, or generating additional costs in the distribution chain (e.g., warble-fly larval damage to hides; drug residues);
- affecting human well-being directly (e.g., zoonotic infections such as salmonellosis and brucellosis);
- generating more diffuse economic effects that reduce the value of livestock to society (e.g., constraints on trade and tourism; concern for poor food quality and animal welfare).

Thus, there is a loss of efficiency, which poses both technical and economic problems. Figure 20.4 depicts

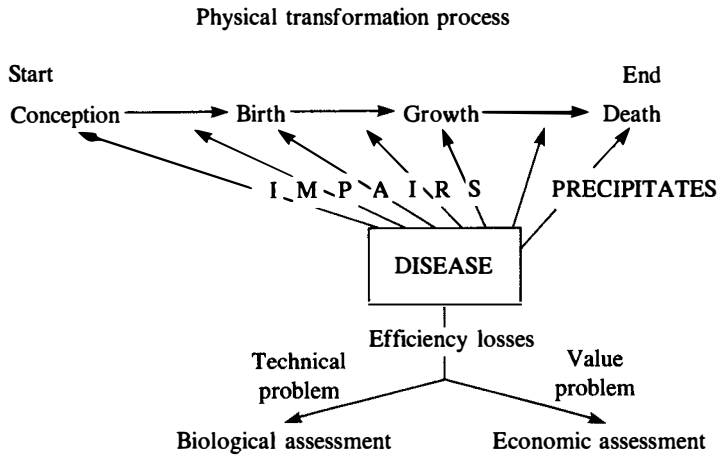

Fig. 20.3 The physical transformation process in relation to livestock production.

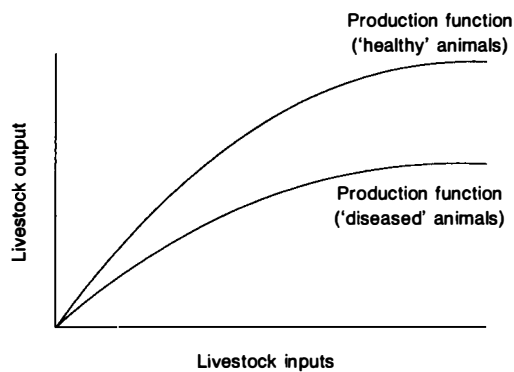

Fig. 20.4 General production function for 'healthy' and 'diseased' animals.

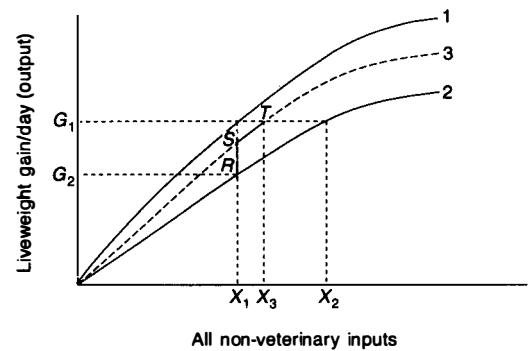

Fig. 20.5 The recovery of planned output utilizing veterinary and non-veterinary inputs. (Based on Howe, 1985.)

the technical efficiency loss as the difference between the production functions of 'healthy' and 'diseased' animals. Disease acts as a 'negative input', and the relationship between inputs and output is shifted downwards, reflecting lower output for given inputs in diseased animals compared with disease-free animals. The concept of efficiency loss is therefore a relationship, not a number, and is smaller under low-input, low-output production systems than under more intensive systems. It follows, therefore, that the potential economic importance of disease varies between farms, regions and countries, and therefore that control measures may be justified in one situation, but not in another.

If restoration of technical efficiency is the goal, the corresponding economic objective is to find the least-cost method to restore health and productivity. The options are presented in Figure 20.5 in which only one output – liveweight gain per day – is considered. For an arbitrary quantity of non-veterinary variable inputs, say  $x_1$ , used with a fixed number of animals, point  $G_1$  indicates the gain per day when they are 'healthy' animals (curve 1);  $G_2$  identifies the liveweight

gain if they are 'diseased' animals (curve 2). Thus,  $G_1 - G_2$  is the loss in technical efficiency. One option is to control the disease exclusively by veterinary intervention, thus restoring  $G_2$  to  $G_1$ . However, reduction of disease commonly does not depend *exclusively* on veterinary services and medicines. An economist regards these as just particular types of inputs that may have substitutes in the form of greater managerial expertise, use of more land to reduce stocking rate, and so on, all of which may reduce disease. Using  $x_2 - x_1$  additional non-veterinary inputs also restores  $G_2$  to  $G_1$ . In practice, the option most commonly adopted corresponds to a movement along some intermediate curve, say curve 3. Production is then lifted from  $G_2$  to  $G_1$  in two parts. The proportion of  $G_1 - G_2$  given by  $RS$  is achieved by veterinary expenditures, while the remainder (climbing from  $S$  to  $T$ ) is achieved by increasing non-veterinary inputs from  $x_1$  to  $x_3$ . The main goal of economic evaluation is to identify the path corresponding to  $RST$ , which enables  $G_1$ , rather than  $G_2$ , to be obtained most cheaply; that is, identifying the *combination* of veterinary and other inputs that will minimize the costs of recovery.

## Assessing the economic costs of disease

The total economic cost of disease can be measured as the sum of **output losses** and **control expenditures**. A reduction in output is a loss because it is a benefit that is either taken away (e.g., when milk containing antibiotic residues is compulsorily discarded) or unrealized (e.g., decreased milk yield). Expenditures, in contrast, are increases in input, and are usually associated with disease control. Examples of control expenditures are veterinary intervention and increased use of agricultural labour, both of which may be used either therapeutically or prophylactically. The economic costs are more than just the sum of financial outlays, and it is important not to confuse the two. A full evaluation enters the realm of **welfare economics**, which is beyond the scope of this introductory chapter. Ebel *et al.* (1992), Howe (1992) and Kristjanson *et al.* (1999), outline basic principles and illustrate their application in animal health economics.

### Optimum control strategies

Figures 20.4 and 20.5 have used the basic economic model of a production function to illustrate the implications of disease and its control for technical and economic efficiency. A related approach is to explore the general relationship between control expenditures and output losses as defined by a curve, which again demonstrates the law of diminishing returns (Figure 20.6). The curve is an 'efficiency frontier' if it defines the lowest disease losses that can be attained for any level of control expenditure, or the lowest possible expenditures for restricting losses to a specified level<sup>5</sup>. Combinations of output losses ( $L$ ) and control expenditures ( $E$ ) to the 'south west' of the curve are unattainable, whereas combinations observed to the 'north east' result from technical deficiencies in livestock management. Two control programmes, A and B, are identified in the figure. A change from programme A to programme B involves an increase in control expenditures of  $\delta E = E_B - E_A$ , and a decrease in output losses of  $\delta L = L_A - L_B$ . It is worth increasing the level of control expenditures by  $\delta E$  because  $\delta L$  is greater than  $\delta E$ . However, it becomes increasingly expensive to achieve incremental reductions in output losses.

The **optimum** control strategy is defined by point C in Figure 20.7. At this point, the total costs,  $T_C = (L_C + E_C)$  are the lowest that can be attained (i.e., the avoidable costs = £0). To the left of C, £1 of control expenditures reduces output losses by more than £1; to the

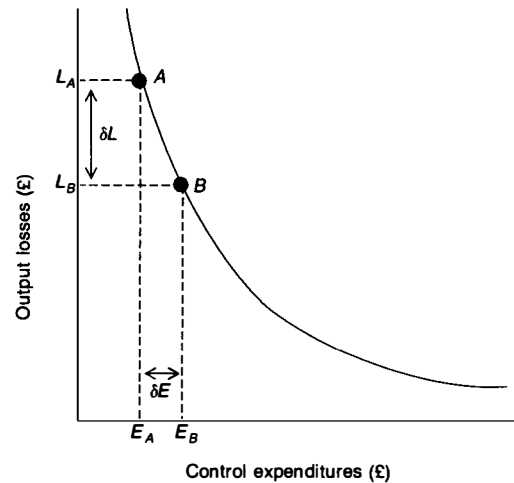

Fig. 20.6 The general relationship between output losses and control expenditures. (From Schepers, 1990.)

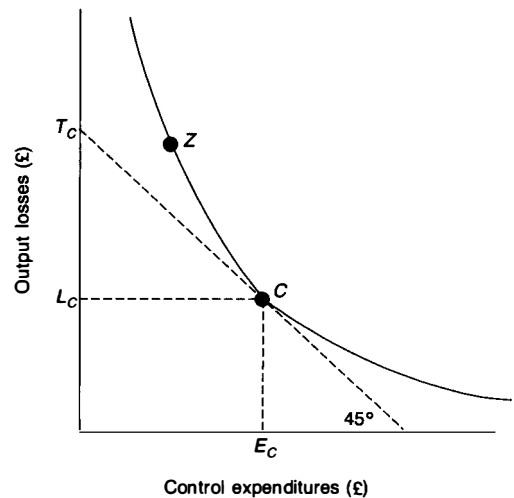

Fig. 20.7 Defining the economically optimum control programme. (From Schepers, 1990.)

right of this point, £1 of control expenditures reduces output losses by less than £1. This is an illustration of **marginal analysis** and, specifically, the principle that resources should be used up to the point where the expenditure on the last unit of resource is just recouped by the additional returns.

### An example of identifying an optimum control strategy: bovine subclinical mastitis in the UK (McInerney *et al.*, 1992)

Bovine mastitis is considered to be the most important disease affecting dairy cattle in many developed countries. In the UK, a national mastitis survey conducted in 1977 provided detailed information on the prevalence of subclinical infection and control procedures

<sup>5</sup> This curve relates to persistent or recurrent conditions, such as bovine mastitis. If the disease of interest could be eradicated (e.g., swine fever), the frontier would intersect the horizontal ( $E$ ) axis.



**Table 20.1** Predicted mastitis incidence and economic costs associated with 18 different control strategies employed by dairy herds in the National Mastitis Survey, UK, 1977. (Modified from McInerney *et al.*, 1992.)

<i>Control method</i>			<i>Group no.</i>	<i>Effect on incidence</i>		<i>Loss/expenditure coordinates</i>		
<i>Teat dip/spray (period)</i>	<i>Dry-period therapy (cows)</i>	<i>Testing milk machine</i>		<i>Predicted incidence rate (/100 cows/year)</i>	<i>Decrease in incidence (relative to no control)</i>	<i>Control expenditures (£/100 cows/year) (E)</i>	<i>Output losses (£/100 cows/year) (L)</i>	<i>Total economic cost (C)</i>
All year	All	Yes	1	18.5	24.8	710	2296	3006
		No	2	22.3	21.0	670	2770	3440
	Some	Yes	3	23.4	19.9	490	2899	3389
		No	4	27.2	16.1	450	3373	3823
	None	Yes	5	27.8	15.5	270	3446	3716
		No	6	31.6	11.7	230	3923	4153
Part of year	All	Yes	7	33.7	9.6	615	4148	4799
		No	8	37.6	5.7	575	4657	5232
	Some	Yes	9	38.6	4.7	395	4786	5181
		No	10	42.4	0.9	355	5260	5615
	None	Yes	11	43.0	0.3	175	5333	5508
		No	12	46.8	-3.5	135	5807	5942
Not used	All	Yes	13	30.3	13.0	480	3751	4231
		No	14	34.1	9.2	440	4225	4665
	Some	Yes	15	35.1	8.2	260	4354	4614
		No	16	38.9	4.4	220	4827	5047
	None	Yes	17	39.5	3.8	40	4900	4940
		No	18	43.3	0	0	5374	5374

practised in over 500 herds (Wilson and Richards 1980; Wilson *et al.*, 1983). The latter include:

- teat dipping and spraying;
- dry-cow therapy;
- annual testing of milking machines.

The losses due to subclinical mastitis include:

- decreased milk yield;
- changed milk composition;
- decreased milk quality (e.g., antibiotic residues);
- accelerated replacement of dairy cows.

Sometimes there are offsetting savings in some input expenditures such as decreased feed intake because of loss of appetite in affected cows.

Control expenditures relate to the three control techniques, and sufficient published information was available to attach financial values to these expenditures and the losses. The prevalence was expressed as the percentage of quarters that were subclinically infected per day, and annual incidence was estimated assuming that subclinical infection lasts an average of 0.6 years (Dodd and Neave, 1970).

Table 20.1 lists the predicted disease incidence and the economic costs associated with the various combinations of control strategy. The lowest costs that can be attained are associated with control strategy 1 (teat dipping throughout the year, administering dry-cow therapy to all eligible animals, and annual testing of milking machines), where the total costs = £3006 per 100 cows per year. The specific relationship between control expenditures and output losses is displayed in Figure 20.8, and is consistent with the general case (Figure 20.7). The curve identifies the 'best practical' options from a technical point of view, and so the corresponding economic optimum must be somewhere along its length.

If these results are extrapolated to the national herd, they suggest that if strategy 1 were implemented in all

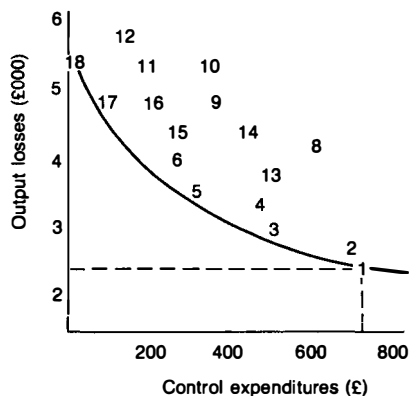

Fig. 20.8 Output losses and control expenditures of farms in the National Mastitis Survey. (Numbers refer to the control strategies listed in Table 20.1.). (From McInerney *et al.*, 1992.)

dairy herds, the overall cost of mastitis to the nation could be reduced from £172.7 million to £159.6 million, at which level the avoidable costs = £0. It is these costs that are relevant to decisions about resource allocation and disease control – not the costs measured from a base of zero, which it may be impossible to reach with current control techniques. The costs cannot be reduced further unless investment is made into research to improve methods of mastitis control.

### Cost-benefit analysis of disease control

The costs and benefits of disease control campaigns can be assessed using several methods including **gross margin analysis** and **partial budgeting** (Asby *et al.*, 1975). These are essentially straightforward accounting approaches, whereas **social cost-benefit analysis** (Pearce, 1971; Mishan, 1976; Sugden and Williams, 1978; Campbell and Brown, 2003) is really the application of a specific technique that allows for the fact that costs and benefits are commonly distributed over time, and sometimes are more than simple financial values. If it is necessary only to minimize the costs of achieving a given objective, then a **cost-effective** study is undertaken. The remainder of this chapter introduces partial budgets and social cost-benefit analysis.

#### Partial farm budgets

Partial farm budgets have been used to assess the suitability of control strategies (notably against endemic diseases such as mastitis and internal parasitism) on individual farms. A partial budget is a simple description of the financial consequences of particular changes in farm management procedures, of which disease control programmes are a part. 'Partial' indicates that assessment is restricted to the factors that are likely to change as a result of the procedural changes.

There are four main components:

1. additional revenue realized from the change,  $r_1$ ;
2. reduced costs stemming from the change,  $c_1$ ;
3. increased costs as a result of the change,  $r_2$ ;
4. cost of implementing the change,  $c_2$ .

If  $(r_1 + c_1) > (r_2 + c_2)$ , then the proposed change is justified.

For example (Erb, 1984), if a new programme to control subclinical mastitis comprised maintenance of milking machines, routine intramammary dry-cow therapy and teat dipping, then:

- $r_1$  = sales due to increased milk production;
- $c_1$  = savings stemming from fewer cases of clinical mastitis to treat;

- $r_2$  = increased feed costs due to increased milk production;
- $c_2$  = costs of implementation (disinfectants, dry-cow intramammary preparations).

A one-year partial farm budget for this programme produced values of  $r_1 = £397$ ,  $c_1 = £18$ ,  $r_2 = £77$ ,  $c_2 = £246$ . Thus:

$$r_1 + c_1 = £415,$$

$$r_2 + c_2 = £323.$$

and so there is a net benefit of £92, indicating that the farm should increase its annual profits by that amount if it invests in the control campaign.

### Social cost–benefit analysis (CBA)

Social cost–benefit analysis developed as a means of assessing large-scale investment policies. It evolved in the public sector, as an aid to resource allocation in areas where markets do not exist, where there are no clear ‘market signals’ to guide the size and direction of investments, and where governments are responsible for determining the shape of services (Burchell, 1983). It has been used widely in veterinary medicine to assess national animal disease control campaigns against infectious diseases; for example, swine fever (Ellis *et al.*, 1977), rinderpest (Felton and Ellis, 1978; Tambi *et al.*, 1999), rabies (Aubert, 1999), bovine virus diarrhoea (Valle *et al.*, 2000) and foot-and-mouth disease (Berentsen *et al.*, 1992a,b; James and Rushton, 2002).

#### Principles of CBA

Social cost–benefit analysis attempts to quantify the social advantages and disadvantages of a policy in terms of a common monetary unit. For example, the building of a road will incur costs to society arising from the resources expended on construction and maintenance, the undesirable side-effects of pollution, increased noise levels and spoiling of the landscape. The benefits include savings in travelling time, reduced congestion and decreased noise levels in a town if the road is a bypass. Some of the costs or benefits (e.g., construction outlays – costs) are expressed easily in pecuniary values. Other costs or benefits (e.g., decreased noise level – a benefit), however, are much more difficult to translate into monetary terms; these are called **intangibles**. Only by using the common denominator of money is it possible to aggregate the gains and losses that ultimately interest society as the benefits and costs perceived in *real* terms; that is, as adding to or reducing people’s sense of well-being. Consequently, it is important to quantify, in

monetary units, all important factors as comprehensively as possible. Any problem areas should be made explicit, especially where the value of intangibles is assessed subjectively or even not at all.

If a disease control programme were initiated, costs would include those of manpower, drugs, vaccines, quarantine buildings, compensation for slaughter, transportation and training programmes. The benefits would include increased productivity, decreased animal and (in the case of zoonotic diseases) human suffering, increased trade and the psychological well-being accompanying the decreased disease incidence. The prefix ‘social’ to CBA is often dropped from the name but is important. It emphasizes that CBA is used by an organization to maximize the *net benefits to society*, rather than maximizing its own purely private benefits (Pearce and Sturmeay, 1966).

#### ‘Internal’ and ‘external’ costs and benefits

**Internalities** (private costs and benefits) are those that accrue directly to an investment project. Costs and benefits accruing to others are termed **externalities**. It is the externalities that mainly are not reflected in the price mechanism (which therefore becomes inadequate as a guide to correct investment decisions from the point of view of society). For example, a farm mastitis control campaign includes dry-cow antibiotic therapy (a cost) and increased milk yield (a benefit), both of which are part of the farm’s budget and therefore internal. However, antibiotic residues in milk may have undesirable side-effects on unknowing consumers. If they were aware of the risks, they would be prepared to pay less for the milk (if, indeed, they would buy it at all). To protect consumers, and to ‘internalize’ the external effects, legislation limiting the use of antibiotics and affected milk may be necessary, instead of reliance on a deficient price mechanism. Similarly, in a foot-and-mouth disease campaign in Britain, farmers’ loss of slaughtered animals is an internal cost, whereas the inconvenience of restrictions on movement and access is an external cost.

#### Discounting

Control campaigns may operate over several years. The value of a sum of money in hand now is greater than the same sum of money received at a later date. This is because being able to consume now is considered preferable to having to wait to consume in the future, or because a sum invested now will produce a larger sum in the future as interest accrues. If the interest rate is 5% per annum, then £100 now is worth £105 compound in 1 year’s time, £110.25 in 2 years, and so on. If costs and benefits, spread over several years, are to be compared, then they must be adjusted to

calculate their value now. The process of adjustment, which is the opposite of compounding, is called **discounting**. The formulae for its calculation are described by Gittinger (1972) and Little and Mirrlees (1974). The calculation uses a rate of discount that is usually defined by governments, for example the World Bank Rate and, in Britain, the Treasury Rate. Cost-benefit analysis is performed in real terms, which means that the rate of interest used in the calculations is adjusted to exclude the effects of price inflation.

**Shadow prices**

The social value of a benefit may not always be the market price. For example, a litre of milk is valued by the farmer at its market price. However, when governments use trade barriers to increase product prices for domestic farmers as, for example, happened in the European Union before production quotas were introduced, a milk surplus may develop. Then the real economic value to society of the excess supply must be less than its (supported) market price. A national disease control campaign that resulted in increased milk surpluses under price support therefore would use the value of the excess milk, termed a **shadow price**, as a better estimate of its true economic value to society. This will be the international market price if supplies are disposed of on the world market.

**Uncertainty**

Any project is accompanied by uncertainty. The results of a control campaign cannot be known with certainty, but it is necessary to have an idea what the outcome might be. There are two approaches to dealing with uncertainty. First, if a model is constructed, the 'most probable outcome' can be defined; a sensitivity analysis (see Chapter 19) can then be conducted to determine whether changes in the model's parameters can produce major changes in the outcome. Alternatively, the likelihood of the various outcomes can be judged using probability theory (Reutlinger, 1970).

**Criteria for selecting a control campaign**

Three important measures of economic efficiency used as criteria for selecting a control campaign are:

1. net present value (*NPV*);
2. benefit:cost ratio (*B/C*);
3. internal rate of return (*IRR*).

The **net present value (NPV)** is the value of the stream of discounted benefits less costs over *n* time periods. It is given by:

$$NPV = \frac{B_0 - C_0}{(1+r)^0} + \frac{B_1 - C_1}{(1+r)^1} + \dots + \frac{B_n - C_n}{(1+r)^n}$$

$$= \sum_{t=0}^n \frac{B_t - C_t}{(1+r)^t}$$

where:

- $C_t$  = value of costs incurred in time *t*;
- $B_t$  = value of benefits gained in time *t*;
- r* = discount rate;
- n* = life of project.

A project is considered to be viable if the *NPV* is positive.

The **benefit:cost ratio (B/C)** is the ratio of the present value of benefits to that of costs. It is given by:

$$B/C = \frac{\sum_{t=0}^n \{B_t / (1+r)^t\}}{\sum_{t=0}^n \{C_t (1+r)^t\}}$$

$$= \sum_{t=0}^n \frac{B_t}{C_t}$$

A project is viable if the ratio is greater than or equal to 1.

The **internal rate of return (IRR)** is the rate of discount that equates the present value of the costs with the present value of the benefits. It is given by solving for *r* such that:

$$NPV = \sum_{t=0}^n \frac{B_t - C_t}{(1+r)^t} = 0.$$

If the internal rate of return of an investment project is greater than the actual interest rate, the project is economically worthwhile.

**An example of CBA: alternative policies for the prevention, control and eradication of infestation with *Chrysomya bezziana* in Australia (Cason and Geering, 1980)**

*Chrysomya bezziana*, the Old World screw-worm fly (SWF), causes serious economic losses in livestock in Africa, Asia and Papua New Guinea. Damage caused by burrowing larvae can result in a case fatality rate of up to 50% in young animals, and can cause loss of condition, occasional deaths and sterility (if genitalia are struck) in adults. The disease is not present in Australia, but if the fly entered Australia, potential losses have been estimated at around \$100 million per annum. The most likely method of entry into Australia would be by movement of infested livestock across the Torres Strait islands from Papua New Guinea, although entry could also occur either by the direct flight of the flies or by transmission of the flies by migratory birds and aircraft.

Strategies to prevent the introduction and establishment of SWF in Australia include:

- improved quarantine surveillance, including training of local inhabitants and education programmes;
- better control of livestock in danger areas, possibly including total destocking of the Torres Strait islands – although this would probably be socially unacceptable to the islanders;
- the development of a SWF monitoring system, facilitated by a specific chemical bait ('Swormlure');
- the construction of a clinic in the Torres Strait islands to neuter dogs and cats (potential hosts of SWF);
- eradication of SWF from Papua New Guinea.

The major strategy to control and eradicate an outbreak of infestation with SWF in Australia is ground control of the fly, consisting of restriction of movement of livestock, dipping and spraying with insecticides, the use of a sterile insect release method, by which sterile male flies compete with fertile male flies for each mating female, and the use of a screw-worm adult suppression system (SWASS), in which poisoned baits are released by aeroplane over infested areas. The quickest response to an outbreak of SWF infestation would be obtained if a sterile SWF facility were built in advance, but not opened until an outbreak occurred.

Table 20.2 shows the benefit:cost ratios for the various strategies over a 20-year period, assuming that

infestation occurred after 1, 10 or 20 years. In all cases the benefit:cost ratios are greater than 1, indicating that all techniques are economically justifiable.

In the example, the benefits do not derive from increased production, but from decreasing the risk of infestation. Although the benefit:cost ratios are high, they have to be weighed against the probability of infestation occurring when a particular policy either is or is not adopted. These and other considerations are discussed by the authors of the study.

### Some problems associated with CBA

There are several general problems related to CBA. The technique assumes that the preferences and priorities of society are known; this may not always be true. The technique also applies current social preferences, rather than future ones. Additionally, as indicated earlier, the costs and benefits of externalities and intangibles may be difficult to assess.

There are specific problems relating to disease control policy formulation (Schepers, 1990). A CBA refers to only one combination of control expenditures and output losses. Thus, point Z in Figure 20.7 represents a benefit:cost ratio greater than 1; that is, the reduction in output losses exceeds the control expenditures. Indeed, the combinations of expenditures and losses furthest to the left of the curve have the greatest benefit:cost ratios, and there may be the temptation to fallaciously conclude that the larger the benefit:cost ratio, the more economically efficient the control technique. However,

**Table 20.2** Cost–benefit analysis of strategies for the prevention, control and eradication of infestation with *Chrysomya bezziana* in Australia. (The analysis is in present values over a 20-year period, and assumes that the methods prevent Australia-wide losses commencing in year 1, year 10, year 20; discounted at 9.5%). (Modified from Cason and Geering, 1980.)

Prevention method	Year infestation prevented					
	1		10		20	
	Benefit: \$389m		Benefit: \$164m		Benefit: \$69m	
	Cost (\$000)	Benefit:cost ratio	Cost (\$000)	Benefit:cost ratio	Cost (\$000)	Benefit:cost ratio
Strategic eradication from Papua New Guinea	2 962	131	11 734	14	16 123	4
Mothballed factory and maintenance colony	1 394	279	1 670	98	1 809	38
Ground control*	2 523	154	1 065	154	449	155
Destocking of Torres Strait islands	657	592	776	212	836	83
Improving quarantine	124	3 137	417	394	563	123
'Swormlure' trapping and myiasis monitoring	30	12 966	171	961	241	288
Training	26	14 961	69	2 383	91	763
Extension	13	29 923	83	1 980	119	583
Torres Strait clinic	7	55 571	40	4 110	56	1 239

\* Includes the SWASS technique (see text).

the economically optimum control programme is indicated by point C; this will be identified by a CBA only if the CBA happens, by chance, to be concerned with evaluating a control policy corresponding to point C.

Moreover, CBA is a relatively sophisticated technique, but may be applied in situations – especially in the developing countries – where accurate basic data are lacking (Grindle, 1980, 1986). For example, there may be inadequate information on livestock numbers, disease morbidity and the actual economic impact of disease. It may also be impossible to predict future market prices (e.g., of beef and milk), which need to be included in analyses. The sophistication of the economic techniques therefore needs to be balanced with the quality of the epidemiological data that are available. However, although CBA and other techniques of project evaluation are, at best, approximate (Gittinger, 1972), they play a useful role in economic evaluation. Despite its limitations, CBA is a rigorous approach to project evaluation, and its application can help towards better informed decisions regarding the efficient use of scarce resources in disease control programmes.

### Further reading

- Ansell, D.J. and Done, J.T. (1988) *Veterinary Research and Development: Cost-Benefit Studies on Products for the Control of Animal Diseases*. CAS Joint Publication No. 3. Centre for Agricultural Strategy, Reading/British Veterinary Association, London
- Dykhuizen, A.A. (1993) Modelling animal health economics. In: Society for Veterinary Epidemiology and Preventive Medicine, Proceedings, Exeter, 31 March–2 April 1993. Ed. Thrusfield, M.V., pp. ix–xx
- Ebel, E.D., Hornbaker, R.H. and Nelson, C.H. (1992) Welfare effects of the national pseudorabies eradication program. *American Journal of Agricultural Economics*, **74**, 638–645
- Ellis, P.R. and James, A.D. (1979) The economics of animal health – (1) Major disease control programmes. *Veterinary Record*, **105**, 504–506
- Ellis, P.R. and James, A.D. (1979) The economics of animal health – (2) Economics in farm practice. *Veterinary Record*, **105**, 523–526
- Erb, H. (1984) Economics for veterinary farm practice. *In Practice*, **6**, 33–37
- Hill, B. (1990) *Introduction to Economics for Students of Agriculture*, 2nd edn. Pergamon Press, Oxford. (*A general introduction to agricultural economics*)
- Howe, K.S. (1992) Epidemiologists' views of economics – an economist's reply. In: Society for Veterinary Epidemiology and Preventive Medicine, Proceedings, Edinburgh, 1–3 April 1992. Ed. Thrusfield, M.V., pp. 157–167
- Howe, K.S. and Christiansen, K. (2004) The state of animal health economics: a review. In: Society for Veterinary Epidemiology and Preventive Medicine, Proceedings, Martigny, 24–26 March 2004. Eds Reid, S.W.J. Menzies, F.D. and Russell, A.M., pp. 153–165
- Howe, K.S. and McNerney (Eds) (1987) *Agriculture. Disease in Farm Livestock: Economics and Policy*. Proceedings of a symposium in the Community programme for coordination of agricultural research, 1–3 July 1987, Exeter. Report EUR 11285 EN. Commission of the European Communities, Luxembourg. (*A study of economic losses due to animal disease in the European Union, and methods for the economic assessment of disease control*)
- Kristjanson, P.M., Swallow, B.M., Rowlands, G.J., Kruska, R.L. and de Leeuw, P.N. (1999) Measuring the costs of African animal trypanosomosis, the potential benefits of control and returns to research. *Agricultural Systems*, **59**, 79–98
- Mather, E.C. and Kaneene, J.B. (Eds) (1986) *Economics of Animal Diseases*. Proceedings of a conference held at Michigan State University, 23–25 June 1986. Michigan State University, Michigan
- McNerney, J.P. (1996) Old economics for new problems – livestock disease: Presidential Address. *Journal of Agricultural Economics*, **47**, 295–314
- McNerney, J.P., Howe, K.S. and Schepers, J.A. (1992) A framework for the economic analysis of disease in farm livestock. *Preventive Veterinary Medicine*, **13**, 137–154
- Mishan, E.J. (1982) *Cost-Benefit Analysis: An Informal Introduction*, 3rd edn. Allen and Unwin, London
- Morris, R.S. and Dijkhuizen, A.A. (Eds) (1997) *Animal Health Economics: Principles and Applications*. Postgraduate Foundation in Veterinary Science, University of Sydney, Sydney
- Ngategize, P.K. and Kaneene, J.B. (1985) Evaluation of the economic impact of animal diseases on production: a review. *Veterinary Bulletin*, **55**, 153–162. (*A review of some analytical techniques*)
- OIE (1999) The economics of animal disease control. *Revue Scientifique et Technique, Office International des Epizooties*, **18**, 295–561
- Putt, S.N.H., Shaw, A.P.M., Woods, A.J., Tyler, L. and James, A.D. (1987) *Veterinary Epidemiology and Economics in Africa*. ILCA Manual No. 3, International Livestock Centre for Africa, Addis Ababa

# 21

## Health schemes

---

### Private health and productivity schemes

The traditional role of the veterinarian has been to attend individual sick animals when requested to do so by the owner: such attention has been called 'fire brigade' treatment. This approach was useful when most diseases, such as the classical epidemic infectious diseases, had a predominantly single cause and responded to a simple course of treatment. However, an appreciation during the 1960s of the multifactorial nature of many diseases, which coincided with intensification of animal industries in the developed countries, with a relative decrease in the value of individual animals, resulted in a change in attitude towards the management of diseases in livestock units (see Chapter 1). First, it became clear that diseases needed to be controlled by simultaneously manipulating all determinants: those associated with agent, host and environment. The veterinarian's objective should be to prevent, rather than to treat, disease. Secondly, it became necessary to consider disease in terms of its contribution to reduced performance (and therefore profitability) of a herd<sup>1</sup>.

The first change stimulated the development of **preventive medicine programmes** in the early 1960s. The second change resulted in the evolution of comprehensive **herd health and productivity schemes**, encompassing preventive medicine and the assessment of productivity (Blood *et al.*, 1978; Cannon *et al.*, 1978;

Eskesbo *et al.*, 1994). These programmes and schemes may be run by one or more general practitioners, with data stored by the practitioners (the 'bureaux' approach); alternatively, the data may be managed entirely 'on farm' (Etherington *et al.*, 1995). All are concerned with problems on individual farms; they are therefore **private** schemes.

### Structure of private health and productivity schemes

#### Objectives

The goals of a health and productivity scheme were initially summarized by Blood (1976). They should:

- identify disease and productivity constraints and problems on a farm;
- rate the problems in order of importance, with reference to technical and economic criteria<sup>2</sup>;
- initiate suitable control techniques and measure their success, not only technically but also with regard to the economic efficiency of the utilization of resources at the national and individual farm level, thereby indicating which technique should be increased and which reduced.

The scope of service offered by the veterinarian in a comprehensive health and productivity scheme (Grunsell *et al.*, 1969; Ribble, 1989) includes:

- the diagnosis and prevention of the major epidemic diseases;

---

<sup>1</sup> *Performance-related diagnosis* was introduced in Chapter 1; and an example of multifactorial 'disease', defined in terms of a production shortfall in a population, was given in Figure 5.2. The concept of a 'sick' population is not confined to veterinary medicine, though. Medical epidemiologists also search for characteristics of 'sick' populations, for example to answer the questions 'Why is hypertension common in London but absent from Kenyans?' and 'Why is coronary heart disease common in Finland but rare in Japan?'

---

<sup>2</sup> The financial impact of production diseases can be measured in terms of relative health indices such as *Healex* (Esslemont and Kossaibati, 2002), which compares direct losses due to disease with those in 'top' herds.

- an emergency service for individual animals;
- the supply of drugs;
- advice on environmental determinants (nutrition, housing and management);
- advice on production techniques and general policies of livestock farming.

This scope is broad and indicates that the veterinarian requires more than just a knowledge of the diagnosis and treatment of clinical disease. In many cases, the veterinarian may need to enlist further expert help from nutritionists, building advisors, and management specialists who have some knowledge of farm economics.

### Components

There are differences between the schemes applied to different species, but the principles are the same. The main components of a scheme are:

- the recording of a **farm profile** comprising details of animal numbers, buildings and feeding systems, stocking density, nutrition, usual management practices, disease status and current levels of production;
- identification of production shortfalls;
- monitoring of all aspects of production;
- identification of the major disease problems;
- routine prophylaxis against the major disease risks;
- definition of **production targets** that are suitable for the system of management operating on the particular livestock units and for the aims of the farmer;
- advice on management and husbandry, to achieve the predetermined targets;
- detection of unacceptable shortfalls in production (and therefore in profitability);
- correction of the shortfalls by eliminating the defects associated with agent, host and environment, or revising the production targets in the light of experience;
- identification of farmers' perception of strengths and weaknesses in health, fertility and nutrition.

Regular visits to farms are an important part of health schemes. A **health plan** is drawn up containing details of procedures (e.g., routine treatments and vaccination) to be followed during the year.

Health and productivity schemes require accurate records to be kept. Early schemes used longhand records, but most contemporary systems store data on computers where the data can be analysed rapidly. The first computerized systems were run on mainframes and were organized by central advisory bureaux. There is now a trend towards complete

decision support systems (see Chapter 11), mounted on microcomputers, which support farmers in herd management. For example, CHES (Computerized Herd Evaluation System for Sows) comprises a decision support system that assesses performance in pig breeding herds, and three expert systems that attempt to identify strengths and weaknesses in the enterprises in an economic context (Huirne and Dijkhuizen, 1994). All of these systems are essentially microscale (see Table 11.2).

### Targets

The variables that are used to determine production targets are described below in relation to the different species. Targets usually have been defined as measures of position (e.g., mean age of dry sows) or as upper or lower limits (e.g., maximum calving interval or minimum first service pregnancy rate in dairy cattle). Measures of location do not indicate the dispersion of values in a herd and can be misleading; measures of dispersion, such as the standard deviation (when a variable is Normally distributed) or the semi-interquartile range are more informative (see Chapter 12). Thus, if a farmer bred some cows very soon (less than 35 days) after calving, then the measure of position would be reduced, but the measure of dispersion would be increased. This can eliminate the economic benefit that owners think they are achieving because the economic benefit results from most cows calving with intervals close to 365 days (Morris, 1982); the benefit will not exist with a large dispersion.

Some variables that are used as production indices have frequency distributions that are skewed, in which case the mean may be far from the peak of the distribution. For example, the frequency distribution of calving to conception intervals is positively skewed; typically the median may be 10 days less than the mean. More appropriate measures of position and dispersion therefore would be the median and semi-interquartile range, respectively. Logarithmic transformation of values (see Chapter 12) may be undertaken because this may convert skewed distributions to Normal ones. Morant (1984) discusses the appropriateness of measures in relation to dairy fertility, giving examples. In practice, mean values usually are used because they are understood by farmers. This approach works, provided they also appreciate the notion of dispersion of values.

No single set of standards can be set as production targets because satisfactory performance varies with type of farm and management practices (Kay, 1986). **Internal** standards can be set, using a farm's historical data (say, over the previous three years). Additionally, **external** standards, such as the mean performance (with the associated standard deviation) of similar



herds, may be specified. In The Netherlands, for example, such standards are published for pig breeding herds (Baltussen *et al.*, 1988) and in the UK for dairy herds (Whitaker *et al.*, 2000, 2004).

### Measuring shortfalls in production

Shortfalls in production are defined by an **action level** (also termed an **interference level**). This is the level at which the recorded production variable ceases to be acceptable in relation to its target level. Action levels are often identified by experience, based on financial criteria; and defined as levels beyond which there is unacceptable financial loss. When the measurement of location of a variable (the mean commonly has been used), recorded over a period of time, is beyond the action level, corrective measures are undertaken. This method does not consider the effects of random variation. These can be accommodated by defining the action levels as statistical parameters of the target level; the standard error is a suitable parameter for Normally distributed data. Suitable techniques for continuous data are the construction of cusums and Shewhart charts (see Chapter 12).

### Justification

A herd health and productivity scheme must be economically justifiable. The economic justification of these schemes is well documented (e.g., Williamson, 1980, 1987, 1993). Pharo *et al.* (1984) derived a benefit:cost ratio of approximately 3:1 for a computerized dairy herd health and productivity scheme in Britain over a 5-year period, and a similar value has been estimated for a scheme in the US (Williamson, 1987)<sup>3</sup>. Similarly, Brand *et al.* (1996) demonstrated that herd health schemes improved farms' economic results in The Netherlands<sup>4</sup>.

Details of schemes for the various species given below are presented only as introductory examples and therefore are not comprehensive descriptions of the systems. Eddy (1992) gives a concise introduction to these schemes, and Rueg (2001) describes them in detail.

<sup>3</sup> Demonstration of benefits requires analysis of appropriate data from herds, some of which may be large. Chamberlain and Wassell (1995) suggest that, for most variables, adequate precision (see Chapters 9 and 13) to assess poor herd performance is achieved from a sample of animals in a herd (approximately 40 cows from a 200-cow herd, and 20 cows from a 100-cow herd), but that it is not achieved for some variables (e.g., annual culling rate), in which circumstance data from the whole herd should be monitored.

<sup>4</sup> Despite the financial advantages and the benefits perceived by veterinarians, uptake by farmers has been slow in some sectors: in the early 1990s, for example, about one third of dairy practices in the UK had health schemes, but only a small proportion of dairy clients were using them – possibly because of doubts about 'new technology' (Wassell and Esslemont, 1992).

## Dairy health and productivity schemes

Dairy health and productivity schemes were developed in the 1950s and since then have received considerable attention. The main object of a dairy scheme is to improve welfare and productivity by maximizing health, milk yield and milk quality under the particular system of management on the farm. Optimum milk yield and quality are achieved by:

- efficient reproduction;
- decreasing important diseases – especially mastitis and lameness;
- optimum feeding – both nutritionally and economically.

### Targets

Some suggested targets for efficient reproduction for a dairy enterprise in the UK are listed in *Table 21.1*. North American targets are given by Fetrow *et al.* (1997). A target mean calving to conception interval of 85 days is often recommended. This facilitates an annual reproductive cycle (because the cow's gestation period is approximately 280 days, with a calving interval (the interval between calvings for an individual cow) of 365 days, and a calving index (the mean calving interval for all cows) with a similar value).

The index variables used in measuring reproductive performance are complex, and need to be interpreted with care (Eddy, 1992). The calving to conception interval, for example, is related to the calving to first service interval and to the first service to conception

**Table 21.1** Suggested reproductive performance targets for a dairy herd in the UK. (Modified from Eddy, 1992.)

<i>Index variable</i>	<i>Target</i>	<i>Interference level</i>
Mean calving to conception interval	85 days	95 days
Mean calving to first service interval	65 days	70 days
Mean first service to conception interval	20 days	25 days
Pregnancy rate to first service (%)	60	50
Pregnancy rate to all services (%)	60	50
Overall culling rate (%)	<18	>23
Per cent served of cows calved	95	<90
Per cent conceived of cows calved	85	<80
Per cent conceived of cows served	95	<90
Per cent of interservice intervals 18–24 days	60	45
Per cent of interservice intervals <18 days	8	12
Submission rate* (%)	90	<75

\* The number of cows or heifers served within a 21-day period, expressed as a percentage of the number of cows or heifers at or beyond their earliest service date at the start of the 21-day period.

interval. The calving to first service interval, in turn, depends on the restoration of ovarian function, uterine involution, oestrus detection, and farm policy on mating; whereas the first service to conception interval is affected by oestrus detection efficiency and the pregnancy rate. Moreover, no single index should be used as an indicator of reproductive efficiency. Thus, the calving to conception interval and culling rate need to be considered jointly because they are inversely related; a reduced culling rate on fertility grounds will result in an increased calving to conception interval, and vice versa (Eddy, 1992). Some authorities recommend assessing fertility performance in a single financial index (*Fertex*), which combines the calving interval, culling rate for failure to conceive, and pregnancy rate (Esslemont, 1993a). This may be difficult to translate into appropriate action because it is first necessary to identify which of its component parameters is deficient.

Targets for a wider range of problems and production parameters can be defined according to the performance of the 'top' herds for which data are available (Table 21.2)

### Routine visits

Regular farm visits are required to achieve reproductive

**Table 21.2** Some suggested disease and production targets for a dairy herd in the UK. (Calculated from the 'top' 10 herds out of 42 herds.) (Modified from Esslemont and Kossaibati, 2002.)

Index variable	Target
Twinning (cases/100 cows)	2.5
Calf mortality (cases/100 calves born)	4.4
Aid at calving (cases/100 cows)	3.9
Retained fetal membranes (cases/100 cows)	2.2
Milk fever (cases/100 cows)	2.2
Vulval discharge including endometriosis	
(a) % of cows affected (initial cases/100 cows)	5.7
(b) average number of cases per affected cow	1.3
(c) total cases per 100 cows ( $a \times b$ )	7.4
(d) extra cases per 100 cows ( $c - a$ )	1.7
Oestrus not observed	
(a) % of cows affected (initial cases/100 cows)	15.6
(b) average number of cases per affected cow	1.3
(c) total cases per 100 cows ( $a \times b$ )	20.3
(d) extra cases per 100 cows ( $c - a$ )	4.7
Mastitis	
(a) % of cows affected (initial cases/100 cows)	14.1
(b) average number of cow-cases per affected cow	1.2
(c) total cow-cases per 100 cows ( $a \times b$ )	17.3
(d) extra cow-cases per 100 cows ( $c - a$ )	3.2
Lameness	
(a) % of cows affected (initial cases/100 cows)	6.0
(b) cases per affected cow	1.4
(c) total cases per 100 cows ( $a \times b$ )	8.4
(d) extra cases per 100 cows ( $c - a$ )	2.4

targets (Morrow, 1980). De Kruif (1980) recommended visits to cows:

- that have calved during the previous 3–6 weeks and have abnormal histories of parturition and of the early post-partum period;
- not seen in oestrus by 50–70 days post-partum;
- with abnormal discharges or irregular oestrous cycles;
- inseminated three or more times without becoming pregnant;
- served 35–60 days earlier (for pregnancy diagnosis).

Modern practice in the UK would anticipate visits every 1 or 2 weeks (depending on breeding season), and the post-partum period over which cows not seen in oestrus necessitating visits reduced to 42 days. Moreover, an additional item would be included; namely, visits to cows:

- not having received a first service by 63 days post-partum;

with pregnancy diagnosis undertaken from 30 days after being served.

Some veterinarians only conduct pregnancy diagnosis and give advice on management and nutrition, spurning the use of all treatments to influence the timing of oestrus and conception rate.

The introduction, by milk purchasers, of Quality Assurance schemes (NDFAS, 2004), which require a Herd Health Plan, recording of disease rates and trends, and written Action Plans, has provided additional opportunities for improvements in health, welfare and productivity.

### Decreasing important diseases

Mastitis is a major cause of loss of milk yield (Kossaibati and Esslemont, 1997; Kossaibati *et al.*, 1998). A recommended five-point control programme, recognizing the disease's various component causes, was developed by Kingwill *et al.* (1970). It includes:

1. the dipping of teats in a suitable disinfectant immediately after milking;
2. antibiotic therapy of clinical cases;
3. antibiotic therapy of all cows at 'drying off';
4. culling of recurrent cases;
5. improved general husbandry, including milking machine maintenance.

This remains a useful and valid template, which has developed in the detail (Brand *et al.*, 1996; Blowey and Edmondson, 2000a; Erskine, 2001).

Pedal lameness is also an important cause of reduced production, especially when chronic (Kossaibati and

Esslemont, 1997). 'Lameness' is a disease definition based on presenting signs (see Chapter 9) which result from a range of lesions including hoof erosions, white line disease, sole trauma, sole ulceration, sandcrack, aseptic laminitis, digital dermatitis, foul-in-the-foot and interdigital hyperplasia. Component causes relate to host, agent and environment. Digital dermatitis, for example, depends on the presence of an infection; whereas pododermatitis has a genetic component associated with sires (Peterse and Antonisse, 1981) and therefore might be controlled partially by sire selection. Laminitis and the related conditions of white line disease and sole ulcer are caused primarily by lack of comfortable lying time (Colam-Ainsworth *et al.*, 1989; Leonard *et al.*, 1994). Control of lameness therefore depends on identification of the major lesions and manipulation of their component causes. The survey illustrated in Chapter 11 (Figure 11.3) was undertaken to identify the lesions associated with pedal lameness and their importance. Greenough and Weaver (1997) describe hoof lameness and its control.

### Optimum feeding

The correct nutritional balance is important in maintaining optimum milk yield, milk quality and fertility. The possibility of deficiencies or imbalances arising can be estimated in theory by feed analysis, but unrecognized variations in individual food intake within groups of cows can limit the value of conclusions. Blood analysis can be of value in diagnosing some mineral deficiencies (e.g. magnesium, selenium and copper), but failure to appreciate the relationships between dietary content, intake and blood levels can lead to the wrong conclusions.

A popular means of assessing the nutritional balance in dairy herds is the **metabolic profile**, initiated in the 1970s (Payne *et al.*, 1970). This involves estimating the levels of blood constituents that are important components of metabolism related to milk yield, health and fertility. Such constituents include some minerals, protein metabolites and measures of energy balance.

Much has been learned since the initial use of metabolic profiles in dairy cattle. It has become apparent that planning of blood sampling according to feed changes and calving patterns is necessary, and that care must be taken when selecting cows 'typical' of the herd. Useful and sensible interpretation of biochemical results can only be carried out with access to background information on the cows' level of performance, stage of lactation and diet. With these caveats, some authors conclude that practical information can be obtained on the important aspects of the nutritional status of animals (Whitaker, 2000; Kelly and Whitaker, 2001).

## Pig health and productivity schemes

Intensively reared pigs are housed in large units, sometimes with over 100 sows in a herd (Table 1.11).

There are four areas of concern:

1. reproduction in the dry sow;
2. production in the suckling sow;
3. performance of the growing pig;
4. performance of the boar.

Different constraints operate in each area. The dry sow's reproductive potential is governed by the service programme (the rate of reproduction), by the fertility of the sow (the sow's efficiency) and by disease. Productivity of the suckling sow is a function of the farrowing rate, the number of piglets born alive, piglet mortality, diseases of the sow, and the sucking piglets' growth rate. Performance of the growing pig is affected by the type of feed, feed costs, food conversion efficiency, disease and mortality. Boar performance, which affects the reproductive capacity of the sow, is affected by the age of the boar, the boar:sow ratio, frequency of mating, and the litter size and litter scatter<sup>5</sup> attributable to the boar.

The basic variables that should be recorded to produce and regularly update the profile of a pig farm are listed in Table 21.3.

**Table 21.3** Recommended variables to be recorded in a pig herd. (From Deen *et al.*, 2001.)

---

<i>Data recorded in the breeding herd</i>
Sow identity
Birth date or date of entry
Service date and boar used
Abortion date
Farrowing date
Number born alive
Number born dead
Number mummified
Total litter weight at birth
Piglet deaths (recorded as they occur)
Weaning date and number weaned
Weight at weaning (total litter or individual pigs)
Weaner deaths (recorded as they occur)
Sow culling date
Feed consumed by breeding females and by piglets in nursery
<i>Data recorded in the feeder-finishing unit</i>
Identity of group
Date of entering nursery-feeder-finishing unit or date at which 30 kg live weight reached
Group weight at entry
Date sold off farm
Weight at date of sale
Total amount of feed consumed to determine feed conversion ratio
Death losses (recorded as they occur)

---

<sup>5</sup> Litter scatter is the percentage of litters of eight or less.

**Table 21.4** Suggested targets and interference levels for an intensive pig unit in north-east England. (From Muirhead, 1978.)

<i>Index variable</i>	<i>Target</i>	<i>Interference level</i>	<i>Index variable</i>	<i>Target</i>	<i>Interference level</i>
<i>(a) The dry sow</i>			Piglet mortality (%):		
Average number of sows in herd	As determined	Fluctuation of 30% of target	Laid on	5	7
Average age	24 months	30 months	Congenital defects	0.5	1.5
Ratio of average number of maiden gilts:sows	1:15		Low viability	1.5	3
Service programme	As determined	>10% variation	Starvation	1	3
Weaning to service interval average	7 days	9 days	Scour	0.5	2
Normal repeat service (%)	5	8	Miscellaneous	3	5
Abnormal repeat service (%)	3	4	Pigs reared/sow/year	21	19
Abortions (%)	1	2.5	Sow feed (tonnes/year)	1.1	1.2
Sows infertile not in pig (%)	<2	5	<i>(c) The growing pig</i>		
Sow deaths (%)	2	3	Mortality (%)	2.5	3.5
Sows culled due to disease (%)	<2	4	Feed conversion from weaning:		
Farrowing rate (%)	85–89	80	Pork (60 kg)	2.7	2.9
*Litters/sow/year	2.25	2.0	Cutter (80 kg)	2.9	3.2
<i>(b) The farrowing/suckling sow</i>			Bacon (90 kg)	2.9	3.2
Number of piglets born alive/litter	10.9	10	Heavy (115 kg)	3.6	3.8
Number of piglets born dead (%)	5	7	Feed cost/kg liveweight gain	Variable with feed costs	Comparative figures
Number of mummified piglets (%)	0.5	1	<i>(d) The boar</i>		
Number of piglets weaned/litter	9.6	9	Average age	20 months	30 months
Deaths until weaning (%)	8–12	13	Boar:sow ratio	1:20	1:30
**Litter scatter (%)	10	18	Matings/week	4	5
			Matings/sow	2	3
			Mating interval	12 hours (variable)	–
			Boar litter scatter (%)	15	25
			Litter size	9.8–10.8	Obtained by boar comparison
			Conception to first service (%)	>90	85

\* Assuming 5-week weaning

\*\* Litter of 8 or less (see text for definition)

## Targets

Table 21.4 lists target and interference levels (the latter based on experience) for dry sows, suckling sows, growing pigs and boars in an intensively reared pig herd. Alternatively, targets may be set with reference to the performance profile of a number of herds (Table 21.5), the object being to gain a competitive advantage over other producers. Deen *et al.* (2001) discuss performance monitoring and target levels in detail.

## Routine visits

A schedule for regular visits to a pig herd is recommended by Muirhead (1980). Table 21.6 lists components of monthly visits to a herd of 150–300 sows. Visits comprise a standard procedure and discussion of special topics. The standard procedure involves:

- pre-visit preparation, when previous reports, current investigations and clinical problems are studied;

- a clinical examination of the reproductive and service areas, dry sows, the farrowing and weaning areas, and fattening pigs;
- a discussion with the farmer.

Comprehensive examination of a pig herd is described by Goodwin (1971) and Muirhead (1978). Routine preventive measures are described by Douglas (1984).

## Sheep health and productivity schemes

The major areas of concern in sheep health schemes, like schemes in other species, are reproductive efficiency, losses due to disease, and suboptimal production (which may be caused by subclinical disease).

Sheep schemes are designed primarily for lowland flocks. Examples include those developed in England (Hindson, 1982; Holland, 1984; Morgan and Tuppen, 1988; Clarkson and Winter, 1997; Scott, 2001), western

**Table 21.5** PigCHAMP breeding herd summary data, US, 2003. (Source: PigCHAMP 2004b.)

<i>Index variable</i>	<i>Mean</i>	<i>Top 25%</i>	<i>Top 10%</i>	<i>Top 1%</i>
<i>Breeding performance</i>				
Repeat services, %	14.0	9.6	7.1	3.9
Multiple matings, %	88.7	97.6	99.4	99.8
Entry-to service interval, days	36.5	14.0	0.8	0.4
Sows bred by 7 days, %	84.2	89.9	93.2	94.7
Weaning-to-first-service interval	7.6	6.2	5.6	5.1
Average nonproductive days	81.8	59.8	49.1	35.8
<i>Farrowing performance</i>				
Average parity of farrowed sows	3.3	3.9	4.2	4.1
Farrowing interval	146	142	140	138
Farrowing rate, %	74.8	81.4	84.8	88.8
Average total pigs per litter	11.2	11.7	12.0	12.5
Average pigs born alive/litter	10.1	10.5	10.8	11.3
Average stillborn pigs	1.2	0.7	0.6	0.5
Average mummies per litter	0.4	0.1	0.1	0.1
Per cent <7 born alive	12.2	9.5	8.0	6.2
Preweaning mortality (PWM) for farrowed and weaned	13.2	10.6	9.0	7.9
Litters per mated female per year	2.30	2.40	2.50	2.74
Litters per female per year	2.10	2.30	2.40	2.51
Litters/farrowing crate/year	10.3	15.3	17.2	17.3
<i>Weaning performance</i>				
Pigs weaned per litter weaned	9.0	9.4	9.7	10.3
Pigs weaned per sow	8.8	9.2	9.5	10.0
Adjusted 21-d litter weight, lb	123.6	135	145.2	154.1
Average age at weaning	18.0	19.3	21.1	21.0
Pigs weaned/mated female/year	20.4	22.1	23.3	25.1
Pigs weaned/female/year	19.0	20.9	22.2	24.6
Pigs weaned/lifetime	29.3	38.0	43.0	48.0
Pigs weaned/farrowing crate/year	91.4	136.0	154.5	171.9
<i>Population</i>				
Average female inventory (AFI)	1046.4	1335.8	2467.2	1681
AFI/farrowing crate	7.0	7.3	8.6	7.5
Average gilt pool inventory	67.4	87.0	169.3	255.9
Average parity	2.5	3.0	3.5	3.2
Replacement rate, %	65.4	42.9	32.1	39.0
Culling rate, %	43.1	30.9	18.5	12.1
Death rate, %	7.8	4.9	3.0	3.1
Average parity of culled sows	3.5	4.4	5.1	5.3

**Table 21.6** A 12-monthly preventive medicine programme for a herd of 150–300 sows on monthly visits. (From Muirhead, 1980.)

<i>Visit No.</i>	<i>Special topics</i>
(1) Standard procedure*	Herd security
(2) Standard procedure	Stock introduction; methods of gene movement; herd replacement policies; gilt selection requirements
(3) Standard procedure	Economic losses in the herd; feed costs and utilization
(4) Standard procedure	External/internal parasites; vermin control; vaccination programme
(5) Standard procedure	Fertility; boar management
(6) Standard procedure	Herd security check; farrowing sow diseases; parturition, mastitis, etc.
(7) Standard procedure	Piglet problems
(8) Standard procedure	Diseases, mortality and management of the weaned and fattening pigs
(9) Standard procedure	Housing utilization; alterations; associated diseases
(10) Standard procedure	Man management, disease and productivity
(11) Standard procedure	Slaughter house monitoring; pathological tests
(12) Standard procedure	12-monthly appraisal and analysis

\* See text for details.

**Table 21.7** An information sheet recording a farm profile, and illustrating some recorded variables in a lowland sheep flock health programme. (From Holland, 1984.)

INFORMATION SHEET	
(1)	RAMS Nos. Breed(s) – rams – ram lambs
(2)	EWES Nos. Breed(s) – ewes – ewe lambs
(3)	EWES TO TUP Nos. and date
(4)	EWES LAMBED
(5)	LAMBS BORN – alive – dead
(6)	LAMB DEATHS BETWEEN BIRTH AND WEANING
(7)	LAMBING COMMENCED – Date
(8)	LAMBING COMPLETED – Date
(9)	EWES HOUSED/HOUSED AT LAMBING/NOT HOUSED
(10)	RATION (a) ewes (b) lamb creep (c) lamb fattener
(11)	LAMB SALES (a) commenced (c) completed
(12)	COMMENTS ON: (a) Results (b) Problem areas
(13)	COMMENTS ON MASTITIS IN EWES (a) known cases this year (b) previous culling percentage
(14)	CONDITION SCORING FULLY PRACTISED AND UNDERSTOOD?

Australia (Bell, 1980), south-west Australia (Morley *et al.*, 1983), New Zealand (McNeil *et al.*, 1984) and the Netherlands (Konig, 1985).

An initial visit should be undertaken to generate a general farm profile (West *et al.*, 2002), including:

- location of property;
- elevation (flat, hill-country);
- soil type;
- a farm plan;
- livestock profile (Table 21.7).

A detailed history of management practices and levels of disease morbidity should also be documented.

### Targets

Records of past performance of a flock enable the setting of suitable production targets. Examples of targets are given in Table 21.8. In common with other health schemes, accurate records must be kept so that

productivity can be assessed and corrective action taken if shortfalls are detected.

### Routine visits

Advisory visits are made at important stages of sheep management. In Britain, three to six visits per year are advised (Table 21.9).

Condition scoring, examination of udders, mouths, feet and legs, and assessment of fertility are important components of the health scheme. Rams' reproductive functions should be assessed, to determine how closely they conform to accepted standards (Boundy, 1998). Nutrition at all stages, and for all types, of production (maintenance, conception and pregnancy, lactation, wool growth and meat production) is important (Freer and Dove, 2002), and metabolic profiles, based on butyrate examination (Russel, 1985), are valuable.

Specific disease problems should be identified during visits (Hindson and Winter, 1998). In Britain, problem diseases can include infection by orf, foot-rot, infectious abortion, mastitis, swayback, pregnancy toxæmia, mineral and trace element deficiencies, and ecto- and endo-parasitism (Martin and Aitken, 1999). Infection by *Clostridium* spp., however, now is controlled effectively by routine vaccination.

### Beef health and productivity schemes

The beef cattle industry comprises a range of production systems, including breeding (cow-calf; suckler) and fattening (feedlot) enterprises, which are managed under differing conditions. In the US, for example, breeding enterprises tend to utilize rangeland and pasture, whose only economic alternative use is recreation and wildlife. This contrasts with the UK, where beef cattle may be reared as a matter of choice<sup>6</sup>.

The economics of beef production in Europe have become so poor that beef cattle health and productivity schemes hardly exist. Where routine veterinary attention is sought, it is usually confined to investigating possible fertility constraints when failure to conceive has resulted in an unacceptable adult-cow disposal rate. Nutritional causes of this are common, and monitoring through metabolic profile testing in late pregnancy and soon after calving, early enough in the following season, can allow preventive measures to be taken (Whitaker, 2000). Thus, although financial margins are small, programmes to maintain and enhance efficiency can be useful.

<sup>6</sup> Mixed dairy and beef enterprises were common, but there is now a trend towards specialized enterprises.

**Table 21.8** Some suggested production targets for sheep flocks. (Reduced and modified from Scott, P.R. Health and production management in sheep flocks. In: *Herd Health: Food Animal Production Medicine*, 3rd edn. Ed. Radostits, O.M., pp. 765–844. W.B. Saunders, Philadelphia. © 2001, with permission of Elsevier.)

<i>Index variable</i>	<i>Target</i>
<i>Lambing rate</i> Number of lambs born per ewe exposed to the ram per breeding period	1.5–2.00 (varies with breed and the purpose of the flock)
<i>Oestrous cycling index</i> Percentage of females bred in the first 17 days of breeding period	100%
<i>Breeding index</i> Percentage of females bred (marked by ram) per breeding period	100% (for a two-cycle breeding season)
<i>Length of breeding period</i>	35 days
<i>Ram: ewe ratio</i> Depends on the age of the ram, breeding environment (pen or field), ram behaviour, and whether synchronized oestrus is used	
• ram lamb	1:20
• yearling ram	1:25–30
• mature ram	1:40
<i>Pregnancy rate</i> Percentage of females pregnant per female exposed to the ram per breeding period	98%
<i>Abortion rate</i> Percentage of females that abort	<2%
<i>Weaning rate</i> Number of lambs weaned per female exposed to the ram per breeding period	1.5–1.7
<i>Ewes weaning lambs</i> Percentage of ewes that wean at least one lamb	95%
<i>Average daily gain</i> Measured from birth to weaning and adjusted for sex and multiple birth	0.3–0.5 kg/day (dependent on breed and management of the flock)
<i>Age at first breeding/lambing</i> Intensive systems	7–12 months
Extensive conditions	18 months
<i>Culling rate</i> Reasons for culling should be age, not chronic disease such as mastitis and foot-rot	20%
<i>Ewe mortality rate</i> Percentage of ewes that die annually	<2%
<i>Perinatal lamb mortality rate</i> Percentage of lambs born alive that die from birth to weaning	<5%
<i>Stillbirth rate</i> Percentage of lambs born dead	<2%

## Targets

Beef health and productivity schemes are designed to attain optimum reproductive efficiency and to reduce morbidity and mortality in the stock that are being fattened. Traditionally, the number of calves reared is the sole measure of production. The production target of beef rearing is to produce one calf per cow per year. This objective is somewhat optimistic, requiring a breeding season restricted to 6–9 weeks, a 95%

pregnancy rate, and a 100% reared calf crop during each year, none of which usually occurs. In practice, in the UK, a breeding season of 9–12 weeks is considered to be a reasonable target.

Targets depend on the type of production system. *Table 21.10* lists some variables that are suggested as indices of reproduction and production, with target levels, for a North American cow-calf enterprise; whereas *Table 21.11* lists variables under two types of production system in the UK.

**Table 21.9** Plan of visits to monitor a sheep health programme. (Modified from Clarkson and Winter, 1997.)

Visit	Timing of visit	Jobs
Visit 1*	2 months before tupping	1 Rams (all): Condition score, check fertility and feet. Ensure that the farmer/shepherd is able to condition score rams and ewes 2 Ewes (100 selected): Condition score, cull (teeth, age, udders) 3 Store lambs (a selection): Condition score 4 Take samples of blood and faeces for copper, B12, selenium, fluke and worms and abortion profile ( <i>Toxoplasma</i> and enzootic) 5 Check hay or silage and take samples for fibre, protein and energy estimates 6 Inspect pasture, examine for snail habitats 7 Check and discuss Farm Questionnaire (sent and hopefully returned in advance) 8 Discuss 'clean grazing' 9 Discuss farmer's objectives and possible targets for production  Prepare draft programme following this visit and receipt of laboratory results
Visit 2	Approximately 1 month later	Discuss draft programme with farmer and finalize programme
Visit 3*	6 weeks before lambing	Condition score 100 ewes Advise about feeding (including trace elements) Treat clinical cases
Visit 4	2 weeks before lambing	Condition score 100 ewes Advise about housing facilities, colostrum, lambing and recording Treat clinical cases
Visit 5*	At peak lambing time	Clinical events Recording of lambs Advise about hypothermia and starvation, <i>E. coli</i> , coccidia and worming
Visit 6 <sup>†</sup>	12 weeks after lambing	Check growth rates

\* Visits in subsequent years.

<sup>†</sup> When more than one flock is involved with widely different lambing dates, more than six visits will be necessary, although it is probable that some can be combined. In addition to the six planned visits, advice will be available by telephone.

**Table 21.10** Suggested reproductive performance and production variables for a beef enterprise in the US. (From Spire, 1990.)

Index variable	Target	Interference level
<i>Reproduction</i>		
Calf crop (%)	>90	<85
60-day pregnancy rate (%)	>95	<90
First 20-day pregnancy rate (%)	>65	<50
<i>Herd</i>		
Average cow age (years)	5–6	<4, >7
Body condition score		
Mid-gestation	4.5–6.0	<4
Calving	5–6	<4.5
Adult dystokia (%)	<5	>8
Heifer dystokia (%)	<15	>25
Losses during pregnancy (%)	<2	>3
Perinatal losses (%)	<5	>10
Annual cow loss (%)	<2	>5
Culling rate (%)	15–20	<10, >25

### Routine visits

Routine visits should coincide with major events. Chenoweth and Sanderson (2001) suggest that, in breeding herds in North America, the reproductive year should be divided into four periods for spring-calving herds:

1. late winter – early spring;
2. late spring – early summer;
3. late summer – early autumn;
4. late autumn – early winter.

Relevant management procedures and prophylaxis are carried out, and advice is given, during each period. For example, in late winter to early spring, heifers are de-wormed and vaccinated, and bulls checked for vibriosis; whereas in late spring and early summer, external parasites are controlled in cows,



**Table 21.11** Targets for beef suckler herds in the UK (continental sire)

Index variable	Target: upland/low-ground herds		Target: hill herds	
	Autumn calving	Spring calving	Autumn calving	Spring calving
Calving period (max. days)	90	85	100	90
Calves weaned/100 cows bulled	92	92	90	90
Calf mortality	<5%	<5%	<5%	<5%
Barren cows	<6%	<6%	<8%	<8%
Weaning weight of calf (kg)	330	250	270	225

heifers and bulls, and calves are castrated, dehorned and vaccinated.

Beef health schemes are reviewed by Caldow (1984) and discussed in detail by Chenoweth and Sanderson (2001) and Smith *et al.* (2001).

## National schemes

Some schemes operate at the national level and may be subject to legislation (Rees and Davies, 1992). They are frequently part of national control and eradication campaigns (see Chapter 22) directed at diseases that the farmer cannot control alone (e.g., tuberculosis and brucellosis) or at zoonotic infections that are of greater significance to human, than to animal, health (e.g., avian salmonellosis). They therefore contrast with the private schemes which are involved with problems that can be controlled by the stockowner on individual farms (e.g., bovine mastitis).

### Accredited/attested herds

Herds or flocks can be voluntarily certified free from *specified* diseases; they are then described as **accredited** or **attested** (Latin: *testis* = witness). Such schemes include rules for testing animals and maintaining disease-free status. For example, in the UK, the Deer Health Scheme provides a pool of deer herds of tuberculosis-attested health status (ADAS, 1989). Herds must pass three successive tuberculin tests before they are accredited (see *Table 17.20*), after which deer entering the herd must be isolated and tested. Disease status is monitored by regular periodic testing and the compulsory post-mortem examination of deer that die. Members of the scheme must identify all animals, maintain an approved herd record, and report all movements into the herd. Adequate security (e.g., boundary fences and walls) must also be maintained.

In Scandinavia, herds are attested as being free from bovine virus diarrhoea, following serological

and bulk-milk testing, and elimination of persistently infected animals, after which good biosecurity is required to prevent re-infection (Lindberg and Alenius, 1999). Vaccination may also be a component of control<sup>7</sup>.

Accredited/attested herd schemes are frequently the initial component of eradication campaigns; for example, accreditation of herds is the first step in eradication of bovine virus diarrhoea in Scandinavia (Lindberg, 2003). Such schemes are often followed by compulsory test-and-slaughter programmes (usually when the disease has been voluntarily removed from 80–90% of herds). For example, the first attested herd scheme in the UK was introduced in 1935 as the initial stage of a national tuberculosis eradication campaign. Subsequently, a similar approach was adopted to eradicate brucellosis in the UK (MAFF, 1983) and US (Ragan, 2002). Incentives frequently are offered to increase participation (e.g., milk bonuses for participating dairy herds).

### Health schemes

National health schemes establish a pool of herds or flocks of recognized health status. They may be directed at one or more *specific* diseases that may be of economic importance to the livestock industry, but may not currently be suitable candidates for eradication. Alternatively, they may have the *general* aim of improving health and productivity. A consequence is enhancement of the market potential of animals for national and international trade. National health schemes are often run by government veterinary services in collaboration with private practitioners. The former provide field advice and diagnostic facilities, whereas the latter have the flexibility to cater for individual owners' requirements.

<sup>7</sup> Whether or not vaccination is used to control bovine virus diarrhoea depends on the density of cattle and the infection's seroprevalence (Greiser-Wilke *et al.*, 2003).

In Great Britain, four national schemes, comprising programmes for pigs, cattle, sheep and goats, and poultry, were introduced in 1987 (Rees and Davies, 1992). These were all modifications of earlier health schemes.

The Pig Health Scheme aims to improve the general health and productivity of herds, and membership is two-tiered. All participating herds are subject to quarterly visits by government veterinarians and private practitioners and, in the 'higher' health status category, lungs and snouts are monitored at the abattoir to detect enzootic pneumonia and atrophic rhinitis, respectively. More recently, another category – the Pig Assurance Scheme – was added to give purchasers of pigs from registered herds assurances on aspects of medication, welfare and infection with *Salmonella* spp., and to assist producers in the production of food that is 'wholesome' and free from unwanted residues (Lomas, 1993).

In the Cattle Health Scheme, herds are tested for enzootic bovine leucosis (EBL), and may then become EBL-attested. The herds can also be monitored for infectious bovine rhinotracheitis. They can also participate in a *Leptospira hardjo* control programme, in which they may achieve a controlled, officially vaccinated or an elite status, depending on what risk factors for the infection are identified in the herd.

The Sheep and Goat Health Scheme enables participating flocks and herds to qualify for accredited status in relation to Maedi-Visna and caprine arthritis-encephalitis. Additionally, the flocks and herds can be more generally monitored for enzootic abortion of ewes, jaagsiekte and scrapie.

The Poultry Health Scheme ensures freedom from infection with *Salmonella pullorum* and *S. gallinarum*, and includes monitoring for other diseases. There are also guidelines to prevent contamination of eggs by *S. enteritidis*.

In Scotland, the Premium Cattle Health Scheme focuses on the control and eradication of John's disease, bovine virus diarrhoea<sup>8</sup> and infectious bovine rhinotracheitis.

## Companion-animal schemes

Companion-animal health schemes are concerned with disease prevention in the individual animal, rather than in a group (although several individuals may be involved in kennels and stables). Production is

not relevant to companion-animal schemes. (The track performance of racehorses and greyhounds is loosely described as 'production' but the animals are usually more commercial than companion.) Schemes involve:

- routine examination of animals (Jones, 2000);
- prophylaxis, such as vaccination (Greene, 1998a);
- routine therapy, including dosing with anthelmintics (Moore, 1999);
- advice on management relating to diet and housing (Kelly and Wills, 1996; Hand *et al.*, 2000; Morris *et al.*, 2005).

Table 21.12 outlines a health scheme for dogs in the US. This may require modification in other countries (e.g., heartworm prevention and rabies vaccination would be unnecessary in areas where the diseases were absent). Nowadays, companion animals may also be implanted with identity microchips (see Chapter 4). Preventive medicine schemes for 'stable' and 'transient' kennels (e.g., breeding kennels and boarding kennels, respectively) are given by Glickman (1980) and Lawler (1998a). They include nutritional recommendations, vaccination, ectoparasite and endoparasite control, and the management of reproduction and common diseases. Systematic record keeping is advised, to provide a kennel profile, facilitating the detection of deviations from normal breeding performance and expected patterns of morbidity and mortality.

A health scheme for cats in the US is listed in Table 21.13. This can also be modified to suit local conditions (e.g., omission of routine rabies vaccination in countries free from the disease). There are also preventive medicine schemes for catteries (Lawler, 1998b).

Equine health schemes focus on vaccination, parasite control, care of the teeth and feet, and optimum nutrition (Anon., 1989; DiPietro, 1992; Pilliner, 1992; Williamson, 1995). Stable hygiene is also important because infections can be readily spread by fomites such as water buckets, bits, trailers and clothing (Timoney *et al.*, 1988). Table 21.14 is an example of a health scheme from the US. Fraser (1969), Owen (1985) and Loving and Johnston (1995) describe equine schedules in the UK, and Verberne and Mirck (1976) list a programme for use in The Netherlands. Again, the programmes may need to be modified to suit local management practices and the preference of the veterinarian and owner.

Preventive medicine schemes are also described for rabbits (Antinoff, 1999), psittacine birds (Romagnano, 1999), and ferrets (Ivey and Morrissey, 1999).

<sup>8</sup> Bovine virus diarrhoea appeared to have been eradicated from Shetland by 1997 (Synge *et al.*, 1999).

**Table 21.12** General outline of a health scheme for dogs in the US. (Modified from Hoskins *et al.*, 2002.)

<p>I First office visit for health programme – usually at 6 weeks of age</p> <p>A Conduct a general physical examination and record body weight</p> <p>B Check for external parasites and dermatophytes and initiate appropriate therapy</p> <ol style="list-style-type: none"> <li>1 Fleas, ticks and ear mites (<i>Otodectes cyanotis</i>)</li> <li>2 Mange mites, especially <i>Demodex canis</i> and <i>Sarcoptes scabiei</i></li> <li>3 Dermatophytes, particularly <i>Microsporum</i> spp. and <i>Trichophyton mentagrophytes</i></li> </ol> <p>C Conduct faecal examination including both direct smear and flotation</p> <p>D Initiate administration of heartworm preventive management</p> <p>E Administer an anthelmintic for hookworms and roundworms and, if tapeworms are present, administer praziquantel or epsiprantel</p> <p>F Vaccinate against canine distemper/infectious canine hepatitis/leptospirosis/canine parainfluenza virus/canine parvovirus/canine coronavirus, and, possibly, against kennel cough (<i>Bordetella bronchiseptica</i>), canine Lyme borreliosis and <i>Giardia</i></p> <p>G Advise on nutrition and routine grooming</p> <p>H Provide owner with client education pamphlets on topics such as the following:</p> <ol style="list-style-type: none"> <li>1 Identification, treatment and control of fleas, ticks and ear mites</li> <li>2 Benefits of preventive management for canine heartworm disease</li> <li>3 Management of normal and abnormal puppy behaviours</li> <li>4 Skin, nail and ear care</li> <li>5 'How to' on grooming and nutrition</li> </ol> <p>I Complete the puppy's health record for the owner</p>	<p>III Third office visit for health programme – usually at 12 weeks of age</p> <p>A Conduct a general physical examination and record body weight</p> <p>B Check for external parasites and dermatophytes and initiate appropriate therapy.</p> <ol style="list-style-type: none"> <li>1 Fleas, ticks and ear mites (<i>Otodectes cyanotis</i>)</li> <li>2 Mange mites, especially <i>Demodex canis</i> and <i>Sarcoptes scabiei</i></li> <li>3 Dermatophytes, particularly <i>Microsporum</i> spp. and <i>Trichophyton mentagrophytes</i></li> </ol> <p>C Conduct faecal examination including both direct smear and flotation</p> <p>D Adjust dosage of heartworm preventive according to body weight</p> <p>E Administer an anthelmintic for hookworms and roundworms and, if tapeworms are present, administer praziquantel or epsiprantel</p> <p>F Vaccinate against canine distemper/infectious canine hepatitis/leptospirosis/canine parainfluenza virus/canine parvovirus/canine coronavirus and rabies, possibly, against kennel cough (<i>Bordetella bronchiseptica</i>), canine Lyme borreliosis and <i>Giardia</i>.</p> <p>G Adjust nutrition according to health needs and, if needed, change the grooming procedures</p> <p>H Provide owner with client education pamphlets on topics such as the following:</p> <ol style="list-style-type: none"> <li>1 Identification, treatment and control of fleas, ticks and ear mites</li> <li>2 Dental, skin, nail and ear care</li> <li>3 'How to' on grooming and nutrition</li> <li>4 Management of normal and abnormal puppy behaviours</li> <li>5 Recommendations for spaying and castration</li> <li>6 Exercise and its importance</li> </ol> <p>I Complete the puppy's health record for the owner</p>
<p>II Second office visit for health programme – usually at 9 weeks of age</p> <p>A Conduct a general physical examination and record body weight</p> <p>B Check for external parasites and dermatophytes and initiate appropriate therapy</p> <ol style="list-style-type: none"> <li>1 Fleas, ticks and ear mites (<i>Otodectes cyanotis</i>)</li> <li>2 Mange mites, especially <i>Demodex canis</i> and <i>Sarcoptes scabiei</i></li> <li>3 Dermatophytes, particularly <i>Microsporum</i> spp. and <i>Trichophyton mentagrophytes</i></li> </ol> <p>C Conduct faecal examination including both direct smear and flotation</p> <p>D Adjust dosage of heartworm preventive according to body weight</p> <p>E Administer an anthelmintic for hookworms and roundworms and, if tapeworms are present, administer praziquantel or epsiprantel</p> <p>F Vaccinate against canine distemper/infectious canine hepatitis/leptospirosis/canine parainfluenza virus/canine parvovirus/canine coronavirus, and, possibly, against kennel cough (<i>Bordetella bronchiseptica</i>), canine Lyme borreliosis and <i>Giardia</i></p> <p>G Adjust nutrition according to health needs and, if needed, change the grooming procedures</p> <p>H Provide owner with client education pamphlets on topics such as the following:</p> <ol style="list-style-type: none"> <li>1 Identification, treatment and control of fleas, ticks and ear mites</li> <li>2 Benefits of preventive management for canine heartworm disease</li> <li>3 Dental, skin, nail and ear care</li> <li>4 'How to' on grooming and nutrition</li> <li>5 Management of normal and abnormal puppy behaviours</li> </ol> <p>I Complete the puppy's health record for the owner</p>	<p>IV Subsequent visits for health programme – usually annual visits</p> <p>A Conduct a general physical examination and record body weight</p> <p>B Check for external parasites and dermatophytes and initiate appropriate therapy</p> <ol style="list-style-type: none"> <li>1 Fleas, ticks and ear mites (<i>Otodectes cyanotis</i>)</li> <li>2 Mange mites, especially <i>Demodex canis</i> and <i>Sarcoptes scabiei</i></li> <li>3 Dermatophytes, particularly <i>Microsporum</i> spp. and <i>Trichophyton mentagrophytes</i></li> </ol> <p>C Conduct faecal flotation and occult heartworm examination, or all tests, for intestinal and heartworm infection screen</p> <p>D Adjust dosage of heartworm preventive according to body weight</p> <p>E Administer an anthelmintic according to faecal examination findings</p> <p>F Vaccinate against canine distemper/infectious canine hepatitis/leptospirosis/canine parainfluenza virus/canine parvovirus/canine coronavirus, and rabies, possibly, against kennel cough (<i>Bordetella bronchiseptica</i>), canine Lyme borreliosis and <i>Giardia</i>.</p> <p>G Adjust nutrition according to health needs and, if needed, change the grooming procedures</p> <p>H Provide owner with client education pamphlets on topics such as the following:</p> <ol style="list-style-type: none"> <li>1 Identification, treatment and control of fleas, ticks and ear mites</li> <li>2 Dental, skin, nail and ear care</li> <li>3 'How to' on grooming and nutrition</li> <li>4 Management of normal and abnormal puppy behaviours</li> <li>5 Exercise and its importance</li> </ol> <p>I Complete the puppy's health record for the owner</p>

**Table 21.13** General outline of a health scheme for cats in the US. (Modified from Hoskins *et al.*, 2002.)

<p>I First office visit for health programme (usually at 8–10 weeks of age)</p> <p>A Perform a general physical examination and record body weight</p> <p>B Check for external parasites and dermatophytes and initiate appropriate therapy for:</p> <ol style="list-style-type: none"> <li>1 Fleas and ear mites (<i>Otodectes cyanotis</i>)</li> <li>2 Mange mites, especially <i>Notoedres cati</i>, <i>Demodex</i> spp. and <i>Cheyletiella</i> spp.</li> <li>3 Dermatophytes, particularly <i>Microsporum</i> spp. and <i>Trichophyton mentagrophytes</i></li> </ol> <p>C Perform faecal examination, including both direct smear and flotation</p> <p>D Administer anthelmintics, such as pyrantel pamoate for roundworms and hookworms and praziquantel or epsiprantel for tapeworms (if present)</p> <p>E Vaccinate against feline viral rhinotracheitis/feline calicivirus/feline panleucopenia/<i>Chlamydia</i>/feline leukaemia/feline infectious peritonitis/<i>Bordetella</i>/<i>Giardia</i></p> <p>F Advise on nutrition and routine grooming</p> <p>G Provide owner with client education pamphlets on topics such as:</p> <ol style="list-style-type: none"> <li>1 Identification, treatment, and control of fleas, ticks and ear mites</li> <li>2 Benefits of vaccination against feline leukaemia</li> <li>3 Management of normal and abnormal cat behaviour</li> <li>4 Grooming and nutrition</li> </ol> <p>H Complete the cat's health record for the owner</p>	<p>E Vaccinate against feline viral rhinotracheitis/feline calicivirus/feline panleucopenia/<i>Chlamydia</i>/feline leukaemia/feline infectious peritonitis/<i>Bordetella</i>/<i>Giardia</i>/rabies</p> <p>F Adjust nutrition and grooming procedures</p> <p>G Provide owner with client education pamphlets on topics such as:</p> <ol style="list-style-type: none"> <li>1 Identification, treatment and control of fleas, ticks and ear mites</li> <li>2 Benefits of vaccination against feline leukaemia</li> <li>3 Dental, skin, nail and ear care</li> <li>4 Management of normal and abnormal cat behaviours</li> <li>5 Exercise and its importance</li> <li>6 Recommendations for spaying and castration</li> </ol> <p>H Complete the cat's health record for owner</p>
<p>II Second office visit for health programme (usually at 12–14 weeks of age)</p> <p>A Perform a general physical examination and record body weight</p> <p>B Check for external parasites and dermatophytes and initiate appropriate therapy for:</p> <ol style="list-style-type: none"> <li>1 Fleas and ear mites (<i>Otodectes cyanotis</i>)</li> <li>2 Mange mites, especially <i>Notoedres cati</i>, <i>Demodex</i> spp. and <i>Cheyletiella</i> spp.</li> <li>3 Dermatophytes, particularly <i>Microsporum</i> spp. and <i>Trichophyton mentagrophytes</i></li> </ol> <p>C Perform faecal examination, including both direct smear and flotation</p> <p>D Administer anthelmintics, such as pyrantel pamoate for roundworms and hookworms and praziquantel or epsiprantel for tapeworms (if present)</p>	<p>III Subsequent visits for health programme (usually annual visits)</p> <p>A Perform a general physical examination and record body weight</p> <p>B Check for external parasites and dermatophytes and initiate appropriate therapy for:</p> <ol style="list-style-type: none"> <li>1 Fleas and ear mites (<i>Otodectes cyanotis</i>)</li> <li>2 Mange mites, especially <i>Notoedres cati</i>, <i>Demodex</i> spp. and <i>Cheyletiella</i> spp.</li> <li>3 Dermatophytes, particularly <i>Microsporum</i> spp. and <i>Trichophyton mentagrophytes</i></li> </ol> <p>C Perform faecal examination (faecal flotation)</p> <p>D Administer an anthelmintic according to faecal examination findings</p> <p>E Vaccinate against feline viral rhinotracheitis/feline calicivirus/feline panleucopenia/<i>Chlamydia</i>/feline leukaemia/feline infectious peritonitis/<i>Bordetella</i>/<i>Giardia</i>/rabies</p> <p>F Adjust nutrition and grooming procedures</p> <p>G Provide owner with client education pamphlets on topics such as:</p> <ol style="list-style-type: none"> <li>1 Identification, treatment and control of fleas, ticks and ear mites</li> <li>2 Benefits of vaccination against feline leukaemia</li> <li>3 Dental, skin, nail and ear care</li> <li>4 Management of normal and abnormal cat behaviours</li> <li>5 Exercise and its importance</li> <li>6 Recommendations for spaying and castration</li> </ol> <p>H Complete the cat's health record for owner</p>

**Table 21.14** General outline of a health scheme for horses in the US. (Modified from Hoskins *et al.*, 2002.)**First Quarter: January – March***All horses*

Deworm at least every 8 weeks. Exercise care in choice of anthelmintics for mares in the third trimester. Begin deworming foals at 2 months of age. Trim feet every 6 weeks. More frequently in foals requiring limb correction. Dentistry: check twice yearly and float teeth as needed. Remove wolf teeth and retained caps in 2-, 3- and 4-year-old thoroughbreds. Immunize for respiratory disease: influenza, strangles and rhinopneumonitis. In south-eastern US immunize for equine encephalitis.

*Stallions*

Perform complete breeding examination. Maintain stallions under lights if being used for early breeding.

*Pregnant mares*

Immunize with tetanus toxoid and open sutured mares 30 days prepartum. Develop a colostrum bank. Ninth-day breeding only for mares with normal foaling history and normal reproductive tract. Wash udders of foaling mares.

*Non-pregnant mares*

Maintain under lights if being used for early breeding. Perform daily teasing. Perform reproductive tract examination during estrus. Mares should not be too fat but in gaining condition during breeding season.

*Newborn foals*

Dip navel in disinfectant. Carefully, give a cleansing enema at birth. Administer tetanus prophylaxis if indicated by history. Perform immunoglobulin test at 12–24 h.

**Second Quarter: April–June***All horses*

Deworm at least every 8 weeks. Trim feet every 6 weeks. Do not forget the foals and yearlings. Dentistry: check teeth and remove or float teeth as needed. Immunize for equine encephalomyelitis. Administer appropriate vaccine boosters.

*Stallions*

Maintain an exercise programme. Monitor the semen quality.

*Broodmares*

Palpate at 21, 42 and 60 days after successful breeding.

**Third Quarter: July–September***All horses*

Deworm at least every 8 weeks. Clip and sweep the pastures. Trim feet every 6 weeks. Continue corrective trimming on foals. Dentistry: check teeth and remove or float teeth as needed.

*Stallions*

Maintain an exercise programme.

*Broodmares*

Administer rhinopneumonitis boosters to pregnant mares according to manufacturer's labelled directions. Administer appropriate vaccine boosters to foals and yearlings. Check condition of mare's udder at weaning and reduce amount of feed given until milk flow is reduced.

*Foals*

Administer all appropriate immunizations. Provide free-choice minerals. Maintain a protein supplement in creep feeders.

**Fourth Quarter: October–December***All horses*

Deworm at least every 8 weeks. Select anthelmintics appropriate for season. Trim feet every 6 weeks. Continue corrective trimming on foals. Dentistry: check teeth and remove or float teeth as needed.

*Stallions*

Continue exercise programme. Check immunizations. Perform breeding examination.

*Broodmares*

Confirm pregnancy. Begin treating open mares. Check immunizations.

## Further reading

- Andrews, A.H. (Ed.) (2000) *The Health of Dairy Cattle*. Blackwell Science, Oxford
- Brand, A., Noordhuizen, J.P.T.M. and Schukken, Y.H. (1996) *Herd Health and Production Management in Dairy Practice*. Wageningen Pers, Wageningen
- Esslemont, R.J., Bailie, J.H. and Cooper, M.J. (1985) *Fertility Management in Dairy Cattle*. Collins Professional and Technical Books, London
- Hill, F.W.G., Brand, A. and Schukken, Y.H. (1990) Protocols for herd health and productivity control in dairy herds: young dairy stock. In: *The Veterinary Annual*, 30, Eds Grunsell, C.S.G. and Raw, M.-E., pp. 23–33. Wright, London
- Hoskins, J.D., Eades, S.C. and Gill, M.S. (2002) Preventive health programs. In: *Clinical Textbook for Veterinary Technicians*, 5th edn. Eds McCurnin, D.M. and Bassett, J.M., pp. 263–301. W.B. Saunders, Philadelphia
- Moss, R. (Ed.) (1992) *Livestock Health and Welfare*. Longman Scientific and Technical, Harlow
- Radostits, O.M. (Ed.) (2001) *Herd Health: Food Animal Production Medicine*, 3rd edn. W.B. Saunders, Philadelphia
- Sibley, R. (2000) Planning health care on dairy farms. In *Practice*, 22, 405–407
- Smith, M.C. and Sherman, D.M. (1994) *Goat Medicine*, Williams and Wilkins, Baltimore

# 22

## The control and eradication of disease

---

The preceding chapters have outlined the scope of veterinary epidemiology. In reiteration: epidemiology is the study of disease and factors affecting its distribution in populations. This study involves the **description** and **analysis** of disease in groups of animals using three related techniques:

1. observation and recording of the natural occurrence of disease and its determinants, and presentation of the recorded observations;
2. statistical analysis of the observations;
3. modelling.

These three techniques are used in conjunction with clinical, pathological and, sometimes, experimental investigations to:

- estimate disease morbidity and mortality;
- elucidate the cause of disease;
- understand the ecology of disease (transmission, maintenance and nidality);
- investigate the efficiency of different techniques of disease control.

This final chapter outlines the ways in which the results of epidemiological investigations are applied to the **control** and **eradication** of disease.

### Definition of 'control' and 'eradication'

#### Control

'Control' is the reduction of the morbidity and mortality from disease, and is a general term embracing all measures intended to interfere with the unrestrained occurrence of disease, whatever its cause (Done, 1985). It is an ongoing process (Last, 2001).

Control can be achieved by **treating** diseased animals, which therefore reduces disease prevalence, and

by **preventing**<sup>1</sup> disease, which therefore reduces both incidence and prevalence. Veterinary medicine, like human medicine, developed as a healing art concerned with the treatment of sick individuals. This approach continues, with the improvement of medical and surgical skills. However, prevention is an increasingly important part of disease control, being better than cure on humanitarian and, frequently, economic grounds.

#### Eradication

The term 'eradication' was first applied in the 19th century to the regional elimination of *infectious* diseases of animals; notably, Texas fever from cattle in the US, and pleuropneumonia, glanders and rabies from European animals. Since then, the term has been used in four different senses.

First, it has been used to mean the extinction of an infectious agent (Cockburn, 1963); eradication has not been completed if a single infectious agent survives anywhere in nature. According to this definition, very few diseases have been eradicated; human smallpox is an example (Fenner *et al.*, 1988).

Secondly, eradication has been defined as the reduction of infectious disease prevalence in a specified area to a level at which transmission does not occur (Andrews and Langmuir, 1963). For instance, in local areas in northern Nigeria, trypanosomiasis can be

---

<sup>1</sup> Three types of prevention are sometimes distinguished (Caplan and Grunebaum, 1967): *primary*, which modifies determinants to prevent or postpone new cases of disease, and therefore reduces incidence; *secondary*, which detects and treats disease promptly to shorten disease duration or to prolong life; and *tertiary*, which treats long-term cases to reduce dysfunction or to prolong life; (i.e., to make outcome less severe). In this book, prevention is synonymous with primary prevention, whereas treatment encompasses secondary and tertiary prevention.

'eradicated' by clearing the vector (the tsetse fly) from riverine areas.

Thirdly, eradication has been defined as the reduction of infectious disease prevalence to a level at which the disease ceases to be a major health problem, although some transmission may still take place (Maslakov, 1968).

Fourthly, and most commonly in veterinary medicine, eradication refers to the *regional* extinction of an infectious agent. For example, since the eradication of foot-and-mouth disease in the UK, no foot-and-mouth disease virus particles are believed to be present in the country (apart from laboratory stocks). Disease may be accidentally reintroduced into regions from which it has been previously eradicated (e.g., foot-and-mouth disease into European countries in 2001: *Table 1.1*), in which circumstance it is usually subjected rapidly to another eradication programme, to regain disease-free status.

Eradication involves a *time-limited* campaign (Yekutieli, 1980).

**Elimination** The intermediate concept of elimination (Latin: *ex* = out of; *limen*, *liminis* = threshold) can also be identified. This is reduction in the incidence of infectious disease below the level achieved by control, so that either very few or no cases occur, although the infectious agent may be allowed to persist (Payne, 1963; Spinu and Biberi-Moroianu, 1969).

## Strategies of control and eradication

### Doing nothing

In some circumstances, the natural history of a disease is such that the incidence of the disease is reduced by doing nothing. This is not strictly a technique of control, but illustrates that the incidence of disease may be reduced by natural changes in host/parasite relationships without the intervention of man. Thus, bluetongue does not occur in Cyprus in winter because the vector (*Culicoides* spp.) of the causal virus cannot survive then. Similarly, the incidence of trypanosomiasis in the dry savannah regions of Nigeria is reduced during the dry season when the tsetse fly is absent.

### Quarantine

Quarantine is the isolation of animals that are either infected or suspected of being so, or of non-infected animals that are at risk. Quarantine is an old method of disease control (see Chapter 1) that is still very valuable. It is used to isolate animals when they are imported from countries where exotic diseases are endemic; for example, the compulsory quarantine of

dogs, cats and zoo animals when they are imported to some countries to prevent the introduction of rabies<sup>2</sup>. It is also used to isolate animals suspected of being infected, until infection is either confirmed or discounted by clinical examination or laboratory testing (e.g., cows suspected of being infected with *Brucella abortus*). Similarly, when an infectious agent is not spreading within a herd or flock, quarantine may be adopted as part of a control campaign. Ultimately, eradication can be achieved by the gradual removal of affected animals; for example, enzootic bovine leucosis (MAFF, 1981) appeared in the UK in 1978 and was eradicated by 1996 using a policy that included within-herd quarantine of seropositive individuals, which were gradually culled when economically expedient. Quarantine is commonly applied in human medicine during epidemics to isolate infected from susceptible individuals.

The period of quarantine depends on the incubation period of the agent, the time taken for the infection to be confirmed, and the time taken for an infected animal to become non-infectious (either with or without treatment)<sup>3</sup>.

### Slaughter

The productivity of animals usually is decreased when they are chronically diseased. If a disease is infectious, affected animals can be a source of infection to others. In such circumstances it may be economically and technically expedient to slaughter the affected animals. For example, clinical bovine mastitis can produce a 15% drop in the milk yield of dairy cattle (Parsons, 1982); cows that have three or more bouts of mastitis per lactation therefore are often culled.

In eradication campaigns, infected animals may be slaughtered to remove sources of infection. Thus, in some countries, all cloven-hoofed animals in infected herds are slaughtered during foot-and-mouth disease epidemics.

Eradication of specific diseases from herds often involves a '**test-and-removal**' strategy, in which all animals are tested, and only those testing positive are removed and slaughtered. Examples include bovine tuberculosis (see Chapter 17) and porcine reproductive and respiratory syndrome (Dee *et al.*, 2000).

<sup>2</sup> Some regions have abandoned quarantine in favour of a policy that allows freer movement of animals (although unnecessary journeys are eschewed). Thus, in the European Union, dogs and cats can travel between countries, subject to identity microchipping, vaccination against rabies, serological sampling to assess antibody status, and treatment against selected parasites to reduce the risk of transmission of zoonotic diseases (the 'PETS' travel scheme: Fooks *et al.*, 2002; Feeney, 2004).

<sup>3</sup> The word is derived from the Italian '*quaranta*', meaning 40: the number of days for which humans formerly were isolated.



**Pre-emptive slaughter** Culling of infected animals during epidemics is often accompanied by the slaughter of animals that may have been exposed to infection and therefore be at risk of developing disease; for example, those that have had direct contact with people or vehicles that have been in close proximity to infected animals. Although clinical signs of disease might not be present, these animals are removed to pre-empt the possible development of disease, and therefore reduce the risk of further outbreaks.

The **blanket culling** of animals on premises immediately surrounding an infected farm (**contiguous culling**) is a particular category of pre-emptive culling that also aims to 'get ahead' of the disease before clinical signs occur. However, this is a contentious policy (Kitching *et al.*, 2005): although sometimes justified by mathematical models (e.g., for the control of foot-and-mouth disease: Ferguson *et al.*, 2001), field studies have failed to identify a beneficial effect (Honhold *et al.*, 2004; Thrusfield *et al.*, 2005b). It has been described as a 'blunt instrument' (Anderson, 2002), involving the slaughter of a large proportion of healthy animals.

Slaughter of animals in epidemics is usually accompanied by other procedures designed to reduce the risk of transmission (e.g., disinfection, and destruction of carcasses by burning or burial); this is termed '**stamping out**' (see Appendix I and Geering *et al.*, 2001). These two procedures can be laborious (see Chapter 6 for the disinfection protocol used in the Scottish 2001 foot-and-mouth disease epidemic, for instance), fraught with practical problems (e.g., if widespread sub-surface aquifers supplying drinking water limit areas over which carcasses can be buried: Thrusfield *et al.*, 2005a), and costly (e.g., approximately £710 000 000 in the 2001 UK foot-and-mouth disease epidemic: Thompson *et al.*, 2002).

## Vaccination

Vaccines can confer immunity not only to many bacteria and viruses, but also to some helminths. They are used routinely to prevent disease; for example, canine distemper vaccination.

**Strategic vaccination** Vaccination may be deployed **strategically** to prevent incursion of disease from endemic areas, and the spread of disease when epidemics occur; this is **emergency vaccination** (Barnett *et al.*, 2002). There are several strategies, dictated by different circumstances. First, animals in an area surrounding an infected region are vaccinated to provide a circumjacent barrier against spread of infection; this is **ring vaccination**. For instance, in the 1950s and 1960s, rinderpest was endemic in the Karamoja region of north-eastern Uganda but was absent from other parts of the country. A 20-mile-deep ring of cattle

around the region was vaccinated to prevent transmission to disease-free areas. Similarly, ring vaccination is an option if an outbreak of foot-and-mouth disease occurs in the European Union (Donaldson and Doel, 1992; Toma *et al.*, 2002).

Secondly, a barrier, not completely circumscribing an infected region, may be created (**barrier vaccination**). Thus, animals in parts of Bulgaria and Greece bordering Turkey have been vaccinated to prevent entry of foot-and-mouth disease from Asia.

Thirdly, vaccination can be practised both within and around a region where an outbreak occurs; this strategy (which includes ring vaccination) is **suppressive or dampening-down vaccination**. An example was seen in the foot-and-mouth disease epidemic in The Netherlands in 2001 (Bouma *et al.*, 2003).

These three strategies are applied in countries that do not routinely vaccinate. Additionally, vaccination may be undertaken in countries that routinely vaccinate, either to boost immunity following an outbreak, or to provide immunity against novel serotypes of virus.

Emergency vaccines are generally manufactured to a higher potency than routine vaccines. The vaccination strategy is facilitated by preparatory stockpiling of vaccines in vaccine banks (Forman and Garland, 2002).

**Inactivated and live vaccines** Vaccines may be **inactivated** (e.g., by alkylating agents, which render bacterial and virus nucleic acid incapable of replication: Dermer and Ham, 1969). Alternatively, they may be **live**, and the organisms usually attenuated. Each type of vaccine has advantages and disadvantages (Table 22.1). Inactivated vaccines are safer than live vaccines and can be produced more quickly when new agents or serotypes are discovered. However, they cost more than live vaccines, and stimulate mucosal and cell-mediated immunity less quickly and less effectively; therefore, 'booster' doses are frequently required. On the other hand, there is a danger that the live immunizing agent might revert to a virulent form. Also, it may be difficult to differentiate serologically between infections due to live vaccinal strains of agent and to natural 'field' strains (e.g., foot-and-mouth disease: Sørensen *et al.*, 1998; Clavijo *et al.*, 2004; also see below 'Vaccinate or slaughter?').

**Natural vaccination** When animals are exposed to a low level of challenge from agents in the environment, natural vaccination can occur. This mechanism has been enhanced in pigs by feeding faeces back to pregnant animals, a technique called 'feedback'. Immunity to pathogens, for example porcine transmissible gastroenteritis virus and parvovirus (Stein *et al.*, 1982), thus may be increased and passed passively to the

**Table 22.1** Advantages and disadvantages on live versus killed conventional vaccines. (Modified from *The Veterinary Journal*, 164, Babiuk, L.A. Vaccination: a management tool in veterinary medicine, 188–201. © (2002), with permission from Elsevier.)

	Advantages	Disadvantages
Live vaccines	<ul style="list-style-type: none"> <li>Mode of action similar to natural infection</li> <li>Multiply in host; induce range of immune responses</li> <li>Duration of immunity usually long-lasting</li> <li>No adverse side-effects to foreign protein</li> </ul>	<ul style="list-style-type: none"> <li>Possible reversion to virulence</li> <li>Possible contaminating viruses</li> <li>Interference by other agents and passive antibody</li> <li>Storage problems</li> <li>Possible production of latency</li> <li>Possible induction of abortion</li> </ul>
Killed vaccines	<ul style="list-style-type: none"> <li>Quite stable</li> <li>Easy to produce</li> </ul>	<ul style="list-style-type: none"> <li>Require large amounts of antigen/may not contain protective antigens if these are secreted proteins</li> <li>Reactions can develop to foreign protein or adjuvants</li> <li>Immunity is usually short-lived; multiple doses required</li> <li>Do not produce local immunity</li> <li>May not inactivate all of the agent</li> <li>Other agents that are resistant to inactivating agent may be present (e.g., prions)</li> <li>May induce aberrant disease</li> </ul>

piglets via colostrum after birth. Although this may be of value when no other means of control is available, there are dangers (Porter, 1979): some agents, such as enteropathogenic *Escherichia coli* can increase in virulence when passaged *in vivo*.

**New vaccine technology** Modern biotechnology has facilitated new techniques for identifying immunologically active antigens and presenting antigens to the host (Wray and Woodward, 1990; Biggs, 1993; Bourne, 1993; Pastoret *et al.*, 1997; Schultz, 1999). The former include the cloning of T cells specific to small areas of stimulating antigens, and identification of parts of an infectious agent's proteins that are responsible for stimulation of the immune response (epitopes). The latter include attenuated mutants produced by deletion of genes responsible for pathogenicity (e.g., Aujeszky's disease vaccine produced by deletion of the thymidine kinase gene), and 'vectored vaccines': attenuated virus and bacterial vectors which also carry immunizing antigens derived from other infectious agents. Vectors under development include vaccinia, fowlpox, adenoviruses, *Escherichia coli* and *Salmonella* spp., and plasmid DNA to encode *Mycobacterium tuberculosis* antigens (Vordermeier *et al.*, 2000; Buddle *et al.*, 2002), subsequently boosted by recombinant protein (Vordermeier *et al.*, 2003). There are also potential alternatives to conventional whole inactivated vaccines, including synthetic epitopes (produced either chemically or in prokaryotic systems such as *E. coli*) and synthetic virus capsids.

The use of vaccination as a control strategy is discussed in detail by Biggs (1982). The potential and application of vaccination for the control of several parasitic diseases, such as East Coast Fever, fascio-

liasis, echinococcosis, haemonchosis and trypanosomiasis, are described by Urquhart (1980), Willetts and Cobon (1993), Lightowlers (1996), Meeusen and Maddox (1999), Smith (1999) and Dalton and Mulcahy (2001).

### Therapeutic and prophylactic chemotherapy

Antibiotics, anthelmintics, other drugs and hyper-immune serum are used (therapeutically) to treat diseases, and are administered (prophylactically) at times of high risk to prevent disease and thus to increase productivity. Examples include the preoperative and postoperative use of antibiotics to prevent bacterial infections, and the addition of antibiotics to livestock feed to promote growth (a declining practice). These procedures can have undesirable consequences; notably, the selection of strains of bacteria that are resistant to the antibiotic to which they have been exposed. Furthermore, bacterial resistance can be spread by transfer to other bacteria (see Chapter 5).

Sometimes, chemotherapy can be used to eradicate disease. Thus, warble fly was eradicated from the UK through the use of 'warblecides' (MAFF, 1987)<sup>4</sup>.

### Movement of hosts

Animals can be removed from 'high risk' areas where infections are endemic. This control strategy is implemented in tropical countries where hosts are seasonally migrated from areas in which biological vectors

<sup>4</sup> Warbles, which have a marked impact on productivity, affected 40% of cattle in England and Wales, and 20% in Scotland, in the late 1970s, before eradication began.

are active. The Fulani tribe in West Africa traditionally migrate, with their livestock, from the south to the north in the wet season to avoid the tsetse fly. Similarly, horses may be moved indoors at night, to prevent infection with African horse sickness virus, which is transmitted by night-flying vectors of the genus *Culicoides* (Chalmers, 1968).

### Restriction of movement of hosts

The movement of animals is often restricted during epidemics and eradication campaigns to reduce the risk of disease transmission. Thus, during epidemics of foot-and-mouth disease in the UK, the movement of animals is restricted within a 3-km radius of infected holdings (a so-called 'Protection Zone'). Other measures aimed at reducing the risk of disease spread within zones, such as the control of slurry spreading (see Table 6.7) and hunting, are also applied.

Rarely, a ban on animal movements may be enacted nationally; for instance, during the 2001 epidemic of foot-and-mouth disease in the UK (Gibbens *et al.*, 2001b), the goal being to prevent the commonest form of spread of the disease: the movement of infected animals (Donaldson, 1987, 1993). However, such a step should not be taken lightly (HMSO, 1969) because it has far-reaching consequences on trade and welfare (e.g., by possibly depriving animals of access to food). Imposition of the ban in the UK epidemic was justified because the disease was not confined to a single focus (DEFRA, 2002b).

Restriction of international animal movements is important in ensuring that countries remain free from exotic diseases (e.g., banning the importation of live animals and their products from countries in which foot-and-mouth disease is endemic).

### Mixed, alternate and sequential grazing

The level of infection with some nematodes can be reduced by mixed, alternate and sequential grazing (Brunsdon, 1980). The **mixed grazing** of susceptible animals with stock that are genetically or immunologically resistant to helminths reduces pasture contamination to an acceptable level. Thus, adult cattle (immune) can be grazed with calves (susceptible). Similarly, cattle (resistant to *Ostertagia circumcincta*) can be grazed with sheep (susceptible).

The **alternate grazing** of a pasture with different species of livestock again reduces pasture contamination. Thus, annual alternation of sheep and cattle in Norway has reduced to negligible levels the challenge to sheep from nematode species that overwinter (*Ostertagia* spp. and *Nematodirus* spp.: Helle, 1971).

The **sequential grazing** at different times of resistant and susceptible animals of the same species reduces

pasture contamination. Thus, when clean grazing is not available in the late summer and autumn, trichostrongyle infections of calves (susceptible animals) can be reduced by transferring them to pastures that have been grazed by cows (resistant) (Burger, 1976).

Detailed discussions of grazing management strategies to control helminths are given by Barger (1996, 1997) and Niezen *et al.* (1996). These strategies, and other approaches such as vaccination and biological control (e.g., the use of predaceous fungi: see Chapter 7), offer means of helminth control without the risk of resistance attendant on the use of anthelmintics.

### Control of biological vectors

Infectious diseases transmitted by biological vectors can be controlled by removing the vectors. Insect vectors can be killed with insecticides. The habitat of the vectors can be destroyed; for example, by draining land to remove snails that are intermediate hosts of *Fasciola hepatica*. Alternatively, an animal that competes with the vector can be introduced into the habitat; for example, the exclusion of the molluscan vectors of schistosomiasis by a snail that is not a vector (see Chapter 7). Some infections of definitive hosts may be prevented by the elimination of infective material found at post-mortem meat inspection of intermediate hosts; for instance, the inspection of cattle to identify and condemn meat containing *Cysticercus bovis* cysts. Modern recombinant DNA technology offers the prospect of controlling trypanosomiasis in humans and animals by eliminating the ability of the tsetse vector to transmit the pathogen by introducing foreign genes with 'antipathogenic' activity (Beaty, 2000; Aksoy *et al.*, 2001).

### Control of mechanical vectors

Living organisms that mechanically transmit infectious agents can be controlled by destruction and disinfection. Biting fleas that transmit bacteria, for example, can be destroyed by insecticides. People can also act as mechanical vectors; thus the veterinarian must impose a strict procedure for personal disinfection when dealing with outbreaks of highly contagious infectious diseases such as foot-and-mouth disease.

### Disinfection of fomites

Fomites (see Chapter 6) can be disinfected to prevent the transmission of infectious agents. Fomites include farm equipment, vehicles, surgical instruments and sometimes drugs themselves, the last two being associated with iatrogenic transmission (see Chapter 6). Food is heat-treated (e.g., the pasteurization of milk) to destroy microbes and their heat-sensitive toxins, to prevent food-borne infection.

## Biosecurity

'Biosecurity' is a relatively new term for a relatively old concept. It is the application of management practices that reduce the opportunities for infectious agents to gain access to, or spread within, a food animal production unit (Anderson, 1998; Toma *et al.*, 1999). Biosecurity can also be extended to the national level, with the aim of excluding pathogens and pests from a country (Wansbrough, 2004). During epidemics, biosecurity is also relevant to preventing infection being taken from animals on infected farms to healthy animals on 'clean' farms.

Biosecurity encompasses cleanliness<sup>5</sup>, disinfection, reduction of exposure (e.g., maintenance of perimeter fencing<sup>6</sup>, testing of animals before inclusion into a herd, isolation of new additions and diseased animals, and waste management), management of personnel (limiting visitors, adequate training of staff), and ensuring that animals can be traced (England, 2002). Some infections are particularly likely to be introduced by the addition of animals (Barrett, 2001) and so it is important that they are tested appropriately before inclusion (e.g., Table 17.27). Biosecurity is therefore, essentially, the application of 'informed common sense'. Van Schaik *et al.* (2001) discuss the economic aspects of biosecurity measures.

## Niche filling

The presence of one organism within a niche can prevent its occupation by another organism. This is epidemiological interference (a particular case of competitive exclusion, see Chapter 7), and has been investigated experimentally in the poultry industry where suspensions of endogenous intestinal microbes have been fed to day-old chicks to prevent colonization of their digestive tract by virulent *Salmonella* spp. (Pivnick and Nurmi, 1982), *Campylobacter jejuni* and *Escherichia coli* (Nurmi, 1988). This technique of control has the advantage over prophylactic antibiotic chemotherapy that antibiotic resistance is not encouraged. In Sweden, it has been successful in restricting colonization by *Salmonella* spp. nationwide (Wierup *et al.*, 1988) but has had limited success elsewhere (Humbert *et al.*, 1997).

## Improvement in environment, husbandry and feeding

The diseases of intensively produced animals, particularly cattle and pigs, are major contemporary problems (e.g., Webster, 1982), which can be controlled only when epidemiological investigations have identified the determinants associated with inadequate management. The relatively high average levels of mastitis in dairy herds housed in winter in straw-yards (Whitaker *et al.*, 2004), compared with cubicles, makes this point because a proportion in straw-yards, nevertheless, have very little mastitis. This illustrates that it is not the housing system, *per se*, which is responsible, but differences in the way the system is managed (the undesirable provision of damp bedding in this example).

## Genetic improvement

Many diseases of both agricultural and companion animals have a variable heritable component (Foley *et al.*, 1979; Ackerman, 1999). The disease may be determined predominantly genetically, as in canine cyclic neutropenia (the gray collie syndrome: Cheville, 1975), which is carried by a simple autosomal recessive lethal gene. Alternatively, the disease may be determined by several factors, only one of which is genetic, as in canine hip dysplasia (Morgan *et al.*, 2000) whose determinants also include growth rate, body type and pelvic muscle mass. The incidence of such diseases can be reduced by early detection, followed by voluntary agreement of owners of affected animals not to breed from the animals. Established techniques include, for example, radiography to identify hip dysplasia.

A valuable aid to the identification of genetic conditions and predispositions is **genetic screening** (Jolly *et al.*, 1981) to identify diseased animals by screening either the total population at risk or the part that is mainly responsible for the maintenance of a particular disease. The latter technique is commonly applied in veterinary medicine because animal populations tend to be very large, and most animals of 'superior' genetic potential are concentrated in pedigree 'nuclei' that are used for breeding. Human populations are screened to detect hereditary dietary deficiencies (e.g., aminoacidurias, so facilitating dietary control) and to identify serious genetic diseases prenatally so that elective abortion can be considered. In veterinary medicine, the main value of screening is the reduction in defective gene frequency by identifying and removing normal and partially expressed carriers. The relatively short generation time of domestic animals, and artificial breeding techniques, help towards this objective. Thus, in the National Scrapie Plan in Great Britain, screening is used to identify resistant and susceptible sheep, according to the relative resistance of the various genotypes (Table 22.2). The Plan initially

<sup>5</sup> The intuitive value of cleanliness is supported by experimental investigations (Alvarez *et al.*, 2001) and intervention trials (Gibbens *et al.*, 2001a).

<sup>6</sup> Adequate methods for preventing mixing of animals are relevant not only to adjacent livestock but also to feral animals. Visits of badgers to farms to consume cattle feed, for instance, may be a source of transmission of tuberculosis to cattle (Roper *et al.*, 2003).

**Table 22.2** Ovine genotypes and their relative resistance to scrapie. (From DEFRA, 2003.)

Genotype	Type	Degree of resistance/susceptibility
ARR/ARR	1	Sheep that are genetically most resistant to scrapie
ARR/AHQ ARR/ARH ARR/ARQ	2	Sheep that are genetically resistant to scrapie, but will need careful selection when used for further breeding
AHQ/AHQ AHQ/ARH AHQ/ARQ ARH/ARH ARH/ARQ ARQ/ARQ	3	Sheep that genetically have little resistance to scrapie and will need careful selection when used for further breeding
ARR/VRQ	4	Sheep that are genetically susceptible to scrapie and should not be used for breeding unless in the context of an approved controlled breeding programme
AHQ/VRQ ARH/VRQ ARQ/VRQ VRQ/VRQ	5	Sheep that are highly susceptible to scrapie and should not be used for breeding

A = alanine  
H = histidine  
Q = glutamine  
R = arginine  
V = valine

aims to concentrate on promoting the ARR gene (the most resistant), whilst excluding the VRQ gene (the most susceptible), and allowing the continued use of sheep with the AHQ, ARH and ARQ genes for a limited period.

Defects can be identified by clinical examination of animals; for example, canine progressive retinal atrophy (PRA) (Black, 1972). However, the main benefit of screening is in the detection of heterozygotes where disease is either subclinical or is transmitted by healthy carriers. Techniques include test matings, cytogenetic studies (e.g., bovine Robertsonian translocations: Gustavsson, 1969) and biochemical analyses (e.g. bovine mannosidosis: Jolly *et al.*, 1973). The current focus is on the identification of defective genes themselves using recombinant DNA techniques (Goldspink, 1993). Two methods are commonly employed: the **candidate gene** approach, and identification of **linked markers**. The candidate gene technique (Kwon and Goate, 2000) utilizes knowledge of genes in man and the mouse (about which much is known), whose mutations result in diseases that are similar to ones affecting domestic animals. For example, PRA in the Irish setter is similar to retinitis pigmentosa in the mouse, which is caused by the *rde* mutant gene. This facilitated identification of the same gene as the cause of PRA. Linked markers are genes that are so closely associated on the chromosome that they are inherited together in 80% or more of cases. Thus, although causal genes

may not be specifically identified, their approximate location between known markers allows their presence to be detected in animals (Langston *et al.*, 1999). Comprehensive listing of markers is an essential component of mapping of the entire genome, such as that of the dog (Wayne and Ostrander, 2004).

The requirements for a genetic screening programme are listed by Jolly *et al.* (1981):

- the disease must occur in a defined population sufficiently frequently to make the disease of economic or social importance; the defined population may be a family, a herd or a breed of animal within certain geographical boundaries;
- a simple, relatively inexpensive test, capable of identifying heterozygotes with a high degree of accuracy, should be available; as most tests in biological systems do not have a sensitivity and specificity (see Chapter 17) of 100%, there should be provision for follow-up testing, either with a more specific supplementary test or by replication of the original method;
- control by culling of heterozygotes should neither have a deleterious effect on the overall genetic makeup of the population nor deplete breeding stock to an uneconomic or disadvantageous level;
- the logistics of the programme should be acceptable to the breeders and be preceded by adequate educational and public relations programmes;

**Table 22.3** Cost-benefit analysis of a genetic screening programme for bovine mannosidosis in New Zealand, at different levels of heterozygote prevalence. (From Jolly and Townsley, 1980.)

Time horizon	Costs and benefits 10% discount rate	Prevalence of heterozygotes			
		10%	7.5%	5.0%	2.5%
Incurring first	Cumulative costs	\$500 000	\$500 000	\$500 000	\$500 000
8 years	Discounted costs	\$333 433	\$333 433	\$333 433	\$333 433
20 years	Cumulative benefits	\$3 471 600	\$1 910 800	\$874 300	\$211 100
	Discounted benefits	\$963 838	\$530 850	\$243 588	\$58 576
	Benefit: cost ratio	2.89	1.59	0.73	0.18
Infinity	Discounted benefits	\$1 381 527	\$760 951	\$348 951	\$83 994
	Benefit:cost ratio	4.41	2.28	1.04	0.25
Break even time	Undiscounted benefits and costs	9 years	11 years	15 years	>20 years

- the logistics of the programme should satisfy the breeders but not encroach on other necessary disease prevention programmes; where possible, the programme should be integrated with other disease control schemes to simplify specimen collection;
- there should be provision for adequate genetic counselling and either breed society or kennel club rules or legislation to ensure that control is instigated on the basis of information provided by the screening tests.

Table 22.3 illustrates the economic benefit of a screening programme for bovine mannosidosis. This disease causes a lethal nervous syndrome in Angus and Murray Gray cattle. It is inherited recessively; carriers can be detected biochemically because their blood  $\alpha$ -mannosidase levels are approximately half of the normal. The cost-benefit analysis relates to New Zealand, where the prevalence of heterozygotes before the programme was 10%, and approximately one million Angus and Murray Gray calves are born each year, with a total estimated loss due to the disease of \$281 000. Different values for the prevalence, number and value of susceptible cattle, cost of screening test and discount rate affect the results of such an analysis and therefore the economic viability of the control programme, which has effectively reduced the  $\alpha$ -mannosidosis gene prevalence to an insignificant level, with disease incidence reduced from an estimated 3000 cases per year to a negligible level (Jolly, 2002).

Other genetic diseases to which screening can be applied are bovine protoporphyria and canine inherited bleeding and eye defects (Jolly *et al.*, 1981), fucosidosis, a lysosomal storage disease of English springer spaniels (Barker *et al.*, 1988), and portosystemic shunts in Irish wolfhounds (Kerr and van Doorn, 1999). Benefit:cost ratios greater than one have been demonstrated for screening and control programmes for canine hip dysplasia (Swenson *et al.*, 1997a) and elbow arthrosis (Swenson *et al.*, 1997b).

The relationship between phenotype and heritable diseases can also be used to advise owners of an appropriate **selective breeding** policy (Wood *et al.*, 2004). For example, ocular pectinate ligament dysplasia (PLD) is related to the development of adult-onset glaucoma in dogs (Read *et al.*, 1998) and so selective breeding to reduce the severity of PLD may be an appropriate strategy to reduce the incidence of glaucoma, which develops after bitches have reached their peak breeding age. Additionally, observational studies can be used to assess the degree of risk, for dichotomous disease traits (e.g., fragmented coronoid process: Guthrie and Pidduck, 1990), associated with the relatedness of ancestors of cases (Ubbink *et al.*, 1998a). The relative risks obtained by this procedure, which does not require the mode of inheritance to be known, can be used to select suitable breeding stock to reduce the incidence of disease.

The incidence of some infectious diseases also can be reduced by selective breeding (Gogolin-Ewens *et al.*, 1990). For example, certain cattle are known to be tolerant to trypanosomiasis (so called 'trypanotolerant' cattle: d'Ieteren *et al.*, 1998), and there is potential for breeding resistance to helminths (Stear and Bishop, 1999). Other infectious diseases for which genetic resistance has been reported include foot-and-mouth disease and tuberculosis in cattle; jaagsiekte and scrapie in sheep; brucellosis and leptospirosis in pigs; Newcastle disease, infectious bronchitis, Marek's disease and coccidiosis in poultry (Payne, 1982); and salmonellosis in pigs and poultry (Wigley, 2004).

Modern **transgenic biology**, which involves the introduction of specific genes into the genome, now offers a means of changing the genome of the animal more rapidly than it has ever been changed by traditional selective breeding. The techniques are being directed at improved productivity (Ward *et al.*, 1990) but could also be used to introduce artificial genes that block amplification of pathogens and to control non-infectious diseases (Wells and Wells, 2002). Potential veterinary applications include cancer gene therapy,

**Table 22.4** Some eradicable diseases in the UK and chosen methods of eradication. (Updated from Sellers, 1982.)

Method of eradication	Cattle	Sheep	Pigs	Poultry
Slaughter of infected and in-contact animals	Exotic infections, e.g., foot-and-mouth disease	Exotic infections, e.g., foot-and-mouth disease	Exotic infections, e.g., foot-and-mouth disease, classical swine fever	Exotic infections, e.g., Newcastle disease
Identify infected or genetically susceptible animals and either destroy, quarantine, treat or administer prophylactic vaccination or treatment	Tuberculosis, brucellosis, warble fly infection, leptospirosis, enzootic bovine leucosis, Johne's disease, infectious bovine rhinotracheitis (stud bulls)	Johne's disease, scrapie	Tuberculosis, Aujeszky's disease	Pullorum disease, fowl typhoid, egg drop syndrome, fowl pox, duck hepatitis
Improvement of environment and management, and treatment	Streptococcal mastitis, coliform mastitis	Foot-rot, liver fluke	Streptococcal meningitis, mange	Chronic respiratory disease, <i>Mycoplasma meleagridis</i> infection
Minimal disease methods		Maedi-Visna	Enzootic pneumonia, atrophic rhinitis	

the treatment of inflammatory diseases (e.g., arthritis), and lentivirus infections (Argyle, 1999)<sup>7</sup>, as well as manipulation of biological vectors described earlier in this chapter.

For a discussion of the improvement of disease-resistance traits using conventional breeding programmes, markers and transgenic techniques, see OIE (1998) and Axford *et al.* (2000).

### Minimal disease methods

Disease can be reduced in intensively reared livestock by disinfecting infected premises and by treating infected animals or removing them from the animal unit. Uninfected animals can be produced by caesarian section and by hatching uninfected eggs from poultry. These combined techniques are termed **minimal disease methods**. They have been applied commercially only in pig and poultry units. Successes include the eradication of enzootic pneumonia from some pig herds in the UK.

### Choosing appropriate techniques

Techniques of control and eradication have developed gradually. Until the germ theory of infectious disease was adequately supported in the 19th century, only those people who believed in contagion could attempt to control infectious disease. Thus, Lancisi controlled rinderpest in Italy by a slaughter policy (see Chapter 1). Those who accepted the miasmatic theory of cause occasionally succeeded in controlling disease by

applying basic sanitary principles such as disinfection and fumigation.

A combination of the various techniques that have been described is applied to the control and eradication of disease. An example is the use of vaccination, followed by mass testing of animals and slaughter of infected animals to control contagious bovine pleuropneumonia in Nigeria (David-West, 1980) and brucellosis in the UK (MAFF, 1983). The choice of technique involves assessing, technically and economically, the most efficient strategy for a particular disease and system of management (Sellers, 1982), noting that the maximum economic benefits may be affected by agricultural policy (Andersson *et al.*, 1997).

Table 22.4 lists some eradicable diseases in the UK and the methods chosen for eradication. Slaughter and quarantine campaigns against widespread epidemics and exotic diseases usually are conducted at the national level by government veterinary services. These campaigns are frequently supported by legislation.

Vaccination, treatment, alteration in environment and minimal disease techniques generally are carried out at the local level, and often are concerned with individual or herd problems, such as distemper in dogs (vaccination), and helminthiasis in herds of cattle and flocks of sheep (treatment and management practices). Vaccination sometimes may be carried out as part of a national government policy, for example against bovine brucellosis.

**Vaccinate or slaughter?** The need to choose an appropriate strategy is brought into sharp focus when considering either vaccination or slaughter (or a combination of the two techniques). This may arise in both long-term eradication campaigns and the short-term

<sup>7</sup> In human medicine, attention has focussed on single-gene traits such as adenosine deaminase deficiency; but, in veterinary medicine, these can be tackled by selective breeding.

control of epidemics. The choice is usually unique to the disease, and depends on its natural history, characteristics of the available diagnostic tests, availability of vaccines, and economic constraints. Two current examples are the control of bovine tuberculosis and foot-and-mouth disease.

Bovine tuberculosis has been successfully eradicated in many countries and regions using the intradermal skin test, followed by slaughter of reactors. However, the existence of wildlife reservoirs (e.g., badgers in the UK and Ireland, opossums in New Zealand, and the white-tailed deer in the US: Krebs, 1997; de Lisle *et al.*, 2001) has rendered the disease refractory in some areas. The Bacille Calmette Guerin (BCG) vaccine is the only currently available vaccine, but its efficacy is unpredictable in cattle and man<sup>8</sup>. Moreover, it compromises the specificity of the intradermal skin test (Francis, 1947), resulting in false-positive reactions. Thus, 'test-and-slaughter' currently remains the method of choice, despite its lack of success in some areas. However, new vaccines, which do not interfere with the intradermal test, are being developed (Vordermeier *et al.*, 2000), and some may be applicable to wildlife (Buddle *et al.*, 2002), suggesting that vaccination, rather than slaughter, may be a viable option for control in problem areas.

Foot-and-mouth disease is commonly controlled by routine vaccination in countries in which it is endemic, using inactivated vaccine. Current vaccines usually require regular 'boosting' at least every 6 months (Doel, 2003). Epidemics in countries from which the disease is absent may be controlled either by 'stamping out' alone or by emergency vaccination (outlined earlier in this chapter). Alternatively, both techniques can be used together by combining suppressive (dampening-down) vaccination with slaughter of infected animals and their close contacts. However, this generates a problem because vaccination, whilst preventing clinical disease, does not prevent infection. Moreover, vaccinated animals that are subsequently infected may become carriers of the virus (see Chapter 5). Although it is possible to distinguish between infected and vaccinated animals (Mackay, 1996), this discrimination is lost if infected animals have been previously vaccinated. Consequently, in the European epidemic in 2001, any animal displaying foot-and-mouth disease antibody was considered as potentially infected, and could not be exported. Therefore, all animals that were 'emergency-vaccinated' needed to be slaughtered (over 200 000 in The Netherlands: Bouma *et al.*, 2003), so that an affected country could regain disease-free status for the purpose of trade.

<sup>8</sup> See Suazo *et al.* (2003) for a review of the use of BCG vaccine in animals.

However, diagnostic tests that can distinguish between natural infection and vaccination have been developed (Sørensen *et al.*, 1998). Natural infection induces the production of non-structural virus proteins (NSPs), which are not produced following vaccination with purified inactivated vaccines that have had NSP antigens removed (Barteling, 2002). The tests, which detect antibodies to NSPs, used in conjunction with appropriate vaccines, therefore offer the prospect of 'emergency-vaccinating' animals during an epidemic, without the need for subsequent slaughter (so-called 'vaccination to live'). However, there is variation in the magnitude of NSP response in infected animals. Therefore, in the absence of precise estimates of the tests' sensitivity, it is difficult to determine an appropriate sampling protocol for disease detection (see Chapter 13), and all animals in each epidemiological unit may need to be sampled (Clavijo *et al.*, 2004). Moreover, positive results may indicate only previous exposure to virus, rather than carrier animals. Other newer diagnostic methods (e.g., polymerase chain reaction techniques: Callens *et al.*, 1998) may provide the means of identifying virus, thus raising the economically viable prospect of using emergency vaccination, without slaughtering vaccinated animals, and without the risk of continued infection and trade restrictions (Bates *et al.*, 2003). Additionally, new high-potency vaccines may effectively inhibit the carrier state, thereby removing one obstacle to vaccination (Barnett *et al.*, 2004). Suttmoller *et al.* (2003) discuss this topic in a broad review of foot-and-mouth disease.

### Important factors in control and eradication programmes

Before either a control or an eradication campaign can be undertaken, several factors must be considered. These include:

- the level of knowledge about the cause of the disease and, if infectious, also about its transmission and maintenance, including host range and the nature of the host/parasite relationship;
- veterinary infrastructure;
- diagnostic feasibility;
- adequate surveillance;
- availability of replacement stock;
- producers' and society's views;
- the disease's public health significance;
- the existence of suitable legislation with provision for compensation;
- the possible ecological consequences;
- economic costs and the availability of funds for the programme.



### Knowledge of the cause, maintenance and transmission of disease

A complete knowledge of the natural history of a disease, although not always necessary to control or eradicate the disease (recall Lancisi's eradication of rinderpest), is necessary to develop the *most effective* means of control. When the various disease determinants have been defined, often by epidemiological studies, a suitable control strategy can be selected; for example, improving ventilation to reduce respiratory disease in intensively reared pigs. If a disease is infectious, then a knowledge of its incubation period and method of transmission, including the life-cycle and habitat of any vectors, assists in control. If the incubation period is long (e.g., tuberculosis), tests may have to be repeated several times to identify all infected animals. If the generation time (see Chapter 6) is short (e.g., foot-and-mouth disease), diagnosis and removal of affected animals must be rapid. If an infectious agent is aerielly transmitted (e.g., Aujeszky's disease or foot-and-mouth disease), control necessitates visiting all herds that may be infected (see EpiMAN: Chapter 11). In contrast, strictly contagious diseases (e.g., contagious bovine pleuropneumonia) can be controlled by simple quarantine of infected livestock. Careful disinfection of fomites is required when agents

can survive outside the host (e.g., swine fever). A knowledge of the host range of an infectious agent and the host/parasite relationship (considered separately below) is also desirable.

### Host range

An infectious agent that infects or can be transmitted by only one species of host is easier to control than an agent with a wide host range. The global eradication of human smallpox was possible because the virus infected only humans; control, by quarantine and vaccination, therefore needed to be directed towards only humans. Similarly, the British bovine brucellosis eradication programme required control of infection only in cattle because only cattle can transmit *Brucella abortus* significantly. On the contrary, it has already been mentioned that a current obstacle to the control of bovine tuberculosis in England is considered to be the presence of the infection in badgers (Krebs, 1997). Agents that are transmitted by arthropod vectors may be particularly difficult to control because of the problems associated with controlling infection in the arthropod.

Table 22.5 tabulates, for several infectious diseases, the factors that have been discussed.

**Table 22.5** Factors influencing the control of some infectious disease. (Updated from Rees and Davies 1992.)

Disease	Incubation period		Host range			Method of transmission				
	Long <sup>1</sup>	Short <sup>2</sup>	Single	Limited	Wide	Contagious	Fomites	Vectors	Airborne	Vertical/ milkborne
Foot-and-mouth disease		•		•*		•	•	?	•	
Classical swine fever		•	•*			• <sup>3</sup>	• <sup>4</sup>	?		• <sup>5</sup>
African swine fever		•	•*			•	•	•		
Swine vesicular disease		•	•			•	•			
Rinderpest/peste des petits ruminants		•	•*			•				
Vesicular stomatitis		•		•*		•		•	?	
Lumpy skin disease		•	•			?		?		
Rift valley fever		•		•*†				•		
Bluetongue				•*				•		
Sheep/goat pox		•	•			•				
African horse sickness		•		•				•		
Teschen disease		•	•			•	•			
Tuberculosis	•				•*	•	•			
Brucellosis	•		•*			•	•			
Contagious bovine pleuropneumonia	•		•			•				
Maedi-Visna	•		•							•
Scrapie	•		•							•

• Factor characteristic present.

<sup>1</sup> More than 4 weeks (average).

<sup>2</sup> Less than 4 weeks (average).

<sup>3,4</sup> Postnatal infections.

<sup>5</sup> Prenatal infections.

\* The hosts include wildlife.

† The hosts include man.

? Factor characteristic suspected.

### Nature of the host/parasite relationship

Exogenous agents (see Chapter 5) have been, and still are, the causes of the major animal plagues (Table 1.1). Control is relatively straightforward and eradication is possible. Infected animals can be identified relatively easily using clinical and laboratory diagnosis, and can be removed by slaughter or quarantine.

The endogenous agents, by definition, however, are ubiquitous and their eradication is therefore impracticable because it would require elimination of the agent from most animals, including healthy ones in which no disease is present. Many infections of intensively reared animals are endogenous. Diseases in which endogenous agents are incriminated are best controlled by alteration of other determinants; for example, by improving hygiene to prevent mastitis involving *E. coli*.

### Veterinary infrastructure

Veterinary services must be capable of implementing control and eradication campaigns. There are three main requirements:

1. a mobile field service, comprising adequately trained veterinarians and veterinary auxiliaries;
2. adequate diagnostic facilities;
3. adequate research facilities.

The first two requirements are important when controlling the infectious diseases such as the classic animal plagues whose causes are understood. The third requirement must be fulfilled to improve the techniques of controlling the diseases whose causes are not known, and is also needed to elucidate the causes of new and emerging diseases, such as those of intensive animal production, so that the most appropriate control strategies can be selected.

Many developed countries possess the first two requirements, mainly because their veterinary services evolved at the beginning of the 20th century to deal with the major plagues that were common then, such as foot-and-mouth disease, pleuropneumonia and rinderpest. However, fulminating epidemics usually put considerable strain on resources. The epidemic of foot-and-mouth disease in the UK in 2001, for example, required substantial supplementation of government veterinary staff by veterinarians from general practice, overseas, universities and research institutes, as well as involving veterinary students and additional ancillary staff (Figure 22.1).

The developing countries often lack the first two requirements. These countries have over half of the world's livestock units (see Table 1.8) but contain only 20% of the world's veterinary force. Disease control programmes in these countries therefore should include two stages (Mussman *et al.*, 1980):

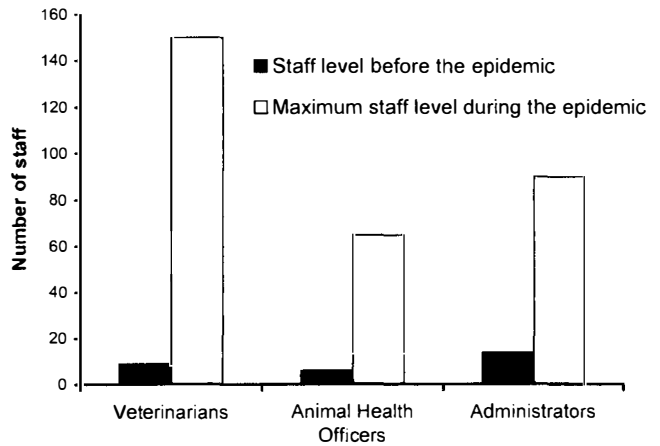

Fig. 22.1 Staff levels in the Ministry of Agriculture, Fisheries and Food (renamed the Department for Environment, Food and Rural Affairs) in south-west Scotland, during the epidemic of foot-and-mouth disease in the UK in 2001. (From Thrusfield *et al.*, 2005a.)

1. a short-term programme that includes the development of diagnostic and field services, training of personnel to deal with the major exotic diseases, and associated control techniques, such as prevention of entry of diseases across borders;
2. a long-term programme, similar to those present in some developed countries, that includes disease reporting systems, facilities for field surveys, and economic and epidemiological modelling.

### Diagnostic feasibility

Control and eradication can be carried out successfully only if a disease can be recognized. The main techniques of recognition are by:

- clinical signs;
- pathological changes;
- isolation of causal agents;
- demonstration of an immune, allergic or biochemical response, or novel nucleotide sequences;
- epidemiological identification of changes of a variable in a population.

Presenting signs may be observed either in the individual sick animal or in its offspring (e.g., congenital abnormalities). The value of signs varies because they can be either pathognomonic or indicative of general lesions and causes (see Figure 9.3).

Identification of pathological changes may substantiate clinical impressions and may be of value when clinical signs are absent, but again the changes may have several causes.

Isolation of causal agents is the most valuable means of identification of disease, but agents may be missed in a specimen (i.e., there may be false negatives).

Identification of an immune reaction is frequently used in control programmes. It should be recalled that each serological test has its own inherent diagnostic sensitivity and specificity (see Chapter 17) whose acceptability for the control programme must be considered. Recall, too, that the predictive value of a test depends on the prevalence of the disease: the predictive value of a positive result decreases as control reduces prevalence because the proportion of false positives increases, and so appropriate test strategies must be identified (see *Table 17.20*). Moreover, tests need to be applied with regard to a disease's natural history and the goals of the testing (e.g., screening herds versus testing animals before inclusion in a herd; see *Table 17.27*).

Epidemiological diagnosis includes the detection of changes in production trends in populations, for example by constructing Shewhart charts and cusums (see Chapter 12).

### **Adequate surveillance**

Control and eradication programmes require effective surveillance (Chapter 10). Several surveillance and monitoring systems have been introduced in Chapter 11, where the principles of data collection were also described. They are therefore not discussed further. When new national or international disease control policies are formulated, the options for surveillance may need to be reassessed. Existing data-gathering procedures may be utilized; alternatively, new systems, based on active data collection (e.g., NAHMS: see Chapter 11), may be developed. Davies (1993) discusses the merits and disadvantages of these two approaches in the context of the European Union. Sudden outbreaks of infectious disease require prompt surveillance to identify potential sources and spread of infection; an example is given below ('Outbreak investigation').

### **Availability of replacement stock**

If a control or an eradication campaign involves the slaughter of many animals, sufficient replacement stock should be available in the livestock industry to minimize disruption to production. This consideration has not been critical hitherto, although it has been cited as a potential problem if a slaughter campaign were used to control or eradicate bovine tuberculosis in developing countries (FAO/WHO, 1967).

### **Producers' opinions and co-operation**

The opinions of animal producers can affect the success of control and eradication campaigns. In Mexico in the 1940s, a slaughter campaign to eradicate foot-

and-mouth disease had to be abandoned because local farmers strongly disagreed with the technique. Producers' opinions and the degree of their co-operation are influenced by their understanding of the control campaign; an important preliminary step is a detailed explanation of its rationale to farmers. In developed countries, pamphlets and audio-visual presentations, such as posters at ports of entry warning of the risk of bringing rabies into the UK, are useful. In developing countries, especially where illiteracy is widespread, these techniques may not be satisfactory and may need to be replaced or supplemented by more direct contact with farmers (Chain, 1980). However, educational campaigns may not always be fruitful. For example, a campaign by the Dutch Ministry of Public Health to increase veterinarians', physicians' and the public's awareness of toxocariasis achieved little (Overgaauw, 1996).

### **Public opinion**

The opinion of society may be an important consideration in a possible control or eradication scheme. Bovine brucellosis and canine distemper have a similar natural history. Both are transmitted by a single host species: cattle in the case of brucellosis, dogs in the case of distemper (ferrets and mink are excluded because their contribution is minor). In situations where bovine brucellosis can be eradicated on economically justifiable grounds, a vaccination and slaughter campaign is socially acceptable in most countries (excepting Hindu countries for religious reasons). A slaughter campaign to control distemper, even though technically feasible, would not be acceptable in many Western countries because of social attitudes towards dogs. In other countries, slaughter of companion animals may be acceptable to the public; for example, in China, slaughtering dogs to improve environmental hygiene (*The Times*, 1983) and culling cats to reduce the putative risk of transmission of severe acute respiratory syndrome (SARS) (*Daily Mail*, 2004). The epidemic of foot-and-mouth disease in the UK in 2001 revealed the public's concern over the mass slaughter of animals when supposedly effective vaccines were available, and provides impetus for 'vaccination to live' strategies (Scudamore, 2004).

Again, education of the public plays an important part in influencing attitudes. The virtual eradication of echinococcosis from Iceland over the last century was achieved by explaining to the public the dangers of keeping dogs unhygienically (Beard, 1973), beginning with the publication, in the 19th century, of a pamphlet that outlined precautions against infection (Krabbe, 1864). More recently, canine genetic disease control programmes in Finland have received the support of dog owners (Leppänen *et al.*, 2000a) and breeders

(Leppänen *et al.*, 2000b) as a result of their awareness of the benefits.

Knowledge of **anthropology** may also be valuable. In the border region of New Guinea, oestrous-postponement drugs have been injected into village bitches to regulate the dog population in relation to the control of diseases, such as rabies, that might enter the country from Indonesia. Treated dogs were tagged with brightly coloured discs. However, villagers removed the discs to wear for personal adornment. Thus, treated bitches subsequently could not be identified.

### Public health considerations

Over 70% of the known pathogens are infectious to both man and other animals. Many of these – the zoonoses – are naturally transmissible between man and animals. The control of zoonotic diseases is the main concern of veterinary public health authorities.

The public health significance of a disease may be a major factor in determining the need for control, usually when human infection is either fatal (e.g., rabies, tuberculosis, and, in the past, glanders) or when the infection can be clinically severe, such as occupationally acquired leptospirosis, brucellosis or anthrax in farmers and abattoir workers.

In many cases, however, prevention of human infection is secondary to control of the infection in animals. Routine prophylactic administration of anthelmintics to dogs, for instance, is practised primarily to prevent clinical and subclinical disease in dogs, although animal owners sometimes are made aware of the potential risk of human infection (e.g., Woodruff, 1976). The control of infectious disease in livestock is usually undertaken because of the financial impact of diseases; a decrease in the incidence of human infection is an added bonus, for example when controlling bovine brucellosis.

### The requirement for legislation and compensation

Control and eradication programmes are more effective when supported by legislation, sometimes accompanied by penalties when the legislation is contravened. For example, in Australia, New Zealand, Papua New Guinea and other areas in which rabies is absent, there is legislation forbidding the entry, without quarantine, of animals from countries in which the disease is present. Severe fines are imposed (and the imported animals sometimes destroyed) if the legislation is ignored.

The benefits of disease control in agriculture are frequently realized by the consumer; thus, tuberculosis eradication results in uninfected milk. The culling of an infected cow, however, represents a financial loss to the farmer. An essential part of many control pro-

grammes therefore is the compensation of producers for the loss of infected animals as a result of the programme. Thus, from February 1990, farmers were awarded 100% of the value of affected cattle as part of the bovine spongiform encephalopathy control programme in the UK. In other cases, bonuses can be offered to increase cooperation of owners; for example, awarding a bonus to farmers whose herd bulk milk somatic cell count (which is an indirect measure of bovine mastitis) is below a defined level; and those whose herd bulk cell count is above the defined level, are penalized.

### Ecological consequences

It has been argued that control and, particularly, eradication of an infectious agent may disturb the 'balance of nature' in an ecosystem (see Yekutieli, 1980, for a detailed discussion). The elimination of an infectious agent may free a niche that could be occupied by a more virulent organism.

The use of insecticides to destroy arthropod vectors could kill other animals in the arthropods' ecosystem. These considerations have, so far, only been theoretical in relation to animal disease control, although the use of insecticides to control insect pests has resulted in the death of other animals, such as birds that have ingested the insecticides (Carson, 1963).

Similarly, anthelmintic residues might disturb the ecosystem. For example, concern has been expressed over the avermectin group of parasiticides which can be excreted unchanged, and so, through their effect on insects that breed in dung, might affect the rate of decomposition of dung pats, with consequent local effects on soil composition and earthworm populations, and more widespread effects on pastureland ecology (Herd *et al.*, 1993). However, such adverse effects have not been unequivocally demonstrated (Herd *et al.*, 1993; Wratten *et al.*, 1993).

### Financial support

Control and eradication campaigns require financial support. The control of companion-animal diseases readily draws financial support from owners; canine, equine and feline vaccination programmes are examples.

Livestock disease control campaigns are usually funded either totally or partially by the government or by non-governmental sources (Parsons, 1982). Total government support is often given to the control of exotic infectious diseases of major economic importance. Diagnostic tests, vaccines, disinfection, compensation, quarantine facilities and veterinary staff are funded by the government. Examples of such diseases are foot-and-mouth disease and swine vesicular

disease. There may be partial government support; for example, when a control scheme is initially voluntary and then compulsory (funded by the government). An example is the British bovine brucellosis scheme which initially was financed by farmers, with incentives and compensation awarded for inclusion in the scheme, and which then became compulsory. Alternatively, costs may be shared by government and the livestock industry; for example, in Britain, before sheep scab was deregulated, the disease was controlled by dipping; the dips were provided by farmers; veterinary supervision was funded by the government. Occasionally, the programme may be funded entirely by the producer (e.g., bovine virus diarrhoea eradication in Sweden: Greiser-Wilke *et al.*, 2003).

State financial support may also be provided indirectly; for example, through the state laboratory diagnostic services and participation in herd health schemes. Non-governmental financial support is supplied indirectly by the pharmaceutical industry in the development of therapeutic and prophylactic drugs and vaccines. In Israel, a part of farm insurance premiums is directed towards disease control; and in parts of Germany some of the costs of bovine virus diarrhoea eradication are funded from public animal insurance (Greiser-Wilke *et al.*, 2003). The extent of government support is reflected by current political and economic attitudes. Support may be reduced in circumstances when the government becomes less 'paternalistic' and when it supports private enterprise rather than state control.

In all cases of financial support, the cost of control has to be weighed against the cost of disease.

### **Control or eradication?**

The ten factors discussed above are relevant to both disease control and eradication. However, in the livestock sector, governments usually need to decide on the final objective: control or eradication of a disease in national herds and flocks (Rees and Davies, 1992). Recall that the former is an ongoing process, requiring regular financial support, whereas the latter is time-limited. Eradication is therefore the more attractive option because its costs are limited to the duration of the programme, whereas its benefits are enduring. However, before an eradication campaign is undertaken, a government must be certain that:

- all technical resources (e.g., manpower) are available;
- the agricultural community fully supports the policy to reduce the risk of illegal trade in infected animals;
- state borders can be adequately 'policed';

- adequate diagnostic facilities (see above) and other tools (e.g., effective vaccines) are available.

Moreover, eradication programmes should only begin when success is reasonably certain. During the initial and intermediate stages of a campaign, costs usually outweigh benefits; for example, in a programme to eradicate an infectious disease, based initially on vaccination and subsequently on a test-and-slaughter policy. If vaccination failed (e.g., because of movement of infected animals into cleared zones), there could be continuous high costs with few potential benefits.

National control schemes – without eradication – are becoming harder to justify because they need to demonstrate continuous long-term benefits in excess of costs. However, they have a role when the livestock industry is willing to support the control measures (e.g., tick-dipping to control East Coast fever) and when diseases are of public health significance (see above).

### **Outbreak investigation**

Control of disease is a particularly acute challenge when disease occurs as an outbreak, either in isolation or as part of a wider epidemic. Outbreaks may occur when the cause of the disease is either infectious or non-infectious and is either initially known or unknown. In both circumstances, clinical and epidemiological expertise are required, the goals being to prevent further cases and, if applicable, to treat affected animals appropriately. Examples of an outbreak induced by a known infectious cause, and an outbreak ascribed to an initially unknown non-infectious cause, are now explored.

#### **Cause known: foot-and-mouth disease**

Foot-and-mouth disease is a highly contagious disease, which can be spread by animal contact, fomites, and aurally (Chapter 6). In the UK, following confirmation of disease, animals on affected farms are slaughtered, animals within the neighbouring area are subject to movement restrictions, and enhanced bio-security measures are introduced, as outlined earlier in this chapter; the goal of these procedures being to prevent further virus production and dissemination to other susceptible livestock. A detailed veterinary investigation is undertaken on each affected farm to find the source of virus (from which the virus may already have been disseminated to other farms) and to assess the likelihood of animals on other premises having been exposed to infection.

## Dangerous contacts

The immediate task is to identify, and assess, susceptible livestock that may have been exposed to infection; for example, those on adjacent farms that may have had close contact with the infected animals and those that may have been infected by contaminated personnel. If the risk of exposure is considered to be high, the animals are classified as '**dangerous contacts**' and slaughtered to reduce the risk of potential disease occurrence and transmission. If not considered as dangerous contacts, they are subject to regular clinical examination (to identify the disease if it subsequently develops), movement restrictions, and increased biosecurity, to reduce the risk of potential transmission of infection.

## Tracing

Simultaneously, the recent movements of animals, personnel and vehicles from, and to, the affected farm, are **traced**, to identify any potential spread of disease to other livestock premises and to detect a putative source of infection for the affected farm, respectively. This information is gathered by the veterinarian attending the affected farm, and by a team of dedicated field epidemiologists. Multiple vehicle and personnel tracings, such as milk-tanker and feed-lorry tracings, are conducted from information supplied by milk-collection and feed-supply companies. 'Tracing windows', based on the time during which virus may be excreted from infected animals, are then defined.

**Forward (spread) tracings** Forward (spread) tracings focus on potential spread of disease to other livestock premises. All movements of animals, personnel and vehicles from the affected farm to other premises from the beginning of the maximum incubation period (14 days: Garland and Donaldson, 1990) to the date when movement restrictions were imposed (when disease is reported and investigated) are considered. However, to take account of the accepted precision of ageing of lesions as being  $\pm 1$  day for lesions up to 7 days old (MAFF, 1986), the actual 'tracing window' 'opens' 15 days prior to the estimated date of first (i.e., oldest) clinical lesion (the earliest time that infection could have arrived on the farm, and therefore be distributed to other farms) and is 'closed' on the date of disease reporting and investigation (when stringent controls are instituted, and therefore no infection can leave the farm) (*Figure 22.2*). Animals on premises thus identified are then assessed and either categorized as dangerous contacts (and therefore slaughtered) or placed under appropriate restrictions and subjected to regular clinical inspections, conservatively until 21 days after exposure.

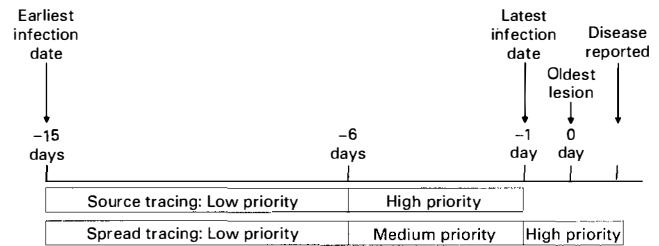

**Fig. 22.2** Forward (spread) and backward (source) tracing 'windows' used in investigating an outbreak of foot-and-mouth disease. (Modified from Thrusfield *et al.*, 2005a.)

Visits are prioritized within the 'tracing window'. Highest priority is given to the period from the date of the oldest lesion (minus 1 day, to account for the precision), from when virus is likely to be shed. Medium priority is accorded to the 5-day period before the latest infection date, representing the average incubation period of the disease during which virus may have been present on the farm (Gibbens and Wilesmith, 2002).

**Backward (source) tracings** Backward (source) tracings address putative sources of infection. Animals showing signs of disease are considered to have been exposed to infection at some time during the 2–14 days prior to the appearance of the first lesions (2–14 days being the accepted range of the incubation period for foot-and-mouth disease: Sellers and Forman, 1973; Garland and Donaldson, 1990). Thus the source 'tracing window' opens 15 days before the estimated date of the first lesion; this comprises the 14 days maximum incubation period plus one day to allow for the accepted precision of lesion-ageing (*Figure 22.2*). The window is 'closed' one day before the estimated date of the first lesion, again allowing for the accepted precision of lesion-ageing and a minimum incubation period of 2 days; this is therefore the latest time that infection could have been introduced. Animals on any premises identified by the tracings are then clinically inspected. No further action is taken in the absence of clinical signs of disease.

Visits are again prioritized, with high priority being given to the 5-day period before the latest infection date, consistent with the average incubation period.

The tracing procedure, if implemented comprehensively, should therefore both identify potential sources of infection of the affected holding and 'capture' all farms potentially infected by it<sup>9</sup>. If the outbreak is one of many, then tracing can be extensive. Thus, in the epidemic in the UK in 2001, with 2030 outbreaks (*Figure 4.1b*), approximately 80 000 sheep flocks, alone,

<sup>9</sup> Airborne transmission is excluded from this assessment, but may be explored by meteorological virus dispersion models (Chapter 6),

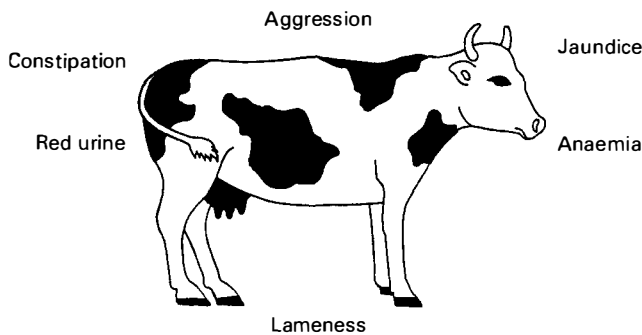

Fig. 22.3 Clinical signs associated with mortality in cattle on a farm in South Africa, 1989.

were inspected as part of the epidemiological inquiries linked to affected farms (DEFRA, 2002a).

Thrusfield *et al.* (2005a) report this example in greater detail.

An example of forward and backward tracing in classical swine fever outbreaks is given by Elbers *et al.* (2001b).

### Cause unknown: chronic copper poisoning

The following example relates to chronic copper poisoning in cattle (*Bos indicus*) on a farm close to the Kruger National Park in South Africa in the late 1980s (Gummow *et al.*, 1991).

Initially, a clinical history was taken. The farmer reported that 39 out of 189 cattle had died over 3 months in the current year (1989), demonstrating signs of a haemolytic crisis (Figure 22.3). The obvious differential diagnosis for the region, based on clinical signs, included vector-borne haemoparasitic disease (i.e., babesiosis or anaplasmosis), but examination of blood smears failed to demonstrate the parasites. The private veterinarians who were involved diagnosed leptospirosis, based on the gross pathology, and treated the herd with dihydrostreptomycin. However, the antibiotic treatment, followed by vaccination against leptospirosis, failed to alleviate the problem.

An epidemiological investigation involves recording of characteristics of the disease in the **population**, including **when** and **where** the disease occurs. This revealed that all of the deaths occurred in cattle over 18 months of age, although there were younger cattle on the holding. Moreover, there had been no deaths in the previous year (1988), but seven deaths in 1987, when there had also been a high mortality in sheep on the farm. An interesting meteorological finding was that there was above-average rainfall in 1988 and below-average rainfall in 1987 and 1989. The farm was also located in a copper-rich area of the country.

### The accumulated findings:

- clinical signs of a haemolytic crisis<sup>10</sup>;
- only cattle over 18 months of age dying (long accumulation period);
- high case fatality, but low morbidity;
- gross pathology and histopathological evidence of a haemolytic crisis;
- location in a copper-rich area;
- the particular susceptibility of sheep (high mortality in the year when there were only a few deaths in cattle);

are consistent with chronic copper poisoning (Gummow, 1996; Roder, 2001). Gross pathological and histopathological findings, and hepatic copper levels – 343–600 parts per million (ppm) wet matter – were consistent with this toxicity.

Thus, a diagnosis of copper poisoning was made, and surviving animals treated prophylactically with a 'lick' containing zinc sulphate and sulphur.

Additionally, further investigations were required to identify the precise source of the copper. A survey of the area revealed that a large open-cast copper mine was located to the south-east of the farm (Figure 22.4). Meteorological records indicated that the wind usually blew towards the north-west, in the direction of the farm; and occasionally towards the south-east (in the direction of the Kruger National Park). Thus, the source of the copper causing the poisoning could be either air pollution or the soil. Subsequent analysis of copper levels on the surface soil and grass were above the accepted maximum levels for grass (10 ppm) but the deep soil levels were generally low. This suggested that the source was air pollution. Moreover, low levels in washed-grass samples implied that the contamination lay in the dust covering the grass. This explained the temporal relationship between rainfall and mortality: in wet years the dust would be rinsed off the grass, reducing the chance of ingestion.

Examination of copper levels of culled buffalo and impala in the Kruger National Park revealed high organ copper levels only to the south-east of the mine (in which direction the wind sometimes blew<sup>11</sup>), adding credence to the hypothesis of air pollution. Subsequently, a more efficient electrostatic precipitator was fitted to the mine's furnace, reducing air pollution.

This successful investigation demonstrated the following features of the 'epidemiological approach':

<sup>10</sup> The aggression (Figure 22.3), reported by the farmer, was a coincidental behavioural finding in some cattle, and therefore constituted a 'red herring'.

<sup>11</sup> The relatively small home ranges (see Chapter 7) of these species maintained the concentration of affected animals under the plume.

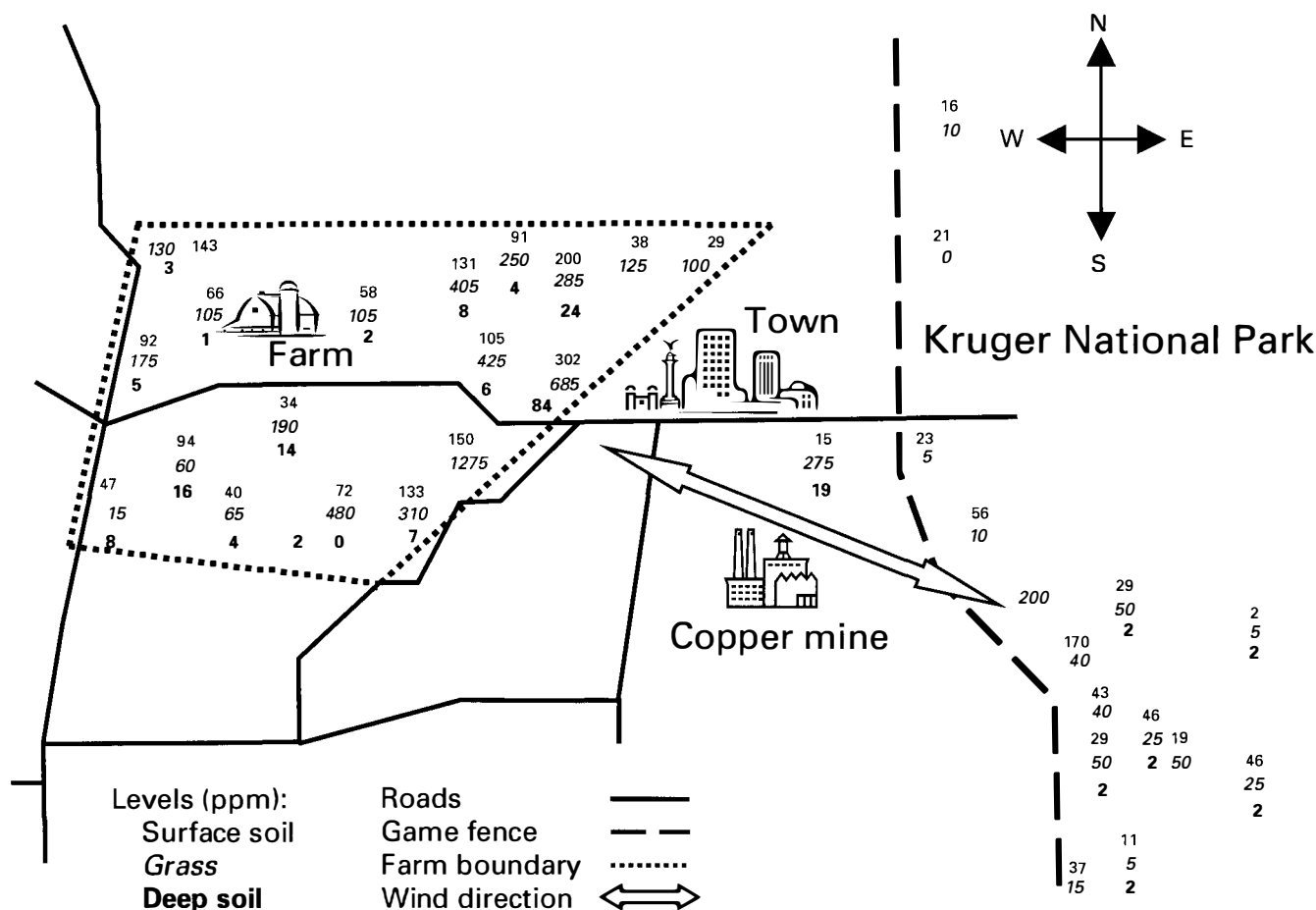

Fig. 22.4 The distribution of soil and grass copper levels (dry mass in parts per million, ppm) in an area close to the Kruger National Park, South Africa, 1989. (Redrawn from Gummow *et al.*, 1991.)

- medical 'detective work' (Chapter 2);
- exploration of the temporal and spatial distribution of disease (Chapter 4);
- reasoning by the method of difference (Chapter 3): the problem was greater during dry years;
- recording of age-specific values (Chapter 4): the cumulative nature of the poisoning resulted in cases only becoming clinically apparent in older animals.

It also highlights that epidemiological investigations are as concerned with ruling out disease as with ruling it in. The link to low rainfall periods was inconsistent with vector-borne outbreaks and leptospirosis; the age profile of cases was inconsistent with a vector-borne or infectious disease, and the occurrence in *Bos indicus* – a species relatively resistant to tick-borne diseases – also reduced the likelihood of the disease being vector-borne.

## Veterinary medicine in the 21st century

Chapter 1 described how veterinary medicine coped with various challenges during its development. This final chapter ends with some thoughts on the future direction of the veterinary profession, highlighting the contribution that epidemiology will make. The topic is discussed in greater detail by Henderson (1982), Hugh-Jones (1983), Pritchard (1986, 1989), Michell (1993), IAEA (1998) and Catanzaro and Hall (2002).

### Livestock medicine

Multifactorial diseases are the major problems in intensive livestock enterprises. Investigation of their cause does not involve the study of a simple infectious agent, but of several determinants associated with host, agent and environment. The environment is also



recognized as important because of its significance to animal welfare (Ekesbo, 1992). Observational studies (see Chapter 15) provide a critical framework for identifying the many determinants of disease in intensive enterprises. Epidemiological principles and concepts are also applicable to welfare issues (McInerney, 1991; Willeberg, 1991).

Modelling of livestock units, using variables associated with disease and production, will continue to develop, facilitated by microcomputerized decision support systems (see Chapter 11). These also facilitate definition of the most suitable technical and economic production variables, and provide methods for assessing individual and herd performance (e.g., Huirne *et al.*, 1991, 1992; Huirne and Dijkhuizen, 1994).

In developing countries, there is a need for an improvement in the 'quality' of data. For example, the epidemic infectious diseases such as rinderpest still pose problems, and eradication campaigns require application of appropriate sampling techniques in their terminal stages (see Chapter 13). Participatory epidemiology (Chapter 10) is likely to expand to fulfil this goal. Additionally, there is a move towards privatization of veterinary services in these countries, stemming from a decline in the efficiency of public services due to financial constraints (de Hann and Umali, 1992). This move is likely to expand, although not without some resistance (Turkson and Brownie, 1999).

Methods of identifying infectious diseases are becoming more analytically sensitive and refined. Smaller quantities of antigen can be detected, and subtle differences between strains can be identified using ELISA tests, monoclonal antibodies and the newer molecular techniques (see Chapter 2). All of these techniques are now being applied to the diagnosis of bacterial, virus and parasitic diseases of animals (Ambrosio and de Waal, 1990; Knowles and Gorham, 1990; OIE, 1993). However, they have some disadvantages, and older techniques therefore still have an important role (Wilson, 1993). For example, the analytical sensitivity and specificity of DNA probe technology – which involves a whole new level of complexity – is similar to conventional microscopy in diagnosing human malaria. Similarly, the polymerase chain reaction can produce false positive results due to contamination (Pang *et al.*, 1992) and is relatively slow.

New techniques are producing vaccines that are safer than formerly. For example, sub-unit vaccines comprise only virus capsid antigens and lack nucleic acid, and therefore cannot be pathogenic. Vaccines against helminths (e.g., *Dictyocaulus viviparus*) are few but they have a considerable advantage over the current anthelmintics, with the latter's associated risk of resistance and short period of action. The breeding of resistant stock may be a more useful technique because techniques such as embryo cloning, superovulation

and nuclear transplantation can accelerate this otherwise slow process.

## Companion-animal medicine

In developed countries, the number of pet-owning households is increasing (e.g., Singleton, 1993), and there is a concomitant increase in the proportion of veterinarians engaged in companion-animal practice (e.g., Figure 1.4). The public's expectation of veterinary services will continue to rise and this will be reflected in improvements in the quality of patient care, involving better surgical techniques and medical therapy, and newer diagnostic methods (Leutenegger *et al.*, 2003). All of these are now subject to more critical evaluation than previously in properly designed clinical trials (see Chapter 16) and diagnostic-test validation (see Chapter 17). Advances in gene-targeted cancer therapy, recently evidenced in human medicine (Kaelin, 1999), may also be directed to companion-animal tumours. However, the impact of advances in biotechnology, in general, may be slower than initially anticipated (Nightingale and Martin, 2004).

The aim of medical epidemiologists is to ensure that each person enjoys a long life with morbidity confined to a short period before death<sup>12</sup>. This goal can be shared by veterinarians, and its achievement requires research on improved preventive techniques, such as vaccination, and on the determinants associated with chronic and refractory diseases, such as canine heart disease and dermatoses. Observational studies (see Chapter 15) again provide a critical framework for such research. This research is still hampered by a lack of basic demographic and morbidity data from a wide cross-section of the companion-animal population, although more data are becoming available (Table 4.2). However, the increasing availability of inexpensive microcomputers to veterinary practitioners, and the expansion of computer networks, notably the Internet, should facilitate the gathering and sharing of these data.

Epidemiology plays a central role in the continuing development and improvement of livestock and companion-animal veterinary medicine. Its contemporary objectives have many similarities with those of ancient Greek medicine, described by Hippocrates, in the 'Second Constitution' of Book 1 of his *Epidemics*, as to:

'Declare the past, diagnose the present, foretell the future'

(Jones, 1923)

<sup>12</sup> In some western countries, increased life expectancy is an added goal (USDHHC, 2000).

## Further reading

- Artois, M., Delahay, R., Guberti, V. and Cheeseman, C. (2001) Control of infectious diseases of wildlife in Europe. *The Veterinary Journal*, **162**, 141–152
- Babiuk, L.A. (2002) Vaccination: a management tool in veterinary medicine. *The Veterinary Journal*, **164**, 188–201
- Biggs, P.M. (1985) Infectious disease and its control. *Philosophical Transactions of the Royal Society of London, Series B*, **310**, 259–274
- Blancou, J. (2003) *History of the Surveillance and Control of Transmissible Animal Diseases*. Office International des Epizooties, Paris
- Bourne, F.J. (1993) Biotechnology and farm animal medicine. In: *The Advancement of Veterinary Science. The Bicentenary Symposium Series. Volume 1: Veterinary Medicine beyond 2000*. Ed. Michell, A.R., pp. 41–57. CAB International, Wallingford. (A discussion of the application of modern biotechnology to animal disease control)
- Brander, G.C. and Ellis, P.R. (1976) *The Control of Disease*. Baillière Tindall, London. (A general discussion of the prevention of infectious diseases in animals, including zoonoses)
- Correa Melo, E. and Gerster, F. (Coordinators) (2003) Veterinary Services: organisation, quality assurance, evaluation. *Revue Scientifique et Technique, Office International des Epizooties*, **22**, 355–768. (A global review of veterinary services)
- England, J.J. (Ed.) (2002) Animal health emergency diseases. *Veterinary Clinics of North America, Food Animal Practice*, **18** (3), 1–583. (A general description of some exotic diseases, including their control)
- Geering, W.A., Roeder, P.L. and Obi, T.U. (1999) *Manual on the Preparation of National Animal Disease Emergency Preparedness Plans*. FAO Animal Health Manual No. 6. Food and Agriculture Organization of the United Nations, Rome. (A comprehensive discussion of the procedures and structures necessary for controlling outbreaks of infectious diseases; also containing a list of training aids, including books, interactive software, and videos)
- Geering, W.A., Penrith, M.-L. and Nyakahuma (2001) *Manual on Procedures for Disease Eradication and Stamping Out*. FAO Animal Health Manual No. 12. Food and Agriculture Organization of the United Nations, Rome. (A detailed consideration of the practical aspects of destruction and disposal of animals, and decontamination procedures)
- Gregg, M.B. (Ed.) (2002) *Field Epidemiology*, 2nd edn. Oxford University Press, Oxford. (A medical text, which contains the basic principles of outbreak investigation)
- Hanson, R.P. and Hanson, M.G. (1983) *Animal Disease Control*. Iowa State University Press, Ames. (A description of principles and techniques relating to regional control programmes in developed and developing countries)
- House, J.A., Kocan, K.M. and Gibbs, E.P.J. (Eds) (2000) *Tropical Veterinary Diseases: Control and Prevention in the Context of the New World Order*. *Annals of the New York Academy of Sciences*, Vol. 916. The New York Academy of Sciences, New York
- New Technologies in the Fight against Transboundary Animal Diseases*. FAO Animal Production and Health Paper No. 144 (1999) Food and Agriculture Organization of the United Nations, Rome. (Includes descriptions of advances in epidemiological and diagnostic techniques, and vaccines, relevant to the control of infectious diseases)
- Nielsen, T.G., Christensen, B. and Dantzer, V. (Eds) (1996) Decision of vaccination strategy in relation to increased trade of animals and animal products. *Acta Veterinaria Scandinavica*, Suppl. 90, 1–118
- Pastoret, P.-P., Blancou, J., Vannier, P. and Verschuere, C. (Eds) (1997) *Veterinary Vaccinology*. Elsevier, Amsterdam
- Patterson, D.F. (1993) Understanding and controlling inherited diseases in dogs and cats. *Tijdschrift voor Diegeneeskunde*, **118**, Suppl. 1, 23S–27S
- Perry, B., McDermott, J. and Randolph, T. (2001) Can epidemiology and economics make a meaningful contribution to national animal-disease control? *Preventive Veterinary Medicine*, **48**, 231–260
- Peters, A.R. (Ed.) (1994) *Vaccines for Veterinary Applications*. Butterworth Heinemann, Oxford
- Rees, W.G.H. and Davies, G. (1992) Legislation for health. In: *Livestock Health and Welfare*. Ed. Moss, R., pp. 118–159. Longman Scientific and Technical, Harlow. (A description of national and international control and eradication schemes)
- Report of a British Veterinary Association Trust Project on the Future of Animal Health Control (1982) *The Control of Infectious Diseases in Farm Animals*. British Veterinary Association, London
- Royal Society (2002) *Infectious Diseases in Livestock: Scientific questions relating to the transmission, prevention and control of epidemic outbreaks of infectious diseases of livestock in Great Britain*. Policy document 15/02, The Royal Society, London. (A broad discussion of the issues relating to epidemic control, focussing on the UK, but addressing general principles of wider relevance)
- Schnurrenberger, P.R., Sharman, R.S. and Wise, G.H. (1987) *Attacking Animal Diseases: Concepts and Strategies for Control and Eradication*. Iowa State University Press, Ames. (A general discussion of disease control, mainly with American examples)
- Schudel, A. and Lombard, M. (Eds) (2004) *Control of Infectious Animal Diseases by Vaccination*. Developments in Biologicals, Vol. 119. Karger, Basel
- Schultz, R.D. (Ed.) (1999) *Veterinary Vaccines and Diagnostics*. *Advances in Veterinary Medicine*, **41**, 1–815. Academic Press, San Diego
- US Department of Health and Human Resources (1998) *Preventing Emerging Infectious Diseases. A Strategy for the 21st Century*. US Department of Health and Human Resources, Centres for Disease Control and Prevention, Atlanta. (A comprehensive discussion of the control of emerging human infections in the US, but also including some general principles and details of zoonotic and foodborne infections)
- Winkler, J.K. (1982) *Farm Animal Health and Disease Control*, 2nd edn. Lea and Febiger, Philadelphia
- Wobeser, G.A. (1994) *Investigation and Management of Disease in Wild Animals*. Plenum Press, New York
- Woods, G.T. (Ed.) (1986) *Practices in Veterinary Public Health and Preventive Medicine in the United States*. Iowa State University Press, Ames. (A general discussion of veterinary public health, including environmental health, and animal disease control in the United States)
- Yekutieli, P. (1980) *Eradication of Infectious Disease – A Critical Study*. Contributions to Epidemiology and Biostatistics, Vol. 2. Karger, Basel

# General Reading

---

## Books

- Blaha, T. (Ed.) (1989) *Applied Veterinary Epidemiology*. Elsevier, Amsterdam
- Campbell, R.S.F. (Ed.) (1983) *A Course Manual in Veterinary Epidemiology*. Australian Universities' International Development Program, Canberra
- Dohoo, I., Martin, M. and Stryhn, H. (2003) *Veterinary Epidemiologic Research*. AVC Inc, Charlottetown
- Elliot, R.E.W. and Tattersfield, J.G. (1979) *Investigating Animal Disease Status*. Ministry of Agriculture and Fisheries, Wellington, New Zealand
- Halpin, B. (1975) *Patterns of Animal Disease*. Baillière Tindall, London
- Houe, H., Ersbøl, A.K. and Toft, N. (Eds) (2004) *Introduction to Veterinary Epidemiology*. Biofolia, Frederiksberg
- Hugh-Jones, M.E., Hubbert, W. and Hagstad, H.V. (1995) *Zoonoses: Recognition, Control, and Prevention*. Iowa State University Press, Ames. (Includes some general epidemiological principles and methods)
- Leech, F.B. and Sellers, K.C. (1979) *Statistical Epidemiology in Veterinary Science*. Charles Griffin and Company Ltd, London and High Wycombe
- Lessard, P.R. and Perry, B.D. (Eds) (1988) Investigation of disease outbreaks and impaired productivity. *The Veterinary Clinics of North America: Food Animal Practice*, 4 (1)
- Martin, S.W., Meek, A.H. and Willeberg, P. (1987) *Veterinary Epidemiology: Principles and Methods*. Iowa State University Press, Ames
- Meek, A.H. and Martin, S.W. (1991) Epidemiology of infectious disease. In: *Microbiology of Animals and Animal Products*. World Animal Science, A6. Ed. Woolcock, J.B., pp.141–180. Elsevier, Amsterdam. (Abridged adaptation of Martin et al., 1987)
- Noordhuizen, J.P.T.M., Frankena, K., Thrusfield, M.V. and Graat, E.A.M. (2001) *Application of Quantitative Methods in Veterinary Epidemiology*, revised reprint. Wageningen Pers, Wageningen
- Putt, S.N.H., Shaw, A.P.M., Woods, A.J., Tyler, L. and James, A.D. (1987) *Veterinary Epidemiology and Economics in Africa*. ILCA Manual No. 3, International Livestock Centre for Africa, Addis Ababa
- Schwabe, C.W. (1984) *Veterinary Medicine and Human Health*, 3rd edn. Williams and Wilkins, Baltimore and London
- Schwabe, C.W., Riemann, H.P. and Franti, C.E. (1977) *Epidemiology in Veterinary Practice*. Lea and Febiger, Philadelphia
- Sergeant, E.S.G., Cameron, A. and Baldock, F.C. (2004) *Epidemiological Problem Solving*. AusVet Animal Health Services, Brisbane
- Slater, M.R. (2003) *Veterinary Epidemiology*. Butterworth Heinemann, St Louis
- Smith, R.D. (2005) *Veterinary Clinical Epidemiology*. 3rd edn. CRC Press, Boca Raton
- Toma, B., Dufour, B., Sanaa, N., Bénét, J.J., Moutou, F., Louza, A. and Ellis, P. (1999) *Applied Veterinary Epidemiology and the Control of Disease in Populations*. AEEMA, Paris
- Waltner-Toews, D. (Ed.) (1991) *Veterinary Epidemiology in the Real World: a Canadian Potpourri*. Canadian Association of Veterinary Epidemiology and Preventive Medicine, Ontario Veterinary College, Guelph

## Proceedings

- Epidemiology at Work* (1990) Refresher Course for Veterinarians. Proceedings 144. North Head, 5–7 October 1990. Post Graduate Committee in Veterinary Science, University of Sydney
- Epidemiology in Animal Health* (1983) Proceedings of a symposium held at the British Veterinary Association's Centenary Congress, Reading, 22–25 September 1982. Society for Veterinary Epidemiology and Preventive Medicine
- Epidemiological Skills in Animal Health* (1990) Refresher Course for Veterinarians. Proceedings 143. Sydney, 1–5 October 1990. Post Graduate Committee in Veterinary Science, University of Sydney

Proceedings of the Dutch Society for Veterinary Epidemiology and Economics. 1989– (1989–1990 in Dutch) (continuing) (annual)

Proceedings of the International Society for Veterinary Epidemiology and Economics. 1976– (continuing) (triennial)<sup>1</sup>

Proceedings of the Society for Veterinary Epidemiology and Preventive Medicine. 1984– (continuing) (annual)

## Journals

Papers on veterinary epidemiology are published in a wide range of journals. *Preventive Veterinary Medicine* is the main journal devoted to the subject.<sup>2</sup> National veterinary journals such as *Acta Veterinaria Scandinavica*, the *American Journal of Veterinary Research*, the *Australian Veterinary Journal*, the *Canadian Veterinary Journal*, the *Journal of the American Veterinary Medical Association*, the *New Zealand Veterinary Journal*, *Veterinary Journal* (formerly the *British Veterinary Journal*) and the *Veterinary Record*; disciplinary journals such as *Cancer Research*, the *International Journal of Parasitology*, the *Journal of National Cancer Institute* and the *Journal of Pathology*; and journals specializing in particular species, such as the *Equine Veterinary Journal*, the *Journal of Small Animal Practice* and the *Journal of the*

*American Animal Hospitals Association*, also publish epidemiological papers. *Epidemiology and Infection* (formerly the *Journal of Hygiene, Cambridge*) focusses on infectious diseases. The *Bulletin of the Pan American Health Organization*, *Bulletin of the World Health Organization*, *Revue Scientifique et Technique – Office International des Epizooties*, *Tropical Animal Health and Production* and the *World Animal Review* (now defunct) contain material relevant to developing countries. *Emerging Infectious Diseases* publishes reports of new infections and infections that are increasing in importance. *Animal Health Research Reviews* provides broad descriptions of many diseases.

The *American Journal of Epidemiology* (formerly the *American Journal of Hygiene*) is primarily medical, but occasionally publishes veterinary material. It, *Epidemiology*, and the *International Journal of Epidemiology*, also contain papers on quantitative methods. These methods are also published in statistical journals such as *Applied Statistics*, *Biometrics*, the *Journal of the Royal Statistical Society (Series A and B)*, *Mathematical Biosciences* and *Statistics in Medicine*. *Evidence-Based Medicine* reports clinical trials (including meta-analyses) and assessments of procedures; although primarily medical, the veterinary reader will find some of the methods that are reported in this journal to be of value.

<sup>1</sup> Available at:

<http://www.sciquest.org.nz/default.asp?pageid=68&pub=10>

<sup>2</sup> An overview of the contents of this journal, from 1982 to 1997, is given in volume 30 (1997), pages 181–333; and, from 1997 to 2001, in volume 50 (2001), pages 187–218.

# Appendices

---

Appendices V, IX, XXI and XXIII are taken from Tables III, IV, VII and V, respectively, in *Statistical Tables for Biological, Agricultural and Medical Research*, 6th edition (1974), edited by Fisher, R. and Yates, F. and published

by Longman Group Limited (previously published by Oliver and Boyd Limited, Edinburgh), and are reproduced with the permission of the authors and publishers.

# Appendix I

## Glossary of terms

This glossary provides brief definitions of some common epidemiological terms that are used in this book. More comprehensive guides are *Dictionary of Veterinary Epidemiology* (edited by B. Toma, J.-P. Vaillancourt, B. Dufour, M. Eloit, F. Moutou, W. Marsh, J.-J. Bénét, M. Sanaa and P. Michel, Iowa State University Press, Ames, 1999)<sup>1</sup>, *A Dictionary of Epidemiology*, 4th edition (edited by J.M. Last, Oxford University Press, New York, 2001)<sup>2</sup>, and *The Cambridge Dictionary of Statistics in the Medical Sciences* (B.S. Everitt, Cambridge University Press, Cambridge, 1995), from which some of the definitions below are derived.

**Accuracy:** the degree to which an individual measurement represents the true value of the attribute that is being measured: the greater the accuracy, the greater the degree.

**Adjustment:** a summarizing procedure for a parameter (see Appendix II), for example, incidence or mortality, in which the effects of differences in the composition of populations compared (e.g., different age distributions) are minimized. Two common techniques are **direct** and **indirect standardization**.

**Antibody:** a protein produced by an animal's immunological system in response to exposure to a foreign substance (an antigen; q.v.). Sometimes antibodies are produced against the individual's own proteins, causing autoimmune disease. Antibodies display specificity (q.v.) to particular antigens.

**Antigen:** a substance (usually a protein) that induces a specific immune response (e.g., circulating antibody production).

**Association:** a general term to describe the relationship between two variables (see Appendix II). The association is 'positive' when the variables occur together more frequently than is expected by chance; the association is 'negative' when they occur less frequently than is expected by chance.

**Asymptotic method:** any statistical method based on an approximation to a Normal distribution (q.v.) or other probability distribution that becomes more accurate as sample size increases.

**Bias:** systematic (as opposed to random) departure from true values.

**Binomial distribution:** a probability distribution relating to two mutually exclusive and exhaustive outcomes (e.g., the birth of either male or female animals), where successive outcomes (e.g., births) are independent and occur with constant probability.

**Biosecurity:** management-practice activities that reduce the opportunities for infectious agents to gain access to, or spread within, a food animal production unit.

**Carrier:**

1. an animal that is infected with an infectious agent without displaying clinical signs, and that can be a source of infection to other animals;
2. (**of foot-and-mouth disease virus**) an animal in which virus persists in the pharyngeal region for more than 4 weeks after infection;
3. (**genetic**) an animal that is heterozygous for a normal and an abnormal gene, the latter of which is not expressed but may be detected by tests.

**Case:** an animal in a population or study group identified as having a particular disease or other health-related event that is being investigated.

**Case-control study:** an observational study (q.v.) in which a group of diseased animals (cases) is compared with a group of non-diseased animals

<sup>1</sup> An earlier, shorter French glossary of veterinary epidemiology, with English/German/Spanish/Italian/Portuguese-French indices, is available (Toma *et al.*, 1991).

<sup>2</sup> An English-French and French-English dictionary, based on the 1st edition (1983), is also published (Fabia *et al.*, 1988).

- (controls) with respect to exposure to a hypothesized cause.
- Causality:** the relating of causes to the effects that they produce.
- Clinical trial:** a systematic study in the species for which a prophylactic or therapeutic procedure is intended in order to establish the procedure's prophylactic or therapeutic effects. A 'field trial' is a clinical trial undertaken in the field, that is, under husbandry and management practices typical of those under which the procedure is intended to be used.
- Cohort study:** an observational study (q.v.) in which a group of animals exposed to a hypothesized cause is compared with a group not so exposed, with respect to development of a disease.
- Commensals:** microbes found on the skin or within the body that do not usually cause disease (cf. pathogens).
- Confidence interval:** a range of values within which the value of a parameter (see Appendix II) lies with a specified level of confidence.
- Confounding:** the inseparability from a given data set of the effects of two possible causes of an observed result, because both occur together.
- Continuous variable:** a variable (see Appendix II) that may take any value in an interval; the interval may be finite or infinite.
- Correlation:** see Association.
- Cost-benefit analysis:** see Social cost-benefit analysis.
- Cross-product ratio:** see Odds ratio.
- Cross-sectional study:** an observational study (q.v.) in which animals are classified according to presence or absence of disease, and presence or absence of exposure to a hypothesized causal factor, at a particular point in time.
- Cross-sectional survey:** a survey (q.v.) undertaken at a particular point in time.
- Database:** a structured collection of data, organized so that it can be accessed easily by a range of computer software.
- Determinant:** a factor that affects the health of a population.
- Discrete variable:** a variable (see Appendix II) for which there is a definite distance from one value of the variable to the next possible value (e.g., numbers of cases of disease: 1, 2, 3 . . . where the distance is 1).
- Endemic:**
1. the predictable level of occurrence of disease, infection, antibody, etc.;
  2. the usual presence of disease, infection, antibody, etc.
- Endogenous:**
1. normally from within an animal;
  2. (characteristic) an innate characteristic of an animal (e.g., breed).
- Epidemic:** an occurrence of disease in excess of its anticipated frequency (also used adjectivally).
- Epidemic curve:** a graph plotting the number of new cases against time of onset of disease; thus, an epidemic curve plots incidence.
- Epidemiology (veterinary):** the investigation of disease, other health-related events, and production in animal populations and the making of inferences from the investigation in an attempt to improve the health and productivity of the populations.
- Evidence-based medicine:** the process of finding relevant information in the veterinary literature to address a specific clinical problem; the application of simple rules of science and common sense to determine the validity of information; the application of the information to a clinical question; that is, patient care based on the best available studies.
- Exogenous:**
1. normally from outside an animal;
  2. (characteristic) a characteristic that is not innate, to which an animal is exposed (e.g., climate, toxic substances and microbes).
- Experimental study:** a study (q.v.) in which the investigator can allocate animals to different categories; thus, the conditions of the study are controlled by the investigator.
- Extrinsic factor:** see Exogenous (2).
- Extrinsic incubation period:** the time between the entry of an infectious agent into an arthropod vector and the time at which the arthropod becomes infectious.
- Field trial:** see Clinical trial.
- Fomites (singular: fomes):** inanimate communicators of infection (cf. vector).
- Health and productivity schemes:** systems for recording disease and productivity in groups of animals (usually herds and flocks), their aim being to improve health and productivity of the groups.
- Horizontal (lateral) transmission:** transmission of an infection from an individual to any other individual in a population, but excluding vertical transmission (q.v.).
- Hypothesis:** a proposition that can be tested formally; after which the hypothesis may be either 'supported' or 'rejected'.
- Inapparent infection:** an infection that does not produce clinical signs.
- Incidence:** the number of new cases that occur over a specified period of time. It is usually expressed in relation to the population at risk and the time during which the population is observed.
- Informatics:** the supply of information through the medium of the computer.
- Interaction:**
1. (**biological**) the interdependent operation of two or more causes to produce an effect;
  2. (**statistical**) in an epidemiological context, a quantitative interdependence between two or more

factors, such that the frequency of disease when two or more factors are present is either in excess of that expected from the combined effects of each factor (positive interaction) or less than the combined effect (negative interaction).

**Intrinsic factor:** see Endogenous (2).

**Likelihood:** the probability of a set of observations, given the value of a parameter (see Appendix II) or set of parameters.

**Longitudinal study:**

1. a cohort study (q.v.);
2. a general description of both cohort and case-control studies (q.v.), so called because these studies investigate exposure to a hypothesized cause and development of disease (the effect) when cause and effect are separated temporally.

**Longitudinal survey:** a survey (q.v.) that records events over a period of time.

**Misclassification:** the incorrect allocation of individuals or features to categories to which they do not belong (e.g., the classification of a diseased animal as non-diseased).

**Model:**

1. (**biological**) a system that uses animals to study diseases, pathological conditions and impaired function; the model may be induced experimentally or may be constructed using naturally occurring conditions;
2. (**mathematical**) a representation of a system, process or relationship in mathematical form in which equations are used to simulate the behaviour of the system or process under study.

**Monitoring:** the routine collection of information on disease, productivity and other characteristics possibly related to them in a population.

**Morbidity:** the amount of disease in a population (commonly defined in terms of incidence or prevalence; q.v.).

**Mortality:** a measure of the number of deaths in a population.

**Multifactorial disease:** a disease that depends on the presence of several factors for its induction. Most diseases are multifactorial, although some may have one major component cause (e.g., foot-and-mouth disease virus is the cause of foot-and-mouth disease), in which case they are commonly termed 'unifactorial'.

**Multivariate analysis:** a set of statistical techniques used to study the variation in several variables simultaneously.

**Necessary cause:** a cause that must always be present for a disease to occur (e.g., *Mycobacterium tuberculosis* is the necessary cause of tuberculosis).

**Nidality:** the characteristic of an infectious agent to occur in distinct nidi (q.v.) associated with particular geographic, climatic and ecological conditions.

**Nidus** (plural: nidi): a focus of infection.

**nm (nanometre):**  $10^{-9}$  m; equivalent to the obsolescent millimicron ( $\mu\text{m}$ ).

**Normal distribution:** a probability distribution relating to continuous data and characterized by a symmetric bell-shaped distribution with 'tails' extending to infinity.

**Observational study:** an epidemiological study (q.v.) in which the investigator has no freedom, or does not exercise his freedom, to allocate animals to different categories; disease is studied as it occurs 'naturally'.

**Odds:** the ratio (q.v.) of the probability of an event occurring to that of it not occurring.

**Odds ratio:** the ratio of two odds: a measure of association commonly used in observational studies (q.v.). The odds are defined differently, depending the type of study. Thus, in a cohort study (q.v.): a *disease-odds ratio* is estimated: this is the odds in favour of disease among exposed individuals divided by: the odds in favour of disease among unexposed individuals. (See Chapter 15 for fuller details.) (cf. Relative risk.)

**One-tailed test:** a statistical significance test based on the assumption that the data have only one possible direction of variability.

**Outbreak:** an identified occurrence of disease involving one or more animals. In developed countries, an outbreak is frequently synonymous with disease occurrence on individual farms or holdings. The term sometimes refers to a bout of disease occurrence stemming from a single source, irrespective of the number of premises involved.

**Pandemic:** a geographically widespread (sometimes global) epidemic (also used adjectivally).

**Parameter:** see Appendix II.

**Pathogen:** an organism that produces disease.

**Pathogenicity:** the ability of an infectious agent to cause disease.

**Point (common) source epidemic:** an epidemic resulting from exposure of animals to a single common cause.

**Poisson distribution:** a probability distribution relating to the distribution of events, independently, either throughout space (an area) or over time.

**Population at risk:** the population that is naturally susceptible to a disease.

**Precision:**

1. the reciprocal of the variance of an estimate;
2. the quality of being lucidly and clearly defined.

**Prevalence:** the number of occurrences of disease, infection, antibody presence, and so on in a population, usually relating to a particular point in time; it is commonly expressed as the proportion of the population at risk.



**Predictive value:**

1. of a positive test result: the probability that an animal with a 'positive' test is a true 'positive';
2. of a negative test result: the probability that an animal with a 'negative' test result is a true 'negative'.

**Proportion:** a ratio (q.v.) in which the numerator is part of the denominator.

**Prospective study:** a cohort study.

**Rate:** a ratio (q.v.) that indicates the change in one quantity with respect to one or more others over time. Thus, incidence rate is the number of new cases of disease occurring in a population observed for a defined period of time (e.g. 10 cases per 100 animal-years at risk).

**Ratio:** a value obtained by dividing one quantity (the numerator) by another (the denominator); for example, the number of males born per female birth. Proportions and rates are ratios.

**Refinement:** the quality of being sharply defined. Thus, a refined serological test will detect subtle antigenic differences between microbes, whereas a less refined test will only identify major antigenic groups.

**Relative odds:** see Odds ratio.

**Relative risk:** the ratio of disease incidence in individuals exposed to an hypothesized cause, to the incidence in those not so exposed. It is a measure of association commonly used in cohort studies (q.v.). (cf. Odds ratio.)

**Reliability:** the degree of stability exhibited when a measurement is repeated under identical conditions; reliability therefore may be demonstrated by repeating a measurement.

**Reservoir:** an animate or inanimate object on or in which an infectious agent usually lives, and which therefore is often a source of infection by the agent.

**Retrospective study:**

1. a case-control study (so-called because the study looks back from effect to cause);
2. any study that collects and utilizes historical data.

**Risk ratio:** see Relative risk.

**Sample:** a selected part of a population.

**Sampling error:**

1. the difference between a sample's result and the population characteristic that is being estimated;
2. that part of the overall estimation error of a parameter (q.v.) caused by the random nature of the sample.

**Sampling variation:** the variation shown by different samples of the same size caused by the chance inclusion of individuals in the samples.

**Screening:** the identification of unrecognized disease or defect in an apparently healthy population.

**Sensitivity (of a test):**

1. **diagnostic:** the proportion of diseased animals that are detected by a test;

2. **analytical:** the ability of a test to detect amounts of antigen, enzyme, nucleic acid, and so on; a sensitive test will detect small amounts.

**Social cost-benefit analysis:** an economic technique used in epidemiology to assess the costs of disease and impaired productivity in relation to the benefits that accrue from their control.

**Specificity:**

1. degree of refinement; the greater the specificity, the greater the degree;
2. **diagnostic** (of a test): the proportion of non-diseased animals that are detected by a test;
3. **analytical** (of a test): degree of refinement in an infectious agent (e.g., antigenic type or nucleic acid composition) that can be detected by a test; the greater the specificity, the greater the degree.

**Sporadic:** the irregular, unpredictable occurrence of disease or infection.

**Spreadsheet:** a computer software package providing a representation of a large rectangular area upon which data tabulation may be displayed and a variety of calculations performed.

**'Stamping-out policy':** the *Office International des Epizooties* defines stamping out as the carrying out under the authority of the veterinary administration, on confirmation of a disease, of zoo-sanitary prophylactic measures, consisting of killing the animals that are affected and those suspected of being affected in the herd and, where appropriate, those in other herds that have been exposed to infection by direct animal-to-animal contact, or by indirect contact of any kind likely to cause transmission of the causal pathogen. All susceptible animals, vaccinated or unvaccinated, on an infected premises should be killed and the carcasses destroyed by burning or burial, or by any other method which will eliminate the spread of infection through the carcasses or products of the animals killed. This policy should be accompanied by approved cleansing and disinfection procedures.

A 'modified stamping-out policy' is any policy where the above zoo-sanitary measures are not implemented in full.

**Study:** an investigation that involves the testing of a causal hypothesis. A study may be either experimental (q.v.) or observational (q.v.).

**Sufficient cause:** the complex of component causes that induces a disease. Several different sufficient causes may induce the same disease.

**Surveillance (veterinary):** the on-going systematic collection and collation of useful information about disease, infection, intoxication or welfare in a defined animal population, closely integrated with timely analysis and interpretation of this information, and dissemination of relevant results to those

requiring them, including those responsible for control measures.

**Survey:** an investigation involving the collection of information and in which a causal hypothesis usually is not tested (cf. Study). It may suggest aspects worthy of study.

**Synergism:** a positive statistical interaction (q.v.) where a causal pathway can be inferred (other authors may use the term differently).

**Threshold level:**

1. the spatial density of susceptible animals required to initiate an epidemic;
2. the minimum concentration of an infectious agent in a vertebrate host's circulation that allows successful transmission to an arthropod vector;
3. a critical level for the number and combination of genes above which a genetically determined disease occurs.

**Two-tailed test:** a statistical significance test based on the assumption that the data are distributed in both directions from some central value(s).

**Validity:** a term with a variety of meanings; in this book it is the degree to which a diagnostic test or survey produces, *on average*, an accurate result. It is therefore a long-run property of the test or survey.

**Variable:** see Appendix II.

**Vector:** a living organism (frequently an arthropod) that communicates an infectious agent from an infected to a susceptible animal.

**Vertical transmission:** transmission of an infection from one individual to its offspring.

**Virulence:** the disease-evoking power of an infectious agent in a particular host.

**Zoonosis:** an infection shared in nature by man and other vertebrates.

# Appendix II

## Basic mathematical notation and terms

### Variables

There are properties of members of a population that vary between the members, for example, weights of cows or breed of pig; these properties are **variables**. Their values are denoted by letters of the Roman alphabet, which usually take the lower case,  $x, y, z$ , etc. The letters often have subscripts (small-sized numbers to the right of, and slightly below, the letter), for example:

the weights  $x_1, x_2, x_3$  of three calves

$$x_1 = 230 \text{ kg}, x_2 = 221 \text{ kg}, x_3 = 155 \text{ kg}.$$

### Constants

There are two types of constant:

1. **universal constants** have a single value, for example,  $\pi = 3.141 \dots$
2. **parameters** are constants that are fixed for a particular study, but which may change from one study to another. Greek letters,  $\lambda, \mu$  and so on, usually denote parameters. For example, the infectivity rate of a particular parasite could be denoted by  $\lambda$ , where  $\lambda$  may change from one isolate to another.

### Logarithms

Logarithms are a class of arithmetical functions distinguished by a characteristic known as the **base**, such that the logarithm of a number is the power to which the base of the logarithm must be raised to give the number. Two bases are frequently used: base 10 and base  $e$ , where  $e =$  the universal exponential constant, 2.718 281... Logarithms to base 10 are also called

'common' logarithms, whereas logarithms to the base  $e$  (abbreviated to 'log <sub>$e$</sub> ' or 'ln') are called 'natural' or Napierian logarithms. Additionally, logarithms to the base 2 are sometimes used.

$$\text{Thus, } \log_{10} 100 = 2 \text{ (i.e., } 10^2 = 100),$$

$$\log_e 5 = 1.609 \text{ (i.e., } 2.7181^{1.609} = 5),$$

$$\log_2 8 = 3 \text{ (i.e., } 2^3 = 8).$$

(Note that the logarithm of 1 to any base is zero, and the logarithm of zero to any base is 'minus infinity'.)

The inverse of logarithmic transformation is anti-logarithmic transformation. Thus,  $\text{antilog}_{10} 2 = 10^2 = 100$ .

### Exponential function: $\exp(x)$

The exponential function,  $\exp(x)$ , alternatively written  $e^x$ , is the particular case of antilogarithmic transformation which relates to natural logarithms. For example, if  $x = 4$ ,  $\exp(x) = 2.718^4 = 54.6$ .

### Summation notation: $\Sigma$

$\Sigma$  is used to denote the sum of a set of data. For example:

$$\sum_{i=1}^6 x_i = x_1 + x_2 + x_3 + x_4 + x_5 + x_6.$$

This means 'the sum of all the values of  $x$  from  $x_1$  to  $x_6$ , inclusive'. This notation is of value if, for instance, one wanted to add  $x_3, x_4$  and  $x_5$  from the series of values, in which case one would write:

$$\sum_{i=3}^5 x_i$$

In biological calculations it is usually necessary to add **all** of the values of  $x$  from  $x_1$  to the last value of  $x$ , omitting none of the values in the series. It is therefore sufficient to write  $\sum x$ , in which case it is assumed that all of the  $x$  values in the series are being added.

This system of notation can also be applied to powers. For example,  $\sum x^2$  means 'square all the individual values of  $x$  in the series and then add these square values together':

$$x_1 = 2, x_2 = 3, x_3 = 2,$$

$$\text{then } \sum x^2 = x_1^2 + x_2^2 + x_3^2 = 4 + 9 + 4 = 17.$$

$(\sum x)^2$  means 'add together all the values of  $x$  in the series and then square the result'. For example:

$$x_1 = 2, x_2 = 3, x_3 = 2,$$

$$\text{then } \sum(x)^2 = (x_1 + x_2 + x_3)^2 = (2 + 3 + 2)^2 = 49.$$

## Order of calculation

Multiplication and division are conducted before addition and subtraction. Thus:

$$\begin{aligned} 6 \times 3 + 1 &= 18 + 1 \\ &= 19. \end{aligned}$$

Brackets are used to indicate the order of calculation, taking precedence over multiplication and division when calculations would otherwise be ambiguous. Three types of brackets are commonly used: parentheses ( ), braces { }, and square brackets [ ], usually, but not always, in that order.

$$\text{Thus: } 3 [3 + \{6(4 + 2)\}]$$

is calculated as  $4 + 2 = 6$

$$\text{then } 6 \times 6 = 36$$

$$\text{then } 3 + 36 = 39$$

$$\text{then } 3 \times 39 = 117.$$

Similarly:  $1 + 6 \times 3 = 19$ ,  
but  $(1 + 6) \times 3 = 21$ .

Pocket calculators compute values following the order of calculation described above. Therefore, in circumstances in which brackets are required to avoid ambiguity, calculations must be undertaken in unambiguous stages. This is circumvented on some calculators by the presence of appropriate bracket keys on the keypad.

## Magnitude notation

$>$  = greater than (e.g.,  $6 > 5$ )

$<$  = less than (e.g.,  $5 < 6$ )

$\geq$  = greater than or equal to

$\leq$  = less than or equal to

A line through any of these symbols means 'not', for example,  $\nexists$  means 'not greater than'.

## Approximation notation

The symbol  $\approx$ , read as 'approximately equal to', is used to indicate approximation. For example, the base of natural logarithms  $e = 2.718\ 281 \dots$  and may be written as  $e \approx 2.72$ .

## Estimation notation

Parameters are frequently estimated from a **sample** drawn from a population. The sample produces an **estimate** of the population parameter. An estimate is indicated either by  $\hat{\phantom{x}}$  (a 'hat') or by a single asterisk, \*. Thus, a sample estimate of disease prevalence is presented as either  $\hat{P}$  ( $P$  'hat') or  $P^*$ . The 'hat' notation is used in this book.

## Factorial notation: $x!$

$x!$  is used to denote the successive multiplication of all positive integers (whole numbers) between  $x$  and 1. For example:

$$6! = 6 \times 5 \times 4 \times 3 \times 2 \times 1 = 720$$

$$2! = 2 \times 1 = 2$$

$$1! = 1.$$

(Note that  $0!$  conventionally equals 1.)

## Modulus notation: $|x|$

Vertical lines on each side of a numerical quantity,  $x$ , mean that the positive sign of the value of  $x$  should be used. The value thus obtained is known as the **absolute value** of  $x$ . For example,  $|-2|$  is read as +2. Similarly,  $|-6 + 1|$  will simplify to  $|-5|$ , which is read as +5. Also,  $-6 + 1 = -5$ , but  $|-6| + 1 = 7$ .

# Appendix III

## Some computer software

This directory lists some computer software packages that are of value to veterinary epidemiology. The list is not exhaustive; emphasis is placed on the simpler analytical packages, rather than on software suitable for multivariate analyses. The descriptions of the various packages also differ in the degree of detail and, for some packages, the list is hardly more than enumerative, but should be sufficient to allow potential users to identify appropriate software<sup>1</sup>.

Relevant references are in square brackets, following the names of the packages. (Package manuals are not included.)<sup>2</sup>

Most of the packages run in the MS Windows environment.

The main addresses of suppliers are listed. Some suppliers also have local offices in various countries. Note that the Internet URLs of suppliers may change. If this occurs, most Internet 'Search Engines' (e.g., GOOGLE™; <http://google.com>), specifying either the package name or its supplier, should locate the new URLs.

---

<sup>1</sup> The packages subsume most of the individual applications listed, in Appendix III of the second edition of this book, as being available from the *Epidemiology Monitor*.

<sup>2</sup> A useful review of software for power analysis is presented by Thomas and Krebs (1997).

Package/reference	Functions	Further information/Supplier/URL
AGG [Donald <i>et al.</i> , 1994]	Aggregate-level sensitivity and specificity	A. Donald 101–5805 Balsam Street Vancouver BC Canada V6M 2B9
CIA [Altman <i>et al.</i> , 2000]	Confidence interval estimation means and their differences medians and their differences proportions and their differences regression and correlation relative risks and odds ratios standardized rates and ratios survival analyses sensitivity and specificity <i>kappa</i> likelihood ratios ROC curves clinical trials and meta-analyses	Supplied with <i>Statistics with Confidence</i> (Altman <i>et al.</i> , 2000) BMJ Bookshop, BMA House London WC1H 9JR, UK <a href="http://www.bmjbookshop.com">http://www.bmjbookshop.com</a>
<i>Biostatistical software</i> (Some parts require SAS software)	Statistical distributions Clinical trials Quality control Environmental and ecological statistics Agreement Regression Time series ROC curves Capture–release–recapture Correlation and contingency tables	Paul Johnson PO Box 4146 Davis CA 95617-4146, USA <a href="http://www.biostatsoftware.com">http://www.biostatsoftware.com</a>
EGRET	Descriptive statistics Contingency tables (relative risks and odds ratios), logistic and other types of regression, survival analysis	Cytel Software Corporation 675 Massachusetts Avenue Cambridge MA 02139, USA <a href="http://www.cytel.com">http://www.cytel.com</a>
<i>Epi Info</i>	Questionnaire design Descriptive statistics and graphics Surveys: simple random, stratified and cluster sampling Contingency tables (relative risks and odds ratios) Logistic regression Sample size determination: surveys case-control, cohort and cross-sectional studies Survival analysis Mapping	Centers for Disease Control and Prevention Division of Public Health Surveillance and Informatics, Epidemiology Program Office 4770 Buford Highway, Northeast (Mail Stop K-74) Atlanta Georgia 30341-3717, USA <a href="http://www.cdc.gov/epiinfo">http://www.cdc.gov/epiinfo</a>
<i>Freecal</i> [Cameron and Baldock, 1998a,b]	Survey sample size, accommodating sensitivity and specificity Survey analysis, accommodating sensitivity and specificity	AusVet Animal Health Services 19 Brereton Street, PO Box 3180 South Brisbane, QLD 4101, Australia Australia/AusVet Animal Health Services PO Box 2321 Orange, NSW 2800 Australia Australia/AusVet Animal Health Services 140 Falls Road Wentworth Falls NSW 2782 Australia <a href="http://www.ausvet.com.au/content.php?page=res_software">http://www.ausvet.com.au/content.php?page=res_software</a>
GENSTAT [McConway <i>et al.</i> , 1999]	Comprehensive statistical analyses	NAG Ltd Wilkinson House, Jordan Hill Road Oxford OX2 8DR, UK <a href="http://www.nag.co.uk/stats/GDGE_soft.asp">http://www.nag.co.uk/stats/GDGE_soft.asp</a>

<i>Package/reference</i>	<i>Functions</i>	<i>Further information/Supplier/URL</i>
<i>GLIM</i>	Logistic regression	NAG Ltd Wilkinson House, Jordan Hill Road Oxford OX2 8DR, UK <a href="http://www.nag.co.uk/stats/GDGE_soft.asp">http://www.nag.co.uk/stats/GDGE_soft.asp</a>
<i>Minitab</i>	Comprehensive statistical analyses	Minitab Inc. Quality Plaza, 1829 Pine Hall Road State College PA 16801-3008, USA <a href="http://www.minitab.com">http://www.minitab.com</a>
<i>Model Assist</i> (Requires ●RISK)	Training software for risk analysis	Risk Media Ltd Le Bourg 24400 Les Leches France <a href="http://www.risk-modelling.com">http://www.risk-modelling.com</a>
<i>NCSS</i>	Comprehensive statistical analyses	NCSS 329 North 1000 East Kaysville Utah 84037, USA <a href="http://www.ncss.com">http://www.ncss.com</a>
<i>nQuery Advisor</i>	Sample size and power means, proportions, nonparametric methods, agreement, superiority/equivalence/non- inferiority trials, regression, survival	Statistical Solutions Stonehill Corporate Center Suite 104, 999 Broadway Saugus MA 01906, USA <a href="http://www.statsolusa.com">http://www.statsolusa.com</a>
<i>PASS</i>	Sample size and power correlation, diagnostic tests, superiority/equivalence/non-inferiority trials, incidence rates, means, proportions, regression, survival	NCSS 329 North 1000 East Kaysville Utah 84037, USA <a href="http://www.ncss.com">http://www.ncss.com</a>
<i>PEPI</i>	Contingency tables (relative risk, odds ratio) Power and sample size calculations Diagnostic tests (sensitivity, specificity, ROC curves, optimum cut-off points) Random sampling Agreement Survival analysis Life tables	Sagebrush Press, 225 10th Avenue Salt Lake City UT 841 03, USA, and 12 Hillbury Road, London SW17 8JT, UK <a href="http://www.sagebrushpress.com/pepibook.html">http://www.sagebrushpress.com/pepibook.html</a>
<i>Power and Precision</i>	Power analyses and confidence interval estimation	Lawrence Erlbaum Associates Inc. 10 Industrial Avenue Mahwah NJ 07430-2262, USA <a href="http://www.erlbaum.com/software.htm">http://www.erlbaum.com/software.htm</a>
<i>Powersim Studio</i>	General simulation modelling	Powersim PO Box 3961 Dreggen N-5835 Bergen, Norway, and Fays Business Centre Bedford Road Guildford GU1 4SJ, UK <a href="http://www.powersim.com">http://www.powersim.com</a>
<i>@RISK</i>	Quantitative risk analysis	Palisade Europe The Blue House, Unit 1, 30 Calvin Street London E1 6NW, UK <a href="http://www.palisade.com">http://www.palisade.com</a>

Package/reference	Functions	Further information/Supplier/URL
<i>Risk Matrix</i>	Construction of risk matrices	The MITRE Corporation 202 Burlington Road Bedford MA 01730–1420, USA <a href="http://www.mitre.org/work/sepo/toolkits/risk/ToolsTechniques/RiskMatrix.html">http://www.mitre.org/work/sepo/toolkits/risk/ToolsTechniques/RiskMatrix.html</a>
<i>SCALC</i> [Tryfos, 1996]	Sampling simple random, stratified, cluster	Supplied with <i>Sampling Methods for Applied Research</i> (Tryfos, 1996)
<i>SPSS</i>	Comprehensive statistical analyses	SPSS Inc 233–235 Wacker Drive, 11th Floor Chicago IL 60606, USA <a href="http://www.spss.com">http://www.spss.com</a>
<i>Stata</i>	Comprehensive statistical analyses, notably including surveys	StataCorp LP 4905 Lakeway Drive College Station Texas 77845, USA <a href="http://www.stata.com">http://www.stata.com</a>
<i>StatXact</i>	Exact <i>p</i> -values for contingency tables and non-parametric tests	Cytel Software Corporation 675 Massachusetts Avenue Cambridge MA 02139, USA <a href="http://www.cytel.com">http://www.cytel.com</a>
<i>Survey Toolbox</i>	Random sampling Random geographical coordinate sampling Two-stage prevalence survey design and analysis Survival analysis sample size Capture–release–recapture methods	AusVet Animal Health Services 19 Brereton Street, PO Box 3180 South Brisbane, QLD 4101, and Australia/AusVet Animal Health Services PO Box 2321 Orange, NSW 2800 Australia, and Australia/AusVet Animal Health Services 140 Falls Road Wentworth Falls NSW 2782 Australia <a href="http://www.ausvet.com.au/content.php?page=res_software">http://www.ausvet.com.au/content.php?page=res_software</a>
<i>Winepiscope</i> [Thrusfield <i>et al.</i> , 2001]	Diagnostic test parameters point and interval estimates of sensitivity, specificity, predictive value, <i>Kappa</i> , area under the ROC curve Sample size determination detection of disease, proportion and their differences, differences between means Observational studies simple, stratified and matched case-control studies, simple and stratified cohort studies (cumulative incidence and incidence rate data) Reed–Frost model (deterministic)	Veterinary Faculty of the University of Zaragoza (Spain) <a href="http://infecepi.unizar.es/pages/ratio/soft_uk.htm">http://infecepi.unizar.es/pages/ratio/soft_uk.htm</a> Wageningen Agricultural University (The Netherlands) <a href="http://www.zod.wau.nl/qve/home.html">http://www.zod.wau.nl/qve/home.html</a> Royal (Dick) School of Veterinary Studies, University of Edinburgh (UK) <a href="http://www.clive.ed.ac.uk/winepiscope">http://www.clive.ed.ac.uk/winepiscope</a>



# Appendix IV

## Veterinary epidemiology on the Internet

This Appendix lists the 'addresses' ('uniform resource locators': URLs) of some veterinary and related Internet sites of relevance to veterinary epidemiology. Site URLs may change, in which case users may be

redirected to alternative locations. If this does not occur, an Internet search on the title, using an appropriate search engine (e.g., GOOGLE™: <http://google.com>) should locate any new URL.

<i>Title (subject)</i>	<i>URL</i>
<i>AGRICOLA</i> (General agricultural bibliographic database)	<a href="http://agricola.nal.usda.gov/">http://agricola.nal.usda.gov/</a>
<i>AHEAD ILIAD</i> (Infectious animal and zoonotic disease surveillance [ProMED-AHEAD])	<a href="http://www.fas.org/ahead.index.html">http://www.fas.org/ahead.index.html</a>
<i>American College of Veterinary Public Health</i>	<a href="http://www.acvpm.org/cgi-bin/start/index.htm">http://www.acvpm.org/cgi-bin/start/index.htm</a>
<i>Animal Health in Australia</i>	<a href="http://www.aahc.com.au/sitemap.htm">http://www.aahc.com.au/sitemap.htm</a>
<i>Association for Veterinary Epidemiology and Preventive Medicine</i>	<a href="http://www.cvm.uiuc.edu/atvphpm/">http://www.cvm.uiuc.edu/atvphpm/</a>
<i>CABI</i> (Animal-science bibliographic database)	<a href="http://www.cabi-publishing.org/AnimalScience.asp/">http://www.cabi-publishing.org/AnimalScience.asp/</a>
<i>Canadian Cooperative Wildlife Health Centre</i>	<a href="http://wildlife1.usask.ca/ccwhc2003/">http://wildlife1.usask.ca/ccwhc2003/</a>
<i>Centers for Epidemiology and Animal Health</i>	<a href="http://www.aphis.usda.gov/vs/ceah/">http://www.aphis.usda.gov/vs/ceah/</a>
<i>Cochrane Collaboration</i> (Reviews of clinical trials and other interventions)	<a href="http://www.cochrane.org/index1.htm">http://www.cochrane.org/index1.htm</a>
Epidemiology and related 'Supercourses'	<a href="http://www.pighealth.com/Scourse/main/index.htm">http://www.pighealth.com/Scourse/main/index.htm</a> <a href="http://www.pitt.edu/~super1/index.htm">http://www.pitt.edu/~super1/index.htm</a>
<i>Epidemiology Monitor</i> (Developments and resources for epidemiology)	<a href="http://www.epimonitor.net">http://www.epimonitor.net</a>
<i>EpiVetNet</i> (Repository of information related to veterinary epidemiology, and electronic mailing list <i>EpiVet-L</i> )	<a href="http://www.vetschools.co.uk/EpiVetNet/">http://www.vetschools.co.uk/EpiVetNet/</a>
<i>European College of Veterinary Public Health</i>	<a href="http://www.vu-wien.ac.at/ausland/ECVPH.htm">http://www.vu-wien.ac.at/ausland/ECVPH.htm</a>
<i>EXCITE</i> ( <i>Excellence in Curriculum Integration through Teaching Epidemiology</i> )	<a href="http://www.cdc.gov/excite/">http://www.cdc.gov/excite/</a>
<i>FOCUS</i> (Field epidemiology)	<a href="http://www.sph.unc.edu/nccphp/focus/index.htm">http://www.sph.unc.edu/nccphp/focus/index.htm</a>

Title (subject)	URL
<i>Food and Agriculture Organization of the United Nations (FAO)</i>	<a href="http://www.fao.org/">http://www.fao.org/</a>
<i>International Veterinary Information Service</i>	<a href="http://www.ivis.org">http://www.ivis.org</a>
<i>Journals in Epidemiology</i>	<a href="http://www.epidemiology.esmartweb.com/Journals.htm">http://www.epidemiology.esmartweb.com/Journals.htm</a>
<i>National Animal Health Monitoring System (NAHMS)</i>	<a href="http://www.aphis.usda.gov/vs/ceah/cahm/index.htm">http://www.aphis.usda.gov/vs/ceah/cahm/index.htm</a>
<i>National Centre for Animal Health Surveillance</i> (Includes link to NAHMS)	<a href="http://www.aphis.usda.gov/vs/ceah/ncahs/nsu">http://www.aphis.usda.gov/vs/ceah/ncahs/nsu</a>
<i>Net-Epi</i> (Network-enabled Epidemiology) (Free tools for epidemiology and public health)	<a href="http://www.netepi.org/">http://www.netepi.org/</a>
<i>Office International des Epizooties (OIE)</i>	<a href="http://www.oie.int">http://www.oie.int</a>
<i>Pan American Health Organization</i>	<a href="http://www.paho.org/">http://www.paho.org/</a>
<i>Participatory Epidemiology</i>	<a href="http://www.participatoryepidemiology.info/">http://www.participatoryepidemiology.info/</a>
<i>ProMED</i> (Monitoring of emerging disease)	<a href="http://www.fas.org/promed/">http://www.fas.org/promed/</a>
<i>PubMed</i> (Medical bibliographic database)	<a href="http://www.ncbi.nlm.nih.gov/pubmed/">http://www.ncbi.nlm.nih.gov/pubmed/</a>
<i>Regional International Organization for Animal and Plant Health (OIRSA/Central America)</i> [In Spanish]	<a href="http://ns1.oirsa.org.sv/">http://ns1.oirsa.org.sv/</a>
<i>Society for Veterinary Epidemiology and Preventive Medicine</i>	<a href="http://www.svepm.org.uk">http://www.svepm.org.uk</a>
<i>SNOMED</i>	<a href="http://www.snomed.org">http://www.snomed.org</a> <a href="http://www.snomed.vetmed.vt.edu">http://www.snomed.vetmed.vt.edu</a>
<i>Statistics Calculators</i>	<a href="http://calculators.stat.ucla.edu">http://calculators.stat.ucla.edu</a>
<i>Veterinary Medical Database</i>	<a href="http://www.vmdb.org">http://www.vmdb.org</a>
<i>Web-agri</i> (Agricultural Search Engine)	<a href="http://www.web-agri.com/recherche.asp">http://www.web-agri.com/recherche.asp</a>
<i>World Health Organization (WHO)</i>	<a href="http://www.who.int/en/">http://www.who.int/en/</a>
<i>WWWeb Epidemiology &amp; Evidence-based Medicine Sources for Veterinarians</i> (Epidemiology, evidence-based medicine and biostatistics academic resources)	<a href="http://www.vetmed.wsu.edu/courses-jmgay/Epilinks.htm">http://www.vetmed.wsu.edu/courses-jmgay/Epilinks.htm</a>

# Appendix V

## Student's *t*-distribution

Degrees of freedom	Probability												
	.9	.8	.7	.6	.5	.4	.3	.2	.1	.05	.02	.01	.001
1	.158	.325	.510	.727	1.000	1.376	1.963	3.078	6.314	12.706	31.821	63.657	636.619
2	.142	.289	.445	.617	.816	1.061	1.386	1.886	2.920	4.303	6.965	9.925	31.598
3	.137	.277	.424	.584	.765	.978	1.250	1.638	2.353	3.182	4.541	5.841	12.924
4	.134	.271	.414	.569	.741	.941	1.190	1.533	2.132	2.776	3.747	4.604	8.610
5	.132	.267	.408	.559	.727	.920	1.156	1.476	2.015	2.571	3.365	4.032	6.869
6	.131	.265	.404	.553	.718	.906	1.134	1.440	1.943	2.447	3.143	3.707	5.959
7	.130	.263	.402	.549	.711	.896	1.119	1.415	1.895	2.365	2.998	3.499	5.408
8	.130	.262	.399	.546	.706	.889	1.108	1.397	1.860	2.306	2.896	3.355	5.041
9	.129	.261	.398	.543	.703	.883	1.100	1.383	1.833	2.262	2.821	3.250	4.781
10	.129	.260	.397	.542	.700	.879	1.093	1.372	1.812	2.228	2.764	3.169	4.587
11	.129	.260	.396	.540	.697	.876	1.088	1.363	1.796	2.201	2.718	3.106	4.437
12	.128	.259	.395	.539	.695	.873	1.083	1.356	1.782	2.179	2.681	3.055	4.318
13	.128	.259	.394	.538	.694	.870	1.079	1.350	1.771	2.160	2.650	3.012	4.221
14	.128	.258	.393	.537	.692	.868	1.076	1.345	1.761	2.145	2.624	2.977	4.140
15	.128	.258	.393	.536	.691	.866	1.074	1.341	1.753	2.131	2.602	2.947	4.073
16	.128	.258	.392	.535	.690	.865	1.071	1.337	1.746	2.120	2.583	2.921	4.015
17	.128	.257	.392	.534	.689	.863	1.069	1.333	1.740	2.110	2.567	2.898	3.965
18	.127	.257	.392	.534	.688	.862	1.067	1.330	1.734	2.101	2.552	2.878	3.922
19	.127	.257	.391	.533	.688	.861	1.066	1.328	1.729	2.093	2.539	2.861	3.883
20	.127	.257	.391	.533	.687	.860	1.064	1.325	1.725	2.086	2.528	2.845	3.850
21	.127	.257	.391	.532	.686	.859	1.063	1.323	1.721	2.080	2.518	2.831	3.819
22	.127	.256	.390	.532	.686	.858	1.061	1.321	1.717	2.074	2.508	2.819	3.792
23	.127	.256	.390	.532	.685	.858	1.060	1.319	1.714	2.069	2.500	2.807	3.767
24	.127	.256	.390	.531	.685	.857	1.059	1.318	1.711	2.064	2.492	2.797	3.745
25	.127	.256	.390	.531	.684	.856	1.058	1.316	1.708	2.060	2.485	2.787	3.725
26	.127	.256	.390	.531	.684	.856	1.058	1.315	1.706	2.056	2.479	2.779	3.707
27	.127	.256	.389	.531	.684	.855	1.057	1.314	1.703	2.052	2.473	2.771	3.690
28	.127	.256	.389	.530	.683	.855	1.056	1.313	1.701	2.048	2.467	2.763	3.674
29	.127	.256	.389	.530	.683	.854	1.055	1.311	1.699	2.045	2.462	2.756	3.659
30	.127	.256	.389	.530	.683	.854	1.055	1.310	1.697	2.042	2.457	2.750	3.646
40	.126	.255	.388	.529	.681	.851	1.050	1.303	1.684	2.021	2.423	2.704	3.551
60	.126	.254	.387	.527	.679	.848	1.046	1.296	1.671	2.000	2.390	2.660	3.460
120	.126	.254	.386	.526	.677	.845	1.041	1.289	1.658	1.980	2.358	2.617	3.373
∞	.126	.253	.385	.524	.674	.842	1.036	1.282	1.645	1.960	2.326	2.576	3.291

The table gives the percentage points most frequently required for significance tests and confidence limits based on Student's *t*-distribution. Thus the probability of observing a value of *t*, with 10 degrees of freedom, greater in **absolute value** than 3.169 (i.e.  $< -3.169$  or  $> +3.169$ ) is exactly 0.01 or 1 per cent.

# Appendix VI

---

## **Multipliers used in the construction of confidence intervals based on the Normal distribution, for selected levels of confidence**

These multipliers are based on two-tailed probabilities for critical significance levels, extracted from Appendix XV.

---

Confidence interval	80%	90%	95%	99%	99.9%
Multiplier	1.282	1.645	1.960	2.576	3.291

---

# Appendix VII

## Values of exact 95% confidence limits for proportions

(From Beyer, 1968)

These tables give exact confidence limits for a proportion, based on the binomial distribution. The first ( $x$ ) column indicates the numerator in the proportion; the first ( $n - x$ ) row indicates the sample size;  $n$ , minus the numerator,  $x$ . For example, if 14 animals were

sampled, of which 6 were diseased, then  $x = 6$ ,  $n = 14$ , and  $n - x = 8$ . Thus, the point estimate of prevalence is  $6/14 = 0.428$  (42.8%) and, from the table, the interval estimate = 0.177, 0.711 (17.7%, 71.1%).

	<i>Denominator minus numerator (n - x)</i>								
	1	2	3	4	5	6	7	8	9
0	<b>975</b> 000	<b>842</b> 000	<b>708</b> 000	<b>602</b> 000	<b>522</b> 000	<b>459</b> 000	<b>410</b> 000	<b>369</b> 000	<b>336</b> 000
1	<b>987</b> 013	<b>906</b> 008	<b>806</b> 006	<b>716</b> 005	<b>641</b> 004	<b>579</b> 004	<b>527</b> 003	<b>483</b> 003	<b>445</b> 003
2	<b>992</b> 094	<b>932</b> 068	<b>853</b> 053	<b>777</b> 043	<b>710</b> 037	<b>651</b> 032	<b>600</b> 028	<b>556</b> 025	<b>518</b> 023
3	<b>994</b> 194	<b>947</b> 147	<b>882</b> 118	<b>816</b> 099	<b>755</b> 085	<b>701</b> 075	<b>652</b> 067	<b>610</b> 060	<b>572</b> 055
4	<b>995</b> 284	<b>957</b> 223	<b>901</b> 184	<b>843</b> 157	<b>788</b> 137	<b>738</b> 122	<b>692</b> 109	<b>651</b> 099	<b>614</b> 091
5	<b>996</b> 359	<b>968</b> 290	<b>915</b> 245	<b>863</b> 212	<b>813</b> 187	<b>766</b> 167	<b>723</b> 151	<b>684</b> 139	<b>649</b> 128
6	<b>996</b> 421	<b>968</b> 349	<b>925</b> 299	<b>878</b> 262	<b>833</b> 234	<b>789</b> 211	<b>749</b> 192	<b>711</b> 177	<b>677</b> 163
7	<b>997</b> 473	<b>972</b> 400	<b>933</b> 348	<b>891</b> 308	<b>849</b> 277	<b>808</b> 251	<b>770</b> 230	<b>734</b> 213	<b>701</b> 198
8	<b>997</b> 517	<b>975</b> 444	<b>940</b> 390	<b>901</b> 349	<b>861</b> 316	<b>823</b> 289	<b>787</b> 266	<b>753</b> 247	<b>722</b> 230
9	<b>997</b> 555	<b>977</b> 482	<b>945</b> 428	<b>909</b> 386	<b>872</b> 351	<b>837</b> 323	<b>802</b> 299	<b>770</b> 278	<b>740</b> 260
10	<b>998</b> 587	<b>979</b> 516	<b>950</b> 462	<b>916</b> 419	<b>882</b> 384	<b>848</b> 354	<b>816</b> 329	<b>785</b> 308	<b>756</b> 289
11	<b>998</b> 615	<b>981</b> 546	<b>953</b> 492	<b>922</b> 449	<b>890</b> 413	<b>858</b> 383	<b>827</b> 357	<b>797</b> 335	<b>769</b> 315
12	<b>998</b> 640	<b>982</b> 572	<b>957</b> 519	<b>927</b> 476	<b>897</b> 440	<b>867</b> 410	<b>837</b> 384	<b>809</b> 361	<b>782</b> 340
13	<b>998</b> 661	<b>983</b> 595	<b>960</b> 544	<b>932</b> 501	<b>903</b> 465	<b>874</b> 435	<b>846</b> 408	<b>819</b> 384	<b>793</b> 364
14	<b>998</b> 681	<b>984</b> 617	<b>962</b> 566	<b>936</b> 524	<b>909</b> 488	<b>881</b> 457	<b>854</b> 430	<b>828</b> 407	<b>803</b> 385
15	<b>998</b> 698	<b>985</b> 636	<b>964</b> 586	<b>939</b> 544	<b>913</b> 509	<b>887</b> 478	<b>861</b> 451	<b>836</b> 427	<b>812</b> 406

		<i>Denominator minus numerator (n - x)</i>								
		1	2	3	4	5	6	7	8	9
Numerator of the proportion (x)	16	<b>999</b> 713	<b>986</b> 653	<b>966</b> 604	<b>943</b> 563	<b>918</b> 529	<b>893</b> 498	<b>868</b> 471	<b>844</b> 447	<b>820</b> 425
	17	<b>999</b> 727	<b>987</b> 669	<b>968</b> 621	<b>946</b> 581	<b>922</b> 547	<b>898</b> 516	<b>874</b> 488	<b>851</b> 465	<b>828</b> 443
	18	<b>999</b> 740	<b>988</b> 683	<b>970</b> 637	<b>948</b> 597	<b>925</b> 564	<b>902</b> 533	<b>879</b> 506	<b>857</b> 482	<b>835</b> 460
	19	<b>999</b> 751	<b>988</b> 696	<b>971</b> 651	<b>950</b> 612	<b>929</b> 579	<b>906</b> 549	<b>884</b> 522	<b>862</b> 498	<b>841</b> 476
	20	<b>999</b> 762	<b>989</b> 708	<b>972</b> 664	<b>953</b> 626	<b>932</b> 593	<b>910</b> 564	<b>889</b> 537	<b>868</b> 513	<b>847</b> 492
	22	<b>999</b> 781	<b>990</b> 730	<b>975</b> 688	<b>956</b> 651	<b>937</b> 619	<b>917</b> 590	<b>897</b> 565	<b>877</b> 541	<b>858</b> 519
	24	<b>999</b> 797	<b>991</b> 749	<b>976</b> 708	<b>960</b> 673	<b>942</b> 642	<b>923</b> 614	<b>904</b> 589	<b>885</b> 566	<b>867</b> 545
	26	<b>999</b> 810	<b>991</b> 765	<b>978</b> 726	<b>962</b> 693	<b>945</b> 663	<b>928</b> 636	<b>910</b> 611	<b>893</b> 588	<b>875</b> 567
	28	<b>999</b> 822	<b>992</b> 779	<b>980</b> 743	<b>965</b> 710	<b>949</b> 681	<b>932</b> 655	<b>916</b> 631	<b>899</b> 609	<b>882</b> 588
	30	<b>999</b> 833	<b>992</b> 792	<b>981</b> 757	<b>967</b> 725	<b>952</b> 697	<b>936</b> 672	<b>920</b> 649	<b>904</b> 627	<b>889</b> 607
	35	<b>999</b> 855	<b>993</b> 818	<b>983</b> 786	<b>971</b> 758	<b>958</b> 732	<b>944</b> 708	<b>930</b> 686	<b>916</b> 666	<b>902</b> 647
	40	<b>999</b> 871	<b>994</b> 838	<b>985</b> 809	<b>975</b> 783	<b>963</b> 759	<b>951</b> 737	<b>938</b> 717	<b>925</b> 698	<b>912</b> 679
	45	<b>999</b> 885	<b>995</b> 855	<b>987</b> 828	<b>977</b> 804	<b>967</b> 782	<b>956</b> 761	<b>944</b> 742	<b>933</b> 724	<b>921</b> 707
	50	<b>1000</b> 896	<b>995</b> 868	<b>988</b> 843	<b>979</b> 821	<b>970</b> 800	<b>960</b> 781	<b>949</b> 763	<b>939</b> 746	<b>928</b> 730
	60	<b>1000</b> 912	<b>996</b> 888	<b>990</b> 867	<b>983</b> 848	<b>975</b> 830	<b>966</b> 813	<b>957</b> 797	<b>948</b> 782	<b>939</b> 767
	80	<b>1000</b> 933	<b>997</b> 915	<b>992</b> 898	<b>987</b> 882	<b>981</b> 868	<b>974</b> 855	<b>967</b> 842	<b>960</b> 820	<b>953</b> 816
	100	<b>1000</b> 946	<b>998</b> 931	<b>994</b> 917	<b>989</b> 904	<b>984</b> 892	<b>979</b> 881	<b>973</b> 870	<b>967</b> 859	<b>962</b> 849
	200	<b>1000</b> 973	<b>999</b> 965	<b>997</b> 957	<b>995</b> 951	<b>992</b> 944	<b>989</b> 938	<b>986</b> 932	<b>983</b> 926	<b>980</b> 920
	500	<b>1000</b> 989	<b>1000</b> 986	<b>999</b> 983	<b>998</b> 980	<b>997</b> 977	<b>996</b> 974	<b>995</b> 972	<b>993</b> 969	<b>992</b> 967
	∞	<b>1000</b> 1000	<b>1000</b> 1000	<b>1000</b> 1000	<b>1000</b> 1000	<b>1000</b> 1000	<b>1000</b> 1000	<b>1000</b> 1000	<b>1000</b> 1000	<b>1000</b> 1000

		<i>Denominator minus numerator (n - x)</i>								
		10	11	12	13	14	15	16	17	18
Numerator of the proportion (x)	0	<b>308</b> 000	<b>285</b> 000	<b>265</b> 000	<b>247</b> 000	<b>232</b> 000	<b>218</b> 000	<b>206</b> 000	<b>195</b> 000	<b>185</b> 000
	1	<b>413</b> 002	<b>385</b> 002	<b>360</b> 002	<b>339</b> 002	<b>319</b> 002	<b>302</b> 002	<b>287</b> 001	<b>273</b> 001	<b>260</b> 001
	2	<b>484</b> 021	<b>454</b> 019	<b>428</b> 018	<b>405</b> 017	<b>383</b> 016	<b>364</b> 015	<b>347</b> 014	<b>331</b> 013	<b>317</b> 012
	3	<b>538</b> 050	<b>508</b> 047	<b>481</b> 043	<b>456</b> 040	<b>434</b> 038	<b>414</b> 036	<b>396</b> 034	<b>379</b> 032	<b>363</b> 030
	4	<b>581</b> 084	<b>551</b> 078	<b>524</b> 073	<b>499</b> 068	<b>476</b> 064	<b>456</b> 061	<b>437</b> 057	<b>419</b> 054	<b>403</b> 052
	5	<b>616</b> 118	<b>587</b> 110	<b>560</b> 103	<b>535</b> 097	<b>512</b> 091	<b>491</b> 087	<b>471</b> 082	<b>453</b> 078	<b>436</b> 075
	6	<b>646</b> 152	<b>617</b> 142	<b>590</b> 133	<b>565</b> 126	<b>543</b> 119	<b>522</b> 113	<b>502</b> 107	<b>484</b> 102	<b>467</b> 098



	<i>Denominator minus numerator (n - x)</i>									
	19	20	22	24	26	28	30	35	40	
<i>Numerator of the proportion (x)</i>	0	<b>176</b> 000	<b>168</b> 000	<b>154</b> 000	<b>142</b> 000	<b>132</b> 000	<b>123</b> 000	<b>116</b> 000	<b>100</b> 000	<b>088</b> 000
	1	<b>249</b> 001	<b>238</b> 001	<b>219</b> 001	<b>203</b> 001	<b>190</b> 001	<b>178</b> 001	<b>167</b> 001	<b>145</b> 001	<b>129</b> 001
	2	<b>304</b> 012	<b>292</b> 011	<b>270</b> 010	<b>251</b> 009	<b>235</b> 009	<b>221</b> 008	<b>208</b> 008	<b>182</b> 007	<b>162</b> 006
	3	<b>349</b> 029	<b>336</b> 028	<b>312</b> 025	<b>292</b> 024	<b>274</b> 022	<b>257</b> 020	<b>243</b> 019	<b>214</b> 017	<b>191</b> 015
	4	<b>388</b> 050	<b>374</b> 047	<b>349</b> 044	<b>327</b> 040	<b>307</b> 038	<b>290</b> 035	<b>275</b> 033	<b>242</b> 029	<b>217</b> 025
	5	<b>421</b> 071	<b>407</b> 068	<b>381</b> 063	<b>358</b> 058	<b>337</b> 055	<b>319</b> 051	<b>303</b> 048	<b>268</b> 042	<b>241</b> 037
	6	<b>451</b> 094	<b>436</b> 090	<b>410</b> 083	<b>386</b> 077	<b>364</b> 072	<b>345</b> 068	<b>328</b> 064	<b>292</b> 056	<b>263</b> 049
	7	<b>478</b> 116	<b>463</b> 111	<b>435</b> 103	<b>411</b> 096	<b>389</b> 090	<b>369</b> 084	<b>351</b> 080	<b>314</b> 070	<b>283</b> 062
	8	<b>502</b> 138	<b>487</b> 132	<b>459</b> 123	<b>434</b> 115	<b>412</b> 107	<b>391</b> 101	<b>373</b> 096	<b>334</b> 084	<b>302</b> 075
	9	<b>524</b> 159	<b>508</b> 153	<b>481</b> 142	<b>455</b> 133	<b>433</b> 125	<b>412</b> 118	<b>393</b> 111	<b>353</b> 098	<b>321</b> 088
	10	<b>544</b> 179	<b>528</b> 173	<b>500</b> 161	<b>475</b> 151	<b>452</b> 142	<b>431</b> 134	<b>412</b> 127	<b>372</b> 112	<b>338</b> 100
	11	<b>561</b> 199	<b>546</b> 192	<b>519</b> 180	<b>493</b> 160	<b>470</b> 159	<b>449</b> 150	<b>429</b> 142	<b>388</b> 126	<b>354</b> 113
	12	<b>578</b> 218	<b>563</b> 211	<b>535</b> 197	<b>510</b> 186	<b>487</b> 175	<b>465</b> 166	<b>446</b> 157	<b>404</b> 140	<b>369</b> 125
	13	<b>594</b> 237	<b>579</b> 229	<b>551</b> 215	<b>525</b> 202	<b>503</b> 191	<b>481</b> 181	<b>461</b> 172	<b>419</b> 153	<b>384</b> 138
	14	<b>608</b> 255	<b>593</b> 247	<b>566</b> 232	<b>540</b> 218	<b>517</b> 206	<b>496</b> 196	<b>476</b> 186	<b>433</b> 166	<b>398</b> 150
	15	<b>621</b> 272	<b>607</b> 263	<b>579</b> 248	<b>554</b> 234	<b>531</b> 221	<b>509</b> 210	<b>490</b> 200	<b>446</b> 179	<b>410</b> 162
	16	<b>634</b> 288	<b>619</b> 280	<b>592</b> 263	<b>567</b> 249	<b>544</b> 236	<b>522</b> 224	<b>502</b> 214	<b>459</b> 191	<b>422</b> 173
	17	<b>645</b> 304	<b>631</b> 295	<b>604</b> 278	<b>579</b> 263	<b>556</b> 250	<b>535</b> 238	<b>515</b> 227	<b>471</b> 203	<b>434</b> 185





	<i>Denominator minus numerator (n - x)</i>							
	<i>45</i>	<i>50</i>	<i>60</i>	<i>80</i>	<i>100</i>	<i>200</i>	<i>500</i>	<i>∞</i>
0	<b>079</b> 000	<b>071</b> 000	<b>060</b> 000	<b>045</b> 000	<b>036</b> 000	<b>018</b> 000	<b>007</b> 000	<b>000</b> 000
1	<b>115</b> 001	<b>104</b> 001	<b>088</b> 000	<b>067</b> 000	<b>054</b> 000	<b>027</b> 000	<b>011</b> 000	<b>000</b> 000
2	<b>145</b> 005	<b>132</b> 005	<b>112</b> 004	<b>085</b> 003	<b>069</b> 002	<b>035</b> 001	<b>014</b> 000	<b>000</b> 000
3	<b>172</b> 013	<b>157</b> 012	<b>133</b> 010	<b>102</b> 008	<b>083</b> 006	<b>043</b> 003	<b>017</b> 001	<b>000</b> 000
4	<b>196</b> 023	<b>179</b> 021	<b>152</b> 017	<b>118</b> 013	<b>096</b> 011	<b>049</b> 005	<b>020</b> 002	<b>000</b> 000
5	<b>218</b> 033	<b>200</b> 030	<b>170</b> 025	<b>132</b> 019	<b>108</b> 016	<b>056</b> 008	<b>023</b> 003	<b>000</b> 000
6	<b>239</b> 044	<b>219</b> 040	<b>187</b> 034	<b>145</b> 026	<b>119</b> 021	<b>062</b> 011	<b>026</b> 004	<b>000</b> 000
7	<b>258</b> 056	<b>237</b> 051	<b>203</b> 043	<b>158</b> 033	<b>130</b> 027	<b>068</b> 014	<b>028</b> 005	<b>000</b> 000
8	<b>276</b> 067	<b>254</b> 061	<b>218</b> 052	<b>171</b> 040	<b>141</b> 033	<b>074</b> 017	<b>031</b> 007	<b>000</b> 000
9	<b>293</b> 079	<b>270</b> 072	<b>233</b> 061	<b>184</b> 047	<b>151</b> 038	<b>080</b> 020	<b>033</b> 008	<b>000</b> 000
10	<b>310</b> 091	<b>286</b> 083	<b>248</b> 071	<b>196</b> 055	<b>162</b> 045	<b>086</b> 023	<b>036</b> 009	<b>000</b> 000
11	<b>325</b> 102	<b>300</b> 094	<b>260</b> 080	<b>207</b> 062	<b>171</b> 051	<b>091</b> 026	<b>038</b> 011	<b>000</b> 000
12	<b>339</b> 114	<b>314</b> 104	<b>273</b> 089	<b>217</b> 069	<b>180</b> 057	<b>097</b> 030	<b>040</b> 012	<b>000</b> 000
13	<b>353</b> 125	<b>327</b> 115	<b>285</b> 098	<b>227</b> 077	<b>189</b> 063	<b>102</b> 033	<b>043</b> 014	<b>000</b> 000
14	<b>367</b> 136	<b>340</b> 125	<b>297</b> 107	<b>237</b> 084	<b>198</b> 069	<b>107</b> 036	<b>045</b> 015	<b>000</b> 000
15	<b>379</b> 147	<b>352</b> 135	<b>308</b> 116	<b>247</b> 091	<b>206</b> 075	<b>112</b> 039	<b>047</b> 016	<b>000</b> 000
16	<b>391</b> 158	<b>364</b> 146	<b>319</b> 126	<b>256</b> 099	<b>214</b> 081	<b>117</b> 043	<b>050</b> 018	<b>000</b> 000
17	<b>402</b> 169	<b>375</b> 156	<b>330</b> 134	<b>266</b> 106	<b>222</b> 087	<b>122</b> 046	<b>052</b> 019	<b>000</b> 000

Numerator of the proportion (x)



# Appendix VIII

## Values from the Poisson distribution for calculating 90%, 95% and 99% confidence intervals for observed numbers from 0 to 100

(From Altman *et al.*, 2000)

If  $x$  is the observed number in a study,  $x_L$  and  $x_U$  give the lower and upper confidence limits for the popula-

tion mean, assuming that the observed number is from a Poisson distribution.

x	90%		Level of confidence 95%		99%	
	$x_L$	$x_U$	$x_L$	$x_U$	$x_L$	$x_U$
0		2.996	0	3.689	0	5.298
1	0.051	4.744	0.025	5.572	0.005	7.430
2	0.35	6.296	0.242	7.225	0.103	9.274
3	0.81	7.754	0.619	8.767	0.338	10.977
4	1.366	9.154	1.090	10.242	0.672	12.594
5	1.970	10.513	1.623	11.668	1.078	14.150
6	2.613	11.842	2.202	13.059	1.537	15.660
7	3.285	13.148	2.814	14.423	2.037	17.134
8	3.981	14.435	3.454	15.763	2.571	18.578
9	4.695	15.705	4.115	17.085	3.132	19.998
10	5.425	16.962	4.795	18.390	3.717	21.398
11	6.169	18.208	5.491	19.682	4.321	22.779
12	6.924	19.443	6.201	20.962	4.943	24.145
13	7.690	20.669	6.922	22.230	5.580	25.497
14	8.464	21.886	7.654	23.490	6.231	26.836
15	9.246	23.097	8.395	24.740	6.893	28.164
16	10.036	24.301	9.145	25.983	7.567	29.482
17	10.832	25.499	9.903	27.219	8.251	30.791
18	11.634	26.692	10.668	28.448	8.943	32.091
19	12.442	27.879	11.439	29.671	9.644	33.383
20	13.255	29.062	12.217	30.888	10.353	34.668
21	14.072	30.240	12.999	32.101	11.069	35.946
22	14.894	31.415	13.787	33.308	11.792	37.218
23	15.719	32.585	14.580	34.511	12.521	38.484
24	16.549	33.752	15.377	35.710	13.255	39.745
25	17.382	34.916	16.179	36.905	13.995	41.000
26	18.219	36.077	16.984	38.096	14.741	42.251
27	19.058	37.234	17.793	39.284	15.491	43.497
28	19.901	38.389	18.606	40.468	16.245	44.738
29	20.746	39.541	19.422	41.649	17.004	45.976
30	21.594	40.691	20.241	42.827	17.767	47.209
31	22.445	41.838	21.063	44.002	18.534	48.439
32	23.297	42.982	21.888	45.174	19.305	49.665
33	24.153	44.125	22.716	46.344	20.079	50.888
34	25.010	45.266	23.546	47.512	20.857	52.107

$x$	90%		Level of confidence 95%		99%	
	$x_L$	$x_U$	$x_L$	$x_U$	$x_L$	$x_U$
35	25.870	46.404	24.379	48.677	21.638	53.324
36	26.731	47.541	25.214	49.839	22.422	54.537
37	27.595	48.675	26.051	51.000	23.208	55.748
38	28.460	49.808	26.891	52.158	23.998	56.955
39	29.327	50.940	27.733	53.314	24.791	58.161
40	30.196	52.069	28.577	54.469	25.586	59.363
41	31.066	53.197	29.422	55.621	26.384	60.563
42	31.938	54.324	30.270	56.772	27.184	61.761
43	32.812	55.449	31.119	57.921	27.986	62.956
44	33.687	56.573	31.970	59.068	28.791	64.149
45	34.563	57.695	32.823	60.214	29.598	65.341
46	35.441	58.816	33.678	61.358	30.407	66.530
47	36.320	59.935	34.534	62.500	31.218	67.717
48	37.200	61.054	35.391	63.641	32.032	68.902
49	38.082	62.171	36.250	64.781	32.847	70.085
50	38.965	63.287	37.111	65.919	33.664	71.266
51	39.849	64.402	37.973	67.056	34.483	72.446
52	40.734	65.516	38.836	68.191	35.303	73.624
53	41.620	66.628	39.701	69.325	36.125	74.800
54	42.507	67.740	40.566	70.458	36.949	75.974
55	43.396	68.851	41.434	71.590	37.775	77.147
56	44.285	69.960	42.302	72.721	38.602	78.319
57	45.176	71.069	43.171	73.850	39.431	79.489
58	46.067	72.177	44.042	74.978	40.261	80.657
59	46.959	73.284	44.914	76.106	41.093	81.824
60	47.852	74.390	45.786	77.232	41.926	82.990
61	48.746	75.495	46.660	78.357	42.760	84.154
62	49.641	76.599	47.535	79.481	43.596	85.317
63	50.537	77.702	48.411	80.604	44.433	86.479
64	51.434	78.805	49.288	81.727	45.272	87.639
65	52.331	79.907	50.166	82.848	46.111	88.798
66	53.229	81.008	51.044	83.968	46.952	89.956
67	54.128	82.108	51.924	85.088	47.794	91.112
68	55.028	83.208	52.805	86.206	48.637	92.269
69	55.928	84.306	53.686	87.324	49.482	93.423
70	56.830	85.405	54.568	88.441	50.327	94.577
71	57.732	86.502	55.452	89.557	51.174	95.729
72	58.634	87.599	56.336	90.672	52.022	96.881
73	59.537	88.695	57.220	91.787	52.871	98.031
74	60.441	89.790	58.106	92.900	53.720	99.180
75	61.346	90.885	58.992	94.013	54.571	100.328
76	62.251	91.979	59.879	95.125	55.423	101.476
77	63.157	93.073	60.767	96.237	56.276	102.622
78	64.063	94.166	61.656	97.348	57.129	103.767
79	64.970	95.258	62.545	98.458	57.984	104.912
80	65.878	96.350	63.435	99.567	58.840	106.056
81	66.786	97.441	64.326	100.676	59.696	107.198
82	67.695	98.532	65.217	101.784	60.553	108.340
83	68.604	99.622	66.109	102.891	61.412	109.481
84	69.514	100.712	67.002	103.998	62.271	110.621
85	70.425	101.801	67.895	105.104	63.131	111.761
86	71.336	102.889	68.789	106.209	63.991	112.899
87	72.247	103.977	69.683	107.314	64.853	114.037
88	73.159	105.065	70.579	108.418	65.715	115.174
89	74.071	106.152	71.474	109.522	66.578	116.310
90	74.984	107.239	72.371	110.625	67.442	117.445
91	75.898	108.325	73.268	111.728	68.307	118.580
92	76.812	109.410	74.165	112.830	69.172	119.714
93	77.726	110.495	75.063	113.931	70.038	120.847
94	78.641	111.580	75.962	115.032	70.905	121.980
95	79.556	112.664	76.861	116.133	71.773	123.112
96	80.472	113.748	77.760	117.232	72.641	124.243
97	81.388	114.832	78.660	118.332	73.510	125.373
98	82.305	115.915	79.561	119.431	74.379	126.503
99	83.222	116.997	80.462	120.529	75.250	127.632
100	84.139	118.079	81.364	121.627	76.120	128.761

# Appendix IX

## The $\chi^2$ -distribution

Degrees of freedom	Value of P				
	0.99	0.95	0.05	0.01	0.001
1	0.000 157	0.00 393	3.841	6.635	10.83
2	0.0201	0.103	5.991	9.210	13.82
3	0.115	0.352	7.815	11.34	16.27
4	0.297	0.711	9.488	13.28	18.47
5	0.554	1.145	11.07	15.09	20.51
6	0.872	1.635	12.59	16.81	22.46
7	1.239	2.167	14.07	18.48	24.32
8	1.646	2.733	15.51	20.09	26.13
9	2.088	3.325	16.92	21.67	27.88
10	2.558	3.940	18.31	23.21	29.59
11	3.053	4.575	19.68	24.72	31.26
12	3.571	5.226	21.03	26.22	32.91
13	4.107	5.892	22.36	27.69	34.53
14	4.660	6.571	23.68	29.14	36.12
15	5.229	7.261	25.00	30.58	37.70
16	5.812	7.962	26.30	32.00	39.25
17	6.408	8.672	27.59	33.41	40.79
18	7.015	9.390	28.87	34.81	42.31
19	7.633	10.12	30.14	36.19	43.82
20	8.260	10.85	31.41	37.57	45.31
21	8.897	11.59	32.67	38.93	46.80
22	9.542	12.34	33.92	40.29	48.27
23	10.20	13.09	35.17	41.64	49.73
24	10.86	13.85	36.42	42.98	51.18
25	11.52	14.61	37.65	44.31	52.62
26	12.20	15.38	38.89	45.64	54.05
27	12.88	16.15	40.11	46.96	55.48
28	13.56	16.93	41.34	48.28	56.89
29	14.26	17.71	42.56	49.59	58.30
30	14.95	18.49	43.77	50.89	59.70

The table gives the percentage points most frequently required for significance tests based on  $\chi^2$ . Thus the probability of observing a  $\chi^2$  with 5 degrees of freedom **greater** in value than 11.07 is 0.05 or 5 per cent. Again, the probability of observing a  $\chi^2$  with 5 degrees of freedom **smaller** in value than 0.554 is  $1 - 0.99 = 0.01$  or 1 per cent.

# Appendix X

## Technique for selecting a simple random sample

**Example** An investigator requires a random sample of 10 animals from a population of 90.

Construct a sampling frame of all animals and label them consecutively from 1 to 90. The random numbers in the table overleaf are arranged in groups of two columns for visual convenience (other tables may have different numbers of columns grouped together).

- (1) Select two columns arbitrarily, to correspond to tens and units – use columns 27 and 28 for visual convenience.
- (2) Select a row arbitrarily – say row 7: number 89.

(3) Move down the columns: 89, 97, 32, 21, 60, 48, 10, 98, 23, 89, 08, 15, 44, 68. . . . All numbers greater than 90 are ignored. The first 10 numbers are then: 89, 32, 21, 60, 48, 10, 23, 89, 08, 15.

(4) Number 89 has been selected twice. The second 89 should be rejected\* and the next available number chosen: 44.

The sample size of 10 is then made up of animals labelled 89, 32, 21, 60, 48, 10, 23, 8, 15, 44.

If the table is used repeatedly, then the row and column starting point should be changed.

---

\* Rejection of numbers that occur more than once is performed if animals are not returned to the selection pool after having been selected once: sampling 'without replacement'. If animals are returned to the pool after having been selected once, so that they can be selected again – sampling 'with replacement' – then a number corresponding to an animal can be selected more than once (number 89 in this example).

Table of random numbers. (Extracted from Lindley and Scott, 1984.)

84 42	56 53	87 75	18 91	76 66	64 83	97 11	69 41	80 92	38 75
28 87	77 03	57 09	85 86	46 86	40 15	31 81	78 91	30 22	88 58
64 12	39 65	37 93	76 46	11 09	56 28	94 54	10 14	30 73	80 30
49 41	73 76	49 64	06 70	99 37	72 60	39 16	02 26	91 90	16 54
06 46	69 31	24 33	52 67	85 07	01 33	16 33	43 98	17 62	52 52
75 56	96 97	65 20	68 68	60 97	90 46	63 37	10 34	41 64	85 01
09 35	89 97	97 10	00 76	39 82	49 94	15 89	60 65	57 03	91 68
73 81	11 08	52 73	64 85	22 72	85 16	15 97	76 28	41 95	00 33
49 69	80 41	46 62	26 32	58 16	88 76	54 32	06 37	46 45	28 95
64 60	49 70	33 73	71 57	83 26	19 25	86 21	64 60	11 01	86 70
93 05	36 44	59 19	99 51	54 21	37 48	18 60	22 92	68 34	39 02
39 88	11 26	68 92	81 14	12 16	37 64	61 48	21 69	77 76	33 00
89 34	19 12	83 76	35 11	96 53	04 76	63 10	93 68	52 42	73 20
77 29	03 26	45 36	15 17	27 28	79 58	38 98	73 52	63 72	48 41
86 75	51 29	70 78	24 78	94 78	64 17	32 23	95 52	87 79	14 30
95 98	77 51	14 65	76 49	42 36	11 33	23 89	32 01	60 48	91 44
22 09	01 14	04 96	97 56	92 52	83 44	45 08	72 78	10 36	26 70
30 49	36 23	36 81	11 76	91 08	67 60	01 15	64 77	21 33	72 29
77 59	88 92	17 75	04 47	18 02	94 84	71 44	87 63	06 04	49 33
03 50	80 26	74 74	18 85	92 20	64 39	98 68	29 26	90 14	77 36
46 32	79 69	41 06	26 04	47 24	67 10	66 69	21 55	66 63	48 47
65 73	98 08	05 96	92 27	22 86	54 87	95 87	40 27	09 97	47 21
68 82	77 73	08 37	28 47	73 49	10 65	53 48	87 74	02 99	52 86
93 98	12 19	82 69	61 08	00 42	88 83	70 85	08 48	74 94	88 61
61 27	39 16	42 17	89 81	27 44	12 33	43 24	92 41	55 13	45 01
54 74	04 79	72 61	21 87	23 83	96 56	97 63	67 02	67 30	36 89
28 00	40 86	92 97	06 22	37 37	83 00	97 17	08 06	43 95	76 84
61 78	71 16	41 01	69 63	35 96	60 65	09 44	93 42	72 11	22 85
68 60	92 99	60 97	53 55	34 61	43 40	77 96	19 87	63 49	22 47
21 76	13 39	25 89	91 38	25 19	44 33	11 36	72 21	40 90	76 95
73 59	53 04	35 13	12 31	88 70	05 40	43 42	47 17	03 86	14 10
85 68	66 48	05 24	28 97	84 84	91 65	62 83	89 68	07 51	01 02
60 30	10 46	44 34	19 56	00 83	20 53	53 05	29 03	47 55	23 26
44 63	80 62	80 80	99 43	33 87	70 52	51 62	02 12	02 90	44 44
89 38	13 68	31 31	97 15	35 67	23 74	76 96	62 82	62 19	65 58
55 20	77 12	79 81	42 15	30 67	88 83	69 08	99 82	20 39	92 40
67 40	42 16	46 06	60 74	61 22	95 47	24 62	81 06	19 67	15 06
57 19	76 98	65 64	55 28	34 03	58 62	35 22	67 40	04 88	17 59
21 72	97 04	82 62	09 54	35 17	22 73	35 72	53 65	95 48	55 12
46 89	95 61	31 77	14 14	24 14	91 58	76 56	19 33	98 67	09 04
99 73	85 64	96 58	61 65	60 83	62 10	87 00	82 63	39 90	83 17
85 52	98 27	40 33	09 59	80 17	22 06	84 03	41 48	76 07	26 69
50 12	17 86	50 57	91 28	42 29	83 87	00 87	93 52	53 47	08 65
92 84	02 93	44 36	93 19	08 54	76 62	31 65	94 68	38 04	62 31
69 74	30 25	68 65	19 77	57 05	71 56	91 30	16 66	70 48	78 65
51 69	76 00	20 92	58 21	24 33	74 08	66 90	61 89	56 83	39 58
27 25	81 29	75 02	85 09	58 89	77 83	03 40	21 14	45 90	54 01
44 03	62 96	68 65	24 57	44 43	07 72	59 16	04 94	23 36	55 85
40 59	49 20	48 63	35 74	33 12	96 25	59 35	07 45	80 97	19 90
92 91	07 14	82 22	50 70	75 15	69 71	31 20	60 06	99 56	57 74



# Appendix XI

---

## Sample sizes

This Appendix comprises sample sizes required to attain a desired confidence interval around expected prevalence values of 5%, 10%, 20%, 30%, 40% and 50% (from WHO, 1973). For example, if the expected

prevalence is 30%, consult *Figure 4*. A sample size of 200 will produce a 95% confidence interval of 24% to 36%. A sample size of 800 will produce a 95% confidence interval of 27% to 33%.

Sample size required to attain desired confidence interval around expected percentage of 5%

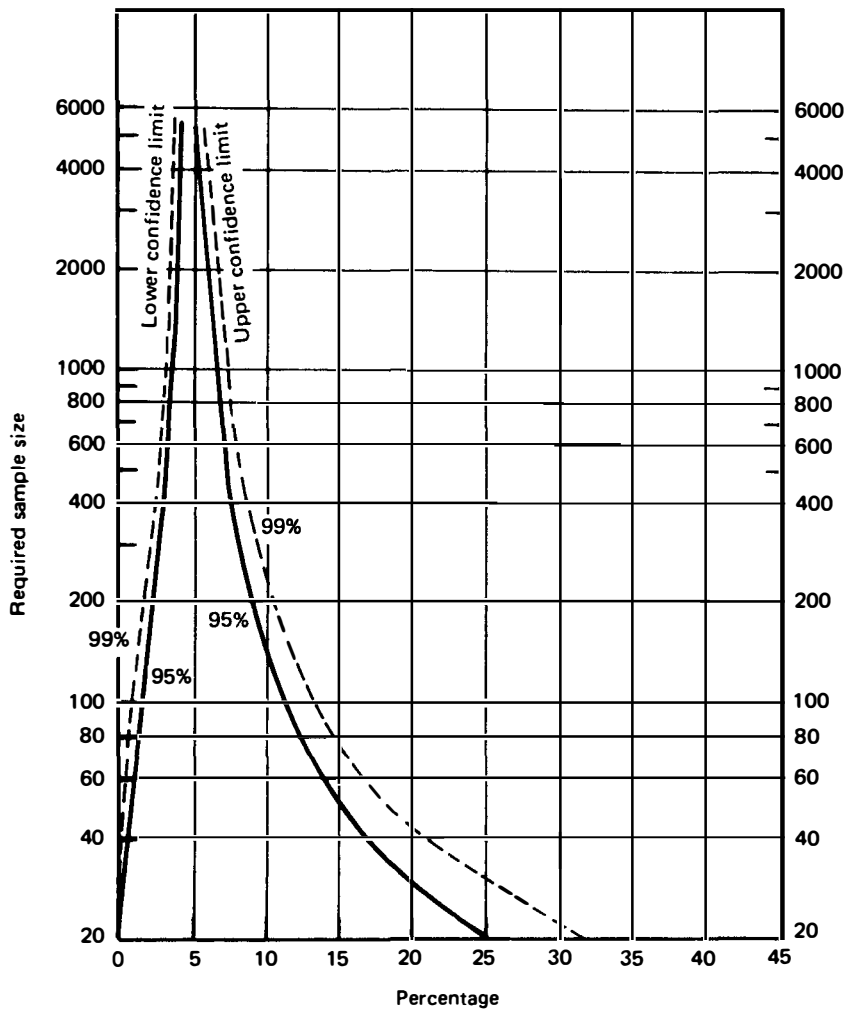

Fig. 1

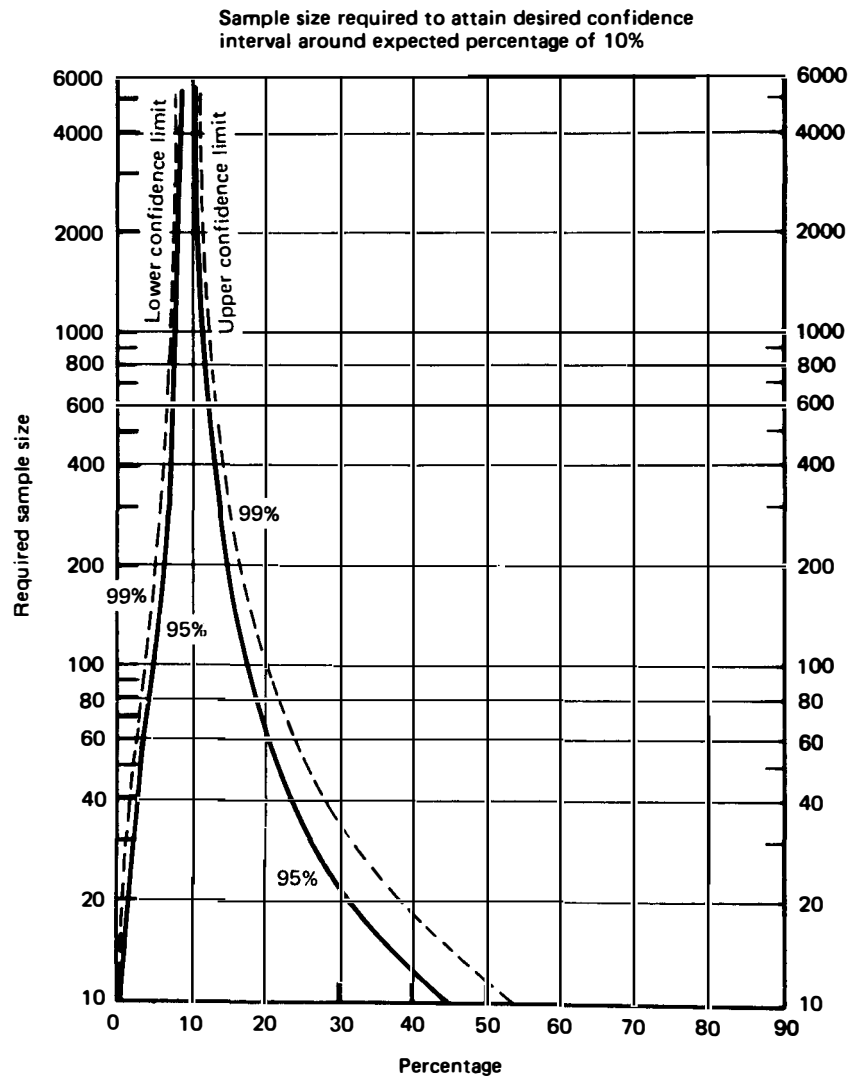

Fig. 2

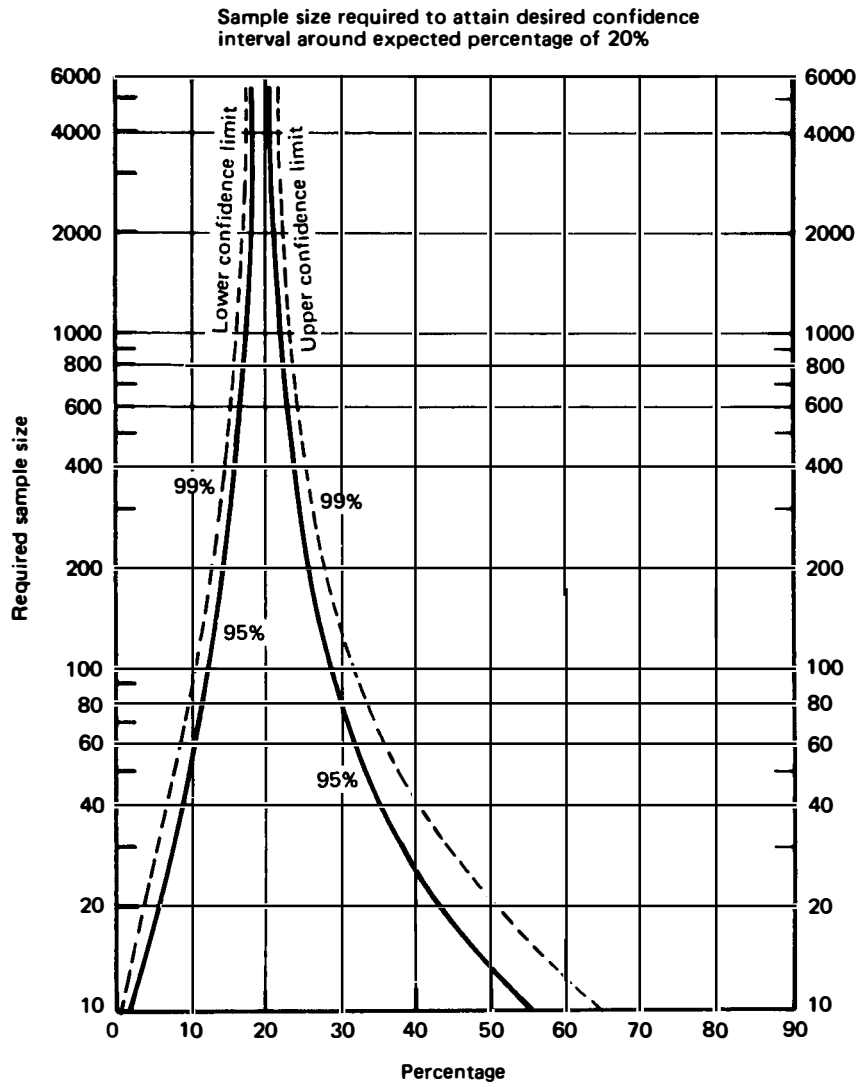

Fig. 3

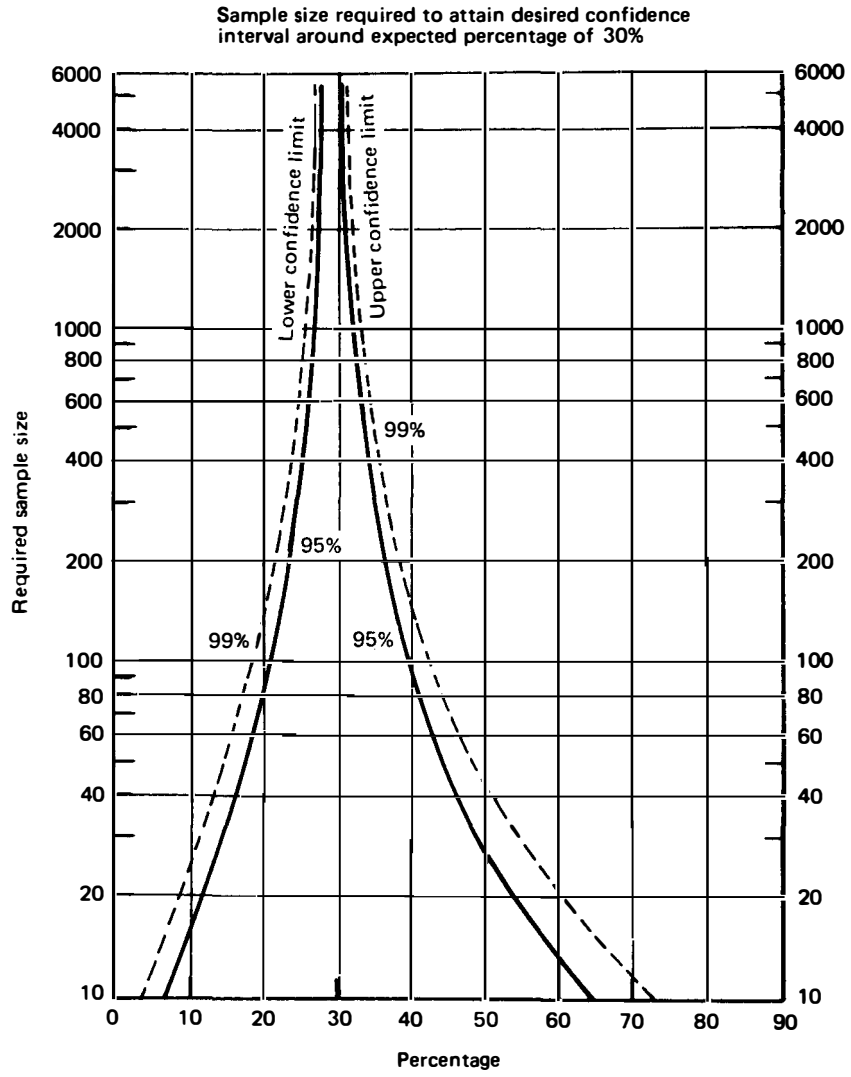

Fig. 4

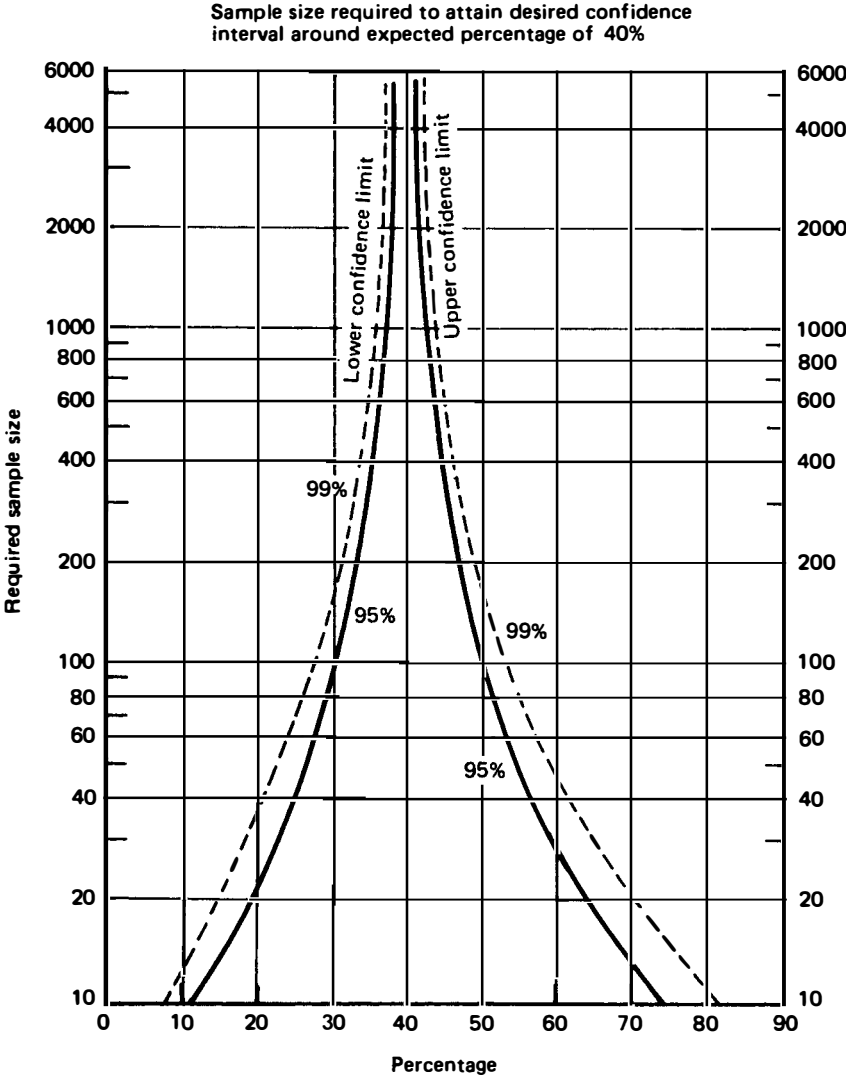

Fig. 5

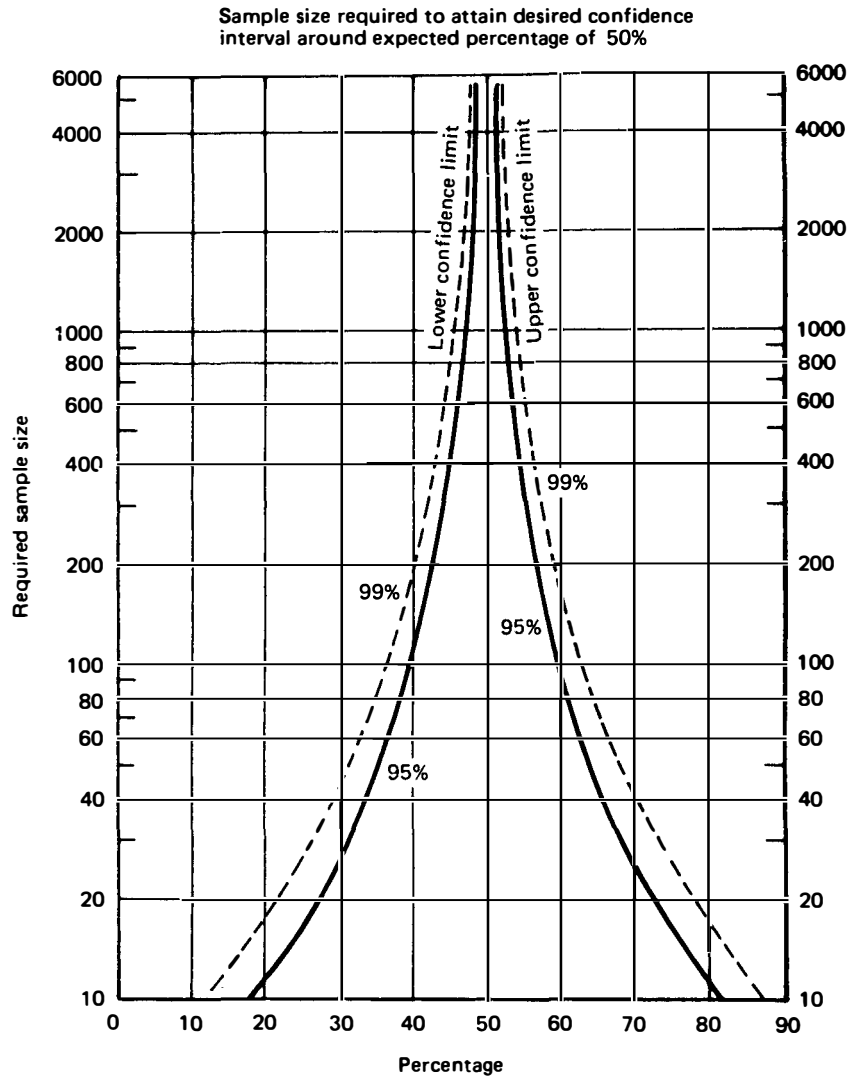

Fig. 6

# Appendix XII

## The probability of detecting a small number of cases in a population

(Modified from Cannon and Roe, 1982)

These tables give the probability of detecting at least one case for different sampling fractions and numbers of cases in the population.

**Example** A 40% sample from a herd of 20 animals would have a 97.6% chance of including at least one positive if six were present in the herd.

### 20% Sampling

Population size	Number sampled	Number of positives in the population							
		1	2	3	4	5	6	7	8
10	2	0.200	0.378	0.533	0.667	0.778	0.867	0.933	0.978
20	4	0.200	0.368	0.509	0.624	0.718	0.793	0.852	0.898
30	6	0.200	0.366	0.501	0.612	0.702	0.773	0.830	0.874
40	8	0.200	0.364	0.498	0.607	0.694	0.764	0.819	0.863
50	10	0.200	0.363	0.498	0.603	0.689	0.758	0.813	0.857
60	12	0.200	0.363	0.495	0.601	0.686	0.755	0.809	0.853
70	14	0.200	0.362	0.494	0.599	0.684	0.752	0.807	0.850
80	16	0.200	0.362	0.493	0.598	0.683	0.751	0.804	0.847
90	18	0.200	0.362	0.492	0.597	0.682	0.749	0.803	0.846
100	20	0.200	0.362	0.492	0.597	0.681	0.748	0.802	0.844
∞	∞	0.200	0.360	0.486	0.590	0.672	0.738	0.790	0.832

### 30% Sampling

Population size	Number sampled	Number of positives in the population							
		1	2	3	4	5	6	7	8
10	3	0.300	0.533	0.708	0.833	0.917	0.967	0.992	1.000
20	6	0.300	0.521	0.681	0.793	0.871	0.923	0.956	0.976
30	9	0.300	0.517	0.672	0.782	0.857	0.909	0.943	0.965
40	12	0.300	0.515	0.668	0.776	0.851	0.902	0.936	0.960
50	15	0.300	0.514	0.666	0.773	0.847	0.898	0.933	0.956
60	18	0.300	0.514	0.665	0.770	0.844	0.895	0.930	0.954
70	21	0.300	0.513	0.663	0.769	0.842	0.893	0.928	0.952
80	24	0.300	0.513	0.663	0.768	0.841	0.892	0.927	0.951
90	27	0.300	0.512	0.662	0.767	0.840	0.891	0.926	0.950
100	30	0.300	0.512	0.661	0.766	0.839	0.890	0.925	0.949
∞	∞	0.300	0.510	0.657	0.760	0.832	0.882	0.918	0.942



## 40% Sampling

Population size	Number sampled	Number of positives in the population							
		1	2	3	4	5	6	7	8
10	4	0.400	0.667	0.833	0.929	0.976	0.995	1.000	1.000
20	8	0.400	0.653	0.807	0.898	0.949	0.976	0.990	0.996
30	12	0.400	0.648	0.799	0.888	0.940	0.969	0.984	0.993
40	16	0.400	0.646	0.795	0.884	0.935	0.965	0.981	0.990
50	20	0.400	0.645	0.793	0.881	0.933	0.963	0.980	0.989
60	24	0.400	0.644	0.791	0.879	0.931	0.961	0.978	0.988
70	28	0.400	0.643	0.790	0.878	0.930	0.960	0.977	0.987
80	32	0.400	0.643	0.789	0.877	0.929	0.959	0.977	0.987
90	36	0.400	0.643	0.789	0.876	0.928	0.959	0.976	0.987
100	40	0.400	0.642	0.788	0.876	0.927	0.958	0.976	0.986
$\infty$	$\infty$	0.400	0.640	0.784	0.870	0.922	0.953	0.972	0.983

## 50% Sampling

Population size	Number sampled	Number of positives in the population							
		1	2	3	4	5	6	7	8
10	5	0.500	0.778	0.917	0.976	0.996	1.000	1.000	1.000
20	10	0.500	0.763	0.895	0.957	0.984	0.995	0.998	0.994
30	15	0.500	0.759	0.888	0.950	0.979	0.992	0.997	0.999
40	20	0.500	0.756	0.885	0.947	0.976	0.990	0.996	0.998
50	25	0.500	0.755	0.883	0.945	0.975	0.989	0.995	0.998
60	30	0.500	0.754	0.881	0.944	0.974	0.988	0.995	0.998
70	35	0.500	0.754	0.880	0.943	0.973	0.988	0.994	0.998
80	40	0.500	0.753	0.880	0.942	0.973	0.987	0.994	0.997
90	45	0.500	0.753	0.879	0.942	0.972	0.987	0.994	0.997
100	50	0.500	0.753	0.879	0.941	0.972	0.987	0.994	0.997
$\infty$	$\infty$	0.500	0.750	0.875	0.937	0.969	0.984	0.992	0.996

## 60% Sampling

Population size	Number sampled	Number of positives in the population							
		1	2	3	4	5	6	7	8
10	6	0.600	0.867	0.967	0.994	1.000	1.000	1.000	1.000
20	12	0.600	0.853	0.951	0.986	0.994	0.997	1.000	1.000
30	18	0.600	0.848	0.946	0.982	0.994	0.997	1.000	1.000
40	24	0.600	0.846	0.943	0.980	0.993	0.997	0.999	1.000
50	30	0.600	0.845	0.942	0.979	0.993	0.997	0.999	1.000
60	36	0.600	0.844	0.941	0.978	0.992	0.997	0.999	1.000
70	42	0.600	0.843	0.940	0.978	0.992	0.997	0.999	1.000
80	48	0.600	0.843	0.940	0.977	0.992	0.997	0.999	1.000
90	54	0.600	0.843	0.939	0.977	0.991	0.997	0.999	1.000
100	60	0.600	0.842	0.939	0.977	0.991	0.997	0.999	1.000
$\infty$	$\infty$	0.600	0.840	0.936	0.974	0.990	0.996	0.998	1.000



# Appendix XIV

## Sample sizes required for detecting disease with probability, $p_1$ , and threshold number of positives (in brackets) (probability of incorrectly concluding that a healthy population is diseased [in square brackets])

These tables give the number of animals that need to be sampled, and the upper limit of the number of test-positive animals that can be identified in the sample, while still concluding, with probability  $p_1$ , that disease is absent.

**Example** (consult the first table) A diagnostic test has a sensitivity of 99% and specificity of 99%. If 173 animals are sampled from a population of 500 in which, if disease is present, the minimum prevalence is 5%,

up to four test-positive animals can be identified in the sample, while still concluding, with probability,  $p_1$ , 0.99, that disease is absent. The probability of observing more than four test-positive animals in a disease-free population is no greater than 0.05. Thus, if more than four test-positive animals are identified in the sample, the probability of incorrectly concluding that a healthy population is diseased is no greater than 0.05 (i.e., it can be concluded that the population is diseased, with at least 95% 'confidence').

$p_1 = 0.99$ ; sensitivity = 99%; specificity = 99%

Population size	Prevalence														
	50%			20%			10%			5%			1%		
	[1.0]	[0.05]	[0.01]	[1.0]	[0.05]	[0.01]	[1.0]	[0.05]	[0.01]	[1.0]	[0.05]	[0.01]	[1.0]	[0.05]	[0.01]
30	6 (0)	9 (1)	9 (1)	15 (0)	20 (1)	24 (2)	23 (0)	28 (1)	*	27 (0)	*	*	*	*	*
50	7 (0)	10 (1)	10 (1)	17 (0)	24 (1)	29 (2)	29 (0)	44 (2)	44 (2)	44 (0)	*	*	*	*	*
100	7 (0)	10 (1)	10 (1)	19 (0)	26 (1)	33 (2)	34 (0)	58 (2)	67 (3)	55 (0)	96 (3)	*	99 (0)	*	*
150	7 (0)	10 (1)	10 (1)	19 (0)	27 (1)	35 (2)	36 (0)	63 (2)	74 (3)	59 (0)	113 (3)	126 (4)	123 (0)	*	*
200	7 (0)	10 (1)	10 (1)	19 (0)	28 (1)	35 (2)	37 (0)	66 (2)	78 (3)	65 (0)	129 (3)	160 (5)	157 (0)	*	*
300	7 (0)	10 (1)	10 (1)	20 (0)	29 (1)	36 (2)	38 (0)	69 (2)	82 (3)	68 (0)	161 (4)	179 (5)	182 (0)	*	*
500	7 (0)	11 (1)	11 (1)	20 (0)	29 (1)	37 (2)	39 (0)	71 (2)	98 (4)	71 (0)	173 (4)	215 (6)	202 (0)	*	*
1000	7 (0)	11 (1)	11 (1)	20 (0)	29 (1)	37 (2)	40 (0)	73 (2)	101 (4)	74 (0)	183 (4)	229 (6)	217 (0)	*	*
5000	7 (0)	11 (1)	11 (1)	20 (0)	30 (1)	38 (2)	41 (0)	75 (2)	103 (4)	76 (0)	191 (4)	264 (7)	228 (0)	2078 (28)	2754 (40)
10 000	7 (0)	11 (1)	11 (1)	20 (0)	30 (1)	38 (2)	41 (0)	75 (2)	104 (4)	76 (0)	193 (4)	267 (7)	230 (0)	2406 (32)	?

\* = Required accuracy cannot be achieved, even by sampling all animals in the population.

? = Unable to compute (population size too large).

 $p_1 = 0.99$ ; sensitivity = 95%; specificity = 99%

Population size	Prevalence														
	50%			20%			10%			5%			1%		
	[1.0]	[0.05]	[0.01]	[1.0]	[0.05]	[0.01]	[1.0]	[0.05]	[0.01]	[1.0]	[0.05]	[0.01]	[1.0]	[0.05]	[0.01]
30	7 (0)	10 (1)	10 (1)	16 (0)	21 (1)	25 (2)	24 (0)	30 (1)	*	28 (0)	*	*	*	*	*
50	7 (0)	10 (1)	10 (1)	18 (0)	25 (1)	30 (2)	30 (0)	46 (2)	46 (2)	46 (0)	*	*	*	*	*
100	7 (0)	11 (1)	11 (1)	19 (0)	28 (1)	35 (2)	35 (0)	60 (2)	70 (3)	58 (0)	100 (3)	*	*	*	*
150	7 (0)	11 (1)	11 (1)	20 (0)	29 (1)	36 (2)	38 (0)	66 (2)	77 (3)	61 (0)	118 (3)	143 (5)	128 (0)	*	*
200	7 (0)	11 (1)	11 (1)	20 (0)	29 (1)	37 (2)	39 (0)	69 (2)	81 (3)	67 (0)	134 (3)	167 (5)	163 (0)	*	*
300	7 (0)	11 (1)	11 (1)	21 (0)	30 (1)	38 (2)	40 (0)	72 (2)	98 (4)	71 (0)	167 (4)	204 (6)	188 (0)	*	*
500	7 (0)	11 (1)	11 (1)	21 (0)	30 (1)	39 (2)	41 (0)	74 (2)	102 (4)	74 (0)	180 (4)	223 (6)	208 (0)	*	*
1000	8 (0)	11 (1)	11 (1)	21 (0)	31 (1)	39 (2)	42 (0)	76 (2)	105 (4)	76 (0)	190 (4)	260 (7)	222 (0)	*	*
5000	8 (0)	11 (1)	11 (1)	21 (0)	31 (1)	39 (2)	42 (0)	78 (2)	107 (4)	78 (0)	198 (4)	273 (7)	232 (0)	2242 (30)	2929 (42)
10 000	8 (0)	11 (1)	11 (1)	21 (0)	31 (1)	40 (2)	42 (0)	78 (2)	108 (4)	79 (0)	226 (5)	276 (7)	235 (0)	2579 (34)	?

 $p_1 = 0.99$ ; sensitivity = 95%; specificity = 95%

Population size	Prevalence														
	50%			20%			10%			5%			1%		
	[1.0]	[0.05]	[0.01]	[1.0]	[0.05]	[0.01]	[1.0]	[0.05]	[0.01]	[1.0]	[0.05]	[0.01]	[1.0]	[0.05]	[0.01]
30	6 (0)	12 (2)	14 (3)	14 (0)	*	*	22 (0)	*	*	26 (0)	*	*	*	*	*
50	7 (0)	13 (2)	15 (3)	16 (0)	37 (4)	45 (6)	25 (0)	48 (3)	*	39 (0)	*	*	*	*	*
100	7 (0)	13 (2)	16 (3)	17 (0)	47 (5)	57 (7)	28 (0)	94 (8)	*	41 (0)	*	*	69 (0)	*	*
150	7 (0)	13 (2)	16 (3)	17 (0)	49 (5)	60 (7)	29 (0)	118 (10)	145 (14)	42 (0)	*	*	68 (0)	*	*
200	7 (0)	13 (2)	16 (3)	17 (0)	50 (5)	66 (8)	30 (0)	124 (10)	161 (15)	44 (0)	*	*	73 (0)	*	*
300	7 (0)	14 (2)	16 (3)	18 (0)	51 (5)	68 (8)	30 (0)	137 (11)	178 (16)	45 (0)	*	*	74 (0)	*	*
500	7 (0)	14 (2)	16 (3)	18 (0)	52 (5)	69 (8)	30 (0)	151 (12)	193 (17)	46 (0)	400 (27)	*	75 (0)	*	*
1000	7 (0)	14 (2)	17 (3)	18 (0)	53 (5)	70 (8)	31 (0)	154 (12)	107 (18)	46 (0)	465 (31)	604 (43)	76 (0)	*	*
5000	7 (0)	14 (2)	17 (3)	18 (0)	53 (5)	71 (8)	31 (0)	166 (13)	220 (19)	46 (0)	504 (33)	687 (48)	76 (0)	*	*
10 000	7 (0)	14 (2)	17 (3)	18 (0)	53 (5)	71 (8)	31 (0)	167 (13)	221 (19)	47 (0)	520 (34)	705 (49)	76 (0)	*	*

$p_1 = 0.95$ ; sensitivity = 99%; specificity = 99%

Population size	Prevalence														
	50%			20%			10%			5%			1%		
	[1.0]	[0.05]	[0.01]	[1.0]	[0.05]	[0.01]	[1.0]	[0.05]	[0.01]	[1.0]	[0.05]	[0.01]	[1.0]	[0.05]	[0.01]
30	5 (0)	5 (0)	7 (1)	11 (0)	17 (1)	21 (2)	18 (0)	26 (1)	30 (2)	23 (0)	30 (1)	*	*	*	*
50	5 (0)	5 (0)	7 (1)	12 (0)	19 (1)	24 (2)	21 (0)	32 (1)	40 (2)	37 (0)	49 (1)	*	*	*	*
100	5 (0)	5 (0)	8 (1)	13 (0)	20 (1)	26 (2)	24 (0)	48 (2)	57 (3)	41 (0)	77 (2)	99 (4)	89 (0)	*	*
150	5 (0)	5 (0)	8 (1)	13 (0)	20 (1)	27 (2)	25 (0)	50 (2)	61 (3)	41 (0)	82 (2)	113 (4)	97 (0)	*	*
200	5 (0)	5 (0)	8 (1)	13 (0)	21 (1)	28 (2)	26 (0)	52 (2)	63 (3)	45 (0)	109 (3)	127 (4)	120 (0)	*	*
300	5 (0)	5 (0)	8 (1)	13 (0)	21 (1)	28 (2)	26 (0)	53 (2)	66 (3)	46 (0)	116 (3)	154 (5)	130 (0)	*	*
500	5 (0)	5 (0)	8 (1)	13 (0)	21 (1)	28 (2)	26 (0)	55 (2)	67 (3)	48 (0)	121 (3)	163 (5)	139 (0)	*	*
1000	5 (0)	5 (0)	8 (1)	13 (0)	21 (1)	29 (2)	26 (0)	56 (2)	69 (3)	49 (0)	125 (3)	169 (5)	145 (0)	*	*
5000	5 (0)	5 (0)	8 (1)	13 (0)	22 (1)	29 (2)	27 (0)	56 (2)	70 (3)	50 (0)	129 (3)	175 (5)	149 (0)	1487 (21)	2104 (32)
10 000	5 (0)	5 (0)	8 (1)	13 (0)	22 (1)	29 (2)	27 (0)	57 (2)	70 (3)	50 (0)	129 (3)	176 (5)	150 (0)	1641 (23)	2338 (35)

$p_1 = 0.95$ ; sensitivity = 95%; specificity = 99%

Population size	Prevalence														
	50%			20%			10%			5%			1%		
	[1.0]	[0.05]	[0.01]	[1.0]	[0.05]	[0.01]	[1.0]	[0.05]	[0.01]	[1.0]	[0.05]	[0.01]	[1.00]	[0.05]	[0.01]
30	5 (0)	5 (0)	8 (1)	12 (0)	18 (1)	22 (2)	19 (0)	27 (1)	*	24 (0)	*	*	*	*	*
50	5 (0)	5 (0)	8 (1)	12 (0)	19 (1)	25 (2)	22 (0)	33 (1)	41 (2)	39 (0)	*	*	*	*	*
100	5 (0)	5 (0)	8 (1)	13 (0)	21 (1)	28 (2)	25 (0)	50 (2)	60 (3)	42 (0)	80 (2)	*	93 (0)	*	*
150	5 (0)	5 (0)	8 (1)	14 (0)	21 (1)	28 (2)	26 (0)	53 (2)	64 (3)	43 (0)	102 (3)	118 (4)	100 (0)	*	*
200	5 (0)	5 (0)	8 (1)	14 (0)	22 (1)	29 (2)	26 (0)	54 (2)	66 (3)	47 (0)	113 (3)	148 (5)	123 (0)	*	*
300	5 (0)	5 (0)	8 (1)	14 (0)	22 (1)	29 (2)	27 (0)	56 (2)	68 (3)	48 (0)	120 (3)	160 (5)	134 (0)	*	*
500	5 (0)	5 (0)	8 (1)	14 (0)	22 (1)	30 (2)	27 (0)	57 (2)	70 (3)	49 (0)	126 (3)	169 (5)	142 (0)	*	*
1000	5 (0)	5 (0)	8 (1)	14 (0)	22 (1)	30 (2)	27 (0)	58 (2)	71 (3)	50 (0)	130 (3)	175 (5)	148 (0)	*	*
5000	5 (0)	5 (0)	8 (1)	14 (0)	22 (1)	30 (2)	28 (0)	59 (2)	72 (3)	51 (0)	133 (3)	204 (6)	152 (0)	1636 (23)	2263 (34)
10 000	5 (0)	5 (0)	8 (1)	14 (0)	23 (1)	30 (2)	28 (0)	59 (2)	73 (3)	52 (0)	134 (3)	205 (6)	153 (0)	1735 (24)	2503 (37)

$p_1 = 0.95$ ; sensitivity = 95%; specificity = 95%

Population size	Prevalence														
	50%			20%			10%			5%			1%		
	[1.0]	[0.05]	[0.01]	[1.0]	[0.05]	[0.01]	[1.0]	[0.05]	[0.01]	[1.0]	[0.05]	[0.01]	[1.0]	[0.05]	[0.01]
30	5 (0)	7 (1)	12 (3)	10 (0)	25 (3)	*	16 (0)	*	*	20 (0)	*	*	*	*	*
50	5 (0)	10 (2)	13 (3)	11 (0)	28 (3)	36 (5)	18 (0)	49 (5)	*	29 (0)	*	*	*	*	*
100	5 (0)	10 (2)	13 (3)	11 (0)	35 (4)	45 (6)	19 (0)	79 (7)	*	28 (0)	*	*	47 (0)	*	*
150	5 (0)	10 (2)	13 (3)	12 (0)	36 (4)	46 (6)	20 (0)	91 (8)	121 (12)	28 (0)	*	*	46 (0)	*	*
200	5 (0)	11 (2)	13 (3)	12 (0)	36 (4)	47 (6)	20 (0)	94 (8)	132 (13)	29 (0)	*	*	49 (0)	*	*
300	5 (0)	11 (2)	13 (3)	12 (0)	37 (4)	48 (6)	20 (0)	104 (9)	136 (13)	30 (0)	268 (19)	*	49 (0)	*	*
500	5 (0)	11 (2)	13 (3)	12 (0)	37 (4)	48 (6)	20 (0)	106 (9)	148 (14)	30 (0)	300 (21)	423 (32)	49 (0)	*	*
1000	5 (0)	11 (2)	13 (3)	12 (0)	37 (4)	54 (7)	20 (0)	108 (9)	150 (14)	30 (0)	331 (23)	459 (34)	50 (0)	*	*
5000	5 (0)	11 (2)	13 (3)	12 (0)	38 (4)	54 (7)	20 (0)	109 (9)	152 (14)	30 (0)	349 (24)	492 (36)	50 (0)	*	*
10 000	5 (0)	11 (2)	13 (3)	12 (0)	38 (4)	54 (7)	20 (0)	109 (9)	161 (15)	30 (0)	351 (24)	507 (37)	50 (0)	*	*

$p_1 = 0.90$ ; sensitivity = 99%; specificity = 99%

Population size	Prevalence														
	50%			20%			10%			5%			1%		
	[1.0]	[0.05]	[0.01]	[1.0]	[0.05]	[0.01]	[1.0]	[0.05]	[0.01]	[1.0]	[0.05]	[0.01]	[1.0]	[0.05]	[0.01]
30	4 (0)	4 (0)	6 (1)	9 (0)	15 (1)	15 (1)	15 (0)	24 (1)	29 (2)	20 (0)	29 (1)	*	*	*	*
50	4 (0)	4 (0)	6 (1)	10 (0)	16 (1)	21 (2)	17 (0)	28 (1)	37 (2)	32 (0)	47 (1)	47 (1)	*	*	*
100	4 (0)	4 (0)	7 (1)	10 (0)	17 (1)	23 (2)	19 (0)	31 (1)	42 (2)	33 (0)	70 (2)	96 (4)	79 (0)	*	*
150	4 (0)	4 (0)	7 (1)	10 (0)	17 (1)	24 (2)	19 (0)	32 (1)	42 (2)	33 (0)	73 (2)	105 (4)	80 (0)	*	*
200	4 (0)	4 (0)	7 (1)	10 (0)	17 (1)	24 (2)	20 (0)	33 (1)	56 (3)	35 (0)	79 (2)	116 (4)	98 (0)	*	*
300	4 (0)	4 (0)	7 (1)	10 (0)	18 (1)	24 (2)	20 (0)	34 (1)	58 (3)	36 (0)	82 (2)	122 (4)	104 (0)	*	*
500	4 (0)	4 (0)	7 (1)	10 (0)	18 (1)	24 (2)	20 (0)	34 (1)	59 (3)	37 (0)	106 (3)	127 (4)	109 (0)	*	*
1000	4 (0)	4 (0)	7 (1)	10 (0)	18 (1)	24 (2)	20 (0)	35 (1)	60 (3)	38 (0)	109 (3)	151 (5)	112 (0)	981 (15)	*
5000	4 (0)	4 (0)	7 (1)	10 (0)	18 (1)	25 (2)	21 (0)	35 (1)	60 (3)	38 (0)	111 (3)	155 (5)	115 (0)	1226 (18)	1781 (28)
10 000	4 (0)	4 (0)	7 (1)	10 (0)	18 (1)	25 (2)	21 (0)	35 (1)	60 (3)	38 (0)	112 (3)	156 (5)	116 (0)	1305 (19)	1875 (29)

 $p_1 = 0.90$ ; sensitivity = 95%; specificity = 99%

Population size	Prevalence														
	50%			20%			10%			5%			1%		
	[1.0]	[0.05]	[0.01]	[1.0]	[0.05]	[0.01]	[1.0]	[0.05]	[0.01]	[1.0]	[0.05]	[0.01]	[1.0]	[0.05]	[0.01]
30	4 (0)	4 (0)	7 (1)	9 (0)	15 (1)	15 (1)	16 (0)	25 (1)	*	21 (0)	30 (1)	*	*	*	*
50	4 (0)	4 (0)	7 (1)	10 (0)	17 (1)	22 (2)	18 (0)	29 (1)	38 (2)	33 (0)	49 (1)	49 (1)	*	*	*
100	4 (0)	4 (0)	7 (1)	10 (0)	18 (1)	24 (2)	20 (0)	33 (1)	44 (2)	34 (0)	73 (2)	100 (4)	82 (0)	*	*
150	4 (0)	4 (0)	7 (1)	11 (0)	18 (1)	25 (2)	20 (0)	34 (1)	57 (3)	37 (0)	75 (2)	109 (4)	83 (0)	*	*
200	4 (0)	4 (0)	7 (1)	11 (0)	18 (1)	25 (2)	21 (0)	34 (1)	58 (3)	38 (0)	82 (2)	120 (4)	101 (0)	*	*
300	4 (0)	4 (0)	7 (1)	11 (0)	18 (1)	25 (2)	21 (0)	35 (1)	60 (3)	39 (0)	106 (3)	126 (4)	107 (0)	*	*
500	4 (0)	4 (0)	7 (1)	11 (0)	18 (1)	25 (2)	21 (0)	49 (2)	61 (3)	39 (0)	110 (3)	152 (5)	111 (0)	*	*
1000	4 (0)	4 (0)	7 (1)	11 (0)	19 (1)	25 (2)	21 (0)	49 (2)	62 (3)	39 (0)	113 (3)	156 (5)	115 (0)	*	*
5000	4 (0)	4 (0)	7 (1)	11 (0)	19 (1)	26 (2)	21 (0)	50 (2)	63 (3)	40 (0)	115 (3)	160 (5)	117 (0)	1310 (19)	1875 (29)
10 000	4 (0)	4 (0)	7 (1)	11 (0)	19 (1)	26 (2)	21 (0)	50 (2)	63 (3)	40 (0)	116 (3)	161 (5)	118 (0)	1391 (20)	2029 (31)

 $p_1 = 0.90$ ; sensitivity = 95%; specificity = 95%

Population size	Prevalence														
	50%			20%			10%			5%			1%		
	[1.0]	[0.05]	[0.01]	[1.0]	[0.05]	[0.01]	[1.0]	[0.05]	[0.01]	[1.0]	[0.05]	[0.01]	[1.0]	[0.05]	[0.01]
30	4 (0)	6 (1)	9 (2)	8 (0)	23 (3)	30 (5)	13 (0)	*	*	17 (0)	*	*	*	*	*
50	4 (0)	6 (1)	9 (2)	9 (0)	25 (3)	34 (5)	14 (0)	46 (4)	*	23 (0)	*	*	45 (0)	*	*
100	4 (0)	7 (1)	9 (2)	9 (0)	26 (3)	36 (5)	15 (0)	66 (6)	*	22 (0)	*	*	37 (0)	*	*
150	4 (0)	7 (1)	9 (2)	9 (0)	27 (3)	37 (5)	15 (0)	77 (7)	107 (11)	22 (0)	*	*	36 (0)	*	*
200	4 (0)	7 (1)	9 (2)	9 (0)	27 (3)	37 (5)	15 (0)	78 (7)	109 (11)	23 (0)	*	*	38 (0)	*	*
300	4 (0)	7 (1)	9 (2)	9 (0)	27 (3)	43 (6)	16 (0)	79 (7)	120 (12)	23 (0)	233 (17)	*	38 (0)	*	*
500	4 (0)	7 (1)	9 (2)	9 (0)	27 (3)	43 (6)	16 (0)	81 (7)	122 (12)	23 (0)	249 (18)	361 (28)	38 (0)	*	*
1000	4 (0)	7 (1)	9 (2)	9 (0)	27 (3)	44 (6)	16 (0)	81 (7)	123 (12)	23 (0)	265 (19)	380 (29)	38 (0)	*	*
5000	4 (0)	7 (1)	9 (2)	9 (0)	28 (3)	44 (6)	16 (0)	91 (8)	124 (12)	24 (0)	281 (20)	410 (31)	38 (0)	*	*
10 000	4 (0)	7 (1)	9 (2)	9 (0)	28 (3)	44 (6)	16 (0)	91 (8)	133 (13)	24 (0)	282 (20)	411 (31)	38 (0)	*	*



# Appendix XVI

## Lower- and upper-tail probabilities for $W_x$ , the Wilcoxon–Mann–Whitney rank-sum statistic

(From Siegel and Castellan, 1988)

The body of the table gives the one-tailed probability,  $P$ , of obtaining a value of  $W_x \leq c_L$ , and  $W_s \geq c_U$  under the

null hypothesis;  $W_x$  is the rank sum for the smaller group.

<b>m = 3</b>																				
$c_L$	$n=3$	$c_U$	$n=4$	$c_U$	$n=5$	$c_U$	$n=6$	$c_U$	$n=7$	$c_U$	$n=8$	$c_U$	$n=9$	$c_U$	$n=10$	$c_U$	$n=11$	$c_U$	$n=12$	$c_U$
6	.0500	15	.0286	18	.0179	21	.0119	24	.0083	27	.0061	30	.0045	33	.0035	36	.0027	39	.0022	42
7	.1000	14	.0571	17	.0357	20	.0238	23	.0167	26	.0121	29	.0091	32	.0070	35	.0055	38	.0044	41
8	.2000	13	.1143	16	.0714	19	.0476	22	.0333	25	.0242	28	.0182	31	.0140	34	.0110	37	.0088	40
9	.3500	12	.2000	15	.1250	18	.0833	21	.0583	24	.0424	27	.0318	30	.0245	33	.0192	36	.0154	39
10	.5000	11	.3143	14	.1964	17	.1310	20	.0917	23	.0667	26	.0500	29	.0385	32	.0302	35	.0242	38
11	.6500	10	.4286	13	.2857	16	.1905	19	.1333	22	.0970	25	.0727	28	.0559	31	.0440	34	.0352	37
12	.8000	9	.5714	12	.3929	15	.2738	18	.1917	21	.1394	24	.1045	27	.0804	30	.0632	33	.0505	36
13	.9000	8	.6857	11	.5000	14	.3571	17	.2583	20	.1879	23	.1409	26	.1084	29	.0852	32	.0681	35
14	.9500	7	.8000	10	.6071	13	.4524	16	.3333	19	.2485	22	.1864	25	.1434	28	.1126	31	.0901	34
15	1.0000	6	.8857	9	.7143	12	.5476	15	.4167	18	.3152	21	.2409	24	.1853	27	.1456	30	.1165	33
16			.9429	8	.8036	11	.6429	14	.5000	17	.3879	20	.3000	23	.2343	26	.1841	29	.1473	32
17			.9714	7	.8750	10	.7262	13	.5833	16	.4606	19	.3636	22	.2867	25	.2280	28	.1824	31
18			1.0000	6	.9286	9	.8095	12	.6667	15	.5394	18	.4318	21	.3462	24	.2775	27	.2242	30
19					.9643	8	.8690	11	.7417	14	.6121	17	.5000	20	.4056	23	.3297	26	.2681	29
20					.9821	7	.9167	10	.8083	13	.6848	16	.5682	19	.4685	22	.3846	25	.3165	28
21					1.0000	6	.9524	9	.8667	12	.7515	15	.6364	18	.5315	21	.4423	24	.3670	27
22							.9762	8	.9083	11	.8121	14	.7000	17	.5944	20	.5000	23	.4198	26
23							.9881	7	.9417	10	.8606	13	.7591	16	.6538	19	.5577	22	.4725	25
24							1.0000	6	.9667	9	.9030	12	.8136	15	.7133	18	.6154	21	.5275	24



<i>m</i> = 4																		
<i>c<sub>L</sub></i>	<i>n</i> = 4	<i>c<sub>U</sub></i>	<i>n</i> = 5	<i>c<sub>U</sub></i>	<i>n</i> = 6	<i>c<sub>U</sub></i>	<i>n</i> = 7	<i>c<sub>U</sub></i>	<i>n</i> = 8	<i>c<sub>U</sub></i>	<i>n</i> = 9	<i>c<sub>U</sub></i>	<i>n</i> = 10	<i>c<sub>U</sub></i>	<i>n</i> = 11	<i>c<sub>U</sub></i>	<i>n</i> = 12	<i>c<sub>U</sub></i>
10	.0143	26	.0079	30	.0048	34	.0030	38	.0020	42	.0014	46	.0010	50	.0007	54	.0005	58
11	.0286	25	.0159	29	.0095	33	.0061	37	.0040	41	.0028	45	.0020	49	.0015	53	.0011	57
12	.0571	24	.0317	28	.0190	32	.0121	36	.0081	40	.0056	44	.0040	48	.0029	52	.0022	56
13	.1000	23	.0556	27	.0333	31	.0212	35	.0141	39	.0098	43	.0070	47	.0051	51	.0038	55
14	.1714	22	.0952	26	.0571	30	.0364	34	.0242	38	.0168	42	.0120	46	.0088	50	.0066	54
15	.2429	21	.1429	25	.0857	29	.0545	33	.0364	37	.0252	41	.0180	45	.0132	49	.0099	53
16	.3429	20	.2063	24	.1286	28	.0818	32	.0545	36	.0378	40	.0270	44	.0198	48	.0148	52
17	.4429	19	.2778	23	.1762	27	.1152	31	.0768	35	.0531	39	.0380	43	.0278	47	.0209	51
18	.5571	18	.3651	22	.2381	26	.1576	30	.1071	34	.0741	38	.0529	42	.0388	46	.0291	50
19	.6571	17	.4524	21	.3048	25	.2061	29	.1414	33	.0993	37	.0709	41	.0520	45	.0390	49
20	.7571	16	.5476	20	.3810	24	.2636	28	.1838	32	.1301	36	.0939	40	.0689	44	.0516	48
21	.8286	15	.6349	19	.4571	23	.3242	27	.2303	31	.1650	35	.1199	39	.0886	43	.0665	47
22	.9000	14	.7222	18	.5429	22	.3939	26	.2848	30	.2070	34	.1518	38	.1128	42	.0852	46
23	.9429	13	.7937	17	.6190	21	.4636	25	.3414	29	.2517	33	.1868	37	.1399	41	.1060	45
24	.9714	12	.8571	16	.6952	20	.5364	24	.4040	28	.3021	32	.2268	36	.1714	40	.1308	44
25	.9857	11	.9048	15	.7619	19	.6061	23	.4667	27	.3552	31	.2697	35	.2059	39	.1582	43
26	1.0000	10	.9444	14	.8238	18	.6758	22	.5333	26	.4126	30	.3177	34	.2447	38	.1896	42
27			.9683	13	.8714	17	.7364	21	.5960	25	.4699	29	.3666	33	.2857	37	.2231	41
28			.9841	12	.9143	16	.7939	20	.6586	24	.5301	28	.4196	32	.3304	36	.2604	40
29			.9921	11	.9429	15	.8424	19	.7152	23	.5874	27	.4725	31	.3766	35	.2995	39
30			1.0000	10	.9667	14	.8848	18	.7697	22	.6448	26	.5275	30	.4256	34	.3418	38
31					.9810	13	.9182	17	.8162	21	.6979	25	.5804	29	.4747	33	.3852	37
32					.9905	12	.9455	16	.8586	20	.7483	24	.6334	28	.5253	32	.4308	36
33					.9952	11	.9636	15	.8929	19	.7930	23	.6823	27	.5744	31	.4764	35
34					1.0000	10	.9788	14	.9232	18	.8350	22	.7303	26	.6234	30	.5236	34

<i>m</i> = 5												
<i>c<sub>L</sub></i>	<i>n</i> = 5	<i>c<sub>U</sub></i>	<i>n</i> = 6	<i>c<sub>U</sub></i>	<i>n</i> = 7	<i>c<sub>U</sub></i>	<i>n</i> = 8	<i>c<sub>U</sub></i>	<i>n</i> = 9	<i>c<sub>U</sub></i>	<i>n</i> = 10	<i>c<sub>U</sub></i>
15	.0040	40	.0022	45	.0013	50	.0008	55	.0005	60	.0003	65
16	.0079	39	.0043	44	.0025	49	.0016	54	.0010	59	.0007	64
17	.0159	38	.0087	43	.0051	48	.0031	53	.0020	58	.0013	63
18	.0278	37	.0152	42	.0088	47	.0054	52	.0035	57	.0023	62
19	.0476	36	.0260	41	.0152	46	.0093	51	.0060	56	.0040	61
20	.0754	35	.0411	40	.0240	45	.0148	50	.0095	55	.0063	60
21	.1111	34	.0628	39	.0366	44	.0225	49	.0145	54	.0097	59
22	.1548	33	.0887	38	.0530	43	.0326	48	.0210	53	.0140	58
23	.2103	32	.1234	37	.0745	42	.0466	47	.0300	52	.0200	57
24	.2738	31	.1645	36	.1010	41	.0637	46	.0415	51	.0276	56
25	.3452	30	.2143	35	.1338	40	.0855	45	.0559	50	.0376	55
26	.4206	29	.2684	34	.1717	39	.1111	44	.0734	49	.0496	54
27	.5000	28	.3312	33	.2159	38	.1422	43	.0949	48	.0646	53
28	.5794	27	.3961	32	.2652	37	.1772	42	.1199	47	.0823	52
29	.6548	26	.4654	31	.3194	36	.2176	41	.1489	46	.1032	51
30	.7262	25	.5346	30	.3775	35	.2618	40	.1818	45	.1272	50
31	.7897	24	.6039	29	.4381	34	.3108	39	.2188	44	.1548	49
32	.8452	23	.6688	28	.5000	33	.3621	38	.2592	43	.1855	48
33	.8889	22	.7316	27	.5619	32	.4165	37	.3032	42	.2198	47
34	.9246	21	.7857	26	.6225	31	.4716	36	.3497	41	.2567	46
35	.9524	20	.8355	25	.6806	30	.5284	35	.3986	40	.2970	45
36	.9722	19	.8766	24	.7348	29	.5835	34	.4491	39	.3393	44
37	.9841	18	.9113	23	.7841	28	.6379	33	.5000	38	.3839	43
38	.9921	17	.9372	22	.8283	27	.6892	32	.5509	37	.4296	42
39	.9960	16	.9589	21	.8662	26	.7382	31	.6014	36	.4765	41
40	1.0000	15	.9740	20	.8990	25	.7824	30	.6503	35	.5235	40

<b><math>m = 6</math></b>										
$c_L$	$n=6$	$c_U$	$n=7$	$c_U$	$n=8$	$c_U$	$n=9$	$c_U$	$n=10$	$c_U$
21	.0011	57	.0006	63	.0003	69	.0002	75	.0001	81
22	.0022	56	.0012	62	.0007	68	.0004	74	.0002	80
23	.0043	55	.0023	61	.0013	67	.0008	73	.0005	79
24	.0076	54	.0041	60	.0023	66	.0014	72	.0009	78
25	.0130	53	.0070	59	.0040	65	.0024	71	.0015	77
26	.0206	52	.0111	58	.0063	64	.0038	70	.0024	76
27	.0325	51	.0175	57	.0100	63	.0060	69	.0037	75
28	.0465	50	.0256	56	.0147	62	.0088	68	.0055	74
29	.0660	49	.0367	55	.0213	61	.0128	67	.0080	73
30	.0898	48	.0507	54	.0296	60	.0180	66	.0112	72
31	.1201	47	.0688	53	.0406	59	.0248	65	.0156	71
32	.1548	46	.0903	52	.0539	58	.0332	64	.0210	70
33	.1970	45	.1171	51	.0709	57	.0440	63	.0280	69
34	.2424	44	.1474	50	.0906	56	.0567	62	.0363	68
35	.2944	43	.1830	49	.1142	55	.0723	61	.0467	67
36	.3496	42	.2226	48	.1412	54	.0905	60	.0589	66
37	.4091	41	.2669	47	.1725	53	.1119	59	.0736	65
38	.4686	40	.3141	46	.2068	52	.1361	58	.0903	64
39	.5314	39	.3654	45	.2454	51	.1638	57	.1099	63
40	.5909	38	.4178	44	.2864	50	.1942	56	.1317	62
41	.6504	37	.4726	43	.3310	49	.2280	55	.1566	61
42	.7056	36	.5274	42	.3773	48	.2643	54	.1838	60
43	.7576	35	.5822	41	.4259	47	.3035	53	.2139	59
44	.8030	34	.6346	40	.4749	46	.3445	52	.2461	58
45	.8452	33	.6859	39	.5251	45	.3878	51	.2811	57
46	.8799	32	.7331	38	.5741	44	.4320	50	.3177	56
47	.9102	31	.7774	37	.6227	43	.4773	49	.3564	55
48	.9340	30	.8170	36	.6690	42	.5227	48	.3962	54
49	.9535	29	.8526	35	.7136	41	.5680	47	.4374	53
50	.9675	28	.8829	34	.7546	40	.6122	46	.4789	52
51	.9794	27	.9097	33	.7932	39	.6555	45	.5211	51

<i>m=7</i>								
<i>c<sub>L</sub></i>	<i>n=7</i>	<i>c<sub>U</sub></i>	<i>n=8</i>	<i>c<sub>U</sub></i>	<i>n=9</i>	<i>c<sub>U</sub></i>	<i>n=10</i>	<i>c<sub>U</sub></i>
28	.0003	77	.0002	84	.0001	91	.0001	98
29	.0006	76	.0003	83	.0002	90	.0001	97
30	.0012	75	.0006	82	.0003	89	.0002	96
31	.0020	74	.0011	81	.0006	88	.0004	95
32	.0035	73	.0019	80	.0010	87	.0006	94
33	.0055	72	.0030	79	.0017	86	.0010	93
34	.0087	71	.0047	78	.0026	85	.0015	92
35	.0131	70	.0070	77	.0039	84	.0023	91
36	.0189	69	.0103	76	.0058	83	.0034	90
37	.0265	68	.0145	75	.0082	82	.0048	89
38	.0364	67	.0200	74	.0115	81	.0068	88
39	.0487	66	.0270	73	.0156	80	.0093	87
40	.0641	65	.0361	72	.0209	79	.0125	86
41	.0825	64	.0469	71	.0274	78	.0165	85
42	.1043	63	.0603	70	.0356	77	.0215	84
43	.1297	62	.0760	69	.0454	76	.0277	83
44	.1588	61	.0946	68	.0571	75	.0351	82
45	.1914	60	.1159	67	.0708	74	.0439	81
46	.2279	59	.1405	66	.0869	73	.0544	80
47	.2675	58	.1678	65	.1052	72	.0665	79
48	.3100	57	.1984	64	.1261	71	.0806	78
49	.3552	56	.2317	63	.1496	70	.0966	77
50	.4024	55	.2679	62	.1755	69	.1148	76
51	.4508	54	.3063	61	.2039	68	.1349	75
52	.5000	53	.3472	60	.2349	67	.1574	74
53	.5492	52	.3894	59	.2680	66	.1819	73
54	.5976	51	.4333	58	.3032	65	.2087	72
55	.6448	50	.4775	57	.3403	64	.2374	71
56	.6900	49	.5225	56	.3788	63	.2681	70
57	.7325	48	.5667	55	.4185	62	.3004	69
58	.7721	47	.6106	54	.4591	61	.3345	68
59	.8086	46	.6528	53	.5000	60	.3698	67
60	.8412	45	.6937	52	.5409	59	.4063	66
61	.8703	44	.7321	51	.5815	58	.4434	65
62	.8957	43	.7683	50	.6212	57	.4811	64
63	.9175	42	.8016	49	.6597	56	.5189	63

<i>m=8</i>						
<i>c<sub>L</sub></i>	<i>n=8</i>	<i>c<sub>U</sub></i>	<i>n=9</i>	<i>c<sub>U</sub></i>	<i>n=10</i>	<i>c<sub>U</sub></i>
36	.0001	100	.0000	108	.0000	116
37	.0002	99	.0001	107	.0000	115
38	.0003	98	.0002	106	.0001	114
39	.0005	97	.0003	105	.0002	113
40	.0009	96	.0005	104	.0003	112
41	.0015	95	.0008	103	.0004	111
42	.0023	94	.0012	102	.0007	110
43	.0035	93	.0019	101	.0010	109
44	.0052	92	.0028	100	.0015	108
45	.0074	91	.0039	99	.0022	107
46	.0103	90	.0056	98	.0031	106
47	.0141	89	.0076	97	.0043	105
48	.0190	88	.0103	96	.0058	104
49	.0249	87	.0137	95	.0078	103
50	.0325	86	.0180	94	.0103	102
51	.0415	85	.0232	93	.0133	101
52	.0524	84	.0296	92	.0171	100
53	.0652	83	.0372	91	.0217	99
54	.0803	82	.0464	90	.0273	98
55	.0974	81	.0570	89	.0338	97
56	.1172	80	.0694	88	.0416	96
57	.1393	79	.0836	87	.0506	95
58	.1641	78	.0998	86	.0610	94
59	.1911	77	.1179	85	.0729	93
60	.2209	76	.1383	84	.0864	92
61	.2527	75	.1606	83	.1015	91
62	.2869	74	.1852	82	.1185	90
63	.3227	73	.2117	81	.1371	89
64	.3605	72	.2404	80	.1577	88
65	.3992	71	.2707	79	.1800	87
66	.4392	70	.3029	78	.2041	86
67	.4796	69	.3365	77	.2299	85
68	.5204	68	.3715	76	.2574	84
69	.5608	67	.4074	75	.2863	83
70	.6008	66	.4442	74	.3167	82
71	.6395	65	.4813	73	.3482	81
72	.6773	64	.5187	72	.3809	80
73	.7131	63	.5558	71	.4143	79
74	.7473	62	.5926	70	.4484	78
75	.7791	61	.6285	69	.4827	77
76	.8089	60	.6635	68	.5173	76

<b><i>m = 9</i></b>									
$c_L$	$n=9$	$c_U$	$n=10$	$c_U$	$c_L$	$n=9$ (cont.)	$n=10$ (cont.)	$c_U$	
45	.0000	126	.0000	135	68	.0680	103	.0394	112
46	.0000	125	.0000	134	69	.0807	102	.0474	111
47	.0001	124	.0000	133	70	.0951	101	.0564	110
48	.0001	123	.0001	132	71	.1112	100	.0667	109
49	.0002	122	.0001	131	72	.1290	99	.0782	103
50	.0004	121	.0002	130	73	.1487	98	.0912	107
51	.0006	120	.0003	129	74	.1701	97	.1055	106
52	.0009	119	.0005	128	75	.1933	96	.1214	105
53	.0014	118	.0007	127	76	.2181	95	.1388	104
54	.0020	117	.0011	126	77	.2447	94	.1577	103
55	.0028	116	.0015	125	78	.2729	93	.1781	102
56	.0039	115	.0021	124	79	.3024	92	.2001	101
57	.0053	114	.0028	123	80	.3332	91	.2235	100
58	.0071	113	.0038	122	81	.3652	90	.2483	99
59	.0094	112	.0051	121	82	.3981	89	.2745	98
60	.0122	111	.0066	120	83	.4317	88	.3019	97
61	.0157	110	.0086	119	84	.4657	87	.3304	96
62	.0200	109	.0110	118	85	.5000	86	.3598	95
63	.0252	108	.0140	117	86	.5343	85	.3901	94
64	.0313	107	.0175	116	87	.5683	84	.4211	93
65	.0385	106	.0217	115	88	.6019	83	.4524	92
66	.0470	105	.0267	114	89	.6348	82	.4841	91
67	.0567	104	.0326	113	90	.6668	81	.6668	90

<b><i>m = 10</i></b>					
$c_L$	$n=10$	$c_U$	$c_L$	$n=10$ (cont.)	$c_U$
55	.0000	155	81	.0376	129
56	.0000	154	82	.0446	128
57	.0000	153	83	.0526	127
58	.0000	152	84	.0615	126
59	.0001	151	85	.0716	125
60	.0001	150	86	.0827	124
61	.0002	149	87	.0952	123
62	.0002	148	88	.1088	122
63	.0004	147	89	.1237	121
64	.0005	145	90	.1399	120
65	.0008	145	91	.1575	119
66	.0010	144	92	.1763	118
67	.0014	143	93	.1965	117
68	.0019	142	94	.2179	116
69	.0026	141	95	.2406	115
70	.0034	140	96	.2644	114
71	.0045	139	97	.2894	113
72	.0057	138	98	.3153	112
73	.0073	137	99	.3421	111
74	.0093	136	100	.3697	110
75	.0116	135	101	.3980	109
76	.0144	134	102	.4267	108
77	.0177	133	103	.4559	107
78	.0216	132	104	.4853	106
79	.0262	131	105	.5147	105
80	.0315	130			

# Appendix XVII

## Critical values of $T^+$ for the Wilcoxon signed ranks test

(From Siegel and Castellan, 1988)

The body of the table gives the one-tailed probability,  $P$ , under the null hypothesis, that  $T^+ \geq c$ , for  $N$  pairs of observations with non-zero differences.

c	N						
	3	4	5	6	7	8	9
3	.6250						
4	.3750						
5	.2500	.5625					
6	.1250	.4375					
7		.3125					
8		.1875	.5000				
9		.1250	.4063				
10		.0623	.3125				
11			.2188	.5000			
12			.1563	.4219			
13			.0938	.3438			
14			.0625	.2813	.5313		
15			.0313	.2188	.4688		
16				.1563	.4063		
17				.1094	.3438		
18				.0781	.2891	.5273	
19				.0469	.2344	.4727	
20				.0313	.1875	.4219	
21				.0156	.1484	.3711	
22					.1094	.3203	
23					.0781	.2734	.5000

c	N						
	3	4	5	6	7	8	9
24					.0547	.2305	.4551
25					.0391	.1914	.4102
26					.0234	.1563	.3672
27					.0156	.1250	.3262
28					.0078	.0977	.2852
29						.0742	.2480
30						.0547	.2129
31						.0391	.1797
32						.0273	.1504
33						.0195	.1250
34						.0117	.1016
35						.0078	.0820
36						.0039	.0645
37							.0488
38							.0371
39							.0273
40							.0195
41							.0137
42							.0098
43							.0059
44							.0039
45							.0020

c	N					
	10	11	12	13	14	15
28	.5000					
29	.4609					
30	.4229					
31	.3848					
32	.3477					
33	.3125	.5171				
34	.2783	.4829				
35	.2461	.4492				
36	.2158	.4155				
37	.1875	.3823				
38	.1611	.3501				
39	.1377	.3188	.5151			
40	.1162	.2886	.4849			
41	.0967	.2598	.4548			
42	.0801	.2324	.4250			
43	.0654	.2065	.3955			
44	.0527	.1826	.3667			
45	.0420	.1602	.3386			
46	.0322	.1392	.3110	.5000		
47	.0244	.1201	.2847	.4730		
48	.0186	.1030	.2593	.4463		
49	.0137	.0874	.2349	.4197		
50	.0098	.0737	.2119	.3934		
51	.0068	.0615	.1902	.3677		
52	.0049	.0508	.1697	.3424		
53	.0029	.0415	.1506	.3177	.5000	
54	.0020	.0337	.1331	.2939	.4758	
55	.0010	.0269	.1167	.2709	.4516	
56		.0210	.1018	.2487	.4276	
57		.0161	.0881	.2274	.4039	
58		.0122	.0757	.2072	.3804	
59		.0093	.0647	.1879	.3574	
60		.0068	.0549	.1698	.3349	.5110
61		.0049	.0461	.1527	.3129	.4890
62		.0034	.0386	.1367	.2915	.4670
63		.0024	.0320	.1219	.2708	.4452
64		.0015	.0261	.1082	.2508	.4235
65		.0010	.0212	.0955	.2316	.4020
66		.0005	.0171	.0839	.2131	.3808
67			.0134	.0732	.1955	.3599
68			.0105	.0636	.1788	.3394
69			.0081	.0549	.1629	.3193
70			.0061	.0471	.1479	.2997
71			.0046	.0402	.1338	.2807
72			.0034	.0341	.1206	.2622
73			.0024	.0287	.1083	.2444
74			.0017	.0239	.0969	.2271

c	N				
	12	13	14	15	
75	.0012	.0199	.0863	.2106	
76	.0007	.0164	.0765	.1947	
77	.0005	.0133	.0676	.1796	
78	.0002	.0107	.0594	.1651	
79		.0085	.0520	.1514	
80		.0067	.0453	.1384	
81		.0052	.0392	.1262	
82		.0040	.0338	.1147	
83		.0031	.0290	.1039	
84		.0023	.0247	.0938	
85		.0017	.0209	.0844	
86		.0012	.0176	.0757	
87		.0009	.0148	.0677	
88		.0006	.0123	.0603	
89		.0004	.0101	.0535	
90		.0002	.0083	.0473	
91		.0001	.0067	.0416	
92			.0054	.0365	
93			.0043	.0319	
94			.0034	.0277	
95			.0026	.0240	
96			.0020	.0206	
97			.0015	.0177	
98			.0012	.0151	
99			.0009	.0128	
100			.0006	.0108	
101			.0004	.0090	
102			.0003	.0075	
103			.0002	.0062	
104			.0001	.0051	
105			.0001	.0042	
106				.0034	
107				.0027	
108				.0021	
109				.0017	
110				.0013	
111				.0010	
112				.0008	
113				.0006	
114				.0004	
115				.0003	
116				.0002	
117				.0002	
118				.0001	
119				.0001	
120				.0000	

# Appendix XVIII

## Values of $K$ for calculating 95% confidence intervals for the difference between population medians for two independent samples

(From Altman *et al.*, 2000)

Sample sizes ( $n_1, n_2$ )		Level of confidence 95% (approx)	
Smaller	Larger	$K$	Exact level (%)
5	5	3	96.8
5	6	4	97.0
5	7	6	95.2
5	8	7	95.5
5	9	8	95.8
5	10	9	96.0
5	11	10	96.2
5	12	12	95.2
5	13	13	95.4
5	14	14	95.6
5	15	15	95.8
5	16	16	96.0
5	17	18	95.2
5	18	19	95.4
5	19	20	95.6
5	20	21	95.8
5	21	23	95.1
5	22	24	95.3
5	23	25	95.5
5	24	26	95.6
5	25	28	95.1
6	6	6	95.9
6	7	7	96.5
6	8	9	95.7
6	9	11	95.0
6	10	12	95.8
6	11	14	95.2
6	12	15	95.9
6	13	17	95.4
6	14	18	95.9
6	15	20	95.5
6	16	22	95.1
6	17	23	95.6
6	18	25	95.3
6	19	26	95.7
6	20	28	95.4

Sample sizes ( $n_1, n_2$ )		Level of confidence 95% (approx)	
Smaller	Larger	$K$	Exact level (%)
6	21	30	95.1
6	22	31	95.5
6	23	33	95.3
6	24	34	95.6
6	25	36	95.4
7	7	9	96.2
7	8	11	96.0
7	9	13	95.8
7	10	15	95.7
7	11	17	95.6
7	12	19	95.5
7	13	21	95.4
7	14	23	95.4
7	15	25	95.3
7	16	27	95.3
7	17	29	95.3
7	18	31	95.3
7	19	33	95.2
7	20	35	95.2
7	21	37	95.2
7	22	39	95.2
7	23	41	95.2
7	24	43	95.2
7	25	45	95.2
8	8	14	95.0
8	9	16	95.4
8	10	18	95.7
8	11	20	95.9
8	12	23	95.3
8	13	25	95.5
8	14	27	95.8
8	15	30	95.3
8	16	32	95.5
8	17	35	95.1
8	18	37	95.3

Sample sizes ( $n_1, n_2$ )		Level of confidence 95% (approx)	
Smaller	Larger	K	Exact level (%)
8	19	39	95.5
8	20	42	95.1
8	21	44	95.3
8	22	46	95.5
8	23	49	95.2
8	24	51	95.4
8	25	54	95.1
9	9	18	96.0
9	10	21	95.7
9	11	24	95.4
9	12	27	95.1
9	13	29	95.7
9	14	32	95.4
9	15	35	95.2
9	16	38	95.1
9	17	40	95.5
9	18	43	95.4
9	19	46	95.2
9	20	49	95.1
9	21	51	95.5
9	22	54	95.4
9	23	57	95.3
9	24	60	95.1
9	25	63	95.0
10	10	24	95.7
10	11	27	95.7
10	12	30	95.7
10	13	34	95.1
10	14	37	95.2
10	15	40	95.2
10	16	43	95.3
10	17	46	95.4
10	18	49	95.5
10	19	53	95.0
10	20	56	95.1
10	21	59	95.2
10	22	62	95.3
10	23	65	95.3
10	24	68	95.4
10	25	72	95.0
11	11	31	95.3
11	12	34	95.6
11	13	38	95.3
11	14	41	95.6
11	15	45	95.3
11	16	48	95.6
11	17	52	95.3
11	18	56	95.1
11	19	59	95.3
11	20	63	95.1
11	21	66	95.4
11	22	70	95.2
11	23	74	95.0
11	24	77	95.3
11	25	81	95.1

Sample sizes ( $n_1, n_2$ )		Level of confidence 95% (approx)	
Smaller	Larger	K	Exact level (%)
12	12	38	95.5
12	13	42	95.4
12	14	46	95.4
12	15	50	95.3
12	16	54	95.3
12	17	58	95.2
12	18	62	95.2
12	19	66	95.2
12	20	70	95.2
12	21	74	95.2
12	22	78	95.2
12	23	82	95.1
12	24	86	95.1
12	25	90	95.1
13	13	46	95.6
13	14	51	95.2
13	15	55	95.4
13	16	60	95.0
13	17	64	95.2
13	18	68	95.4
13	19	73	95.1
13	20	77	95.2
13	21	81	95.4
13	22	86	95.1
13	23	90	95.3
13	24	95	95.1
13	25	99	95.2
14	14	56	95.0
14	15	60	95.4
14	16	65	95.3
14	17	70	95.2
14	18	75	95.1
14	19	79	95.4
14	20	84	95.3
14	21	89	95.2
14	22	94	95.1
14	23	99	95.1
14	24	103	95.3
14	25	108	95.3
15	15	65	95.5
15	16	71	95.1
15	17	76	95.1
15	18	81	95.2
15	19	86	95.3
15	20	91	95.4
15	21	97	95.1
15	22	102	95.1
15	23	107	95.2
15	24	112	95.3
15	25	118	95.0
16	16	76	95.3
16	17	82	95.1
16	18	87	95.4
16	19	93	95.2
16	20	99	95.1



Sample sizes ( $n_1, n_2$ )		Level of confidence 95% (approx)	
Smaller	Larger	K	Exact level (%)
16	21	104	95.3
16	22	110	95.2
16	23	116	95.0
16	24	121	95.2
16	25	127	95.1
17	17	88	95.1
17	18	94	95.1
17	19	100	95.1
17	20	106	95.2
17	21	112	95.2
17	22	118	95.2
17	23	124	95.2
17	24	130	95.2
17	25	136	95.2
18	18	100	95.3
18	19	107	95.1
18	20	113	95.2
18	21	120	95.1
18	22	126	95.2
18	23	133	95.0
18	24	139	95.2
18	25	146	95.0
19	19	114	95.0
19	20	120	95.3
19	21	127	95.3
19	22	134	95.2

Sample sizes ( $n_1, n_2$ )		Level of confidence 95% (approx)	
Smaller	Larger	K	Exact level (%)
19	23	141	95.2
19	24	148	95.2
19	25	155	95.1
20	20	128	95.1
20	21	135	95.2
20	22	142	95.3
20	23	150	95.1
20	24	157	95.2
20	25	164	95.3
21	21	143	95.1
21	22	151	95.0
21	23	158	95.2
21	24	166	95.2
21	25	174	95.1
22	22	159	95.1
22	23	167	95.1
22	24	175	95.2
22	25	183	95.2
23	23	176	95.0
23	24	184	95.2
23	25	193	95.1
24	24	193	95.2
24	25	202	95.2
25	25	212	95.1

# Appendix XIX

**Values of  $K^*$  for calculating 95 % confidence intervals for the difference between population medians for two related samples**  
 (From Altman *et al.*, 2000)

Sample size (n)	Level of confidence 95% (approx.)	
	$K^*$	Exact level (%)
6	1	96.9
7	3	95.3
8	4	96.1
9	6	96.1
10	9	95.1
11	11	95.8
12	14	95.8
13	18	95.2
14	22	95.1
15	26	95.2
16	30	95.6
17	35	95.5
18	41	95.2
19	47	95.1
20	53	95.2
21	59	95.4
22	66	95.4
23	74	95.2
24	82	95.1
25	90	95.2
26	99	95.1
27	108	95.1
28	117	95.2

Sample size (n)	Level of confidence 95% (approx.)	
	$K^*$	Exact level (%)
29	127	95.2
30	138	95.0
31	148	95.2
32	160	95.0
33	171	95.2
34	183	95.2
35	196	95.1
36	209	95.0
37	222	95.1
38	236	95.1
39	250	95.1
40	265	95.0
41	280	95.0
42	295	95.1
43	311	95.1
44	328	95.0
45	344	95.1
46	362	95.0
47	379	95.1
48	397	95.1
49	416	95.1
50	435	95.1

# Appendix XX

## Common logarithms ( $\log_{10}$ ) of factorials of the integers 1–999

(From Lentner, 1982)

<i>n</i>	0	1	2	3	4	5	6	7	8	9
<b>0</b>	0.000 00	0.000 00	0.301 03	0.778 15	1.380 21	2.079 18	2.857 33	3.702 43	4.605 52	5.559 76
10	6.559 76	7.601 16	8.680 34	9.794 28	10.940 41	12.116 50	13.320 62	14.551 07	15.806 34	17.085 09
20	18.386 12	19.708 34	21.050 77	22.412 49	23.792 71	25.190 65	26.605 62	28.036 98	29.484 14	30.946 54
30	32.423 66	33.915 02	35.420 17	36.938 69	38.470 16	40.014 23	41.570 54	43.138 74	44.718 52	46.309 59
40	47.911 65	49.524 43	51.147 68	52.781 15	54.424 60	56.077 81	57.740 57	59.412 67	61.093 91	62.784 10
<b>50</b>	64.483 07	66.190 64	67.906 65	69.630 92	71.363 32	73.103 68	74.851 87	76.607 74	78.371 17	80.142 02
60	81.920 17	83.705 50	85.497 90	87.297 24	89.103 42	90.916 33	92.735 87	94.561 95	96.394 46	98.233 31
70	100.078 41	101.929 66	103.787 00	105.650 32	107.519 55	109.394 61	111.275 43	113.161 92	115.054 01	116.951 64
80	118.854 73	120.763 21	122.677 03	124.596 10	126.520 38	128.449 80	130.384 30	132.323 82	134.268 30	136.217 69
90	138.171 94	140.130 98	142.094 76	144.063 25	146.036 38	148.014 10	149.996 37	151.983 14	153.974 37	155.970 00
<b>100</b>	157.970 00	159.974 33	161.982 93	163.995 76	166.012 80	168.033 98	170.059 29	172.088 67	174.122 10	176.159 52
110	178.200 92	180.246 24	182.295 46	184.348 54	186.405 44	188.466 14	190.530 60	192.598 78	194.670 67	196.746 21
120	198.825 39	200.908 18	202.994 54	205.084 44	207.177 87	209.274 78	211.375 15	213.478 95	215.586 16	217.696 75
130	219.810 69	221.927 97	224.048 54	226.172 39	228.299 50	230.429 83	232.563 37	234.700 09	236.839 97	238.982 98
140	241.129 11	243.278 33	245.430 62	247.585 95	249.744 32	251.905 68	254.070 04	256.237 35	258.407 62	260.580 80
<b>150</b>	262.756 89	264.935 87	267.117 71	269.302 40	271.489 93	273.680 26	275.873 38	278.069 28	280.267 94	282.469 33
160	284.673 45	286.880 28	289.089 80	291.301 98	293.516 83	295.734 31	297.954 42	300.177 13	302.402 44	304.630 33
170	306.860 78	309.093 78	311.329 30	313.567 35	315.807 90	318.050 94	320.296 45	322.544 42	324.794 84	327.047 70
180	329.302 97	331.560 65	333.820 72	336.083 17	338.347 99	340.615 16	342.884 67	345.156 51	347.430 67	349.707 13
190	351.985 89	354.266 92	356.550 22	358.835 78	361.123 58	363.413 62	365.705 87	368.000 34	370.297 00	372.595 86
<b>200</b>	374.896 89	377.200 08	379.505 44	381.812 93	384.122 56	386.434 32	388.748 18	391.064 15	393.382 22	395.702 36
210	398.024 58	400.348 87	402.675 20	405.003 58	407.334 00	409.666 43	412.000 89	414.337 35	416.675 80	419.016 25
220	421.358 67	423.703 06	426.049 42	428.397 72	430.747 97	433.100 15	435.454 26	437.810 29	440.168 22	442.528 06
230	444.889 78	447.253 40	449.618 88	451.986 24	454.355 46	456.726 52	459.099 44	461.474 18	463.850 76	466.229 16
240	468.609 37	470.991 39	473.375 20	475.760 81	478.148 20	480.537 37	482.928 30	485.321 00	487.715 45	490.111 65
<b>250</b>	492.509 59	494.909 26	497.310 66	499.713 78	502.118 62	504.525 16	506.933 40	509.343 33	511.754 95	514.168 25
260	516.583 22	518.999 86	521.418 16	523.838 12	526.259 72	528.682 97	531.107 85	533.534 36	535.962 50	538.392 25
270	540.823 61	543.256 58	545.691 15	548.127 31	550.565 06	553.004 39	555.445 30	557.887 78	560.331 83	562.777 43
280	565.224 59	567.673 30	570.123 54	572.575 33	575.028 65	577.483 49	579.939 86	582.397 74	584.857 13	587.318 03
290	589.780 43	592.244 32	594.709 71	597.176 57	599.644 92	602.114 74	604.586 03	607.058 79	609.533 01	612.008 68
<b>300</b>	614.485 80	616.964 36	619.444 37	621.925 81	624.408 69	626.892 99	629.378 71	631.865 85	634.354 40	636.844 36
310	639.335 72	641.828 48	644.322 63	646.818 18	649.315 11	651.813 42	654.313 10	656.814 16	659.316 59	661.820 38
320	664.325 53	666.832 04	669.339 89	671.849 10	674.359 64	676.871 52	679.384 74	681.899 29	684.415 16	686.932 36
330	689.450 87	691.970 70	694.491 84	697.014 28	699.538 03	702.063 07	704.589 41	707.117 04	709.645 96	712.176 16
340	714.707 64	717.240 39	719.774 42	722.309 71	724.846 27	727.384 09	729.923 17	732.463 50	735.005 08	737.547 90
<b>350</b>	740.091 97	742.637 28	745.183 82	747.731 60	750.280 60	752.830 83	755.382 28	757.934 95	760.488 83	763.043 92
360	765.600 23	768.157 73	770.716 44	773.276 35	775.837 45	778.399 74	780.963 23	783.527 89	786.093 74	788.660 77
370	791.228 97	793.798 34	796.368 88	798.940 59	801.513 47	804.087 50	806.662 68	809.239 03	811.816 52	814.395 16
380	816.974 94	819.555 87	822.137 93	824.721 13	827.305 46	829.890 92	832.477 51	835.065 22	837.654 05	840.244 00
390	842.835 07	845.427 24	848.020 53	850.614 92	853.210 42	855.807 01	858.404 71	861.003 50	863.603 38	866.204 36

<i>n</i>	0	1	2	3	4	5	6	7	8	9
400	868.806 42	871.409 56	874.013 79	876.619 09	879.225 47	881.832 93	884.441 46	887.051 05	889.661 71	892.273 43
410	894.886 22	897.500 06	900.114 96	902.730 91	905.347 91	907.965 95	910.585 05	913.205 18	915.826 36	918.448 57
420	921.071 82	923.696 11	926.321 42	928.947 76	931.575 12	934.203 51	936.832 92	939.463 35	942.094 80	944.727 25
430	947.360 72	949.995 20	952.630 68	955.267 17	957.904 66	960.543 15	963.182 63	965.823 12	968.464 59	971.107 05
440	973.750 51	976.394 95	979.040 37	981.686 77	984.334 15	986.982 51	989.631 85	992.282 16	994.933 44	997.585 68
450	1000.238 89	1002.893 07	1005.548 21	1008.204 31	1010.861 36	1013.519 37	1016.178 34	1018.838 25	1021.499 12	1024.160 93
460	1026.823 69	1029.487 39	1032.152 03	1034.817 61	1037.484 13	1040.151 58	1042.819 97	1045.489 29	1048.159 53	1050.830 71
470	1053.502 80	1056.175 82	1058.849 77	1061.524 63	1064.200 41	1066.877 10	1069.554 71	1072.233 22	1074.912 65	1077.592 99
480	1080.274 23	1082.956 37	1085.639 42	1088.323 37	1091.008 21	1093.693 95	1096.380 59	1099.068 12	1101.756 54	1104.445 85
490	1107.136 04	1109.827 12	1112.519 09	1115.211 94	1117.905 66	1120.600 27	1123.295 75	1125.992 11	1128.689 34	1131.387 44
500	1134.086 41	1136.786 24	1139.486 95	1142.188 51	1144.890 94	1147.594 24	1150.298 39	1153.003 39	1155.709 26	1158.415 98
510	1161.123 55	1163.831 97	1166.541 24	1169.251 35	1171.962 32	1174.674 12	1177.386 77	1180.100 26	1182.814 59	1185.529 76
520	1188.245 76	1190.962 60	1193.680 27	1196.398 77	1199.118 10	1201.838 26	1204.559 25	1207.281 06	1210.003 69	1212.727 15
530	1215.451 42	1218.176 52	1220.902 43	1223.629 16	1226.356 70	1229.085 05	1231.814 22	1234.544 19	1237.274 97	1240.006 56
540	1242.738 96	1245.472 15	1248.206 15	1250.940 95	1253.676 55	1256.412 95	1259.150 14	1261.888 13	1264.626 91	1267.366 48
550	1270.106 84	1272.847 99	1275.589 93	1278.332 66	1281.076 17	1283.820 46	1286.565 54	1289.311 39	1292.058 03	1294.805 44
560	1297.553 63	1300.302 59	1303.052 32	1305.802 83	1308.554 11	1311.306 16	1314.058 98	1316.812 56	1319.566 91	1322.322 02
570	1325.077 90	1327.834 53	1330.591 93	1333.350 08	1336.108 99	1338.868 66	1341.629 08	1344.390 26	1347.152 19	1349.914 87
580	1352.678 29	1355.442 47	1358.207 39	1360.973 06	1363.739 48	1366.506 63	1369.274 53	1372.043 17	1374.812 54	1377.582 66
590	1380.353 51	1383.125 10	1385.897 42	1388.670 48	1391.444 26	1394.218 78	1396.994 03	1399.770 00	1402.546 70	1405.324 13
600	1408.102 28	1410.881 15	1413.660 75	1416.441 07	1419.222 10	1421.003 86	1424.786 33	1427.569 52	1430.353 43	1433.138 04
610	1435.923 37	1438.709 41	1441.496 17	1444.283 63	1447.071 79	1449.860 67	1452.650 25	1455.440 54	1458.231 52	1461.023 22
620	1463.815 61	1466.608 70	1469.402 49	1472.196 98	1474.992 16	1477.788 04	1480.584 62	1483.381 88	1486.179 84	1488.978 49
630	1491.777 84	1494.577 87	1497.378 58	1500.179 99	1502.982 08	1505.784 85	1508.588 31	1511.392 45	1514.197 27	1517.002 77
640	1519.808 95	1522.615 81	1525.423 34	1528.231 55	1531.040 44	1533.850 00	1536.660 23	1539.471 14	1542.282 71	1545.094 96
650	1547.907 87	1550.721 45	1553.535 70	1556.350 61	1559.166 19	1561.982 43	1564.799 33	1567.616 90	1570.435 13	1573.254 01
660	1576.073 56	1578.893 76	1581.714 61	1584.536 13	1587.358 30	1590.181 12	1593.004 59	1595.828 72	1598.653 50	1601.478 92
670	1604.305 00	1607.131 72	1609.959 09	1612.787 10	1615.615 76	1618.445 07	1621.275 01	1624.105 60	626.936 83	1629.768 70
680	1632.601 21	1635.434 36	1638.268 14	1641.102 56	1643.937 62	1646.773 31	1649.609 64	1652.446 59	1655.284 18	1658.122 40
690	1660.961 25	1663.800 73	1666.640 83	1669.481 57	1672.322 93	1675.164 91	1678.007 52	1680.850 75	1683.694 61	1686.539 09
700	1689.384 18	1692.229 90	1695.076 24	1697.923 20	1700.770 27	1703.618 96	1706.467 76	1709.317 18	1712.167 21	1715.017 86
710	1717.869 12	1720.720 99	1723.573 47	1726.426 56	1729.280 26	1732.134 56	1734.989 48	1737.845 00	1740.701 12	1743.557 85
720	1746.415 18	1749.273 12	1752.131 65	1754.990 79	1757.850 53	1760.710 87	1763.571 81	1766.433 34	1769.295 47	1772.158 20
730	1775.021 52	1777.885 44	1780.749 95	1783.615 05	1786.480 75	1789.347 04	1792.213 91	1795.081 38	1797.949 44	1800.818 08
740	1803.687 31	1806.557 13	1809.427 54	1812.298 53	1815.170 10	1818.042 25	1820.914 99	1823.788 31	1826.662 22	1829.536 70
750	1832.411 76	1835.287 40	1838.163 62	1841.040 41	1843.917 78	1846.795 73	1849.674 25	1852.553 35	1855.433 02	1858.313 26
760	1861.194 07	1864.075 46	1866.957 41	1869.839 94	1872.723 03	1875.606 69	1878.490 92	1881.375 71	1884.261 08	1887.147 00
770	1890.033 49	1892.920 55	1895.808 16	1898.696 34	1901.585 08	1904.474 39	1907.364 25	1910.254 67	1913.145 65	1916.037 18
780	1918.929 28	1921.821 93	1924.715 14	1927.608 90	1930.503 21	1933.398 08	1936.293 51	1939.189 48	1942.086 01	1944.983 08
790	1947.880 71	1950.778 89	1953.677 61	1956.576 89	1959.476 71	1962.377 07	1965.277 99	1968.179 44	1971.081 45	1973.983 99
800	1976.887 08	1979.790 72	1982.694 89	1985.599 61	1988.504 86	1991.410 66	1994.316 99	1997.223 87	2000.131 28	2003.039 22
810	2005.947 71	2008.856 73	2011.766 29	2014.676 38	2017.587 00	2020.498 16	2023.409 85	2026.322 07	2029.234 82	2032.148 11
820	2035.061 92	2037.976 26	2040.891 14	2043.806 54	2046.722 46	2049.638 92	2052.555 90	2055.473 40	2058.391 43	2061.309 99
830	2064.229 06	2067.148 67	2070.068 79	2072.989 43	2075.910 60	2078.832 29	2081.754 49	2084.677 22	2087.600 46	2090.524 22
840	2093.448 50	2096.373 30	2099.298 61	2102.224 44	2105.150 78	2108.077 64	2111.005 01	2113.932 89	2116.861 29	2119.790 19
850	2122.719 61	2125.649 54	2128.579 98	2131.510 93	2134.442 39	2137.374 35	2140.306 83	2143.239 81	2146.173 30	2149.107 29
860	2152.041 79	2154.976 79	2157.912 30	2160.848 31	2163.784 82	2166.721 84	2169.659 36	2172.597 37	2175.535 89	2178.474 91
870	2181.414 43	2184.354 45	2187.294 97	2190.235 98	2193.177 49	2196.119 50	2199.062 00	2202.005 00	2204.948 50	2207.892 49
880	2210.836 97	2213.781 95	2216.727 41	2219.673 38	2222.619 83	2225.566 77	2228.514 20	2231.462 13	2234.410 54	2237.359 44
890	2240.308 83	2243.258 71	2246.209 08	2249.159 93	2252.111 26	2255.063 09	2258.015 40	2260.968 19	2263.921 46	2266.875 22
900	2269.829 47	2272.784 19	2275.739 40	2278.695 09	2281.651 25	2284.607 90	2287.565 03	2290.522 64	2293.480 72	2296.439 29
910	2299.398 33	2302.357 85	2305.317 84	2308.278 31	2311.239 26	2314.200 68	2317.162 58	2320.124 95	2323.087 79	2326.051 11
920	2329.014 89	2331.979 15	2334.943 88	2337.909 09	2340.874 76	2343.840 90	2346.807 51	2349.774 59	2352.742 14	2355.710 15
930	2358.678 64	2361.647 59	2364.617 00	2367.586 88	2370.557 23	2373.528 04	2376.499 32	2379.471 06	2382.443 26	2385.415 93
940	2388.389 06	2391.362 65	2394.336 70	2397.311 21	2400.286 18	2403.261 61	2406.237 50	2409.213 85	2412.190 66	2415.167 93
950	2418.145 65	2421.123 83	2424.102 47	2427.081 56	2430.061 11	2433.041 12	2436.021 57	2439.002 49	2441.983 85	2444.965 67
960	2447.947 94	2450.930 66	2453.913 84	2456.897 47	2459.881 54	2462.866 07	2465.851 05	2468.836 47	2471.822 35	2474.808 67
970	2477.795 45	2480.782 66	2483.770 33	2486.758 44	2489.747 00	2492.736 01	2495.725 46	2498.715 35	2501.705 69	2504.696 47
980	2507.687 70	2510.679 37	2513.671 48	2516.664 03	2519.657 03	2522.650 47	2525.644 34	2528.638 66	2531.633 42	2534.628 61
990	2537.624 25	2540.620 32	2543.616 83	2546.613 78	2549.611 17	2552.608 99	2555.607 25	2558.605 95	2561.605 08	2564.604 64

# Appendix XXI

## The correlation coefficient

Degrees of freedom	Value of P				
	0.10	0.05	0.02	0.01	0.001
1	0.987 7	0.996 92	0.999 51	0.999 88	0.999 998 8
2	0.900 0	0.950 0	0.980 0	0.990 0	0.999 0
3	0.805	0.878	0.934 3	0.958 7	0.991 1
4	0.729	0.811	0.882	0.917 2	0.974 1
5	0.669	0.754	0.833	0.875	0.950 9
6	0.621	0.707	0.789	0.834	0.924 9
7	0.582	0.666	0.750	0.798	0.898
8	0.549	0.632	0.715	0.765	0.872
9	0.521	0.602	0.685	0.735	0.847
10	0.497	0.576	0.658	0.708	0.823
11	0.476	0.553	0.634	0.684	0.801
12	0.457	0.532	0.612	0.661	0.780
13	0.441	0.514	0.592	0.641	0.760
14	0.426	0.497	0.574	0.623	0.742
15	0.412	0.482	0.558	0.606	0.725
16	0.400	0.468	0.543	0.590	0.708
17	0.389	0.456	0.529	0.575	0.693
18	0.378	0.444	0.516	0.561	0.679
19	0.369	0.433	0.503	0.549	0.665
20	0.360	0.423	0.492	0.537	0.652
25	0.323	0.381	0.445	0.487	0.597
30	0.296	0.349	0.409	0.449	0.554
35	0.275	0.325	0.381	0.418	0.519
40	0.257	0.304	0.358	0.393	0.490
45	0.243	0.288	0.338	0.372	0.465
50	0.231	0.273	0.322	0.354	0.443
60	0.211	0.250	0.295	0.325	0.408
70	0.195	0.232	0.274	0.302	0.380
80	0.183	0.217	0.257	0.283	0.357
90	0.173	0.205	0.242	0.267	0.338
100	0.164	0.195	0.230	0.254	0.321

The table gives percentage points for the distribution of the estimated correlation coefficient  $r$  when the true value  $\rho$  is zero. Thus when there are 10 degrees of freedom (i.e. in samples of 12) the probability of observing an  $r$  greater in **absolute value** than 0.576 (i.e.  $< -0.576$  or  $> +0.576$ ) is 0.05 or 5 per cent.

# Appendix XXII

## Some veterinary observational studies

Species	Disease*	Hypothesized risk factors	Source
Ox, horse, pig, dog, cat	Congenital defects	Species, institution, for dogs and horses: breed	Priester <i>et al.</i> (1970)
Ox, horse, pig, dog, cat	Congenital umbilical and inguinal hernias	Breed, sex	Hayes (1974a)
Ox, horse, dog, cat	Congenital ocular defects	Breed, sex	Priester (1972a)
Ox, horse, dog, cat	Nervous tissue tumours	Breed, sex, age	Hayes <i>et al.</i> (1975)
Ox, horse, dog, cat	Oral and pharyngeal cancer	For dogs: sex, age, size of urban area	Dorn and Priester (1976)
Ox, horse, dog, cat	Pancreatic carcinoma	For dogs: breed, sex, age	Priester (1974b)
Ox, horse, dog, cat	Skin tumours	Breed, sex, age, annual sunlight	Priester (1973)
Ox, horse, dog, cat	Various tumours	Breed, sex, age	Priester and Mantel (1971); Priester and McKay (1980)
Horse, dog, cat	Tumours of the nasal passages and paranasal sinuses	Age, for dogs: breed	Madewell <i>et al.</i> (1976)
Dog, cat	<i>Campylobacter</i> spp., infection	Breed, age, season, management	Sandberg <i>et al.</i> (2002)
Dog, cat	Dermatophytosis	Breed, sex, age	Sparkes <i>et al.</i> (1993)
Dog, cat	Follicular tumours	Breed, sex, age	Abramo <i>et al.</i> (1999)
Dog, cat	Leukaemia-lymphoma	Breed, sex, age	Bäckgren (1965); Dorn <i>et al.</i> (1967); Priester (1967); Schneider (1983)
Dog, cat	Non-accidental injury	Breed	Munro and Thrusfield (2001b)
Dog, cat	Pleural and peritoneal effusions	Sex, age, other diseases	Steyn and Wittum (1993)
Dog, cat	Surrender to an animal home (shelter)	Breed, sex, age, behaviour, history, owners' attitudes and socio-economic status	Patronek <i>et al.</i> (1996a,b)
Dog, cat	Various tumours	Breed, sex, age	Dorn <i>et al.</i> (1968)
Badger	Mortality	Sex, age, infection with <i>Mycobacterium bovis</i> , ELISA test status to <i>M. bovis</i>	Wilesmith and Clifton-Hadley (1991)
Camel	Somatic cell counts	Udder infections	Abdurahman <i>et al.</i> (1995)

Species	Disease*	Hypothesized risk factors	Source
Cat	Blood pressure	Age, concurrent disease	Bodey and Sansom (1998)
Cat	<i>Bordetella bronchiseptica</i>	Sex, age, management history	Binns <i>et al.</i> (1999)
Cat	Borna disease	Sex, age, lifestyle	Berg <i>et al.</i> (1998)
Cat	<i>Candidatus (Haemobartonella)</i> spp.	Sex, age	Tasker <i>et al.</i> (2003)
Cat	<i>Cryptosporidium</i> spp. infection	Age, lifestyle (domestic versus feral)	Mtambo <i>et al.</i> (1991)
Cat	Cutaneous and oral squamous cell carcinoma	Sex, skin, colour, exposure to sunlight	Dorn <i>et al.</i> (1971)
Cat	Diabetes mellitus	Breed, sex, age, body weight	Pancieria <i>et al.</i> (1990)
Cat	Diarrhoea	Verocytotoxigenic <i>Escherichia coli</i>	Smith <i>et al.</i> (1998c)
Cat	Dystokia	Breed, cranial conformation	Ekstrand and Linde-Forsberg (1994); Gunn-Moore and Thrusfield (1995)
Cat	Dysautonomia	<i>Clostridium botulinum</i> infection	Nunn <i>et al.</i> (2004)
Cat	Feline immunodeficiency virus (serological)	Breed, sex, age, clinical signs	Sukura <i>et al.</i> (1992)
Cat	Feline infectious anaemia	Breed, sex, age, prior disease	Hayes and Priester (1973)
Cat	Feline leukaemia	Feline infectious anaemia	Priester and Hayes (1973)
Cat	Feline leukaemia and feline immunodeficiency virus-induced disease	Breed, sex, age	Hosie <i>et al.</i> (1989)
Cat	Fibrosarcoma	Feline leukaemia virus vaccination, rabies vaccination Age, vaccination site, vaccine type	Kass <i>et al.</i> (1993) Hendrick <i>et al.</i> (1994)
Cat	Hyperthyroidism	Breed, sex, age, other demographic characteristics, exposure to herbicides, pesticides and other potential trace agents, diet, medical history	Scarlett <i>et al.</i> (1988); Edinboro <i>et al.</i> (2004)
Cat	Key-Gaskell syndrome See Dysautonomia		
Cat	Lower urinary tract disease	Breed, sex, age	Lekcharoensuk <i>et al.</i> (2001)
Cat	Mortality (in kittens)	Breed, sex, age, source, specific conditions	Cave <i>et al.</i> (2002)
Cat	Obesity	Breed, sex, age, diet environment	Robertson (1999); Allan <i>et al.</i> (2000)
Cat	Renal failure	Diet, management	Hughes <i>et al.</i> (2002)
Cat	Road traffic accidents	Breed, sex, age, management	Rochlitz (2003a,b)
Cat	Urolithiasis	Breed, sex, age, neutering, season of year, diet, weight, level of activity, time of diagnosis	Willeberg (1975a,b,c, 1976, 1977, 1981); Willeberg and Priester (1976); Thumchai <i>et al.</i> (1996)
Cat	Various conditions	Neutering (early)	Spain <i>et al.</i> (2004a)
Dog	Aggression	Environment Breed, location, owner characteristics	Appleby <i>et al.</i> (2002) Bradshaw <i>et al.</i> (1996); Rugbjerg <i>et al.</i> (2003)
	(in cocker spaniels)	Personality of owner	Podberscek and Serpell (1997)
Dog	Bartonellosis (serological)	Location (rural versus urban), lifestyle (indoors versus outdoors), exposure to horses, cattle and ectoparasites	Pappalardo <i>et al.</i> (1997)
Dog	Behavioural characteristics	Breed, sex, age	Bradshaw <i>et al.</i> (1996); Lund <i>et al.</i> (1996)

Species	Disease*	Hypothesized risk factors	Source
Dog	Bladder cancer	Breed, sex, location (areas of industrial activity), passive smoking, environmental chemicals, insecticides, herbicides, obesity	Hayes (1976); Hayes <i>et al.</i> (1981); Glickman <i>et al.</i> (1989, 2004); Raghavan <i>et al.</i> (2004)
Dog	Bone sarcoma	Body size	Tjalma (1966)
Dog	Bronchiectasis	Breed, age	Hawkins <i>et al.</i> (2003)
Dog	Carcinoma of the nasal cavity and paranasal sinuses	Breed, sex, age, skull type	Hayes <i>et al.</i> (1982)
Dog	Cauda equine syndrome	Degenerative disc disease, lumbosacral transitional vertebrae	Morgan <i>et al.</i> (1993)
Dog	Chemodectomas	Breed, sex, age	Hayes and Fraumeni (1974); Hayes (1975)
Dog	Chronic liver disease	Breed, sex, age	Andersson and Sevelius (1991)
Dog	Chronic pulmonary disease	Breed, sex, age, environmental pollution	Reif and Cohen (1979)
Dog	Chronic superficial keratitis	Breed, sex, age, location (altitude)	Chavkin <i>et al.</i> (1994)
Dog	Congenital heart disease	Breed, sex, other congenital defects	Mulvihill and Priester (1973); Tidholm (1997)
Dog	Congenital portosystemic shunts	Breed, age	Tobias and Rohrbach (2003)
Dog	Cranial cruciate ligament rupture	Age, sex, breed, body weight	Whitehair <i>et al.</i> (1993); Duval <i>et al.</i> (1999)
Dog	Cryptorchidism	Breed	Pendergrass and Hayes (1975); Yates <i>et al.</i> (2003)
Dog	Deafness	Sex, parental deafness	Wood and Lakhani (1997); Famula <i>et al.</i> (2001)
	(in Dalmatians)	Sex	Wood and Lakhani (1998)
Dog	Diabetes mellitus	Breed, sex, age, obesity	Krook <i>et al.</i> (1960); Marmor <i>et al.</i> (1982); Gupstill <i>et al.</i> (2003)
Dog	Dysautonomia	Breed, sex, age, season, environment, management	Berghaus <i>et al.</i> (2001)
Dog	Dystokia	Litter size	Walett Darvelid and Linde-Forsberg (1994)
Dog	Ectopic ureter	Breed	Hayes (1974b, 1984); Holt <i>et al.</i> (2000)
Dog	Elbow arthrosis	History of the disease in parents	Grondalen and Lingaas (1991)
Dog	Elbow disease (mainly dysplasia)	Breed, sex	Hayes <i>et al.</i> (1979)
Dog	Epilepsy (in Labrador retrievers)	Sex, age	Jaggy <i>et al.</i> (1998)
Dog	Euthanasia (behaviour related)	Aggressive characteristics, body weight, source	Reisner <i>et al.</i> (1994)
Dog	Eyelid neoplasms	Breed	Krehbiel and Langham (1975)
Dog	Gastric dilation and dilatation-volvulus	Breed, sex, age, body weight	Glickman <i>et al.</i> (1994)
		Age, food-particle size <i>Pneumonyssoides caninum</i> infection	Theyse <i>et al.</i> (1998) Bredal (1998)
Dog	Gastro-intestinal ulceration (related to ibuprofen toxicity)	Breed, dosage schedules	Poortinga and Hungerford (1998)
Dog	Glaucoma	Ocular characteristics	Wood <i>et al.</i> (2001a)
Dog	Haemangioma and haemangiosarcoma	Breed	Srebernik and Appleby (1991)
Dog	Heart valve incompetence	Breed, sex, age	Thrusfield <i>et al.</i> (1985); Häggström <i>et al.</i> (1992)



Species	Disease*	Hypothesized risk factors	Source
Dog	Heartworm infection	Breed, grouping (e.g., working, sporting, toy), sex, age	Selby <i>et al.</i> (1980); Yoon <i>et al.</i> (2002)
Dog	Hepatic angiosarcomas	Breed, sex, age	Priester (1976b)
Dog	Hip dysplasia	Breed, sex, age  Sex, lineage Month of birth	Priester and Mulvihill (1972); Keller and Corley (1989); Wood and Lakhani (2003b) Wood <i>et al.</i> (2002) Hanssen (1991); Wood and Lakhani (2003a)
Dog	House-dust mites and mite allergens	House and furnishing characteristics, flea prevention	Randall <i>et al.</i> (2003)
Dog	Hypospadias	Breed, sex	Hayes and Wilson (1986)
Dog	Hypothyroidism	Breed, sex, age, pedigree	Dixon <i>et al.</i> (1999)
Dog	Immune-mediated haemolytic anaemia	Breed, sex, blood type, bacteraemia	Miller <i>et al.</i> (2004)
Dog	Infectious tracheobronchitis (kennel cough)	Vaccinal status against <i>Bordetella bronchiseptica</i> , canine parainfluenza virus and canine adenoviruses	Thrusfield <i>et al.</i> (1989a)
Dog	Intervertebral disc disease	Breed, sex, age, site of involvement	Goggin <i>et al.</i> (1970); Priester (1976a)
Dog	Leptospirosis	Breed, sex, age, management	Ward <i>et al.</i> (2002a)
Dog	Lung cancer	Passive smoking	Reif <i>et al.</i> (1992)
Dog	Lymphoma	Magnetic fields	Reif <i>et al.</i> (1995)
Dog	Malignant neoplasms	Benign neoplasms	Bender <i>et al.</i> (1982)
Dog	<i>Malassezia pachydermatis</i> populations	Breed, age, concurrent disease	Bond <i>et al.</i> (1996)
Dog	Mammary neoplasia	Breed, sex, age  Inbreeding Oestrus irregularity, pseudopregnancy, gestation history Body conformation, weight, diet	Frye <i>et al.</i> (1967); Moulton <i>et al.</i> (1970) Dorn and Schneider (1976) Brodey <i>et al.</i> (1966) Sonnenschein <i>et al.</i> (1987, 1991)
Dog	Mastocytoma	Ancestry (breed grouping)	Peters (1969)
Dog	Mesothelioma	Domestic and owner's exposure to asbestos, urban residence, management, flea repellents	Glickman <i>et al.</i> (1983)
Dog	Multiple primary neoplasia (benign and malignant) involving the reproductive system	Sex, index tumours, for malignant neoplasms: benign neoplasms	Bender <i>et al.</i> (1984)
Dog, cat	Obesity	Breed, sex, age	Krook <i>et al.</i> (1960); Edney and Smith (1986)
Dog	Oesophageal sarcoma	Infection with <i>Spirocerca lupi</i>	Ribelin and Bailey (1958)
Dog	Oral and pharyngeal neoplasms	Breed, sex, age	Cohen <i>et al.</i> (1964)
Dog	Osteochondritis dissecans	Breed, sex, age	Slater <i>et al.</i> (1991)
Dog	Parvovirus enteritis	Breed, sex, neutering	Houston <i>et al.</i> (1996)
Dog	Pancreatic islet cell tumours	Breed, sex, age	Priester (1974c)
Dog	Pancreatitis (acute)	Breed, sex, age	Cook <i>et al.</i> (1993a); Hess <i>et al.</i> (1999)
Dog	Patellar dislocation	Breed, sex, size	Priester (1972b)
Dog	Patellar subluxation	Breed, sex, age, other orthopaedic conditions	Hayes <i>et al.</i> (1994)
Dog	Patent ductus arteriosus	Breed, sex	Eyster <i>et al.</i> (1976)

Species	Disease*	Hypothesized risk factors	Source
Dog	Perianal adenocarcinoma	Breed, neutering, age, weight	Vail <i>et al.</i> (1990)
Dog	Periodontal disease (in poodles)	Age	Hoffman and Gaengler (1996)
Dog	Piroplasmosis	Breed, sex, age, ticks, management	Guitián <i>et al.</i> (2003)
Dog	Progressive retinal atrophy	Breed, sex, age	Priester (1974a)
Dog	Prostatic hyperplasia (benign)	Age	Berry <i>et al.</i> (1986)
Dog	Pyometra	Breed	De Troyer and De Schepper (1989)
		Breed, age, obesity	Krook <i>et al.</i> (1960)
		Oestrus irregularity, pseudopregnancy, gestation history	Fidler <i>et al.</i> (1966)
		Breed, age, parity, hormonal therapy	Niskanen and Thrusfield (1998)
Dog	Renal tumours	Breed, sex, age	Hayes and Fraumeni (1977)
Dog	Respiratory tract neoplasms	Environment (urban versus rural)	Reif and Cohen (1971)
Dog	Salivary cyst	Breed, sex, age	Knecht and Phares (1971)
Dog	Separation-related behaviour	Sex, household profile	Flannigan and Dodman (2001)
		Breed, sex, environment, source	Bradshaw <i>et al.</i> (2002)
Dog	Several diseases	Vaccination	Edwards <i>et al.</i> (2004)
Dog	Splenic haemangiosarcoma and haematoma	Breed, sex, age	Prymak <i>et al.</i> (1988)
Dog	Status epilepticus	Breed, sex, age, weight, history	Saito <i>et al.</i> (2001)
Dog	Tail injuries	Undocked tails	Darke <i>et al.</i> (1985)
Dog	Testicular neoplasia	Breed, sex, age, cryptorchidism	Reif and Brodey (1969); Hayes and Pendergrass (1976); Reif <i>et al.</i> (1979); Weaver (1983); Hayes <i>et al.</i> (1985); Thrusfield <i>et al.</i> (1989b)
Dog	Thyroid neoplasms	Breed, sex, age	Hayes and Fraumeni (1975)
Dog	Transmissible venereal tumour	Breed, sex, age, management, other integumentary and genital diseases	Batamuzi <i>et al.</i> (1992)
Dog	Urethral cancer	Breed, sex, age	Wilson <i>et al.</i> (1979)
Dog	Urinary incontinence (female)	Breed, size, neutering, docking	Thrusfield (1985c); Holt and Thrusfield (1993); Thrusfield <i>et al.</i> (1998)
Dog	Urinary tract infection (female)	Reproductive history, concurrent disease, drug administration, veterinary procedures	Freshman <i>et al.</i> (1989)
		Transmissible venereal disease	Batamuzi and Kristensen (1996)
Dog	Urolithiasis	Breed, sex, age	Brown <i>et al.</i> (1977); Bovee and McGuire (1984); Case <i>et al.</i> (1993); Bartges <i>et al.</i> (1994)
		Diet	Lekcharoensuk <i>et al.</i> (2002a,b)
Dog	Various conditions	Neutering (early)	Spain <i>et al.</i> (2004b)
Dog	Various diseases and mortality	Source	Scarlett <i>et al.</i> (1994)
Dog	Various tumours	Breed, sex, age	Howard and Nielsen (1965); Rahko (1968); Cohen <i>et al.</i> (1974); Kelsey <i>et al.</i> (1998); Richards <i>et al.</i> (2001)
		Exposure to uranium mill tailings	Reif <i>et al.</i> (1983)
Dog	Vena cava syndrome ( <i>Dirofilaria</i> -associated)	Sex, age, body size	Ganchi <i>et al.</i> (1992)
Dog	Viper poisoning	Breed, sex, age, location, time	Aroch and Harrus (1999)
Felids (captive wild)	Mammary cancer	Progestin contraception	Harrenstien <i>et al.</i> (1996)
Ferret	<i>Mycobacterium bovis</i> infection	Opossum abundance	Caley <i>et al.</i> (2001)

Species	Disease*	Hypothesized risk factors	Source
Hare	Various diseases	Climate	Rattenborg and Agger (1991)
Horse	Abortion	Environment Management	Dwyer <i>et al.</i> (2003) Cohen <i>et al.</i> (2003a,b)
Horse	Atrioventricular valvular regurgitation	Age, training	Young and Wood (2000)
Horse	Azoturia ('Monday morning disease', exertional rhabdomyolysis; chronic intermittent rhabdomyolysis)	Sex, age, management	MacLeay <i>et al.</i> (1999)
Horse	Basal sesamoidean fractures	Breed	Parente <i>et al.</i> (1993)
Horse	Behavioural disorders	Breed, management Stabling	Bachmann <i>et al.</i> (2003) McGreevy <i>et al.</i> (1995)
Horse	Behaviours	Breed, sex, management, maternal profile	Waters <i>et al.</i> (2002)
Horse	Bone spavin	Sex, age, origin, conformation and gait	Eksell <i>et al.</i> (1998)
Horse	<i>Borellia</i> and <i>Ehrlichia</i> spp. (serological)	Breed, age, sex, exposure to ticks, management	Egenvall <i>et al.</i> (2001)
Horse	Chronic endometrial disease	Age, parity	Ricketts and Alonso (1991)
Horse	<i>Clostridium</i> spp.	Age, date of birth, history	Fosgate <i>et al.</i> (2002)
Horse	Colic	Breed, sex, age, weight, history, management, diet, season	Sembrat (1975); Pascoe <i>et al.</i> (1983); White and Lessard (1986); Morris <i>et al.</i> (1989); Reeves <i>et al.</i> (1989, 1996b); Cohen <i>et al.</i> (1995a,b); Cohen and Peloso (1996); Kaneene <i>et al.</i> (1997); Tinker <i>et al.</i> (1997); Hillyer <i>et al.</i> (2001, 2002)
		Breed, sex, age, intestinal parasitism	Leblond <i>et al.</i> (2002)
		Breed, sex, factors associated with orthopaedic surgery	Senior <i>et al.</i> (2004)
Horse	<i>Corynebacterium pseudotuberculosis</i>	Breed, age, season, management	Doherr <i>et al.</i> (1998)
Horse	Coughing	Age, history, endoscopic findings	Christley <i>et al.</i> (1999, 2001)
Horse	Cryptorchidism	Breed	Hayes (1986)
Horse	Epiglottitis	Breed	Hawkins and Tulleners (1994)
Horse	Ehrlichiosis (Potomac fever)	Breed, age, management Age, sex, location, management, transportation Premises, husbandry management, previous history of the syndrome on premises	Atwill <i>et al.</i> (1996) Kiper <i>et al.</i> (1992) Perry <i>et al.</i> (1984b, 1986)
Horse	Endoparasitism	Age, type of enterprise, management	Larsen <i>et al.</i> (2002)
Horse	Enterolithiasis	Diet, environment	Hassel <i>et al.</i> (2004)
Horse	Entrapment of the small intestine	Crib-biting	Archer <i>et al.</i> (2004)
Horse	Fatal musculoskeletal injuries	Horseshoe characteristics Exercise schedule Race characteristics	Kane <i>et al.</i> (1996); Parkin <i>et al.</i> (2003) Estberg <i>et al.</i> (1995) Parkin <i>et al.</i> (2004)
Horse	Fever (associated with influenza)	Age, vaccinal history, track	Bendixen <i>et al.</i> (1993)
Horse	Foal rejection	Mare's behaviour, sire history	Juarbe-Díaz <i>et al.</i> (1998)
Horse	Gestation length	Year, sex of fetus, sire, month of conception	Martenuik <i>et al.</i> (1998)
Horse	Grass sickness	Sex, age, management, use, diet, worming, parental deafness	Gilmour and Jolly (1974); Wood <i>et al.</i> (1994, 1998)

Species	Disease*	Hypothesized risk factors	Source
		<i>Clostridium botulinum</i> (serological) Characteristic of premises	McCarthy <i>et al.</i> (2004a,b) Newton <i>et al.</i> (2004)
Horse	Hepatic disease	Breed, sex, age	Smith <i>et al.</i> (2003)
Horse	Impaired reproductive performance	Age, management	Meyers <i>et al.</i> (1991)
Horse	Influenza	Breed, sex, age, vaccinal status, antibody titre, type of barn, Vaccinal status	Nyaga (1975); Townsend <i>et al.</i> (1991); Morley <i>et al.</i> (2000) Estola and Neuvonen (1976)
Horse	Lameness	Breed, sex, age, management, use  Age, source, management Breed, sex, factors associated with orthopaedic surgery	Gaustad <i>et al.</i> (1995); Ross and Kaneene (1996); Ross <i>et al.</i> (1998); Vigre <i>et al.</i> (2002) Axelsson <i>et al.</i> (2001) Landman <i>et al.</i> (2004)
Horse	Laminitis	Breed, age, sex Age, sex, seasonality Breed, sex, castration  In cases of duodenitis/proximal jejunitis: weight, haemorrhagic gastric reflux, heparin administration	Slater <i>et al.</i> (1995) Polzer and Slater (1996) Dorn <i>et al.</i> (1975); Alford <i>et al.</i> (2001) Cohen <i>et al.</i> (1994)
Horse	Laryngeal hemiplegia	Breed, sex, age	Beard and Hayes (1993)
Horse	Leptospirosis (serological)	Age, sex, other diseases Age, management, water source, exposure to wildlife and rodents	Park <i>et al.</i> (1992) Barwick <i>et al.</i> (1997)
Horse	Mortality during racing	Gender, race characteristics	Wood <i>et al.</i> (2001b)
Horse	Mortality (in foals)	Management, sire and mare factors	Haas <i>et al.</i> (1996)
Horse	Motor neuron disease	Breed, diet	Mohammed <i>et al.</i> (1993); Divers <i>et al.</i> (1994)
Horse	Musculoskeletal injuries	Age, season, factors related to racing history and race-track  Racing-related factors and results of pre-race inspection Racing and training schedules Hoof size, shape and balance	Bailey <i>et al.</i> (1997, 1998); Cogger <i>et al.</i> (2003); Verheyen <i>et al.</i> (2003) Cohen <i>et al.</i> (1997) Estberg <i>et al.</i> (1998) Kane <i>et al.</i> (1998)
Horse	Navicular disease	Breed, sex, age	Lowe (1974)
Horse	Osteochondrosis	Breed, sex, age, weight Hepatic copper status	Mohammed (1990a) van Weeren <i>et al.</i> (2003)
Horse	Parturient mortality	Method of delivery	Freeman <i>et al.</i> (1999)
Horse	Pericarditis	History, environment	Seahorn <i>et al.</i> (2003)
Horse	Perioperative fatality	Breed, sex, age, type, time and duration of surgery, anaesthetic	Johnston (1994)
Horse	Pleuropneumonia	Breed, sex, age, occupation, racing and vaccination history	Austin <i>et al.</i> (1995)
Horse	Pneumonia (in foals)	Breed, sex, management, farm characteristics	Chaffin <i>et al.</i> (2003a,b,c)
Horse	Post-operative ileus	Pre-operative and post-operative clinical variables	Blikslager <i>et al.</i> (1994)
Horse	Pregnancy	Mare, sire, management	van Buiten <i>et al.</i> (2003)
Horse	Protozoal myeloencephalitis	Age, history, management	Saville <i>et al.</i> (2000)
Horse	Potomac fever	see Ehrlichiosis	
Horse	Racing characteristics	Sex, age, foaling period	Bailey <i>et al.</i> (1999a)

Species	Disease*	Hypothesized risk factors	Source
Horse	Racing falls	Racing history, course characteristics	Pinchbeck <i>et al.</i> (2004a)
Horse	Racing history and performance	Sex, age, gait, previous racing history	Physick-Sheard (1986a,b); Physick-Sheard and Russell (1986); Beard <i>et al.</i> (1994)
	(post-operative)	Whip use, race progress Race and rider characteristics Lesions in the third carpal bone Synovitis Osteochondrosis dissecans	Pinchbeck <i>et al.</i> (2004b) Singer <i>et al.</i> (2003) Uhlhorn and Carlsten (1999) Roneus <i>et al.</i> (1997) Beard <i>et al.</i> (1994)
Horse	Racing, eventing and training injuries	Age, track type and condition, environmental conditions, length of race, racing history, season, training methods	Rooney (1982); Hill <i>et al.</i> (1986); Robinson <i>et al.</i> (1988); Mohammed <i>et al.</i> (1991a, 1992a); Peloso <i>et al.</i> (1994); Pinchbeck <i>et al.</i> (2002a,b, 2003); Stephen <i>et al.</i> (2003); Parkin <i>et al.</i> (2003); Murray <i>et al.</i> (2004a,b)
Horse	Reproductive failure	Management, caterpillars ( <i>Malacosoma americanum</i> )	Dwyer <i>et al.</i> (2002)
Horse	Respiratory disease	Age, specific bacteria	Newton <i>et al.</i> (2003)
Horse	<i>Salmonella</i> spp. infection	Breed, sex, presenting complaint, emergency admission, pre-surgical status, procedures (e.g., anaesthesia, antibiotic administration)	Hird <i>et al.</i> (1984, 1986); House <i>et al.</i> (1999)
Horse	Sarcoids	Breed, sex, age  Age, sarcoid characteristics (for recurrence)	Angelos <i>et al.</i> (1988); Mohammed <i>et al.</i> (1992b); Reid and Gettinby (1994); Reid <i>et al.</i> (1994) Broström (1995)
Horse	<i>Sarcocystis</i> spp. (serological)	Management, proximity to opossums	Rossano <i>et al.</i> (2003)
Horse	Self-mutilation syndrome	Sex	Dodman <i>et al.</i> (1994)
Horse	Strangles	Population size, number of mares served, location, fencing and feeder type, water source, vaccinal status Previous exposure to <i>Streptococcus equi</i>	Jorm (1990) Hamlen <i>et al.</i> (1994)
Horse	Sweet itch	Breed, sex, age, coat colour, topographical location, rainfall Sex geographical region, country of origin	Braverman <i>et al.</i> (1983) Broström and Larsson (1987)
Horse	Training schedule	Injuries	Bailey <i>et al.</i> (1999b)
Horse	Upper respiratory tract disease	Age, sex management, immune status	Townsend <i>et al.</i> (1991)
Horse	Uveitis	Breed	Angelos <i>et al.</i> (1988)
Horse (foals)	Various diseases and mortality	Age, management	Cohen (1994); Junwook Chi <i>et al.</i> (2002)
Man	Fatal attacks	Breed of dog	Sacks <i>et al.</i> (2000)
Opossum	Tuberculosis	Climate, body condition, demographic variables	Pfeiffer <i>et al.</i> (1991)
Ox	Abomasal displacement	Serum electrolyte and mineral concentrations	Delgado-Lecaroz <i>et al.</i> (2000)
Ox	Abortion	Management and husbandry, genital infection <i>Neospora caninum</i> <i>Neospora caninum</i> (serological) <i>Neospora caninum</i> , other microbes  Bovine herpesvirus-4 (serological) <i>Chlamydia psittaci</i> (serological)	Lemire <i>et al.</i> (1991) Thurmond and Hietala (1997) Jensen <i>et al.</i> (1999) Hässig and Gottstein (2002); Thobokwe and Heuer (2004) Czaplicki and Thiry (1998) Cavirani <i>et al.</i> (2001)
Ox	Anaplasmosis	Management practices, herd location (vegetation)	Morley and Hugh-Jones (1989)
Ox	Antibiotic milk residues	Management	Kaneene and Willeberg (1988)

Species	Disease*	Hypothesized risk factors	Source
Ox	Anoestrus	Parity, body condition, housing, nutrition	Pouilly <i>et al.</i> (1994)
Ox	Babesiosis (serological)	Management	Solorio-Rivera <i>et al.</i> (1999)
Ox	Bladder tumours	Breed, sex, age, location	Seifi <i>et al.</i> (1995)
Ox	Bluetongue	Location, climate (relative humidity, temperature, rainfall)	Ward (1991); Ward and Thurmond (1995)
Ox	Bovine spongiform encephalopathy	Herd size and type, animal source Maternally associated factors Region, farm characteristics, time	Denny and Hueston (1997) Wilesmith <i>et al.</i> (1997) Stevenson <i>et al.</i> (2000)
Ox	Bovine virus diarrhoea virus infection (congenital) (serological)	Country, herd structure and management Breed, age, herd history Herd and dam characteristics Age, serological status against <i>Campylobacter fetus</i> , <i>Haemophilus somnus</i> and <i>Leptospira hardjo</i> Management and husbandry, age of farmer	Houe <i>et al.</i> (1995) Mainar-Jaime <i>et al.</i> (2001) Muñoz-Zanzi <i>et al.</i> (2003) Akhtar <i>et al.</i> (1996) Valle <i>et al.</i> (1999)
Ox	Brucellosis	Breed, sex, age Herd size, stabling, registration status, history of previous reactors, time of exposure, vaccination level, farm density, herd type, insemination methods, other management factors Breed, sex, age lactation, source	McDermott <i>et al.</i> (1987) Kellar <i>et al.</i> (1976); Pfeiffer <i>et al.</i> (1988); Omer <i>et al.</i> (2000) Bedard <i>et al.</i> (1993)
Ox	Caesarian section	Age, gestation length, sex of calf, breed of sire, dry period, previous history of caesarian section	Barkema <i>et al.</i> (1991)
Ox	<i>Campylobacter fetus</i> infection (serological)	Breed, age, location, antibodies to other organisms	Akhtar <i>et al.</i> (1990)
Ox	Conception rate	Bovine viral diarrhoea virus infection	Houe <i>et al.</i> (1993)
Ox	Contagious bovine pleuropneumonia	Breed, sex, age	McDermott <i>et al.</i> (1987)
Ox	<i>Cryptosporidium</i> spp. infection (in calves)	Husbandry, management, typographical location, herd size	Garber <i>et al.</i> (1994)
Ox	Culling	Various diseases  Parity, stage of lactation, production	Martin <i>et al.</i> (1982a); Milian-Suazo <i>et al.</i> (1988, 1989); Oltenacu <i>et al.</i> (1990); Beaudeau <i>et al.</i> (1994); Rhodes <i>et al.</i> (2003) Milian-Suazo <i>et al.</i> (1988, 1989)
Ox	Cystic ovaries	Breed, parity, season, previous history of the condition, twinning, milk yield	Emanuelson and Bendixen (1991)
Ox	Decreased milk production	<i>Campylobacter fetus</i> (serological) Ketosis (subclinical)	Akhtar <i>et al.</i> (1993a) Miettinen and Setälä (1993)
Ox	Dermatitis interdigitalis (in dairy calves)	Breed, age, housing, sole haemorrhages, nutrition, management	Frankena <i>et al.</i> (1993)
Ox	Diarrhoea (in calves)	Age, season, management Breda virus Rotavirus, coronavirus  <i>Cryptosporidium</i> spp., <i>Salmonella</i> spp., enterotoxigenic <i>Escherichia coli</i>	Waltner-Toews <i>et al.</i> (1986a,b); Clement <i>et al.</i> (1995) Hoet <i>et al.</i> (2003) Reynolds <i>et al.</i> (1986); De Verdier and Svensson (1998) Snodgrass <i>et al.</i> (1986)
Ox	Digital haemorrhages (in dairy calves)	Breed, age, housing, dermatitis, interdigitalis, nutrition, management	Frankena <i>et al.</i> (1992)
Ox	Displaced abomasum	Age, medical history Parity, retained placenta, stillbirth, ketonuria, aciduria, metritis, milk fever	Willeberg <i>et al.</i> (1982) Markusfeld (1986)

Species	Disease*	Hypothesized risk factors	Source
Ox	Drug residue violations	Management	Carpenter <i>et al.</i> (1995)
Ox	Dystokia	Breed, season, management, other diseases Breed, dimension of dam and calf Previous history of dystocia Management, environment	Bendixen <i>et al.</i> (1986a,b) Schwabe and Hall (1989) Rowlands <i>et al.</i> (1986) Mohammed <i>et al.</i> (1991b)
Ox	Endometritis	Previous history of other diseases	Rowlands <i>et al.</i> (1986)
Ox	<i>Escherichia coli</i> (verocytotoxigenic) infection (shedding)	Age, management	Wilson <i>et al.</i> (1993); Schouten <i>et al.</i> (2001, 2004)
Ox	Fever (undifferentiated, in calves)	Management, diet Various infectious agents (serological)	Garber <i>et al.</i> (1995) Booket <i>et al.</i> (1999)
Ox	Foot-and-mouth disease (vaccine-related)	Geographical factors Vaccine type	Rivas <i>et al.</i> (2003) Nicod <i>et al.</i> (1991)
Ox	Foot health	Housing	Hultgren and Bergsten (2001)
Ox	Foot lesions	Housing	Hultgren (2002); Webster (2002)
Ox	High milk somatic cell counts	Age, year, season, herd size, stage of lactation, management, environment	Bodoh <i>et al.</i> (1976); Moxley <i>et al.</i> (1978); Lindstrom (1983); Erskine <i>et al.</i> (1987); Hueston <i>et al.</i> (1987, 1990); Osteras and Lund (1988a,b); Hutton <i>et al.</i> (1991)
Ox	Hygienic condition of finished cattle	Production factors	Davies <i>et al.</i> (2000)
Ox	Hypomagnesaemia	Body condition, feed quantity and quality, location	Harris <i>et al.</i> (1983)
Ox	Impaired production	Bovine leukaemia, viral infection	Jacobs <i>et al.</i> (1991)
Ox	Inactive ovaries	High milk yield after calving, long dry period, low milk yield prior to calving, parity, primary metritis, retained placenta, serum glutamate oxaloacetate transaminase activity, stillbirth, twinning	Markusfeld (1987)
Ox	Infectious bovine rhinotracheitis	Herd characteristics	Solis-Calderon <i>et al.</i> (2003)
Ox	Infertility (in beef cows)	Calving difficulties, retained placenta, puerperal endometritis	Ducrot <i>et al.</i> (1994)
Ox	Infertility (female)	Exposure to high voltage transmission lines Lameness	Algers and Hennichs (1985) Collick <i>et al.</i> (1989)
Ox	Interdigital dermatitis	Management	Murray <i>et al.</i> (2002)
Ox	Intramammary infection with <i>Staphylococcus</i> spp.	Management, environment, hygiene	Dargent-Molina <i>et al.</i> (1988); Hutton <i>et al.</i> (1991); Bartlett <i>et al.</i> (1992); Bartlett and Miller (1993)
Ox	Intramammary infection with <i>Streptococcus</i> spp.	Management, environment	Dargent-Molina <i>et al.</i> (1988)
Ox	Intussusception	Breed, sex, age, season	Constable <i>et al.</i> (1997)
Ox	Johne's disease	Environment Breed, age, parity, herd size Calf management, herd size and location Location, management Management, wildlife Soil type	Johnson-Ifearulundu and Kaneene (1999) Jakobsen <i>et al.</i> (2000) Collins <i>et al.</i> (1994) Wells and Wagner (2000) Daniels <i>et al.</i> (2002) Ward and Perez (2004)
Ox	Ketosis	Metritis, low milk yield before calving, long dry period Breed, previous history of ketosis and other diseases	Markusfeld (1985) Rowlands <i>et al.</i> (1986); Bendixen <i>et al.</i> (1987c)

Species	Disease*	Hypothesized risk factors	Source
Ox	Lameness	Breed, parity, pedal lesions, stage of lactation, herd size, herd milk production Previous history of lameness Parity, herd size, housing nutrition, bedding Physical hoof properties Body weight, condition score, pedal anatomy Environmental and behavioural factors Season, location, soil type, housing, nutrition, foot care, floor type Season, herd size, management, veterinary practice Farmers' knowledge and training Long-term administration of bovine somatotrophin Breed, parity, season, other diseases, summer grazing, management Housing Management, housing, milk yield, prior bouts of lameness Farm-level and animal-level factors	Frankena <i>et al.</i> (1991a) Rowlands <i>et al.</i> (1986) Groehn <i>et al.</i> (1992) Tranter <i>et al.</i> (1993) Wells <i>et al.</i> (1993a) Chesterton <i>et al.</i> (1989) Faye and Lescouret (1989) Rowlands <i>et al.</i> (1983); Wells <i>et al.</i> (1993b) Mill and Ward (1994) Wells <i>et al.</i> (1995) Alban (1995) Faull <i>et al.</i> (1996) Alban <i>et al.</i> (1996) Gitau <i>et al.</i> (1996)
Ox	Laminitis (in calves)	Breed, age, management, feeding, housing	Frankena <i>et al.</i> (1991b)
Ox	Leptospirosis	Local geography (e.g., presence of rivers, number of arable hectares), presence of other species of livestock and bulls, management (including rodent control)	Pritchard <i>et al.</i> (1989); Alonso-Andicoberry <i>et al.</i> (2001)
Ox	Mammary lesions	Breed, parity, season, milk yield, other diseases Management	Bendixen <i>et al.</i> (1986a, 1988b) Grohn <i>et al.</i> (1988)
Ox	Mastitis	Age, herd size, stage of lactation, stage of dry period, season, winter housing  Breed, manure system, stall and bedding type, lactation number, other diseases Udder and teat characteristics Previous history of mastitis Management, environment  Retained placenta Teat disinfection Bovine virus diarrhoea virus Somatic cell count  Condition of bedding, hygiene	Pearson <i>et al.</i> (1972); Francis <i>et al.</i> (1986); Wilesmith <i>et al.</i> (1986); Rowlands and Booth (1989); Hultgren (2002) Bendixen <i>et al.</i> (1988a); Oltenacu <i>et al.</i> (1988) van den Geer <i>et al.</i> (1988) Rowlands <i>et al.</i> (1986) Pearson <i>et al.</i> (1972); Agger <i>et al.</i> (1986); Bendixen <i>et al.</i> (1986a); McDougall (2003); Zecconi <i>et al.</i> (2003) Schukken <i>et al.</i> (1988) Blowey and Collis (1992) Waage (2000); Rupp <i>et al.</i> (2000); Beaudeau <i>et al.</i> (2002); Peeler <i>et al.</i> (2002, 2003) Ward <i>et al.</i> (2002b)
Ox	Mastitis caused by mycoplasmata	Herd size, percentage culled, production	Thomas <i>et al.</i> (1981, 1982)
Ox	Mastitis caused by <i>Nocardia</i>	Breed, herd, size milking management, dry cow therapy, housing	Stark and Anderson (1990); Ferns <i>et al.</i> (1991)
	Mastitis caused by <i>Streptococcus agalactiae</i>	Herd size, herd location, participation in a dairy herd improvement scheme	Thorburn <i>et al.</i> (1983)
	Mastitis (somatic cell counts/sub-clinical)	Milking characteristics, teat structure  Teat disinfection Teat lesions (presence and position) Management  Somatic cell counts Factors before the dry period Age, condition, type of farm, management	Slettbakk <i>et al.</i> (1990) Blowey and Collis (1992) Agger and Willeberg (1986) Osteras and Lund (1988a,b); Tadich <i>et al.</i> (2003) Beaudeau <i>et al.</i> (1998) Østerås and Edge (2000) Busato <i>et al.</i> (2000)



Species	Disease*	Hypothesized risk factors	Source
		History, biochemical and haematological markers	Barnouin and Chassagne (2001)
Ox	Metritis	Diet Demographic and management variables, other diseases, diet Breed, parity, other diseases, management	Barnouin and Chacornac (1992) Kaneene and Miller (1995) Brunn <i>et al.</i> (2002)
Ox	Morbidity (in calves)	Maternal dystocia, management	Sanderson and Dargatz (2000)
Ox	Mortality (in calves)	Management, husbandry (e.g., corn silage feeding, penning, vaccination)  Herd size, environment, management Individual-animal and maternal factors	Martin <i>et al.</i> (1982b); Wells <i>et al.</i> (1996); Losinger and Heinrichs (1996) Lance <i>et al.</i> (1992) Wittum <i>et al.</i> (1994a)
Ox	<i>Mycobacterium paratuberculosis</i> (see Johne's disease)		
Ox	<i>Neospora caninum</i> (serological)	Cattle density, wildlife abundance Management Breed, age, management	Barling <i>et al.</i> (2000b) Barling <i>et al.</i> (2001) Romero <i>et al.</i> (2002)
Ox	Ocular squamous cell carcinoma	Corneoscleral pigmentation	Anderson (1963)
Ox	Papillomatous digital dermatitis	Demographic, management and production variables	Rodríguez-Lainz <i>et al.</i> (1996)
Ox	Parturient paresis (milk fever)	Age, season Breed, age, nutrition Breed, age, parity, male calves, twinning production, pasture feeding, housing system, previous history of parturient paresis, retained placenta Diet (in the dry period) Breeding Calving season, production potential, exercise, prepartum nutrition, parity Prepartum grain feeding Month, herd size, type of housing, milk recording Previous milk production	Dohoo <i>et al.</i> (1984) Harris (1981) Ekesbo (1966); Bendixen <i>et al.</i> (1986a, 1987b)  Barnouin (1991) Mohammed <i>et al.</i> (1991b) Curtis <i>et al.</i> (1984); Rowlands <i>et al.</i> (1986) Emery <i>et al.</i> (1969) Saloniemi and Roine (1981)
Ox	Periparturient and reproductive traits	Serum cholesterol and non-esterified fatty acid levels Previous history of traits Other periparturient conditions	Kaneene <i>et al.</i> (1991) Markusfeld (1990) Peeler <i>et al.</i> (1994)
Ox	Physical injuries	Season, cow characteristics, disease, production	Enevoldsen <i>et al.</i> (1990)
Ox	Pneumonia (in calves)	Age, season, management	Walter-Toews <i>et al.</i> (1986a,b)
Ox	Production efficiency	Antibodies to bluetongue virus and <i>Mycoplasma bovis</i> Sire characteristics, health and management Antibodies to bovine immunodeficiency-like virus Antibodies to bovine leukosis virus Antibodies to <i>Neospora caninum</i> Gas pollution Natural gas (leaked)	Uhaa <i>et al.</i> (1990a) McDermott <i>et al.</i> (1994a) McNab <i>et al.</i> (1994) Ott <i>et al.</i> (2003) Barling <i>et al.</i> (2000a) Scott <i>et al.</i> (2003a,b) Waldner <i>et al.</i> (1998)
Ox	Pruritus, pyrexia, haemorrhagic syndrome	Citrinin (in citrus pulp pellets)	Griffiths and Done (1991)
Ox	Rectovaginal injuries	Age, dystocia	Farhoodi <i>et al.</i> (2000)
Ox	Reduced survival period (in calves)	Various diseases	Curtis <i>et al.</i> (1989)

<i>Species</i>	<i>Disease*</i>	<i>Hypothesized risk factors</i>	<i>Source</i>
Ox	Repeat breeder syndrome	Herd characteristics, environment, management, other diseases, milk production Herd profile and production parameters	Lafi and Kaneene (1992); Moss <i>et al.</i> (2002) Gustafsson and Emanuelson (2002)
Ox	Reproductive disorders	Other diseases Parity, milk yield	Saloniemi <i>et al.</i> (1988) Grohn <i>et al.</i> (1990)
Ox	Reproductive performance	Antibodies to bluetongue virus, <i>Mycoplasma bovis</i> and <i>Campylobacter fetus</i> Bovine leukaemia virus infection Retained placenta, metritis Various diseases  Management, nutrition, site-related factors Oestrus synchronization therapy Periparturient diseases  Sole ulcers and claw trimming	Emanuelson <i>et al.</i> (1992); Akhtar <i>et al.</i> (1993b); Uhaa <i>et al.</i> (1990b) Emanuelson <i>et al.</i> (1992) Sandals <i>et al.</i> (1979) Borsberry and Dobson (1989); Oltenucu <i>et al.</i> (1990) McDermott <i>et al.</i> (1994b) Xu <i>et al.</i> (1996) Mellado and Reyes (1994); McDougall (2001) Hultgren <i>et al.</i> (2004)
Ox	Respiratory disease	Immune status, antibody level to various infectious agents  Various infectious agents (serological) Herd size, management	Pritchard <i>et al.</i> (1983); Caldwell <i>et al.</i> (1988); O'Connor <i>et al.</i> (2001a,b) Martin <i>et al.</i> (1998, 1999) Norström <i>et al.</i> (2000)
Ox	Retained placenta	Breed, age, parity, other diseases, sex of calf, previous history of the disease Diet (in the dry period)	Bendixen <i>et al.</i> (1987a)  Barnouin and Chassagne (1990)
Ox	Salmonellosis	Management, environmental and production variables Previous history of retained placenta Diet, feed source Management, presence of rodents, exposure to poultry manure Management, dogs, cats  Management (conventional vs organic farms)	Bendixen <i>et al.</i> (1986a); Vandegraaf (1980) Rowlands <i>et al.</i> (1986) Anderson <i>et al.</i> (1997) Warnick <i>et al.</i> (2001)  Kirk <i>et al.</i> (2002); Veling <i>et al.</i> (2002) Foosler <i>et al.</i> (2004)
Ox	Sarcocystosis	Management, presence of dogs, cats and foxes, carcass disposal	Savini <i>et al.</i> (1994)
Ox	Sole haemorrhages and heel horn erosion	Housing	Bergsten and Herlin (1996)
Ox	Stillbirth and neonatal morbidity and mortality (in beef calves)	Sex, dystokia, twins, age of dam	Wittum <i>et al.</i> (1991)
Ox	Stillbirth/perinatal weak-calf syndrome	<i>Leptospira</i> infection	Smyth <i>et al.</i> (1999)
Ox	Tail-tip necrosis	Management, behaviour	Drolia <i>et al.</i> (1990)
Ox	Trypanosomiasis	Several variables relating to host population size, vectors, climate and ecological zones	Habtemariam <i>et al.</i> (1986)
Ox	Tuberculosis	Breed, sex, age, location, source Husbandry, farm characteristics, environmental factors  Colostrum management  Distance of herd from badger set  Movement Badger control  Opossum control	Bedard <i>et al.</i> (1993) Griffin <i>et al.</i> (1993, 1996); Marangon <i>et al.</i> (1998); Kaneene <i>et al.</i> (2002); Shirima <i>et al.</i> (2003) Rentefia Evangelista and De Anda (1996) Martin <i>et al.</i> (1997, 1998); Denny and Wilesmith (1999); Munroe <i>et al.</i> (1999) Abernethy <i>et al.</i> (2000) Máirtín <i>et al.</i> (1998); Donnelly <i>et al.</i> (2003) Caley <i>et al.</i> (1999)

Species	Disease*	Hypothesized risk factors	Source
Ox	Umbilical hernia (congenital)	Sex, sire, maternal characteristics Sire, umbilical infection	Herrmann <i>et al.</i> (2001) Steenholdt and Hernandez (2004)
Ox	Uterine prolapse	Parturition history	Murphy and Dobson (2002)
Ox	Variations in oestrus and fertility	Exposure to high-voltage transmission lines	Algers and Hultgren (1987)
Ox	Various diseases	Age, other diseases	Bigras-Poulin <i>et al.</i> (1990); Rajala and Gröhn (1998)
		Bovine leukaemia virus infection	Emanuelson <i>et al.</i> (1992)
		Management	Junwook Chi <i>et al.</i> (2002); van Schaik <i>et al.</i> (2002)
	(in calves)	Housing	Valde <i>et al.</i> (1997)
		Individual-animal and maternal factors	Wittum <i>et al.</i> (1994a)
Ox	Volvulus	Serum electrolyte and mineral concentrations	Delgado-Lecaroz <i>et al.</i> (2000)
Ox	Weaning weight	Neonatal health	Wittum <i>et al.</i> (1994b)
Ox	Winter dysentery	Age, management, previous outbreaks of the disease	Jactel <i>et al.</i> (1990); Smith <i>et al.</i> (1998a,b)
Pig	Adventitious bursitis (hock)	Type of floor, foot lesions Management	Moultotou <i>et al.</i> (1998) Moultotou <i>et al.</i> (1999a)
Pig	<i>Ascaris suum</i> and <i>Oesophagostomum</i> spp.	Management	Dangolla <i>et al.</i> (1996)
Pig	Atrophic rhinitis	Season, housing	Cowart <i>et al.</i> (1992)
Pig	Aujeszky's disease	Herd size and type, date of outbreak Husbandry, housing, herd size, clinical signs of pseudorabies and <i>Actinobacillus pleuropneumoniae</i> infection, feeding, time since quarantine	Mousing <i>et al.</i> (1991) Anderson <i>et al.</i> (1990)
	(serological)	Biosecurity Topography Management	Bech-Nielsen <i>et al.</i> (1995) Solymosi <i>et al.</i> (2004) Rodríguez-Buenfil <i>et al.</i> (2002); Tamba <i>et al.</i> (2002)
	(test status)	Herd size and type, location	Cowen <i>et al.</i> (1991); Leontides <i>et al.</i> (1995)
		Age, management, vaccination, geographical density of herds Management, husbandry	Weigel <i>et al.</i> (1992) Austin <i>et al.</i> (1993)
Pig	Carcass condemnations	Herd size, management, environment	Tuovinen <i>et al.</i> (1992)
Pig	Culling	Management and environment Various diseases	D'Allaire <i>et al.</i> (1989) Stein <i>et al.</i> (1990)
Pig	Encephalomyocarditis	Management, other species	Maurice <i>et al.</i> (2002)
Pig	Enzootic pneumonia	Sex, age, clinical disease, ventilation, herd size, replacement policy, diarrhoea Season, housing	Aalund <i>et al.</i> (1976); Pointon <i>et al.</i> (1985); Willeberg <i>et al.</i> (1978) Cowart <i>et al.</i> (1992)
Pig	Foot abscesses (in neonates)	Birth weight, breed of sire, management, parity and history of illness in the sow, dose of antibiotic	Gardner and Hird (1994)
Pig	Foot and skin lesions	Behaviour	Moultotou and Green (1999)
Pig	Forelimb lesions	Management, housing	Moultotou <i>et al.</i> (1999b)
Pig	Gastric lesions	Behaviour	Dybkjær <i>et al.</i> (1994)
Pig	Health and welfare	Housing	Cagienard <i>et al.</i> (2002)
Pig	Impaired growth	Respiratory disease, antibodies to <i>Mycoplasma hyopneumoniae</i>	Fourichon <i>et al.</i> (1990)
Pig	Intestinal lesions associated with <i>Campylobacter</i> spp.	Open drains, slatted floors, feed medication	Pointon (1989)
Pig	Leg and teat damage	Floor type	Edwards and Lightfoot (1986); Furniss <i>et al.</i> (1986)

Species	Disease*	Hypothesized risk factors	Source
Pig	Leptospirosis (serological)	Breed, age, management	Boqvist <i>et al.</i> (2002)
Pig	Litter size	Previous lactation length and weaning-to-conception interval	Dewey <i>et al.</i> (1994)
Pig	Mortality	Herd characteristics, disease and health management	Abiven <i>et al.</i> (1998)
Pig	Pale, soft and exudative pork	Pre-slaughter processing factors	Spangler <i>et al.</i> (1991)
Pig	Pleuritis	Sex, various infections, management	Mousing <i>et al.</i> (1990); Enøe <i>et al.</i> (2002)
Pig	Porcine dermatitis nephropathy syndrome	Age, source of pigs, management	Cook <i>et al.</i> (2001)
Pig	Porcine reproductive and respiratory syndrome virus	Animal trade	Mortensen <i>et al.</i> (2002)
Pig	Porcine respiratory coronavirus (serological)	Herds, size, location, husbandry and management	Flori <i>et al.</i> (1995)
Pig	Post-weaning multisystemic wasting syndrome	Age, source of pigs, management	Cook <i>et al.</i> (2001)
Pig	Productivity	Management	Rose <i>et al.</i> (2003)
Pig	Pulmonary lesions	Management and husbandry	King <i>et al.</i> (1998)
Pig	Pseudorabies (see Aujeszky's disease)		Maes <i>et al.</i> (2001)
Pig	Reproductive failure	Breed, management factors, previous reproductive performance, behaviour	Madec (1988)
Pig	Reproductive performance	Antibodies to <i>Leptospira interrogans</i> subgroup <i>Australis</i>	Pritchard <i>et al.</i> (1985)
Pig	Reproductive performance	Season	Xae <i>et al.</i> (1994)
Pig	Reproductive performance	Management	Sterning and Lundeheim (1995)
Pig	Reproductive performance	Bovine virus diarrhoea virus	Frederiksen <i>et al.</i> (1998)
Pig	Respiratory disease	Housing, vermin control, husbandry, management	Hurnik and Dohoo (1991); Vraa-Andersen (1991); Elbers <i>et al.</i> (1992)
Pig	Respiratory disease	Herd structure, season, management	Stärk <i>et al.</i> (1998)
Pig	Respiratory disease	Climate	Beskow <i>et al.</i> (1998)
Pig	Respiratory disease	Type of enterprise, management	Hege <i>et al.</i> (2002)
Pig	Rotavirus infection	Management	Dewey <i>et al.</i> (2003)
Pig	Salmonellosis	Management, diet	Lo Fo Wong <i>et al.</i> (2004)
Pig	Sow health	Housing	Hultén <i>et al.</i> (1995)
Pig	Stillbirths	Breed, parity, management	Lucia <i>et al.</i> (2002)
Pig	Swine fever	Farm characteristics, management, herd size, biosecurity	Elbers <i>et al.</i> (2001a)
Pig	Trichinosis (serological)	Management (including access to cats and exposure to wildlife)	Cowen <i>et al.</i> (1990)
Pig	Umbilical hernia	Breed, sex, antibiotic administration	Searcy-Bernal <i>et al.</i> (1994)
Pig	Various diseases	Breed, previous history of disease	Lingaas (1991a)
Pig	Various diseases	Season	Lingaas and Ronningen (1991)
Pig	Various diseases	Herd size, management	Lingaas (1991b)
Pig	Various intestinal pathogens	Management	Stege <i>et al.</i> (2001)
Pig	Various lesions (at slaughter)	Environment, management	Flesja <i>et al.</i> (1982)
Pig	Various lesions (at slaughter)	Rearing system, herd size	Flesja and Solberg (1981)
Poultry	<i>Campylobacter</i> spp. infection	Management	Evans and Sayers (2000)
Poultry	<i>Campylobacter</i> spp. infection	Season, housing, management	Refrégier-Petton <i>et al.</i> (2001); Cardinale <i>et al.</i> (2004)

Species	Disease*	Hypothesized risk factors	Source
		Age, other animals, management	Bouwknegt <i>et al.</i> (2004)
Poultry	Coccidiosis	Several variables relating to host population density, parasite control, health and management of hosts, and environment	Stallbaumer and Skryznecki (1987); Graat <i>et al.</i> (1996, 1998)
Poultry	Feather picking	Management	Green <i>et al.</i> (2000)
Poultry	Feather- and vent-pecking	Management	Pötzsch <i>et al.</i> (2001)
Poultry	Foot lesions	Management	Martrenchar <i>et al.</i> (2002)
Poultry	Hydropericardium syndrome	Location, management, broiler strain	Akhtar <i>et al.</i> (1992)
Poultry	Marek's disease and mortality	Strain, flock size, management	Heier and Jarp (2000)
Poultry	Mortality	Management, housing	Heier <i>et al.</i> (2002)
Poultry	<i>Mycoplasma gallisepticum</i> infection	Hygiene	Mohammed (1990b)
Poultry	Necrotic enteritis	Diet	Kaldhusdal and Skjerve (1996)
Poultry	Newcastle disease	Demographic and management variables, prophylactic measures	Akhtar and Zahid (1995)
Poultry	<i>Salmonella enteritidis</i> (in eggs)	Management and environmental factors	Henzler <i>et al.</i> (1998)
Poultry	Salmonellosis	Geographical region, type of ventilation, flock size, farm type, management and hygiene, source of feed	Graat <i>et al.</i> (1990); Chriél <i>et al.</i> (1999); Rose <i>et al.</i> (1999)
Raptors	Pododermatitis (bumblefoot)	Species, age, season, other diseases	Rodríguez-Lainz <i>et al.</i> (1997)
Salmon ( <i>Salmo salar</i> )	Infectious salmon anaemia	Factors related to potential active and passive transmission, reservoirs and host resistance	Vågsholm <i>et al.</i> (1994)
		Management	Hammell and Dohoo (1999)
Seal	Herpesvirus	Species, age	Martina <i>et al.</i> (2002)
Sheept	Abomasal bloat (in young lambs)	Geographical area, type of floor, diet	Lutnaes and Simensen (1983)
Sheep	Blowfly strike	Climate	Ward (2001)
Sheep	Brucellosis (serological)	Breed, management, farmer characteristics	Mainar-Jaime and Vázquez-Boland (1999); Reviriego <i>et al.</i> (2000)
Sheep	Caseous lymphadenitis	Breed, management	Binns <i>et al.</i> (2002a)
Sheep	Congenital entropion	Breed of sire	Green <i>et al.</i> (1995)
Sheep	Diarrhoea and faecal soiling (in lambs)	Sex, history, neonatal diarrhoea, wool type	French <i>et al.</i> (1998)
		Variables related to the ewe and lamb	French and Morgan (1996)
Sheep	Fetal membrane retention	Management of lambing, lamb status (healthy/stillborn/neonatal death)	Leontides <i>et al.</i> (2000)
Sheep	Foot-rot	Management	Wassink <i>et al.</i> (2003)
Sheep	Hepatic lesions (especially due to <i>Cysticercus tenuicollis</i> )	Spreading of pig slurry, access to grazing land by hunts, infrequent use of canine cestocides	Jepson and Hinton (1986)
Sheep	Infectious kerato-conjunctivitis	<i>Mycoplasma conjunctivae</i> , <i>Branhamella ovis</i> , <i>Escherichia coli</i> , <i>Staphylooccus aureus</i>	Egwu <i>et al.</i> (1989)
Sheep	Interdigital dermatitis	Farm location, management	Wassink <i>et al.</i> (2004)
Sheep	Intestinal adenocarcinoma	Exposure to herbicides	Newell <i>et al.</i> (1984)
Sheep	Listeriosis	Housing, feeding of silage	Wilesmith and Gitter (1986)
		Breed, sex, age, management	Nash <i>et al.</i> (1995)
Sheep	Maedi-Visna	Breed, age, ewe/lamb relationship	Houwers (1989)
		Husbandry, management	Campbell <i>et al.</i> (1991)
Sheep	Mastitis	Non-clinical intramammary infection	Bor <i>et al.</i> (1989)

<i>Species</i>	<i>Disease*</i>	<i>Hypothesized risk factors</i>	<i>Source</i>
Sheep	Mortality (during marine transportation) (in lambs) (neonatal)	Sex, season, birth weight Age, body condition, season Management Ewe and lamb characteristics	Turkson <i>et al.</i> (2004) Higgs <i>et al.</i> (1991) Binns <i>et al.</i> (2002b) Christley <i>et al.</i> (2003)
Sheep	<i>Mycobacterium paratuberculosis</i> (serological)	Breed, husbandry and management	Mainar-Jaime and Vázquez-Boland (1998)
Sheep	Orf	Age, frequency of the disease, mammary lesions, infected pasture, animal density, nutritional deficiencies, lambing period	Ducrot and Cimarosti (1991)
Sheep	Perinatal mortality	Birth weight, supplementation and weight gain of ewes during pregnancy	Mukasa-Mugerwa <i>et al.</i> (1994)
Sheep	Poor body condition	Periodontal disease	Orr and Chalmers (1988)
Sheep	Prewaning lamb mortality	Breed, sex, litter size, birth weight, causes of death	Yapi <i>et al.</i> (1990)
Sheep	Production	Pneumonia	Goodwin <i>et al.</i> (2004)
Sheep	Productivity	Lentivirus infection	Keen <i>et al.</i> (1997)
Sheep	Scrapie	Management Trace elements	Hopp <i>et al.</i> (2001) Chihota <i>et al.</i> (2004)
Sheep	Toxoplasmosis (serological)	Cats (neutered versus intact), kittens' nutrition, pigs, management Geography, management	Waltner-Toews <i>et al.</i> (1991) Skjerve <i>et al.</i> (1998)
Shrimp	White spot disease	Production	Turnbull <i>et al.</i> (2003)
Trout	Bacterial gill disease	Management and ecological variables, level of production, previous history of disease, other diseases	Bebak <i>et al.</i> (1997)
Turkey	Fowl cholera	Management, vaccinal status, previous history of disease, other diseases	Hird <i>et al.</i> (1991)
Water buffalo	Osteomalacia	Season, parity, stage of lactation, serum phosphorus level	Heuer <i>et al.</i> (1991)
Water buffalo	Redwater	Season, parity, stage of lactation, serum phosphorus level	Heuer <i>et al.</i> (1991)

\* In some studies, 'Disease' is used loosely to describe the response variables

† Some studies include goats

# Appendix XXIII

## The variance-ratio ( $F$ ) distribution

5 per cent points

$f_2$	$f_1$														
	1	2	3	4	5	6	7	8	9	10	12	15	20	30	$\infty$
1	161.4	199.5	215.7	224.6	230.2	234.0	236.8	238.9	240.5	241.9	143.9	245.9	248.0	250.1	254.3
2	18.51	19.00	19.16	19.25	19.30	19.33	19.35	19.37	19.38	19.40	19.41	19.43	19.45	19.46	19.50
3	10.13	9.55	9.28	9.12	9.01	8.94	8.89	8.85	8.81	8.79	8.74	8.70	8.66	8.62	8.53
4	7.71	6.94	6.59	6.39	6.26	6.16	6.09	6.04	6.00	5.96	5.91	5.86	5.80	5.75	5.63
5	6.61	5.79	5.41	5.19	5.05	4.95	4.88	4.82	4.77	4.74	4.68	4.62	4.56	4.50	4.36
6	5.99	5.14	4.76	4.53	4.39	4.28	4.21	4.15	4.10	4.06	4.00	3.94	3.87	3.81	3.67
7	5.59	4.74	4.35	4.12	3.97	3.87	3.79	3.73	3.68	3.64	3.57	3.51	3.44	3.38	3.23
8	5.32	4.45	4.07	3.84	3.69	3.58	3.50	3.44	3.39	3.35	3.28	3.22	3.15	3.08	2.93
9	5.12	4.26	3.86	3.63	3.48	3.37	3.29	3.23	3.18	3.14	3.07	3.01	2.94	2.86	2.71
10	4.96	4.10	3.71	3.48	3.33	3.22	3.14	3.07	3.02	2.98	2.91	2.85	2.77	2.70	2.54
11	4.84	3.98	3.59	3.36	3.20	3.09	3.01	2.95	2.90	2.85	2.79	2.72	2.65	2.57	2.40
12	4.75	3.89	3.49	3.26	3.11	3.00	2.91	2.85	2.80	2.75	2.69	2.62	2.54	2.47	2.30
13	4.67	3.81	3.41	3.18	3.03	2.92	2.83	2.77	2.71	2.67	2.60	2.53	2.46	2.38	2.21
14	4.60	3.74	3.34	3.11	2.96	2.85	2.76	2.70	2.65	2.60	2.53	2.46	2.39	2.31	2.13
15	4.54	3.68	3.29	3.06	2.90	2.79	2.71	2.64	2.59	2.54	2.48	2.40	2.33	2.25	2.07
16	4.49	3.63	3.24	3.01	2.85	2.74	2.66	2.59	2.54	2.49	2.42	2.35	2.28	2.19	2.01
17	4.45	3.59	3.20	2.96	2.81	2.70	2.61	2.55	2.49	2.45	2.38	2.31	2.23	2.15	1.96
18	4.41	3.55	3.16	2.93	2.77	2.66	2.58	2.51	2.46	2.41	2.34	2.27	2.19	2.11	1.92
19	4.38	3.52	3.13	2.90	2.74	2.63	2.54	2.48	2.42	2.38	2.31	2.23	2.16	2.07	1.88
20	4.35	3.49	3.10	2.87	2.71	2.60	2.51	2.45	2.39	2.35	2.28	2.20	2.12	2.04	1.84
21	4.32	3.47	3.07	2.84	2.68	2.57	2.49	2.42	2.37	2.32	2.25	2.18	2.10	2.01	1.81
22	4.30	3.44	3.05	2.82	2.66	2.55	2.46	2.40	2.34	2.30	2.23	2.15	2.07	1.98	1.78
23	4.28	3.42	3.03	2.80	2.64	2.53	2.44	2.37	2.32	2.27	2.20	2.13	2.05	1.96	1.76
24	4.26	3.40	3.01	2.78	2.62	2.51	2.42	2.36	2.30	2.25	2.18	2.11	2.03	1.94	1.73
25	4.24	3.39	2.99	2.76	2.60	2.49	2.40	2.34	2.28	2.24	2.16	2.09	2.01	1.92	1.71
26	4.23	3.37	2.98	2.74	2.59	2.47	2.39	2.32	2.27	2.22	2.15	2.07	1.99	1.90	1.69
27	4.21	3.35	2.96	2.73	2.57	2.46	2.37	2.31	2.25	2.20	2.13	2.06	1.97	1.88	1.67
28	4.20	3.34	2.95	2.71	2.56	2.45	2.36	2.29	2.24	2.19	2.12	2.04	1.96	1.87	1.65
29	4.18	3.33	2.93	2.70	2.55	2.43	2.35	2.28	2.22	2.18	2.10	2.03	1.94	1.85	1.64
30	4.17	3.32	2.92	2.69	2.53	2.42	2.33	2.27	2.21	2.16	2.09	2.01	1.93	1.84	1.62
40	4.08	3.23	2.84	2.61	2.45	2.34	2.25	2.18	1.12	2.08	2.00	1.92	1.84	1.74	1.51
60	4.00	3.15	2.76	2.53	2.37	2.25	2.17	2.10	2.04	1.99	1.92	1.84	1.75	1.65	1.39
120	3.92	3.07	2.68	2.45	2.29	2.17	2.09	2.02	1.96	1.91	1.83	1.75	1.66	1.55	1.25
$\infty$	3.84	3.00	2.60	2.37	2.21	2.10	2.01	1.94	1.88	1.83	1.75	1.67	1.57	1.46	1.00

The table gives the 5 per cent points of the distribution of the variance-ratio,  $F = s_1^2/s_2^2$ , where the numerator and denominator have  $f_1$  and  $f_2$  degrees of freedom respectively. Thus if  $f_1 = 7$  and  $f_2 = 15$ , the probability that the observed value of  $F$  is greater than 2.71 is exactly 0.05 or 5 per cent.

## 1 per cent points

$f_2$	$f_1$														
	1	2	3	4	5	6	7	8	9	10	12	15	20	30	$\infty$
1	4052	4999	5403	5625	5764	5859	5928	5982	6022	6056	6106	6157	6209	6261	6366
2	98.50	99.00	99.17	99.25	99.30	99.33	99.36	99.37	99.39	99.40	99.42	99.43	99.45	99.47	99.50
3	34.12	30.82	29.46	28.71	28.24	27.91	27.67	27.49	27.35	27.23	27.05	26.87	26.69	26.50	26.13
4	21.20	18.00	16.69	15.98	15.52	15.21	14.98	14.80	14.66	14.55	14.37	14.20	14.02	13.84	13.46
5	16.26	13.27	12.06	11.39	10.97	10.67	10.46	10.29	10.16	10.05	9.89	9.72	9.55	9.38	9.02
6	13.75	10.92	9.78	9.15	8.75	8.47	8.26	8.10	7.98	7.87	7.72	7.56	7.40	7.23	6.88
7	12.25	9.55	8.45	7.85	7.46	7.19	6.99	6.84	6.72	6.62	6.47	6.31	6.16	5.99	5.65
8	11.26	8.65	7.59	7.01	6.63	6.37	6.18	6.03	5.91	5.81	5.67	5.52	5.36	5.20	4.86
9	10.56	8.02	6.99	6.42	6.06	5.80	5.61	5.47	5.35	5.26	5.11	4.96	4.81	4.65	4.31
10	10.04	7.56	6.55	5.99	5.64	5.39	5.20	5.06	4.94	4.85	4.71	4.56	4.41	4.25	3.91
11	9.65	7.21	6.22	5.67	5.32	5.07	4.89	4.74	4.63	4.54	4.40	4.25	4.10	3.94	3.60
12	9.33	6.93	5.95	5.41	5.06	4.82	4.64	4.50	4.39	4.30	4.16	4.01	3.86	3.70	3.36
13	9.07	6.70	5.74	5.21	4.86	4.62	4.44	4.30	4.19	4.10	3.96	3.82	3.66	3.51	3.17
14	8.86	6.51	5.56	5.04	4.69	4.46	4.28	4.14	4.03	3.94	3.80	3.66	3.51	3.35	3.00
15	8.68	6.36	5.42	4.89	4.56	4.32	4.14	4.00	3.89	3.80	3.67	3.52	3.37	3.21	2.87
16	8.53	6.23	5.29	4.77	4.44	4.20	4.03	3.89	3.78	3.69	3.55	3.41	3.26	3.10	2.75
17	8.40	6.11	5.18	4.67	4.34	4.10	3.93	3.79	3.68	3.59	3.46	3.31	3.16	3.00	2.65
18	8.29	6.01	5.09	4.58	4.25	4.01	3.84	3.71	3.60	3.51	3.37	3.23	3.08	2.92	2.57
19	8.18	5.93	5.01	4.50	4.17	3.94	3.77	3.63	3.52	3.43	3.30	3.15	3.00	2.84	2.49
20	8.10	5.85	4.94	4.43	4.10	3.87	3.70	3.56	3.46	3.37	3.23	3.09	2.94	2.78	2.42
21	8.02	5.78	4.87	4.37	4.04	3.81	3.64	3.51	3.40	3.31	3.17	3.03	2.88	2.72	2.36
22	7.95	5.72	4.82	4.31	3.99	3.76	3.59	3.45	3.35	3.26	3.12	2.98	2.83	2.67	2.31
23	7.88	5.66	4.76	4.26	3.94	3.71	3.54	3.41	3.30	3.21	3.07	2.93	2.78	2.62	2.26
24	7.82	5.61	4.72	4.22	3.90	3.67	3.50	3.36	3.26	3.17	3.03	2.89	2.74	2.58	2.21
25	7.77	5.57	4.68	4.18	3.85	3.63	3.46	3.32	3.22	3.13	2.99	2.85	2.70	2.54	2.17
26	7.72	5.53	4.64	4.14	3.82	3.59	3.42	3.29	3.18	3.09	2.96	2.81	2.66	2.50	2.13
27	7.68	5.49	4.60	4.11	3.78	3.56	3.39	3.26	3.15	3.06	2.93	2.78	2.63	2.47	2.10
28	7.64	5.45	4.57	4.07	3.75	3.53	3.36	3.23	3.12	3.03	2.90	2.75	2.60	2.44	2.06
29	7.60	5.42	4.54	4.04	3.73	3.50	3.33	3.20	3.09	3.00	2.87	2.73	2.57	2.41	2.03
30	7.56	5.39	4.51	4.02	3.70	3.47	3.30	3.17	3.07	2.98	2.84	2.70	2.55	2.39	2.01
40	7.31	5.18	4.31	3.83	3.51	3.29	3.12	2.99	2.89	2.80	2.66	2.52	2.37	2.20	1.80
60	7.08	4.98	4.13	3.65	3.34	3.12	2.95	2.82	2.72	2.63	2.50	2.35	2.20	2.03	1.60
120	6.85	4.79	3.95	3.48	3.17	2.96	2.79	2.66	2.56	2.47	2.34	2.19	2.03	1.86	1.38
$\infty$	6.63	4.61	3.78	3.32	3.02	2.80	2.64	2.51	2.41	2.32	2.18	2.04	1.88	1.70	1.00

The table gives the 1 per cent points of the distribution of the variance-ratio,  $F = s_1^2/s_2^2$ , where the numerator and denominator have  $f_1$  and  $f_2$  degrees of freedom respectively. Thus if  $f_1 = 7$  and  $f_2 = 15$ , the probability that the observed value of  $F$  is **greater** than 4.14 is exactly 0.01 or 1 per cent.



# Appendix XXIV

## Risk analysis

**Risk analysis** is a formal procedure for estimating the likelihood and consequences of adverse effects occurring in a specific population, taking into consideration exposure to potential hazards and the nature of their effects. This includes the management (usually reduction) of the likelihood of exposure. It is used widely in finance (e.g., to control either an individual's or a company's chances of losing on an investment), environmental science (e.g., to estimate hazards associated with contaminants or other environmental conditions, as they affect exposed humans, animals, or selected elements of an ecosystem) and engineering (e.g., to study the safety of nuclear reactors).

The impetus for risk analysis was global industrialization, which accelerated after World War II, presenting new hazards (e.g., novel synthetic isotopes) with which society was unfamiliar (Rowe, 1977). New anxieties associated with man-made risks were rapidly disseminated via the media, and created perceptions that some risks were unacceptably high, resulting in confrontations in the courts, referenda and regulation. There was a need to address these problems (including the more subjective issue of how risks are deemed to be acceptable or unacceptable) in a regular and consistent manner. Formal risk analysis consequently emerged in the nuclear and chemical industries in the 1960s and 1970s, respectively<sup>1</sup>. The need to understand and communicate what risks signify was realized in the 1980s, but remains the least appreciated component of risk analysis.

---

<sup>1</sup> Awareness of risk, however, is much older. The Biblical dietary laws of the Pentateuch are considered by some (Townley, 1827), but not all (Milgrom, 1992), scholars to be the earliest documented example of a risk analysis, designed to improve food hygiene.

### Definition of risk

There is no single definition of risk (*Table 1*). Risk has two components: the **likelihood** of an event occurring, and the **severity** (i.e., impact, magnitude or seriousness) of the consequences of the event. The latter may range from relatively mild (e.g., most cases of staphylococcal food poisoning) to catastrophic (e.g., a nuclear accident or a tsunami).

Qualitative descriptions commonly rank risk as 'very low', 'low', 'medium' or 'high'<sup>2</sup>. Alternatively, risk may be characterized as 'negligible' (generally assumed to be 'below very low') or 'non-negligible'. Descriptions with elements combined from each of these schemes may also be used.

A quantitative description often focuses on likelihood expressed as the **probability** (see Chapter 12) of an event (exposure to a hazard) occurring over a specified period of time (hence the use of 'risk' as a synonym for cumulative incidence; see Chapter 4). This probabilistic notion of risk (also sometimes described as 'objective' or 'real' risk) is found in risk analysis in engineering, toxicology and actuarial studies (Renn, 1992), and constitutes a 'physical, technical' conception of risk, in contrast to social outlooks (Bradbury, 1989)<sup>3</sup>.

---

<sup>2</sup> This implicitly accepts that in most contexts 'zero risk' is extremely difficult, if not impossible, to achieve (Nakayachi, 1998), although the notion is very attractive to the general public (Tversky and Kahneman, 1981), as material comfort and individualism in western societies appear to have increased sensitivity to risk.

<sup>3</sup> It follows that, in pursuing the probabilistic notion, decisions on how to respond to risk are determined by 'technical' (i.e., scientific) evidence, which may become central to regulatory mechanisms (the 'technocratic model', Weingart, 1999), rather than being subordinate to political considerations (the 'Weberian decisionist mode', Weber, 1958).

**Table 1** Some terms used in risk analysis.

<i>Term</i>	<i>Definition/description</i>	<i>Source</i>	
Acceptable risk	Risk level judged by <i>OIE</i> Member Countries to be comparable with the protection of animal and public health within their country	Murray <i>et al.</i> (2004c)	
Average (of 'likelihood')	The usual amount, extent, rate	<i>Oxford English Dictionary</i> (1971)	
Critical control point	A location, practice, procedure or process at which control can be exercised over one or more factors, which, if controlled, could minimize or prevent a hazard	Gracey <i>et al.</i> (1999)	
Extremely (of 'likelihood')	Outermost; furthest from the centre; situated at either end; the highest or most extreme degree of anything	<i>Oxford English Dictionary</i> (1971)	
Hazard	A situation that could occur during the lifetime of a product, system or plant that has the potential for human [ <i>or animal</i> ] injury, damage to property, damage to the environment, or economic loss	The Royal Society (1992)	
High (of 'likelihood')	Extending above the normal or average level	<i>Oxford English Dictionary</i> (1971)	
Insignificant (of 'likelihood')	Unimportant, trifling ( <i>c.f.</i> 'significant')	<i>Oxford English Dictionary</i> (1971)	
Likelihood	Probability; the state or fact of being likely <sup>†</sup>	<i>Oxford English Dictionary</i> (1971)	
Likely	Probable; such as might well happen or be true; to be reasonably expected	OIE (2004)	
Low (of 'likelihood')	Less than average, coming below the normal level	<i>Oxford English Dictionary</i> (1971)	
Negligible (of 'likelihood')	That need not be considered	<i>Oxford English Dictionary</i> (1971)	
	Insignificant ( <i>c.f.</i> 'significant')	<i>Oxford English Dictionary</i> (1971)	
Remote	Slight, faint	<i>Oxford English Dictionary</i> (1971)	
Risk	A function of the probability of an adverse health effect and the severity of that effect, consequential to a hazard	The Royal Society (1992)	
	The amalgam of the probability of an event occurring and the seriousness of the event's consequences	Cameron and Wade-Gery (1995)	
	The probability that an event will occur and the seriousness of that event for the environment and human [ <i>and animal</i> ] health	CEPS (2002)	
	The potential for realization of unwanted, negative consequences of an event	Rowe (1977)	
Risk analysis	A process consisting of three components: risk assessment, risk management and risk communication	Codex Alimentarius Commission (1999)	
Risk assessment	A scientifically based process consisting of the following steps: (i) hazard identification, (ii) hazard characterization, (iii) exposure assessment and (iv) risk characterization	Codex Alimentarius Commission (1999)	
	A tool for extrapolating from statistical and scientific data to arrive at a value which people will accept as an estimate of the risk attached to a particular activity or event	UKILGRA (1996)	
	Qualitative	A risk assessment based on data which, while forming an inadequate basis for numerical risk estimations, nonetheless, when conditioned by prior expert knowledge and identification of attendant uncertainties permits risk ranking or separation into descriptive categories of risk	Codex Alimentarius Commission (1999)
		An assessment where the outputs on the likelihood of the outcome or the magnitude of the consequences are expressed in qualitative terms such as high, medium, low or negligible	Murray <i>et al.</i> (2004c)
Quantitative	A risk assessment that provides numerical expressions of risk and indication of the attendant uncertainties	Codex Alimentarius Commission (1999)	

Table 1 (cont'd)

Term	Definition/description	Source
Risk characterization	The process of determining the qualitative and/or quantitative estimation, including attendant uncertainties, of the probability of occurrence and severity of known or potential adverse health effects in a given population based on hazard identification, hazard characterization and exposure assessment	Codex Alimentarius Commission (1999)
Risk communication	The interactive exchange of information and opinions concerning risk and risk management among risk assessors, risk managers, consumers and other interested parties	Codex Alimentarius Commission (1999)
Risk estimate	Output of risk characterization	Codex Alimentarius Commission (1999)
Risk management	The process of weighing policy alternatives in the light of the results of risk assessment and, if required, selecting and implementing appropriate control options, including regulatory measures	Murray (2002)
Safety	. . . a judgement of the acceptability of risk; a thing is safe if its risks are judged to be acceptable (see 'acceptable risk') (contrast with the usual dictionary definition of 'safe' as 'not exposed to danger')	Lowrance (1976)
Significant (of 'likelihood')	Noteworthy, important, consequential (c.f. 'insignificant')	Oxford English Dictionary (1971)
Uncertainty	The lack of precise knowledge of the input values which is due to measurement error or to lack of knowledge of the steps required, and the pathways from hazard to risk, when building the scenario being assessed	Murray et al. (2004c)
	An assessor's lack of knowledge (level of ignorance) about parameters that characterize the physical system that is being modelled (c.f. 'variability')	Vose (2000)
Variability	The fact or quality of being variable in some respect; tendency towards, capacity for, variation or change	Oxford English Dictionary (1971)
	A real-world complexity in which the value of an input is not the same for each case due to natural diversity in a given population	Murray et al. (2004c)
	A phenomenon in the physical world to be measured, analysed and where appropriate explained (c.f. 'uncertainty')	Cox, quoted by Vose (2000)

<sup>†</sup> This broad definition is relevant to the way in which the term is generally used in risk analysis. In formal statistics, 'likelihood' has a specific meaning (see Appendix I and Everitt, 1998).

Risk defines neither a current problem nor a future certainty. It is the potential for future harm. Thus, it can only be estimated, not measured (Gould *et al.*, 1988).

### Risk analysis and the 'precautionary principle'

The '**precautionary principle**' argues that if there is scientific uncertainty regarding a risk and its consequences (i.e., cause and effect relationships are not fully established) then preventive measures can be justified in the absence of proof of such a risk. The term emerged in Germany in the 1970s, and attained international credibility in the 1980s (Cameron and Wade-Gery, 1995). It has been cited mainly in the context of emerging perceived hazards, such as environmental pollution, genetically-modified foods and other food-safety hazards, where uncertainty remains (CEPS, 2002).

A precautionary approach has a useful protective role as an initial response to new potential threats. It may also be the only reaction to complex serious problems such as global warming and loss of 'biodi-

versity', where traditional, formal risk analysis is not (and, indeed, may never be) adequate<sup>4</sup>. A precautionary approach also may comfort politicians and the public, who are frequently slow to be reassured in the face of uncertainty. However, it tends towards inertia and tardiness in responding to new policy options, and can indefinitely mask political decisions (Starr, 2003)<sup>5</sup>. In contrast, risk analysis provides an

<sup>4</sup> However, a precautionary approach and a 'scientific' risk-based approach should not be viewed as being mutually exclusive: key elements of the former are consistent with responses to intractable issues in risk analysis, such as uncertainty (Stirling, 2001).

<sup>5</sup> Nevertheless, it has been applied as a very effective temporary trade barrier (e.g., the ban on the importation of British beef into France between 1996 and 2002, in relation to bovine spongiform encephalopathy), and its acceptance by the European Union (CEC, 2000) has led to disagreement between Europe and North America over trade in genetically-modified commodities, although it arguably has no basis in international law. It has also been formulated in international treaties and agreements, including the *Montreal Protocol on Substances that Deplete the Ozone Layer* (1987), the *Third North Sea Conference* (1990), the *Rio Declaration on Environment and Development* (1992), the *Framework Convention on Climate Change* (1992), the *Treaty on European Union (Maastricht Treaty)* (1992) and the *Cartagena Protocol on Biosafety* (2000) (Harremöes *et al.*, 2001).

operational framework for determining policy, using accruing knowledge<sup>6</sup>.

## Risk analysis in veterinary medicine

Risk analysis is now applied to a wide range of veterinary issues (Table 2). A major area is **import risk analysis**. Although diseases may occur at low levels and be adequately controlled (or eradicated), there may be a risk of importing them from other countries. Such a risk can only be eliminated completely if importation is totally prohibited. However, current political pressures in the world favour movement towards free trade<sup>7</sup>. Thus, the 'unquantified' risk of introduction of a disease cannot now be presented as a trade barrier, exemplified by concerns that the liberalization of trade under the *General Agreement on Tariff and Trade* (and the resultant *World Trade Organization (WTO)*) may be associated with countries applying domestic standards that are less stringent than those applied to imported goods, thereby restricting trade (Scudamore, 1995).

Additionally, it may be untenable to adopt a 'zero-risk' approach. For example, it is unrealistic to aim for absence of pathogens in livestock, and so effective control of food-borne pathogens must be tackled by identification of those animals that pose a risk, management of the risk at critical stages in the production process, and hygiene (Kühne and Lhafi, 2005).

Animal-health risk analysis therefore has evolved to assess as objectively as possible the risks associated with particular diseases, rather than only relying on the somewhat subjective judgements of individual scientists or parties (Morley, 1993; Murray *et al.*, 2004c,d). (This squares well with the probabilistic, 'technical' notion of risk.) All aspects of international animal disease control policy are now based on risk analysis, which has therefore become a routine veterinary procedure.

Veterinary risk analyses frequently report risk in terms of likelihood, but exclude severity from the assessment. This is often because severity may be very difficult to assess (see later: 'What level of risk is acceptable?').

<sup>6</sup> Thus, precautionary quarantine became the standard method of preventing the entry of rabies into the UK early in the 20th century, when little was known of the disease's cause and vaccines were not available. However, increased knowledge of the natural history of rabies, and the development of vaccines, facilitated risk analyses (MAFF, 1998; Dye, 1999) leading to the 'PETS' travel scheme (see Chapter 22), which allows vaccinated dogs and cats to enter the UK without the lengthy restriction of quarantine.

<sup>7</sup> See Irwin (1996) for a discussion of the case for free trade. The issue dates back to the 18th century, with the publication of Adam Smith's '*... Wealth of Nations*' (Smith, 1776), but is not without its problems (Stiglitz, 2006).

## Components of risk analysis

The three main components of risk analysis are **risk assessment**, **risk management** and **risk communication** (Figure 1). These are preceded by definition of the **risk question** (i.e., the issue to be addressed).

### Risk assessment

Risk assessment comprises five steps:

1. hazard identification;
2. hazard characterization;
3. release assessment;
4. exposure assessment;
5. risk characterization.

It should involve comprehensive scrutiny of the relevant literature, and may include formal meta-analysis (see Chapter 16), as well as eliciting expert opinion.

**Hazard identification** is simply the definition of hazards (e.g., a pathogen). This may occasionally be eased by published information (e.g., the list of diseases to be notified to *Office International des Epizooties*), but frequently requires scrutiny of literature, and discussion with experts and those potentially affected by the hazards (e.g., the hazards associated with handling and consumption of wild game, which are discussed below).

**Hazard characterization** is the qualitative or quantitative evaluation of the nature of the adverse health effects associated with hazards. For chemical agents, a dose-response assessment should be performed. For biological or physical agents, a dose-response assessment should be undertaken if the data are obtainable.

**Release assessment** is the determination of the likelihood of a commodity (e.g., an imported animal) being contaminated or infected with hazards, and description of the pathways by which the hazards can be introduced into the environment. The survival of organisms is also an important component of microbial release assessment. A **scenario tree**, graphically portraying the release pathways (e.g., Figure 2), is often constructed.

**Exposure assessment** is the estimation (qualitatively or quantitatively) of the magnitude, frequency, duration and route of exposure of humans or animals to hazards. The assessment should also describe the size and nature of the exposed population. An assessment of the risk associated with the unrestricted importation of animals or animal products, for example, would consider the prevalence of pathogens in the source population, the probability of the pathogens surviving during importation, and the probability of

**Table 2** Some veterinary and associated risk analyses.

Topic	Source
Animal-health risks associated with wildlife products	Bengis (1997)
Antimicrobial resistance originating in food animals	Kelly <i>et al.</i> (2004); Snary <i>et al.</i> (2004); Bartholomew <i>et al.</i> (2005)
Biosecurity risks associated with imported livestock testing serologically-positive in quarantine	Pharo (1999)
<i>Campylobacter</i> spp. infection of humans from consumption of poultry	Rosenquist <i>et al.</i> (2003); Nørrung (2006)
Disease transmission by artificial insemination and embryo transfer	MacDiarmid (1993); Suttmoller and Wrathall (1995, 1997); Eaglesome and Garcia (1997); Wrathall (1997)
Exposure of the public to bovine spongiform encephalopathy from beef-on-the-bone	Comer and Huntley (2004)
Exposure of the public to bovine spongiform encephalopathy from burial and burning of cattle infected with foot-and-mouth disease	Comer and Huntley (2003)
Exposure of the public to bovine spongiform encephalopathy from drinking water potentially contaminated by rendering-plant effluent	Gale <i>et al.</i> (1998)
Importation of brucellosis into GB via breeding cattle	Jones <i>et al.</i> (2004b)
Importation of animal diseases via live animals and animal products	Morley (1993a)
Importation of exotic infectious diseases in smuggled meat	Wooldridge <i>et al.</i> (2006)
Importation of foot-and-mouth disease in South American beef	Astudillo <i>et al.</i> (1997)
Importation of foot-and-mouth disease into Australia in animal feed	Doyle (1995)
Importation of foot-and-mouth disease into Australia in milk products	Heng and Wilson (1993)
Importation of foot-and-mouth disease into New Zealand in passenger luggage	Pharo (2002a)
Importation of foot-and-mouth disease into the UK from South Africa	DEFRA (2003a)
Importation of rabies into GB	MAFF (1998); Dye (1999); Laurenson <i>et al.</i> (2002); Jones <i>et al.</i> (2002, 2005); Kosmider <i>et al.</i> 2006)
Importation of rabies into New Zealand	MacDiarmid and Corrin (1998)
Introduction of exotic animal diseases into the US via cruise-ship waste	McElvaine <i>et al.</i> (1993)
Introduction of exotic diseases of fish into New Zealand via imported salmon	MacDiarmid (1994)
Introduction of exotic diseases of pigs via uncooked swill	Corso (1997); Horst <i>et al.</i> (1997)
Introduction of infectious bursal disease virus and Newcastle disease virus in chicken meat	MAF (2000)
Introduction of Newcastle disease virus in hatching eggs	Pharo (2001)
Lyme disease in relation to vector habitat	Guerra <i>et al.</i> (2002)
Microbial contamination of beef carcasses	Jordan <i>et al.</i> (1999); Mellor <i>et al.</i> (2004)
Microbial contamination in poultry production and processing	Kelly <i>et al.</i> (2003); Cox <i>et al.</i> (2005); Kelly (2005)
New outbreaks of foot-and-mouth disease associated with burning pyres	Jones <i>et al.</i> (2004a)
New outbreaks of foot-and-mouth disease associated with public access to footpaths during a foot-and-mouth disease epidemic	Taylor (2002)
Potential for bovine spongiform encephalopathy in the US	Cohen <i>et al.</i> (2001)
Potential animal-health risks from imported sheep and goat meat	MacDiarmid and Thompson (1997); Rapoport and Shimshony (1997)
Public health and animal health risks associated with highly pathogenic avian influenza viruses in Europe	DEFRA (2005); EFSA (2005); Mettenleiter (2005); ECDC (2006)
Residues in poultry and eggs	Donoghue (2005)
Risk of foot-and-mouth disease associated with faulty vaccine production	Cané <i>et al.</i> (1995)
Risks and hazards associated with the handling and consumption of game birds	Coburn <i>et al.</i> (2005)
<i>Salmonella</i> spp. infection of humans from consumption of eggs and broiler chickens	FAO/WHO (2002)
Swabbing techniques for the detection of <i>Taylorella equigenitalis</i> (the cause of contagious equine metritis)	Wood <i>et al.</i> (2005)
Transmission of bovine spongiform encephalopathy to humans and cattle through the application of sewage sludge to agricultural land	Gale and Stanfield (2001)
Transmission of bovine tuberculosis from badgers to cattle	Gallagher <i>et al.</i> (2003)
Transmission of foot-and-mouth disease in milk and dairy products	Donaldson (1997)
Transmission of shrimp viruses via live and frozen shrimp	Lightner <i>et al.</i> (1997)
Transmission of zoonoses during taxidermy	Thrusfield (2006)

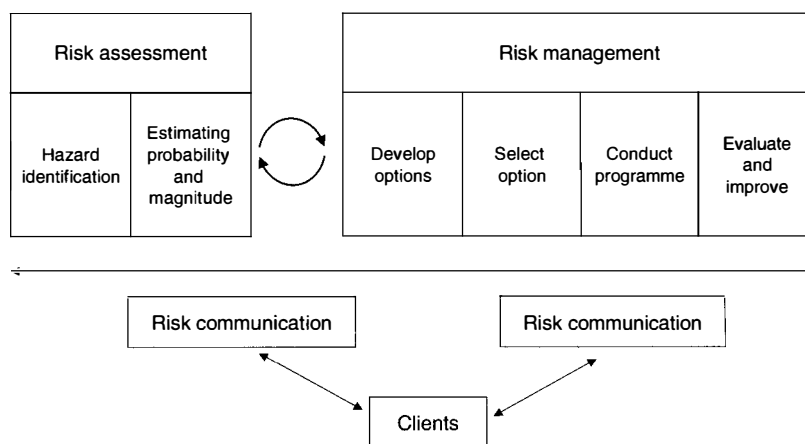

**Fig. 1** The components of risk analysis. (From *OIE Scientific and Technical Review*, Vol. 12(4), December 1993, reproduced with permission.)

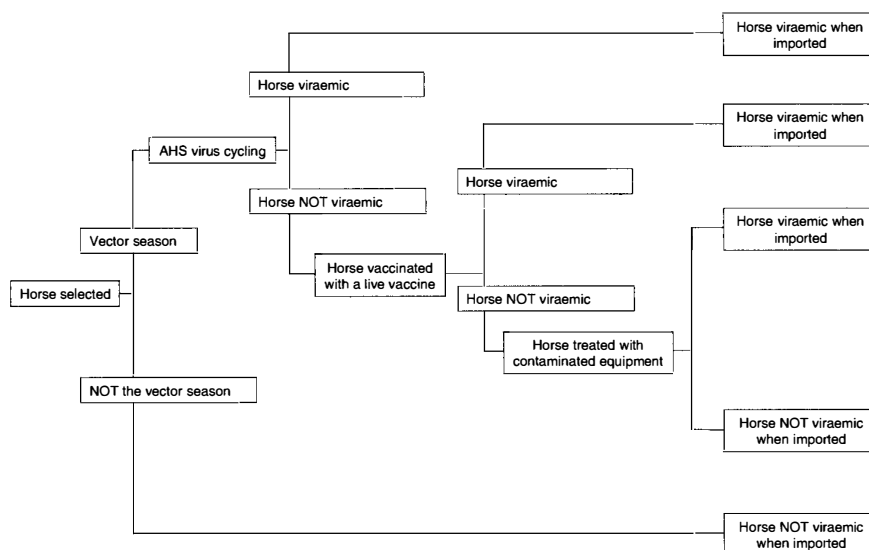

**Fig. 2** Example of a scenario tree for a release assessment: the biological pathways necessary for a horse to become infected with, and harbour, African horse sickness (AHS) virus when imported. (From Murray, 2002.)

the pathogens coming into contact with local livestock after importation. Examples include the risk of introducing maedi-visna and scrapie into New Zealand (MacDiarmid, 1993). The route of exposure can be presented graphically in an **exposure pathway**. This is a very good starting point for a risk analysis, following hazard identification and definition of the risk question.

**Risk characterization** is a description of the nature and magnitude of risk, either to health or the environment. The description combines results of hazard identification, hazard characterization, release assessment and exposure assessment. In a quantitative analysis, it includes the probability and severity of the predicted risk.

### Variability and uncertainty

The risk assessment procedure is accompanied by two characteristics: **variability** and **uncertainty** (Table 1). The former is the inherent variation in biological systems, which can be managed by standard statistical procedures such as the use of distributions (see

Chapter 12). The latter, in contrast, indicates ignorance (e.g., lack of knowledge of the disease status of a country). Variability will exist, even if there is complete knowledge (e.g., it may be known that disease is present in a country, but the prevalence may be based on a sample survey, giving rise to a point estimate and a confidence interval for the prevalence). Thus, uncertainty may be reduced with time as more data are collected and more research is completed. In contrast, variability cannot be reduced by further study because it expresses the inherent variability of a system.

Variability is sometimes termed 'stochastic uncertainty' or 'aleatory uncertainty'<sup>8</sup>, whereas uncertainty, as defined above, is termed 'epistemic uncertainty'. The combination of variability and uncertainty is termed 'total uncertainty' or 'indeterminability' (Vose, 2000).

Risk characterization must include an indication of variability and uncertainty.

<sup>8</sup> Aleatory = 'depending on the throw of a dice' (Latin: *aleator* = 'dice player').

Likelihood	High	Non pathogenic <i>Escherichia coli</i> Some endoparasites	Endoparasites	Ectoparasites of farmed fish (e.g., sea lice)	Bluetongue
	Medium			Introduction of anthelmintic-resistant strains of helminths	
	Low	Exotic strains of non-pathogenic organisms		Introduction of equine viral arteritis in horses due to movement of horses from the continent	Widespread dissemination of foot-and-mouth disease with new measures (e.g., 'standstill' procedures*) in place
	Very low				Introduction of rinderpest
		Very low	Low	Medium	High
		Severity			

**Fig. 3** Example of a risk matrix: exposure to some animal diseases in the UK. Darker shading indicates higher levels of risk.  
\* 'Standstill' requirements direct that, when livestock are moved onto a farm, a minimum period of time must lapse before any livestock can leave the farm.

### Subjectivity

A degree of **subjectivity** is also attached to both qualitative and quantitative assessments (Redmill, 2002). The questions to be asked in risk analysis involve judgement, which is subjective (Kasper, 1980). If data are sparse, expert opinion may be sought (either individually, or by a formal Delphi Conference; see Chapter 19 and Van Der Fels-Klerx *et al.*, 2002). In some cases, the opinion may be little more than a guess (e.g., the cattle-to-human species barrier of bovine spongiform encephalopathy: Comer and Huntley, 2004)<sup>9</sup>. Consequently, the results obtained by one risk analyst are unlikely to be obtained by others.

<sup>9</sup> The consequences of selecting the wrong opinion can be disastrous. For example, following the tragedy of the space shuttle, *Challenger*, in 1986, Feynman (1988) noted that organizational decision-making was conducted as though the *National Aeronautics and Space Administration's* management's estimate of a shuttle failure (1 in 100 000 – equivalent to a daily launch with an average of 300 years between accidents) was accurate, whereas an engineer's estimate was, more realistically, as low as 1 in 100. A subsequent quantitative risk analysis identified the weaknesses in the booster-rocket seal performance, which was responsible for the accident (Dalal *et al.*, 1989).

Risk analyses, therefore, should always be fully **documented**, including details of analytical methods, the data that are used, assumptions and references<sup>10</sup>. Finally, they should be subjected to independent **peer review**<sup>11</sup>.

### Risk management

**Risk management** is the selection of the options for controlling risks, taking into account social values, legal requirements and costs of control. It is not about future decisions, but about the future of decisions that must be taken now; that is, about speculative or uncertain aspects of the outcomes of decisions (Charette, 1989).

Management can be prioritized by construction of a **risk matrix**, which ranks risks according to their two components: likelihood and severity of consequences (Donoghue, 2001). *Figure 3* illustrates the technique for

<sup>10</sup> Comprehensive documentation enables all aspects of the analysis to be scrutinized. This is termed '**transparency**' (from 'transparent' = 'easily seen through'; Latin: *transparens* = 'shine through').

<sup>11</sup> Peer review of a quantitative analysis should include not only examination of input parameters but also deconstruction of the model so that its structure is revealed.

exposure to some animal diseases in the UK. Note that risks associated with some hazards (e.g., foot-and-mouth disease and rinderpest) may be ranked relatively high although likelihood is low; this is because of the severity of the consequences of exposure to these hazards. The construction of risk matrices is assisted by appropriate software (*Risk Matrix*: see Appendix III and Lansdowne, 1999).

**Hazard Analysis Critical Control Point**

**Hazard Analysis Critical Control Point (HACCP)** is a procedure for identifying, evaluating and controlling hazards associated with particular stages in a process. Control occurs by action at key stages in a process – the **critical control points (CCPs)**. Hazard Analysis Critical Control Point is therefore an important risk-management tool. It was initially developed in the 1960s for the US’s *National Aeronautics and Space Administration* to ensure safe food for the first manned space missions<sup>12</sup>. It is now an internationally recognized technique for ensuring food safety (Brown, 2000); impetus for its adoption in the UK, for example, followed an outbreak of food poisoning due to *Escherichia coli* 0157 in the 1990s (Stationery Office, 1997).

The stages of HACCP are:

- identify the **hazards** that must be prevented, eliminated or controlled;
- identify the **CCPs**;
- establish the **critical limits** (measurable target levels (e.g., temperature, pH) that indicate that a product is at risk from an identified hazard) at the CCPs; each CCP must have at least one critical limit;
- **monitor** procedures to ensure that each CCP is under control;
- establish any **corrective actions** that are required;
- confirm that the HACCP plan is effective (**validation**);
- confirm that the HACCP plan is being followed (**verification**);
- **document** the procedure with an effective record-keeping system.

The CCPs can be subdivided (Gracey *et al.*, 1999) thus:

- CCP1: where hazards can be prevented or eliminated;
  - CCP2: where hazards can be minimized, reduced or delayed;
- alternatively:
- CCPe: where hazards are eliminated and no further problem exists;

- CCPp: where hazards are prevented but not necessarily eliminated;
- CCPr: where hazards are significantly reduced, minimized or delayed.

If HACCP is applied before and during slaughter of red-meat animals, for instance, hazards would include bacterial contamination of raw meat (biological hazards), contamination by disinfectants and cleansing agents (chemical hazards), and metal, glass, plastic, bone splinters and string (physical hazards). Critical control points would include dirty animals, hide removal, evisceration, chill and storage, despatch and transport, and scalding (Figure 4). Thus, at the stage of evisceration, contamination of carcasses by food-poisoning bacteria (e.g., *Salmonella* spp.) can occur due to rupturing of the stomach and intestines, and control involves sealing of the oesophagus and rectum to minimize spillage. Likewise, during the receipt, storage, cutting and transport of poultry meat, growth of *Salmonella* spp. may occur due to inadequate temperature regulation; the control measure therefore involves keeping poultry meat at 4°C or below.

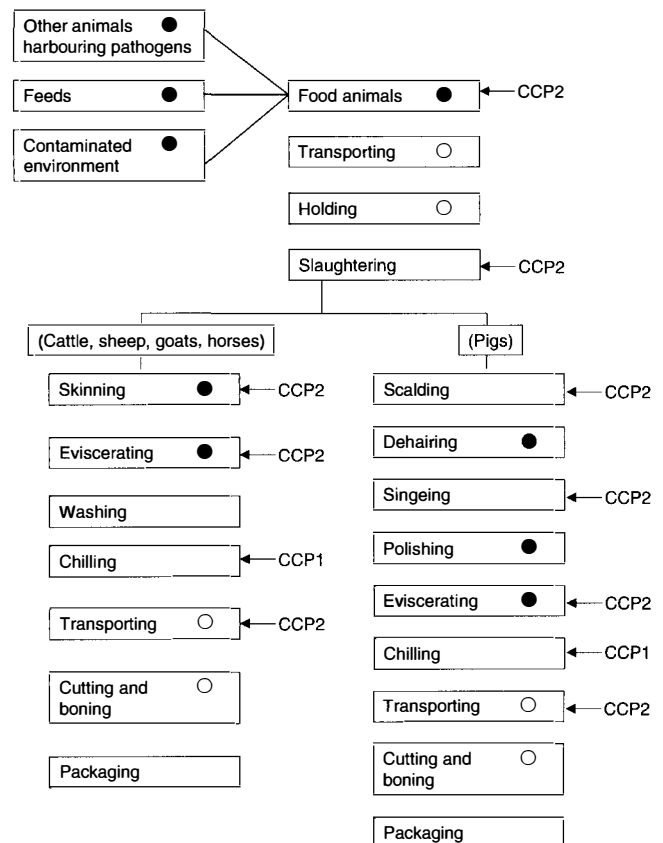

**Fig. 4** Sources of contamination and critical control points before and during slaughter and processing of red-meat animals. ○ : site of minor contamination; ● : site of major contamination; CCP1 : effective; CCP2 : effect not absolute (see text). (Expanded and reprinted from Gracey, J.F., Collins, D.S. and Huey, R.J. *Meat Hygiene*, 10th edn, Copyright © (1999), with permission from Elsevier.)

<sup>12</sup> Its antecedent was the 'Prescott-Meyer-Wilson strategy', which was developed in the UK and US in the 1930s, and was aimed at taking preventive and remedial measures, rather than merely examining samples of the final product (Mossel, 1989).



**Table 3** Application of HACCP to the control of bovine mastitis. (Based on, and expanded from, Cullor, 1995.)

Hazards	Critical control points	Action	Critical limits
Mastitis-inducing organisms on or in the udder	Calving pen	Changing of bedding, and disinfection of pens at appropriate periods	
	Drying-off	Apply five-point plan (see Chapter 21)	Liner-use limits: 2500 milkings/six months
	Milking parlour	Apply five-point plan (see Chapter 21), plus pre-milking dipping/spraying	Milking-machine standards: 14"–16" mercury (high milk lines); 12.5"–13.5" mercury (low milk lines)  Milk:rest ratio between 40:60 and 60:40

Figure 4 also indicates that contamination of animals from feeds, the environment and other animals can occur during production. Thus, emphasis is now being placed on food-safety assurance during this so-called 'pre-harvest' stage (Smulders and Collins, 2002). The HACCP approach can be applied on the farm to improve hygiene in an attempt to reduce contamination by chemicals, microorganisms and parasites (Edwards, 2002), and is therefore relevant to the 'paddock to plate' approach to food quality (see Chapter 1). Microbial risk assessment, which estimates the magnitude of microbial exposure at various stages of the production chain, has already been outlined (see Chapter 2). Additionally, the international use of HACCP by food manufacturers has a role in standardizing international food-safety regulations and in reducing trade barriers arising from food safety (Caswell and Hooker, 1996).

Hazard Analysis Critical Control Point procedures can also be applied to veterinary preventive medicine more generally. Table 3 presents a basic HACCP programme for the control of mastitis in dairy herds. Several microorganisms constitute the hazards, and risk is managed at three critical control points (in the calving pen, at drying off, and in the milking parlour), reflecting the multifactorial nature of the disease. Noordhuizen and Frankena (1999) and Johnston (2000) discuss the use of HACCP on the farm.

The elegance of HACCP lies in the known reduction of risk at the critical control points. Risk can only rise subsequently through external contamination of the process.

## Risk communication

**Risk communication** is concerned with disseminating information about the hazards and risks to all interested parties (e.g., livestock owners, the general public and politicians) and encouraging dialogue between them. Risk communication is particularly important because the perception of risk by risk analysts is often different from that of the general public. The former

may argue that risk should be determined objectively by the 'data alone', whereas the latter may 'irrationally' colour their perception of risk by subjective factors (Schrader-Frechette, 1991)<sup>13</sup>. Collectively termed '**outrage factors**' (Sandman, 1987), these include '**dread**' (e.g., AIDS and cancer may be perceived as more serious risks than emphysema, although all may be lethal), the '**involuntary**' nature of the risk (involuntary exposure to a risk is viewed more seriously than if an individual has control over exposure) and '**familiarity**': 'exotic' risks tend to provoke outrage more than familiar ones (e.g., ingestion of meat potentially infected with the bovine spongiform encephalopathy prion, compared with electrocution by faulty electrical appliances in the home: Setbon *et al.*, 2005). Thus, the public's concern over the risk of importation of rabies into the UK may be excessive in terms of the actual risk (MAFF, 1998), and reaction to the risk of Ebola haemorrhagic fever infection appears to be unjustified (Sokol, 2002).

'Outrage factors' are not distortions of the public's perception of risk, they are intrinsic parts of what risk means. They may be intensified by extensive media coverage, strong public concerns and institutional attention, resulting in '**socially amplified risks**' (Kasperson *et al.*, 2001) – bovine spongiform encephalopathy is a good example. Since society generally reacts more to outrage than 'mere hazard', an important part of risk communication is to make serious hazards 'more outrageous', and modest hazards less so. Gruesome graphic government campaigns highlighting the dangers associated with driving under the influence of alcohol or drugs are examples of increasing outrage. The extent to which the public accepts risks is clearly related to the degree of outrage<sup>14</sup>.

<sup>13</sup> For a discussion of the psychology of risk evaluation by the layman, and the set of judgemental rules (heuristics) that are employed, see Kahneman *et al.* (1982) and Gilovich *et al.* (2002). Heuristics make assessments or judgements of probability simpler, but can lead to serious biases.

<sup>14</sup> See Bedford and Cooke (2001) for the criteria by which the public judges the acceptability of various risks.

Risk communication should not be an afterthought (Covello *et al.*, 2001). Consideration of communication of the results of a risk assessment is essential in both defining the hazard and the risk question, as well as formulating the approach to the whole risk analysis. Otherwise, the exercise may be nugatory.

## Qualitative or quantitative assessment?

There may be a temptation in contemporary society – where a degree of intellectual superiority is often attached to numerical outputs – to assume that a quantitative assessment is ‘better’ than a qualitative one<sup>15</sup>. However, qualitative assessment is appropriate for the majority of risk assessments, and is the commonest type of assessment to support routine decisions. As such, it is ‘... a reasoned and logical discussion of ... a hazard where the likelihood of its release and exposure, and magnitude of its consequences are expressed using non-numerical terms such as high, medium, low or negligible’ (Murray, 2002). Quantification may be required to explore a problem more fully and to compare control measures (e.g., removal strategies relating to test-positive imported animals, Table 17.23). This involves the construction of a mathematical model, with the attendant difficulties of the quality and availability of data, choice of appropriate statistical distributions, assumptions and validation (see Chapter 19). Such models may not yield to easy interpretation, noting that ‘... mathematicized theory in science is rarely so pellucid or so rigorous that its significance and bearing can be grasped immediately by distant readers’ (Porter, 1995). Consequently, quantitative assessments may not stand up well in an adversarial climate.

## Semi-quantitative risk assessment

**Semi-quantitative risk assessment** usually involves assigning numerical (or non-numerical) scores to qualitative estimates, thereby generating ordinal data (see Chapter 9). For example, an on-farm risk assessment evaluating the risk of Johne’s disease might include scores for particular management practices, thus (VTCHIP, 2003):

multiple animal use in the calving areas: 0 = never;  
3 = rarely; 5 = occasionally; 7 = frequently; 10 = always;

manure build up in the calving areas: 0 = none;  
3 = minimal; 5 = moderate; 7 = considerable;  
10 = extensive.

This avenue is often followed because of concerns over the subjectivity of a purely qualitative approach and the aforementioned perception that numbers are ‘better’. However, the weightings attached to scores are usually arbitrary and therefore subjective. Semi-quantitative assessments therefore provide an illusion of objectivity and precision that is unwarranted. This may be acceptable if the aim is to prioritize risks in a non-contentious context (e.g., the on-farm risk of Johne’s disease, outlined above), but offers no advantage over qualitative assessments in determining realistic estimates of risk, especially in controversial matters. Thus, semi-quantitative methods, by augmenting qualitative assessments with a quantitative dimension, add superfluous complexity. Murray (2002) concludes that the best ‘antidote’ for ‘too much subjectivity’ is thorough documentation and peer review of qualitative assessments.

The term ‘semi-quantitative’ also applies to quantitative assessment of parts of a process; notably, when the detail (of both data and mechanisms) is known for only small parts of the exposure pathway (e.g., time/temperature inactivation curves for microbes), which may therefore be modelled quantitatively. This is of value in identifying and confirming critical control points.

## Qualitative risk analysis

### Framework for qualitative risk assessment

#### Example of a qualitative risk assessment: hazards and risks posed by wild game

The framework for a qualitative risk assessment is best demonstrated by an example: hazards and risks posed by wild game, which is detailed by Coburn *et al.* (2003) and summarized by Coburn *et al.* (2005).

**Risk question** The risk question, to be answered qualitatively, was: ‘Under current UK law, what is the risk to human health (particularly of human infection with a food borne pathogen) from handling/consumption of wild game meat and how would the currently proposed European Union hygiene proposals affect the risk?’.

**Hazard identification** A search of the literature and expert opinion indicated that the relevant hazards were *Escherichia coli* 0157, *Salmonella* spp., *Campylobacter jejuni*, *Chlamydothyla psittaci*, *Mycobacterium avium*, *Clostridium botulinum*, lead shot, *Mycobacterium bovis* and *Yersinia pseudotuberculosis*. The relevant wild game comprised game birds, wild ducks, wild deer and wild lagomorphs, the particular species to be included being based on the number shot (e.g., pheasant were

<sup>15</sup> Recall that ‘... all numbers pose as true’ (Chapter 1).

**Table 4** Hazards considered for wild game species in a qualitative risk assessment. (From Coburn *et al.*, 2005.)

Hazard	Wild game species
<i>Escherichia coli</i> 0157	All
<i>Salmonella</i> spp.	All
<i>Campylobacter jejuni</i>	All
<i>Mycobacterium avium</i>	Game birds, wild ducks, wild deer
<i>Chlamydomphila psittaci</i>	Game birds
<i>Clostridium botulinum</i>	Wild ducks
<i>Mycobacterium bovis</i>	Wild deer
<i>Yersinia pseudotuberculosis</i>	Wild lagomorphs
Lead shot	Game birds, wild ducks, wild lagomorphs

included, but capercaillie and ptarmigan were not). Table 4 lists these in relation to the hazards.

**Hazard characterization** Hazard characterization included investigation of the infectivity of organisms. Thus, only a few viable cells are required to initiate human salmonellosis (D'Aoust, 2001). Dose-response relationships were available for some microorganisms (e.g., Table 5). Lead poisoning occurs with the consumption of high-dose or low-dose sources; retention of metallic lead (e.g., lead shot) in the stomach is a high-dose source (Beers and Berkow, 1999).

**Release assessment** Release assessment focused on the qualitative likelihood of a carcass releasing the hazard into the environment. This depends on the prevalence of infection in the live animals and the survival of microorganisms in the carcass. In many cases, there was meagre evidence on prevalence (e.g., only one publication citing the prevalence of *E. coli* 0157 in wild birds as 0.34%: Rice *et al.*, 2003); consequently, there was a high level of uncertainty. However, there was more published information on microorganisms'

survival (e.g., *C. jejuni* survives best at refrigeration temperature), supplemented by expert opinion (e.g., chlamydiae survive in a killed pigeon, as long as the carcass is fresh).

**Exposure assessment** The exposure pathways are presented in Figure 5. Exposure can occur when handling live animals and their carcasses at all stages in the distribution and marketing chain, and when they are consumed. However, the degree of exposure in the marketing chain is highly variable. For example, the conditions under which deer and birds are transported (outlined by expert opinion) vary, some being suspended, and others being piled on vehicle floors. Similarly, the mode of storage in game larders varies, with temperature fluctuations occurring (Barnes *et al.*, 1973). Since these factors affect the likelihood of cross-contamination, there is the capacity for substantial variability in the degree of cross-contamination.

**Risk characterization** The risk characterization defined risk qualitatively as 'negligible', 'very low', 'low' and 'non-negligible'. The criteria for characterization included the infectivity and survival of the microorganisms; the likelihood of cross-contamination during storage, distribution and retail; and the preva-

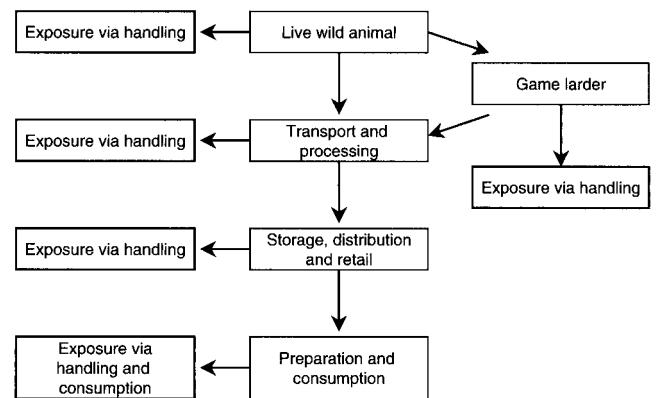
**Fig. 5** Human exposure pathway for hazards from wild game. (From Coburn *et al.*, 2005)**Table 5** Results of dose-response experiment with *Campylobacter jejuni*, strain A3249, in healthy volunteers. (Simplified from Black *et al.*, 1988.)

Dose (number of ingested bacteria)	Number dosed	Number infected	Percentage infected	Number with gastro-intestinal symptoms	Percentage of infected with gastro-intestinal symptoms
800	10	5	50	1	20
8 000	10	6	60	1	17
90 000	13	11	85	6	55
800 000	11	8	73	1	13
1 000 000	19	15	79	1	7
10 000 000	9	9	100	2	22

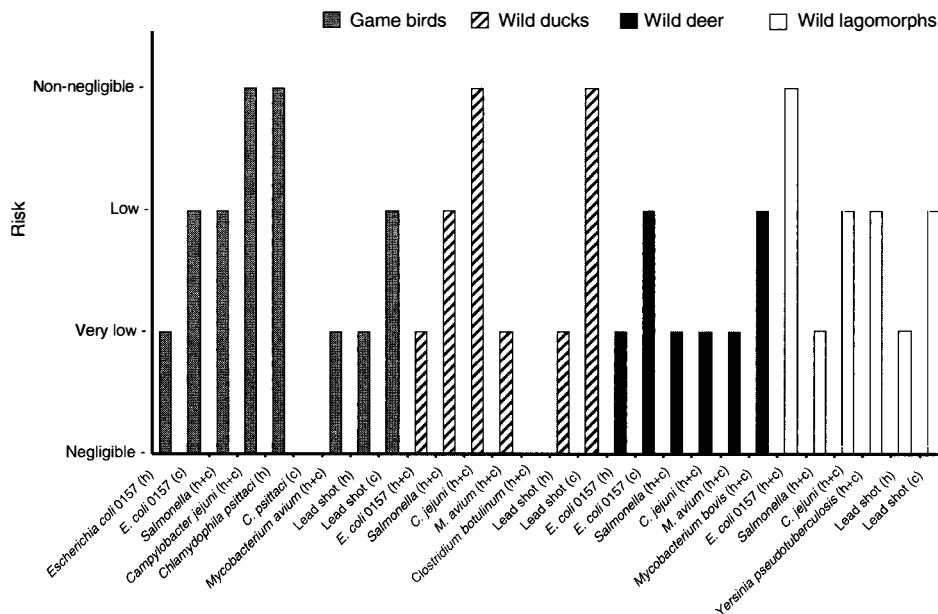

Fig. 6 Assessed risk to human health from identified hazards in wild game. (h): handling game; (c): consumption of game. (From Coburn *et al.*, 2005.)

lence of infection in the various species. Thus, the risk of *Salmonella* spp. infection through handling and consumption of wild deer was considered to be very low, based on the very low prevalence of infection in deer. In contrast, the risk of *C. jejuni* in wild ducks was considered to be non-negligible (the highest ranking) based on a high prevalence in wild waterfowl. The results of the overall risk assessment are presented in Figure 6.

**Risk management** The second part of the risk question refers to management of the risks – namely, to what extent would new European Union proposals on hygiene affect the risk? These proposals are threefold:

1. training of hunters;
2. control of hazards on game-meat plants using HACCP principles;
3. veterinary post-mortem inspection.

The risk analysis was mainly concerned with the second and third proposals, and drew mixed conclusions. Thus, using HACCP, adequate trimming and rejection of deer carcasses contaminated with rumen contents would reduce the amount of cross-contamination during processing, thereby reducing the risk of *Salmonella* spp. exposure, either by handling or consumption. Consequently, the adverse risk to human health would be reduced. Likewise, veterinary post-mortem examination would additionally ensure the rejection of septicaemic or toxæmic carcasses, thereby further reducing risk. In contrast, although application of HACCP to *C. jejuni* infection of deer would reduce the risk of cross-contamination, vet-

erinary post-mortem examination would provide no additional benefit because the infection is carried without visible lesions.

Small wild game (rabbit and hare) infected with *E. coli* O157, *Salmonella* spp., *C. jejuni*, *Y. pseudotuberculosis*, and contaminated with lead shot, would benefit from reduced risk associated with HACCP (including the removal of obviously unfit carcasses and residue testing), but veterinary post-mortem inspection would not result in added benefit.

Although there was clear uncertainty attached to several of the hazards, this analysis provided a profile of risks associated with wild game, and gave a useful indication of where veterinary post-mortem examination (an additional cost to marketing) would be of benefit, and where it would not.

### Qualitative risk assessment during epidemics

An important component of the control of major epidemic diseases, such as classical swine fever and foot-and-mouth disease, is the identification of all susceptible livestock that may have been exposed to infection. These animals may be incubating disease, which, at some future date, could result in the appearance of clinical signs accompanied by virus excretion and subsequent spread. Such animals are termed 'dangerous contacts' (see also Chapter 22) and their removal during the incubation period of infection, before the release of virus associated with the appearance of clinical disease, may be necessary to manage (i.e., reduce) the risk of transmission of infection.

This involves undertaking a qualitative veterinary risk assessment of all susceptible livestock on premises where the risk of exposure to infection may be high. This first requires a thorough knowledge of the characteristics of the relevant microbe – notably, its survival and modes of transmission. Foot-and-mouth disease virus, for example, is commonly transmitted by direct contact between infected and susceptible animals, and by short-range aerosol spread. However, the PanAsia strain is not associated with significant aerosol spread (Sakamoto and Yoshida, 2002), which is estimated to be less than 100 m under farming conditions in the UK (Donaldson *et al.*, 2001). Moreover, the ability of the virus to survive in the environment (Table 6.7) facilitates spread on footwear, clothing, vehicles and other fomites, and the virus can also be transmitted atmospherically (see Chapter 6), noting that this can be modified by the characteristics of the virus strain (Table 6.5). Thus, potential high-risk premises include those contiguous (adjacent) to premises with confirmed infection in animals (termed infected premises (IPs)), those potentially exposed to infection via the movement of livestock (both infected and uninfected), vehicles and personnel from IPs onto other farms, and those under a virus plume, if one forms.

#### Example of a contiguous-premises assessment

The assessment of animals on contiguous premises is a major component of dangerous-contact assessment. It

should be considered on a case-by-case basis, according to their species and locations relative to animals on the IP to which they are adjacent. Consider, for instance, the premises and animals in Figure 7. The IP comprises 200 cattle at pasture, many of which are clinically affected by the PanAsia strain of foot-and-mouth disease virus.

**Farm A** The sheep on Farm A are separated from the IP by a wood, and so are unlikely either to have direct contact with the infected cattle or to be exposed to short-distance aerosols. The cattle on Farm A are not at pasture, but are housed some distance from the IP and so, similarly, are unlikely to be exposed to infection. Thus, animals on this farm would not be declared to be dangerous contacts. However, to manage any potential risk, the animals should be isolated, the farm placed under movement restrictions, and regular veterinary surveillance inspections mounted (traditional epidemic risk management techniques: HMSO, 1969).

**Farm B** The sheep on Farm B may have had direct contact with the infected cattle across a common boundary, and so are deemed to be dangerous contacts, and are subjected to precautionary slaughter.

**Farm C** The sheep on Farm C, in common with those on Farm A, are separated from the IP by a wood. Therefore, they should not be classed as dangerous contacts, but should be isolated, the farm placed under

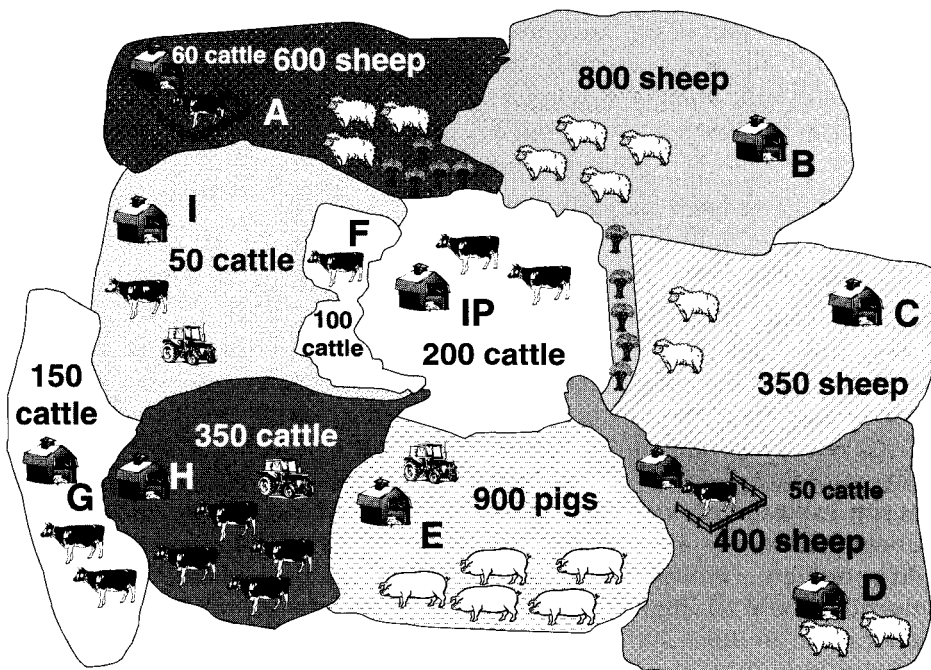

Fig. 7 Location of animals around a premises infected with foot-and-mouth disease (IP). (Similar shading indicates premises under common ownership.)

movement restrictions, and regular veterinary surveillance inspections undertaken.

**Farm D** The sheep on Farm D are at grass some distance from the IP, and the cattle are housed. Therefore, again, animals on this farm are not considered to be dangerous contacts.

**Farm E** The pigs on Farm E are at pasture some distance from the farm's boundary with the IP. Although there may have been some vehicular movement close to the boundary, the cattle on the IP are pastured some distance from the boundary. Moreover, pigs are hard to infect by aerosol, infection by ingestion being the commonest route (Donaldson and Alexandersen, 2002). Thus, the pigs on this farm are not classified as dangerous contacts. However, because of the large amounts of virus that can be produced by pigs, if infected (Donaldson, 1987), regular veterinary surveillance inspections and the other traditional epidemic risk management strategies (movement restrictions and isolation of animals) should be undertaken. Alternatively the pigs may be assessed as dangerous contacts and slaughtered as a precaution, to minimize the potential risk posed by the (uncontrollable) spread of airborne virus if the pigs succumbed to infection and produced a virus plume.

**Farm F** The cattle on Farm F are in close proximity to the infected animals, and thus may have had contact with them across the fence. They should therefore be classified as dangerous contacts, and slaughtered as a precaution (like Farm B).

**Farm G** Farm G and Farm F have the same owner. However, the livestock on G have had no contact with the stock on F; therefore they are not classified as dangerous contacts, but are subjected to regular surveillance.

**Farm H** Cattle on Farm H are not grazing close to the infected cattle, and there is very little common boundary with the IP, justifying their not being classified as dangerous contacts, although they should be subjected to surveillance.

**Farm I** Farm I also has very little common boundary with the IP, and its cattle are also grazing some distance away from cattle on the IP, and on Farms G and H. This suggests that these are at low risk and therefore should not be classified as dangerous contacts but, again, should be subjected to surveillance.

Note that case-by-case veterinary risk assessment – which has been shown to be effective in identifying premises at high risk (Honhold *et al.*, 2004a) – is a more

selective approach than the blanket culling of susceptible animals on all premises that are cartographically contiguous to an IP, irrespective of stock location and details of movements of vehicles and personnel (see Chapter 22). In this example, the selective approach results in 1100 animals (including those on the IP) being culled (2000, if the pigs on Farm E are slaughtered), whereas blanket culling results in 3860 being slaughtered.

## Quantitative risk analysis

### Framework for quantitative risk assessment

Quantitative risk assessment follows the same general framework as qualitative assessment (indeed, qualitative risk assessment is the foundation on which quantitative assessment is built), but numerical values are attached to the various stages of release and exposure pathways; a numerical estimate of risk is thereby generated. This frequently involves the use of **simulation models**, and methods may be either **deterministic**, providing single point estimates of risk as outputs, or **stochastic**, whereby probability distributions are obtained as outputs. (See Chapter 19 for a fuller discussion of models and modelling terms.)

A deterministic assessment of the risk associated with the unrestricted importation of animals or animal products, for example, would consider, as input parameters, the prevalence of pathogens in the source population and the probability of the pathogens surviving during importation as part of the release assessment, and the probability of the pathogens coming into contact with local livestock after importation as part of the exposure assessment. The output would be the single point estimate of the annual probability of an infected animal or animal product introducing the pathogen. In contrast, a stochastic assessment would involve the probability distributions of the pathogens surviving during importation and coming into contact with local livestock after importation, thereby presenting a range of values for the annual probability of introduction of the pathogen.

Deterministic prediction of the risks of importing infected animals under various general importation rules has already been discussed in detail in Chapter 17 ('Diagnostic tests in import risk assessment').

### Example of a deterministic risk assessment: introduction of anthrax into New Zealand in imported unprocessed Australian hides

New Zealand imports from Australia unprocessed ('green') hides, which may be contaminated with

anthrax. A deterministic risk assessment was therefore undertaken to answer the risk question: 'What is the probability of the introduction of anthrax into New Zealand in unprocessed Australian hides?' (Cox and Ryan, 1998).

The following release and exposure pathways can be identified:

- unprocessed hides and skins, which may be contaminated with anthrax spores, are imported into New Zealand for processing in tanneries;
- in some tanneries, wastewater is discharged without treatment; thus, waterways downstream from the tanneries could be contaminated with anthrax spores;
- during floods, spores that escape could be carried onto pasture and infect livestock.

Table 6 details the data and calculations used in the assessment. Note that some input parameters are based on expert opinion (e.g., the survival of spores,  $p_s$ ), whereas others are little more than guesses (e.g., the number of officially approved tanneries with a risk of contaminating pasture during flood periods,  $t$ ). Other assumptions include:

- a contaminated hide will not cross-contaminate other hides during handling, transportation and storage, except (possibly) other hides processed on the same day at the same tannery;
- the probability that New Zealand livestock will be infected with anthrax if spores escape from a 'risk tannery' on a flood day is 1;
- infected hides are randomly distributed among all hides imported from Australia;
- spores on a hide can only escape into rivers on the day it is processed in a 'risk tannery';
- all 23 tanneries in New Zealand process the same number of hides in each year;
- each tannery processes a constant number of Australian hides each working day.

The assessment concludes that the annual probability of anthrax introduction in Australian hides is  $1.2 \times 10^{-2}$ ; that is, approximately 1 in 82. Thus, one (or more) outbreaks of anthrax can be expected to occur once every 82 years<sup>16</sup>.

A more realistic analysis of the risk would require improved knowledge of the pattern of the disease in Australia, handling of the hides during shipment, processing of hides, and management of wastewater. The assumption that escape of spores from a 'risk tannery' during a flood always leads to infection should also be examined further.

More detailed information on the variability and uncertainty associated with the input parameters

would give rise to a stochastic approach. Thus, the assessment could be refined by attaching a range of values to the input parameters. The probability that anthrax spores survive processing, for example, could be represented using a point estimate and upper and lower limits, generating three final estimates of risk. However, there are two disadvantages to this approach. First, no weighting is attached to the three values of probability, yet the point estimate may be more likely than the limits. Secondly, analyses become cumbersome as the number of parameters increases. If, for example, six input parameters were being considered, each with a point estimate and upper and lower limits, there would be 729 ( $3^6$ ) output scenarios. These problems can be overcome by **Monte Carlo simulation modelling** (see Chapter 19). This is commonly undertaken using the dedicated risk-analysis software, @RISK (see Appendix III).

### Probability distributions

Probability distributions of input parameters are first required. If a substantial amount of empirical data is available, standard statistical methods, such as the construction of histograms and box-and-whisker plots (see Chapter 12) may be used to explore the distribution. There are also statistics that explore the 'goodness-of-fit' of data to defined distributions; these are given in standard statistical texts. If data are sparse (but representative), bootstrapping (see Chapter 12) can be used to derive a distribution. If data are rare or unrepresentative, then expert opinion may need to be sought (with its attendant uncertainty). Expert opinion can also be combined with empirical data (Murray, 2002).

Some distributions that are applied in risk analysis are listed in Table 7. Key ones are the binomial, Poisson and hypergeometric<sup>17</sup>. The **triangular distribution** (Gupta and Nadaraja, 2004) (Figure 8), has become popular in risk analysis as a proxy for the beta distribution, which – although a suitable model in risk analysis because it provides a wide variety of distributional shapes over a finite interval – is not readily understood and its parameters are not easily estimated (Johnson, 1997). The triangular distribution requires only the mode (most common value or values) and end points of a distribution (i.e., does not require description of its shape). It can be easily constructed using the point estimate of a parameter as the most likely value, and the lower and upper limits to define the range of the distribution. It is therefore attractive because credible input data may not be available, but experts may be relied upon to provide figures for the mode and two

<sup>16</sup> The expression of frequency in this form (rather than the probability,  $1.2 \times 10^{-2}$ ) is easy to understand by the layman, and so is an appropriate figure for communicating risk.

<sup>17</sup> This is found when random sampling is undertaken 'without replacement' (see Chapter 13 and Appendix X).

**Table 6** Deterministic quantitative risk assessment of the introduction into New Zealand of anthrax in unprocessed Australian hides and skins. (Based on Cox and Ryan, 1998, with parameters extracted from MacDiarmid, 1993)

$p_i$	= probability that a hide contains anthrax spores = $9.94 \times 10^{-7}$ (maximum annual incidence of anthrax in Australia, estimated at 40 cases/year; 40.23 million cattle and sheep slaughtered annually; therefore $p_i = 40/4.023 \times 10^7$ );	
$p_s$	= probability that anthrax spores survive to processing in New Zealand = 0.9 (estimate based on the known resistance of anthrax spores);	
$n$	= number of Australian hides processed annually in New Zealand = $0.92 \times 10^6$ (extracted from official records);	
$g$	= number of officially approved tanneries = 23 (data from Ministry of Agriculture and Fisheries records);	
$t$	= number of officially approved tanneries with a risk of contaminating pasture during flood periods = 5 (approximately 20% of $g$ – a guessed estimate, in the absence of data);	
$d$	= annual number of processing days at each tannery = 235 (365 days minus weekends and holidays);	
$v$	= average number of days per year on which flooding occurs downstream of tanneries = 25 (estimated from a range of 20–30 days);	
$p_f$	= probability that there is a flood on any day at any of the ‘risk tanneries’ = $v/365$ = 0.0685;	
$p_a$	= probability that an Australian hide in New Zealand is contaminated = $p_i \times p_s$ = $9.94 \times 10^{-7} \times 0.9$ = $8.946 \times 10^{-7}$ ;	
$h$	= number of Australian hides processed each day by each tannery = $(n/g)/d$ = $(0.92 \times 10^6/23)/235$ = 170;	
$p_x$	= probability, on any given day, at any given tannery, that there is both a flood and at least one infected hide processed = $p_f \times p_a$	
where: $p_1$	= $[1 - (1 - 0.999848)^h]$ = $(1 - 0.999848)^h$ = 0.000152;	$- p_a^h]$
thus: $p_x$	= $0.0685 \times 0.000152$ = $1.0412 \times 10^{-5}$ .	
$P_E$	= annual probability of anthrax introduction in Australian hides = $[1 - \exp(-p_x \times t \times d)]^*$ = $[1 - \exp(-1.0412 \times 10^{-5} \times 5 \times 235)]$ = $[1 - \exp(-0.0122341)]$ = $[1 - 1/(\exp 0.0122341)]$ = $1 - 0.9878$ = 0.012 = $1.2 \times 10^{-2}$ .	

\* This assumes that that annual number of floods (and hence number of flood days when at least one infected hide is processed) follows a Poisson distribution (see Chapter 12), where the annual mean number of anthrax introductions,  $\lambda$ , =  $p_x \times t \times d$ . Thus, using the formula and notation in Chapter 12, the probability that there are no anthrax introductions in a year = (e introduction in a year,  $P_E$ , is one minus the probability that there are no introductions =  $1 - e^{-\lambda} = [1 - \exp(-p_x \times t \times d)]$ ).

extreme values<sup>18</sup>. Probabilities associated with any range between the lower and upper limits can then be derived using linear interpolation. The triangular distribution is considered to be a good approximation to

distributions such as the Normal distribution (see Chapter 12). However, it should not be applied when useful information, suggesting a distribution other than the triangular, is available.

<sup>18</sup> Note, however, that experts tend to narrow the range of a distribution; that is, subjective estimates – especially extreme estimates – provided by experts are liable to potential bias (Hudak, 1994). One reason for this is ‘anchoring’ (Morgan and Henrion, 1990): experts usually select the

most likely value first (the ‘anchor’) and then adjust the minimum and maximum estimates from this value. However, the adjustment rarely includes the extremes that could occur; that is, the estimates of the extremes are biased towards the most likely value.



**Table 7** Some distributions applied in risk analysis\*. (Modified from Murray *et al.*, 2004d.)

Discrete distributions	Continuous distributions
Binomial <sup>†</sup>	Beta <sup>§</sup>
Discrete	Cumulative
Discrete uniform	Exponential
Geometric	Gamma
Hypergeometric	Histogram
Negative binomial	Lognormal <sup>†</sup>
Poisson <sup>†</sup>	Normal <sup>†</sup>
	Pert <sup>§</sup>
	Triangular
	Uniform (rectangular)

\* See Evans *et al.* (2000) for full details.

<sup>†</sup> Described in Chapter 12.

<sup>§</sup> See also Chapter 17.

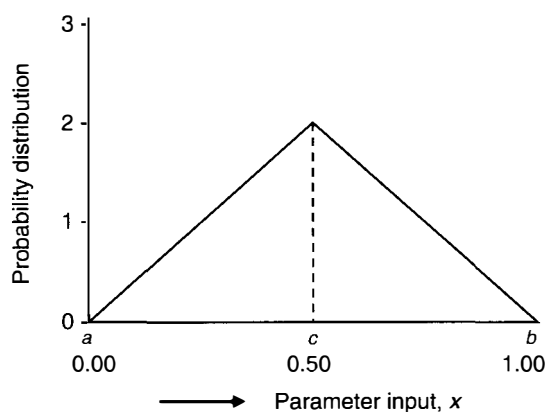

**Fig. 8** The triangular distribution.  $a$  = minimum,  $b$  = maximum;  $c$  = mode. (The distribution can be skew.)

### Variability and uncertainty

Variability and uncertainty both need to be addressed in stochastic simulations. Fortunately, both of these can be explored by Monte Carlo simulation, and it is suggested that they should both be identified individually so that the contribution of each to the total uncertainty can be noted (Vose, 2000). Variability can be addressed by the adoption of distributions, such as some of those listed in *Table 7*, for undefined parameters. Uncertainty associated with parameter inputs is more difficult to address, but may be tackled by either assuming a distribution, or using a range of parameter values to investigate the sensitivity of outputs to the parameter input (i.e., a 'sensitivity analysis' is undertaken, see Chapter 19).

### Example of a stochastic risk assessment: introduction of rabies into Great Britain in dogs and cats

Rabies prevention in Great Britain was traditionally based on quarantine of susceptible species, notably dogs and cats. However, in the 1990s, it became clear that the policy should be reviewed because of the reduced incidence of rabies in the European Union and the availability of vaccines. Accordingly, a stochastic risk assessment was undertaken to answer the risk question: 'What is the risk of an imported dog or cat developing rabies if various policies to prevent the entry of rabies into Great Britain are implemented?' (MAFF, 1998).

The various policy options are listed in *Table 8*. Risk of release in relation to all options, the possible routes of entry of imported dogs and cats, and points of interception, are given in *Figure 9*. This gives rise to eight possible pathways (the numbered columns in the *Figure*). The most important outcomes under the quarantine system in force in the 1990s are represented by the black squares in Columns 1 and 5: an infected animal develops rabies in quarantine, or an illegal infected animal develops rabies outside quarantine, respectively.

The number of infected or uninfected animals that are expected to enter Great Britain by each pathway can be estimated. This requires several parameters (*Table 9*). For example, the number of infected animals entering in pathway 1 is:

$$N_1 = Iq(1-r_q)$$

using the notation in *Table 9*.

The data that were required to estimate the variables and parameters were obtained from published and

**Table 8** Policies to prevent the entry of rabies into Great Britain. (Modified from MAFF, 1998.)

Policy current in the 1990s (option (a))	Quarantine 6 months
Option (b)	Reduced quarantine period (e.g., 1 month)
Option (c)	Vaccination of animals > 3 months old at a fixed time (e.g., 6 months), or during a fixed interval (e.g., 6–12 months), before entry to GB; followed by serological testing; permanent marking for identification
Option (d)	As (c), but checking (of certificates and blood test results) to be done away from port of entry
Option (e)	As for (c) or (d), but without quarantine; animals not satisfying requirements to be destroyed or refused entry
Option (f)	As for (e), but with all cats and dogs in GB vaccinated

**Fig. 9** Pathways by which imported dogs and cats can enter Great Britain, accounting for the different control measures and points of interception. (Modified from MAFF, 1998.) □: smuggled animals not discovered; ▨: smuggled animals checked and placed in quarantine; ■: pathways by which the majority of rabid animals enter Great Britain. Each numbered column represents a different sequence of events and outcomes, which, in the upper part of the diagram, are chronological from top to bottom. There are eight possible pathways, hence eight columns. When considering the risk of a cat or dog developing rabies in Great Britain, these pathways lead to five relevant outcomes (the bottom part of the diagram).

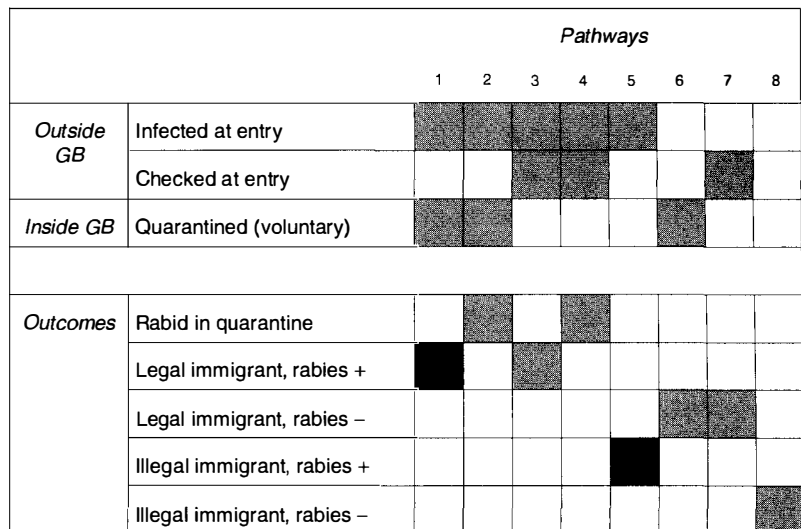

**Table 9** Parameters and variables required for a stochastic quantitative risk assessment of the importation of rabies into Great Britain. (From MAFF, 1998.)

Symbol	Definition	Value*
$N_x$	Number of animals (dogs + cats) entering GB annually via pathway x	Variable; 8914 (7267, 12901) for present policy
$I$	Number of rabies-infected, prospective imported (dogs + cats) into GB/year	Varies with country of origin
$b$	Rabies incubation period (years); used to calculate prevalence of infection among imported animals	0.115 (0.055, 0.164)
$c$	Fraction of animals checked at port of entry; animals that do not meet requirements of the policy in question are apprehended, and then quarantined (options (c),(d)), destroyed (options (e),(f)) or do not enter GB (withdrawn)	Varies with policy
$q$	Fraction of animals entering quarantine, voluntarily or through enforcement after non-compliance	Varies with policy and compliance
$r_q$	Fraction of rabies-infected animals that develop rabies in quarantine; determined by incubation period; varies according to quarantine period	0.9 (0.86, 0.95) for 6 months quarantine; 0.5 (0.45, 0.53) for 1 month
$r_p$	Fraction of rabies-infected animals that develop rabies during a given, statutory pre-entry period	0.9 (0.86, 0.95) 6 month pre-entry period; 0.95 (0.91, 1.0) for 12 months
$v$	Fraction of animals vaccinated before entering GB	Varies with compliance
$s$	Fraction of vaccinated animals that is blood tested	0.98 (0.8, 0.998)
$t_+$	Fraction of rabies-infected animals that test positive following vaccination	0.95 (0.9, 0.99)
$t_-$	Fraction of uninfected animals that test positive following vaccination	0.95 (0.9, 0.99)
$p_+$	Fraction of vaccinated, uninfected, blood test positive that is protected	0.99 (0.98, 0.999)
$p_-$	Fraction vaccinated, uninfected, blood test negative that is protected	0.5 (0.2, 0.8)
$w$	Fraction blood test negative that is withdrawn	0.15 (0.05, 0.25)
$d_q$	Duration of quarantine (years)	0.083 (option (b)) or 0.5 (other options)
$d_p$	Time between vaccination and entry (years); options (c)–(f)	0.5 or 1.0
$e$	Vaccine efficacy; proportion of vaccinated animals that is protected against infection = $t_+p_+ + (1 - t_+)p_-$	0.9666 (0.902, 0.997)

\* The three values are best (low, high) defining the points of triangular distributions used in variability and uncertainty analysis.

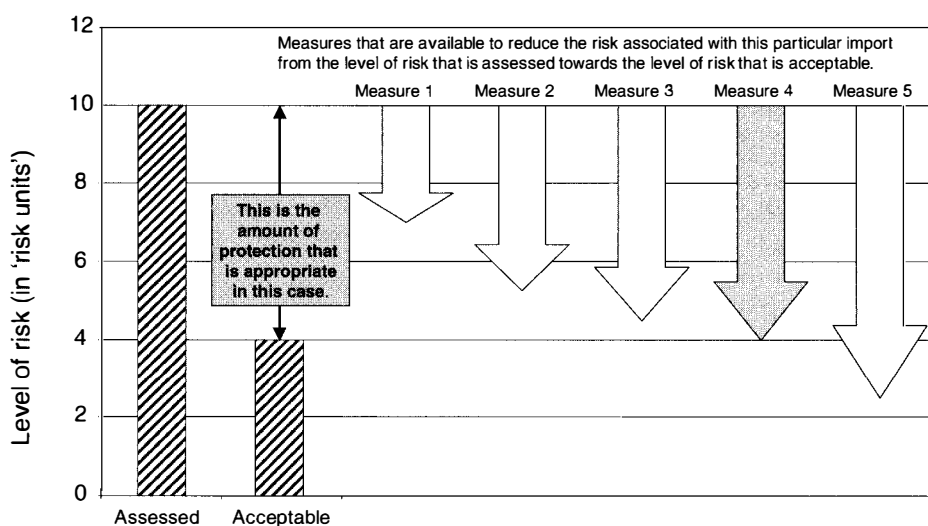

**Fig. 10** The relationship between assessed risk, acceptable level of risk, the appropriate level of protection, and *Sanitary and Phytosanitary* measures, for import of a specific commodity. (From Pharo, 2004.)

unpublished sources, and ranged from verifiable objective data to guesses. Thus, the number of animals imported under the quarantine system was obtained from official government records, whereas the number of animals expected to be imported if control was changed to one based on vaccination without quarantine was a guess.

Taking account of the variability and the uncertainty in the risk assessment, modelled using the various triangular distributions, the results concluded that there would be very little increase in the risk of rabies being imported into Great Britain if quarantining of animals from the European Union was abandoned and was replaced by a control strategy based on animal identification, vaccination and serological testing. This risk assessment therefore provided evidence in favour of a policy change to the latter strategy.

### What level of risk is acceptable?

The results of risk assessments need to be meaningfully interpreted so that appropriate risk management strategies can be adopted. The latter implicitly depend on the level of risk that is deemed to be acceptable (more strictly, on the options that entail a specific level of risk). This is a major concern in the context of the international trade in animals and animal products, where epidemic diseases and zoonoses may be imported. The *Sanitary and Phytosanitary (SPS) Agreement* of the WTO (OIE, 1997) requires that each participating country specifies its appropriate level of protection or acceptable level of risk.

Figure 10 depicts a conceptual framework for the acceptable level of risk in relation to *SPS* control measures (e.g., quarantine) for importation of animals or

their products. Noting that risk has two components – the probability of an event's occurrence and the severity (impact) of its consequences – the risk units are best considered in economic terms, because probability is dimensionless, but consequences of introduction of disease have an economic impact (e.g., in disease losses and control, and loss of trade). This framework assumes that risk can be estimated objectively and accurately (ideally quantitatively), and that each country can set its level of acceptable risk. Thus, if the current level of disease risk is 10, and the acceptable level of disease risk is 4, Measure 4 comprises the optimum combination of control measures. Measures 1–3 are inadequate, whereas Measure 5 is excessive<sup>19</sup>. Note that the acceptable level of risk and the appropriate level of protection are subtly different. The former is about acceptable economic losses to the national economy, whereas the latter is the level of economic losses avoided by the application of safeguards.

However, noting the steps in risk assessment (see above: 'Components of risk analysis'), Pharo (2004) concludes that neither the scientific assessment of risk nor the risk-reduction effect of safeguards can be estimated as objectively as the *SPS* framework anticipates. Release assessment in import risk assessment, for example, usually computes the probability of an imported animal being affected. However, this is based on the prevalence of infection in the exporting countries, many of which may have poor surveillance systems and consequently poor prevalence data. Additionally, predicting the volume of trade (and therefore the number of imported animals) may be

<sup>19</sup> If the risk units are expressed in monetary terms, there is thus a clear similarity between risk analysis and cost-benefit analysis (see Chapter 20 and Lave, 1996).

difficult. If the imported commodity is an animal product rather than a live animal (e.g., hatching eggs), the exposure pathway and infectious dose may be complex and difficult to ascertain. If bulk commodities such as animal feeds are being imported, the choice of trade-unit size is somewhat arbitrary and microbial inactivation curves for various stages of the production process are usually unknown. Diagnostic tests may be used to estimate the risk of importing affected test-negative animals, but there is often a lack of precision attached to the estimate because of the attendant lack of precision associated with the relevant parameter (sensitivity), reflected in the width of its confidence interval (see Chapter 17).

The consequences of exposure may also be refractory to objective assessment, with the opinions of experts being no more than personal belief. Infections pose an additional problem when their zoonotic impact is uncertain (e.g., highly pathogenic avian influenza virus). Additionally, unknown factors may also confound prediction. For example, the magnitude of the foot-and-mouth disease epidemic in the UK in 2001 (Figure 4.1) was determined by widespread dissemination of the virus by subclinically infected sheep (Mansley *et al.*, 2003) – a feature that was impossible to predict before the epidemic. Moreover, economic impact is partly related to control policy, which may be modified unpredictably in the future. Thus, the traditional foot-and-mouth control procedures were modified in the UK in 2001 by a more aggressive culling policy only after the epidemic had begun, thereby incurring higher control costs than could be predicted (Kitching *et al.*, 2006)<sup>20</sup>.

Market reaction also can be unpredictably extreme. A single case of bovine spongiform encephalopathy in Canada in 2003, for instance, resulted in cessation of exports, and the country's \$7 billion per year cattle and beef industry suffered a 34% drop in value (Carter and Hule, 2004). Since Canada is a major exporter of beef to the US, the export ban also resulted in a substantial increase in the price of US beef (Hanrahan and Becker, 2004).

In summary, there usually is a lack of quantitative data with which to assess precisely the probability and magnitude (severity) of the consequences of importation. Moreover, if acceptable risk is viewed monetarily, then it may be framed in terms of the level of economic losses that can be tolerated to optimize the benefits of international trade – but the perception and reaction of the public and politicians cannot be discounted. The

determination of acceptable levels of risk in import risk assessment is therefore complex, in common with acceptable risk in the wider context, which involves economic (Starr, 1969) and psychological (Fischhoff *et al.*, 1978) factors. This indicates that the final decision on the acceptable level of risk usually involves social, economic and political, rather than scientific, considerations (Slovic, 2000; Sjöberg, 2001).

Veterinarians need to be aware of the limitations of risk analysis, which may pose more questions than it answers. (Indeed, an important function of risk analysis is to identify what is not known.) The results of risk analyses may be founded on invalid assumptions, and frequently there may be uncertainty attached to the hazards and processes for which risk is being assessed (Ballard, 1992). Moreover, it is often possible only to produce a relative ranking of the likelihood of events, rather than accurate assessments (Ansell, 1992), noting that numerical outputs are likely to be crude (Schneiderman, 1980). Nevertheless, risk analysis has a valuable role to play in identifying and managing risk in many areas of veterinary medicine, rather than attempting to prosecute a 'zero-risk' strategy, which is not amenable to changes in the light of new knowledge, economic circumstances, and political requirements.

## Further Reading

- Ahl, A.S., Acree, J.A., Gibson, P.S., McDowell, R.M., Miller, L. and McElvaine, M. (1993) Standardization of nomenclature for animal health risk analysis. *Revue Scientifique et Technique, Office International des Epizooties*, 12, 1045–1053
- Amass, S.F. (2005) Biosecurity: reducing the spread. *The Pig Journal*, 56, 78–87. (*Guidelines for qualitative risk assessment of farm biosecurity to prevent within-farm spread of infections*)
- Amass, S.F. (2005) Biosecurity: stopping the bugs from getting in. *The Pig Journal*, 55, 104–114. (*Guidelines for qualitative risk assessment of farm biosecurity to prevent entry of pathogens*)
- Codex Alimentarius Commission (1999) *Principles and Guidelines for the Conduct of Microbial Risk Assessment*. CAC/GL-30. Food and Agriculture Organization of the United Nations, Rome
- Covello, V.T. and Merkhofer, M.W. (1993) *Risk Assessment Methods: Approaches for Assessing Health and Environmental Risks*. Plenum Press, New York and London
- Covello, V.T., McCallum, D.B. and Pavlova, M.T. (Eds) (1989) *Effective Risk Communication: the Role and Responsibility of Government and Nongovernment Organizations*. Plenum Press, New York
- ICMSF (1988) *HACCP in Microbiological Safety and Quality. Micro-organisms in Food, 4, Application of the hazard analysis critical control point (HACCP) system to ensure microbiological safety and quality*. The International Commission on Microbiological Specifications for Foods (ICMSF) of the International Union of Microbiological Societies. Blackwell Scientific Publications, Oxford

<sup>20</sup> The full impact involved more than the cost of control. It also included losses to the leisure and tourist industry (Fawcett and Head, 2001a,b; Thompson *et al.*, 2002; Blake *et al.*, 2003), as well as psychological damage to individuals.

- ICMSF (1998) Potential application of risk assessment techniques to microbiological issues related to international trade in food and food products. International Commission on Microbiological Specifications for Foods (ICMSF) Working Group on Microbial Risk Assessment. *Journal of Food Protection*, **61**, 1075–1086
- Kindred, T.P. (1996) Risk assessment and its role in the safety of foods of animal origin. *Journal of the American Veterinary Medical Association*, **209**, 2055–2056
- MacDiarmid, S.C. and Pharo, H.J. (2003) Risk analysis: assessment, management and communication. *Revue Scientifique et Technique, Office International des Epizooties*, **22**, 397–408
- Moos, M. (1995) Models of risk assessments for biologicals or related products in the European Union. *Revue Scientifique et Technique, Office International des Epizooties*, **14**, 1009–1020
- Morley, R.S. (Coordinator) (1993) Risk analysis, animal health and trade. *Revue Scientifique et Technique, Office International des Epizooties*, **12**, 1001–1362
- Murray, N. (2002) *Import Risk Analysis: Animals and Animal Products*. Ministry of Agriculture and Forestry, Wellington
- Murray, N., MacDiarmid, S.C., Wooldridge, M., Gummow, B., Morley, R.S., Weber, S.E., Giovannini, A. and Wilson, D. (2004) *Handbook on Import Risk Analysis for Animals & Animal Products, Volume I. Introduction and Qualitative Risk Analysis*. Office International des Epizooties, Paris
- Murray, N., MacDiarmid, S.C., Wooldridge, M., Gummow, B., Morley, R.S., Weber, S.E., Giovannini, A. and Wilson, D. (2004) *Handbook on Import Risk Analysis for Animals & Animal Products, Volume II. Quantitative Risk Analysis*. Office International des Epizooties, Paris
- North, D.W. (1995) Limitations, definitions, principles and methods of risk analysis. *Revue Scientifique et Technique, Office International des Epizooties*, **14**, 913–923
- OIE (2006) Risk analysis. In: *Terrestrial Animal Health Code*, 15th edn. Section 1.3. Office International des Epizooties, Paris
- O’Riordan, T., Cameron, J. and Jordan, A. (Eds) (2001) *Reinterpreting the Precautionary Principle*. Cameron May, London. (A discussion of the current evolution of the precautionary principle in science, public affairs, the public understanding of science, and international law and trade)
- Pfeiffer, D.U. (2006) Communicating risk and uncertainty in relation to development and implementation of disease control policies. *Veterinary Microbiology*, **112**, 259–264
- Roberts, T., Ahl, A. and McDowell, R. (1995) Risk assessment for foodborne microbial hazards. In: *Tracking Foodborne Pathogens from Farm to Table: Data Needs to Evaluate Control Options*. Conference Proceedings, January 9–10 1995, pp. 95–115. United States Department of Agriculture Miscellaneous Publication Number 1532
- Vose, D.J. (1997) Risk analysis in relation to the importation and exportation of animal products. *Revue Scientifique et Technique, Office International des Epizooties*, **16**, 17–29
- Vose, D. (2000) *Risk Analysis: A Quantitative Guide*, 2nd edn. John Wiley, Chichester
- Wooldridge, M., Clifton-Hadley, R. and Richards, M. (1996) ‘I don’t want to be told what to do by a mathematical formula’ – overcoming adverse perceptions of risk analysis. In: *Society for Veterinary Epidemiology and Preventive Medicine, Proceedings, Glasgow, 27–29 March 1996*. Eds Thrusfield, M.V. and Goodall, E.A., pp. 36–46

# References

---

- Aalund, O., Willeberg, P., Mandrup, M. and Riemann, H. (1976) Lung lesions at slaughter: association to factors in the pig herd. *Nordisk Veterinærmedicin*, **28**, 481–486
- Abbey, H. (1952) An examination of the Reed–Frost theory of epidemics. *Human Biology*, **24**, 201–233
- Abdurahman, O.A.Sh., Agab, H., Abbas, B. and Åström, G. (1995) Relations between udder infection and somatic cells in camels (*Camelus dromedaries*) milk. *Acta Veterinaria Scandinavica*, **36**, 423–431
- Abernethy, D.A., Pfeiffer, D.U. and Neill, S.D. (2000) Case control study examining the role of livestock markets in the transmission of bovine tuberculosis. In: Society for Veterinary Epidemiology and Preventive Medicine, Proceedings, Edinburgh, 29–31 March 2000, Eds Thrusfield, M.V. and Goodall, E.A., pp. 108–114
- Abiven, N., Seegers, H., Beaudeau, F., Laval, A. and Fourichon, C. (1998) Risk factors for high sow mortality in French swine herds. *Preventive Veterinary Medicine*, **33**, 109–119
- Abramo, F., Pratesi, F., Cantile, C., Sozzi, S. and Poli, A. (1999) Survey of canine and feline follicular tumours and tumour-like lesions in central Italy. *Journal of Small Animal Practice*, **40**, 479–481
- Abramson, J.H. (1991) Meta-analysis: a review of pros and cons. *Public Health Reviews*, **18**, 1–47
- Abramson, J.H. and Abramson, Z.H. (1999) *Survey Methods in Community Medicine*, 5th edn. Churchill Livingstone, Edinburgh
- Acheson, R.M., Hall, D.J. and Aird, L. (Eds) (1976) *Health Information, Planning and Monitoring. Seminars in Community Medicine, Volume 2*. Oxford University Press, Oxford
- Ackerman, L.J. (1999) *The Genetic Connection: A Guide to Health Problems in Purebred Dogs*. AAHA Press, Lakewood
- Ackoff, R.L. (1971) Towards a system of systems concepts. *Management Science*, **17**, 661–671
- Adamson, M.L. (1986) Modes of transmission and evolution of life histories in zooparasitic nematodes. *Canadian Journal of Zoology*, **64**, 1375–1384
- ADAS (1989) *Deer Health Scheme*. Ministry of Agriculture, Fisheries and Food, State Veterinary Service, PB 0052. ADAS Publications, London
- AFSSA (2000) TAGS: Evaluation of tests in the absence of a gold standard. *Agence Française de Sécurité Sanitaire des Aliments*, France. <http://www.afssa.fr/interne/tags.htm> (Accessed 7 December 2004)
- Agger, J.F. and Willeberg, P. (1986) Epidemiology of teat lesions in a dairy herd. II. Associations with subclinical mastitis. *Nordisk Veterinærmedicin*, **38**, 220–232
- Agger, J.F., Willeberg, P., Schmidt Madsen, P. and Klastrup, O. (1986) A case control study of environmental and managerial factors in the Danish national mastitis control program. In: Proceedings of the Fourth International Symposium on Veterinary Epidemiology and Economics. Singapore, 18–22 November 1985, pp. 438–440. Singapore Veterinary Association
- Agriculture Canada (1984) Enzyme immunoassay: application to the detection of bovine antibody to *Brucella abortus*. Agriculture Canada, Animal Disease Research Institute, Nepean, P.O. Box 11300, Station H, Nepean, Ontario, Canada
- Aguirre, A.A., Ostfeld, R.S., Tabor, G.M., House, C. and Pearl, M.C. (2002) *Conservation Medicine: Ecological Health in Practice*. Oxford University Press, Oxford
- Ahuja, V. and Redmond, E. (2004) Livestock services and the poor. *Tropical Animal Health and Production*, **36**, 247–268
- Aitken, I.D. (1993) Environmental change and animal disease. In: *The Advancement of Veterinary Science. The Bicentenary Symposium Series. Volume 1: Veterinary Medicine Beyond 2000*. Ed. Michell, A.R., pp. 179–193. CAB International, Wallingford
- Akhtar, S. and Zahid, S. (1995) Risk indicators for Newcastle Disease outbreaks in broiler flocks in Pakistan. *Preventive Veterinary Medicine*, **22**, 61–69
- Akhtar, S., Farver, T.B. and Riemann, H.P. (1996) Associations between *Campylobacter fetus*, *Haemophilus somnus*, *Leptospira hardjo* and bovine viral diarrhoea virus antibody titers in dairy cattle from a California herd. *Preventive Veterinary Medicine*, **27**, 125–134

- Akhtar, S., Riemann, H.P., Thurmond, M.C., Farver, T.A. and Franti, C.E. (1990) Multivariate logistic analysis of repeated cross-sectional surveys of *Campylobacter fetus* in dairy cattle. *Preventive Veterinary Medicine*, **10**, 15–24
- Akhtar, S., Zahid, S. and Khan, M.I. (1992) Risk factors associated with hydropericardium syndrome in broiler flocks. *Veterinary Record*, **131**, 481–484
- Akhtar, S., Riemann, H.P., Thurmond, M.C. and Franti, C.E. (1993a) The association between antibody titres against *Campylobacter fetus* and milk production efficiency in dairy cattle. *Veterinary Research Communications*, **17**, 183–191
- Akhtar, S., Riemann, H.P., Thurmond, M.C. and Franti, C.E. (1993b) The association between antibody titres against *Campylobacter fetus* and reproductive efficiency in dairy cattle. *Veterinary Research Communications*, **17**, 95–107
- Aksoy, S., Maudlin, I., Dale, C., Robinson, A.S. and O'Neill, S.L. (2001) Prospects for the control of African trypanosomiasis by tsetse vector manipulation. *Trends in Parasitology*, **17**, 29–35
- Alba, A., Casal, J. and Domingo, M. (2004) Possible introduction of bluetongue into the Balearic Islands, Spain, in 2000, via air streams. *Veterinary Record*, **155**, 460–461
- Alban, L. (1995) Lameness in Danish dairy cows: frequency and possible risk factors. *Preventive Veterinary Medicine*, **22**, 213–225
- Alban, L., Agger, J.F. and Lawson, L.G. (1996) Lameness in tied Danish dairy cattle: the possible influence of housing systems, management, milk yield, and prior incidents of lameness. *Preventive Veterinary Medicine*, **29**, 135–149
- Albert, R.E., Alessandro, D., Lippmann, M. and Berger, J. (1971) Long-term smoking in the donkey. Effect on tracheo-bronchial particle clearance. *Archives of Environmental Health*, **22**, 12–19
- Alexander, K. and Appel, M. (1994) African wild dogs (*Lycaon pictus*) endangered by a canine distemper epizootic among domestic dogs near the Masai Mara National Reserve, Kenya. *Journal of Wildlife Diseases*, **30**, 481–485
- Alexander, K.A., Smith, J.S., Macharia, M.J. and King, A.A. (1993) Rabies in the Masai Mara, Kenya: a preliminary report. *Onderstepoort Journal of Veterinary Research*, **60**, 411–414
- Alexander, K.A., Kat, P.W., Munson, M.A., Kalake, A. and Appel, M.J.G. (1996) Canine distemper-related mortality among wild dogs (*Lycaon pictus*) in Chobe National Park, Botswana. *Journal of Zoo and Wildlife Medicine*, **27**, 426–427
- Alford, P., Geller, S., Richardson, B., Slater, M., Honnas, C., Foreman, J., Robinson, J., Messer, M., Roberts, M., Goble, D., Hood, D. and Chaffin, M. (2001) A multicenter, matched case-control study of risk factors for equine laminitis. *Preventive Veterinary Medicine*, **49**, 209–222
- Algers, B. and Hennichs, K. (1985) The effects of exposure to 400 kV transmission lines on the fertility of cows. A retrospective cohort study. *Preventive Veterinary Medicine*, **3**, 351–361
- Algers, B. and Hultgren, J. (1987) Effects of long-term exposure to a 400-kV, 50-Hz transmission line on oestrous and fertility in cows. *Preventive Veterinary Medicine*, **5**, 21–36
- Algers, B., Ekesbo, I. and Stromberg, S. (1978) The impact of continuous noise on animal health. *Acta Veterinaria Scandinavica*, **19**, Suppl. 67, 1–26
- Alitzer, S., Dobson, A.P., Harvell, C.D., Mitchell, C.E., Ostfeld, R.S., Samuel, M.D. and Ward, J.R. (2002) Climate warming and disease risks for terrestrial and marine biota. *Science*, **296**, 2158–2162
- Allan, F.J., Pfeiffer, D.U., Jones, B.R., Esslemont, D.H.B. and Wiseman, M.S. (2000) A cross-sectional study of risk factors for obesity in cats in New Zealand. *Preventive Veterinary Medicine*, **46**, 183–196
- Allsopp, R. (1998) Geographic information system (GIS) and remote sensing aid tsetse control in Botswana. *Pesticide Outlook*, **9** (4), 9–12
- Alonso-Andicoberry, C., García-Peña, F.J., Pereira-Bueno, J., Costas, E. and Ortega-Mora, L.M. (2001) Herd-level risk factors associated with *Leptospira* spp. seroprevalence in dairy and beef cattle in Spain. *Preventive Veterinary Medicine*, **52**, 109–117
- Altman, D.G. (1991a) *Practical Statistics for Medical Research*. Chapman and Hall, London
- Altman, D.G. (1991b) Randomisation – essential for reducing bias. *British Medical Journal*, **302**, 1481–1482
- Altman, D.G. (1996) Better reporting of randomised controlled trials: the CONSORT statement. *British Medical Journal*, **313**, 570–571
- Altman, D.G., Machin, D., Bryant, T.N. and Gardner, M.J. (Eds) (2000) *Statistics with Confidence*, 2nd edn. BMJ Books, London
- Alvarez, R.M., Amass, S.F., Anderson, C.D., Ragland, D., Grote, L.A., Dowell, C.A., Clark, L.K., Stevenson, G.W. and Spicer, P.M. (2001) Evaluation of biosecurity protocols to prevent mechanical transmission of transmissible gastroenteritis virus of swine by pork production unit personnel. *The Pig Journal*, **48**, 22–33
- Ambrosio, R.E. and de Waal, D.T. (1990) Diagnosis of parasitic disease. *Revue Scientifique et Technique, Office International des Epizooties*, **9**, 759–788
- Anand, K.J. and Craig, K.D. (1996) New perspectives in the definition of pain. *Pain*, **67**, 3–6
- Anderson, D.E. (1963) Genetic aspects of cancer with special reference to cancer of the eye in the bovine. *Annals of the New York Academy of Sciences*, **108**, 948–962
- Anderson, D.E., Lush, J.L. and Chambers, C. (1957) Studies on bovine ocular squamous carcinoma ('cancer eye'). II. Relationships between eyelid pigmentation and occurrence of cancer eye lesions. *Journal of Animal Science*, **16**, 739–746
- Anderson, E.C., Doughty, W.J. and Anderson, J. (1976) The role of sheep and goats in the epizootiology of foot-and-mouth disease in Kenya. *Journal of Hygiene, Cambridge*, **76**, 395–402
- Anderson, H., Henricson, B., Lundquist, P.-G., Wendenberg, H. and Wesall, J. (1968) Genetic hearing impairment in the Dalmatian dog. *Acta-otolaryngologica, Suppl.*, **232**, 1–34
- Anderson, I. (2002) *Foot and Mouth Disease 2001: Lessons to be Learned Inquiry*. The Stationery Office, London
- Anderson, J.F. (1988) Mammalian and avian hosts of *Borrelia burgdorferi*. *Annals of the New York Academy of Science*, **539**, 180–191
- Anderson, J.F. (1998) Biosecurity – a new term for an old concept: how to apply it. *Bovine Practitioner*, **32**, 61–70
- Anderson, K.L. (Ed.) (1993) Update on bovine mastitis. *Veterinary Clinics of North America: Food Animal Practice*, **9**, 421–630

- Anderson, P.L., Morrison, R.B., Molitor, T.W. and Thawley, D.G. (1990) Factors associated with circulation of pseudorabies virus within swine herds. *Journal of the American Veterinary Medical Association*, **196**, 877–884
- Anderson, R.C. (1984) The origins of zooparasitic nematodes. *Canadian Journal of Zoology*, **62**, 317–328
- Anderson, R.C. (2000) *Nematode Parasites of Vertebrates: Their Development and Transmission*, 2nd edn. CABI Publishing, Wallingford
- Anderson, R.J., Walker, R.L., Hird, D.W. and Blanchard, P.C. (1997) Case-control study of an outbreak of clinical disease attributable to *Salmonella menhaden* infection in eight dairy herds. *Journal of the American Veterinary Medical Association*, **210**, 528–530
- Anderson, R.M. (1979) The influence of parasitic infection on the dynamics of host population growth. In: *Population Dynamics*. Eds Anderson, R.M., Turner, B.D. and Taylor, L.R., pp. 245–281. Blackwell Scientific Publications, Oxford
- Anderson, R.M. (1981) Population ecology of infectious disease agents. In: *Theoretical Ecology*. Ed. May, R.M., pp. 318–355. Blackwell Scientific Publications, Oxford
- Anderson, R.M. and May, R.M. (1986) The invasion, persistence and spread of infectious diseases within animal and plant communities. *Philosophical Transactions of the Royal Society of London, Series B*, **314**, 533–570
- Anderson, R.M. and May, R.M. (1988) Epidemiological parameters of HIV infection. *Nature*, **333**, 514–518
- Anderson, R.M. and May, R.M. (1991) *Infectious Diseases of Humans: Dynamics and Control*. Oxford University Press, Oxford
- Anderson, R.S. (1983) Trends in pet populations. In: *Society for Veterinary Epidemiology and Preventive Medicine*, Proceedings, Southampton, 12–13 April 1983. Ed. Thrusfield, M.V., pp. 94–97
- Anderson, T.W. (1958) *An Introduction to Multivariate Statistical Analysis*. John Wiley, New York
- Andersson, H., Lexmon, Å., Robertsson, J.-Å., Lundeheim, N. and Wierup, M. (1997) Agricultural policy and social returns to eradication programs: the case of Aujeszky's disease in Sweden. *Preventive Veterinary Medicine*, **29**, 311–328
- Andersson, M. and Sevelius, E. (1991) Breed, sex and age distribution in dogs with chronic liver disease: a demographic study. *Journal of Small Animal Practice*, **32**, 1–5
- Andrewartha, H.G. and Birch, L.C. (1954) *The Distribution and Abundance of Animals*. University of Chicago Press, Chicago
- Andrewes, C. and Pereira, H.G. (1964) *Viruses of Vertebrates*. Baillière, Tindall and Cassell, London
- Andrews, J.M. and Langmuir, A.D. (1963) The philosophy of disease eradication. *American Journal of Public Health*, **53**, 1–6
- Andrews, L. (1988) Animal health information systems in Australia. *Revue Scientifique et Technique, Office International des Epizooties*, **7**, 569–575
- Angelos, J., Oppenheim, Y., Rebhun, W., Mohammed, H. and Antczak, D.F. (1988) Evaluation of breed as a risk factor for sarcoid and uveitis in horses. *Animal Genetics*, **19**, 417–425
- Animal Health Services (2004) Pooled prevalence calculator. AusVet Animal Health Services, 19 Brereton Street, P.O. Box 3180, South Brisbane, Queensland 4101, Australia. <http://www.ausvet.com.au/pprev/> (Accessed 7 December 2004)
- Anon. (1954) Age comparison between man and dog. *Journal of the American Veterinary Medical Association*, **124**, 236
- Anon. (1984) Tattoos to help keep track of pets. *Veterinary Practice*, **16** (20), 8
- Anon. (1985) Turkey rhinotracheitis of unknown aetiology in England and Wales. *Veterinary Record*, **117**, 653–654
- Anon. (1989) *Nutrient Requirements of Horses*, 5th edn. National Academy Press, Washington DC
- Anon. (1992) *Completing the Internal Market. Current Status, 1 January 1992. Veterinary and Plant Health Controls, Vol. 5*. Commission of the European Communities, Office for Official Publications of the European Communities, Luxembourg
- Anon. (1995) FECAVA to accept ISO standards on microchips. *Veterinary Record*, **136**, 306–308
- Anon. (1997) Wobbly possum disease virus thought to have been isolated. *Sentinel*, **62**, 1
- Anon. (2000) Microchipping: survey shows extent of veterinary support. *Veterinary Practice*, **32** (5), 1
- Ansell, J. (1992) Reliability: industrial risk assessment. In: *Risk Analysis, Assessment and Management*. Eds Ansell, J. and Wharton, F., pp. 105–122. John Wiley, Chichester
- Antinoff, N. (1999) Physical examination and preventive care of rabbits. *The Veterinary Clinics of North America, Exotic Animal Practice*, **2**, 405–427
- Anvik, J.O.I., Hague, A.E. and Rahaman, A. (1974) A method of estimating urban dog populations and its application to the assessment of canine fecal pollution and endoparasitism in Saskatchewan. *Canadian Veterinary Journal*, **15**, 219–223
- Appel, M.J. (Ed.) (1987) *Virus Infections of Vertebrates Vol. 1. Virus Infections of Carnivores*. Elsevier, Amsterdam
- Appleby, D.L., Bradshaw, J.W.S. and Casey, R.A. (2002) Relationship between aggressive and avoidance behaviour by dogs and their experience in the first six months of life. *Veterinary Record*, **150**, 434–438
- Appleby, M.C. and Hughes, B.O. (Eds) (1997) *Animal Welfare*. CABI Publishing, Wallingford
- Arámbulo, P.V. and Astudillo, V. (1991) Perspectives on the application of remote sensing and geographic information system to disease control and health management. *Preventive Veterinary Medicine*, **11**, 345–352
- Archer, D.C., Freeman, D.E., Doyle, A.J., Proudman, C.J. and Edwards, G.B. (2004) Association between cribbing and entrapment of the small intestine in the epiploic foramen in horses: 68 cases (1991–2002). *Journal of the American Veterinary Medical Association*, **224**, 562–564
- Archibald, A.L. and Imlah, P. (1985) The halothane sensitivity locus and its linkage relationships. *Animal Blood Groups and Biochemical Genetics*, **16**, 253–263
- Argyle, D.J. (1999) Gene therapy in veterinary medicine. *Veterinary Record*, **144**, 369–376
- Arimitsu, Y., Fukumura, K. and Shingaki, Y. (1989) Distribution of leptospirosis among stray dogs in the Okinawa Islands, Japan: comparison of the microcapsule and microscopic agglutination tests. *British Veterinary Journal*, **145**, 473–477
- Armenian, H.K. (1987) Incubation periods of cancer: old and new. *Journal of Chronic Diseases*, **40**, Suppl. 2, 9S–15S



- Armenian, H.K. and Lilienfeld, A.M. (1974) The distribution of incubation periods of neoplastic disease. *American Journal of Epidemiology*, **99**, 92–100
- Armitage, P. (1975) *Sequential Medical Trials*, 2nd edn. John Wiley and Sons, New York
- Armitage, P. and Doll, R. (1954) The age distribution of cancer and a multistage theory of carcinogenesis. *British Journal of Cancer*, **8**, 1–12
- Armitage, P., Berry, G. and Matthews, J.N.S. (2002) *Statistical Methods in Medical Research*, 4th edn. Blackwell Science, Oxford
- Armitage, P., McPherson, C.K. and Rowe, B.C. (1969) Repeated significance tests on accumulating data. *Journal of the Royal Statistical Society, Series A*, **132**, 235–244
- Arnold, S., Arnold, P., Hubler, M., Casal, M., and Rüschi, P. (1989) Incontinentia Urinae bei der kastrierten Hündin: Häufigkeit und Rassedisposition. *Schweizer Archiv für Tierheilkunde*, **131**, 259–263. (In German) English translation: Urinary incontinence in spayed bitches: prevalence and breed predisposition. *European Journal of Companion Animal Practice* (1992) **2**, 65–68
- Aroch, I. and Harrus, S. (1999) Retrospective study of the epidemiological, clinical, haematological and biochemical findings in 109 dogs poisoned by *Vipera xanthina palestinae*. *Veterinary Record*, **144**, 532–535
- Asby, C.G., Griffin, T.K., Ellis, P.R. and Kingwill, R.G. (1975) The Benefits and Costs of a System of Mastitis Control in Individual Herds. Study No. 17. University of Reading
- Ascione, F.R. and Arkow, P. (Eds) (1999) *Child Abuse, Domestic Violence and Animal Abuse*. Purdue University Press, West Lafayette
- Ashton, J. (Ed.) (1994) *The Epidemiological Imagination*. Open University Press, Buckingham
- Asplin, F.D. (1965) Duck hepatitis: vaccination against two serological types. *Veterinary Record*, **77**, 1529–1530
- Astudillo, V., Suttmoller, P., Saraiva, V. and Lopéz, A. (1997) Risks of introducing foot and mouth disease through the importation of beef from South America. *Revue Scientifique et Technique, Office International des Epizooties*, **16**, 33–44
- Atlas, R.M. and Bartha, R. (1998) *Microbial Ecology: Fundamentals and Applications*, 4th edn. Benjamin/Cummings, Menlo Park
- Atwill, E.R., Mohammed, H.O., Lopez, J.W., McCulloch, C.E. and Dubovi, E.J. (1996) Cross-sectional evaluation of environmental, host, and management factors associated with risk of seropositivity to *Ehrlichia risticii* in horses of New York state. *American Journal of Veterinary Research*, **57**, 278–285
- Aubert, M. (1994) Control of rabies in foxes: what are the appropriate measures? *Veterinary Record*, **134**, 55–59
- Aubert, M.F.A. (1999) Costs and benefits of rabies control in wildlife in France. *Revue Scientifique et Technique, Office International des Epizooties*, **18**, 533–543
- Audigé, L., Doherr, M.G., Hauser, R. and Salman, M.D. (2001) Stochastic modelling as a tool for planning animal-health surveys and interpreting screening-test results. *Preventive Veterinary Medicine*, **49**, 1–17
- Auditors (2004) The organisation of the system for the identification and registration of bovine animals in the European Union, together with the Commission's replies. Special Report No 6/2004. European Court of Auditors, Luxembourg
- Audy, J.R. (1958) The localisation of disease with special reference to the zoonoses. *Transactions of the Royal Society of Tropical Medicine and Hygiene*, **52**, 308–328
- Audy, J.R. (1960) *Relation of Foci of Zoonoses to Interspersed or Mosaic Vegetation*. Papers on the First WHO course on natural foci of infections, USSR
- Audy, J.R. (1961) The ecology of scrub typhus. In: *Studies in Disease Ecology*. Ed. May, J.M., pp. 389–432. Hafner Publishing Company, New York
- Audy, J.R. (1962) *Behavioral and Sociocultural Aspects of Natural Foci of Infections*. Papers of the Second WHO course on natural foci of infections, Leningrad
- Austin, C.C., Weigel, R.M., Hungerford, L.L. and Biehl, L.G. (1993) Factors affecting the risk of infection with pseudorabies virus in Illinois swine herds. *Preventive Veterinary Medicine*, **17**, 161–173
- Austin, S.M., Foreman, J.H. and Hungerford, L.L. (1995) Case-control study of risk factors for development of pleuropneumonia in horses. *Journal and the American Veterinary Medical Association*, **207**, 325–328
- Avgerou, C. and Cornford, T. (1993) *Developing Information Systems: Concepts, Issues and Practice*. The Macmillan Press, London
- Axelsson, M., Björnsdóttir, S., Eksell, P., Haggström, J., Sigurdsson, H. and Carlsten, J. (2001) Risk factors associated with hindlimb lameness and degenerative joint disease in the distal tarsus of Icelandic horses. *Preventive Veterinary Medicine*, **33**, 84–90
- Axford, R.F.E., Bishop, S.C. and Nicholas, F.W. (Eds) (2000) *Breeding for Disease Resistance in Farm Animals*, 2nd edn. CAB International, Wallingford
- Ayling, R.D., Bashiruddin, S.E. and Nicholas, R.A.J. (2004) *Mycoplasma* species and related organisms found from ruminants in Britain between 1990 and 2000. *Veterinary Record*, **155**, 413–416
- Ayres, E., Cameron, E., Kemp, R., Lietch, H., Mollison, A., Muir, I., Reid, H., Smith, D. and Sproat, J. (2001) Oral lesions in sheep and cattle in Dumfries and Galloway. *Veterinary Record*, **148**, 720–723
- Babudieri, B. (1958) Animal reservoirs of leptospirosis. *Annals of the New York Academy of Science*, **70**, 393–413
- Bachmann, I., Audigé, L. and Stauffacher, M. (2003) Risk factors associated with behavioural disorders of cribbiting, weaving and box-walking in Swiss horses. *Equine Veterinary Journal*, **35**, 158–163
- Bäckgren, A.W. (1965) Lymphatic leukosis in dogs. An epizootiological, clinical and haematological study. *Acta Veterinaria Scandinavica*, **6**, Suppl. 1, 1–80
- Bailey, C.J., Reid, S.W.J., Hodgson, D.R., Suann, C.J. and Rose, R.J. (1997) Risk factors associated with musculoskeletal injuries in Australian Thoroughbred racehorses. *Preventive Veterinary Medicine*, **32**, 47–55
- Bailey, C.J., Reid, W.J., Hodgson, D.R., Bourke, J.M. and Rose, R.J. (1998) Flat, hurdle and steeple racing: risk factors for musculoskeletal injury. *Equine Veterinary Journal*, **30**, 498–503
- Bailey, C.J., Reid, S.W.J., Hodgson, D.R. and Rose, R.J. (1999a) Factors associated with time until first race and

- career duration for Thoroughbred racehorses. *American Journal of Veterinary Research*, **60**, 1196–1200
- Bailey, C.J., Reid, S.W.J., Hodgson, D.R. and Rose, R.J. (1999b) Impact of injuries and disease on a cohort of two- and three-year-old thoroughbreds in training. *Veterinary Record*, **145**, 487–493
- Bailey, K.R. (1987) Inter-study differences: how should they influence the interpretation and analysis of results? *Statistics in Medicine*, **6**, 351–358
- Bailey, N.T.J. (1975) *The Mathematical Theory of Infectious Diseases*, 2nd edn. Charles Griffin and Company, London and High Wycombe
- Bailey, N.T.J. (1995) *Statistical Methods in Biology*, 3rd edn. Cambridge University Press, Cambridge
- Bailey, T.A., Sleigh, I.M., Anderson, S.J., Tarr, D.B. and Naldo, J.L. (2003) Development of CAPTIVE, a computerised record system for the bustard captive-breeding programme at the national Avian Research Center, Abu Dhabi. *International Zoo Yearbook*, **38**, 219–229
- Baker, A. (1973) Scientific method. In: *A Random Walk in Science*. Ed. Mendoza, E., p. 202. Institute of Physics, London and Bristol
- Baker, M. (1974) *Folklore and Customs of Rural England*. David and Charles, Newton Abbot
- Ballard, G.M. (1992) Industrial risk: safety by design. In: *Risk Analysis, Assessment and Management*. Eds Ansell, J. and Wharton, F., pp. 95–104. John Wiley, Chichester
- Baltussen, W.H.M., Altena, H., Bakker, C.M. and Van Rijnberk, D. (1988) *Results on Dutch Swine Breeding Herds in 1987*. Swine Extension Service and Agricultural Economics Research Institute, Rosmalen
- Bang, F.B. (1975) Epidemiological interference. *International Journal of Epidemiology*, **4**, 337–342
- Barger, I. (1997) Control by management. *Veterinary Parasitology*, **72**, 493–506
- Barger, I.A. (1996) Prospects for integration of novel parasite control options into grazing systems. *International Journal for Parasitology*, **26**, 1001–1007
- Barger, I.A., Dash, K.M. and Southcott, W.H. (1978) Epidemiology and control of liver fluke in sheep. In: *The Epidemiology and Control of Gastrointestinal Parasites of Sheep in Australia*. Eds Donald, A.D., Southcott, W.H. and Dineen, J.K., pp. 65–74. Division of Animal Health, Commonwealth Scientific and Industrial Research Organisation, Australia
- Barkema, H.W., Schukken, Y.H., Guard, C.L., Brand, A. and van der Weyden, G.C. (1991) Cesarean section in dairy cattle: a study of risk factors. In: *Proceedings of the Sixth International Symposium on Veterinary Epidemiology and Economics*, Ottawa, 12–16 August 1991. Ed. Martin, S.W., pp. 304–306
- Barker, C.G., Herrtage, M.E., Shanahan, F. and Winchester, B.G. (1988) Fucosidosis in English springer spaniels: Results of a trial screening programme. *Journal of Small Animal Practice*, **29**, 623–630
- Barling, K.S., McNeill, J.W., Thompson, J.A., Paschal, J.C., McCollum III, F.T., Craig, T.M. and Adams, L.G. (2000a) Association of serologic status for *Neospora caninum* with postweaning weight gain and carcass measurements in beef calves. *Journal of the American Veterinary Medical Association*, **9**, 1356–1360
- Barling, K.S., Sherman, M., Peterson, M.J., Thompson, J.A., McNeill, J.W., Craig, T.M. and Adams, L.G. (2000b) Spatial associations among density of cattle, abundance of wild canids, and seroprevalence to *Neospora caninum* in a population of beef calves. *Journal of the American Veterinary Medical Association*, **9**, 1361–1365
- Barling, K.S., McNeill, J.W., Paschal, J.C., McCollum III, F.T., Craig, T.M., Adams, L.G. and Thompson, J.A. (2001) Ranch-management factors associated with antibody seropositivity for *Neospora caninum* in consignments of beef calves in Texas, USA. *Preventive Veterinary Medicine*, **52**, 53–61
- Barnard, B.J.H., Van Der Lugt, J.J. and Mushi, E.Z. (1994) Malignant catarrhal fever. In: *Infectious Diseases of Livestock: with Special Reference to Southern Africa*, Eds Coetzer, J.A.W., Thomson, G.R. and Tustin, R.C., Vol. 2, pp. 946–957. Oxford University Press, Cape Town and Oxford
- Barnard, G.A. (1959) Control charts for stochastic processes. *Journal of the Royal Statistical Society, Series B*, **21** (2), 239–271
- Barnes, J. (Ed.) (1984) *The Complete Works of Aristotle*. 2 vols. Princeton University Press, Princeton
- Barnes, E.M., Mead, G.C. and Griffiths, N.M. (1973) The microbiology and sensory evaluation of pheasants hung at 5, 10 and 15 °C. *British Poultry Science*, **14**, 229–240
- Barnett, P., Garland, A.J.M., Kitching, R.P. and Schermbrucker, C.G. (2002) Aspects of emergency vaccination against foot-and-mouth disease. *Comparative Immunology, Microbiology and Infectious Diseases*, **25**, 345–364
- Barnett, P.V., Keel, P., Reid, S., Armstrong, R.M., Staham, R.J., Voyce, C., Aggarwal, N. and Cox, S.J. (2004) Evidence that high potency foot-and-mouth disease vaccine inhibits local virus replication and prevents the ‘carrier’ state in sheep. *Vaccine*, **22**, 1221–1232
- Barnett, T. and Whiteside, A. (2002) *AIDS in the Twenty-First Century*. Palgrave Macmillan, Basingstoke
- Barnett, V. (2003) *Sample Survey: Principles and Methods*, 3rd edn. Oxford University Press, New York
- Barnouin, J. (1991) Components of the diet in the dry period as risk factors for milk fever in dairy herds in France. *Preventive Veterinary Medicine*, **10**, 185–194
- Barnouin, J. and Chacornac, J.P. (1992) A nutritional risk factor for early metritis in dairy farms in France. *Preventive Veterinary Medicine*, **13**, 27–37
- Barnouin, J. and Chassagne, M. (1990) Components of the diet in the dry period as risk factors for placental retention in French dairy herds. *Preventive Veterinary Medicine*, **8**, 231–240
- Barnouin, J. and Chassagne, M. (2001) Predictive variables for the occurrence of early clinical mastitis in primiparous Holstein cows under field conditions in France. *Canadian Veterinary Journal*, **42**, 47–53
- Barr, C., Benefield, C., Bunce, B., Ridsdale, H. and Whittaker, M. (1986) *Landscape Changes in Britain*. Institute for Terrestrial Ecology, Huntingdon
- Barracrough, G. (Ed.) (1984) *The Times Atlas of World History*. Revised edn. Times Books, London
- Barrett, D.C. (2001) Biosecurity and herd health – a challenge for the 21st century. *Cattle Practice*, **9**, 97–103
- Barron, B.A. (1977) The effects of misclassification on the estimation of relative risk. *Biometrics*, **33**, 414–418

- Barry, D. and Carrington, M. (2004) Antigenic variation. In: *The Trypanosomiases*. Eds Maudlin, I., Holmes, P.H. and Miles, M.A., pp. 25–37. CAB Publishing, Wallingford
- Barry, J.D. and McCulloch, R. (2001) Antigenic variation in trypanosomes: enhanced phenotypic variation in a eukaryotic parasite. *Advances in Parasitology*, **49**, 1–70
- Barteling, S.J. (2002) Development and performance of inactivated vaccines against foot and mouth disease. *Revue Scientifique et Technique, Office International des Epizooties*, **21**, 577–588
- Bartges, J.W., Osborne, C.A., Lulich, J.P., Unger, L.K., Koehler, L.A., Bird, K.A., Clinton, C.W. and Davenport, M.P. (1994) Prevalence of cystine and urate uroliths in Bulldogs and urate uroliths in Dalmatians. *Journal of the American Veterinary Medical Association*, **204**, 1914–1918
- Bartholomew, M.J., Vose, D.J., Tollefson, L.R. and Travis, C.C. (2005) A linear model for managing the risk of antimicrobial resistance originating in food animals. *Risk Analysis*, **25**, 99–108
- Bartlett, M.S. (1957) Measles periodicity and community size. *Journal of the Royal Statistical Society, Series A*, **120**, 48–60. (Discussion: 60–70)
- Bartlett, P.C. and Miller, G.Y. (1993) Managerial risk factors for intramammary coagulase-positive staphylococci in Ohio dairy herds. *Preventive Veterinary Medicine*, **17**, 33–40
- Bartlett, P.C., Kaneene, J., Gibson, C.D., Erickson, R. and Mather, E.C. (1982) Development of a computerised dairy management and disease surveillance system: FAHRMX. In: Proceedings of the first symposium on computer applications in veterinary medicine. College of Veterinary Medicine, Mississippi State University, 13–15 October 1982, pp. 21–29
- Bartlett, P.C., Kaneene, J.B., Kirk, J.H., Wilke, M.A. and Martenuik, J.V. (1986) Development of a computerized dairy herd health data base for epidemiological research. *Preventive Veterinary Medicine*, **4**, 3–14
- Bartlett, P.C., Kirk, J.H., Mather, E.C., Gibson, C. and Kaneene, J.B. (1985) FAHRMX: A computerized dairy herd health management network. *The Compendium on Continuing Education for the Practicing Veterinarian*, **7**, S124–S133
- Bartlett, P.C., Miller, G.Y., Lance, S.E., Heider, L.E. and Anderson, C.R. (1992) Environmental and managerial risk factors of intramammary infection with coagulase-negative staphylococci in Ohio dairy herds. *Preventive Veterinary Medicine*, **14**, 129–142
- Barwick, R.S., Mohammed, H.O., McDonough, P.L. and White, M.E. (1997) Risk factors associated with the likelihood of leptospiral seropositivity in horses in the state of New York. *American Journal of Veterinary Research*, **58**, 1097–1103
- Basson, P.A. and Hofmeyer, J.M. (1973) Mortalities associated with wildlife capture operations. In: *The Capture and Care of Wild Animals*. Ed. Young, E., pp. 151–160. Human and Rousseau, Cape Town and Pretoria
- Bastos, A.D.S., Boshoff, C.I., Keet, D.F., Bengis, R.G. and Thomson, G.R. (2000) Natural transmission of foot-and-mouth disease virus between African buffalo (*Syncerus caffer*) and impala (*Aepyceros melampus*) in the Kruger National Park, South Africa. *Epidemiology and Infection*, **124**, 591–598
- Basu, S. and Basu, A. (1995) Comparison of several goodness-of-fit tests for the kappa statistic based on exact power and coverage probability. *Statistics in Medicine*, **14**, 347–356
- Batamuzi, E.K. and Kristensen, F. (1996) Urinary tract infection: The role of canine transmissible venereal disease. *Journal of Small Animal Practice*, **37**, 276–279
- Batamuzi, E.K., Kassuku, A.A. and Agger, J.F. (1992) Risk factors associated with canine transmissible venereal tumour in Tanzania. *Preventive Veterinary Medicine*, **13**, 13–17
- Bates, T. (1717–1719) A brief account of the contagious disease which raged among the milch cows near London, in the year 1714, and of the methods that were taken for suppressing it. *Philosophical Transactions of the Royal Society*, **30**, 872–885
- Bates, T.W., Carpenter, T.E. and Thurmond, M.C. (2003) Benefit–cost analysis of vaccination and preemptive slaughter as a means of eradicating foot-and-mouth disease. *American Journal of Veterinary Research*, **64**, 805–812
- Baudet, A.E.R.F. (1923) Mortality in ducks in the Netherlands caused by a filterable virus; fowl plague. *Tijdschrift Diergeneesk*, **50**, 455–459 (In Dutch)
- Baumann, M.P.O. (1990) The Nomadic Animal Health System (NAHA-System) in Pastoral Areas of Central Somalia and its Usefulness in Epidemiological Surveillance. MPVM Thesis. University of California–Davis
- Baxby, D. (1972) Smallpox-like virus from camels in Iran. *Lancet*, **2**, 1063
- Bayes, T. (1763) An essay towards solving a problem in the doctrine of chance. *Philosophical Transactions of the Royal Society*, **53**, 370–418
- Baylis, M. and Rawlings, P. (1998) Modelling the distribution and abundance of *Culicoides imicola* in Morocco and Iberia using climatic data and satellite imagery. In: *African Horse Sickness*. Eds Mellor, P.S., Baylis, M., Hamblin, C., Callisher, C.H. and Mertens, P.P.C., pp. 137–153. Springer, Vienna
- Baylis, M., Meiswinkel, R. and Venter, G.J. (1999) A preliminary attempt to use climate data and satellite imagery to model the abundance and distribution of *Culicoides imicola* (Diptera: Ceratopogonidae) in southern Africa. *Journal of the South African Veterinary Association*, **70**, 80–89
- Baylis, M., Mellor, P.S., Wittmann, E.J. and Rogers, D.J. (2001) Prediction of areas around the Mediterranean at risk of bluetongue by modelling the distribution of its vector using satellite imaging. *Veterinary Record*, **149**, 639–643
- Bazin, H. (2003) A brief history of the prevention of infectious diseases by immunisations. *Comparative Immunology, Microbiology and Infectious Diseases*, **26**, 293–308
- Beal, V.C. and McCallon, W.R. (1983) The use of mathematical models in animal disease program evaluation. In: Proceedings of the Third International Symposium on Veterinary Epidemiology and Economics. Arlington, Virginia, 6–10 September 1982, pp. 400–407. Veterinary Medical Publishing Company, Edwardsville
- Beard, T.C. (1973) The elimination of echinococcosis from Iceland. *Bulletin of the World Health Organization*, **48**, 653–660
- Beard, W.L. and Hayes, H.M. (1993) Risk factors for laryngeal hemiplegia in the horse. *Preventive Veterinary Medicine*, **17**, 57–63

- Beard, W.L., Bramlage, L.R., Schneider, R.L. and Embertson, R.M. (1994) Postoperative racing performance in Standardbreds and Thoroughbreds with osteochondrosis of the tarsocrural joint: 109 cases (1984–1990) *Journal of the American Veterinary Medical Association*, **204**, 1655–1659
- Beatty, B. (2000) Genetic manipulation of vectors: a potential novel approach for control of vector-borne diseases. *Proceedings of the National Academy of Sciences of the United States of America*, **97**, 10295–10297
- Beaudeau, F. and Fourichon, C. (1998) Estimating relative risk of disease from outputs of logistic regression when the disease is not rare. *Preventive Veterinary Medicine*, **36**, 243–256
- Beaudeau, F., Fourichon, C., Seegers, H. and Bareille, N. (2002) Risk of clinical mastitis in dairy herds with a high proportion of low individual milk somatic-cell counts. *Preventive Veterinary Medicine*, **53**, 43–54
- Beaudeau, F., Frankena, K., Fourichon, C., Seegers, H., Faye, B. and Noordhuizen, J.P.T.M. (1994) Associations between health disorders of French dairy cows and early and late culling within the lactation. *Preventive Veterinary Medicine*, **19**, 213–231
- Beaudeau, F., Seegers, H., Fourichon, C. and Hortet, P. (1998) Association between milk somatic cell counts up to 400 000 cells/ml and clinical mastitis in French Holstein cows. *Veterinary Record*, **143**, 685–687
- Bebak, J., Baumgarten, M. and Smith, G. (1997) Risk factors for bacterial gill disease in young rainbow trout (*Oncorhynchus mykiss*) in North America. *Preventive Veterinary Medicine*, **32**, 23–34
- Bech-Nielsen, S., Miller, G.Y., Bowman, G.L., Burkholder, R.H., Dodaro, S.J. and Palte, W.J. (1995) Risk factors identified as source of new infections (area spread) with pseudorabies (Aujeszky's disease) virus in 50 swine herds in a contiguous geographical area of Ohio. *Preventive Veterinary Medicine*, **23**, 53–64
- Beck, A.M. (1973) *The Ecology of Stray Dogs*. York Press, Baltimore
- Beck, E. and Strohmaier, K. (1987) Subtyping of European foot-and-mouth disease virus strains by nucleotide sequence determination. *Journal of Virology*, **61**, 1621–1629
- Becker, B.A. (1987) The phenomenon of stress: concepts and mechanisms associated with stress-induced response of the neuroendocrine system. *Veterinary Research Communications*, **11**, 443–456
- Becker, F.F. (1981) Recent concepts of initiation and promotion in carcinogenesis. *American Journal of Pathology*, **105**, 3–9
- Bedard, B.G., Martin, S.W. and Chinombo, D. (1993) A prevalence study of bovine tuberculosis and brucellosis in Malawi. *Preventive Veterinary Medicine*, **16**, 193–205
- Bedford, T. and Cooke, R. (2001) *Probabilistic Risk Analysis: Foundations and Methods*. Cambridge University Press, Cambridge
- Beech, M.W.H. (1911) *The Suk, Their Language and Folklore*. Clarendon Press, Oxford
- Beechinor, G. (1993) Regulatory and administrative implications of clinical trials. In: *Field Trial and Error*. Proceedings of the international seminar with workshops on the design, conduct and interpretation of field trials, Berg en Dal, Netherlands, 27–28 April 1993. Eds Noordhuizen, J.P.T.M., Frankena, K., Ploeger, H. and Nell, T., pp. 29–35. Epidecon, Wageningen
- Beers, M.H. and Berkow, R. (Eds) (1999) *The Merck Manual of Diagnosis and Therapy*, 17th edn. Merck Research Laboratories, Whitehouse Station
- Begg, C., Cho, M., Eastwood, S., Horton, R., Moher, D., Olkin, I., Pitkin, R., Rennie, D., Schulz, K.F., Simel, D. and Stroup, D.F. (1996) Improving the quality of reporting of randomised controlled trials – the CONSORT statement. *Journal of the American Veterinary Medical Association*, **286**, 637–639
- Behbehani, K. and Hassounah, O. (1976) The role of native and domestic animals in the dissemination of *Echinococcus* infection among dogs in the State of Kuwait. *Journal of Helminthology*, **50**, 275–280
- Beilage, G.B., Salge, H.-J., Krabbe, H. and Blaha, T. (1991) Untersuchungen zur Epidemiologie des seuchenhaften Spätabortes der Zuchtsauen (PRRS). *Collegium Veterinariarum*, **22**, 62–64 (In German)
- Belák, S. and Ballagi-Pordány, A. (1993) Application of the polymerase chain reaction (PCR) in veterinary diagnostic virology. *Veterinary Research Communications*, **17**, 55–72
- Belák, S., Ballagi-Pordány, A., Flensburg, J. and Virtanen, A. (1989) Detection of pseudorabies virus DNA sequences by the polymerase chain reaction. *Archives of Virology*, **108**, 279–286
- Bell, K.J. (1980) A study of productivity in sheep flocks. The application and evaluation of health and productivity programmes in south west Australia. In: Proceedings of the 10th Seminar of the Sheep and Beef Cattle Society of the New Zealand Veterinary Association. Lincoln College, Canterbury, 11–12 July 1980, pp. 108–114
- Bemis, D.A., Carmichael, L.E. and Appel, M.J. (1977) Naturally occurring respiratory disease in a kennel caused by *Bordetella bronchiseptica*. *Cornell Veterinarian*, **67**, 282–293
- Bender, A.P., Bender, G.P., Dorn, C.R. and Schneider, R. (1982) Association between canine benign and malignant neoplasms. *Preventive Veterinary Medicine*, **1**, 77–87
- Bender, A.P., Dorn, C.R. and Schneider, R. (1984) An epidemiologic study of canine multiple primary neoplasia involving the female and male reproductive systems. *Preventive Veterinary Medicine*, **2**, 715–731
- Bendinelli, M., Pistello, M., Matteucci, D., Lombardi, S., Baldinotti, F., Bandecchi, P., Ghilarducci, R., Ceccherini-Nelli, L., Garzelli, C., Poli, A., Esposito, F., Malvaldi, G. and Tozzini, F. (1993) Small animal model of AIDS and the feline immunodeficiency virus. *Advances in Experimental Medicine and Biology*, **335**, 189–202
- Bendixen, P.H. (1987) Notes about incidence calculations in observational studies (letter). *Preventive Veterinary Medicine*, **5**, 151–156
- Bendixen, P.H., Vilson, B., Ekesbo, I. and Astrand, D.B. (1986a) Disease frequencies of tied zero-grazing dairy cows and of dairy cows on pasture during summer and tied during winter. *Preventive Veterinary Medicine*, **4**, 291–306
- Bendixen, P.H., Vilson, B., Ekesbo, I. and Astrand, D.B. (1986b) Disease frequencies in Swedish dairy cows. I. Dystokia. *Preventive Veterinary Medicine*, **4**, 291–306
- Bendixen, P.H., Vilson, B., Ekesbo, I. and Astrand, D.B. (1987a) Disease frequencies in dairy cows in Sweden II. Retained placenta. *Preventive Veterinary Medicine*, **4**, 377–387

- Bendixen, P.H., Vilson, B., Ekesbo, I. and Astrand, D.B. (1987b) Disease frequencies in dairy cows in Sweden. III Parturient paresis. *Preventive Veterinary Medicine*, **5**, 87–97
- Bendixen, P.H., Vilson, B., Ekesbo, I. and Astrand, D.B. (1987c) Disease frequencies in dairy cows in Sweden IV. Ketosis. *Preventive Veterinary Medicine*, **5**, 99–109
- Bendixen, P.H., Vilson, B., Ekesbo, I. and Astrand, D.B. (1988a) Disease frequencies in dairy cows in Sweden. V. Mastitis. *Preventive Veterinary Medicine*, **5**, 263–274
- Bendixen, P.H., Vilson, B., Ekesbo, I. and Astrand, D.B. (1988b) Disease frequencies in dairy cows in Sweden VI. Trapped teat. *Preventive Veterinary Medicine*, **6**, 17–25
- Bendixen, P.H., Emanuelson, U., Forssberg, P. and Silferberg, L. (1993) Analysis of status of vaccination and development of fever in trotters in Sweden during an outbreak of influenza Type A2 (H3N8). *Preventive Veterinary Medicine*, **16**, 95–102
- Bengis, R.G. (1997) Animal health risks associated with the transportation and utilisation of wildlife products. *Revue Scientifique et Technique, Office International des Epizooties*, **16**, 104–110
- Bengis, R.G., Kock, R.A. and Fischer, J. (2002) Infectious animal diseases: the wildlife/livestock interface. *Revue Scientifique et Technique, Office International des Epizooties*, **21**, 53–65
- Benham, P.J.F. and Broom, D.M. (1989) Interactions between cattle and badgers at pasture with reference to bovine tuberculosis transmission. *British Veterinary Journal*, **145**, 226–241
- Benjamin, B. (1959) *Elements of Vital Statistics*. George Allen and Unwin, London
- Bennett, R.M. (1996) Willingness-to-pay measures of public support for farm animal welfare legislation. *Veterinary Record*, **139**, 320–321
- Bennett, S., Woods, T., Liyanage, W.M. and Smith, D.L. (1991) A simplified general method for cluster sampling surveys of health in developing countries. *World Health Statistics Quarterly*, **44**, 98–106
- Berentsen, P.B.M., Dijkhuizen, A.A. and Oskam, A.J. (1992a) A critique of published cost–benefit analyses of foot-and-mouth disease. *Preventive Veterinary Medicine*, **12**, 217–227
- Berentsen, P.B.M., Dijkhuizen, A.A. and Oskam, A.J. (1992b) A dynamic model for cost–benefit analyses of foot-and-mouth disease. *Preventive Veterinary Medicine*, **12**, 229–243
- Berg, A.-L., Reid-Smith, R., Larsson, M. and Bonnett, B. (1998) Case control study of feline Born disease in Sweden. *Veterinary Record*, **142**, 715–717
- Berger, L., Speare, R., Daszak, P., Green, D.E., Cunningham, A.A., Goggin, C.L., Slocombe, R., Ragan, M.A., Hyatt, A.D., McDonald, K.R., Hines, H.B., Lips, K.R., Marantelli, G. and Parkes, H. (1998) Chytridiomycosis causes amphibian mortality associated with population declines in the rainforests of Australia and Central America. *Proceedings of the National Academy of Sciences*, **95**, 9031–9036
- Berger, L., Speare, R. and Hyatt, A. (1999) Chytrid fungi and amphibian declines: overview, implications and further directions. In: *Declines and Disappearances of Australian Frogs*. Ed., Campbell, A., pp. 23–33. Environment Australia, Canberra
- Berghaus, R.D., O'Brien, D.P., Johnson, G.C. and Thorne, J.G. (2001) Risk factors for development of dysautonomia in dogs. *Journal of the American Veterinary Medical Association*, **218**, 1285–1290
- Bergsma, D.R. and Brown, K.S. (1971) White fur, blue eyes, and deafness in the domestic cat. *Journal of Heredity*, **62**, 171–185
- Bergsten, C. and Herlin, A.H. (1996) Sole haemorrhages and heel horn erosion in dairy cows: the influence of housing system on their prevalence and severity. *Acta Veterinaria Scandinavica*, **7**, 395–408
- Berkson, J. (1960) Smoking and cancer of the lung. *Proceedings of Staff Meeting of the Mayo Clinic*, **35**, 367–385
- Berkson, J. (1962) Mortality and marital status. *American Journal of Public Health*, **52**, 1318–1329
- Bernardo, T.M., Schotman, C.Y.L. and Chillaud, T. (1994) The future of international animal health reporting. In: *Proceedings of the 7th International Symposium on Veterinary Epidemiology and Economics*, Nairobi, 15–19 August 1994, Eds Rowlands, G.J., Kyule, M.N. and Perry, B.D. *The Kenya Veterinarian*, **18** (2), 44–46
- Bernoulli, M.D. (1766) Essai d'une nouvelle analyse de la mortalité causée par la petite vérole et des avantages de l'inoculation pour la prévenir. In: *Histoire de L'Académie Royale des Sciences, 1760, Avec les Mémoires de Mathématique et de Physique*. L'Imprimerie Royale, Paris. Translated in: Bradley, L. (1971) *Smallpox Inoculation: An Eighteenth Century Mathematical Controversy*. University of Nottingham Adult Education Department, Nottingham
- Berry, S.J., Strandberg, J.D., Saunders, W.J. and Coffey, D.S. (1986) Development of canine benign prostatic hyperplasia with age. *The Prostate*, **9**, 363–373
- Beskow, P., Nordqvist, M. and Wallgren, P. (1998) Relationships between selected climatic factors in fattening units and their influence on the development of respiratory diseases in swine. *Acta Veterinaria Scandinavica*, **39**, 49–60
- Beyer, W.H. (Ed.) (1968) *CRC Handbook of Probability and Statistics*, 2nd edn. The Chemical Rubber Company, Cleveland
- Beyer, W.H. (Ed.) (1981) *CRC Statistical and Mathematical Tables*, 26th edn. CRC Press Inc, Boca Raton
- Biberstein, E.L. (1999) Parasitism and pathogenicity. In: *Veterinary Microbiology*. Eds Hirsh, D.C. and Zee, Y.C., pp. 3–6. Blackwell Science, Oxford
- Bibikova, V.A. (1977) Contemporary views on the interrelationships between fleas and the pathogens of human and animal diseases. *Annual Review of Entomology*, **22**, 23–32
- Bielfelt, S.W., Redman, H.C. and McClellan, R.G. (1971) Sire- and sex-related differences in rates of epileptiform seizures in a purebred beagle dog colony. *American Journal of Veterinary Research*, **32**, 2039–2048
- Biggs, H.C. and Hare, K.M. (1994) Essential features of an integrated veterinary disease information system for Namibia. In: *Proceedings of the 7th International Symposium on Veterinary Epidemiology and Economics*, Nairobi, 15–19 August 1994. Eds Rowlands, G.J., Kyule, M.N. and Perry, B.D. *The Kenya Veterinarian*, **18** (2), 29–31
- Biggs, P.M. (1982) Vaccination. In: *The Control of Infectious Diseases in Farm Animals*, pp. 21–27. British Veterinary Association Trust Project on the future of animal health control, London
- Biggs, P.M. (1993) Developments in vaccines. In: *The Advancement of Veterinary Science. The Bicentenary Symposium Series. Volume 4: Veterinary Medicine – Growth Points and*

- Comparative Medicine*. Ed. Michell, A.R., pp. 13–27. CAB International, Wallingford
- Biggs, P.M., Milne, B.S., Frazier, J.A., McDougall, J.S. and Stuart, J.C. (1974) Lymphoproliferative disease in turkeys. *Proceedings of the World's Poultry Congress*, **15**, 55–56
- Bigras-Poulin, M., Meek, A.H., Martin, S.W. and McMillan, I. (1990) Health problems in selected Ontario Holstein cows: frequency of occurrences, time to first diagnosis and associations. *Preventive Veterinary Medicine*, **10**, 79–89
- Binns, S.H., Dawson, S., Speakman, A.J., Cuevas, L.E., Gaskell, C.J., Hart, C.A., Morgan, K.L. and Gaskell, R.M. (1999) Prevalence and risk factors for feline *Bordetella bronchiseptica* infection. *Veterinary Record*, **144**, 575–580
- Binns, S.H., Bailey, M. and Green, L.E. (2002a) Post survey of ovine caseous lymphadenitis in the United Kingdom between 1990 and 1999. *Veterinary Record*, **150**, 263–268
- Binns, S.H., Cox, I.J., Rizvi, S. and Green, L.E. (2002b) Risk factors for lamb mortality on UK sheep farms. *Preventive Veterinary Medicine*, **52**, 287–303
- Biziere, K. and Chambon, J.P. (1987) Modèles animaux d'épilepsie et crises expérimentales. *Revue Neurologique (Paris)*, **143**, 329–340
- Black, A. (1972) Progressive retinal atrophy: a review of the genetics and an appraisal of the eradication scheme. *Journal of Small Animal Practice*, **13**, 295–314
- Black, F.L. (1975) Infectious diseases in primitive societies. *Science*, **187**, 515–518
- Black, R.E., Levine, M.M., Clements, M.L., Hughes, T.P. and Blaser, M.J. (1988) Experimental *Campylobacter jejuni* infection in humans. *Journal of Infectious Diseases*, **157**, 472–479
- Blackmore, D.K. (1963) The incidence and aetiology of thyroid dysplasia in budgerigars (*Melopsittacus undulatus*). *Veterinary Record*, **75**, 1068–1072
- Blackmore, D.K. (1964) A survey of disease in British wild foxes (*Vulpes vulpes*). *Veterinary Record*, **76**, 527–533
- Blackmore, D.K. (1983) Practical problems associated with the slaughter of stock. In: *Stunning of Animals for Slaughter*. Ed. Eikelenboom, G., pp. 167–178. Martin Nijhoff Publishers, The Hague
- Blackmore, D.K. and Hathaway, S.C. (1980) The nidality of zoonoses. In: *Veterinary Epidemiology and Economics*. Proceedings of the Second International Symposium, Canberra, 7–11 May 1979. Eds Geering, W.A., Roe, R.T. and Chapman, L.A., pp. 207–213. Australian Government Publishing Service, Canberra
- Blackmore, D.K. and Schollum, L.M. (1983) The serological investigation of occupational exposure to leptospirosis. In: Proceedings of the Third International Symposium on Veterinary Epidemiology and Economics, Arlington, 6–10 September, 1982, pp. 544–551. Veterinary Medical Publishing Company, Edwardsville
- Blackmore, D.K., Hill, A. and Jackson, O.F. (1971) The incidence of mycoplasma in pet and colony maintained cats. *Journal of Small Animal Practice*, **12**, 207–216
- Blaha, T. (Ed.) (1989) *Applied Veterinary Epidemiology*. Elsevier, Amsterdam
- Blaha, T. (1992) Regional eradication of swine dysentery by gradual elimination of the pathogen from infected herds. In: Society for Veterinary Epidemiology and Preventive Medicine, Proceedings, Edinburgh, 1–3 April 1992. Ed. Thrusfield, M.V., pp. 186–189
- Blaisdell, J.D. (1994) The Curse of the Pharaohs: anthrax in Ancient Egypt. *Bulletin van het Veterinari Historisch Genootschap*, **10**, 311–314
- Blajan, L. (1979) The systems for veterinary information at the national and worldwide levels. *Bulletin Office International des Epizooties*, **91**, 795–821
- Blajan, L. and Chillaud, T. (1991) The OIE world animal disease information system. *Revue Scientifique et Technique, Office International des Epizooties*, **10**, 71–87
- Blajan, L. and Welte, V.R. (1988) Information, a prerequisite for veterinary activities. *Revue Scientifique et Technique, Office International des Epizooties*, **7**, 463–478
- Blake, A., Sinclair, M.T. and Sugiyarto, G. (2003) Quantifying the impact of foot and mouth disease on tourism and the UK economy. *Tourism Economics*, **9**, 449–465
- Blamire, R.V., Crowley, A.J. and Goodhand, R.H. (1970) A review of some animal diseases encountered at meat inspection 1960–1968. *Veterinary Record*, **87**, 234–238
- Blamire, R.V., Goodhand, R.H. and Taylor, K.C. (1980) A review of some animal diseases encountered at meat inspections in England and Wales, 1969 to 1978. *Veterinary Record*, **106**, 195–199
- Blancou, J. (2001) A history of the traceability of animals and animal products. *Revue Scientifique et Technique, Office International des Epizooties*, **20**, 420–425
- Bland, J.M. and Altman, D.G. (1986) Statistical methods for measuring agreement between two methods of clinical measurement. *Lancet*, **1**, 307–310
- Bland, M. (2000) *An Introduction to Medical Statistics*, 3rd edn. Oxford University Press, Oxford
- Blikslager, A.T., Bowman, K.F., Levine, J.F., Bristol, D.G. and Roberts, M.C. (1994) Evaluation of factors associated with post-operative ileus in horses: 31 cases (1990–1992). *Journal of the American Veterinary Medical Association*, **205**, 1742–1752
- Bloch, D.A. and Kraemer, H.C. (1989) 2 × 2 kappa coefficients: measures of agreement or association. *Biometrics*, **45**, 269–287
- Blood, D.C. (1976) The principles of herd health programmes. In: Proceedings Number 28. Refresher course for veterinarians on mastitis, pp. 47–64. The University of Sydney Post-graduate Committee on Veterinary Science in association with the Australian Veterinary Association and the Veterinary Clinic Centre, University of Melbourne
- Blood, D.C. and Henderson, J.A. (1960) *Veterinary Medicine*, Baillière, Tindall and Cox, London
- Blood, D.C. and Studdert, V.P. (2002) *Saunders Comprehensive Veterinary Dictionary*, 2nd edn. W.B. Saunders, London
- Blood, D.C., Morris, R.S., Williamson, N.B., Cannon, C.M. and Cannon, R.M. (1978) A health program for commercial dairy herds. 1. Objectives and methods. *Australian Veterinary Journal*, **54**, 207–215
- Blot, W.J. and Day, N.E. (1979) Synergism and interaction: are they equivalent? *American Journal of Epidemiology*, **110**, 99–100
- Blowey, R. and Edmondson, P. (1995) *Mastitis Control in Dairy Herds*. Farming Press Books, Ipswich
- Blowey, R. and Edmondson, P. (2000a) *Mastitis Control in Dairy Herds: An Illustrated and Practical Guide*, revised reprint. Farming Press, Ipswich

- Blowey, R. and Edmondson, P. (2000b) The environment and mastitis. *In Practice*, **22**, 382–394
- Blowey, R.W. and Collis, K. (1992) Effect of premilking teat disinfection on mastitis incidence, total bacterial count and milk yield in three dairy herds. *Veterinary Record*, **130**, 175–178
- Bodey, A.R. and Sansom, J. (1998) Epidemiological study of blood pressure in domestic cats. *Journal of Small Animal Practice*, **39**, 567–573
- Bodin, J. (1580) *De la Demonomanie des Sorciers*. Jacques du Puys, Paris. (Quoted by Summers, 1994)
- Bodoh, G.W., Battista, W.J., Schultz, L.H. and Johnston, R.P. (1976) Variation in somatic cell counts in dairy improvement milk samples. *Journal of Dairy Science*, **59**, 1119–1123
- Bodson, L. (1994) Ancient views on pests and parasites of livestock. *Argos*, **10**, 303–310
- Bollett, A.J. (1973) Pierre Louis: The numerical method and the foundation of quantitative medicine. *American Journal of Medical Science*, **266**, 92–101
- Bolton, J.F. (1968) A case of foot-and-mouth disease in sheep. *The State Veterinary Journal*, **23**, 61–64
- Bond, R., Ferguson, E.A., Curtis, C.F., Craig, J.M. and Lloyd, D.H. (1996) Factors associated with elevated cutaneous *Malassezia pachydermatis* populations in dogs with pruritic skin disease. *Journal of Small Animal Practice*, **37**, 103–107
- Bonnett, B.N., Egenvall, A., Olson, P. and Hedhammar, Å. (1997) Mortality in insured Swedish dogs: rates and causes of death in various breeds. *Veterinary Record*, **141**, 40–44
- Booket, C.W., Guichaon, P.T., Jim, G.K., Schunicht, O.C., Harland, R.J. and Morley, P.S. (1999) Seroepidemiology of undifferentiated fever in feedlot calves in western Canada. *Canadian Veterinary Journal*, **40**, 40–48
- Booth, A.J., Stagdale, L. and Gregor, J.A. (1984) Salmon poisoning disease in dogs in Southern Vancouver Island. *Canadian Veterinary Journal*, **25**, 2–6
- Booth, J.M. (1989) Lameness in dairy cattle. *Veterinary Record*, **125**, 161
- Booth, J.M. and Warren, M.E. (1984) The use of a computerised herd fertility monitor. In: Society for Veterinary Epidemiology and Preventive Medicine. Proceedings, Edinburgh, 10–11 July 1984. Ed. Thrusfield, M.V., pp. 166–173
- Booth, M. (1998) The application of attributable risk analysis in helminth epidemiology. *Parasitology Today*, **14**, 497–500
- Boqvist, S., Chau, B.L., Gunnarsson, A., Olsson Engvall, E., Vågsholm, I. and Magnusson, U. (2002) Animal- and herd-level risk factors for leptospiral seropositivity among sows in the Mekong Delta, Vietnam. *Preventive Veterinary Medicine*, **53**, 233–245
- Bor, A., Winkler, M. and Gootwine, E. (1989) Non-clinical intramammary infection in lactating ewes and its association with clinical mastitis. *British Veterinary Journal*, **145**, 178–184
- Bording, A. (1990) The clinical trial in veterinary practice. In: Proceedings of the International Pig Veterinary Society, 11th Congress, Lausanne, 1–5 July 1990, p. 413. Swiss Association of Swine Medicine, Berne
- Borg, K. and Hugoson, G. (1980) Wildlife as an indicator of environmental disturbances. In: *Veterinary Epidemiology and Economics*, Proceedings of the Second International Symposium. Eds Geering, W.A., Roe, R.T. and Chapman, L.A., pp. 250–253. Australian Government Publishing Service, Canberra
- Borsberry, S. and Dobson, H. (1989) Periparturient diseases and their effect on reproductive performance in five dairy herds. *Veterinary Record*, **124**, 217–219
- Bostock, D.E. and Curtis, R. (1984) Comparison of canine oropharyngeal malignancy in various geographical locations. *Veterinary Record*, **114**, 341–342
- Bouma, A., de Jong, M.C.M. and Kimman, T.G. (1995) Transmission of pseudorabies virus within populations is independent of the size of the population. *Preventive Veterinary Medicine*, **23**, 163–172
- Bouma, A., Elbers, A.R.W., Dekker, A., de Koeijer, A., Bartels, C., Vellema, P., van der Wal, P., van Rooij, E.M.A., Pluimers, F.H. and de Jong, M.C.M. (2003) The foot-and-mouth disease epidemic in The Netherlands in 2001. *Preventive Veterinary Medicine*, **57**, 155–166
- Boundy, T. (1998) Routine ram examination. In: *Sheep and Goat Practice 2*. Eds Melling, M. and Alder, M., pp. 1–18. W.B. Saunders, London
- Bourn, D. and Blench, R. (1999) *Can Livestock and Wildlife Co-exist? An Interdisciplinary Approach*. Overseas Development Institute, London
- Bourne, F.J. (1993) Biotechnology and farm animal medicine. In: *The Advancement of Veterinary Science. The Bicentenary Symposium Series. Volume 1: Veterinary Medicine beyond 2000*. Ed. Michell, A.R., pp. 41–57. CAB International, Wallingford
- Bouwknegt, M., van de Giessen, A.W., Dam-Deisz, W.D.C., Havelaar, A.H., Nagelkerke, N.J.D. and Henken, A.M. (2004) Risk factors for the presence of *Campylobacter* spp. in Dutch broiler flocks. *Preventive Veterinary Medicine*, **62**, 35–49
- Bovee, K.C. and McGuire, T. (1984) Qualitative and quantitative analysis of uroliths in dogs: definitive determination of chemical type. *Journal of the American Veterinary Medical Association*, **185**, 983–987
- Boycott, J.A. (1971) *Natural History of Infectious Disease*. Studies in Biology No. 26. Edward Arnold, London
- Bradbury, J.A. (1989) The policy implications of differing concepts of risk. *Science, Technology & Human Values*, **14**, 380–399
- Bradbury, T. (1989) *Meteorology and Flight*. A&C Black, London
- Bradshaw, J.W.S., Goodwin, D., Lea, A.M. and Whitehead, S.L. (1996) A survey of the behavioural characteristics of pure-bred dogs in the United Kingdom. *Veterinary Record*, **138**, 465–468
- Bradshaw, J.W.S., McPherson, J.A., Casey, R.A. and Larter, I.S. (2002) Aetiology of separation-related behaviour in domestic dogs. *Veterinary Record*, **151**, 43–46
- Brand, A., Noordhuizen, J.P.T.M. and Schukken, Y.H. (1996) *Herd Health and Production Management in Dairy Practice*. Wageningen Pers, Wageningen
- Brandeis, L.J. (1971) Business: a profession. In: *Reprints of Economic Classics*, pp. 1–12. A.M. Kelley, New York
- Braverman, Y. and Chechik, F. (1993) Air streams and the introduction of animal diseases borne on *Culicoides* (Diptera, Ceratopogonidae) into Israel. *Israeli Journal of Veterinary Medicine*, **48**, 1–9



- Braverman, Y., Ungar-Waron, H., Frith, K., Adler, H., Danieli, Y., Baker, K.P. and Quinn, P.J. (1983) Epidemiological and immunological studies of sweet itch in horses in Israel. *Veterinary Record*, **112**, 521–524
- Bredal, W.P. (1998) *Pneumonyssoides caninum* infection – a risk factor for gastric dilatation-volvulus in dogs. *Veterinary Research Communications*, **22**, 225–231
- Brenner, H. and Gefeller, O. (1997) Variation in sensitivity, specificity, likelihood ratios and predictive values with disease prevalence. *Statistics in Medicine*, **16**, 981–991
- Breslow, N.E. and Day, N.E. (1980) *Statistical Methods in Cancer Research, Vol.1: The Analysis of Case-Control Studies*. IARC Scientific Publications No. 32. International Agency on Cancer Research, Lyon
- Breslow, N.E. and Day, N.E. (1987) *Statistical Methods in Cancer Research, Vol.2: The Design and Analysis of Cohort Studies*. IARC Scientific Publications No. 82. International Agency on Cancer Research, Lyon
- Britannica (1992) *The New Encyclopædia Britannica*, 15th edn, Macropædia, vol. 25, pp. 630–636. Encyclopædia Britannica, Chicago
- Broadbent, D.W. (1979) Field collection of animal disease data in developing countries. *World Animal Review*, **29**, 38–42
- Brock, W.H. (2002) Crookes, carbolic and cattle plague. *Endeavour*, **26**, 87–91
- Brodey, R.S. (1970) Canine and feline neoplasia. *Advances in Veterinary Science and Comparative Medicine*, **14**, 309–354
- Brodey, R.S. (1979) The use of naturally occurring cancer in domestic animals for research into human cancer: general considerations and a review of canine skeletal osteosarcoma. *Yale Journal of Biology and Medicine*, **52**, 345–361
- Brodey, R.S., Fidler, I.J. and Howson, B.A. (1966) Relationship of oestrus irregularity, pseudopregnancy, and pregnancy to the development of mammary neoplasia. *Journal of the American Veterinary Medical Association*, **149**, 1047–1049
- Brodey, R.S., McDonough, S.F., Frye, F.L. and Hardy, W.D. (1970) Epidemiology of feline leukemia (lymphosarcoma). In: Proceedings of the 4th International Symposium on Comparative Leukaemia Research, Cherry Hill, New Jersey. Ed. Dutcher, R.M. *Bibliotheca Haematologica*, **36**, 333–342
- Bronson, R.T. (1981) Age at death of necropsied intact and neutered cats. *American Journal of Veterinary Research*, **42**, 1606–1608
- Bronson, R.T. (1982) Variation in age at death of dogs of different sexes and breeds. *American Journal of Veterinary Research*, **43**, 2057–2059
- Brooksby, J.B. (1972) Epizootiology of foot-and-mouth disease in developing countries. *World Animal Review*, **1**, 10–13
- Brooksby, J.B. (Ed.) (1983) The aerial transmission of disease. *Philosophical Transactions of the Royal Society of London, Series B*, **302**, 439–604
- Brossard, M. (1998) The use of vaccines and genetically resistant animals in tick control. *Revue Scientifique et Technique, Office International des Epizooties*, **17**, 188–199
- Broström, H. (1995) Equine sarcoids. A clinical and epidemiological study in relation to equine leucocyte antigens (ELA). *Acta Veterinaria Scandinavica*, **36**, 223–236
- Broström, H. and Larsson, A. (1987) Allergic dermatitis (sweet itch) of Icelandic horses in Sweden: an epidemiological study. *Equine Veterinary Journal*, **19**, 229–236
- Brothwell, D. and Sandison, A.T. (Eds) (1967) *Diseases in Antiquity*. Charles C. Thomas, Springfield
- Brown, C. and Bolin, C.A. (2000) *Emerging Diseases of Animals*. ASM Press, Washington
- Brown, D.J. (2002) FMD in a parturient sheep flock. (Letter). *Veterinary Record*, **151**, 127
- Brown, J.L. (1964) The evolution of diversity in avian territorial systems. *Wilson Bulletin*, **76**, 160–169
- Brown, M. (Ed.) (2000) *HACCP in the Meat Industry*. Woodhead Publishing, Abington
- Brown, N., Parks, J.L. and Greene, R.W. (1977) Canine urolithiasis: retrospective analysis of 438 cases. *Journal of the American Veterinary Medical Association*, **170**, 414–418
- Brownlee, J. (1915) Historical note on Farr's theory of the epidemic. *British Medical Journal*, **ii**, 250–252
- Brunn, J., Ersbøll, A.K. and Alban, L. (2002) Risk factors for metritis in Danish dairy cows. *Preventive Veterinary Medicine*, **54**, 179–190
- Brunsdon, R.V. (1980) Principles of helminth control. *Veterinary Parasitology*, **6**, 185–215
- Bruzzi, P., Green, S.B., Byer, D.P. and Brunton, L.A. (1985) Estimating the population attributable risk for multiple risk factors using case-control data. *American Journal of Epidemiology*, **122**, 904–914
- Bryans, J.T. (1964) Viral respiratory disease of horses. *Proceedings of the American Veterinary Medical Association*, **101**, 112–121
- Bryson, R.W. (1982) Kikuyu poisoning and the army worm. *Journal of the South African Veterinary Association*, **53**, 161–165
- BSI (1979) *Precision of test methods. I. Guide for the determination of repeatability and reproducibility for a standard test method for inter-laboratory tests*. BS 5497, Part 1. British Standards Institution, London
- Buchanan, J.W. (1977) Chronic valvular disease (endocardiosis) in dogs. *Advances in Veterinary Science*, **21**, 75–106
- Bucher, H.C., Weinbacher, M. and Gyr, K. (1994) Influence of method of reporting a study on decision of physicians to prescribe drugs to lower cholesterol concentration. *British Medical Journal*, **309**, 761–764
- Buck, C. (1975) Popper's philosophy for epidemiologists. *International Journal of Epidemiology*, **4**, 159–168 (comment: 169–172)
- Buck, W.B. (1979) Animals as monitors of environmental quality. *Veterinary and Human Toxicology*, **21**, 277–284
- Buckland, S.T., Anderson, D.R., Burnham, K.P. and Laake, J.L. (1993) *Distance Sampling*. Chapman and Hall, London
- Buddle, B.M., Skinner, M.A., Wedlock, D.N., Collins, D.M. and de Lisle, G.W. (2002) New generation vaccines and delivery systems for control of bovine tuberculosis in cattle and wildlife. *Veterinary Immunology and Immunopathology*, **87**, 177–185
- Buescher, E.L., Scherer, W.F., McClure, H.E., Moyer, J.T., Rosenberg, M.Z., Yoshii, M. and Okada, Y. (1959) Ecologic studies of Japanese encephalitis virus in Japan. IV. Avian infection. *American Journal of Tropical Medicine and Hygiene*, **8**, 678–688
- Buik, B. (2004) Flying high: air travel and lung disease. *Biologist*, **51**, 181–184
- Buisch, W.W., Hall, A.E. and McDaniel, H.A. (1984) 1983–1984 lethal avian influenza outbreak. *Proceedings of the United States Animal Health Association*, **88**, 430–446



- Bulfield, G., Siller, W.G., Wight, P.A. and Moore, K.J. (1984) X chromosome-linked muscular dystrophy (*mdx*) in the mouse. *Proceedings of the National Academy of Sciences*, **81**, 1189–1192
- Bullock, W.L. (1992) The origin of species and the origins of disease: a tale of two theories. *Perspectives on Science and the Christian Faith*, **44**, 36–44
- Bulmer, M.G. (1994) *Theoretical Evolutionary Ecology*. Sinauer Associates, Sunderland
- Bulpitt, C.J. (1983) *Randomised Controlled Clinical Trials*. Martinus Nijhoff Publishers, The Hague
- Bumstead, N. (1998) Genetic resistance to avian viruses. *Revue Scientifique et Technique, Office International des Epizooties*, **17**, 249–255
- Burch, P.R.J. (1966) Age and sex distributions for some idiopathic non-malignant conditions in man. Some possible implications for growth-control and natural and radiation-induced aging. In: *Radiation and Ageing*. Proceedings of a Colloquium held in Semmering, Austria, 23–24 June 1966. Eds Lindop, P.J. and Sacher, G.A., pp. 117–155. Taylor and Francis, London
- Burchell, A. (1983) Economic evaluation of health schemes. In: *Society for Veterinary Epidemiology and Preventive Medicine*, Proceedings, Southampton, 12–13 April 1983. Ed. Thrusfield, M.V., pp. 148–155
- Burgdorfer, W. (1960) Colorado tick fever: II The behaviour of Colorado tick fever virus in rodents. *Journal of Infectious Diseases*, **107**, 384–388
- Burger, H.J. (1976) Trichostrongyle infestation in autumn on pastures grazed exclusively by cows or by calves. *Veterinary Parasitology*, **1**, 359–366
- Burnet, M. and White, D.O. (1972) *Natural History of Infectious Disease*, 4th edn. Cambridge University Press, London
- Burridge, M.J. and McCarthy, S.M. (1979) The Florida veterinary clinical data retrieval system. In: *Proceedings of an International Symposium on Animal Health and Disease Data Banks*, 4–6 December 1978, Washington DC, pp. 155–161. United States Department of Agriculture. Miscellaneous Publication Number 1381
- Burridge, M.J., Simmons, L.-A., Peter, T.F. and Mahan, S.M. (2002) Increasing risks of introduction of heartwater onto the American Mainland associated with animal movements. In: *The Domestic Animal/Wildlife Interface: Issues for Disease Control, Conservation, Sustainable Food Production, and Emerging Diseases*. *Annals of the New York Academy of Sciences*, Vol. 969, Eds Gibbs, E.P.J. and Bokma, B.H., pp. 269–274. The New York Academy of Sciences, New York
- Busato, A., Trachsel, P., Schällibaum, M. and Blum, J.W. (2000) Udder health and risk factors for subclinical mastitis in organic dairy farms in Switzerland. *Preventive Veterinary Medicine*, **44**, 205–220
- Bush, E.G. and Gardner, A. (1995) Animal health surveillance in the United States via the National Animal Health Monitoring System (NAHMS). *Épidémiologie et Santé Animale*, **27**, 113–126
- Butler, J.R.A. and Bingham, J. (2000) Demography and dog-human relationships of the dog population in Zimbabwean communal lands. *Veterinary Record*, **147**, 442–446
- Butler, M.P., Graveling, R.A., Pilkington, A. and Boyle, A.L. (1999) *Non-auditory Effects of Noise at Work: A Critical Review of the Literature Post 1988*. HSE Books, Sudbury
- Byrt, T., Bishop, J. and Carlin, J.B. (1993) Bias, prevalence and kappa. *Journal of Clinical Epidemiology*, **46**, 423–429
- Cable, J. and Harris, P. (2003) Fish parasites: the fish farmer's foe. *Biologist*, **50**, 178–182
- Cagienard, A., Regula, G. and Danuser, J. (2002) The impact of different housing systems on the health and welfare of grower and finisher pigs. In: *Society for Veterinary Epidemiology and Preventive Medicine*, Proceedings, Cambridge, 3–5 April 2002, Eds Menzies, F.D. and Reid, S.W.J., pp. 120–126
- Cain, C.E. (1999) Results from zooarchaeological analysis at Axum, Ethiopia. *Archaeozoologia*, **10**, 27–46
- Calabrese, E.J. (1986) Animal extrapolation and the challenge of human heterogeneity. *Journal of Pharmaceutical Sciences*, **75**, 1041–1046
- Caldow, G., Edwards, S., Nixon, P. and Peters, A.R. (1988) Associations between viral infection and respiratory disease in young beef bulls. *Veterinary Record*, **122**, 529–531
- Caldow, G., Gunn, G., Humphry, R., Crawshaw, M. and Rushbridge, S. (2001) Biosecurity and screening for disease. *Irish Veterinary Journal*, **54**, 461–470
- Caldow, G.L. (1984) The potential for veterinary involvement in the reproductive management of beef suckler herds. MSc Thesis. University of Edinburgh
- Caley, P., Hickling, G.J., Cowan, P.E. and Pfeiffer, D.U. (1999) Effects of sustained control of brushtail possums on levels of *Mycobacterium bovis* infection in cattle and brushtail possum populations from Hohotaka, New Zealand. *New Zealand Veterinary Journal*, **47**, 133–142
- Caley, P., Hone, J. and Cowan, P.E. (2001) The relationship between prevalence of *Mycobacterium bovis* infection in feral ferrets and possum abundance. *New Zealand Veterinary Journal*, **49**, 195–200
- Callens, M., De Clercq, K., Gruia, M. and Danes, M. (1998) Detection of foot and mouth disease by reverse transcription polymerase chain reaction and virus contact sheep without clinical signs of foot-and-mouth disease. *The Veterinary Quarterly*, **20**, Supplement 2, S37–S40
- Calnek, B.W. (Ed.) (1991) *Diseases of Poultry*, 9th edn. Iowa State University Press, Ames
- Calvete, C., Estrada, R., Villafuerte, R., Osácar, J.J. and Lucientes, J. (2002) Epidemiology of viral haemorrhagic disease and myxomatosis in a free-living population of wild rabbits. *Veterinary Record*, **150**, 776–782
- Cameron, A.R. and Baldock, F.C. (1998a) A new probability formula for surveys to substantiate freedom from disease. *Preventive Veterinary Medicine*, **34**, 1–17
- Cameron, A.R. and Baldock, F.C. (1998b) Two-stage sampling in surveys to substantiate freedom from disease. *Preventive Veterinary Medicine*, **34**, 19–30
- Cameron, D. and Jones, I.G. (1983) John Snow, the Broad Street pump and modern epidemiology. *International Journal of Epidemiology*, **12**, 393–396
- Cameron, J. and Wade-Gery, W. (1995) Addressing uncertainty. In: *Environmental Policy in Search of New Instruments*. Ed. Dente, B., pp. 95–142. Kluwer Academic Publishers, Dordrecht
- Campbell, C.L. (1989) Geographical information system applications in animal health. Proceedings of the 93rd Annual Meeting of the United States Animal Health

- Association. Las Vegas, Nevada, 28 October–3 November 1989, pp. 47–62
- Campbell, H. and Brown, R. (2003) *Benefit–Cost Analysis: Financial and Economic Appraisal Using Spreadsheets*. Cambridge University Press, Cambridge
- Campbell, J.R., Menzies, P., Waltner-Toews, D., Walton, J.W., Buckrell, B. and Thorsen, J. (1991) An epidemiological study of maedi-visna in Ontario sheep flocks. In: *Proceedings of the Sixth International Symposium on Veterinary Epidemiology and Economics*, Ottawa, 12–16 August 1991. Ed. Martin, S.W., pp. 373–375
- Campbell, M.J., Julious, S.A. and Altman, D.G. (1995) Estimating sample sizes for binary, ordered categorical and continuous outcomes in two group comparisons. *British Medical Journal*, **311**, 1145–1148
- Campbell, J.R., Carpenter, P., Sneiderman, C., Cohn, S.P. and Oliver, D.E. (1997) Phase II evaluation of clinical coding schemes: completeness, taxonomy, mapping, definitions, and clarity. *Journal of the American Medical Informatics Association*, **4**, 238–251
- Cané, B.G., Rodríguez Toledo, J., Faczuk, A., Leanes, L.F., Manetti, J.C., Maradei, E. and Verde, P. (1995) Quantitative risk analysis applied to innocuity and potency tests on the oil-adjuvanted vaccine against foot and mouth disease in Argentina. *Revue Scientifique et Technique, Office International des Epizooties*, **14**, 1109–1119
- Canner, P.L., Krol, W.F. and Forman, S.A. (1983) External quality control programs. *Controlled Clinical Trials*, **4**, 441–466
- Cannon, R. (1993) ANADIS: Monitoring and eradication of brucellosis and tuberculosis in Australia. *Agricultural Systems and Information Technology*, **5** (1), 11–13
- Cannon, R.M. (2001) Sense and sensitivity – designing surveys based on an imperfect test. *Preventive Veterinary Medicine*, **49**, 141–163
- Cannon, R.M. and Roe, R.T. (1982) *Livestock Disease Surveys: A Field Manual for Veterinarians*. Australian Government Publishing Service, Canberra
- Cannon, R.M., Morris, R.S., Williamson, N.B., Cannon, C.M. and Blood, D.C. (1978) A health program for commercial dairy herds. 2. Data processing. *Australian Veterinary Journal*, **54**, 216–230
- Cannon, W.B. (1914) The emergency function of the adrenal medulla in pain and major emotions. *American Journal of Physiology*, **33**, 356–372
- Caplan, G. and Grunebaum, H. (1967) Perspectives on primary prevention: A review. *Archives of General Psychiatry*, **17**, 331–346
- Caporale, V., Giovannini, A., Di Francesco, C. and Calistri, P. (2001) Importance of traceability of animals and animal products in epidemiology. *Revue Scientifique et Technique, Office International des Epizooties*, **20**, 372–378
- Cardinale, E., Tall, F., Guèye, E.F., Cisse, M. and Salvat, G. (2004) Risk factors for *Campylobacter* spp. infection in Senegalese broiler-chicken flocks. *Preventive Veterinary Medicine*, **64**, 15–25
- Carles, A.B. (1986) The levels of, and constraints to, productivity of goats and sheep at Ngurunit in Marsabit District. In: *Smallstock and Cattle Productivity, Nutrition and Disease in Northern Kenya*. Integrated Project in Arid Lands, Technical Report No. E-8. Ed. Field, C.R., pp. 33–118. UNESCO, Nairobi
- Carles, A.B. (1992) The non-medicinal prevention of live-stock disease in African rangeland ecosystems. *Preventive Veterinary Medicine*, **12**, 165–173
- Carmichael, L.E. and Binn, L.N. (1981) New enteric viruses in the dog. *Advances in Veterinary Science and Comparative Medicine*, **25**, 1–37
- Carmichael, L.E., Strandberg, J.D. and Barnes, F.D. (1965) Identification of a cytopathogenic agent infectious for puppies as a canine herpesvirus. *Proceedings of the Society of Experimental Biology and Medicine*, **120**, 644–650
- Carpenter, F.L., Paton, D.C. and Hixon, M.A. (1983) Weight gain and adjustment of feeding territory size in migrant hummingbirds. *Proceedings of the National Academy of Sciences*, **80**, 7269–7263
- Carpenter, L.V., Gay, J.M., Ebel, E.D. and Hancock, D.D. (1995) A case-control study of Washington dairy herds experiencing drug residue violations in market calves. *Preventive Veterinary Medicine*, **23**, 143–151
- Carpenter, T.E. (1988) Stochastic epidemiologic modeling using a microcomputer spreadsheet package. *Preventive Veterinary Medicine*, **5**, 159–168
- Carpenter, T.E. (2001) Methods to investigate spatial and temporal clustering in veterinary epidemiology. *Preventive Veterinary Medicine*, **48**, 303–320
- Carruthers, I. and Chambers, R. (1981) Rapid appraisal for rural development. *Agricultural Administration*, **8**, 407–422
- Carson, R.L. (1963) *Silent Spring*. Hamish Hamilton, London
- Carter, H.B. (1939) Longevity and fertility in South African merino stud ewes. *Pastoral Review and Graziers' Record*, **49**, 266–267
- Carter, C.A. and Hule, J. (2004) Market effects of searching for mad cows. *ARE Update*, **8** (1), 5–7. Giannini Foundation of Agricultural Economics, University of California
- Cartwright, S.F. and Huck, R.A. (1967) Viruses isolated in association with herd infertility, abortions and stillbirths in pigs. *Veterinary Research*, **81**, 196–197
- Casal, J., Moreso, J.M., Planas-Cuchí, E. and Casal, J. (1997) Simulated airborne spread of Aujeszky's disease and foot-and-mouth disease. *Veterinary Record*, **140**, 672–676
- Case, J.T. (1994) SNOMED (review). *Preventive Veterinary Medicine*, **21**, 269–273
- Case, L.C., Ling, G.V., Ruby, A.L., Johnston, D.L., Franti, C.E. and Stevens, F. (1993) Urolithiasis in Dalmatians: 275 cases (1981–1990). *Journal of the American Veterinary Medical Association*, **203**, 96–100
- Casella, G. and Berger, R.L. (1987) Reconciling Bayesian and frequentist evidence in the one-sided testing problem. *Journal of the American Statistical Association*, **82**, 106–111 (comment: 112–137)
- Cason, R. and Geering, W.A. (1980) An economic evaluation of possible Australian policies to meet the threat of an exotic pest – the screw-worm fly, *Chrysomya bezziana*. In: *Veterinary Epidemiology and Economics*. Proceedings of the Second International Symposium, Canberra, 7–11 May 1979. Eds Geering, W.A., Roe, R.T. and Chapman, L.A., pp. 463–470. Australian Government Publishing Service, Canberra
- Casswell, S.A. (1966) A simplified calculation of maximum vertical velocities in mountain lee waves. *Meteorological Magazine*, **95**, 68–80

- Castle, M.D. and Christensen, B.M. (1990) Hematazoa of wild turkeys from the midwestern United States: translocation of wild turkeys and its potential role in the introduction of *Plasmodium kempfi*. *Journal of Wildlife Diseases*, **26**, 180–185
- Caswell, J.A. and Hooker, N.H. (1996) HACCP as an international trade standard. *American Journal of Agricultural Economics*, **78**, 775–779
- Catanzaro, T.E. and Hall, T.H. (2002) *Veterinary Medicine and Practice 25 Years in the Future and the Economic Steps to Get There*. Iowa State Press, Ames
- Catley, A. (1999) *Methods on the Move: A Review of Veterinary Uses of Participatory Approaches and Methods Focussing on Experiences in Dryland Africa*. International Institute for Environment and Development, London
- Catley, A. (2000) The use of participatory appraisal by veterinarians in Africa. *Revue Scientifique et Technique, Office International des Epizooties*, **19**, 702–714
- Catley, A. (2004) Validation of participatory appraisal for use in animal-health information systems in Africa. PhD Thesis, University of Edinburgh
- Catley, A. and Leyland, T. (2001) Community participation and the delivery of veterinary services in Africa. *Preventive Veterinary Medicine*, **49**, 95–113
- Catley, A. and Mariner, J. (Eds) (2001) *Participatory Epidemiology: Lessons Learned and Future Directions*. Proceedings of an international workshop held in Addis Ababa, Ethiopia, 15–17 November 2001. Organization of African Unity/Interafrican Bureau of Animal Resources, Nairobi
- Catley, A., Blakeway, S. and Leyland, T. (Eds) (2002a) *Community-based Animal Health Care: a Practical Guide to Improving Primary Veterinary Services*. ITDG Publishing, London
- Catley, A., Irungu, P., Simiyu, K., Dadye, J., Mwakio, W., Kiragu, J. and Nyamwaro, S.O. (2002b) Participatory investigations of bovine trypanosomiasis in Tana River District, Kenya. *Medical and Veterinary Entomology*, **16**, 55–66
- Catley, A., Chibunda, R.T., Ranga, E., Makunu, S., Magayane, F.T., Magoma, G., Madege, M.J. and Vosloo, W. (2004) Participatory diagnosis of heat-intolerance syndrome in cattle in Tanzania and association with foot-and-mouth disease. *Preventive Veterinary Medicine*, **65**, 17–30
- Cave, T.A., Thompson, H., Reid, S.W.J., Hodgson, D.R. and Addie, D.D. (2002) Kitten mortality in the United Kingdom: a retrospective analysis of 274 histopathological examinations (1986 to 2000). *Veterinary Record*, **151**, 497–501
- Cavirani, S., Cabassi, C.S., Donofrio, G., De Iaco, B., Taddei, S. and Flammini, C.F. (2001) Association between *Chlamydia psittaci* seropositivity and abortion in Italian dairy cows. *Preventive Veterinary Medicine*, **50**, 145–151
- CEC (2000) *Communication from the Commission on the Precautionary Principle*. Commission of the European Communities, Brussels
- Cecchini, G., Bekele, T. and Kasali, O.B. (1992) The effect of repeated freezing and thawing of serum on the activity of antibodies. *Veterinary Research Communications*, **16**, 425–428
- CEPS (2002) *The Precautionary Principle in the European Union & Its Impact on International Trade Relations*. Centre for European Policy Studies, Place du Congrès 1, B-1000 Brussels
- Çetinkaya, B., Erdogan, H.M. and Morgan, K.L. (1998) Prevalence, incidence and geographical distribution of Johne's disease in cattle in England and the Welsh borders. *Veterinary Record*, **143**, 265–269
- Chaffin, M.K., Cohen, N.D. and Martens, R.J. (2003a) Evaluation of equine breeding farm characteristics as risk factors for development of *Rhodococcus equi* pneumonia in foals. *Journal of the American Veterinary Medical Association*, **222**, 467–475
- Chaffin, M.K., Cohen, N.D. and Martens, R.J. (2003b) Evaluation of equine breeding farm management and preventative health practices as risk factors for development of *Rhodococcus equi* pneumonia in foals. *Journal of the American Veterinary Medical Association*, **222**, 476–485
- Chaffin, M.K., Cohen, N.D., Martens, R.J., Edwards, R.F. and Nevill, M. (2003c) Foal-related risk factors associated with development of *Rhodococcus equi* pneumonia on farms with endemic infection. *Journal of the American Veterinary Medical Association*, **223**, 1791–1799
- Chain, P. (1980) Public participation and communications in Latin American disease control programs. In: *Veterinary Epidemiology and Economics*. Proceedings of the Second International Symposium, Canberra, 4–11 May 1979. Eds Geering, W.A., Roe, R.T. and Chapman, L.A., pp. 335–340. Australian Government Publishing Service, Canberra
- Chalmers, A.W. (1968) African horse sickness. *Equine Veterinary Journal*, **1**, 83–86
- Chalmers, I., Enkin, M. and Keirse, M.J.N.V. (1989) *Effective Care in Pregnancy and Childbirth*. Oxford University Press, Oxford
- Chamberlain, A.T. and Wassell, T.R. (1995) The size and cost of the estimation error when using analysis of a sample of a dairy herd to assess the whole herd performance. *Preventive Veterinary Medicine*, **23**, 65–71
- Chambers, R. (1983) *Rural Development: Putting the Last First*. Longman Scientific and Technical, New York
- Chambers, R. (1997) *Whose Reality Counts? Putting the Last First*. Intermediate Technology Publications, London
- Chapman, P.A. (2000) Sources of *Escherichia coli* O157 and experiences over the past 15 years in Sheffield, UK. *Journal of Applied Microbiology Symposium Supplement*, **88**, 51S–60S
- Chapman, R.N. (1928) The quantitative analysis of environmental factors. *Ecology*, **9**, 111–122
- Chapman, R.N. (1931) *Animal Ecology with Special Reference to Insects*. McGraw Hill, New York
- Charette, R.N. (1989) *Software Engineering Risk Analysis and Management*. McGraw-Hill, New York
- Charles, D.R. and Payne, C.G. (1966) The influence of graded levels of atmospheric ammonia on chickens. II Effects on the performance of laying hens. *British Poultry Science*, **7**, 189–198
- Chavkin, M.J., Roberts, S.M., Salman, M.D., Severin, G.A. and Scholten, N.J. (1994) Risk factors for development of chronic superficial keratitis in dogs. *Journal of the American Veterinary Medical Association*, **204**, 1630–1634
- Cheeseman, C.L., Jones, G.W., Gallagher, J. and Mallinson, P.J. (1981) The population structure, density and prevalence of tuberculosis (*Mycobacterium bovis*) in badgers (*Meles meles*) from four areas in south-west England. *Journal of Applied Ecology*, **18**, 795–804

- Chenoweth, P.J. and Sanderson, M.W. (2001) Health and production management in beef cattle breeding herds. In: *Herd Health: Food Animal Production Medicine*, 3rd edn. Ed. Radostits, O.M., pp. 509–580, W.B. Saunders, Philadelphia
- Chesney, C.J. (2001) Systematic review of evidence for the prevalence of food sensitivity in dogs. *Veterinary Record*, **148**, 445–448
- Chesterton, R.N., Pfeiffer, D.U., Morris, R.S. and Tanner, C.M. (1989) Environmental and behavioural factors affecting the prevalence of foot lameness in New Zealand dairy herds – a case-control study. *New Zealand Veterinary Journal*, **37**, 135–142
- Cheville, N.F. (1975) The gray collie syndrome (cyclic neutropenia). *Journal of the American Animal Hospital Association*, **11**, 350–352
- Chiang, C.C. (1984) *The Life Table and Its Applications*. Robert E. Kreiger, Malabar
- Chihota, C.M., Gravenor, M.B. and Baylis, M. (2004) Investigation of trace elements in soil as risk factors in the epidemiology of scrapie. *Veterinary Record*, **154**, 809–813
- Childs, J.E., Robinson, L.E., Sadek, R., Madden, A., Miranda, M.E. and Miranda, N.L. (1998) Density estimates of rural dog populations and an assessment of marking methods during a rabies vaccination campaign in the Philippines. *Preventive Veterinary Medicine*, **33**, 207–218
- Chomel, B.B. (1998) New emerging zoonoses: a challenge and an opportunity for the veterinary profession. *Clinical Immunology, Microbiology and Infectious Diseases*, **21**, 1–14
- Chriél, M., Stryhn, H. and Dauphin, G. (1999) Generalised linear mixed models analysis of risk factors for contamination of Danish broiler flocks with *Salmonella typhimurium*, **40**, 1–17
- Christenson, J. and Robinson, J. (1980) *Community Development in America*. Iowa State University Press, Iowa
- Christensen, J., Ellegaard, B., Petersen, B.K., Willeberg, P. and Mousing, J. (1994) Pig health and production surveillance in Denmark: sampling design, data recording and measures of disease frequency. *Preventive Veterinary Medicine*, **20**, 47–61
- Christensen, L.S., Mousing, J., Mortensen, S., Soerensen, K.J., Strandbygaard, S.B., Henriksen, C.A. and Andersen, J.B. (1990) Evidence of long distance transmission of Aujeszky's disease (pseudorabies) virus. *Veterinary Record*, **127**, 471–474
- Christensen, L.S., Mortensen, S., Bøtner, A., Strandbygaard, S.B., Rønsholt, L., Henriksen, C.A. and Andersen, J.B. (1993) Further evidence of long distance airborne transmission of Aujeszky's disease (pseudorabies) virus. *Veterinary Record*, **132**, 317–321
- Christiansen, K.H. (1980) Laboratory management and disease surveillance information system. In: *Veterinary Epidemiology and Economics*. Proceedings of the Second International Symposium, Canberra, 7–11 May, 1979. Eds Geering, W.A., Roe, R.T. and Chapman, L.A., pp. 59–64. Australian Government Publishing Service, Canberra
- Christley, R.M. and French, N.P. (2003) Small-world topology of UK racing: the potential for rapid spread of infectious agents. *Equine Veterinary Journal*, **35**, 586–589
- Christley, R.M., Wood, J.L.N., Reid, S.W.J., Hodgson, D.R., Rosie, R.J. and Hodgson, J.L. (1999) Risk factors for coughing in thoroughbred racehorses. In: Society for Veterinary Epidemiology and Preventive Medicine, Proceedings, Bristol, 24–26 March 1999, Eds Goodall, E.A. and Thrusfield, M.V., pp. 197–210
- Christley, R.M., Hodgson, D.R., Rose, R.J., Hodgson, J.L., Wood, J.L.N. and Reid, S.W.J. (2001) Coughing in thoroughbred racehorses: risk factors and tracheal endoscopic and cytological findings. *Veterinary Record*, **148**, 99–104
- Christley, R.M., Morgan, K.L., Parkin, T.D.H. and French, N.P. (2003) Factors related to the risk of neonatal mortality, birth-weight and serum immunoglobulin concentration in lambs in the UK. *Preventive Veterinary Medicine*, **57**, 209–226
- Chung, S.I., Livingston, C.W., Jones, C.W. and Collisson, E.W. (1991) Cache Valley virus infection in Texas sheep flocks. *Journal of the American Veterinary Medical Association*, **199**, 337–340
- Cicchetti, D.V. and Allison, T. (1971) A new procedure for assessing reliability of scoring EEG sleep recordings. *American Journal of EEG Technology*, **11**, 101–109
- Cimino, J.J. (1998) Desiderata for controlled medical vocabularies in the twenty-first century. *Methods of Information in Medicine*, **37**, 394–403
- Clarke, A. (1987) Air hygiene and equine respiratory disease. *In Practice*, **9**, 196–204
- Clarke, K.C., Osleeb, J.P., Sherry, J.M., Meert, J.P. and Larsson, R.W. (1991) The use of remote sensing and geographic information systems in UNICEF's dracunculiasis (Guinea worm) eradication effort. *Preventive Veterinary Medicine*, **11**, 229–235
- Clarkson, M.J. and Winter, A.C. (1997) *A Handbook for the Sheep Clinician*, 5th edn. Liverpool University Press, Liverpool
- Clatterbaugh, K.C. (1999) *The Causation Debate in Modern Philosophy*, 1637–1739. Routledge, London
- Clavijo, A. and Kitching, P. (2003) Foot-and-mouth disease: epidemiology and current situation. *Biologist*, **50**, 208–212
- Clavijo, A., Wright, P. and Kitching, R.P. (2004) Developments in diagnostic techniques for differentiating infection from vaccination in foot-and-mouth disease. *The Veterinary Journal*, **167**, 9–22
- Clayton, D. and McKeigue, P.M. (2001) Epidemiological methods for studying genes and environmental factors in complex diseases. *The Lancet*, **358**, 1356–1360
- Clemens, J., Sack, D., Rao, M., Chakraborty, J., Kay, B., Ahmed, F., Khan, M.R., van Loon, F.P.L., Svennerholm, A.-M. and Holmgren, J. (1993) The design and analysis of cholera vaccine trials: recent lessons from Bangladesh. *International Journal of Epidemiology*, **22**, 724–730
- Clement, J.C., King, M.E., Salman, M.D., Wittum, T.E., Casper, H.H. and Odde, K.G. (1995) Use of epidemiologic principles to identify risk factors associated with the development of diarrhea in calves in five beef herds. *Journal of the American Veterinary Medical Association*, **207**, 1334–1338
- Clements, A.C.A., Pfeiffer, D.U., Otte, M.J., Morteo, K. and Chen, L. (2002) A global livestock production and health atlas (GLiPHA) for interactive presentation, integration and analysis of livestock data. *Preventive Veterinary Medicine*, **56**, 19–32
- Clewell, D.B. (Ed.) (1993) *Bacterial Conjugation*. Plenum Press, New York

- Cliff, A.D. and Haggett, P. (1988) *Atlas of Disease Distributions: Analytic Approaches to Epidemiological Data*. Basil Blackwell, Oxford
- Cliff, A.D. and Ord, J.K. (1981) *Spatial Processes. Models and Applications*. Pion, London
- Clifton-Hadley, R. (1993) The use of a geographical information system (GIS) in the control and epidemiology of bovine tuberculosis in south-west England. In: Society for Veterinary Epidemiology and Preventive Medicine, Proceedings, Exeter, 31 March–2 April 1993. Ed. Thrusfield, M.V., pp. 166–179
- Coburn, H.L., Snary, E.L. and Wooldridge, M. (2003) *Hazards and Risks from Wild Game: A Qualitative Risk Assessment*. Centre for Epidemiology & Risk Analysis, Veterinary Laboratories Agency, Weybridge
- Coburn, H.L., Snary, E.L., Kelly, L.A. and Wooldridge, M. (2005) Qualitative risk assessment of the hazards and risks from wild game. *Veterinary Record*, **157**, 321–322
- Cochran, W.G. (1950) The comparison of percentages in matched samples. *Biometrika*, **37**, 256–266
- Cockburn, A. (1963) *The Evolution and Eradication of Infectious Diseases*. Johns Hopkins Press, Baltimore
- Cockroft, P. and Holmes, M.A. (2003) *Handbook of Evidence-Based Veterinary Medicine*. Blackwell Publishing, Oxford
- Cockroft, P.D. (2002) Clinical sign profile likelihood ratios for bovine spongiform encephalopathy suspects. *Research in Veterinary Science*, **68**, 285–290
- Codd, G.A., Edwards, C., Beattie, K.A., Barr, W.M. and Gunn, G.J. (1992) Fatal attraction to cyanobacteria? (letter). *Nature*, **359**, 110–111
- Codex Alimentarius Commission (1999) *Principles and Guidelines for the Conduct of Microbial Risk Assessment*. CAC/GL-30. Food and Agriculture Organization of the United Nations, Rome
- Cogger, N., Evans, D., Hodgson, D., Perkins, N. and Reid, S.W.J. (2003) Risk factors for musculoskeletal injuries in two-year-old Thoroughbred mares. In: Society for Veterinary Epidemiology and Preventive Medicine, Proceedings, Warwick, 31 March–2 April 2003. Eds Reid, S.W.J. and Menzies, F.D., pp. 109–118
- Cohen, D., Booth, S. and Sussman, O. (1959) An epidemiological study of canine lymphoma and its public health significance. *American Journal of Veterinary Research*, **20**, 1026–1031
- Cohen, D., Brodey, R.S. and Chen, S.M. (1964) Epidemiologic aspects of oral and pharyngeal neoplasms of the dog. *American Journal of Veterinary Research*, **25**, 1776–1779
- Cohen, D., Reif, J.S., Brodey, R.S. and Keiser, H. (1974) Epidemiologic analysis of the most prevalent sites and types of canine neoplasia observed in a veterinary hospital. *Cancer Research*, **34**, 2859–2868
- Cohen, J.M. and Uphof, N.T. (1980) Participation's place in rural development: seeking clarity through specificity. *World Development*, **8**, 213–235
- Cohen, J.T., Duggar, K., Gray, G.M., Kreindel, S., Abdelrahman, H., Habtemariam, T., Oryang, D. and Tameru, B. (2001) *Evaluation of the Potential for Bovine Spongiform Encephalopathy in the United States*. <http://www.aphis.usda.gov/lpa/issues/bse/bse-riskassmt.html> (Accessed 23rd January 2006)
- Cohen, M.L. (2000) Changing patterns of infectious disease. *Nature*, **406**, 762–767
- Cohen, M.R. and Nagel, E. (1934) *An Introduction to Logic and Scientific Method*. Routledge and Kegan Paul, London
- Cohen, N.D. (1994) Causes of and farm management factors associated with disease and death in foals. *Journal of the American Veterinary Medical Association*, **204**, 1644–1651
- Cohen, N.D. and Peloso, J.G. (1996) Risk factors for history of previous colic and for chronic, intermittent colic in a population of horses. *Journal of the American Veterinary Medical Association*, **208**, 697–703
- Cohen, N.D., Parson, E.M., Seahorn, T.L. and Carter, G.K. (1994) Prevalence and factors associated with development of laminitis in horses with duodenitis/proximal jejunitis; 33 cases (1985–1991). *Journal of the American Veterinary Medical Association*, **204**, 250–254
- Cohen, N.D., Matejka, P.L., Honnas, C.M. and Hooper, R.N. (1995a) Case-control study of the association between various management factors and development of colic in horses. *Journal of the American Veterinary Medical Association*, **206**, 667–673
- Cohen, N.D., Matejka, P.L., Honnas, C.M. and Hooper, R.N. and the Texas Colic Study Group (1995b) Private practitioner-based case-control study of management factors associated with equine colic. *Proceedings of the American Association of Equine Practitioners*, **41**, 181–183
- Cohen, N.D., Peloso, J.G., Mundy, G.D., Fisher, M., Holland, R.E., Little, T.V., Misheff, M.M., Watkins, J.P., Honnas, C.M. and Moyer, W. (1997) Racing-related factors and results of prerace physical inspection and their association with musculoskeletal injuries incurred in Thoroughbreds during races. *Journal of the American Veterinary Medical Association*, **211**, 454–463
- Cohen, N.D., Carey, V.J., Donahue, J.G., Seahorn, J.L., Donahoe, J.K., Williams, D.M. and Harrison, L.R. (2003a) Case-control study of late-term abortions associated with mare reproductive loss syndrome in central Kentucky. *Journal of the American Veterinary Medical Association*, **222**, 199–209
- Cohen, N.D., Donahue, J.G., Carey, V.J., Seahorn, J.L., Piercy, D., Donahoe, J.K., Williams, D.M., Brown, S.E. and Riddle, T.W. (2003b) Case-control study of abortions (early fetal losses) associated with mare reproductive loss syndrome in central Kentucky. *Journal of the American Veterinary Medical Association*, **222**, 210–217
- Coker-Vann, M., Brown, P. and Gajdusek, D.C. (1984) Serodiagnosis of human cysticercosis using a chromatofocused antigen preparation of *Taenia solium* cysticerci in an enzyme-linked immunosorbent assay (ELISA). *Transactions of the Royal Society of Tropical Medicine and Hygiene*, **78**, 492–496
- Colam-Ainsworth, P., Lunn, G.A., Thomas, R.C. and Eddy, R.G. (1989) Behaviour of cows in cubicles and its possible relationship with laminitis in replacement heifers. *Veterinary Record*, **125**, 573–575
- Cole, P. and MacMahon, B. (1971) Attributable risk percent in case-control studies. *British Journal of Preventive and Social Medicine*, **25**, 242–244
- Colinvaux, P.A. (1973) *Introduction to Ecology*. John Wiley and Sons, New York
- Collett, D. (2003) *Modelling Binary Data*, 2nd edn. Chapman and Hall, Boca Raton and London.

- Collick, D.W., Ward, W.R. and Dobson, H. (1989) Associations between types of lameness and fertility. *Veterinary Record*, **125**, 103–106
- Collins, M. and Algers, B. (1986) Effects of stable dust on farm animals – a review. *Veterinary Research Communications*, **10**, 415–428
- Collins, M.T., Sockett, D.C., Goodger, W.J., Conrad, T.A., Thomas, C.B. and Curr, D.J. (1994) Herd prevalence and geographic distribution of, and risk factors for, bovine paratuberculosis in Wisconsin. *Journal of the American Veterinary Medical Association*, **204**, 636–641
- Comben, N. (1969) The early English printed literature on the diseases of poultry and other birds. *The Veterinarian*, **6**, 17–25
- Comer, P.J. and Huntley, P.J. (2003) TSE risk assessments: a decision support tool. *Statistical Methods in Medical Research*, **12**, 279–291
- Comer, P.J. and Huntley, P.J. (2004) Exposure of the human population to BSE infectivity over the course of the BSE epidemic in Great Britain and the impact of changes to the Over Thirty Month Rule. *Journal of Risk Research*, **7**, 523–543
- Comfort, A. (1955) The maximum ages reached by domestic cats. *Journal of Mammalogy*, **37**, 118–119
- Comfort, A. (1956) Longevity and mortality of Irish wolfhounds. *Proceedings of the Zoological Society of London*, **127**, 27–34
- Comfort, A. (1957) Survival curves of mammals in captivity. *Proceedings of the Zoological Society of London*, **128**, 349–364
- Comfort, A. (1958) The longevity and mortality of thoroughbred mares. *Journal of Gerontology*, **13**, 342–350
- Comfort, A. (1960) Longevity and mortality in dogs of four breeds. *Journal of Gerontology*, **15**, 126–129
- Condy, J.B., Hedger, R.S., Hamblin, C. and Barnett, I.T.R. (1985) The duration of the foot-and-mouth disease virus carrier state in African buffalo: (i) in the individual animal and (ii) in a free-living herd. *Comparative Immunology, Microbiology and Infectious Diseases*, **8**, 259–265
- Condy, J.B., Herniman, K.A.J. and Hedger, R.S. (1969) Foot-and-mouth disease in wildlife in Rhodesia and other African territories. *Journal of Comparative Pathology*, **79**, 27–31
- Conover, W.J. (1999) *Practical Nonparametric Statistics*, 3rd edn. John Wiley, New York
- Constable, P.D., St. Jean, G., Hull, B.L., Rings, D.M., Morin, D.E. and Nelson, D.R. (1997) Intussusception in cattle: 336 cases (1964–1993). *Journal of the American Veterinary Medical Association*, **210**, 531–536
- Cook, A.J.C., Pascoe, S.R., Wilesmith, J.W. and Gresham, A.C.J. (2001) A case-control study of post-weaning multi-systemic wasting syndrome (PMWS) and porcine dermatitis nephropathy syndrome (PDNS). *The Pig Journal*, **48**, 53–60
- Cook, A.K., Breitschwerdt, E.B., Levine, J.F., Bunch, S.E. and Linn, L.O. (1993a) Risk factors associated with acute pancreatitis in dogs: 101 cases (1985–1990). *Journal of the American Veterinary Medical Association*, **203**, 673–679
- Cook, R., Flesness, N., Munson, L. and Ullrey, D. (1993b) Working group report: monitoring, investigation, and surveillance of disease in captive wildlife. *Journal of Zoo and Wildlife Medicine*, **24**, 374–388
- Coombs, M.M. (1980) Chemical carcinogenesis: a view at the end of the first half-century. *Journal of Pathology*, **130**, 117–146
- Coop, A. and Ellis, M.J. (2003) The nature and development of cancer. In: *Oxford Textbook of Medicine*, Vol. 1. Eds Warrell, D.A., Cox, T.M., Firth, J.D. and Benz, E.J., pp. 219–228. Oxford University Press, Oxford
- Cooper, J.C. (1990) *The Aquarian Dictionary of Festivals*. The Aquarian Press, Wellingborough
- Copeland, K.T., Checkoway, H., McMichael, A.J. and Holbrook, R.H. (1977) Bias due to misclassification in the estimation of relative risk. *American Journal of Epidemiology*, **105**, 488–495
- Copeland, N.G., Jenkins, N.A., Gilbert, D.J., Eppig, J.T., Maltais, L.J., Miller, J.C., Dietrich, W.F., Weaver, A., Lincoln, S.E., Steen, R.G., Stein, L.D., Nadeau, J.H. and Lander, E.S. (1993) A genetic linkage map of the mouse: current applications and future prospects. *Science*, **262**, 57–66
- Cordes, D.O., Limer, K.L. and McKentee, K. (1981) Data management for the International Registry of Reproductive Pathology using SNOMED coding and computerization. *Veterinary Pathology*, **18**, 342–350
- Coria, M.F. and McClurkin, A.W. (1978) Specific immune tolerance in an apparently healthy bull persistently infected with bovine viral diarrhoea. *Journal of the American Veterinary Medical Association*, **172**, 449–451
- Cork, L.C., Hadlow, W.J., Crawford, T.B., Gorham, J.R. and Piper, R.C. (1974) Infectious leukoencephalomyelitis of young goats. *Journal of Infectious Diseases*, **129**, 134–141
- Cornfield, J. (1951) A method of estimating comparative rates from clinical data: applications to cancer of the lung, breast and cervix. *Journal of the National Cancer Institute*, **11**, 1269–1275
- Cornfield, J. (1956) A statistical problem arising from retrospective studies. In: *Proceedings of the Third Berkeley Symposium on Mathematical Statistics and Probability*. Ed. Newman, J., pp. 135–148. University of California Press, Berkeley
- Corso, B. (1997) Likelihood of introducing selected exotic diseases to domestic swine in the continental United States of America through uncooked swill. *Revue Scientifique et Technique, Office International des Epizooties*, **16**, 199–206
- Corrigan, P.J. and Seneviratna, P. (1989) Pesticide residues in Australian meat. *Veterinary Record*, **125**, 181–182.
- Cosgrove, A.S. (1962) An apparently new disease of chickens – avian nephrosis. *Avian Diseases*, **6**, 385–389
- Coste, J., Fermanian, J. and Venot, A. (1995) Methodological and statistical problems in the construction of composite measurement scales: a survey of six medical and epidemiological journals. *Statistics in Medicine*, **14**, 331–345
- Côté, R.A., Rothwell, D.J., Palotay, J.L., Beckett, R.S. and Brochu, L. (Eds) (1993) *SNOMED International. The Systematized Nomenclature of Human and Veterinary Medicine*. 4 vols. College of American Pathologists, Northfield/American Veterinary Medical Association, Schaumburg.
- Covello, V.T., Peters, R.G., Wojtecki, J.G. and Hyde, R.C. (2001) Risk communication, the West Nile virus epidemic, and bioterrorism: responding to the communication challenges posed by the intentional or unintentional release of a pathogen in an urban setting. *Journal of Urban Health*, **78**, 382–391

- Cowart, R.P., Boessen, C.R. and Kliebenstein, J.B. (1992) Patterns associated with season and facilities for atrophic rhinitis and pneumonia in swine. *Journal of the American Veterinary Medical Association*, **200**, 190–193
- Cowen, P., Pacer, R.A., Van Peteghem, P.N. and Fetrow, J.F. (1990) Management factors affecting trichinosis seropositivity among 91 North Carolina swine farms. *Preventive Veterinary Medicine*, **9**, 165–172
- Cowen, P., McGinn, T.J., Pyle, G.F., Routh, P.A. and Burstein, J.T. (1991) The influence of farm location, management characteristics and medical geographic factors on Aujeszky's disease status of swine farms in Sampson County, North Carolina. In: *Proceedings of the Sixth International Symposium on Veterinary Epidemiology and Economics*, Ottawa, 12–16 August 1991. Ed. Martin, S.W., pp. 409–411
- Cowling, D., Gardner, I.A. and Johnson, W.O. (1999) Comparison of methods for estimation of individual-level prevalence based on pooled samples. *Preventive Veterinary Medicine*, **39**, 211–25
- Cox, D.R. and Wermuth, N. (1996) *Multivariate Dependencies: Models, Analysis and Interpretation*. Chapman and Hall, London
- Cox, N. and Ryan, T. (1998) Introduction of anthrax via green hides: risk analysis revisited. *Surveillance*, **25** (3), 6–8
- Cox, N.A., Richardson, L.J., Bailey, J.S., Cosby, D.E., Cason, J.A., Musgrove, M.T. and Mead, G.C. (2005) Bacterial contamination of poultry as a risk to human health. In: *Food Safety Control in the Poultry Industry*. Ed. Mead, G., pp. 21–43. Woodhead Publishing, Abington
- Cramer, D.W., Welch, W.R., Scully, R.E. and Wojciechowski, C.A. (1982) Ovarian cancer and talc. A case-control study. *Cancer*, **50**, 372–376
- Crandell, R.A. and Maurer, F.D. (1958) Isolation of a feline virus associated with intranuclear inclusion bodies. *Proceedings of the Society of Experimental Biology and Medicine*, **97**, 487–490
- Cregier, S.E. (1990) Shocking docking: mutilation before education? *Journal of Equine Veterinary Science*, **10**, 252–255
- Creighton, C. (1965) *A History of Epidemics in Britain*, 2nd edn. Frank Cass and Co., London
- Croll, N.A., Anderson, R.M., Gyorkos, T.W. and Ghadirian, E. (1982) The population biology and control of *Ascaris lumbricoides* in a rural community in Iran. *Transactions of the Royal Society of Tropical Medicine and Hygiene*, **76**, 187–197
- Cross, D. (2003) Ethics and science: time for a critical review of water fluoridation. *Biologist*, **50**, 199
- Crossman, P.J. (1978) Gastric torsion in sows. *The Pig Veterinary Society Proceedings*, **2**, 47–49
- Csiza, C.K., Scott, F.W., Lahunta, A. de and Gillespie, J.H. (1971) Feline viruses. XIV: Transplacental infections in spontaneous panleukopenia of cats. *Cornell Veterinarian*, **61**, 423–439
- Cullen, J.M., Page, R. and Misdorp, W. (2002) An overview of cancer pathogenesis, diagnosis, and management. In: *Tumors in Domestic Animals*, 4th edn. Ed. Meuten, D.J., pp. 3–44. Iowa State Press, Ames
- Cullor, J.S. (1995) Implementing the HACCP program on your clients' dairies. *Veterinary Medicine*, **90**, 290–295
- Cummings, S.R. and Richard, R.J. (1988) Optimum cutoff points for biochemical validation of smoking status. *American Journal of Public Health*, **78**, 575–575
- Cunningham, E.P. and Meghen, C.M. (2001) Biological identification systems: genetic markers. *Revue Scientifique et Technique, Office International des Epizooties*, **20**, 491–499
- Cunningham, M.P., McIntyre, W.I.M. and Ives, J.C.J. (1957) The incidence of canine leptospirosis in Glasgow. *Veterinary Record*, **69**, 903–906
- Curtis, C.R. and Farrar, J.A. (Eds) (1990) The National Animal Health Monitoring System in the United States. *Preventive Veterinary Medicine*, **8**, 87–225
- Curtis, C.R., Erb, H.N., Sniffen, C.J. and Smith, R.D. (1984) Epidemiology of parturient paresis: predisposing factors with emphasis on dry cow feeding and management. *Journal of Dairy Science*, **67**, 817–825
- Curtis, C.R., White, M.E. and Erb, H.N. (1989) Effects of calthood morbidity of long-term survival in New York Holstein herds. *Preventive Veterinary Medicine*, **7**, 173–186
- Curtis, R. and Barnett, K.C. (1989) A survey of cataracts in golden and labrador retrievers. *Journal of Small Animal Practice*, **30**, 277–286
- Cuthbertson, J.C. (1983) Sheep disease surveillance based on condemnations at three Scottish abattoirs. *Veterinary Record*, **112**, 219–221
- CVMP (1993) Demonstration of efficacy of ectoparasiticides. CVMP Working Party on the Efficacy of Veterinary Medicines. Notes for Guidance. Document No. III/3682/92-EN. Commission of the European Communities, Brussels
- Czaplicki, G. and Thiry, E. (1998) An association exists between bovine herpesvirus-4 seropositivity and abortion in cows. *Preventive Veterinary Medicine*, **33**, 235–240
- Daft, B., Nordhausen, R.W., Latimer, K.S. and Niagro, F.D. (1996) Interstitial pneumonia and lymphadenopathy associated with circoviral infection in a six-week-old pig. *Proceedings of the American Association of Veterinary Laboratory Diagnosticians*, **39**, 32
- Daily Mail (2004) Chinese to cull 10 000 cats as SARS returns. *Daily Mail, Foreign Service*, 6 January 2004, p. 6
- Dalal, S.R., Fowlkes, E.B. and Hoadley, B. (1989) Risk analysis of the space shuttle: pre-Challenger prediction of failure. *Journal of the American Statistical Association*, **84**, 945–957
- D'Allaire, S., Morris, R.S., Martin, F.B., Robinson, R.A. and Leman, A.D. (1989) Management and environmental factors associated with annual sow culling rate: a path analysis. *Preventive Veterinary Medicine*, **7**, 255–265
- Dalton, J.P. and Mulcahy, G. (2001) Parasite vaccines – a reality? *Veterinary Parasitology*, **98**, 149–167
- Dampier, W.C.D. (1948) *A History of Science and its Relations with Philosophy and Religion*, 4th edn. Cambridge University Press, Cambridge
- Dangolla, A., Willeberg, P., Bjørn, H. and Roepstorff, A. (1996) Associations of *Ascaris suum* and *Oesophagostomum* spp. infections of sows with management factors in 83 Danish sow herds. *Preventive Veterinary Medicine*, **27**, 197–209
- Daniel, M. and Kolár, K. (1990) Using satellite data to forecast the occurrence of the common tick *Ixodes ricinus* (L.). *Journal of Hygiene, Epidemiology, Microbiology and Immunology*, **34**, 243–252
- Daniels, M.J., Hutchings, M.R., Allcroft, D.J., McKendrick, I.J. and Greig, A. (2002) Risk factors for Johne's disease in Scotland – the results of a survey of farmers. *Veterinary Record*, **150**, 135–139



- Dannat, L. (1997) *Neospora caninum* antibody levels in an endemically infected dairy herd. *Cattle Practice*, **5**, 335–337
- D'Aoust, J.-Y. (2001) *Salmonella*. In: *Guide to Foodborne Pathogens*. Eds Labbé, R.G. and Garcia, S., pp. 163–191. John Wiley, New York
- Darbyshire, J.H. (1968) Bovine adenoviruses. *Journal of the American Veterinary Medical Association*, **152**, 786–792
- Dargent-Molina, P., Scarlett, J., Pollock, R.V.H., Erb, H.N. and Sears, P. (1988) Herd-level risk factors for *Staphylococcus aureus* and *Streptococcus agalactiae* intramammary infections. *Preventive Veterinary Medicine*, **6**, 127–142
- Darke, P.G.G. (1982) The value of clinical case records in small animal cases. In: *Epidemiology in Animal Health*. Proceedings of a symposium held at the British Veterinary Association's Centenary Congress, Reading, 22–25 September 1982, pp. 103–106. Society for Veterinary Epidemiology and Preventive Medicine
- Darke, P.G.G., Thrusfield, M.V. and Aitken, C.G.G. (1985) Association between tail injuries and docking in dogs. *Veterinary Record*, **116**, 409
- Das, K.M. and Tashjian, R.J. (1965) Chronic mitral valve disease in the dog. *Veterinary Medicine/Small Animal Clinician*, **60**, 1209–1216
- Daubney, R., Hudson, J.R. and Garnham, P.C. (1931) Enzootic hepatitis or Rift Valley fever. An undescribed virus disease of sheep, cattle and man from East Africa. *Journal of Pathology and Bacteriology*, **34**, 545–579
- David, F.N. and Barton, D.E. (1966) Two space-time interaction tests for epidemicity. *British Journal of Preventive and Social Medicine*, **20**, 44–48
- Davidson, M.K., Lindsey, J.R. and Davis, J.K. (1987) Requirements and selection of an animal model. *Israel Journal of Medical Sciences*, **23**, 551–555
- David-West, K.B. (1980) Planning and implementation of contagious bovine pleuropneumonia control programs in Nigeria. In: *Veterinary Epidemiology and Economics*. Proceedings of the Second International Symposium, Canberra, 7–14 May 1979. Eds Geering, W.A., Roe, R.T. and Chapman, L.A., pp. 575–580. Australian Government Publishing Service, Canberra
- Davies, E.B. and Watkinson, J.H. (1966) Uptake of native and applied selenium by pasture species. I. Uptake of Se by browntop, ryegrass, cocksfoot, and white clover from Atiamuri sand. *New Zealand Journal of Agricultural Research*, **9**, 317–327
- Davies, F.G. (1975). Observations on the epidemiology of Rift Valley Fever in Kenya. *Journal of Hygiene, Cambridge*, **75**, 219–230
- Davies, F.G., Shaw, T. and Ochieng, P. (1975) Observations on the epidemiology of ephemeral fever in Kenya. *Journal of Hygiene, Cambridge*, **75**, 231–235
- Davies, G. (1980) Animal disease surveillance. In: *Veterinary Epidemiology and Economics*, Proceedings of the Second International Symposium. Eds Geering, W.A., Roe R.T. and Chapman, L.A., pp. 3–10. Australian Government Publishing Service, Canberra
- Davies, G. (1983) The development of veterinary epidemiology. In: Society for Veterinary Epidemiology and Preventive Medicine, Proceedings, Southampton, 12–13 April 1983. Ed. Thrusfield, M.V., pp. ix–xvi
- Davies, G. (1993) Do we need a European surveillance system? In: Society for Veterinary Epidemiology and Preventive Medicine, Proceedings, Exeter, 31 March–2 April 1993. Ed. Thrusfield, M.V., pp. 153–163
- Davies, G. (2002) Foot and mouth disease. *Research in Veterinary Science*, **73**, 195–199
- Davies, J.T. (1973) *The Scientific Approach*. Academic Press, London and New York
- Davies, M.H., Hadley, P.J., Stosic, P.J. and Webster, S.D. (2000) Production factors that influence the hygienic condition of finished beef cattle. *Veterinary Record*, **146**, 179–183
- Davies, O.L. and Goldsmith, P.L. (1972) *Statistical Methods in Research and Production*, 4th edn. Longman Group, New York and London
- Davison, A. and Hinckley, D. (1997) *Bootstrap Methods and their Applications*. Cambridge University Press, Cambridge
- Davison, H.C., Greiner, M. and Trees, A.J. (1999) Quantitative analysis of *Neospora caninum* serological data obtained from dairy cattle. In: Society for Veterinary Epidemiology and Preventive Medicine, Proceedings, Bristol, 24–26 March 1999. Eds. Goodall, E.A. and Thrusfield, M.V., pp. 172–181
- Dawson, A., Thevsagayam, S., Smith, S.C., Sherington, J. and Peters, A.R. (2002) The efficacy and duration of *Stellamune One*® a single dose *Mycoplasma hyopneumonia* vaccine for young pigs. In: Proceedings of the 17th Congress of the International Pig Veterinary Society Congress, 2–5 June 2002, Ames, Iowa. Vol. 2, p. 339
- Day, J.E.L. and Webster, S.D. (1998) Tail-biting and tail-docking in pigs (letter). *Veterinary Record*, **142**, 468
- De Boer, C.J. (1967) Studies to determine neutralizing antibody in sera from animals recovered from African swine fever and laboratory animals inoculated with African virus adjuvants. *Archiv für die Gesamte Virusforschung*, **20**, 164–179
- De Candolle, A.P.A. (1874) Constitution dans le regne végétal de groupes physiologiques applicables a la géographie ancienne et moderne. *Archives des Sciences Physiques et Naturelles*, **50**, 5–42
- De Hann, C. and Umali, D.L. (1992) Public and private sector roles in the supply of veterinary services. In: *Public and Private Roles in Agricultural Development*, Proceedings of the 12th Agricultural Sector Symposium. Eds Anderson, J.R. and de Hann, C., pp. 125–137. The World Bank, Washington
- De Jong, M.C.M., Diekmann, O., and Heesterbeek, J.A.P. (1995) How does transmission of infection depend on population size? In: *Epidemic Models: Their Structure and Relation to Data*. Ed. Mollison, D., pp. 84–94. Cambridge University Press, Cambridge
- De Kruif, A. (1980) Efficiency of a fertility control programme in dairy herds. In: Proceedings of the Ninth International Congress on Animal Reproduction and Artificial Insemination, Madrid, 16–20 June 1980. Vol. II, pp. 381–388
- De La Rúa, R., Watkins, G.H. and Watson, P.J. (2001) Idiopathic mouth ulcers in sheep. (Letter). *Veterinary Record*, **149**, 30–31
- De La Rúa-Domènech, R., Mohammed, H.O., Atwill, E.R., Cummings, J.F., Divers, T.J., Summers, B.A., De Lahunta,



- A. and Jackson, C. (1995) Epidemiological evidence for clustering of equine motor neuron disease in the United States. *American Journal of Veterinary Research*, **56**, 1433–1439
- De La Rúa-Domènech, R., Mohammed, H.O., Cummings, J.F., Divers, T.J., De Lahunta, A. and Summers, B.A. (1997) Association between plasma vitamin E concentration and the risk of equine motor neuron disease. *The Veterinary Journal*, **154**, 203–213
- De Leo, G., Dobson, A. and Goodman, A. (2002) Wildlife perspectives on the evolution of virulence. In: *Adaptive Dynamics of Infectious Diseases: In Pursuit of Virulence Management*. Eds Dieckmann, U., Metz, A.J., Sabelis, M.W. and Sigmund, K., pp. 26–38. Cambridge University Press, Cambridge
- De Lisle, G.W., Wilson, T., Collins, D.M. and Buddle, B.M. (2001) *Mycobacterium bovis* in free-living and captive wild-life, including farmed deer. *Revue Scientifique et Technique, Office International des Epizooties*, **20**, 86–111
- De Troyer, V. and D. Schepper, J. (1989) Pyometra in bitches: more frequently observed and a more serious illness in the Chow Chow? *Vlaams Diergeneeskundig Tijdschrift*, **58**, 73–76
- De Verdier, K. and Svensson, L. (1998) Group A rotavirus as a cause of neonatal calf enteritis in Sweden. *Acta Veterinaria Scandinavica*, **39**, 195–199
- Dee, S.A., Molitor, T.W. and Rossow, K.D. (2000) Epidemiological and diagnostic observations following the elimination of porcine reproductive and respiratory syndrome virus from a breeding herd of pigs by the test and removal protocol. *Veterinary Record*, **146**, 211–213
- Deen, J., Dee, S., Morrison, R.B. and Radostits, O.M. (2001) Health and production management in swine herds. In: *Herd Health: Food Animal Production Medicine*, 3rd edn. Ed. Radostits, O.M., pp. 635–764. W.B. Saunders, Philadelphia
- Deen, J., Martin, S.W. and Wilson, M.R. (1995) An evaluation of personal interviews as a method of estimating production indices on Ontario swine farms. *Preventive Veterinary Medicine*, **22**, 263–271
- DEFRA (2001) *Condition Scoring of Dairy Cows*. Department for Environment, Food and Rural Affairs, London
- DEFRA (2002a) *Foot and mouth disease in the United Kingdom 2001. Report to the OIE. Part I: Great Britain*. Department for Environment, Food and Rural Affairs, London
- DEFRA (2002b) *Origin of the UK Foot and Mouth Disease Epidemic in 2001*. Department for Environment, Food and Rural Affairs, London
- DEFRA (2002c) *Partnership, Priorities and Professionalism. A Proposed Strategy for Enhancing Veterinary Surveillance in the UK*. Department for Environment, Food and Rural Affairs, London
- DEFRA (2002d) *Technical Review – Bluetongue*. Version 1.5. Department for the Environment, Food and Rural Affairs, London.
- DEFRA (2003) *National Scrapie Plan for Great Britain*. Department for Environment, Food and Rural Affairs, London.
- DEFRA (2003a) *Qualitative Hazard Assessment – Foot and Mouth Disease Outbreak in South Africa (Recognised Buffer Zone)*. International Animal Health Division, Department for Environment, Food and Rural Affairs, London. [http://www.defra.gov.uk/animalh/diseases/monitoring/pdf/fmd\\_rsa.pdf](http://www.defra.gov.uk/animalh/diseases/monitoring/pdf/fmd_rsa.pdf) (Accessed 2nd July 2006)
- DEFRA (2004) *Preparing for a New GB Strategy on Bovine Tuberculosis*. Consultation document. Department for Environment, Food and Rural Affairs, London
- DEFRA (2005) *Qualitative Hazard Assessment – Highly Pathogenic Avian Influenza (H5N1) in Russia*. International Animal Health Division, Department for Environment, Food and Rural Affairs, London. <http://www.defra.gov.uk/animalh/diseases/monitoring/pdf/hpai-russia090805.pdf> (Accessed 2nd July 2006)
- DeGiorgis, M.P., Frey, J., Nicolet, J., Abdo, E.-M., Fatzer, R., Schlatter, Y., Reist, S., Janovsky, M. and Giacometti, M. (2000) An outbreak of infectious keratoconjunctivitis in Alpine chamois (*Rupicapra r. rupicapra*) in Simmental-Gruyères, Switzerland. *Schweizer Archiv Für Tierheilkunde*, **142**, 520–527
- Degner, R.L., Rodan, L.W., Mathis, W.K. and Gibbs, E.P.J. (1983) The recreational and commercial importance of feral swine in Florida: relevance to the possible introduction of African Swine Fever into the U.S.A. *Preventive Veterinary Medicine*, **1**, 371–381
- Delgado, C., Rosegrant, M., Steinfield, H., Ehui, S. and Courbois, C. (1999) *Livestock to 2020: The Next Food Revolution*. Food, Agriculture, and Environment Discussion Paper No. 28. International Food Policy Research Unit/Food and Agriculture Organization of the United Nations/International Livestock Research Institute. International Food Policy Research Unit, Washington
- Delgado-Lecaroz, R., Warnick, L.D., Guard, C.L., Smith, M.C. and Barry, D.A. (2000) Cross-sectional study of the association of abomasal displacement or volvulus with serum electrolyte and mineral concentrations in dairy cows. *Canadian Veterinary Journal*, **41**, 301–305
- Demets, D.L. and Ware, J.H. (1980) Group sequential methods in clinical trials with a one-sided hypothesis. *Biometrika*, **67**, 651–660
- Denny, G.O. and Hueston, W.D. (1997) Epidemiology of bovine spongiform encephalopathy in Northern Ireland 1988 to 1995. *Veterinary Record*, **140**, 302–306
- Denny, G.O. and Wilesmith, J.W. (1999). Bovine tuberculosis in Northern Ireland: a case-control study of herd risk factors. *Veterinary Record*, **144**, 305–310
- Denny, G.O., Wilesmith, J.W., Clements, R.A. and Hueston, W.D. (1992) Bovine spongiform encephalopathy in Northern Ireland: epidemiological observations 1988–1990. *Veterinary Record*, **130**, 113–116
- Dent, J.B. and Blackie, M.J. (1979) *Systems Simulation in Agriculture*. Applied Science Publishers, London
- Deresinski, S.C. (1980) History of coccidioidomycosis: ‘dust to dust’. In: *Coccidioidomycosis*. Ed. Stevens, D.A., pp. 1–20. Plenum, New York
- Dermer, O.C. and Ham, G.E. (1969) *Ethyleneimine and Other Aziridines*. Academic Press, New York
- DerSimonian, R. and Laird, N. (1986) Meta-analysis in clinical trials. *Controlled Clinical Trials*, **7**, 177–188
- Descour, L. (1922) *Pasteur and His Work*. Wedd, A.F. and Wedd, B.H. (Translators). T. Fisher Unwin, London
- Detsky, A.S., Baker, J.P., O'Rourke, K. and Goel, V. (1987) Perioperative parenteral nutrition: a meta-analysis. *Annals of Internal Medicine*, **107**, 195–203
- Dewar, L. (1968) *An Outline of Anglican Moral Theology*. Mowbray, London

- Dewey, C., Carman, S., Pasma, T., Josephson, G. and McEwen, B. (2003) Relationship between group A porcine rotavirus and management practices in swine herds in Ontario. *Canadian Veterinary Journal*, **44**, 649–653
- Dewey, C.E., Martin, S.W., Friendship, R.M. and Wilson, M.R. (1994) The effects on litter size of previous lactation length and previous weaning-to-conception interval in Ontario swine. *Preventive Veterinary Medicine*, **18**, 213–223
- Dickerman, R.W. and Scherer, W.F. (1983) Equine herds as sentinels for Venezuelan equine encephalitis virus activity, Nicaragua 1977. *Bulletin of the Pan American Health Organization*, **17**, 14–18
- Dickersin, K. and Berlin, J.A. (1992) Meta-analysis: state-of-the-science. *Epidemiologic Reviews*, **14**, 154–176
- Dickinson, A.G. and Barlow, R.M. (1967) The demonstration of the transmissibility of Border disease in sheep. *Veterinary Record*, **81**, 114
- Dieckmann, U., Metz, J.A.J., Sabelis, M.W. and Sigmund, K. (2002) *Adaptive Dynamics of Infectious Diseases: In Pursuit of Virulence Management*. Cambridge University Press, Cambridge
- Diekmann, O., Heesterbeek, J.A.P. and Metz, J.A.J. (1990) On the definition and the computation of the basic reproduction ratio  $R_0$  in models for infectious diseases in heterogeneous populations. *Journal of Mathematical Biology*, **28**, 365–382
- Diem, K. and Lentner, C. (Eds) (1970) *Documenta Geigy Scientific Tables*, 7th edn. Geigy Pharmaceuticals, Macclesfield
- Diesch, S.L. (1979) Disease recording at the farm level. In: *Proceedings of an International Symposium on Animal Health and Disease Data Banks*, 4–6 December 1978, Washington, DC, pp. 97–100. United States Department of Agriculture, Miscellaneous Publications No. 1381
- Diesch, S.L. and Ellinghausen, H.C. (1975) Leptospiroses. In: *Diseases Transmitted from Animals to Man*, 6th edn. Eds Hubbert, W.T., McCulloch, W.F. and Schnurrenberger, P.R., pp. 436–462. Charles C. Thomas, Springfield
- D'Ieteren, G.D.M., Authié, E., Wissocq, N. and Murray, M. (1998) Trypanotolerance; an option for sustainable livestock production in areas at risk from trypanosomosis. *Revue Scientifique et Technique, Office International des Epizooties*, **17**, 154–175
- Dietz, K. (1993) The estimation of the basic reproduction number for infectious diseases. *Statistical Methods in Medical Research*, **2**, 23–41
- Dijkhuizen, A.A., Morris, R.S. and Morrow, M. (1986) Economic optimization of culling strategies in swine breeding herds, using the PorkCHOP computer program. *Preventive Veterinary Medicine*, **4**, 341–352
- Dillon, J.L. and Anderson, J.R. (1990) *The Analysis of Response in Crop and Livestock Production*, 3rd edn. Pergamon Press, Oxford
- Dimock, W.W. and Edwards, P.R. (1932) Infections of foetuses and foals. *Kentucky Agriculture Experimental Station Bulletin*, **333**, 291–339
- Dinter, Z. and Morein, B. (Eds) (1990) *Virus Infections of Vertebrates Vol. 3. Virus Infections of Ruminants*. Elsevier, Amsterdam
- DiPietro, J.A. (1992) Internal parasite control programs. In: *Current Therapy in Equine Medicine*, 3, Ed. Robinson, N., pp. 51–55. W.B. Saunders, Philadelphia
- Di Salvo, A.F. and Johnson, W.M. (1979) Histoplasmosis in South Carolina: support for the microfocus concept. *American Journal of Epidemiology*, **109**, 408–492
- Divers, T.J., Mohammed, H.O., Cummings, J.F., Valentine, B.A., de Lahunta, A., Jackson, C.A. and Summers, B.A. (1994) Equine motor neuron disease – findings in 28 horses and proposal of a pathophysiological mechanism for the disease. *Equine Veterinary Journal*, **26**, 409–415
- Dixon, J.S. and Bird, H.A. (1981) Reproducibility along a 10 cm vertical visual analogue scale. *Annals of Rheumatic Diseases*, **40**, 87–89
- Dixon, R.M., Reid, S.W.J. and Mooney, C.T. (1999) Epidemiological, clinical, haematological and biochemical characteristics of canine hypothyroidism. *Veterinary Record*, **145**, 481–487
- Dobben, W.H. van (1952) The food of the cormorants in the Netherlands. *Ardea*, **40**, 1–63
- Dobson, A.P. (1988) Restoring island ecosystems: the potential of parasites to control introduced mammals. *Conservation Biology*, **2**, 31–39
- Dobson, A.P., Hudson, P.J. and Lyles, A.M. (1992) Macro-parasites: worms and others. In: *Natural Enemies: The Population Biology of Predators, Parasites and Diseases*. Ed. Crawley, M.J., pp. 329–348. Blackwell Scientific Publications, Oxford
- Dodd, F.H. and Neave, F.K. (1970) *Mastitis Control*. Biennial Review, Paper No. 3559. National Institute for Research in Dairying, Reading
- Dodds, W.J. (2001) Vaccine protocols for dogs predisposed to vaccine reactions. *Journal of the American Animal Hospital Association*, **37**, 1–4
- Dodman, N.H., Normile, J.A., Shuster, L. and Rand, W. (1994) Equine self-mutilation syndrome (57 cases). *Journal of the American Veterinary Medical Association*, **204**, 1219–1223
- Dodson, S.I., Allen, T.F.H., Carpenter, S.R., Ives, A.R., Jeanne, R.L., Kitchell, J.F., Langston, N.E. and Turner, M.G. (1998) *Ecology*. Oxford University Press, New York
- Doel, T.R. (2003) FMD vaccines. *Virus Research*, **91**, 81–99
- Doherr, M.G., Carpenter, T.E., Hanson, K.M.P., Wilson, W.D. and Gardner, I.A. (1998) Risk factors associated with *Corynebacterium pseudotuberculosis* infection in Californian horses. *Preventive Veterinary Medicine*, **35**, 229–239
- Doherr, M.G., Carpenter, T., Wilson, W.D., and Gardner, I.A. (1999) Evaluation of temporal and spatial clustering of horses with *Corynebacterium pseudotuberculosis* infection. *American Journal of Veterinary Research*, **60**, 284–291
- Doherr, M.G., Baumgarten, L. and Heim, D. (2000) The need for an active (targeted) surveillance system for BSE and scrapie in addition to mandatory reporting of clinical suspect cases. In: *Society for Veterinary Epidemiology and Preventive Medicine, Proceedings, Edinburgh*, 29–31 March 2000, Eds Thrusfield, M.V. and Goodall, E.A., pp. 198–203
- Dohms, J.E. and Metz, A. (1991) Stress-mechanisms of immunosuppression. *Veterinary Immunology and Immunopathology*, **30**, 89–109
- Dohoo, I.R. (1988) Animal Productivity and Health Information Network. *Canadian Veterinary Journal*, **29**, 281–287
- Dohoo, I.R. (1992) Dairy APHIN – an information service for the dairy industry in Prince Edward Island, Canada. *Preventive Veterinary Medicine*, **12**, 259–268

- Dohoo, I.R. (1993) Monitoring livestock health and production: service – epidemiology's last frontier? *Preventive Veterinary Medicine*, **18**, 43–52
- Dohoo, I.R. and Martin, S.W. (1984) Disease, production and culling in Holstein–Friesian cows. III. Disease and production as determinants of disease. *Preventive Veterinary Medicine*, **2**, 671–690
- Dohoo, I.R., Martin, S.W., McMillan, I. and Kennedy, B.W. (1984) Disease, production and culling in Holstein–Friesian cows. II. Age, season and sire effects. *Preventive Veterinary Medicine*, **2**, 655–670
- Dohoo, I.R., Morris, R.S., Martin, S.W., Perry, B.D., Bernardo, T., Thrusfield, M., Smith, R. and Welte, V.R. (1994) Epidemiology (letter). *Nature*, **368**, 284
- Dohoo, I.R., Ducrot, C., Fourichon, C., Donald, A. and Hurnik, D. (1996) An overview of techniques for dealing with large numbers of independent variables in epidemiologic studies. *Preventive Veterinary Medicine*, **29**, 201–239
- Dohoo, I.R., DesCôteaux, L., Leslie, K., Fredeen, A., Shewfelt, W., Preston, A. and Dowling, P. (2003) A meta-analysis review of the effects of recombinant bovine somatotropin 2. Effects on animal health, reproductive performance, and culling. *Canadian Journal of Veterinary Research*, **67**, 252–264
- Doll, R. (1959) Smoking and cancer. Report to the subcommittee for the study of the risks of cancer from air pollution and the consumption of tobacco. *Acta Uniaris Internationalis Contra Cancrum*, **15**, 1283–1296
- Doll, R. (1977) Strategy for detection of cancer hazards to man. *Nature*, **265**, 589–596
- Doll, R. (1992) Sir Austin Bradford Hill and the progress of medical science. *British Medical Journal*, **305**, 1521–1528
- Doll, R. and Hill, A.B. (1964a) Mortality in relation to smoking. Ten years' observations of British doctors. *British Medical Journal*, **i**, 1399–1410
- Doll, R. and Hill, A.B. (1964b) Mortality in relation to smoking. Ten years' observations of British doctors. *British Medical Journal*, **i**, 1460–1467
- Doll, R., Peto, R., Boreham, J. and Sutherland, I. (2004) Mortality in relation to smoking: 50 years' observations on male British doctors. *British Medical Journal*, **328**, 1519–28
- Domingo, E., Escarmís, C., Menéndez-Arias, L. and Holland, J.J. (1999) Viral quasispecies and fitness variations. In: *Origin and Evolution of Viruses*. Eds Domingo, E., Webster, R. and Holland, J., pp. 141–161. Academic Press, San Diego
- Donald, W.A., Gardner, I.A. and Wiggins, A.D. (1994) Cut-off points for aggregate herd testing in the presence of disease clustering and correlation of test errors. *Preventive Veterinary Medicine*, **19**, 167–187
- Donaldson, A.I. (1986) Aerobiology of FMD: an outline and recent advances. In: *Animal Virus Research Institute–Pirbright, Pirbright 60th anniversary celebration special issue*. *Revue Scientifique et Technique, Office International des Epizooties*, **5**, 315–321
- Donaldson, A.I. (1987) Foot and mouth disease: the principal features. *Irish Veterinary Journal*, **41**, 325–327
- Donaldson, A.I. (1993) Epidemiology of foot-and-mouth disease: the current situation and new perspectives. In: *Diagnosis and Epidemiology of Foot-and-Mouth Disease in Southeast Asia*. Proceedings of an international workshop held at Lampang, Thailand, 6–9 September 1993. Eds Copland, J.W., Gleeson, L.J. and Chamnanpood, C., pp. 9–15
- Donaldson, A.I. (1997) Risks of spreading foot and mouth disease through milk and dairy products. *Revue Scientifique et Technique, Office International des Epizooties*, **16**, 117–124
- Donaldson, A.I. (2000) The role of sheep in the epidemiology of foot-and-mouth disease and proposals for control and eradication in animal populations with a high density of sheep. In: *Report of the Session of the Research Group of the Standing Technical Committee of the European Commission for the Control of Foot-and-Mouth Disease, Borovets, Bulgaria, 5–8 September 2000*. AGA: EUFMD/RG/00, pp. 107–116. Food and Agriculture Organization of the United Nations, Rome
- Donaldson, A.I. and Alexandersen, S. (2001) Relative resistance of pigs to infection by natural aerosols of FMD virus. *Veterinary Record*, **148**, 600–602
- Donaldson, A.I. and Alexandersen, S. (2002) Predicting the spread of foot and mouth disease by airborne virus. *Revue Scientifique et Technique, Office International des Epizooties*, **21**, 569–575
- Donaldson, A.I. and Doel, T.R. (1992) Foot-and-mouth disease: the risk for Great Britain after 1992. *Veterinary Record*, **131**, 114–120
- Donaldson, A.I. and Kitching, R.P. (1989) Transmission of foot-and-mouth disease by vaccinated cattle following natural challenge. *Research in Veterinary Science*, **46**, 9–14
- Donaldson, A.I., Gloster, J., Harvey, L.D.J. and Deans, D.H. (1982) Use of prediction models to forecast and analyse airborne spread during the foot-and-mouth disease outbreaks in Brittany, Jersey and the Isle of Wight in 1981. *Veterinary Record*, **110**, 53–57
- Donaldson, A.I., Alexandersen, S., Sørensen, J.H. and Mikkelsen, T. (2001) Relative risks of the uncontrollable (airborne) spread of FMD by different species. *Veterinary Record*, **148**, 602–604
- Done, J.T. (1985) Eradication, elimination or control? *Veterinary Record*, **117**, 253
- Donham, K.J., Berg, J.W. and Sawin, R.S. (1980) Epidemiologic relationships of the bovine population and human leukemia in Iowa. *American Journal of Epidemiology*, **112**, 80–92
- Donnelly, C.A., Woodroffe, R., Cox, D.R., Bourne, J., Gettinby, G., Le Fevre, A.M., McInerney, J.P. and Morrison, W.I. (2003) Impact of localized badger culling on tuberculosis incidence in British cattle. *Nature*, **426**, 834–837
- Donner, A. (1993) The comparison of proportions in the presence of litter effects. *Preventive Veterinary Medicine*, **18**, 17–26
- Donner, A. and Klar, N. (2000) *Design and Analysis of Cluster Randomization Trials in Health Research*. Arnold, London
- Donoghue, A.M. (2001) The design of hazard risk assessment matrices for ranking occupational health risks and their application in mining and minerals processing. *Occupational Medicine*, **51**, 118–123
- Donoghue, D.J. (2005) Modelling risks from antibiotics and other residues in poultry and eggs. In: *Food Safety Control in the Poultry Industry*. Ed. Mead, G., pp. 83–100. Woodhead Publishing, Abington

- Dorn, C.R. (1966) An animal tumour registry as a source of morbidity information. In: Proceedings of the United States Livestock Sanitation Association, pp. 443–454
- Dorn, C.R. and Priester, W.A. (1976) Epidemiologic analysis of oral and pharyngeal cancer in dogs, cats, horses and cattle. *Journal of the American Veterinary Association*, **169**, 1202–1206
- Dorn, C.R. and Priester, W.A. (1987) Epidemiology. In: *Veterinary Cancer Medicine*, 2nd edn. Eds Theilen, G.H. and Madewell, B.R., pp. 27–52. Lea and Febiger, Philadelphia
- Dorn, C.R. and Schneider, R. (1976) Inbreeding and canine mammary cancer: a retrospective study. *Journal of the National Cancer Institute*, **57**, 545–548
- Dorn, C.R., Garner, H.E., Coffman, J.R., Hahn, A.W. and Tritschler, L.G. (1975) Castration and other factors affecting the risk of equine laminitis. *Cornell Veterinarian*, **65**, 57–64
- Dorn, C.R., Taylor, D.O.N. and Hibbard, H.H. (1967a) Epizootiologic characteristics of canine and feline leukemia and lymphoma. *American Journal of Veterinary Research*, **28**, 993–1001
- Dorn, C.R., Terbrusch, F.G. and Hibbard, H.H. (1967b) *Zoographic and Demographic Analysis of Dog and Cat Ownership in Alameda County, California, 1965*. State of California Department of Public Health, Berkeley
- Dorn, C.R., Taylor, D.O.N., Schneider, R., Hibbard, H.H. and Klauber, M.R. (1968) Survey of animal neoplasms in Alameda and Contra Costa Counties, California. II. Cancer morbidity in dogs and cats from Alameda County. *Journal of the National Cancer Institute*, **40**, 307–318
- Dorn, C.R., Taylor, D.O.N. and Schneider, R. (1971) Sunlight exposure and risk of developing cutaneous and oral squamous cell carcinomas in white cats. *Journal of the National Cancer Institute*, **46**, 1073–1081
- Dougherty, C. (2002) *Introduction to Econometrics*, 2nd edn. Oxford University Press, Oxford
- Douglas, A. (1984) Disease prevention in pig herds. *In Practice*, **6**, 108–115
- Doyle, K.A. (1995) Models used in Australia in risk assessments for veterinary biologicals. *Revue Scientifique et Technique, Office International des Epizooties*, **14**, 1021–1042
- Doyle, L.P. and Hutchings, L.M. (1946) A transmissible gastroenteritis of pigs. *Journal of the American Veterinary Medical Association*, **108**, 257–259
- Doyle, T.M. (1927) A hitherto unrecorded disease of fowls due to a filter-passing virus. *Journal of Comparative Pathology and Therapeutics*, **40**, 144–169
- Dragon, D.C. and Rennie, R.P. (1995) The ecology of anthrax spores: tough but not invincible. *Canadian Veterinary Journal*, **36**, 295–301
- Drobia, H., Luescher, U.A. and Meek, A.H. (1990) Tail-tip necrosis in Ontario feedlot cattle: two case-control studies. *Preventive Veterinary Medicine*, **9**, 195–205
- Drummond, J.G., Curties, S.E., Meyer, R.C., Simon, J. and Norton, H.W. (1981) Effects of atmospheric ammonia on young pigs experimentally infected with *Bordetella bronchiseptica*. *American Journal of Veterinary Research*, **42**, 963–968
- Dubos, R. (1965) *Man Adapting*. Yale University Press, New Haven
- Ducrot, C. and Cimarosti, I. (1991) Complementary aspects of the logistic model and of the correspondence analysis to investigate risk factors in animal pathology: application to the study of orf risk factors in sheep breeders. In: Proceedings of the Sixth International Symposium on Veterinary Epidemiology and Economics, Ottawa, 12–16 August 1991. Ed. Martin, S.W., pp. 97–100
- Ducrot, C., Cimarosti, I., Bugnard, F. and Luquet F. (1994) Calving effects on French beef-cow fertility. *Preventive Veterinary Medicine*, **19**, 129–136
- Dufour, B. and Audigé, L. (1997) A proposed classification of veterinary epidemiosurveillance networks. *Revue Scientifique et Technique, Office International des Epizooties*, **16**, 745–758
- Dufour, B. and La Vieille, S. (2000) Epidemiological surveillance of infectious diseases in France. *Veterinary Research*, **31**, 169–185
- Dunbar, I. (1979) *Dog Behaviour: Why Dogs Do What They Do*. T.F.H. Publications Inc., Neptune, New Jersey
- Dunne, H.W., Gobble, J.L., Hokanson, J.F., Kradel, D.C., and Bubash, G.R. (1965) Porcine reproductive failure associated with a newly identified 'SMEDI' groups of picorna viruses. *American Journal of Veterinary Research*, **26**, 1284–1297
- Duppong, B.L. and Ettinger, S.J. (1983) The medical record. In: *Textbook of Veterinary Internal Medicine: Diseases of the Dog and Cat*, Vol. 2, 2nd edn. Ed. Ettinger, S.J., pp. 3–29. W.B. Saunders Company, Philadelphia
- Durr, P.A. and Froggatt, A.E.A. (2002) How best to georeference farms? A case study from Cornwall, England. *Preventive Veterinary Medicine*, **56**, 51–62
- Durr, P.A., Argyraki, A., Ramsey, M.H. and Clifton-Hadley, R.S. (2000) Agro-ecological databases for spatial correlation studies: methodological issues. In: Society for Veterinary Epidemiology and Preventive Medicine, Proceedings, Edinburgh, 29–31 March 2000. Eds Thrusfield, M.V. and Goodall, E.A., pp. 225–235
- Duval, J.M., Budsberg, S.C., Flo, G.L. and Sammarco, J.L. (1999) Breed, sex and body weight as risk factors for rupture of the cranial cruciate ligament in young dogs. *Journal of the American Veterinary Medical Association*, **215**, 811–814
- Dwinger, R., Luckins, A.G., Murray, M., Rae, P. and Moloo, S.H.K. (1986) Interference between different serodemes of *Trypanosoma congolense* in the establishment of superinfections in goats following transmission by tsetse. *Parasite Immunology*, **8**, 293–305
- Dwyer, R.M., Garber, L., Traub-Dargatz, J., Meade, B., Pavlick, M. and Walker, J. (2002) An epidemiological investigation of mare reproductive loss syndrome: breaking ground on a new disease. In: Society for Veterinary Epidemiology and Preventive Medicine, Vicerary Proceedings, Cambridge, 3–5 April 2002. Eds Menzies, F.D. and Reid, S.W.J., pp. 44–47
- Dwyer, R.M., Garber, L.P., Traub-Dargatz, J.L., Meade, B.J., Powell, D., Pavlick, M.P. and Kane, A.J. (2003) Case-control study of factors associated with excessive proportions of early fetal losses associated with mare reproductive loss syndrome in central Kentucky during 2001. *Journal of the American Veterinary Medical Association*, **222**, 613–619
- Dybkjær, L., Vraa-Andersen, L., Paisley, L.G., Møller, K., Christensen, G. and Agger, J.F. (1994) Association between behaviour and stomach lesions in slaughter pigs. *Preventive Veterinary Medicine*, **19**, 101–112

- Dye, C. (1999) *PETS: Risk of Rabies from North America*. Department for Environment, Food and Rural Affairs, London. <http://www.defra.gov.uk/animalh/quarantine/pets/safety/annex.htm> (Accessed 18 April 2006)
- Dyer, J. (1990) *Ancient Britain*. Batsford, London
- Dykhuizen, A.A. (1993) Modelling animal health economics. In: Society for Veterinary Epidemiology and Preventive Medicine, Proceedings, Exeter, 31 March–2 April 1993. Ed. Thrusfield, M.V., pp. ix–xx
- Dzienciowski, R. (1976) Estimating ungulate numbers in a forest by track counts. *Acta Theriologica*, **21**, 217–222
- EAEMP (2000) *Points to Consider on Switching Between Superiority and Non-Inferiority*. CPMP/EWP/482/99. The European Agency for the Evaluation of Medicinal Products, 7 Westferry Circus, Canary Wharf, London E14 4HB
- EAEMP (2001) *Note for Guidance on Statistical Principles for Veterinary Clinical Trials*. EMEA/CVMP/816/00-CONSULTATION The European Agency for the Evaluation of Medicinal Products, 7 Westferry Circus, Canary Wharf, London E14 4HB
- Eaglesome, M.D. and Garcia, M.M. (1997) Disease risks to animal health from artificial insemination with bovine semen. *Revue Scientifique et Technique, Office International des Epizooties*, **16**, 215–225
- Easterbrook, P.J., Berlin, J.A., Gopalan, R. and Matthews, D.R. (1991) Publication bias in clinical research. *Lancet*, **337**, 867–872
- Ebel, E.D., Hornbaker, R.H. and Nelson, C.H. (1992) Welfare effects of the national pseudorabies eradication program. *American Journal of Agricultural Economics*, **74**, 638–645
- Ebert, D. and Mangin, K.L. (1995) The evolution of virulence – when familiarity breeds death. *Biologist*, **42**, 154–156
- ECDC (2006) *The Public Health Risks from Highly Pathogenic Avian Influenza Viruses Emerging in Europe with Specific Reference to Type A/H5N1*. Interim ECDC Risk Assessment – October 19th 2005 (updated January 5th 2006). European Centre for Disease Prevention and Control, Stockholm
- Eddy, R.G. (1992) Private health schemes. In: *Livestock Health and Welfare*. Ed Moss, R., pp. 183–291. Longman Scientific and Technical, Harlow
- Edelsten, R.M. (1995) *Livestock Diseases in the Northern Regions of Somalia. A Report of the British Veterinary Team, 1969–1972*. 1994 Condensed Version. VetAid, Midlothian
- Edinboro, C.H., Scott-Moncrieff, J.C., Janovitz, E., Thacker, H.L. and Glickman, L.T. (2004) Epidemiologic study of relationships between consumption of commercial canned food and risk of hyperthyroidism in cats. *Journal of the American Veterinary Medical Association*, **224**, 879–886
- Edney, A.T.B. and Smith, P.M. (1986) Study of obesity in dogs visiting veterinary practices in the United Kingdom. *Veterinary Record*, **118**, 391–396
- Edney, A.T.B., Gaskell, C.J. and Sharp, N.J.H. (Eds) (1987) Feline dysautonomia – an emerging disease. *Journal of Small Animal Practice*, **28**, 333–416
- Edwards, D. (2002) On-farm hazard analysis critical control points (HACCP) for improving the safety of lamb and beef. In: *Food Safety Assurance and Veterinary Public Health. Volume 1. Food Safety Assurance in the Pre-harvest Phase*. Eds Smulders, F.J.M. and Collins, J.D., pp. 299–301. Wageningen Academic, Wageningen
- Edwards, D.S., Henley, W.E., Ely, E.R. and Wood, J.L.N. (2004) Ill health in dogs: does a temporal association with vaccination exist? In: Society for Veterinary Epidemiological and Preventive Medicine, Proceedings, Martigny, 24–26 March 2004. Eds Reid, S.J.W., Menzies, F.D. and Russell, A.M., pp. 41–49
- Edwards, J.R. (1985) Losses from ovine dermatophilosis. In: Proceedings of the Fourth International Symposium on Veterinary Epidemiology and Economics. Singapore, 18–22 November 1985, pp. 314–316. Singapore Veterinary Association, Singapore
- Edwards, J.R. (1990) Surveys and questionnaires: design, conduct and analysis. In: *Epidemiological Skills in Animal Health*. Refresher Course for Veterinarians. Proceedings 143. Sydney, 1–5 October 1990, pp. 151–158. Post Graduate Committee in Veterinary Science, University of Sydney
- Edwards, J.T. (1928) Rinderpest: active immunization by means of the serum simultaneous method; goat virus. *Agricultural Journal of India*, **23**, 185–189
- Edwards, P. (Ed.) (1967) *The Encyclopedia of Philosophy*. Vol. 8. The Macmillan Company and the Free Press, New York
- Edwards, S.A. and Lightfoot, A.L. (1986) The effect of floor type in farrowing pens on pig injury. II. Leg and teat damage of sows. *British Veterinary Journal*, **142**, 441–445
- Efron, B. and Tibshirani, R.J. (1993) *An Introduction to the Bootstrap*. Chapman and Hall, New York
- EFSA (2005) *Scientific Report: Animal Health and Welfare Aspects of Avian Influenza*. Annex to (EFSA (2005) Animal health and welfare aspects of avian influenza, *EFSA Journal*, **266**, 1–1. [http://www.efsa.eu.int/science/ahaw/ahaw\\_opinions/1145\\_en.html](http://www.efsa.eu.int/science/ahaw/ahaw_opinions/1145_en.html) (Accessed 1st March 2006)
- Egeberg, R.O. (1954) Coccidioidomycosis: its clinical and climatological aspects with remarks on treatment. *American Journal of Medical Science*, **227**, 268–271
- Egenvall, A., Hedhammar, Å., Bonnett, B.N. and Olson, P. (1999) Survey of the Swedish dog population: gender, breed, location and enrolment in animal insurance. *Acta Veterinaria Scandinavica*, **40**, 231–240
- Egenvall, A., Bonnett, B.N., Shoukri, M., Olson, P., Hedhammar, Å. and Dohoo, I. (2000) Age pattern and mortality in eight breeds of insured dogs in Sweden. *Preventive Veterinary Medicine*, **46**, 1–14
- Egenvall, A., Franzén, P., Gunnarsson, A., Engvall, E.O., Vågsholm, I., Wikström, U.-B. and Artursson, K. (2001) Cross-sectional study of the seroprevalence to *Borrelia burgdorferi* sensu lato and granulocytic *Ehrlichia* spp. and demographic, clinical and tick-exposure factors in Swedish horses. *Preventive Veterinary Medicine*, **49**, 191–208
- Egwu, G.O., Faull, W.B., Bradbury, J.M. and Clarkson, M.J. (1989) Ovine infectious keratoconjunctivitis: a microbiological study of clinically unaffected and affected sheep's eyes with special reference to *Mycoplasma conjunctivae*. *Veterinary Record*, **125**, 253–256
- Ejigou, A. and McHugh, R. (1977) On the factorization of the crude relative risk. *American Journal of Epidemiology*, **106**, 188–191
- Ekesbo, I. (1966) Disease incidence in tied and loose housed dairy cattle and causes of incidence variation with

- particular reference to cowshed type. *Acta Agriculturae Scandinavica*, Suppl. 15, 1-74
- Ekesbo, I. (1992) Monitoring systems using clinical, sub-clinical and behavioural records for improving health and welfare. In: *Livestock Health and Welfare*. Ed. Moss, R., pp. 20-50. Longman Scientific and Technical, Harlow
- Ekesbo, I., Oltenacu, P.A., Vilson, B. and Nilsson, J. (1994) A disease monitoring system for dairy herds. *Veterinary Record*, **134**, 270-273
- Eksell, P., Axelsson, M., Brostrom, H., Roneus, B., Hagstrom, J. and Carlsten, J. (1998) Prevalence and risk factors of bone spavin in Icelandic horses in Sweden: a radiographic field study. *Acta Veterinaria Scandinavica*, **39**, 339-348
- Ekstrand, C. and Linde-Forsberg, C. (1994) Dystocia in the cat: a retrospective study of 155 cases. *Journal of Small Animal Practice*, **39**, 459-464
- Elandt-Johnson, R.C. (1977) Various estimators of conditional probabilities of death in follow-up studies. *Journal of Chronic Diseases*, **30**, 247-256
- Elbers, A.R.W. and Schukken, Y.H. (1995) Critical features of veterinary field trials. *Veterinary Record*, **136**, 187-192
- Elbers, A.R.W., Tielen, M.J.M., Cromwijk, W.A.J. and Hunneman, W.A. (1992) Variation in seropositivity for some respiratory disease agents in finishing pigs: epidemiological studies on some health parameters and farm management conditions in the herds. *The Veterinary Quarterly*, **14**, 8-13
- Elbers, A.R.W., Stegeman, J.A. and De Jong, M.C.M. (2001a) Factors associated with the introduction of classical swine fever virus into pig herds in the central area of the 1997/98 epidemic in the Netherlands. *Veterinary Record*, **149**, 377-382
- Elbers, A.R.W., Moser, H., Ekker, H.M., Crauwels, P.A.A., Stegeman, J.A., Smak, J.A. and Pluimers, F.H. (2001b) Tracing systems used during the epidemic of classical swine fever in the Netherlands, 1997-1998. *Revue Scientifique et Technique, Office International des Epizooties*, **20**, 614-629
- Elder, J.K. (1976) A functional computer recording system for a veterinary diagnostic laboratory. *Australian Veterinary Journal*, **52**, 24-35
- Ellenberg, S.S., Fleming, T.R. and DeMets, D.L. (2002) *Data Monitoring Committee in Clinical Trials*. John Wiley, New York
- Ellis, P.R. (1980) International aspects of animal disease surveillance. In: *Veterinary Epidemiology and Economics*, Proceedings of the Second International Symposium. Eds Geering, W.A., Roe, R.T. and Chapman, L.A., pp. 11-15. Australian Government Publishing Service, Canberra
- Ellis, P.R., James, A.D. and Shaw, A.P. (1977) Studies on the Epidemiology and Economics of Swine Fever Eradication in the EEC. EUR 5738e. Commission of the European Communities, Luxembourg
- Elton, C.S. (1927) *Animal Ecology*. Macmillan, New York
- Elwood, J.M. (1998) *Critical Appraisal of Epidemiological Studies and Clinical Trials*, 2nd edn. Oxford University Press, Oxford
- Emanuelson, U. and Bendixen, P.H. (1991) Occurrence of cystic ovaries in dairy cows in Sweden. *Preventive Veterinary Medicine*, **10**, 261-271
- Emanuelson, U., Scherling, K. and Pettersson, H. (1992) Relationship between herd bovine leukemia infection status and reproduction, disease incidence, and productivity in Swedish dairy herds. *Preventive Veterinary Medicine*, **12**, 121-131
- Emery, R.S., Hafs, H.D., Armstrong, D. and Snyder, W.W. (1969) Prepartum grain feeding effects on milk production, mammary edema, and incidence of diseases. *Journal of Dairy Science*, **52**, 345-351
- Emori, T.G. and Gaynes, R.P. (1993) An overview of nosocomial infections, including the role of the microbiology laboratory. *Clinical Microbiology Reviews*, **6**, 428-442
- Enevoldsen, C., Grohn, Y.T. and Thysen, I. (1990) Physical injuries in dairy cows: associations with season, cow characteristics, disease, and production. In: *Society for Veterinary Epidemiology and Preventive Medicine, Proceedings*, Belfast, 4-6 April 1990. Ed. Thrusfield, M.V., pp. 133-144
- England, J.J. (2002) Biosecurity: safeguarding your veterinarian: client relationship. *Veterinary Clinics of North America, Food Animal Practice*, **18** (3), 373-378
- Enøe, C., Georgiadis, M.P. and Johnson, W.O. (2000) Estimation of sensitivity and specificity of diagnostic tests and disease prevalence when the true disease state is unknown. *Preventive Veterinary Medicine*, **45**, 61-81
- Enøe, C., Mousing, J., Schirmer, A.L. and Willeberg, P. (2002) Infectious and rearing-system related risk factors for chronic pleuritis in slaughter pigs. *Preventive Veterinary Medicine*, **54**, 337-349
- Enøe, C., Christensen, G., Andersen, S. and Willeberg, P. (2003) The need for built-in validation of surveillance data so that changes in diagnostic performance of post-mortem meat inspection can be detected. *Preventive Veterinary Medicine*, **57**, 117-125
- EPA (1998) *United States Environmental Protection Agency (EPA) Guidance for Quality Assurance Project Plans*. EPA QA/G-5. EPA Office of Research and Development, Washington, DC
- Epstein, P.R. (2001) Climate change and emerging infectious diseases. *Microbes and Infection*, **3**, 747-754
- Erb, H. (1984) Economics in veterinary farm practice. In *Practice*, **6**, 33-37
- Erickson, B.H. and Nosanchuk, T.A. (1979) *Understanding Data*. Open University Press, Milton Keynes
- Ernst, S.N. and Fabrega, F. (1989) A time series analysis of the rabies control programme in Chile. *Epidemiology and Infection*, **103**, 651-657
- Erskine, R.J. (2001) Mastitis control in dairy herds. In: *Herd Health: Food Animal Production Medicine*, 3rd edn. Ed. Radostits, O.M., pp. 397-433. W.B. Saunders, Philadelphia
- Erskine, R.J., Eberhart, R.J., Hutchinson, L.J. and Spencer, S.B. (1987) Herd management and prevalence of mastitis in dairy herds with high and low somatic cell counts. *Journal of the American Veterinary Medical Association*, **190**, 1411-1416
- Esslemont, R.J. (1993a) Measuring fertility in dairy herds. In: *Society for Veterinary Epidemiology and Preventive Medicine, Proceedings*, Exeter, 31 March-2 April 1993. Ed. Thrusfield, M.V., pp. 96-109
- Esslemont, R.J. (1993b) *The Development of Decision Support Systems in Agriculture: DAISY - The Dairy Information*

- System. Farm Management Unit Publication No. 30. Department of Agriculture, University of Reading
- Esslemont, R.J. and Kossaibati, M.A. (2002) *The Costs of Poor Fertility and Disease in UK Dairy Herds*. DAISY Research Report No. 5. Intervet UK Limited, Walton Manor
- Esslemont, R.J., Wassell, B.R., Wassell, T.R., Grimbleby, L., Lamb, J.M. and Horne, S. (1991) The application of planned animal health and production to dairy farms: DAISY – The Dairy Information System. *The Bovine Practitioner*, **26**, 38–41
- Estberg, L., Gardner, I.A., Stover, S.M. and Johnson, B.J. (1998) A case-crossover study of intensive racing and training schedules and risk of catastrophic musculoskeletal injury and lay-up in California Thoroughbred racehorses. *Preventive Veterinary Medicine*, **33**, 159–170
- Estberg, L., Gardner, I.A., Stover, S.M., Johnson, B.J., Case, J.T. and Ardans, A. (1995) Cumulative racing-speed exercise distance cluster as a risk factor for fatal musculoskeletal injury in Thoroughbred racehorses in California. *Preventive Veterinary Medicine*, **24**, 253–263
- Estola, T. and Neuvonen, E. (1976) Experience of efficacy of equine influenza vaccinations. *Nordisk Veterinærmedicin*, **28**, 353–356
- Etherington, W.G., Kinsel, M.L. and Marsh, W.E. (1995) Options in dairy data management. *Canadian Veterinary Journal*, **36**, 28–33
- Eugster, A.K., Bendele, R.A. and Hones, C.P. (1978) Parvovirus infection in dogs. *Journal of the American Veterinary Medical Association*, **173**, 1340–1341
- EUROPA (2000) Commission Decision of 22 December 1999 amending Commission Decision 93/623/EEC and establishing the identification of equidae for breeding and production (notified under document number C(1999) 5004) (text with EEA relevance) (2000/68/EC). *Official Journal of the European Communities*, L 23, Vol. 43, 28 January 2000, pp. 72–75. Commission of the European Communities, Brussels
- EUROPA (2004) ANIMO. <http://europa.eu.int/comm/food/animal/diseases/animo> (Accessed 7th November 2004)
- European Commission (2002) Proposal for a Council Directive on Community measures for the control of foot-and-mouth disease and amending Directive 92/46/EEC. COM(2002) 736 final. 2002/0299 (CNS). Commission of the European Communities, Brussels
- Evans, A.S. (1976) Causation and disease. The Henle–Koch postulates revisited. *Yale Journal of Biology and Medicine*, **49**, 175–195
- Evans, A.S. (1987) Subclinical epidemiology. *American Journal of Epidemiology*, **125**, 545–555
- Evans, A.S. (1993) *Causation and Disease: A Chronological Journey*. Plenum Publishing Corporation, New York
- Evans, M., Hastings, N. and Peacock, B. (2000) *Statistical Distributions*, 3rd edn. John Wiley, New York
- Evans, S.J. and Sayers, A.R. (2000) A longitudinal study of campylobacter infection of broiler flocks in Great Britain. *Preventive Veterinary Medicine*, **46**, 209–223
- Evans-Pritchard, E.E. (1956) *Nuer Religion*. Oxford University Press, London
- Everitt, B.S. (1989) *Statistical Methods for Medical Investigations*. Oxford University Press, New York/Edward Arnold, London
- Everitt, B.S. (1995) *The Cambridge Dictionary of Statistics in the Medical Sciences*. Cambridge University Press, Cambridge
- Everitt, B.S. (1998) *The Cambridge Dictionary of Statistics*. Cambridge University Press, Cambridge
- Everitt, B.S. and Dunn, G. (2001) *Applied Multivariate Data Analysis*, 2nd edn. Edward Arnold, London
- Evermann, J.F., Bryan, G.M. and McKiernan, A.J. (1981) Isolation of a calicivirus from a case of canine glossitis. *Canine Practice*, **8**, 36–39
- Ewald, P.W. (1995) The evolution of virulence: a unifying link between parasitology and ecology. *Journal of Parasitology*, **81**, 465–485
- Ewbank, D. and Wray, J.D. (1980) Population and public health. In: *Maxcy-Rosenau: Public Health and Preventive Medicine*, 11th edn. Ed. Last, J.M., pp. 1504–1548, Appleton-Century-Crofts, New York
- Ewbank, R. (1986) Animal welfare – is an epidemiological approach possible? In: *Society for Veterinary Epidemiology and Preventive Medicine, Proceedings*, Edinburgh, 2–4 April 1986. Ed. Thrusfield, M.V., pp. 92–96
- Ewbank, R. (1988) Animal welfare. In: *Management and Welfare of Farm Animals*. The UFAW Handbook, 3rd edn, pp. 1–14. Baillière Tindall, London
- Ewbank, R. and Cullinan, A. (1984) The effect of simulated sonic booms on horses. In: *Proceedings of the International Congress on Applied Ethology in Farm Animals*, Kiel. Eds Unschelm, J., van Putten, G. and Zeeb, K., pp. 325–328. Kuratorium für Technik und Bauwesen in der Landwirtschaft, Darmstadt
- Eylenbosch, W.J. and Noah, N.D. (Eds) (1988) *Surveillance in Health and Disease*. Oxford University Press, Oxford
- Eyler, J.M. (2001) The changing assessments of John Snow's and William Farr's cholera studies. *Sozial- und Präventivmedizin*, **46**, 225–232
- Eyster, G.E., Eyster, J.T., Cords, G.B. and Johnston, J. (1976) Patent ductus arteriosus in the dog: characteristics of occurrence and results of surgery in one hundred consecutive cases. *Journal of the American Veterinary Medical Association*, **168**, 435–438
- Fabia, J., Boivin, J.-F., Bernard, P.-M., Ducic, S. and Thuriaux, M. (1988) English–French and French–English dictionary of terms used in epidemiology. *International Journal of Epidemiology*, **17** (1) Suppl. 1–49
- Fabricant, C.G. and Gillespie, J.H. (1974) Identification and characterization of a second feline herpesvirus. *Infection and Immunity*, **9**, 460–466
- Fagan, T.J. (1975) Nomogram for Bayes's Theorem (Letter) *New England Journal of Medicine*, **293**, 257
- Fahey, J.E. and Crawley, J.F. (1954) Studies on chronic respiratory disease of chickens. II. Isolation of a virus. *Canadian Journal of Comparative Medicine*, **18**, 13–21
- FAHRMX (1984) FAHRMX dairy herd health management computer network. In: *Proceedings of the Second Symposium on Computer Applications in Veterinary Medicine*. College of Veterinary Medicine, Mississippi State University, 23–25 May 1984, pp. 45–50
- Falconer, D.S. and Mackay, T.F.C. (1996) *Introduction to Quantitative Genetics*, 4th edn. Longman, Harlow
- Fallon, R.J. (2001) The development and use of electronic ruminal boluses as a vehicle for bovine identification.



- Revue Scientifique et Technique, Office International des Epizooties*, **20**, 480–490
- Famula, T.R., Oberbauer, A.M. and Colette Williams, D. (2001) Gender effects in hearing loss in Dalmatians. *Preventive Veterinary Medicine*, **48**, 15–24
- Fang, D.Y. and Wang, Y.K. (1981) Studies on the aetiology and specific control of goose parvovirus infection. *Scientia Agricultura Sinica*, **4**, 1–8 (in Chinese).
- FAO (1996) *The World without Rinderpest*. Proceedings of the FAO Technical Consultation on the Global Rinderpest Eradication Programme. Rome, Italy, 22–24 July 1996. Food and Agriculture Organization of the United Nations, Rome
- FAO (1999) *Agro-ecological Zones, Farming Systems and Land Pressure in Africa and Asia*. Consultancy Report by ERGO Ltd to the Animal Health Division of the Food and Agriculture Organization of the United Nations, Rome
- FAO (2002) *FAO Production Yearbook 2001*, Vol. 55. Food and Agriculture Organization of the United Nations, Rome
- FAO/WHO (1967) *Report of a Joint Food and Agriculture Organization/World Health Organization Expert Committee on Zoonoses*. Technical Report Series No. 3. World Health Organization, Geneva
- FAO/WHO (2002) *Risk Assessments of Salmonella in Eggs and Broiler Chickens*. Microbiological Risk Assessment Series 2. Food and Agriculture Organization of the United Nations, Rome/World Health Organization, Geneva
- FAO-WHO-OIE (1997) *Animal Health Yearbook 1995*. Food and Agriculture Organization of the United Nations, World Health Organization, Office International des Epizooties. Food and Agricultural Organization of the United Nations, Rome
- Farhoodi, M., Nowrouzian, I., Hovareshti, P., Bolourchi, M. and Nadalian, M. Gh. (2000) Factors associated with recto-vaginal injuries in Holstein dairy cows in a herd in Tehran, Iran. *Preventive Veterinary Medicine*, **46**, 143–148
- Farr, W. (1840) Appendix to the Second Annual Report of the Registrar-General of Births, Deaths, and Marriages in England, pp. 3–22. William Clowes and Sons, London. In: *House of Commons Parliamentary Papers, Vol. XVII. Reports from Commissioners, 2, Births; Deaths; Marriages; Poor Laws, Session 16 January–11 August, 1840*, pp. 39–58
- Fastier, L.B. (1957) A new feline virus isolated in tissue culture. *American Journal of Veterinary Research*, **18**, 382–389
- Faull, W.B., Hughes, J.W., Clarkson, M.J., Downham, D.Y., Manson, F.J., Merritt, J.B., Murray, R.D., Russell, W.B., Sutherst, J.E. and Ward, W.R. (1996) Epidemiology of lameness in dairy cattle: the influence of cubicles and indoor and outdoor walking surfaces. *Veterinary Record*, **139**, 130–136
- Fawcett, J. and Head, R. (2001a) Foot and mouth disease: business impact tracking survey Scotland (June 2001), second wave. Scottish Executive Central Research Unit, Edinburgh
- Fawcett, J. and Head, R. (2001b) Foot and mouth disease: business impact tracking survey Scotland (September 2001), third wave. Scottish Executive Central Research Unit, Edinburgh
- Faye, B. and Lescourret, F. (1989) Environmental factors associated with lameness in dairy cattle. *Preventive Veterinary Medicine*, **7**, 267–287
- Fearon, R. (2004) Vets warned against microchip anomalies. *Veterinary Times*, **34** (42), 1–2
- Feeney, C. (2004) PETS travel scheme. *Irish Veterinary Journal*, **57**, 406–407
- Fekadu, M. and Baer, G.M. (1980) Recovery from clinical rabies of 2 dogs inoculated with a rabies virus strain from Ethiopia. *American Journal of Veterinary Research*, **41**, 1632–1634
- Felton, M.R. and Ellis, P.R. (1978) *Studies in the Control of Rinderpest in Nigeria*. Study No. 23. University of Reading
- Fennell, C. (1975) Some demographic characteristics of the domestic cat population in Great Britain with particular reference to feeding habits and the incidence of the feline urological syndrome. *Journal of Small Animal Practice*, **16**, 775–783
- Fenner, F. and Ratcliffe, F.N. (1965) *Myxomatosis*. Cambridge University Press, Cambridge
- Fenner, F., Henderson, D.A., Arita, I., Jezek, Z. and Ladnyi, I.D. (1988) *Smallpox and its Eradication*. World Health Organization, Geneva
- Ferber, D. (2002) Livestock feed ban preserves drugs' power. *Science*, **295**, 27–28
- Ferguson, N.M., Donnelly, C.A. and Anderson, R.M. (2001) The foot-and-mouth epidemic in Great Britain: patterns of spread and impact of interventions. *Science*, **292**, 1155–1160
- Ferns, L., Dohoo, I. and Donald, A. (1991) A case-control study of *Nocardia* mastitis in Nova Scotia dairy herds. *Canadian Veterinary Journal*, **32**, 673–677
- Ferris, D.H. (1967) Epizootiology. *Advances in Veterinary Science*, **11**, 261–320
- Ferris, D.H. (1971) Epizootiologic features of transmissible swine gastroenteritis. *Journal of the American Veterinary Medical Association*, **159**, 184–194
- Fetrow, J., Stewart, S. and Eicker, S. (1997) Reproductive health programs for dairy herds: analysis of records for assessment of reproductive performance. In: *Current Therapy in Large Animal Theriogenology*, Ed. Youngquist, R.S., pp. 441–451. W.B. Saunders, Philadelphia
- Fey, P.D., Safraneck, T.J., Rupp, M.E., Dunne, E.F., Ribot, E., Iwen, P.C., Bradford, P.A., Angulo, F.J. and Hinrichs, S.H. (2000) Ceftriaxone-resistant salmonella infection acquired by a child from cattle. *New England Journal of Medicine*, **342**, 1242–1249
- Feyeraband, P. (1975) *Against Method: Outline of Anarchistic Theory of Knowledge*. Verso, London
- Feynman, R.P. (1988) *What Do You Care What Other People Think? Further Adventures of a Curious Character*. W.W. Norton, New York and London
- Fidler, I.J., Brodey, R.S., Howson, A.E. and Cohen, D. (1966) Relationship of estrus irregularity, pseudopregnancy, and pregnancy to canine pyometra. *Journal of the American Veterinary Medical Association*, **149**, 1043–1046
- Field, C.R. and Simkin, S.P. (1985) Camel production in Kenya. In: *Significance and Prospects of Camel Pastoralism*. Ed. Migot-Adholla, S.E. IDS Occasional Paper No. 45. Institute for Development Studies, University of Nairobi, Nairobi
- Fielding, R.D. (2004) Ethnoveterinary medicine in the tropics, In: *Bovine Medicine: Diseases and Husbandry of Cattle*, 2nd edn. Eds Andrews, A.H., Blowey, R.W., Boyd, H. and Eddy, R.G., pp. 83–87. Blackwell Science, Oxford



- Finlay, B.B. and Falkow, S. (1997) Common themes of microbial pathogenicity revisited. *Microbiology and Molecular Biology Reviews*, **61**, 136–169
- Finney, D.J. (1971) *Probit Analysis*, 3rd edn. Cambridge University Press, Cambridge
- Finney, D.J. (1978) *Statistical Method in Biological Assay*, 3rd edn. Charles Griffin, London and High Wycombe
- Firth, A.M. and Haldane, S.L. (1999) Development of a scale to evaluate postoperative pain in dogs. *Journal of the American Veterinary Medical Association*, **214**, 651–659
- Fischhoff, B., Slovic, P. and Lichtenstein, S. (1978) How safe is enough? A psychometric study of attitudes towards technological risks and benefits. *Policy Sciences*, **9**, 127–152
- Fisk, D. (1959) *Dr. Jenner of Baltimore*. William Heinemann, London
- Flannigan, G. and Dodman, N.H. (2001) Risk factors and behaviors associated with separation anxiety in dogs. *Journal of the American Veterinary Medical Association*, **219**, 460–466
- Flasse, S., Walker, C., Biggs, H., Stephenson, P. and Hutchinson, P. (1998) Using remote sensing to predict outbreaks of *Oestrus ovis* in Namibia. *Preventive Veterinary Medicine*, **33**, 31–38
- Fleiss, J.L. (1986) Analysis of data from multiclinic trials. *Controlled Clinical Trials*, **7**, 267–275
- Fleiss, J.L., Levin, B. and Paik, M.C. (2003) *Statistical Methods for Rates and Proportions*, 3rd edn. John Wiley, Hoboken
- Flesja, K.I. and Solberg, I. (1981) Pathological lesions in swine at slaughter. IV. Pathological lesions in relation to rearing system and herd size. *Acta Veterinaria Scandinavica*, **22**, 272–282
- Flesja, K.I., Forus, I.B. and Solberg, I. (1982) Pathological lesions in swine at slaughter. V. Pathological lesions in relation to some environmental factors in the herds. *Acta Veterinaria Scandinavica*, **23**, 169–183
- Fletcher, R.H., Fletcher, S.W. and Wagener, E.H. (1988) *Clinical Epidemiology: the Essentials*, 2nd edn. Williams and Wilkins, Baltimore
- Flint, J.C. and Moss, L.C. (1953) Infectious anaemia in cats. *Journal of the American Veterinary Medical Association*, **122**, 45–48
- Flori, J., Mousing, J., Gardner, I., Willeberg, P. and Have, P. (1995) Risk factors associated with seropositivity to porcine respiratory coronavirus in a Danish swine herd. *Preventive Veterinary Medicine*, **25**, 51–62
- Flower, S.S. (1931) Contributions to our knowledge of the duration of life in vertebrates. V. Mammals. *Proceedings of the Zoological Society of London*, pp. 145–234
- Foggini, C.M. (1983) Mokola virus infection in cats and a dog in Zimbabwe. *Veterinary Record*, **113**, 115
- Foley, C.W., Lasley, J.F. and Osweiler, G.D. (1979) *Abnormalities of Companion Animals: Analysis of Heritability*. Iowa State University Press, Ames
- Folk, L.C., Hahn, A.W., Patrick, T.B., Allen, G.K., Smith, A.B. and Wilcke, J.R. (2002) Salvaging legacy data: mapping an obsolete medical nomenclature to a modern one. *Biomedical Sciences Instrumentation*, **38**, 405–410
- Fooks, A.R., McElhinney, L.M., Brookes, S.M., Johnson, N., Keene, V., Parsons, G. and Soldan, A. (2002) Rabies antibody testing and the UK Pet Travel Scheme. *Veterinary Record*, **150**, 428–430
- Foosler, C.P., Wells, S.J., Kaneene, J.B., Ruegg, P.L., Warnick, L.D., Bender, J.B., Godden, S.M., Halbert, L.W., Campbell, A.M. and Geiger Zwald, A.M. (2004) Prevalence of *Salmonella* spp on conventional and organic dairy farms. *Journal of the American Veterinary Medical Association*, **225**, 567–573
- Forbes, N.A., Simpson, G.N., Higgins, R.J. and Gough, R.E. (1997) Adenovirus infection in Mauritius kestrels (*Falco punctatus*). *Journal of Avian Medicine and Surgery*, **11**, 31–33
- Ford, J. (1971) *The Role of the Trypanosomiasis in African Ecology: A Study of the Tsetse Fly Problem*. Clarendon Press, Oxford
- Foreyt, W.J. (1989) Fatal *Pastuerella haemolytica* pneumonia in bighorn sheep after direct contact with clinically normal domestic sheep. *American Journal of Veterinary Research*, **50**, 341–344
- Foreyt, W.J. and Jessup, D.A. (1982) Fatal pneumonia of bighorn sheep following association with domestic sheep. *Journal of Wildlife Diseases*, **18**, 163–168
- Forman, A.J. and Garland, A.J.M. (2002) Foot and mouth disease: the future of vaccine banks. *Revue Scientifique et Technique, Office International des Epizooties*, **21**, 601–612
- Forrow, L., Taylor, W.C. and Arnold, R. (1992) Absolutely relative: how research results are summarised can affect treatment decisions. *American Journal of Medicine*, **92**, 121–124
- Forster, F. (1966) Use of a demographic base map for the presentation of aerial data in epidemiology. *British Journal of Preventive and Social Medicine*, **20**, 156–171
- Forsyth, M.A., Kennedy, S., Wilson, S., Eybatov, T. and Barrett, T. (1998) Canine distemper virus in a Caspian seal. *Veterinary Record*, **143**, 662–664
- Fosgate, G.T., Hird, D.W., Read, D.H. and Walker, R.L. (2002) Risk factors for *Clostridium piliforme* infection in foals. *Journal of the American Veterinary Medical Association*, **220**, 785–790
- Fourichon, C., Madec, F., Pansart, J.F. and Paboeuf, F. (1990) The application of some multivariate statistical methods in epidemiology – an example: a cohort study of respiratory disease in pigs. In: Society for Veterinary Epidemiology and Preventive Medicine, Proceedings, Belfast, 4–6 April 1990. Ed. Thrusfield, M.V., pp. 153–166
- Fourichon, C.S.H., Seegers, H. and Malher, X. (2000) Effect of disease on reproduction in the dairy cow: a meta analysis. *Theriogenology*, **53**, 1729–1759
- Fox, J.P. (1958) Prophylaxis against rabies in humans. *Annals of the New York Academy of Sciences*, **70**, 480–494
- Fox, M.T. and Sykes, T.J. (1985) Establishment of the tropical dog tick, *Rhipicephalus sanguineus*, in a house in London. *Veterinary Record*, **116**, 661–662
- Francis, J. (1947) *Bovine Tuberculosis: Including a Contrast with Human Tuberculosis*. Staple Press, London
- Francis, P.G., Wilesmith, J.W. and Wilson, C.D. (1986) Observations on the incidence of clinical bovine mastitis in non-lactating cows in England and Wales. *Veterinary Record*, **118**, 549–552
- Frankena, K., Stassen, E.N., Noordhuizen, J.P. and Goelma, J.O. (1991a) Lameness in dairy cattle during housing: general descriptive results and risk analysis for dermatitis digitalis. In: Proceedings of the Sixth International Symposium on Veterinary Epidemiology and Economics, Ottawa, 12–16 August 1991. Ed. Martin, S.W., pp. 276–279

- Frankena, K., van Keulen, K.A.S., Noordhuizen, J.P., Noordhuizen-Stassen, E.N., Gundelach, J., de Jong, D.-J. and Saedt, I. (1991b) Prevalence and risk indicators of digital laminitis in dairy breeding calves. Studievereniging voor Veterinaire Epidemiologie en Economie, Proceedings, Utrecht, 11 December 1991. Eds. Hogeveen, H. and Nielen, M., pp. 41–52
- Frankena, K., van Keulen, K.A.S., Noordhuizen, J.P., Noordhuizen-Stassen, E.N., Gundelach, J., de Jong, D.-J. and Saedt, I. (1992) A cross-sectional study into prevalence and risk indicators of digital haemorrhages in female dairy calves. *Preventive Veterinary Medicine*, **14**, 1–12
- Frankena, K., van Keulen, K.A.S., Noordhuizen, J.P., Noordhuizen-Stassen, E.N., Gundelach, J., de Jong, D.-J. and Saedt, I. (1993) A cross-sectional study into prevalence and risk factors of dermatitis interdigitalis in female dairy calves in the Netherlands. *Preventive Veterinary Medicine*, **17**, 137–144
- Franti, C.E. and Kraus, J.F. (1974) Aspects of pet ownership in Yolo County, California. *Journal of the American Veterinary Medical Association*, **164**, 166–171
- Franti, C.E., Kraus, J.F. and Borhani, N.O. (1974) Pet ownership in a suburban-rural area of California, 1970. *Public Health Reports*, **89**, 473–484
- Franti, C.E., Kraus, J.F. and Borhani, N.O., Johnson, S.L. and Tucker, S.D. (1980) Pet ownership in rural northern California (El Dorado County). *Journal of the American Veterinary Medical Association*, **176**, 143–149
- Fraser, A.C. (1969) Advisory and preventive medicine in equine practice. *Veterinary Record*, **85**, 249–250
- Fraser, A.F. (1976) *Topics in Theriogenology*. A supplementary handbook on special practical and clinical features of veterinary reproduction. Western College of Veterinary Medicine, Saskatoon
- Fraumeni, J.F. (1967) Stature and malignant tumours of bone in childhood and adolescence. *Cancer*, **20**, 967–973
- Frazer, J.G. (1890) *The Golden Bough: A Study in Comparative Religion*, Vol. 2. Macmillan, London
- Frederiksen, B., Ødegaard, S.A. and Løken, T. (1998) The effect of bovine virus diarrhoea virus on reproduction in recently infected Norwegian dairy herds. *Acta Veterinaria Scandinavica*, **39**, 99–108
- Freeman, D.E., Hungerford, L.L., Schaeffer, D., Lock, T.F., Sertich, P.L., Baker, G.J., Vaala, W.E. and Johnston, J.K. (1999) Caesarean section and other methods for assisted delivery: comparison of effects on mare mortality and complications. *Equine Veterinary Journal*, **31**, 203–207
- Freer, M. and Dove, H. (Eds) (2002) *Sheep Nutrition*. CABI Publishing, Wallingford
- French, N.P. and Morgan, K.L. (1996) Role of neonatal and maternal risk factors in the faecal soiling of lambs. *Veterinary Record*, **139**, 460–465
- French, N.P., Wall, R., Cripps, P.J. and Morgan, K.L. (1992) Prevalence, regional distribution and control of blowfly strike in England and Wales. *Veterinary Record*, **131**, 337–342
- French, N.P., Berriatua, E., Kaya, G. and Morgan, K.L. (1998) Case control study of diarrhoea and faecal soiling in two- to six-month-old lambs. *Veterinary Record*, **143**, 408–412
- Frenkel, J.K. (1969) Choice of animal models for the study of disease processes in man. *Federation Proceedings*, **28**, 160–161
- Freshman, J.L., Reif, J.S., Allen, T.A., and Jones, R.L. (1989) Risk factors associated with urinary tract infection in female dogs. *Preventive Veterinary Medicine*, **7**, 59–67
- Freund, R.J. and Wilson, W.J. (1998) *Regression Analysis: Statistical Modeling of a Response Variable*. Academic Press, San Diego
- Frey, J.H. (1989) *Survey Research by Telephone*, 2nd edn. Sage, Newbury Park
- Friedman, L.M., Furberg, C.D. and DeMets, D.L. (1996) *Fundamentals of Clinical Trials*, 3rd edn. Mosby, St Louis
- Fries, C.L. and Remedios, A.M. (1995) The pathogenesis and diagnosis of canine hip dysplasia: a review. *Canadian Veterinary Journal*, **36**, 494–502
- Fritschen, R.D. (1979) Housing and its effect on feet and leg problems. *The Pig Veterinary Society Proceedings*, **5**, 95–98
- Frössling, J., Bonnett, B., Lindberg, A. and Björkman, C. (2003) Validation of *Neospora caninum* iscom ELISA without a gold standard. *Preventive Veterinary Medicine*, **57**, 141–153
- Frost, W.H. (1976) Some conceptions of epidemics in general. *American Journal of Epidemiology*, **103**, 141–151
- Frumkin, H. and Berlin, J. (1988) Asbestos exposure and gastrointestinal malignancy: review and meta-analysis. *American Journal of Industrial Medicine*, **14**, 79–95
- Fry, R. and Green, R. (1999) Biological and migrational characteristics of microchips (letter). *Veterinary Record*, **145**, 564
- Frye, F.L., Dorn, C.R., Taylor, D.O.N., Hibbard, H.H. and Klauber, M.R. (1967) Characteristics of canine mammary gland tumour cases. *Animal Hospital*, **3**, 1–12
- Fuller, S. (2003) *Kuhn vs Popper*. Icon Books, Cambridge
- Fulton, R.W., Purdy, C.W., Confer, A.W., Saliki, J.T., Loan, R.W., Briggs, R.E. and Burge, L.J. (2000) Bovine viral diarrhoea infections in feeder calves with respiratory disease: Interactions with *Pasteurella* spp. parainfluenza-3 virus, and bovine respiratory syncytial virus. *Canadian Journal of Veterinary Research*, **64**, 151–159
- Furniss, S.J., Edwards, S.A., Lightfoot, A.L. and Spechter, H.H. (1986) The effect of floor type in farrowing pens on pig injury. I. Leg and teat damage of suckling piglets. *British Veterinary Journal*, **142**, 434–440.
- Gaddum, J.H. (1933) *Reports of Biological Standards. III. Methods of Biological Assay Depending on a Quantal Response*. Special Report Series No. 183. Medical Research Council, London
- Gale, P. and Stanfield, G. (2001) Towards a quantitative risk assessment for BSE in sewage sludge. *Journal of Applied Microbiology*, **91**, 563–569
- Gale, P., Young, C., Stanfield, G. and Oakes, D. (1998) Development of a risk assessment for BSE in the aquatic environment. *Journal of Applied Microbiology*, **84**, 467–477
- Galen, R.S. (1982) Application of the predictive value model in the analysis of test effectiveness. *Clinical and Laboratory Medicine*, **2**, 685–699
- Galen, R.S. and Gambino, S.R. (1975) *Beyond Normality – The Predictive Value and Efficiency of Medical Diagnoses*. John Wiley, New York
- Gallagher, E., Kelly, L., Pfeiffer, D.U. and Wooldridge, M. (2003) A quantitative risk assessment for badger to cattle transmission of *Mycobacterium bovis*. In: Society for Veterinary Epidemiology and Preventive Medicine,

- Proceedings, Warwick, 31 March–2 April 2003. Eds Reid, S.W.J. and Menzies, F.D., pp. 33–44
- Galuzo, I.G. (1975) Landscape epidemiology (epizootiology). *Advances in Veterinary Science and Comparative Medicine*, **19**, 73–96
- Ganchi, C., Di Sacco, B., Formaggini, L., Venco, L., Vezzoni, A. and Guerro, J. (1992) Spreading of *Dirofilaria immitis* infections in dogs and cats in Italy. In: Proceedings of the 17th World Small Animal Veterinary Association Congress, Rome, 24–27 September 1992. Vol. 1. Ed. Delfino, A., pp. 203–209
- Gantner, G.E. (1977) History of coding. *Pathologist*, **31**, 390–395
- Garber, L.P., Salman, M.D., Hurd, H.S., Keefe, T. and Schlater, J.L. (1994) Potential risk factors for *Cryptosporidium* infection in dairy calves. *Journal of the American Veterinary Medical Association*, **205**, 86–91
- Garber, L.P., Wells, S.J., Hancock, D.D., Doyle, M.P., Tuttle, J., Shere, J.A. and Zhao, T. (1995) Risk factors for fecal shedding of *Escherichia coli* O157:H7 in dairy calves. *Journal of the American Veterinary Medical Association*, **207**, 46–49
- Gardiner, W.P. and Gettinby, G. (1983) A weather-based prediction model for the life-cycle of the sheep tick *Ixodes ricinus* (L). *Veterinary Parasitology*, **13**, 77–84
- Gardner, I.A. and Hird, D.W. (1994) Risk factors for development of foot abscess in neonatal pigs. *Journal of the American Veterinary Medical Association*, **204**, 1062–1067
- Gargadennec, L. and Lalanne, A. (1942) La peste des petits ruminants. *Bulletin des Services Zootechniques et des Epizooties de l'Afrique Occidentale Française*, **5**, 16–21
- Garland, A.J.M. and Donaldson, A.I. (1990) Foot and mouth disease. *Surveillance*, **17** (4), 6–8
- Garner, M.G. and Nunn, M.J. (1995) The Australian national animal health information system. *Épidémiologie et Santé Animale*, **27**, 143–160
- Gascoyne, S.C., King, A.A., Laurenson, M.K., Borner, M., Schildger, B. and Banat, J. (1993) Aspects of rabies infection and control in the conservation of the African wild dog (*Lycyaon pictus*) in the Serengeti region, Tanzania. *Onderstepoort Journal of Veterinary Research*, **60**, 415–420
- Gaskell, C.J. (1983). Dilated pupil (Key-Gaskell) syndrome in cats. In: Society for Veterinary Epidemiology and Preventive Medicine, Proceedings, Southampton, 12–13 April 1983. Ed. Thrusfield, M.V., pp. 99–100
- Gause, G.F. (1934) *The Struggle for Existence*. Williams and Wilkins, Baltimore
- Gaustad, D.V.M., Kjærsgaard, P. and Dolvik, N.I. (1995) Lameness in three-year-old Standardbred trotters – influence of parameters determined during the first year of life. *Journal of Equine Veterinary Science*, **15**, 233–239
- Geering, W.A., Penrith, M.-L. and Nyakahuma (2001) *Manual on Procedures for Disease Eradication and Stamping Out*. FAO Animal Health Manual No. 12. Food and Agriculture Organization of the United Nations, Rome
- Genovese, K.J., Anderson, R.C., Harvey, R.B. and Nisbet, D.J. (2000) Competitive exclusion treatment reduces the mortality and fecal shedding associated with enterotoxigenic *Escherichia coli* infection in nursery-raised neonatal piglets. *Canadian Journal of Veterinary Research*, **64**, 204–207
- George, L. (1995) *The Encyclopedia of Heresies and Heretics*. Robson Books, London
- George, L.W. (1993) Clinical infectious bovine keratoconjunctivitis. In: *Infectious Disease in Food Animal Practice*, pp. 159–168. Veterinary Learning Systems, Trenton
- Gershman, K.A., Sacks, J.J. and Wright, J.C. (1994) Which dogs bite? A case-control study of risk factors. *Pediatrics*, **93**, 913–917
- Gettinby, G. and Byrom, W. (1989) ECFXPART: A computer model for the study of East Coast fever. Eighth Biennial Conference and Bushfire Dynamics Workshop Proceedings, 25–27 September 1989, Australian National University, Canberra. Simulation Society of Australia Inc. affiliated with the International Association for Mathematics and Computers in Simulation, pp. 123–127
- Gettinby, G. and McClean, S. (1979) A matrix formulation of the life cycle of liver fluke. *Proceedings of the Royal Irish Academy*, **79B**, 155–167
- Gettinby, G., Bairden, K., Armour, J. and Benitez-Usher, C. (1979) A prediction model for bovine ostertagiasis. *Veterinary Record*, **105**, 57–59
- Ghirotti, M. (1992) Rapid appraisal techniques: a tool for planning and managing animal health and production programmes. In: Society for Veterinary Epidemiology and Preventive Medicine, Proceedings, Edinburgh, 1–3 April 1992. Ed. Thrusfield, M.V., pp. 190–206
- Gibbens, J.C. and Wilesmith, J.W. (2002) Temporal and geographical distribution of cases of foot-and-mouth disease during the early weeks of the 2001 epidemic in Great Britain. *Veterinary Record*, **151**, 407–412
- Gibbens, J.C., Pascoe, S.J.S., Evans, S.J., Davies, R.H. and Sayers, A.R. (2001a) A trial of biosecurity as a means to control *Campylobacter* infection of broiler chickens. *Preventive Veterinary Medicine*, **48**, 85–99
- Gibbens, J.C., Sharpe, C.E., Wilesmith, J.W., Mansley, L.M., Michalopoulou, E., Ryan, J.B.M. and Hudson, M. (2001b) Descriptive epidemiology of the 2001 FMD epidemic in Great Britain: the first five months. *Veterinary Record*, **149**, 729–743
- Gibbs, C. (1997) The BVA/KC scoring scheme for control of hip dysplasia: interpretation of criteria. *Veterinary Record*, **141**, 275–284
- Gibson, M. and Warren, K.S. (1970) Capture of *Schistosoma mansoni* miracidia and cercariae by carnivorous aquatic vascular plants of the genus *Utricularia*. *Bulletin of the World Health Organization*, **42**, 833–835
- Gibson, T.E. (1978) The 'Mt' system for forecasting the prevalence of fascioliasis. In: *Weather and Parasitic Animal Disease*. Ed. Gibson, T.E., pp. 3–5, World Meteorological Organization Technical Note No. 159
- Gibson, W. (2001) Sex and evolution in trypanosomes. *International Journal for Parasitology*, **31**, 643–647
- Giddens, A. (1987) *Social Theory and Modern Society*. Blackwell Publications, Oxford
- Gill, G. (1993) *O.K., The Data's Lousy, But It's All We've Got (Being a Critique of Conventional Methods)*. Gatekeeper Series No. SA38. International Institute for Environment and Development, London
- Gill, J.L. (1987) Biased statistical analysis when the animal is not the experimental unit. (letter). *Journal of the American Veterinary Medical Association*, **190**, 5–6

- Gillette, E.L. (1979) Radiotherapy. In: *Veterinary Cancer Medicine*. Eds Theilen, G.H. and Madwell, B.R., pp. 85–94. Lea and Febiger, Philadelphia
- Gillette, E.L. (1982) Spontaneous animal neoplasms as models for therapeutic agents. In: *Design of Models for Testing Cancer Therapeutic Agents*. Eds Figler, I.J. and White, R.J., pp. 185–192. Van Nostrand Reinhold, New York
- Gilmour, J.S. (1989) Grass sickness in horses. *Animal Diseases Research Association News Sheet No. 17*. Moredun Research Institute, Edinburgh
- Gilmour, J.S. and Jolly, G.M. (1974) Some aspects of the epidemiology of equine grass sickness. *Veterinary Record*, **95**, 77–81
- Gilovich, T., Griffin, D. and Kahneman, D. (Eds) (2002) *Heuristics and Biases: The Psychology of Intuitive Judgement*. Cambridge University Press, Cambridge
- Gitau, T., McDermott, J.J. and Mbiuki, S.M. (1996) Prevalence, incidence, and risk factors for lameness in dairy cattle in small-scale farms in Kikuyu Division, Kenya. *Preventive Veterinary Medicine*, **28**, 101–115
- Gittinger, J.P. (1972) *Economic Analysis of Agricultural Projects*. The Johns Hopkins University Press, Baltimore and London
- Glass, G.V. (1976) Primary, secondary, and meta-analysis of research. *Educational Research*, **5**, 3–8
- Glass, G.V., McGaw, B. and Smith, M.L. (1981) *Meta-analysis in Social Research*. Sage Publications, Beverly Hills
- Glickman, L.T. (1980) Preventive medicine in kennel management. In: *Current Veterinary Therapy VII. Small Animal Practice*. Ed. Kirk, R.W., pp. 67–76. W.B. Saunders Company, Philadelphia
- Glickman, L.T., Domanski, L.M., Maguire, T.G., Dubielzig, R.R. and Churg, A. (1983) Mesothelioma in pet dogs associated with exposure of their owners to asbestos. *Environmental Research*, **32**, 305–313
- Glickman, L.T., Domanski, L.M., Patronek, G.J. and Visintainer, F. (1985) Breed-related risk factors for canine parvovirus enteritis. *Journal of the American Veterinary Medical Association*, **187**, 589–594
- Glickman, L.T., Schofer, F.S., McKee, L.J., Reif, J.S. and Goldschmidt, M.H. (1989) Epidemiologic study of insecticide exposures, obesity, and risk of bladder cancer in household dogs. *Journal of Toxicology and Environmental Health*, **28**, 407–414
- Glickman, L.T., Glickman, N.W., Perez, C.M., Schellenberg, D.B. and Lantz, G.C. (1994) Analysis of risk factors for gastric dilatation and dilatation-volvulus in dogs. *Journal of the American Veterinary Medical Association*, **204**, 1465–1471
- Glickman, L.T., Raghavan, M., Knapp, D.W., Bonney, P.L. and Dawson, M.H. (2004) Herbicide exposure and the risk of transitional cell carcinoma of the urinary bladder in Scottish Terriers. *Journal of the American Veterinary Medical Association*, **224**, 1290–1297
- Glosser, J.W. (1988) Back to the future: the Animal Health Monitoring System – a political necessity being addressed in the United States. *Acta Veterinaria Scandinavica*, Suppl. 84, 42–48
- Gloster, J., Blackall, R.M., Sellers, R.F. and Donaldson, A.I. (1981) Forecasting the airborne spread of foot-and-mouth disease. *Veterinary Record*, **108**, 370–374
- Gloster, J., Sellers, R.F. and Donaldson, A.I. (1982) Long distance transport of foot and mouth disease virus over the sea. *Veterinary Record*, **110**, 47–52
- Gloster, J., Donaldson, A.I. and Hough, M.N. (1984) Analysis of a series of outbreaks of Aujeszky's disease in Yorkshire in 1981–82: the possibility of airborne disease spread. *Veterinary Record*, **114**, 234–239
- Gloster, J., Hewson, H., Mackay, D., Garland, T., Donaldson, A., Mason, I. and Brown, R. (2001) Spread of foot-and-mouth disease from the burning of animal carcasses on open pyres. *Veterinary Record*, **148**, 585–586
- Gloster, J., Freshwater, A., Sellers, R.F. and Alexandersen, S. (2005) Re-assessing the likelihood of airborne spread of foot-and-mouth disease at the start of the 1967–1968 UK foot-and-mouth disease epidemic. *Epidemiology and Infection*, **133**, 767–783
- Gobar, G.M., Case, J.T. and Kass, P.H. (1998) Program for surveillance of causes of death of dogs, using the Internet to survey small animal veterinarians. *Journal of the American Veterinary Medical Association*, **213**, 251–256
- Goggin, J.E., Li, A. and Franti, C.E. (1970) Canine intervertebral disc disease: characterization by age, sex, breed and anatomic site of involvement. *American Journal of Veterinary Research*, **31**, 1687–1692
- Gogolin-Ewens, K.J., Meeusen, E.N.T., Scott, P.C., Adams, T.E. and Brandon, M.R. (1990) Genetic selection for disease resistance and traits of economic importance in animal production. *Revue Scientifique et Technique, Office International des Epizooties*, **9**, 865–896
- Goldberger, J., Waring, C.H. and Tanner, W.F. (1923) Pellagra prevention by diet among institutional inmates. *Public Health Reports*, **38**, 2361–2368
- Goldschmidt, M.H. and Shofer, F.S. (1994) *Skin Tumours of the Dog and Cat*. Butterworth-Heinemann, Oxford
- Goldspink, G. and Gerlach, G.-F. (1990) Prospective use of recombinant DNA methods in animal disease control. In: *Proceedings of the Society for Veterinary Epidemiology and Preventive Medicine*, Belfast, 4–6 April 1990. Ed. Thrusfield, M.V., pp. 1–14
- Goldspink, G.E. (1993) The impact of recombinant DNA techniques on veterinary diagnosis and genetic screening. In: *The Advancement of Veterinary Science. The Bicentenary Symposium Series. Volume 1: Veterinary Medicine beyond 2000*. Ed. Michell, A.R., pp. 59–71. CAB International, Wallingford
- Goltsman, M.K., Kruchenkova, E.P. and MacDonald, D.W. (1996) The Mednyi arctic foxes: treating a population imperilled by disease. *Oryx*, **30**, 251–258
- Good, P. (1993) *Permutation Tests*. Springer Verlag, New York
- Goodall, E.A., McCaughey, W.J., McMurray, C.H. and Rice, D. (1984) SIRO – a computer system for dairy herd recording. In: *Society for Veterinary Epidemiology and Preventive Medicine, Proceedings*, Edinburgh, 10–11 July 1984. Ed. Thrusfield, M.V., pp. 174–183
- Goodall, E.A., Menzies, F.D., McConachy, D.A. and McLroy, S.G. (1997) A disease management information system for profitable broiler production. In: *Society for Veterinary Epidemiology and Preventive Medicine*, Chester, 9–11 April 1997, Eds Goodall, E.A. and Thrusfield, M.V., pp. 268–278
- Goodger, W.J. and Ruppner, R. (1982) Why the dairy industry does not make greater use of veterinarians. *Journal of the American Veterinary Medical Association*, **181**, 706–710

- Goodman, R.A. and Buehler, J.W. (2002) Field epidemiology defined. In: *Field Epidemiology*, Ed. Gregg, M.B., 2nd edn, pp. 3–7. Oxford University Press, New York
- Goodman, S.N. (1999a) Towards evidence-based medical statistics. 1: The *P* value fallacy. *Annals of Internal Medicine*, **130**, 995–1004
- Goodman, S.N. (1999b) Towards evidence-based medical statistics. 2: The Bayes factor. *Annals of Internal Medicine*, **130**, 1005–1013
- Goodman, S.N. and Berlin, J.A. (1994) The use of predicted confidence intervals when planning experiments and the misuse of power when interpreting results. *Annals of Internal Medicine*, **121**, 200–206
- Goodwin, K.A., Jackson, R., Brown, C., Davies, P.R., Morris, R.S. and Perkins, N.R. (2004) Pneumonic lesions in lambs in New Zealand: patterns of prevalence and effects on production. *New Zealand Veterinary Journal*, **52**, 175–179
- Goodwin, R.F.W. (1971) A procedure for investigating the influence of disease status on productivity efficiency in a pig herd. *Veterinary Record*, **88**, 387–392
- Gopal, T. (1977) Carcinogenesis. In: *Current Veterinary Therapy VI. Small Animal Practice*. Ed. Kirk, R.W., pp. 164–166. W.B. Saunders, Philadelphia
- Gordon, E.R., Curns, A.T., Krebs, J.W., Rupprecht, C.E., Real, L.A. and Childs, J.E. (2004) Temporal dynamics of rabies in a wildlife host and the risk of cross-species transmission. *Epidemiology and Infection*, **132**, 515–524
- Gordon, J.C. and Angrick, E.J. (1985) Stray dogs as sentinels for canine parvovirus. *Preventive Veterinary Medicine*, **3**, 311–316
- Gordon Smith, C.E. (1976) *Epidemiology and Infections*. Meadowfield Press, Shildon
- Gordon Smith, C.E. (1982) Major factors in the spread of infections. In: *Animal Disease in Relation to Animal Conservation*. Symposium of the Zoological Society of London No. 50. Eds Edwards, M.A. and McDonald, U., pp. 207–235. Academic Press, London and New York
- Gorman, B.M., Taylor, J. and Walker, P.J. (1979) Variation in arboviruses. In: *Arbovirus Research in Australia*. Proceedings of the Second Symposium, 17–19 July 1979. Eds St George, T.D. and French, E.L., pp. 71–76. The Commonwealth Scientific and Industrial Research Organization/Queensland Institute of Medical Research, Brisbane
- Gottstein, B. (1984) An immunoassay for the detection of circulating antigens in human echinococcosis. *American Journal of Tropical Medicine and Hygiene*, **33**, 1185–1191
- Gough, A. and Thomas, A. (2003) *Breed Predispositions to Disease in Dogs and Cats*. Blackwell Publishing, Oxford
- Gould, L.C., Gardner, G.T., DeLuca, G.R., Tiemann, A.R., Doob, L.W. and Stolwijk, J.A.J. (1988) *Perceptions of Technological Risks and Benefits*. Russell Sage Foundation, New York
- Goulden, C.H. (1952) *Methods of Statistical Analysis*, 2nd edn. Chapman and Hall, London
- Graat, E.A.M. and Frankena, K. (2001) Introduction to theoretical epidemiology. In: *Application of Quantitative Methods in Veterinary Epidemiology*, 2nd edn. Eds Noordhuizen, J.P.T.M., Frankena, K., Thrusfield, M.V. and Graat, E.A.M., pp. 239–259. Wageningen Pers, Wageningen
- Graat, E.A.M., van der Kooij, E., Frankena, K., Henken, A.M., Smeets, J.F.M. and Hekerman, M.T.J. (1996) Quantifying risk factors for coccidiosis in broilers using data of a veterinary poultry practice. In: *Society for Veterinary Epidemiology and Preventive Medicine, Proceedings, Glasgow, 27–29 March 1996*, Eds Thrusfield, M.V. and Goodall, E.A., pp. 102–108
- Graat, E.A.M., van der Kooij, E., Frankena, K., Henken, A.M., Smeets, J.F.M. and Hekerman, M.T.J. (1998) Quantifying risk factors of coccidiosis in broilers using on-farm data based on a veterinary practice. *Preventive Veterinary Medicine*, **33**, 297–308
- Graat, L., Noordhuizen, J., Frankena, K., Henken, A. and Goelema, J. (1990) Epidemiological aspects of salmonellosis in poultry. In: *Studievereniging voor Veterinaire Epidemiologie en Economie, Proceedings, Wageningen, 19 December 1990*. Ed. Frankena, K., pp. 61–72
- Gracey, J.F. (1960) *Survey of Livestock Diseases in Northern Ireland*. Her Majesty's Stationery Office, Belfast
- Gracey, J. F., Collins, D.S. and Huey, R.J. (1999) *Meat Hygiene*, 10th edn. W.B. Saunders, London
- Grachev, M.A., Kumarev, V.P., Mamaev, L.V., Zorin, V.L., Baranova, L.V., Denikina, N.N., Belikov, S.I., Petrov, E.A., Kolesnik, V.S., Kolesnik, R.S., Dorofeev, V.M., Beim, A.M., Kudelin, V.N., Nagieva, F.G. and Sidorov, V.N. (1989) Distemper virus in Baikal seals. *Nature*, **338**, 209
- Grais, R.F., Ellis, J.H. and Glass, G.E. (2003) Forecasting the geographical spread of smallpox cases by air travel. *Epidemiology and Infection*, **131**, 849–857
- Grant, R.J., Scheidt, A.B. and Ruff, L.R. (1994) Aerosol transmission of a viable virus affecting swine: explanation of an epizootic of pseudorabies. *International Journal of Biometeorology*, **38**, 33–39
- Grauballe, P.C., Baagoe, H.J., Fekadu, M., Westergaard, J.M. and Zoffman, H. (1987) Bat rabies in Denmark. *Lancet*, **1**, 379–380
- Graunt, J. (1662) *Natural and Political Observations Mentioned in a Following Index, and Made Upon the Bills of Mortality*. Thomas Roycroft, London. Reprinted by The Johns Hopkins Press, Baltimore, 1939. Reproduced in facsimile, with an introduction by P. Laslett, in *The Earliest Classics*. Gregg International Publishers, Farnborough, 1973
- Green, L.E. and Medley, G.E. (2002) Mathematical modelling of the foot-and-mouth disease epidemic of 2001: strengths and weaknesses. *Research in Veterinary Science*, **73**, 201–205
- Green, L.E., Berriatua, E. and Morgan, K.L. (1995) The prevalence and risk factors for congenital entropion in intensively reared lambs in south west England. *Preventive Veterinary Medicine*, **24**, 15–21
- Green, L.E., Lewis, K., Kimpton, A. and Nicol C.J. (2000) Cross-sectional study of the prevalence of feather picking in laying hens in alternative systems and its associations with management and disease. *Veterinary Record*, **147**, 233–238
- Green, S.B. and Byar, D.P. (1984) Using observational data from registries to compare treatments: the fallacy of omnimetrics. *Statistics in Medicine*, **3**, 361–370
- Greene, C.E. (1998a) Canine immunization recommendations. In: *Infectious Diseases of the Dog and Cat*, 2nd edn. Ed. Greene, C.F., p. 751. W.B. Saunders, Philadelphia

- Greene, C.E. (1998b) Environmental factors in infectious disease. In: *Infectious Diseases of the Dog and Cat*, 2nd edn. Ed. Greene, C.F., pp. 673–683. W.B. Saunders, Philadelphia
- Greene, W.H. (2003) *Econometric Analysis*, 5th edn. Prentice Hall, New Jersey
- Greenland, S. (1987) Quantitative methods in the review of epidemiologic literature. *Epidemiologic Reviews*, **9**, 1–30
- Greenland, S. and Finkle, W.D. (1995) A critical look at methods for handling missing covariates in epidemiologic regression analyses. *American Journal of Epidemiology*, **142**, 1255–1264
- Greenland, S. and Kleinbaum, D.G. (1983) Correcting for misclassification in two-way tables and matched-pair studies. *International Journal of Epidemiology*, **12**, 93–97
- Greenland, S., Morgenstern, H. and Thomas, D.C. (1981) Considerations in determining matching criteria and stratum sizes for case-control studies. *International Journal of Epidemiology*, **10**, 389–392
- Greenough, P.R. and Weaver, A.D. (Eds) (1997) *Lameness in Cattle*, 3rd edn. W.B. Saunders, Philadelphia
- Greenwood, Major (1943) Medical statistics from Graunt to Farr. VI. Some English medical statisticians in the Eighteenth century. *Biometrika*, **33**, 1–24
- Greenwood, P. (2004) Animal identification and the veterinary practitioner. *Canadian Veterinary Journal*, **45**, 332–333
- Gregory, Fr. CSWG (2002) War in Heaven. *New Directions*, **5**(80), 6–8
- Greiner, M., Böhning, D. and S. Dahms, S. (1997) Meta-analytic review of ELISA tests for the diagnosis of human and porcine trichinellosis: which factors are involved in diagnostic accuracy? In: Society for Veterinary Epidemiology and Preventive Medicine, Proceedings, Chester, 9–11 April 1997. Eds Goodall, E.A. and Thrusfield, M.V., pp. 12–21
- Greiner, M., Pfeiffer, D. and Smith, R.D. (2000) Principles and practical application of the receiver-operating characteristic analysis for diagnostic tests. *Preventive Veterinary Medicine*, **45**, 23–41
- Greiser-Wilke, I., Grummer, B. and Moennig, V. (2003) Bovine viral diarrhoea eradication and control programmes in Europe. *Biologicals*, **31**, 113–118
- Grenfell, B.T., Pybus, O.G., Gog, J.R., Wood, J.L.N., Daly, J.M., Mumford, J.A. and Holmes, E.C. (2004) Unifying the epidemiological and evolutionary dynamics of pathogens. *Science*, **303**, 327–332
- Griffin, J.M., Hahesy, T., Lynch, K., Salman, M.D., McCarthy, J. and Hurley, T. (1993) The association of cattle husbandry practices, environmental factors and farmer characteristics with the occurrence of chronic bovine tuberculosis in dairy herds in the Republic of Ireland. *Preventive Veterinary Medicine*, **17**, 145–160
- Griffin, J.M., Wayne Martin, S., Thorburn, M.A., Eves, J.A. and Hammond, R.F. (1996) A case-control study on the association of selected risk factors with the occurrence of bovine tuberculosis in the Republic of Ireland. *Preventive Veterinary Medicine*, **27**, 75–87
- Griffiths, A.O. and Brenner, A. (1977) Survey of cat and dog ownership in Champagne County, Illinois, 1976. *Journal of the American Veterinary Medical Association*, **170**, 1333–1340
- Griffiths, I.B. and Done, S.H. (1991) Citrinin as a possible cause of the pruritis, pyrexia, haemorrhagic syndrome in cattle. *Veterinary Record*, **129**, 113–117
- Grindle, R.J. (1980) Appropriate methodology in economic analysis of disease control projects. In: *Veterinary Epidemiology and Economics*. Proceedings of the Second International Symposium, Canberra, 7–11 May 1979. Eds Geering, W.A., Roe, R.T. and Chapman, L.A., pp. 506–510. Australian Government Publishing Service, Canberra
- Grindle, R.J. (1986) The use and abuse of economic methods as applied to veterinary problems. In: Proceedings of the Fourth International Symposium on Veterinary Epidemiology and Economics, Singapore, 18–22 November 1985, pp. 60–70. Singapore Veterinary Association, Singapore
- Griner, L.A. (1980) Storage and retrieval of necropsy records at San Diego zoo. In: *The Comparative Pathology of Zoo Animals*. Eds Montali, R.J. and Miguki, G., pp. 663–667. Smithsonian Institution Press, Washington, DC
- Griner, L.A. and Hutton, N.E. (1968) Pathology data retrieval system adopted at a zoological garden. *Journal of the American Veterinary Medical Association*, **153**, 885–892
- Grisel, J.E. (2000) Quantitative trait locus analysis. *Alcohol, Health & Research*, **24**, 169–174
- Groehn, J.A., Kaneene, J.B. and Foster, D. (1992) Risk factors associated with lameness in lactating dairy cattle in Michigan. *Preventive Veterinary Medicine*, **14**, 77–85
- Grohn, Y.T., Erb, H.N. and Saloniemi, H.S. (1988) Risk factors for the disorders of the mammary gland in dairy cattle. *Acta Veterinaria Scandinavica*, Suppl. **84**, 170–172
- Grohn, Y.T., Erb, H.M., McCulloch, C.E. and Saloniemi, H.S. (1990) Epidemiology of reproductive disorders in dairy cattle: associations among host characteristics, disease and production. *Preventive Veterinary Medicine*, **8**, 25–39
- Grondalen, J. and Lingaas, F. (1991) Arthrosis in the elbow joint of young rapidly growing dogs: a genetic investigation. *Journal of Small Animal Practice*, **32**, 460–464
- Grønvold, J., Henriksen, S.A., Nansen, P., Wolstrup, J. and Thylin, J. (1989) Attempts to control infection with *Ostertagia ostertagi* (Trichostrongylidae) in grazing calves by adding mycelium of the nematode-trapping fungus *Arthrobotrys oligospora* (Hyphomycetales) to cow pats. *Journal of Helminthology*, **63**, 115–126
- Grønvold, J., Wolstrup, J., Nansen, P., Henriksen, S.A., Larsen, M. and Bresciani, J. (1993) Biological control of nematode parasites in cattle with nematode-trapping fungi: a survey of Danish studies. *Veterinary Parasitology*, **48**, 311–325
- Gross, L. (1955) Mouse leukaemia: an egg-borne virus disease (with a note on mouse salivary gland carcinoma). *Acta Haematologica*, **13**, 13–29
- Groves, R.M. (1989) *Survey Errors and Survey Costs*. John Wiley, New York
- Groves, R.M., Biemer, P.P., Lyberg, L.E., Massey, J.T., Nicholls, W.L. and Waksberg, J. (Eds) (1988) *Telephone Survey Methodology*. John Wiley, New York
- Grufferman, S. and Kimm, S.Y.S. (1984) Clinical epidemiology defined. *The New England Journal of Medicine*, **311**, 541–542
- Grunsell, C.S., Penny, R.H.C., Wragg, S.R. and Allcock, J. (1969) The practicability and economics of veterinary preventive medicine. *Veterinary Record*, **84**, 26–41

- Guerra, M., Walker, E.C., Paskewitz, S.M. Cortinas, M.R., Stancil, A., Beck, L., Bobo, M. and Kitron, U. (2002) Predicting the risk of Lyme disease: habitat suitability for *Ixodes scapularis* in the North Central United States. *Emerging Infectious Diseases*, **8**, 289–297
- Guerrero, J., Newcomb, K.M. and Fukase, T. (1992) Prevalence of *Dirofilaria immitis* in dogs and cats in the USA and Japan. In: Proceedings of the 17th World Small Animal Veterinary Association Congress, Rome, 24–27 September 1992. Vol. 1. Ed. Dolfino, A., pp. 211–217
- Gutián, F.J., Camacho, A.T. and Telford III, S.R. (2003) Case-control study of canine infection by a newly recognised *Babesia microti*-like piroplasm. *Preventive Veterinary Medicine*, **61**, 137–145
- Gujarati, D. (1999) *Essentials of Econometrics*, 2nd edn. McGraw-Hill, New York
- Gummow, B. (1996) Experimentally induced chronic copper toxicity in cattle. *Onderstepoort Journal of Veterinary Research*, **63**, 277–288
- Gummow, B., Botha, C.J., Basson, A.T. and Bastianello, S.S. (1991) Copper toxicity in ruminants: air pollution as a possible cause. *Onderstepoort Journal of Veterinary Research*, **58**, 33–39
- Gunn, G.J. and Stott, A.W. (1996) Combining economic arguments and active surveillance to promote better management of endemic cattle disease. In: Society for Veterinary Epidemiology and Preventive Medicine, Proceedings, Glasgow, 27–29 March 1996, Eds Thrusfield, M.V. and Goodall, E.A., pp. 1–7
- Gunnarsson, S., Keeling, L.J. and Svedberg, J. (1998) Effects of rearing conditions on behavioural problems in laying hens: an epidemiological approach. In: Proceedings of the 32nd Congress of the International Society for Applied Ethology, 21–25 July 1998, Clermont-Ferrand, France. Eds Veissier, I. and Boissy, A., p. 57. Institut National de la Recherche Agronomique, France
- Gunn-Moore, D.A. and Thrusfield, M.V. (1995) Feline dystocia: prevalence and association with cranial conformation and breed. *Veterinary Record*, **136**, 350–353
- Gupta, A.K. and Nadaraja, S. (Eds) (2004) *Handbook of Beta Distribution and its Application*. Marcel Dekker Inc., New York
- Gupta, S. (2001) Avoiding ambiguity. *Nature*, **412**, 589
- Guptill, L., Glickman, L. and Glickman, N. (2003) Time trends and risk factors for diabetes mellitus in dogs: analysis of Veterinary Medical Data Base Records (1970–1999). *The Veterinary Journal*, **165**, 240–247
- Gustafsson, H. and Emanuelson, U. (2002) Characterisation of the repeat breeding syndrome in Swedish dairy cattle. *Acta Veterinaria Scandinavica*, **43**, 115–125
- Gustavsson, I. (1969) Cytogenetics, distribution and phenotypic effects of a translocation in Swedish cattle. *Hereditas*, **63**, 68–169
- Guthrie, R.S. and Pidduck, H. (1990) Heritability of elbow osteochondrosis within a closed population of dogs. *Journal of Small Animal Practice*, **31**, 93–96
- Haas, S.D., Bristol, F. and Card, C.E. (1996) Risk factors associated with the incidence of foal mortality in an extensively managed mare herd. *Canadian Veterinary Journal*, **37**, 91–95
- Habermas, J. (1972) *Knowledge and Human Interests*. Heinemann Educational, London
- Habtemariam, T., Ruppaner, R., Farver, T.B. and Riemann, H.P. (1986) Determination of risk groups to African trypanosomiasis using discriminant analysis. *Preventive Veterinary Medicine*, **4**, 45–56
- Habtemariam, T., Gharty-Tagoe, A., Robnett, V. and Trammel, G. (1988) Computational epidemiology: new research avenues. *Acta Veterinaria Scandinavica*, Suppl. **84**, 439–441
- Hacking, I. (1975) *The Emergence of Probability: A Philosophical Study of Early Ideas about Probability, Induction and Statistical Inference*. Cambridge University Press, Cambridge
- Hackstadt, T. (1998) The diverse habitats of obligate intracellular parasites. *Current Opinions in Microbiology*, **1**, 82–87
- Haelterman, E.O. (1963) Epidemiological studies of transmissible gastroenteritis of swine. Proceedings of the 66th annual meeting of the United States Livestock Sanitary Association, 29 October–2 November 1962, Washington, DC, pp. 305–315
- Häggeström, J., Hansson, K., Kvart, C. and Swenson, L. (1992) Chronic valvular disease in the cavalier King Charles spaniel in Sweden. *Veterinary Record*, **131**, 549–553
- Hahn, K.A., Bravo, L., Adams, W.H. and Frazier, D.L. (1994) Naturally-occurring tumors in dogs as comparative models for cancer therapy and research. *In Vivo*, **8**, 133–144
- Haig, D.A. (1977) Rabies in animals. In: *Rabies: The Facts*. Ed. Kaplan, C., pp. 53–69. Oxford University Press, Oxford
- Haig, D.A., Clarke, M.C. and Pereira, M.S. (1964) Isolation of an adenovirus from a pig. *Journal of Comparative Pathology*, **74**, 81–84
- Haladej, S. and Hurcik, V. (1988) Computerised management system of the Veterinary Service in the Slovak Socialist Republic. *Revue Scientifique et Technique, Office International des Epizooties*, **7**, 517–541
- Hall, S.A. (1978) Farm animal disease data banks. *Advances in Veterinary Science and Comparative Medicine*, **22**, 265–286
- Hall, S.A., Dawson, P.S. and Davies, G. (1980) VIDA II: A computerised diagnostic recording system for veterinary investigation centres in Great Britain. *Veterinary Record*, **106**, 260–264.
- Halliday, S. (2000) William Farr: a campaigning statistician. *Journal of Medical Biography*, **8**, 220–227
- Halliwell, R.E.W. (1978) Autoimmune disease in the dog. *Advances in Veterinary Science*, **22**, 221–263
- Halloran, M.E. (1998) Concepts of infectious disease epidemiology. In: *Modern Epidemiology*, 2nd edn. Eds Rothman, K.J. and Greenland, S., pp. 529–554. Lippincott-Raven, Philadelphia
- Hallstrom, A.P. and Trobaugh, G.B. (1985) Specificity, sensitivity, and prevalence in the design of randomized trials: a univariate analysis. *Controlled Clinical Trials*, **6**, 128–135
- Hamilton, W. (1852) *Discussions on Philosophy and Literature, Education and University Reform*. Longman, Brown, Green and Longmans, London
- Hamlen, H.J., Timoney, J.F. and Bell, R.J. (1994) Epidemiologic and immunologic characteristics of *Streptococcus equi* infection of foals. *Journal of the American Veterinary Medical Association*, **209**, 760–775
- Hammell, K.L. and Dohoo, I.R. (1999) The epidemiology of hemorrhagic kidney syndrome – infectious salmon anemia in Atlantic salmon in Atlantic Canada. In: Society for Veterinary Epidemiology and Preventive Medicine,



- Proceedings, Bristol, 24–26 March 1999, Eds Goodall, E.A. and Thrusfield, M.V., pp. 211–221
- Hammond, R.F. and Lynch, K. (1992) The use and application of geographical information system technology in the Tuberculosis Investigation Unit. Tuberculosis Investigation Unit, University College Dublin, selected papers, pp. 28–30
- Hancock, R.D. and Prado, J.A.P. (1993) Foot-and-mouth disease in a flock of sheep in southern Brazil. *Veterinary Record*, **132**, 278–279
- Hand, M.S., Thatcher, C.D., Remillard, R.L. and Roudebush, P. (Eds) (2000) *Small Animal Clinical Nutrition*, 4th edn. Mark Morris Institute, Topeka
- Hanley, J.A. and McNeill, B.J. (1982) The meaning and use of the area under a receiver operating characteristic (ROC) curve. *Radiology*, **143**, 29–36
- Hanna, S.R., Briggs, G.A. and Hosker, R.P. (1982) *Handbook on Atmospheric Diffusion*. Technical Information Center, US Department of Energy. Document DE82002045 (DOE/TIC-11223). National Technical Information Service. US Department of Commerce, Springfield, Virginia
- Hanrahan, C.E. and Becker, G.S. (2004) *Mad Cow Disease and the U.S. Beef Trade. CRS Report for Congress, 4 August 2004*. Congressional Research Service, The Library of Congress, 101 Independence Avenue, SE, Washington, DC 20540-7500
- Hanssen, I. (1991) Hip dysplasia in dogs in relation to their month of birth. *Veterinary Record*, **128**, 425–426
- Hardie, E.M. (2000) Recognition of pain behaviour in animals. In: *Animal Pain: A Practice-oriented Approach to an Effective Pain Control in Animals*. Ed. Heelebrekers, I.J., pp. 51–69. Vander Wees, Utrecht.
- Hare, K.M. and Biggs, H.C. (1996) Design and evaluation of a veterinary information system for Namibia. *Preventive Veterinary Medicine*, **26**, 239–251
- Haresnape, J.M. and Wilkinson, P.J. (1989) A study of African swine fever virus infected ticks (*Ornithodoros moubata*) collected from villages in the ASF enzootic area of Malawi following an outbreak of the disease in domestic pigs. *Epidemiology and Infection*, **102**, 507–522
- Harremoes, P., Gee, D., MacGarvin, M., Stirling, A., Keys, J., Wynne, B. and Vaz, S.G. (Eds) (2001) *Late Lessons from Early Warnings: the Precautionary Principle 1896–2000*. European Environment Agency, Environmental issue report No. 22. Office for Official Publications of the European Communities, Luxembourg
- Harrenstien, L.A., Munson, L., Seal, U.S. and the American Zoo and Aquarium Association Mammary Cancer Study Group (1996) Mammary cancer in captive wild felids and risk factors for its development: a retrospective study of the clinical behavior of 31 cases. *Journal of Zoo and Wildlife Medicine*, **27**, 468–476
- Harris, D.J. (1981) Factors predisposing to parturient paresis. *Australian Veterinary Journal*, **57**, 357–361
- Harris, D.J., Lambell, R.G. and Oliver, C.J. (1983) Factors predisposing dairy and beef cows to grass tetany. *Australian Veterinary Journal*, **60**, 230–234
- Harrison, D.J., Bissonette, J.A. and Sherburne, J.A. (1989) Spatial relationships between coyotes and red foxes in Eastern Maine. *Journal of Wildlife Management*, **53**, 181–185
- Hartman, A., van Wuijkhuis, L., Frankena, K., Franken, P., Wever, P., de Wit, J. and Kramps, J. (1997) Within-herd BHV-1 prevalence prediction from an ELISA on bulk milk. *Veterinary Record*, **140**, 484–485
- Hartsough, G.R. and Burger, D. (1965) Encephalopathy of mink. I. Epizootiologic and clinical observations. *Journal of Infectious Diseases*, **115**, 387–392
- Hartsough, G.R. and Gorham, J.R. (1956) Aleutian disease in mink. *National Fur News*, **28**, 10–11
- Hashmi, H.A. and Connan, R.M. (1989) Biological control of ruminant trichostrongylids by *Arthrobotrys oligospora*, a predaceous fungus. *Parasitology Today*, **5**, 28–30
- Hassan, M.K., Afify, M.A. and Aly, M.M. (2004) Genetic resistance of Egyptian chickens to infectious bursal disease and Newcastle disease. *Tropical Animal Health and Production*, **36**, 1–9
- Hassel, D.M., Rakestraw, P.C., Gardner, I.A., Spier, S.J. and Snyder, J.R. (2004) Dietary risk factors and colonic pH and mineral concentrations in horses with enterolithiasis. *Journal of Veterinary Internal Medicine*, **18**, 346–349
- Hässig, M. and Gottstein, B. (2002) Epidemiological investigations of abortions due to *Neospora caninum* on Swiss dairy farms. *Veterinary Record*, **150**, 538–542
- Hastings, B.E., Kenny, D., Lowenstine, L.J. and Foster, J.W. (1991) Mountain gorillas and measles: ontogeny of a wildlife vaccination program. In: Proceedings of the American Association of Zoo Veterinarians, Calgary, 28 September–3 October 1991. Ed. Junge, R.E., pp. 198–207
- Hathaway, S.C. (1981) Leptospirosis in New Zealand: an ecological view. *New Zealand Veterinary Journal*, **29**, 109–112
- Hawkins, E.C., Basseches, J., Berry, C.R., Stebbins, M.E. and Ferris, K.K. (2003) Demographic, clinical, and radiographic features of bronchiectasis in dogs: 316 cases (1988–2000). *Journal of the American Veterinary Medical Association*, **223**, 1628–1635
- Hawkins, J.F. and Tulleners, E.P. (1994) Epiglottitis in horses: 20 cases (1988–1993). *Journal of the American Veterinary Medical Association*, **205**, 1577–1580
- Hay, S.I., Randolph, S.E. and Rogers, D.J. (2000) Remote sensing and geographical information systems in epidemiology. *Advances in Parasitology*, **47**, 1–351
- Hayashidani, H., Omi, Y., Ogawa, M. and Fukutomi, K. (1988) Epidemiological studies on the expectation of life for dogs computed from animal cemetery records. *Japanese Journal of Veterinary Science*, **50**, 1003–1008
- Hayashidani, H., Omi, Y., Ogawa, M. and Fukutomi, Y. (1989) Epidemiological studies on the expectation of life for cats computed from animal cemetery records. *Japanese Journal of Veterinary Science*, **51**, 905–908
- Hayes, A.G., Boudrieau, R.J. and Hungerford, L.L. (1994) Frequency and distribution of medial and lateral patellar subluxation in dogs: 124 cases (1982–1992). *Journal of the American Veterinary Medical Association*, **205**, 716–720
- Hayes, H.M. (1974a) Congenital umbilical and inguinal hernias in cattle, horses, swine, dogs and cats: risk by breed and sex among hospital patients. *American Journal of Veterinary Research*, **35**, 839–842
- Hayes, H.M. (1974b) Ectopic ureter in dogs: epidemiologic features. *Teratology*, **10**, 129–132
- Hayes, H.M. (1975) An hypothesis for the aetiology of canine chemoreceptor system neoplasms, based upon an epidemiological study of 73 cases among hospital patients. *Journal of Small Animal Practice*, **16**, 337–343



- Hayes, H.M. (1976) Canine bladder cancer: epidemiologic features. *American Journal of Epidemiology*, **104**, 673–677
- Hayes, H.M. (1984) Breed association of canine ectopic ureter: a study of 217 female cases. *Journal of Small Animal Practice*, **25**, 501–504
- Hayes, H.M. (1986) Epidemiological features of 5009 cases of equine cryptorchism. *Equine Veterinary Journal*, **18**, 467–471
- Hayes, H.M. and Fraumeni, J.F. (1974) Chemodectomas in dogs: epidemiologic comparisons with man. *Journal of the National Cancer Institute*, **52**, 1455–1458
- Hayes, H.M. and Fraumeni, J.F. (1975) Canine thyroid neoplasms: epidemiologic features. *Journal of the National Cancer Institute*, **55**, 931–934
- Hayes, H.M. and Fraumeni, J.F. (1977) Epidemiological features of canine renal neoplasms. *Cancer Research*, **37**, 2553–2556
- Hayes, H.M. and Pendergrass, T.W. (1976) Canine testicular tumours: epidemiologic features of 410 dogs. *International Journal of Cancer*, **18**, 482–487
- Hayes, H.M. and Priester, W.A. (1973) Feline infectious anaemia: risk by age, sex and breed; prior disease; seasonal occurrence; mortality. *Journal of Small Animal Practice*, **14**, 797–804
- Hayes, H.M. and Wilson, G.P. (1986) Hospital incidence of hypospadias in dogs in North America. *Veterinary Record*, **118**, 605–606
- Hayes, H.M., Priester, W.A. and Pendergrass, T.W. (1975) Occurrence of nervous-tissue tumours in cattle, horses, cats and dogs. *International Journal of Cancer*, **15**, 39–47
- Hayes, H.M., Selby, L.A., Wilson, G.P. and Hohn, R.B. (1979) Epidemiologic observations on canine elbow disease (emphasis on dysplasia). *Journal of the American Animal Hospitals Association*, **15**, 449–453
- Hayes, H.M., Hoover, R. and Tarone, R.E. (1981) Bladder cancer in pet dogs: a sentinel for environmental cancer? *American Journal of Epidemiology*, **114**, 229–233
- Hayes, H.M., Wilson, G.P. and Fraumeni, J.F. (1982) Carcinoma of the nasal cavity and paranasal sinuses in dogs: descriptive epidemiology. *Cornell Veterinarian*, **72**, 168–179
- Hayes, H.M., Wilson, G.P., Pendergrass, T.W. and Cox, V.S. (1985) Canine cryptorchism and subsequent testicular neoplasia: case-control study with epidemiologic update. *Teratology*, **32**, 51–56
- Haygarth, J. (1800) *Of the Imagination, as a Cause and as a Cure of Disorders of the Body; exemplified by Fictitious Tractors, and Epidemical Convulsions*. R. Cruttwell, Bath
- Heady, E.O. and Dillon, J.L. (1961) *Agricultural Production Functions*. Iowa State University Press, Ames
- Heath, T.J. (1998) Longitudinal study of career plans and directions of veterinary students and recent graduates during the first five years after graduation. *Australian Veterinary Journal*, **76**, 181–186
- Hedhammar, Å., Egenvall, A., Olson, P., Sallander, M., Uddman, U. and Bonnet, B. (1999) Hund i Sverige. Dogs in Sweden. *Svensk Veterinärtidning*, **51**, 355–362 (in Swedish)
- Hege, R., Zimmermann, W., Scheidegger, R. and Stärk, K.D.C. (2002) Incidence of reinfections with *Mycoplasma hyopneumoniae* and *Actinobacillus pleuropneumoniae* in pig farms located in respiratory-disease-free regions of Switzerland. *Acta Veterinaria Scandinavica*, **43**, 145–156
- Heier, B.T. and Jarp, J. (2000) Risk factors for Marek's disease and mortality in White Leghorns in Norway. *Preventive Veterinary Medicine*, **44**, 153–165
- Heier, B.T., Høgåsen, H.R. and Jarp, J. (2002) Factors associated with mortality in Norwegian broiler flocks. *Preventive Veterinary Medicine*, **53**, 147–158
- Helle, O. (1971) The effect on sheep parasites of grazing in alternate years by sheep and cattle. A comparison with set-stocking, and the use of anthelmintics with these grazing arrangements. *Acta Veterinaria Scandinavica*, Suppl. 33, 1–59
- Henderson, D.A. (1998) Bioterrorism as a public health threat. *Emerging Infectious Diseases*, **4**, 488–492
- Henderson, R.J. (1969) The outbreak of foot and mouth disease in Worcestershire. An epidemiological study: with special reference to spread of the disease by wind-carriage of the virus. *Journal of Hygiene, Cambridge*, **67**, 21–33
- Henderson, W.M. (1982) Priorities for research. In: *The Control of Infectious Diseases in Farm Animals*. British Veterinary Association Trust Project on the future of animal health control, London, pp. 50–55
- Hendrick, M., Shofer, S.S., Goldschmidt, M.H., Haviland, J.C., Schelling, S.H., Engler, S.J. and Gliatto, J.M. (1994) Comparison of fibrosarcomas that developed at vaccination sites and at nonvaccination sites in cats: 239 cases (1991–1992). *Journal of the American Veterinary Medical Association*, **205**, 1425–1429
- Heng, N.H. and Wilson, D.W. (1993) Risk assessment on the importation of milk and milk products (excluding cheese) from countries not free from foot and mouth disease. *Revue Scientifique et Technique, Office International des Epizooties*, **12**, 1135–1146
- Henneke, D.R., Potter, G.D., Kreider, J.L. and Yeates, B.F. (1983) Relationship between condition score, physical measurement, and body fat percentage in mares. *Equine Veterinary Journal*, **15**, 371–372
- Henzler, D.J., Kradel, D.C. and Sischo, W.M. (1998) Management and environmental risk factors for *Salmonella enteritidis* contamination of eggs. *American Journal of Veterinary Research*, **59**, 824–829
- Herbert, W.J. (1970) *Veterinary Immunology*. Blackwell Scientific Publications, Oxford
- Herd, R., Strong, L. and Wardhaugh, K. (Eds) (1993) Environmental impact of avermectin usage in livestock. *Veterinary Parasitology*, **48**, 1–340
- Herløv, L. and Vedel, T. (1992) An information system for pig producers and advisory service. Proceedings of EAEE Satellite symposium on pig management information systems, 12 September 1992, pp. 17–23; 43rd Annual Meeting of the European Association of Animal Production. Madrid, 13–17 September 1992
- Herrmann, R., Utz, J., Rosenberger, E., Doll, K. and Distl, O. (2001) Risk factors for congenital umbilical hernia in German Fleckvieh. *The Veterinary Journal*, **162**, 233–240
- Hess, R.S., Kass, P.H., Shofer, F.S., Van Winkle, T.J. and Washabau, R.J. (1999) Evaluation of risk factors for fatal acute pancreatitis in dogs. *Journal of the American Veterinary Medical Association*, **214**, 46–51
- Heuer, C., Nothelle, N. and Bode, E. (1991) Clinical disease and fertility associated with low phosphorus supply in water buffaloes. In: Proceedings of the Sixth International

- Symposium on Veterinary Epidemiology and Economics, Ottawa, 12–16 August 1991. Ed. Martin, S.W., pp. 491–493
- Heussner, J.C., Flowers, A.I., Williams, J.D. and Silvy, N.J. (1978) Estimating dog and cat populations in an urban area. *Animal Regulation Studies*, **1**, 203–212
- Hide, G. (2003) The origins of sleeping sickness epidemics. *Biologist*, **50**, 268–272
- Hide, G., Tait, A., Maudlin, I. and Welburn, S.C. (1996) The origins, dynamics and generation of *Trypanosoma brucei rhodesiense* epidemics in East Africa. *Parasitology Today*, **12**, 50–55
- Higgs, A.R.B., Norris, R.T. and Richards, R.B. (1991) Season, age and adiposity influence death rates in sheep exported by sea. *Australian Journal of Agricultural Research*, **42**, 205–214
- Hill, A.B. (1965) The environment and disease: association or causation? *Proceedings of the Royal Society of Medicine*, **58**, 295–300
- Hill, I.D. (1987) 95% confidence limits for the median. *Journal of Statistics and Computer Simulation*, **28**, 80–81
- Hill, R.B. and Cambournac, F.C.D. (1941) Intermittent irrigation in rice cultivation and its effect on yield, water consumption and *Anopheles* production. *American Journal of Tropical Medicine and Hygiene*, **21**, 123–144
- Hill, T., Carmichael, D., Maylin, G. and Krook, L. (1986) Track condition and racing injuries in thoroughbred horses. *Cornell Veterinarian*, **76**, 361–379
- Hills, M. and Armitage, P. (1979) The two-period cross-over clinical trial. *British Journal of Clinical Pharmacology*, **8**, 7–20
- Hillyer, M.H., Taylor, F.G.R. and French, N.P. (2001) A cross-sectional study of colic in horses on Thoroughbred training premises in the British Isles in 1997. *Equine Veterinary Journal*, **33**, 380–385
- Hillyer, M.H., Taylor, F.G.R., Proudman, C.J., Edwards, G.B., Smith, J.E. and French, N.P. (2002) Case control study to identify risk factors for simple colonic obstruction and distension colic in horses. *Equine Veterinary Journal*, **34**, 455–463
- Himsworth, H. (1970) *The Development and Organisation of Scientific Knowledge*. William Heinemann Medical Books, London
- Hindmarsh, F., Fraser, J. and Scott, K. (1989) Efficacy of a multivalent *Bacteroides nodosus* vaccine against foot rot in sheep in Britain. *Veterinary Record*, **125**, 128–130
- Hindson, J. (1982) Sheep health schemes. *In Practice*, **4**, 53–58
- Hindson, J. and Winter, A. (1998) A 'whole flock' approach to disease control. *In Practice*, **20**, 64–71
- Hird, D.W. and Christiansen, K.H. (1991) California national animal health monitoring system for meat turkey flocks. In: *Proceedings of the 6th International Symposium on Veterinary Epidemiology and Economics*, Ottawa, 12–16 August 1991. Ed. Martin, S.W., pp. 504–506
- Hird, D.W., Pappaioanou, M. and Smith, B.P. (1984) Case-control study of risk factors associated with isolation of *Salmonella saintpaul* in hospitalized horses. *American Journal of Epidemiology*, **120**, 852–864
- Hird, D.W., Casebolt, D.B., Carter, J.D., Pappaioanou, M. and Hjerpe, C.A. (1986) Risk factors for salmonellosis in hospitalized horses. *Journal of the American Veterinary Medical Association*, **188**, 173–177
- Hird, D.W., Carpenter, T.E., Snipes, K.P., Hirsh, D.C. and McCapes (1991) Case-control study of fowl cholera outbreaks in meat turkeys in California from August 1985 through July 1986. *American Journal of Veterinary Research*, **52**, 212–216
- Hirsh, D.C. and Zee, Y.C. (Eds) (1999) *Veterinary Microbiology*. Blackwell Science, Malden
- Hirst, P.H. (1965) Liberal education and the nature of knowledge. In: *Philosophical Analysis and Education*. Ed. Archambault, R.D., pp. 113–138. Routledge and Kegan Paul, London
- HMSO (1954) *Mortality and Morbidity during the London fog of December 1952*. Reports on Public Health and Medical Subjects, No. 95. Her Majesty's Stationery Office, London
- HMSO (1958) *1951 Occupational Mortality, Part II, Vol. 2*. Registrar General's Decennial Supplement, 1958. Her Majesty's Stationery Office, London
- HMSO (1968) *A Century of Agricultural Statistics, Great Britain, 1866–1966*. Ministry of Agriculture, Fisheries and Food; Department of Agriculture and Fisheries for Scotland. Her Majesty's Stationery Office, London
- HMSO (1969) *Report of the Committee of Enquiry on Foot-and-Mouth Disease 1968*. 2 vols. Her Majesty's Stationery Office, London
- HMSO (1982) *Agricultural Statistics, United Kingdom 1980 and 1981*. Ministry of Agriculture, Fisheries and Food; Department of Agriculture and Fisheries for Scotland; Department of Agriculture for Northern Ireland; Welsh Agricultural Department. Her Majesty's Stationery Office, London
- HMSO (1991) *Agricultural Statistics, United Kingdom 1989*. Ministry of Agriculture, Fisheries and Food; Department of Agriculture and Fisheries for Scotland; Department of Agriculture for Northern Ireland; Welsh Agricultural Department. Her Majesty's Stationery Office, London
- HMSO (1998) *The Digest of Agricultural Statistics, United Kingdom 1997*. Ministry of Agriculture, Fisheries and Food; The Scottish Office Agriculture, Environment and Fisheries Department; Department of Agriculture for Northern Ireland; Welsh Office. The Stationery Office, London
- HMSO (2004) *The Horse Passports (England) Order, Statutory Instrument 2004, Number 1397*. Her Majesty's Stationery Office, London
- Hoet, A.E., Smiley, J., Thomas, C., Nielsen, P.R., Wittum, T.E. and Saif, L.J. (2003) Association of enteric shedding of bovine torovirus (Breda virus) and other enteropathogens with diarrhea in veal calves. *American Journal of Veterinary Research*, **64**, 485–490
- Höffle, U., Blanco, J.M. and Kaleta, E.F. (2002) Seroprevalence of avian paramyxovirus 1, 2, and 3 in captive and free-living birds of prey in Spain (preliminary results). In: *The Domestic Animal/Wildlife Interface: Issues for Disease Control, Conservation, Sustainable Food Production, and Emerging Diseases*. *Annals of the New York Academy of Sciences*, Vol. 969. Eds Gibbs, E.P.J. and Bokma, B.H., pp. 213–216. The New York Academy of Sciences, New York
- Hoffman, Th. and Gaengler, P. (1996) Epidemiology of periodontal disease in poodles. *Journal of Small Animal Practice*, **37**, 309–316
- Hogenesch, H., Azcona-Olivera, J., Scott-Moncreiff, C., Snyder, P.W. and Glickman, L.T. (1999) Vaccine-induced

- autoimmunity in the dog. *Advances in Veterinary Medicine*, **41**, 733–744
- Hogeveen, H., Noordhuizen-Stassen, E.N., Nielen, M. and Brand, A. (1993) Use of knowledge representation methodologies to diagnose mastitis. In: Society for Veterinary Epidemiology and Preventive Medicine, Proceedings, Exeter, 31 March–2 April 1993. Ed. Thrusfield, M.V., pp. 225–235
- Holden, S., Ashley, S. and Bazeley, P. (1996) *Improving the Delivery of Animal Health Services in Developing Countries: A Literature Review*. Livestock in Development, Crewkerne
- Holland, W. (1984) A standard advisory system for lowland sheep flocks. In: Society for Veterinary Epidemiology and Preventive Medicine, Proceedings, Edinburgh, 10–11 July 1984. Ed. Thrusfield, M.V., pp. 39–52
- Holling, C.S. (1966) The strategy of building models of complex ecological systems. In: *Systems Analysis and Ecology*. Ed. Watt, K.E.F., pp. 195–214. Academic Press, New York
- Holling, C.S. (Ed.) (1978) *Adaptive Environmental Assessment and Management*. John Wiley, Chichester
- Holmes, G. (1996) *Renaissance*. Weidenfeld and Nicolson, London
- Holmes, J.C. (1973) Site segregation by parasitic helminths: interspecific interaction, site segregation, and their importance to the development of helminth communities. *Canadian Journal of Zoology*, **51**, 333–347
- Holst, P.A., Kromhout, D. and Brand, R. (1988) For debate: pet birds as an independent risk factor for lung cancer. *British Medical Journal*, **297**, 1319–1321
- Holt, P.E. and Thrusfield, M.V. (1993) Association in bitches between breed, size, neutering and docking, and acquired urinary incontinence due to incompetence of the urethral sphincter mechanism. *Veterinary Record*, **133**, 177–180
- Holt, P.E., Thrusfield, M.V. and Hotson-Moore, A. (2000) Breed predisposition to utereral ectopia in bitches in the UK. *Veterinary Record*, **146**, 561
- Holton, L., Reid, J., Scott, E.M., Pawson, P. and Nolan, A. (2001) Development of a behaviour-based scale to measure acute pain in dogs. *Veterinary Record*, **148**, 525–531
- Holton, L.L., Scott, E.M., Nolan, A., Reid, J., Welsh, E. and Flaherty, D. (1998) Comparison of three methods used for assessment of pain in dogs. *Journal of the American Veterinary Medical Association*, **212**, 61–66
- Honhold, N., Taylor, N.M., Mansley, L.M. and Paterson, A.D. (2004) Relationship of speed of slaughter on infected premises and intensity of culling of other premises to the rate of spread of the foot-and-mouth disease in Great Britain, 2001. *Veterinary Record*, **155**, 287–294
- Honhold, N., Taylor, N.M., Wingfield, A., Einshoj, P., Middlemiss, C., Eppink, L., Wroth, R. and Mansley, L.M. (2004a) Evaluation of the application of veterinary judgement in the pre-emptive cull of contiguous premises during the epidemic of foot-and-mouth disease in Cumbria in 2001. *Veterinary Record*, **155**, 349–355
- Hoogstraal, H. (1966) Ticks in relation to human diseases caused by viruses. *Annual Review of Entomology*, **11**, 261–308
- Hoogstraal, H. (1979) The epidemiology of tick-borne Crimean-Congo haemorrhagic fever in Asia, Europe and Africa. *Journal of Medical Entomology*, **15**, 307–417
- Hoover, R. and Cole, P. (1973) Temporal aspects of occupational bladder carcinogenesis. *New England Journal of Medicine*, **288**, 1040–1043
- Hope-Cawdery, M.J., Gettinby, G. and Grainger, J.N. (1978) Mathematical models for predicting the prevalence of liver-fluke disease and its control from biological and meteorological data. In: *Weather and Parasitic Animal Disease*. Ed. Gibson, T.E., pp. 21–38. World Meteorological Organization Technical Note No. 159
- Hopp, P., Ulvund, M.J. and Jarp, J. (2001) A case-control study on scrapie in Norwegian sheep flocks. *Preventive Veterinary Medicine*, **51**, 183–198
- Horrobin, D.F. (Ed.) (1990) *Omega-6 Essential Fatty Acids: Pathophysiology and Roles in Clinical Medicine*. Alan R. Liss, New York
- Horse and Hound* (1992) *The Horse and Hound Equestrian Survey, October 1992*. IPC Magazines Ltd, London
- Horst, H.S., Huirne, R.B.M. and Dijkhuizen, A.A. (1997) Risks and economic consequences of introducing classical swine fever into the Netherlands by feeding swill to swine. *Revue Scientifique et Technique, Office International des Epizooties*, **16**, 207–214
- Horwitz, R.I. (1987) Complexity and contradiction in clinical trial research. *American Journal of Medicine*, **82**, 498–510
- Hosie, M.J., Robertson, C. and Jarrett, O. (1989) Prevalence of feline leukaemia virus and antibodies to feline immunodeficiency virus in cats in the United Kingdom. *Veterinary Record*, **128**, 293–297
- Hoskins, J.D., Eades, S.C. and Gill, M.S. (2002) Preventive health programs. In: *Clinical Textbook for Veterinary Technicians*, 5th edn. Eds McCurnin, D.M. and Bassert, J.M., pp. 263–301. W.B. Saunders, Philadelphia
- Hosmer, D.W. and Lemeshow, S. (1992) Confidence interval estimation of interaction. *Epidemiology*, **3**, 452–456
- Hosmer, D.W. and Lemeshow, S. (2000) *Applied Logistic Regression*, 2nd edn. John Wiley, New York
- Houe, H. and Meyling, A. (1991) Prevalence of bovine virus diarrhoea (BVD) in 19 Danish dairy herds and estimation of rate of infection in early pregnancy. *Preventive Veterinary Medicine*, **11**, 9–16
- Houe, H., Pedersen, K.M. and Meyling, A. (1993) The effect of bovine virus diarrhoea virus infection on conception rate. *Preventive Veterinary Medicine*, **15**, 117–123.
- Houe, H., Baker, J.C., Maes, R.K., Lloyd, J.W. and Enevoldsen, C. (1995) Comparison of the prevalence and incidence of infection with bovine virus diarrhoea virus (BVDV) in Denmark and Michigan and association with possible risk factors. *Acta Veterinaria Scandinavica*, **36**, 521–531
- Hourigan, J.L. and Klingsporn, A.L. (1975) Epizootiology of bluetongue: the situation in the United States of America. *Australian Veterinary Journal*, **51**, 203–208
- House, J.A. (1978) The economic impact of rotaviruses and other neonatal disease agents of animals. *Journal of the American Veterinary Medical Association*, **173**, 574–576
- House, J.K., Mainar-Jaime, R.C., Smith, B.P., House, A.M. and Kamiya, D.Y. (1999) Risk factors for nosocomial *Salmonella* infection among hospitalized horses. *Journal of the American Veterinary Medical Association*, **214**, 1511–1516

- Houston, R. (2001) A computerised database system for bovine traceability. *Revue Scientifique et Technique, Office International des Epizooties*, **20**, 652–661
- Houston, D.M., Ribble, C.S. and Head, L.L. (1996) Risk factors associated with parvovirus enteritis in dogs: 283 cases (1982–1991). *Journal of the American Veterinary Medical Association*, **208**, 542–546
- Houwens, D.J. (1989) Importance of ewe/lamb relationship and breed in the epidemiology of maedi-visna virus infections. *Research in Veterinary Science*, **46**, 5–8
- Howard, E.B. and Nielsen, S.W. (1965) Neoplasia of the Boxer dog. *American Journal of Veterinary Research*, **26**, 1121–1131
- Howe, K.S. (1985) An economist's view of animal disease. In: Society for Veterinary Epidemiology and Preventive Medicine, Proceedings, Reading, 27–29 March 1985. Ed. Thrusfield, M.V., pp. 122–129
- Howe, K.S. (1989) An economist's view of veterinary epidemiology. In: Society for Veterinary Epidemiology and Preventive Medicine, Proceedings, Exeter, 12–14 April 1989. Ed. Thrusfield, M.V., pp. 60–71
- Howe, K.S. (1992) Epidemiologists' views of economics – an economist's reply. In: Society for Veterinary Epidemiology and Preventive Medicine, Denary Proceedings, Edinburgh, 1–3 April, 1992. Ed. Thrusfield, M.V., pp. 157–167
- Howe, K.S. and Christiansen, K. (2004) The state of animal health economics: a review. In: Society for Veterinary Epidemiology and Preventive Medicine, Proceedings, Martigny, 24–26 March 2004. Eds Reid, S.W.J., Menzies, F.D. and Russell, A.M., pp. 153–165
- Hoyningen-Huene, P. (1993) *Reconstructing Scientific Revolutions: Thomas S. Kuhn's Philosophy of Science*. University of Chicago Press, Chicago
- Hubbert, W.T. and Hermann, G.J. (1970) A winter epizootic of infectious bovine keratoconjunctivitis. *Journal of the American Veterinary Medical Association*, **157**, 452–454
- Hudak, D.G. (1994) Adjusting triangular distributions for judgemental bias. *Risk Analysis*, **14**, 1025–1031
- Hudson, L. and Hay, F.C. (1989) *Practical Immunology*, 3rd edn. Blackwell Scientific Publications, Oxford
- Hudson, P.J. (1986) *Red Grouse: the Biology and Management of a Wild Gamebird*. The Game Conservancy Trust, Fordingbridge
- Huebner, R.J. (1957) The virologist's dilemma. *Annals of the New York Academy of Sciences*, **67**, 430–445
- Hueston, W.D. (2001) Science, politics and animal health policy: epidemiology in action. In: Society for Veterinary Epidemiology and Preventive Medicine, Proceedings, Noordwijkerhout, 28–30 March 2001. Eds Menzies, F.D. and Reid, S.W.J., pp. xi–xix
- Hueston, W.D. and Walker, K.D. (1993) Macroepidemiological contributions to quantitative risk assessment. *Revue Scientifique et Technique, Office International des Epizooties*, **12**, 1197–1201
- Hueston, W.D., Heider, L.E., Harvey, W.R. and Smith, K.L. (1987) The use of high somatic cell count prevalence in epidemiologic investigations of mastitis control practices. *Preventive Veterinary Medicine*, **4**, 447–461
- Hueston, W.D., Heider, L.E., Harvey, W.R. and Smith, K.L. (1990) Determinants of high somatic cell count prevalence in dairy herds practicing teat dipping and dry cow therapy and with no evidence of *Streptococcus agalactiae* on repeated bulk tank milk examination. *Preventive Veterinary Medicine*, **9**, 131–142
- Hughes, D.E., Pugh, G.W. and McDonald, T.J. (1965) Ultraviolet radiation and *Moraxella bovis* in the etiology of bovine infectious keratoconjunctivitis. *American Journal of Veterinary Research*, **26**, 1331–1338
- Hughes, K.L., Slater, M.R., Geller, S., Burkholder, W.J. and Fitzgerald, C. (2002) Diet and lifestyle variables as risk factors for chronic renal failure in pet cats. *Preventive Veterinary Medicine*, **55**, 1–15
- Hugh-Jones, M., Wilson, K. and Scheffler, S. (1996) GIS mapping of expected *Vibrio vulnificus* levels in Southern Louisiana oysterbays. In: Proceedings of the Society for Veterinary Epidemiology and Preventive Medicine, Glasgow, 27–29 March 1996. Eds Thrusfield, M.V. and Goodall, E.A., pp. 169–177
- Hugh-Jones, M.E. (1972) Epidemiological studies on the 1967/68 foot and mouth disease epidemic: attack rates and cattle density. *Research in Veterinary Science*, **13**, 411–417
- Hugh-Jones, M.E. (1975) Some pragmatic aspects of animal disease monitoring. In: *Animal Disease Monitoring*. Eds Ingram, D.G., Mitchell, W.F. and Martin S.W., pp. 220–36. Charles C. Thomas, Springfield
- Hugh-Jones, M.E. (1983) Conclusions for the symposium and lessons for the future. In: Proceedings of the Third International Symposium on Veterinary Epidemiology and Economics, Arlington, Virginia, 6–10 September 1982, pp. 650–654. Veterinary Medical Publishing Company, Edwardsville
- Hugh-Jones, M.E. (1986) Utilization of a working serum bank. In: Proceedings of the Fourth International Symposium on Veterinary Epidemiology and Economics, Singapore, 18–22 November 1985, pp. 179–182. Singapore Veterinary Association, Singapore
- Hugh-Jones, M.E. (1989) Applications of remote sensing to the identification of the habitats of parasites and disease vectors. *Parasitology Today*, **5**, 244–251
- Hugh-Jones, M.E. (1991a) Remote sensing and geographic information systems, epidemiology and Igor Piskun's rule. In: Proceedings of the 6th International Symposium on Veterinary Epidemiology and Economics, Ottawa, 12–16 August 1991. Ed. Martin, S.W., pp. 541–543
- Hugh-Jones, M.E. (1991b) Satellite imaging as a technique for obtaining disease-related data. *Revue Scientifique et Technique, Office International des Epizooties*, **10**, 197–204
- Hugh-Jones, M.E. (1991c) The remote recognition of tick habitats. *Journal of Agricultural Entomology*, **8**, 309–315
- Hugh-Jones, M.E. and Hubbert, W. (1988) Seroconversion rates to bovine leucosis virus, blue tongue virus, *Leptospira hardjo*, and *Anaplasma marginale* infections in a random series of Louisiana beef cattle. *Acta Veterinaria Scandinavica*, Suppl. 84, 107–109
- Hugh-Jones, M.E. and O'Neil, P. (1986) The epidemiological uses of remote sensing and satellites. In: Proceedings of the 4th International Conference on Veterinary Epidemiology and Economics, Singapore, 18–22 November 1985, pp. 113–118. Singapore Veterinary Association
- Hugh-Jones, M.E. and Wright, P.B. (1970) Studies on the 1967–68 foot-and-mouth disease epidemic. The relation of

- weather to spread of disease. *Journal of Hygiene, Cambridge*, **68**, 253–271
- Hugh-Jones, M.E., Ivory, D.W., Loosmore, R.M. and Gibbins, J. (1969) Veterinary Investigation Diagnosis Analysis: an information recording and retrieval system for veterinary diagnostic laboratories in the Ministry of Agriculture, Fisheries and Food. *Veterinary Record*, **84**, 304–307
- Hugh-Jones, M.E., Parkin, R.S. and Whitney, J.C. (1975) The cost of premature death in young rabbits. *Veterinary Record*, **96**, 353–356
- Hugh-Jones, M.E., Barre, N., Nelson, G., Wehnes, K., Warner, J., Garvin, J. and Garris, G. (1992) Landstat-TM identification of *Amblyomma variegatum* (Acari: Ixodidae) habitats in Guadeloupe. *Remote Sensing of Environment*, **40**, 43–55
- Hugoson, G. and Wallén, C. (Eds) (2000) Proceedings of the Symposium on Antibiotic Resistance with Emphasis on Animal–Human Transfer, Falkenberg, Sweden, 13–14 September 1999. *Acta Veterinaria Scandinavica*, Suppl. 93, 1–164
- Huhn, J.E. and Baumann, M.P.O. (1996) The situation of animal health care in Sub-Saharan Africa: a compilation of constraints and required improvements of animal health systems, research and education. In: *Primary Animal Health Activities in Southern Africa*, Proceedings of an International Seminar held in Mzuzu, Malawi, 26 February–8 March 1996. Eds Zimmerman, W., Pfeiffer, D.U. and Zessin, K.-H., pp. 16–26. Deutsche Stiftung für internationale Entwicklung (DSE) and Zentralstelle für Ernährung Landwirtschaft (ZEL), Feldafing
- Hui, S.L. and Zhou, X.H. (1998) Evaluation of diagnostic tests without gold standards. *Statistics in Medicine*, **7**, 354–370
- Huirne, R.B.M. and Dijkhuizen, A.A. (1994) CHES: a decision support system to analyze individual sow-herd performance. In: *Society for Veterinary Epidemiology and Preventive Medicine Proceedings*, Belfast, 13–15 April 1994. Ed. Thrusfield, M.V., pp. 136–145
- Huirne, R.B.M., Dijkhuizen, A.A., Pijpers, A., Verheijden, J.H.M. and van Gulick, P. (1991) An economic expert system on the personal computer to support sow replacement strategies. *Preventive Veterinary Medicine*, **11**, 79–93
- Huirne, R.B.M., Dijkhuizen, A.A., Renkema, J.A. and Van Beek, P. (1992) Computerized analysis of individual sow-herd performance. *American Journal of Agricultural Economics*, **74**, 388–399
- Hulka, B.S., Wilcosky, T.C. and Griffith, J.D. (Eds) (1990) *Biological Markers in Epidemiology*. Oxford University Press, New York
- Hultén, F., Lundeheim, N., Dalin, A.-M. and Einarson, S. (1995) A field study on group housing of lactating sows with special reference to sow health at weaning. *Acta Veterinaria Scandinavica*, **36**, 201–212
- Hultgren, J. (2002) Foot/leg and udder health in relation to housing changes in Swedish dairy herds. *Preventive Veterinary Medicine*, **53**, 167–189
- Hultgren, J. and Bergsten, C. (2001) Effects of a rubber-slatted flooring system on cleanliness and foot health in tied dairy cows. *Preventive Veterinary Medicine*, **52**, 75–89
- Hultgren, J., Manske, T. and Bergsten, C. (2004) Associations of sole ulcer at claw trimming with reproductive performance, udder health, milk yield, and culling in Swedish dairy cattle. *Preventive Veterinary Medicine*, **62**, 233–251
- Humbert, F., Carramiñana, J.J., Lalande, F. and Salvat, G. (1997) Bacteriological monitoring of *Salmonella enteritidis* carrier birds after decontaminating using competitive exclusion and movement of birds. *Veterinary Record*, **141**, 297–299
- Hume, D. (1739–40) *A Treatise of Human Nature: being an attempt to introduce the experimental method of reasoning into moral subjects*. 3 vols. Printed for John Noon (vols 1 and 2) and Thomas Longman (vol. 3), London
- Humphry, R.W., Cameron, A. and Gunn, G.J. (2004) A practical approach to calculate sample size for herd prevalence surveys. *Preventive Veterinary Medicine*, **65**, 173–188
- Hunter, J.E. and Schmidt, F.L. (1989) *Methods of Meta-Analysis: Correcting Error and Bias in Research Findings*. Sage Publications, Beverly Hills
- Hunter, L., Miller, J.K. and Poxton, I.R. (1999) The association of *Clostridium botulinum* type C with equine grass sickness: a toxico-infection? *Equine Veterinary Journal*, **31**, 492–499
- Hunter, P.R. (2003) Climate change and waterborne and vector-borne disease. *Journal of Applied Microbiology*, **94**, 375–465
- Hurd, H.S. and Kaneene, J.B. (1993) The application of simulation models and systems analysis in epidemiology: a review. *Preventive Veterinary Medicine*, **15**, 81–99
- Hurnik, D. and Dohoo, I.R. (1991) Evaluation of management risk factors in swine respiratory disease. In: *Proceedings of the Sixth International Symposium on Veterinary Epidemiology and Economics*, Ottawa, 12–16 August 1991. Ed. Martin, S.W., pp. 412–415
- Hutchinson, S.E. (1996) *Nuer Dilemmas: Coping with Money, War and the State*. University of California Press, Berkeley
- Hutchison, J.M., Salman, M.D., Fowler, M.E., Zinkl, J.G. and Garry, F.B. (1991) Guidelines for the establishment of reference ranges in veterinary medicine. In: *Proceedings of the 6th International Symposium on Veterinary Epidemiology and Economics*, Ottawa, 12–16 August 1991. Ed. Martin, S.W., pp. 465–467.
- Hutton, C.T., Fox, L.K. and Hancock, D.D. (1991) Risk factors associated with herd-group milk somatic cell count and prevalence of coagulase-positive staphylococcal intramammary infections. *Preventive Veterinary Medicine*, **11**, 25–35
- Hutton, N.E. (1969) *Veterinary Medical Information Systems*. MSc Thesis, Iowa State University
- Hutton, N.E. and Halvorson, L.C. (1974) *A Nationwide System for Animal Health Surveillance*. National Academy of Sciences, Washington DC
- Hutton, N.E. and Seaton, V.A. (1966) Use of computers in veterinary public health activities. *Journal of the American Veterinary Medical Association*, **149**, 1681–1684
- Huzurbazar, S., Van Campen, H. and McLean, M.B. (2004) Sample size calculations for Bayesian prediction of bovine viral-diarrhoea-virus infection in beef herds. *Preventive Veterinary Medicine*, **62**, 217–232
- IAEA (1991) *The Sero-monitoring of Rinderpest throughout Africa. Phase One*. Proceedings of a Final Research Co-ordination

- Meeting of the FAO/IAEA/SIDA/OAU/BAR/PARC Co-ordinated Research Programme, Bingerville, Cote d'Ivoire, 19–23 November 1990. IAEA-TECDOC-623. International Atomic Energy Agency, Vienna
- IAEA (1998) *Towards Livestock Disease Diagnosis and Control in the 21st Century*. Proceedings of an international symposium on the diagnosis and control of livestock diseases using nuclear and related techniques jointly organized by the International Atomic Energy Agency and the Food and Agriculture Organization of the United Nations and held in Vienna, 7–11 April 1997. International Atomic Energy Agency, Vienna
- Ianovich, T.D., Bliznichenko, A.G., Zaburina, L.V., Mstibovskii, S.A., Berkovich, A.I. and Dushevin, I.P. (1957) Leptospirosis of the *canicola* type in one of the districts of Rostov-on-the-Don. *Journal of Microbiology, Epidemiology and Immunology*, **28**, 259–264
- IASP (1979) Pain terms: a list with definitions and notes on usage. *Pain*, **6**, 249–252
- Ingwersen, W. (2000) Electronic identification and retrieval systems. In: *Kirk's Current Veterinary Therapy XIII*. Ed. Bonagura, J.D., pp. 93–95. W.B. Saunders, Philadelphia
- InterAGRI (2004) InterHerd <http://www.interagri.org/E/IH/interherd.htm> (Accessed 7 October 2004)
- Irwin, D.A. (1996) *Against the Tide: An Intellectual History of Free Trade*. Princeton University Press, Princeton
- Isaacson, R.E., Moon, H.W. and Schneider, R.A. (1978) Distribution and virulence of *Escherichia coli* in the small intestines of calves with and without diarrhoea. *American Journal of Veterinary Research*, **39**, 1750–1755
- Ismail, M.O., Greenman, J., Morgan, K., Glover, M.G., Rees, A.S. and Scully, C. (1989) Periodontitis in sheep: a model for human periodontal disease. *Journal of Periodontology*, **60**, 279–284
- Ivey, E. and Morrissey, J. (1999) Ferrets: examination and preventive medicine. *The Veterinary Clinics of North America, Exotic Animal Practice*, **2**, 471–494
- Jack, J.M.D. (1961) The Sudan. In: *A History of the Overseas Veterinary Services, Part 1*, Ed. West, G.P., pp. 123–143. British Veterinary Association, London
- Jackson, G.H. and Baker, J.R. (1981) The occurrence of unthriftiness in piglets post-weaning. *The Pig Veterinary Society Proceedings*, **7**, 63–67
- Jacobs, R.M., Heeney, J.L., Godkin, M.A., Leslie, K.E., Taylor, J.A., Davies, C. and Valli, V.E.O. (1991) Production and related variables in bovine leukaemia virus-infected cows. *Veterinary Research Communications*, **15**, 463–474
- Jacobson, E.R. (1994) Causes of mortality and diseases in tortoises: a review. *Journal of Zoo and Wildlife Medicine*, **25**, 2–17
- Jacobson, E.R., Brown, M.B., Schummercher, I.M., Collins, B.R., Harris, R.K. and Klein, P.A. (1995) Mycoplasmosis and the desert tortoise (*Gopherus agassizii*) in Las Vegas Valley, Nevada. *Chelonian Conservation and Biology*, **1**, 279–284
- Jacobson, R. (2000) Principles of validation of diagnostic assays for infectious diseases. In: *Manual of Standards for Diagnostic Tests and Vaccines (2000)*. Office International des Epizooties, Paris. [http://www.oie.int/eng/normes/mmanual/A\\_00013.htm](http://www.oie.int/eng/normes/mmanual/A_00013.htm) (Accessed 7 October 2003)
- Jactel, B., Espinasse, J., Viso, M. and Valiergue, H. (1990) An epidemiological study of winter dysentery in fifteen herds in France. *Veterinary Research Communications*, **14**, 367–379
- Jaggy, A., Faissler, D., Gaillard, C., Srenk, P. and Graber, H. (1998) Genetic aspects of idiopathic epilepsy in Labrador retrievers. *Journal of Small Animal Practice*, **39**, 275–280
- Jakab, G.J. (1977) Pulmonary defense mechanisms and the interaction between viruses and bacteria in acute respiratory infections. *Bulletin Européen de Physiopathologie Respiratoire*, **13**, 119–135
- Jakobsen, M.B., Alban, L. and Nielsen, S.S. (2000) A cross-sectional study of paratuberculosis in 1155 Danish dairy cows. *Preventive Veterinary Medicine*, **46**, 15–27
- James, A.D. and Rushton, J. (2002) The economics of foot and mouth disease. *Revue Scientifique et Technique, Office International des Epizooties*, **21**, 637–644
- Janzen, D.H. (1971) Seed predation by animals. *Annual Review of Ecology and Systematics*, **2**, 465–492
- Jarrett, O. (1985) Update: feline leukaemia virus. *In Practice*, **7**, 125–126
- Jarrett, W.F.H. (1980) Bracken fern and papilloma virus in bovine alimentary cancer. *British Medical Bulletin*, **36**, 79–81
- Jarrett, W.F.H., Martin, W.B., Crighton, G.W., Dalton, R.G. and Stewart, M.F. (1964) Transmission experiments with leukaemia (lymphosarcoma). *Nature*, **202**, 566–567
- Jarvis, A. and Cockram, M.S. (1994) Effects of handling and transport on bruising of sheep sent directly from farms to slaughter. *Veterinary Record*, **135**, 523–527
- Jasper, D.E., Dellinger, J.D., Rollins, H. and Hakanson, H.D. (1979) Prevalence of mycoplasmal bovine mastitis in California. *American Journal of Veterinary Research*, **40**, 1043–1047
- Jeglum, K.A. (1982) The use of spontaneous feline neoplasms for studies of therapeutic agents. In: *Design of Models for Testing Cancer Therapeutic Agents*. Eds Figler, I.J. and White, R.J., pp. 193–205. Van Nostrand Reinhold, New York
- Jellum, E., Andersen, A., Lund-Larsen, P., Theodorsen, L. and Ørjasæter, H. (1995) Experiences of the Janus serum bank in Norway. *Environmental Health Perspectives*, **103**, Suppl. 3, 85–88
- Jenkins, S.R., Perry, B.D. and Winkler, W.G. (1988) Ecology and epidemiology of raccoon rabies. *Reviews of Infectious Diseases*, **10**, 5620–5636
- Jensen, A.M., Björkman, C., Kjeldsen, A.M., Wedderkopp, A., Willadsen, C., Ugglå, A. and Lind, P. (1999) Associations of *Neospora caninum* seropositivity with gestation number and pregnancy outcome in Danish dairy herds. *Preventive Veterinary Medicine*, **40**, 151–163
- Jepson, P.G.H. and Hinton, M.H. (1986) An inquiry into the causes of liver damage in lambs. *Veterinary Record*, **118**, 584–587
- Johnson, D. (1997) The triangular distribution as a proxy for the beta distribution in risk analysis. *Journal of the Royal Statistical Society, Series D*, **46**, 387–398
- Johnson, N.L. and Kotz, S. (1970) *Distributions in Statistics: Discrete Distributions*. Houghton Mifflin, Boston
- Johnson, R.E., Cameron, T.P. and Kinard, R. (1968a) Canine lymphoma as a potential model for experimental therapeutics. *Cancer Research*, **28**, 2562–2564
- Johnson, R.E., Cameron, T.P. and Kinard, R. (1968b) Total-body irradiation of canine lymphoma. *Radiation Research*, **36**, 629–632
- Johnson-Ifearulundu, Y. and Kaneene, J.B. (1999) Distribution and environmental risk factors for paratuberculosis

- in dairy cattle herds in Michigan. *American Journal of Veterinary Research*, **60**, 589–596
- Johnston, A.M. (2000) HACCP and farm production. In: *HACCP in the Meat Industry*. Ed. Brown, M., pp. 38–79. Woodhead Publishing, Abington
- Johnston, G.M. (1994) Epidemiological aspects of the confidential enquiry of perioperative equine fatalities (CEPEF) and some preliminary results. In: *Society for Veterinary Epidemiology and Preventive Medicine Proceedings*, Belfast, 13–15 April 1994. Ed. Thrusfield, M.V., pp. 174–184
- Johnston, P.I., Henry, N., De Boer, R. and Braidwood, J.C. (1992) Phenoxymethyl penicillin potassium as an in-feed medication for pigs with streptococcal meningitis. *Veterinary Record*, **130**, 138–139
- Jolley, J.L. (1968) *Data Study*. World University Library, Weidenfield and Nicolson, London
- Jolly, R.D. (2002) Mannosidosis in cattle and its control. *New Zealand Veterinary Journal*, **50**, Suppl., 90
- Jolly, R.D. and Townsley, R.J. (1980) Genetic screening programmes: an analysis of benefits and costs using the bovine mannosidosis scheme as a model. *New Zealand Veterinary Journal*, **28**, 3–6
- Jolly, R.D., Tse, C.A. and Greenway, R.M. (1973) Plasma  $\alpha$ -mannosidase activity as a means of detecting mannosidosis heterozygotes. *New Zealand Veterinary Journal*, **21**, 64–69
- Jolly, R.D., Dodds, W.J., Ruth, G.R. and Trauner, D.B. (1981) Screening for genetic diseases: principles and practice. *Advances in Veterinary Science and Comparative Medicine*, **25**, 245–275
- Jones, D. (2000) History and physical examination. In: *Saunders Manual of Small Animal Practice*, 2nd edn. Eds Birchard, S.J. and Sherding, R.G., pp. 1–11. W.B. Saunders, Philadelphia
- Jones, E.E. (1932) An encephalomyelitis in the chicken. *Science*, **76**, 331–332
- Jones, G.E. and Gilmour, J.S. (1983) Atypical pneumonia. In: *Diseases of Sheep*. Ed. Martin, W.B., pp. 17–23. Blackwell Science, Oxford
- Jones, R., Kelly, L., French, N., England, T., Livesey, C. and Wooldridge, M. (2004a) Quantitative estimates of the risk of new outbreaks of foot-and-mouth disease as a result of burning pyres. *Veterinary Record*, **154**, 161–165
- Jones, R., Kelly, L., England, T., MacMillan, A. and Wooldridge, M. (2004b) A quantitative risk assessment for the importation of brucellosis-infected breeding cattle into Great Britain from selected countries. *Preventive Veterinary Medicine*, **63**, 51–61
- Jones, R.D., Kelly, L., Fooks, A.R. and Wooldridge, M. (2002) *Quantitative Risk Assessment to Compare the Risk of Rabies entering Great Britain from North America via Quarantine and PETS*. <http://www.defra.gov.uk/animalh/quarantine/pets/safety/vla2002.PDF> (Accessed 19 April 2006)
- Jones, R.D., Kelly, L., Fooks, A.R. and Wooldridge, M. (2005) Quantitative risk assessment of rabies entering Great Britain from North America via cats and dogs. *Risk Analysis*, **25**, 533–542
- Jones, W.H.S. (translator) (1923) *Hippocrates*, Vol. 1. The Loeb Classical Library. William Heinemann, London
- Jordan, D. and McEwen, S.A. (1998) Herd-level test performance based on uncertain estimates of individual test performance, individual true prevalence and herd true prevalence. *Preventive Veterinary Medicine*, **36**, 187–209
- Jordan, D., McEwen, S.A., Lammerding, A.M., McNab, W.B. and Wilson, J.B. (1999) A simulation model for studying the role of pre-slaughter factors on the exposure of beef carcasses to human microbial hazards. *Preventive Veterinary Medicine*, **41**, 37–54
- Jorm, L.R. (1990) Strangles in horse studs: incidence, risk factors and effect of vaccination. *Australian Veterinary Journal*, **67**, 436–439
- Juarbe-Díaz, S.V., Houpt, K.A. and Kusunose, R. (1998) Prevalence and characteristics of foal rejection in Arabian mares. *Equine Veterinary Journal*, **30**, 424–428
- Jubb, K.V.F., Kennedy, P.A. and Palmer, N. (1993) *Pathology of Domestic Animals*, 4th edn. Academic Press, San Diego
- Julian, A.F. (1981) Tuberculosis in the possum (*Trichosurus vulpecula*). In: *Proceedings of the First Symposium on Marsupials in New Zealand*. Ed. Bell, B.D., pp. 163–174. Zoology Publications from Victoria University of Wellington No. 74. Victoria University, Wellington
- Julious, S.A. and Campbell, M.J. (1998) Sample size calculations for paired or matched ordinal data. *Statistics in Medicine*, **17**, 1635–1642
- Junwook Chi, J., VanLeeuwen, J.A., Weersink, A. and Keefe, G.P. (2002) Management factors related to seroprevalences to bovine viral diarrhoea virus, bovine leukosis virus, *Mycobacterium avium* subspecies *paratuberculosis*, and *Neospora caninum* in dairy herds in the Canadian Maritimes. *Preventive Veterinary Medicine*, **55**, 57–68
- Kaelin, W.G. (1999) Choosing anticancer drug targets in the postgenomic era. *Journal of Clinical Investigation*, **104**, 1503–1506
- Kagan, I.G. (1951) Aspects of the life history of *Neoleucochloridium problematicum* (Magath, 1902) new com. and *Leucochloridium cyanocittae* McIntosh, 1932 (Trematoda: Brachylaemidae). *Transactions of the American Microscopical Society*, **70**, 281–318
- Kahn, H.A. and Sempos, C.T. (1989) *Statistical Methods in Epidemiology*. Oxford University Press, New York
- Kahneman, D., Slovic, P. and Tversky, A. (Eds) (1982) *Judgement under Uncertainty: Heuristics and Biases*. Cambridge University Press, Cambridge
- Kaldhusdal, M. and Skjerve, E. (1996) Association between cereal contents in the diet and incidence of necrotic enteritis in broiler chickens in Norway. *Preventive Veterinary Medicine*, **28**, 1–16
- Kaleta, E.F., Alexander, D.J. and Russell, P.H. (1985) The first isolation of the avian PMV1 virus responsible for the current panzootic in pigeons. *Avian Pathology*, **14**, 553–557
- Kaminjolo, J.S., Nyaga, P.N. and Gicho, J.N. (1974) Isolation, cultivation and characterization of a pox virus from some horses in Kenya. *Zentralblatt für Veterinärmedizin, Reihe B*, **21**, 592–601
- Kane, A.J., Stover, S.M., Gardner, I.A., Case, J.T., Johnson, B.J., Read, D.H. and Ardans, A.A. (1996) Horseshoe characteristics as possible risk factors for fatal musculoskeletal injury of Thoroughbred racehorses. *American Journal of Veterinary Research*, **57**, 1147–1152
- Kane, A.J., Stover, S.M., Gardner, I.A., Bock, K.B., Case, J.T., Johnson, B.J., Anderson, M.L., Barr, B.C., Daft, B.M.,



- Jinde, H., Larochelle, D., Moore, J., Mysore, J., Stolz, J., Woods, L., Read, D.H. and Ardans, A.A. (1998) Hoof size, shape and balance as possible risk factors for catastrophic musculoskeletal injury of Thoroughbred racehorses. *American Journal of Veterinary Research*, **59**, 1545–1552
- Kaneene, J.B. and Miller, R. (1995) Risk factors for metritis in Michigan dairy cattle using herd- and cow-based modelling approaches. *Preventive Veterinary Medicine*, **23**, 183–200
- Kaneene, J.B. and Willeberg, P. (1988) Influence of management factors on the occurrence of antibiotic residues in milk: a case-control study in Michigan dairy herds, with examples of suspected information bias. *Acta Veterinaria Scandinavica*, Suppl. **84**, 473–476
- Kaneene, J.B., Miller, R., Herdt, T. and Gardenier, J. (1991) Hematological indices of feed utilization as predictors of postpartum diseases: metritis, retained placenta and mastitis. In: Proceedings of the Sixth International Symposium on Veterinary Epidemiology and Economics, Ottawa, 12–16 August 1991. Ed. Martin, S.W., pp. 301–303
- Kaneene, J.B., Miller, R., Ross, W.A., Gallagher, K., Marteniuk, J. and Rook, J. (1997) Risk factors for colic in the Michigan (USA) equine population. *Preventive Veterinary Medicine*, **30**, 23–36
- Kaneene, J.B., Bruning-Fann, C.S., Granger, L.M., Miller, R. and Porter-Spalding, B.A. (2002) Environmental and farm management factors associated with tuberculosis on cattle farms in northeastern Michigan. *Journal of the American Veterinary Medical Association*, **221**, 837–842
- Kaneko, J.J., Harvey, J.W. and Bruss, M.L. (Eds) (1997) *Clinical Biochemistry of Domestic Animals*, 5th edn. Academic Press, San Diego
- Kapetsky, J.M., Wijkstrom, U.N., Macpherson, N.J., Vincke, M.M.J., Ataman, E. and Caponera, F. (1991) Where are the best opportunities for fish farming in Ghana? The Ghana aquaculture geographical information system as a decision-making tool. In: *Geographical Information Systems and Remote Sensing in Inland Fisheries*. FAO Fisheries technical paper No. 318, pp. 228–233
- Kaplan, E.L. and Meier, P. (1958) Non-parametric estimation from incomplete observations. *Journal of the American Statistical Association*, **53**, 457–481
- Kaplan, M.M. (1982) Influenza in nature. In: *Animal Diseases in Relation to Animal Conservation*. Symposium of the Zoological Society of London No. 50. Eds Edwards, M.A. and McDonald, U., pp. 121–135. Academic Press, London and New York
- Kappeler, A. (1992) Biological and ecological approaches to the management of reservoir species. In: *Wildlife Rabies Control*. Eds Bögel, K., Meslin, F.X. and Kaplan, M., pp. 184–186. Wells Medical, Tunbridge Wells
- Karasszon, D. (1988) *A Concise History of Veterinary Medicine*. Akadémiai Kiadó, Budapest
- Kärber, G. (1931) Beitrag zur kollektiven Behandlung pharmakologischer Reihenversuche. *Archiv für experimentelle Pathologie und Pharmakologie*, **162**, 480–487
- Karstad, L. (1962) Epizootiology in disease investigations. *Canadian Veterinary Journal*, **3**, 145–149
- Kasl, S.V. and Jones, B.A. (2002) Social epidemiology: towards a better understanding of the field. *International Journal of Epidemiology*, **31**, 1094–1097
- Kasper, R.G. (1980) Perceptions of risk and their effects on decision making. In: *Societal Risk Assessment: How Safe is Enough?* Eds Schwing, R.C. and Albers, A., pp. 71–80 (Discussion: pp. 80–84). Plenum Press, New York
- Kasperson, R.E., Jhaveri, N. and Kasperson, J.X. (2001) Stigma and the social amplification of risk: toward a framework of analysis. In: *Risk, Media, and Stigma: Understanding Public Challenges to Modern Science and Technology*, Eds Flynn, J., Slovik, P. and Kunreuther, H., pp. 9–27. Earthscan, London
- Kass, P.H. and Greenland, S. (1991) Conflicting definitions of confounding and their ramifications for veterinary epidemiologic research: collapsibility vs comparability. *Journal of the American Veterinary Medical Association*, **199**, 1569–1573
- Kass, P.H., Barnes, W.G., Spangler, W.L., Chomel, B.B. and Cuthbertson, M.R. (1993) Epidemiologic evidence for a causal relation between vaccination and fibrosarcoma tumorigenesis in cats. *Journal of the American Veterinary Medical Association*, **203**, 396–405 (Correction: p. 1046)
- Kat, P.W., Alexander, K.A., Smith, J.S. and Munson, L. (1995) Rabies and African wild dogs in Kenya. *Proceedings of the Royal Society of London, Series B*, **262**, 229–233
- Katz, D., Baptista, J., Azen, S.P. and Pike, M.C. (1978) Obtaining confidence intervals for the risk ratio in cohort studies. *Biometrics*, **34**, 469–474
- Kay, R.D. (1986) *Farm Management. Planning, Control, and Implementation*. McGraw-Hill, New York
- Keen, J.E., Hungerford, L.L., Littledike, E.T., Wittum, T.E. and Kwang, J. (1997) Effect of ewe ovine lentivirus infection on ewe and lamb productivity. *Preventive Veterinary Medicine*, **30**, 155–169
- Keet, D.F., Hunter, P., Bengis, R.G., Bastos, A. and Thomson, G.R. (1996) The foot-and-mouth disease epizootic in the Kruger National Park. *Journal of the South African Veterinary Association*, **67**, 83–87
- Keffaber, K.K. (1989) Reproductive failure of unknown aetiology. *American Association of Swine Practitioners Newsletter*, **1** (2), 1, 4–9
- Kellar, J., Marra, R. and Martin, W. (1976) Brucellosis in Ontario: a case-control study. *Canadian Journal of Comparative Medicine*, **40**, 119–128
- Kellar, J.A. (1983) Canada's bovine serum bank – a practical approach. In: Proceedings of the Third International Symposium on Veterinary Epidemiology and Economics, Arlington, Virginia, 6–10 September, 1982, pp. 138–143. Veterinary Medical Publishing Company, Edwardsville
- Keller, G.G. and Corley, E.A. (1989) Canine hip dysplasia: Investigating the sex predilection and the frequency of unilateral CHD. *Veterinary Medicine*, **84**, 1162–1166
- Keller, G.H. and Manak, M.M. (Eds) (1989) *DNA Probes*. Macmillan, London
- Kelly, J.M. and Whitaker, D.A. (2001) A multidisciplinary approach to dairy herd health and productivity management. In: *Fertility in the High-Producing Dairy Cow*, British Society of Animal Science Occasional Publication No. 26, Vol. 1. Ed. Diskin, M.G., pp. 209–222
- Kelly, L.A., Hartnett, E., Gettinby, G., Fazil, A., Snary, E. and Wooldridge, M. (2003) Microbial safety of poultry meat: risk assessment as a way forward. *World's Poultry Science Journal*, **59**, 495–508



- Kelly, L. (2005) Microbial risk assessment in poultry production and processing. In: *Food Safety Control in the Poultry Industry*. Ed. Mead, G., pp. 255–272. Woodhead Publishing, Abington
- Kelly, L., Smith, D.L., Snary, E.L., Johnson, J.A., Harris, A.D., Wooldridge, M. and Morris, J.G. (2004) Animal growth promoters: to ban or not to ban? A risk assessment approach. *International Journal of Antimicrobial Agents*, **24**, 7–14
- Kelly, N.C. and Wills, J.M. (Eds) (1996) *Manual of Companion Animal Nutrition and Feeding*. British Small Animal Veterinary Association, Shurdington
- Kelsey, J.L., Moore, A.S. and Glickman, L.E. (1998) Epidemiologic studies of risk factors for cancer in pet dogs. *Epidemiologic Reviews*, **20**, 204–217
- Kelton, D.F., Martin, S.W. and Hansen, D.S. (1992) Development and implementation of the Ontario dairy monitoring and analysis program. In: Proceedings of the 17th World Buiatrics Congress and the 25th American Association of Bovine Practitioners Conference, St Paul, Minnesota, 31 August–4 September 1992. Ed. Williams, I.E., Vol. 1, pp. 285–289
- Kendall, D.G. (1957) La propagation d'une épidémie ou d'un bruit dans une population limitée. *Publications of the Institute of Statistics, University of Paris*, **6**, 307–331
- Kendall, M.G. and Buckland, W.R. (1982) *A Dictionary of Statistical Terms*, 4th edn. Longman, London and New York
- Kent, J.E., Meikle, L., Molony, V. and McKendrick, I.J. (2001) Qualitative versus quantitative assessment of an acute pain in lambs. *Proceedings of the Sheep Veterinary Society*, **25**, 65–66
- Kent, J.E., Thrusfield, M.V., Molony, V., Hosie, B.D. and Sheppard, B.W. (2004) Randomised, controlled field trial of two new techniques for the castration and docking of lambs less than two days of age. *Veterinary Record*, **154**, 193–200
- Kerr, M.G. and van Doorn, T. (1999) Mass screening of Irish wolfhound puppies for portosystemic shunts by the dynamic bile acid test. *Veterinary Record*, **144**, 693–696
- Kestin, S.C., Knowles, T.G., Tinch, A.E. and Gregory, N.G. (1992) Prevalence of leg weakness in broiler chickens and its relationship with genotype. *Veterinary Record*, **131**, 191–194
- Khoury, M.J., Beaty, T.H. and Cohen, B.H. (1993) *Fundamentals of Genetic Epidemiology*. Oxford University Press, New York
- Kim, L.M., Morley, P.S., Traub-Dargatz, J.L., Salman, M.D. and Gentry-Weeks, C. (2001) Factors associated with *Salmonella* shedding among equine colic patients at a veterinary teaching hospital. *Journal of the American Veterinary Medical Association*, **218**, 740–748
- King, G. (1696) *Natural and Political Observations and Conclusions upon the State and Condition of England 1696*. Published in 1804 by G.E. Barnett, London. Reproduced in facsimile, with an introduction by P. Laslett, in *The Earliest Classics*. Gregg International Publishers, Farnborough, 1973
- King, L.J. (1985) Unique characteristics of the National Animal Disease Surveillance System in the United States. *Journal of the American Veterinary Medical Association*, **186**, 35–39
- King, V.L., Koketsu, Y., Reeves, D., Xue, J. and Dial, G.D. (1998) Management factors associated with swine breeding-herd productivity in the United States. *Preventive Veterinary Medicine*, **35**, 255–264
- Kingwill, R.G., Neave, F.K., Dodd, F.H., Griffin, T.K. and Westgarth, D.R. (1970) The effect of a mastitis control system on levels of subclinical and clinical mastitis in two years. *Veterinary Record*, **87**, 94–100
- Kiper, M.L., Traub-Dargatz, J.L., Salman, M.D. and Rikihisa, Y. (1992) Risk factors for equine monocytic ehrlichiosis seropositivity in horses in Colorado. *Preventive Veterinary Medicine*, **13**, 251–259
- Kirk, J., Atwill, E., Holmberg, C., Arana, M., Collar, C., Ghirardelli, D., Higginbotham, G., Markagaard, G., Mullinax, D. and Wubishet, A. (2002) Prevalence of and risk factors for *Salmonella* in water offered to weaned dairy calves in California, USA. *Preventive Veterinary Medicine*, **54**, 169–178
- Kirkland, T.N. and Fierer, J. (1996) Coccidioidomycosis: a reemerging infectious disease. *Emerging Infectious Diseases*, **2**, 192–199
- Kirkwood, J.K. (2003) Welfare, husbandry and veterinary care of wild animals in captivity; changes in attitudes, progress in knowledge and techniques. In: *International Zoo Yearbook*, **38**. Eds Olney, P.J.S. and Fiskin, F.A., pp. 124–130. The Zoological Society of London, London
- Kirkwood, T.B.L. (1985) Comparative and evolutionary aspects of longevity. In: *Handbook of the Biology of Aging*, 2nd edn. Eds Finch, C.E. and Schneider, E.L., pp. 27–44. Van Nostrand Reinhold, New York
- Kiska, D.L. (2000) Global climate change; an infectious disease perspective. *Clinical Microbiology Newsletter*, **22**, 81–86
- Kissling, R.E. (1958) Host relationships of the arthropod-borne encephalitides. *Annals of the New York Academy of Sciences*, **70**, 320–327
- Kissling, R.E., Chamberlain, R.W., Eidson, E., Sikes, R.K., and Bucca, M.A. (1954) Studies on the North American arthropod-borne encephalitides. II. Eastern equine encephalitis in horses. *American Journal of Hygiene*, **60**, 237–250
- Kitala, P.M., McDermott, J.J., Kyule, M.N. and Gathuma, J.M. (2000) Community-based active surveillance for rabies in Machakos District, Kenya. *Preventive Veterinary Medicine*, **44**, 73–85
- Kitchin, P.A., Almond, N., Szotyori, Z., Fromhole, C.E., McAlpine, L., Silvera, P., Stott, E.J., Cranage, M., Baskerville, A. and Schild, G. (1990) The use of the polymerase chain reaction for the detection of Simian immunodeficiency virus in experimentally infected macaques. *Journal of Virological Methods*, **28**, 85–100
- Kitching, R.P. (1998) A recent history of foot-and-mouth disease. *Journal of Comparative Pathology*, **118**, 89–108
- Kitching, R.P. (2004) Predictive models and FMD: the emperor's new clothes? *The Veterinary Journal*, **167**, 127–128
- Kitching, R.P. and Hughes, G.J. (2002) Clinical variation in foot and mouth disease: sheep and goats. *Revue Scientifique et Technique, Office International des Epizooties*, **21**, 505–512
- Kitching, R.P., Hutber, A.M. and Thrusfield, M.V. (2005) A review of foot-and-mouth disease with special consideration for the clinical and epidemiological factors relevant to predictive modelling of the disease. *The Veterinary Journal*, **169**, 197–209
- Kitching, R.P., Thrusfield, M.V. and Taylor, N.M. (2006) Use and abuse of mathematical models: an illustration

- from the 2001 foot and mouth disease epidemic in the United Kingdom. *Revue Scientifique et Technique, Office International des Epizooties*, **25**, 294–311
- Kitron, U., Bouseman, J.K. and Jones, C.J. (1991) Use of the ARC/INFO GIS to study the distribution of Lyme disease ticks in an Illinois county. *Preventive Veterinary Medicine*, **11**, 243–248
- Kittelberger, R., Hilbink, F., Hansen, F., Penrose, M., de Lisle, G., Letesson, J.-J., Garin-Bastuji, B., Searson, J., Fossati, C.A., Cloeckaert, A. and Schurig, G. (1995) Serocrossreactivity between *Brucella abortus* and *Yersinia enterocolitica* O:9. I Immunoblot analysis of the response to *Brucella* protein antigens in bovine brucellosis. *Veterinary Microbiology*, **47**, 257–270
- Klein, M. (1962) The relationship of two bovine adenoviruses to human adenoviruses. *Annals of the New York Academy of Sciences*, **101**, 493–497
- Kleinbaum, D.G., Kupper, L.L. and Morgenstern, H. (1982) *Epidemiologic Research. Principles and Quantitative Measures*. Lifetime Learning Publications, Belmont
- Klimczak, J.C. (1994) SNOMED (review) *Preventive Veterinary Medicine*, **21**, 266–269
- Knecht, C.D. and Phares, J. (1971) Characterization of dogs with salivary cyst. *Journal of the American Veterinary Medical Association*, **158**, 612–613
- Knight, H.D. (1972) Bacterial and spirochetal diseases: other bacterial infections. In: *Equine Medicine and Surgery – A Textbook and Reference Work*, 2nd edn. Eds Catcott, E.J. and Smithcors, J.F., pp. 85–113. American Veterinary Publications, Wheaton
- Knowles, D.P. and Gorham, J.R. (1990) Diagnosis of viral and bacterial diseases. *Revue Scientifique et Technique, Office International des Epizooties*, **9**, 733–757
- Knox, G.A. (1964) The detection of space-time interactions. *Applied Statistics*, **13**, 25–29
- Knox, K.M.G., Reid, S.W.J., Irwin, T. and Gettinby, G. (1996) Interrogation of a hospital database: from data to decision support. In: *Society for Veterinary Epidemiology and Preventive Medicine Proceedings*, Glasgow, 27–29 March 1996. Eds Thrusfield, M.V. and Goodall, E.A., pp. 94–101
- Koch, A. (1891) *Encyclopädie der gesammten Thierheilkunde und Thierzucht*, tome 8. Verlag Moritz Perles, Vienna and Leipzig
- Koch, R. (1892) *Ueber bakteriologische Forschung*. Hirschwald, Berlin. Translation: Rivers, T.M. (1937) Viruses and Koch's postulates. *Journal of Bacteriology*, **33**, 1–12
- Kock, R.A. and Woodford, M.H. (1988) Reintroduction of Pere David's deer (*Elaphurus davidianus*), scimitar-horned oryx (*Oryx dammah*) and the Arabian Oryx (*Oryx leucoryx*) to their native habitats: a veterinary perspective. Proceedings of the Joint Conference of American Association of Zoo Veterinarians and American Association of Wildlife Veterinarians, Toronto, Ontario, pp. 143–144
- Komarov, A. and Kalmar, E. (1960) A hitherto undescribed disease – turkey meningo-encephalitis. *Veterinary Record*, **72**, 257–261
- Konig, C.D.W. (1985) Bedrijfsdiergeneeskundige aspecten van de schapenhouderij (Planned animal health and production service on sheep farms. An inventory and evaluation). PhD Thesis. University of Utrecht
- Konner, M. (1993) *The Trouble with Medicine*. BBC Books, London
- Körmendy, B. (1988) Diagnostic value of mammalian, avian and johnin PPD tuberculin in cattle herds infected with *Mycobacterium paratuberculosis*. *Acta Veterinaria Hungarica*, **36**, 177–183.
- Kosmider, R.D., Kelly, L., Laurenson, K., Coleman, P., Fooks, A.R., Woolhouse, M. and Wooldridge, M. (2006) Risk assessment informs policy decisions regarding pet importation. *Veterinary Record*, **158**, 694–695
- Kossaibati, M.A. and Esslemont, R.J. (1997) The cost of production diseases in dairy herds in England. *Veterinary Journal*, **154**, 41–51
- Kossaibati, M.A., Hovi, M. and Esslemont, R.J. (1998) Incidence of clinical mastitis in dairy herds in England. *Veterinary Record*, **143**, 649–653
- Kovacs, A.B. and Beer, G.Y. (1979) The mechanical properties and qualities of floors for pigs in relation to limb disorders. *The Pig Veterinary Society Proceedings*, **5**, 99–104
- Krabbe, H. (1864) Observations for Icelanders on hydatids and precautions against them. J. Schultz, Copenhagen. Translated by Maxwell, I.R. (1973). *Australian Veterinary Journal*, **49**, 395–401
- Krebs, J.R. (1997) *Bovine Tuberculosis in Cattle and Badgers*. Ministry of Agriculture, Fisheries and Food, London
- Krehbiel, J.D. and Langham, R.F. (1975) Eyelid neoplasms of dogs. *American Journal of Veterinary Research*, **36**, 115–119
- Kricka, L.J. (Ed.) (1992) *Nonisotopic DNA Probe Techniques*. Academic Press, San Diego
- Kristjanson, P.M., Swallow, B.M., Rowlands, G.J., Kruska, R.L. and de Leeuw, P.N. (1999) Measuring the costs of African animal trypanosomosis, the potential benefits of control and returns to research. *Agricultural Systems*, **59**, 79–98
- Kroneman, A., Vellenga, L., van der Wilt, F.J. and Vermeer, H.M. (1993) Review of health problems in group-housed sows, with special emphasis on lameness. *The Veterinary Quarterly*, **15**, 26–29
- Krook, L., Larsson, S. and Rooney, J.R. (1960) The interrelationship of diabetes mellitus, obesity, and pyometra in the dog. *American Journal of Veterinary Research*, **21**, 120–124
- Kryter, K.D. (1985) *The Effects of Noise on Man*, 2nd edn. Academic Press, Orlando
- Kubes, V. and Rios, F.A. (1939) The causative agent of infectious equine encephalomyelitis in Venezuela. *Science*, **90**, 20–21
- Kuhn, T.S. (1970) *The Structure of Scientific Revolutions*. International Encyclopaedia of Unified Science, Vol. 2, No. 2, 2nd edn. University of Chicago Press, Chicago and London
- Kühne, M. and Lhafi, S.K. (2005) Ist erregerefreiheit in tierbeständen für die lebensmittelsicherheit notwendig? [Do we need pathogen-free livestock for food safety?] (In German) *Deutsche tierärztliche Wochenschrift*, **112**, 300–303
- Kupper, L.L. and Hogan, M.D. (1978) Interaction in epidemiologic studies. *American Journal of Epidemiology*, **108**, 447–453
- Kvale, S. (1996) *InterViews: an Introduction to Qualitative Research Interviewing*. Thousand Oaks, California
- Kwon, J.M. and Goate, A.M. (2000) The candidate gene approach. *Alcohol Research and Health*, **24**, 164–168
- L'Estrange Ewen, C. (1933) *Witchcraft and Demonism. A Concise Account Derived from Sworn Depositions and Confessions*

- Obtained in the Courts of England and Wales*. Heath Cranton, London
- Lafi, S.Q. and Kaneene, J.B. (1992) Epidemiological and economic study of the repeat breeder syndrome in Michigan dairy cattle. I. Epidemiological modeling. *Preventive Veterinary Medicine*, **14**, 87–98
- Lance, S.E., Miller, G.Y., Hancock, D.D., Bartlett, P.C., Heider, L.E. and Moeschberger, M.L. (1992) Effects of environment and management on mortality in preweaned dairy calves. *Journal of the American Veterinary Medical Association*, **201**, 1197–1202
- Landman, M.A.A.M., de Blaauw, J.A., van Weeren, P.R. and Hofland, L.J. (2004) Field study of the prevalence of lameness in horses with back problems. *Veterinary Record*, **155**, 165–168
- Lane-Clayton, J.E. (1926) A further report on cancer of the breast. *Reports on Public Health and Medical Subjects*, **32**. His Majesty's Stationery Office, London
- Langbein, J. (1996) The red deer of Exmoor and the Quantocks. *Deer*, **9**, 492–498
- Langmuir, A.D. (1963) The surveillance of communicable diseases of national importance. *New England Journal of Medicine*, **268**, 182–192
- Langmuir, A.D. (1965) Developing concepts in surveillance. *The Millbank Memorial Fund Quarterly*, **43** (2), 369–372
- Langmuir, A.D. (1971) Communicable disease surveillance. *Proceedings of the Royal Society of Medicine*, **64**, 681–684
- Langmuir, A.D. (1976) William Farr: Founder of modern concepts of surveillance. *International Journal of Epidemiology*, **5**, 13–18
- Langston, A.A., Mellersh, C.S., Wiegand, N.A., Acland, G.M., Ray, K., Aguirre, G.D. and Ostrander, E.A. (1999) Towards a framework linkage map of the canine genome. *Journal of Heredity*, **90**, 7–14
- Lansdowne, Z.F. (1999) Risk Matrix: an approach for prioritizing risks and tracking risk mitigation progress. In: Proceedings of the 30th Annual Project Management Institute 1999 Seminars & Symposium, Philadelphia, Pennsylvania, USA. Papers presented October 10 to 16, 1999. Unpaginated. Project Management Institute, Four Campus Boulevard, Newtown Square, PA 19073-3299, US
- Lantz, C.A. and Nebenzahl, E. (1996) Behavior and interpretation of the kappa statistic: resolution of the two paradoxes. *Journal of Clinical Epidemiology*, **49**, 431–434
- Laplace, P.-S. (1814) *Essai Philosophique sur les Probabilités*. Translated as *A Philosophical Essay on Probabilities*. Truscott, F.W. and Emory, F.L. (translators) (1951). Dover Publications, New York
- Larsen, C.T., Domermuth, C.H., Sponenberg, D.P. and Gross, W.B. (1985) Colibacillosis of turkeys exacerbated by haemorrhagic enteritis virus. Laboratory studies. *Avian Diseases*, **29**, 729–732
- Larsen, M. (1999) Biological control of helminths. *International Journal for Parasitology*, **29**, 139–146
- Larsen, M.M., Lendal, S., Chriél, M., Olsen, S.N. and Bjørn, H. (2002) Risk factors for high endoparasitic burden and the efficiency of a single anthelmintic treatment of Danish horses. *Acta Veterinaria Scandinavica*, **43**, 99–106
- Lascelles, B.D., Cripps, P.J., Jones, A. and Waterman, A.E. (1997) Post-operative central hypersensitivity and pain: the pre-eruptive value of pethidine for ovariohysterectomy. *Pain*, **73**, 461–471
- Last, J.M. (2001) *A Dictionary of Epidemiology*, 4th edn. Oxford University Press, New York
- Laughlin, R.B. and Pines, D. (2000) The theory of everything. *Proceedings of the National Academy of Sciences of the United States of America*, **97**, 28–31
- Laurenson, K., Sillero-Zubiri, C., Thompson, H., Shieffraw, F., Thergood, S. and Malcolm, J. (1998) Disease as a threat to endangered species: Ethiopian wolves, domestic dogs and canine pathogens. *Animal Conservation*, **1**, 273–280
- Laurenson, K.L., Hoyle, D., Woolhouse, M. and Coleman, P. (2002) *Revised Assessment of the Risk of Importing Rabies if Pet Animals from North America were eligible for the Pet Travel Scheme (PETS)*. <http://www.defra.gov.uk/animalh/quarantine/pets/safety/edinburgh2002.PDF> (Accessed 19 April 2006)
- Laut, P. (1986) Land evaluation for bovine tuberculosis eradication in Northern Australia. *Australian Geographical Studies*, **24**, 259–271
- Lave, L. (1996) Benefit–cost analysis: do the benefits exceed the costs? In: *Risks, Costs, and Lives Saved: Getting Better Results from Regulation*. Ed. Hahn, R.W., pp. 104–134. Oxford University Press, Oxford
- Lawler, D.F. (1998a) Prevention and management of infection in kennels. In: *Infectious Diseases of the Dog and Cat*, 2nd edn. Ed. Greene, C.F., pp. 706–710. W.B. Saunders, Philadelphia
- Lawler, D.F. (1998b) Prevention and management of infection in catteries. In: *Infectious Diseases of the Dog and Cat*, 2nd edn. Ed. Greene, C.F., pp. 701–706. W.B. Saunders, Philadelphia
- Lebeau, A. (1953) L'âge du chien et celui de l'homme. Essai de statistique sur la mortalité canine. *Bulletin de l'Académie Vétérinaire de France*, **26**, 229–232
- Leblond, A., Chalvet-Monfray, K., Magnan, C., Marchand, S. and Sabatier, P. (2002) Digestive parasitism as a risk factor for colic in horses – results of a multicentre case-control study conducted in European Veterinary Universities. In: *Society for Veterinary Epidemiology and Preventive Medicine*, Cambridge, 3–5 April 2002, Eds Menzies, F.D. and Reid, S.W.J., pp. 61–71
- Lederberg, J., Shope, R.E. and Oaks, S.C. (1992) *Emerging Infections: Microbial Threats to Health in the United States*. National Academy Press, Washington, DC
- Lee, E.T. (1992) *Statistical Methods for Survival Data Analysis*, 2nd edn. John Wiley, New York
- Lee, J.-A.L.M., More, S.J. and Cotiw-an, B.S. (1999) Problems translating a questionnaire in a cross-cultural setting. *Preventive Veterinary Medicine*, **41**, 187–194
- Lee, W.M. and Yeilding, N.M. (2003) Molecular cell biology. In: *Oxford Textbook of Medicine*, Vol. 1. Eds Warrell, D.A., Cox, T.M., Firth, J.D. and Benz, E.J., pp. 90–107. Oxford University Press, Oxford
- Leech, A., Howarth, R.J., Thornton, I. and Lewis, G. (1982) Incidence of bovine copper deficiency in England and the Welsh borders. *Veterinary Record*, **111**, 203–204
- Leech, F.B. (1980) Relations between objectives and observations in epidemiological studies. In: *Veterinary Epidemiology and Economics*. Proceedings of the Second International Symposium, Canberra, 7–11 May 1979. Eds Geering,

- W.A., Roe, R.T. and Chapman, L.A., pp. 254–257. Australian Government Publishing Services, Canberra
- Lehmann, E.L. and D'Abrera, H.J.M. (1975) *Nonparametrics*. Holden-Day, San Francisco
- Leighton, F.A. (2002) Health risk assessment of the translocation of wild animals. *Revue Scientifique et Technique, Office International des Epizooties*, **21**, 187–195
- Leimbacher, F. (1978) Experience with the 'Mt' system of forecasting fascioliasis in France. In: *Weather and Parasitic Animal Disease*. Ed. Gibson, T.E., pp. 6–13. World Meteorological Organization Technical Note No. 159
- Lekcharoensuk, C., Osborne, C. and Lulich, J. (2001) Epidemiologic study of risk factors for lower urinary tract diseases in cats. *Journal of American Veterinary Medical Association*, **218**, 1429–1435
- Lekcharoensuk, C., Osborne, C.A., Lulich, J.P., Pusoonthornthum, R., Kirk, C.A., Ulrich, L.K., Koehler, L.A., Carpenter, K.A. and Swanson, L.L. (2002a) Associations between dietary factors in canned food and formation of calcium oxalate uroliths in dogs. *American Journal of Veterinary Research*, **63**, 163–169
- Lekcharoensuk, C., Osborne, C.A., Lulich, J.P., Pusoonthornthum, R., Kirk, C.A., Ulrich, L.K., Koehler, L.A., Carpenter, K.A. and Swanson, L.L. (2002b) Associations between dry dietary factors and canine calcium oxalate uroliths. *American Journal of Veterinary Research*, **63**, 330–337
- Lemire, G.E., Lemire, M.R., Tiemann, M. and Verdon, L. (1991) Analytical study of small dairy herds with high pregnancy loss rates. In: *Proceedings of the Sixth International Symposium on Veterinary Epidemiology and Economics*, Ottawa, 12–16 August 1991. Ed. Martin, S.W., pp. 320–322.
- Lengerich, E.J., Teclaw, R.F., Mendlein, J.M., Mariolis, P. and Garbe, P.L. (1992) Pet populations in the catchment area of the Purdue Comparative Oncology Program. *Journal of the American Veterinary Medical Association*, **200**, 51–56
- Lennon, M.A. (2003) Water fluoridation: the public health benefits. *Biologist*, **50**, 200
- Lentner, C. (Ed.) (1982) *Geigy Scientific Tables*, 8th edn. Vol. 2. Ciba-Geigy, Basle
- Leonard, F.C., O'Connell, J. and O'Farrell, K. (1994) Effect of different housing conditions on behaviour and foot lesions in Friesian heifers. *Veterinary Record*, **134**, 490–494
- Leontides, L., Ewald, C., Mortensen, S. and Willeberg, P. (1995) Factors associated with the seroprevalence of Aujeszky's disease virus in seropositive breeding herds of Northern Germany during area-wide compulsory vaccination. *Preventive Veterinary Medicine*, **23**, 73–85
- Leontides, L., Fthenakis, G.C., Amiridis, G.S. and Saratsis, P. (2000) A matched case-control study of factors associated with retention of fetal membranes in dairy ewes in Southern Greece. *Preventive Veterinary Medicine*, **29**, 113–120
- Lepissier, H.E. and MacFarlane, I.M. (1966) Organisation for African Unity. Scientific, Technical and Research Commission. Joint Campaign against Rinderpest. Phase I Final Report, November 1965. *Bulletin of Epizootic Diseases of Africa*, **14**, 193–224
- Leppänen, M., Paloheimo, A. and Saloniemi, H. (2000a) Attitudes of Finnish dog-owners about programs to control canine genetic diseases. *Preventive Veterinary Medicine*, **43**, 145–158
- Leppänen, M., Paloheimo, A. and Saloniemi, H. (2000b) Attitudes of Finnish dog-breeders about programs to control canine genetic diseases. *Preventive Veterinary Medicine*, **43**, 159–175
- Leslie, B.E., Meek, A.H., Kawash, G.F. and McKeown, D.B. (1994) An epidemiological investigation of pet ownership in south central Ontario. *Canadian Veterinary Journal*, **35**, 218–222
- Leslie, P.H. (1945) On the use of matrices in certain population mathematics. *Biometrika*, **35**, 183–212
- Lessard, P., L'Eplattenier, R., Norval, R.A.I., Perry, B.D., Dolan, T.T., Burrill, A., Croze, H., Sorensen, M., Grootenhuis, J.G. and Irvin, A.D. (1988) The use of geographical information systems in estimating East Coast fever risk to African livestock. *Acta Veterinaria Scandinavica*, Suppl. **84**, 234–236
- Lessard, P., L'Eplattenier, R., Norval, R.A.I., Kundert, K., Dolan, T.T., Croze, H., Walker, J.B., Irvin, A.D. and Perry, B.D. (1990) Geographical Information Systems for studying the epidemiology of cattle disease caused by *Theileria parva*. *Veterinary Record*, **126**, 225–262
- Leutenegger, C.M., Pusterla, N., Wicki, R. and Lutz, H. (2003) New molecular tools in the diagnosis of tick-borne diseases. *The European Journal of Companion Animal Practice*, **13**, 185–191
- Levine, P.P. and Fabricant, J. (1950) A hitherto-undescribed virus disease of ducks in North America. *Cornell Veterinarian*, **40**, 71–86
- Levins, R. (1966) The strategy of model building in population biology. *American Scientist*, **54**, 421–431
- Levy, J.K., Woods, J.E., Turick, S.L. and Etheridge, D.L. (2003) Number of unowned free-roaming cats in a college community in the southern United States and characteristics of community residents who feed them. *Journal of the American Veterinary Medical Association*, **223**, 202–205
- Levy, P.S. and Lemeshow, S. (1999) *Sampling of Populations: Methods and Applications*, 3rd edn. John Wiley, New York
- Lewis, D. (1986) *Philosophical Papers*, Vol. 2. Oxford University Press, New York
- Liamputton, P. and Ezzy, D. (2005) *Qualitative Research Methods*, 2nd edn. Oxford University Press, Melbourne
- Lienhardt, G. (1961) *Divinity and Experience, the Religion of the Dinka*. Oxford University Press, Oxford
- Lies, B. and Plowright, W. (1964) Studies on the pathogenesis of rinderpest in experimental cattle. I Correlations of clinical signs, viraemia and virus excretion by various routes. *Journal of Hygiene, Cambridge*, **62**, 81–100
- Lightner, D.V., Redman, R.M., Poulos, B.T., Nunan, L.M., Mari, J.L. and Hasson, K.W. (1997) Risk of spread of pinead shrimp viruses in the Americas by the international movement of live and frozen shrimp. *Revue Scientifique et Technique, Office International des Epizooties*, **16**, 146–160
- Lightowers, M.W. (1996) Vaccination against cestode parasites. *International Journal for Epidemiology*, **26**, 819–824
- Lilienfeld, A.M. and Lilienfeld, D.E. (1980) *Foundations of Epidemiology*, 2nd edn. Oxford University Press, New York
- Lilienfeld, D.E. (1978) Definitions of epidemiology. *American Journal of Epidemiology*, **107**, 87–90
- Lilienfeld, D.E. (1979) 'The greening of epidemiology': sanitary physicians and the London Epidemiological

- Society (1830–1870). *Bulletin of the History of Medicine*, **52**, 503–528
- Lincoln, F.C. (1930) Calculating waterfowl abundance on the basis of banding returns. *USDA Circular No. 118, May 1930*, pp. 1–4. United States Department of Agriculture, Washington DC
- Lind, J. (1753) *A Treatise of the Scurvy in Three Parts: Containing an Inquiry into the Nature, Causes and Cure of that Disease, together with a Critical Chronological View of what has been published on the subject*. Murray and Cochran, Edinburgh
- Lindberg, A.L.E. (2003) Bovine viral diarrhoea virus infections and its control: a review. *Veterinary Quarterly*, **25**, 2–16
- Lindberg, A.L.E. and Alenius, S. (1999) Principles for eradication of bovine viral diarrhoea virus (BVDV) infections in cattle populations. *Veterinary Microbiology*, **64**, 197–222
- Lindemann, R.L. (1942) The trophic dynamic aspects of ecology. *Ecology*, **36**, 587–600
- Lindley, D.V. and Scott, W.F. (1984) *New Cambridge Elementary Statistical Tables*. Cambridge University Press, Cambridge
- Lindstrom, U.B. (1983) Effects of some herd factors and traits of the cow on bacterial scores and cell counts in quarter milk samples. *Acta Agriculturae Scandinavica*, **33**, 389–394
- Lingaas, F. (1991a) Epidemiological and genetical studies in Norwegian pig herds IV. Breed effects, recurrence of disease, and relationship between disease and some performance traits. *Acta Veterinaria Scandinavica*, **32**, 107–114
- Lingaas, F. (1991b) Epidemiological and genetical studies in Norwegian pig herds III. Herd effects. *Acta Veterinaria Scandinavica*, **32**, 97–105
- Lingaas, F. and Ronningen, K. (1991) Epidemiological and genetical studies in Norwegian pig herds II. Overall disease incidence and seasonal variation. *Acta Veterinaria Scandinavica*, **32**, 89–96
- Lipscomb, T.P., Schulman, F.Y., Moffett, D. and Kennedy, S. (1994) Morbilliviral disease in Atlantic bottlenose dolphins (*Tursiops truncatus*) from the 1987–88 epizootic. *Journal of Wildlife Diseases*, **30**, 567–571
- Lipsey, M.W. (1990) *Design Sensitivity. Statistical Power for Experimental Design*. Sage Publications, Newbury Park
- Lister, J. (1870) On the effects of the antiseptic system of treatment upon the salubrity of a surgical hospital. *Lancet*, **1**, 4–6, 40–42
- Little, I.M.D. and Mirrlees, J.A. (1974) *Project Appraisal and Planning for Developing Countries*. Heinemann, London
- Little, R.J.A. and Rubin, D.B. (2002) *Statistical Analysis with Missing Data*, 2nd edn. Wiley, New York
- Little, T.W.A., Swan, C., Thompson, H.V. and Wilesmith, J.W. (1982) Bovine tuberculosis in domestic and wild mammals in an area of Dorset. II. The badger population, its ecology and tuberculosis status. *Journal of Hygiene, Cambridge*, **89**, 211–224
- Liu, S.J., Xue, H.P., Pu, B.Q. and Qian, N.H. (1984) A new viral disease in rabbits. *Animal Husbandry and Veterinary Medicine (Xumu yu Shouyi)*, **16**, 253–255 (in Chinese)
- Lo Fo Wong, D.M.A., Dahl, J., Stege, H., van der Wolf, P.J., Leontides, L., von Altrock, A. and Thorberg, B.M. (2004) Herd-level risk factors for subclinical *Salmonella* infection in European finishing-pigs herds. *Preventive Veterinary Medicine*, **62**, 253–266
- Lobb, T. (1745) *Letters Relating to the Plague, and other Contagious Distempers*. Buckland, London
- Logan, E.F., McBeath, D.G. and Lowman, B.G. (1974) Quantitative studies on serum immunoglobulin levels in suckled calves from birth to five weeks. *Veterinary Record*, **94**, 367–370
- Logas, D. (2003) An approach to pruritus. In: *BSAVA Manual of Small Animal Dermatology*, 2nd edn. Eds Foster, A.P. and Foil, C.S., pp. 37–42. British Small Animal Veterinary Association, Gloucester
- Lomas, M.J. (1993) State Veterinary Service – Pig Health Scheme. *Pig Veterinary Journal*, **30**, 69–71
- Lord, R.D. (1983) Ecological strategies for the prevention and control of health problems. *Bulletin of the Pan American Health Organization*, **17**, 19–34
- Lord, R.D., Calisher, C.H., Metzger, W.R. and Fischer, G.W. (1974) Urban St. Louis encephalitis surveillance through wild birds. *American Journal of Epidemiology*, **99**, 360–363
- Lorenz, K. (1977) *Behind the Mirror: A Search for the Natural History of Human Knowledge*. Methuen, London
- Losinger, W.C. and Heinrichs, J. (1996) Management variables associated with high mortality rates attributable to respiratory tract problems in female calves prior to weaning. *Journal of the American Veterinary Medical Association*, **209**, 1756–1759
- Lotka, A.J. (1925) *Elements of Physical Biology*. Williams and Wilkins, Baltimore
- Louis, P.-C.-A. (1836) *Anatomical, Pathological and Therapeutic Researches upon the Disease Known under the Name of Gastro-Enterite Putrid, Adynamic, Ataxic, or Typhoid Fever, etc., compared with the Most Common Acute Diseases*. Bowditch, H.I. (translator). Vol. 1 Hilliard Gray, Boston; Vol. 2 Isaac R. Butts, Boston
- Loving, N.S. and Johnston, A.M. (1995) *Veterinary Manual for the Performance Horse*. Blackwell Science, Oxford
- Lowe, H.J. (1942) Rinderpest in Tanganyika Territory. *Empire Journal of Experimental Agriculture*, **10**, 189–203
- Lowe, J.E. (1974) Sex, breed and age incidence of navicular disease. In: Proceedings of the twentieth annual convention of the American Association of Equine Practitioners, 3–5 December 1974, Las Vegas, Nevada, pp. 37–46
- Lower, G.M. (1983) Systematic epidemiologic theory: conceptual foundations and axiomatic elements. *Medical Hypotheses*, **11**, 195–215
- Lower, G.M. and Kanarek, M.S. (1983) Conceptual/operational criteria of causality: relevance to systematic epidemiologic theory. *Medical Hypotheses*, **11**, 217–244
- Lowrance, W.W. (1976) *Of Acceptable Risk: Science and the Determination of Safety*. William Kaufmann Inc., Los Altos
- Lucia, T., Corrêa, M.N., Deschamps, J.C., Bianchi, I., Donin, M.A., Machado, A.C., Meincke, W. and Matheus, J.E.M. (2002) Risk factors for stillbirths in two swine farms in the south of Brazil. *Preventive Veterinary Medicine*, **53**, 285–292
- Lumeij, J.T., Endenburg, N. and Luyten, B.R.M. (1998) The percentage of feline, canine, avian and exotic animal consultations in veterinary practice in the Netherlands in 1994 and suggested consequences for the veterinary curriculum and residency programs. *Veterinary Quarterly*, **20**, 35–37
- Lund, E.M., Klausner, J.S., Whitney, J.Q. and Fletcher, T.F. (1994) PetCHAMP: a model for disease surveillance in private practice. In: Proceedings of the 12th Annual Veterinary Medical Forum of the American College of Veterinary Internal Medicine, San Francisco, 2–6 June 1994, pp. 93–95

- Lund, E.M., Armstrong, P.J., Kirk, C.A., Kolar, L.M. and Klausner, J.S. (1999) Health status and population characteristics of dogs and cats examined at private veterinary practices in the United States. *Journal of the American Veterinary Medical Association*, **214**, 1336–1341
- Lund, J.D., Agger, J.S. and Vestergaard, K.S. (1996) Reported behaviour problems in pet dogs in Denmark: age distribution and influence of breed and gender. *Preventive Veterinary Medicine*, **28**, 33–48
- Lust, G., Todhunter, R.J., Erb, H.N., Dykes, N.L., Williams, A.J., Burton-Wurster, N.I. and Farese, J.P. (2001) Repeatability of dorsolateral subluxation scores in dogs and correlation with macroscopic appearance of hip osteoarthritis. *American Journal of Veterinary Research*, **62**, 1711–1715
- Lutnaes, B. and Simensen, E. (1983) An epidemiological study of abomasal bloat in young lambs. *Preventive Veterinary Medicine*, **1**, 335–345
- MacAllister, C.G., Andrews, F.M., Deegan, E., Ruoff, W. and Olovson, S.-G. (1997) A scoring system for gastric ulcers in the horse. *Equine Veterinary Journal*, **29**, 430–433
- MacDiarmid, S.C. (1987) A theoretical basis for the use of a skin test for brucellosis surveillance in extensively managed cattle. *Revue Scientifique et Technique, Office International des Epizooties*, **6**, 1029–1035
- MacDiarmid, S.C. (1991) Risk analysis and the importation of animals. *Surveillance*, **18** (5), 8–11
- MacDiarmid, S.C. (1993) Risk analysis and the importation of animals and their products. *Revue Scientifique et Technique, Office International des Epizooties*, **12**, 1093–1107
- MacDiarmid, S.C. (1994) *The Risk of Introducing Exotic Diseases of Fish into New Zealand through the Importation of Ocean-caught Pacific Salmon from Canada*. Ministry of Agriculture and Fisheries, Wellington
- MacDiarmid, S.C. and Corrin, K.C. (1998) Case study: the risk of introducing rabies through the importation of dogs. In: *Owning the Future: Integrated Risk Management in Practice*. Ed. Elms, D., pp. 221–226. Centre for Advanced Engineering, University of Canterbury, Christchurch
- MacDiarmid, S.C. and Thompson, E.J. (1997) The potential risks to animal health from imported sheep and goat meat. *Revue Scientifique et Technique, Office International des Epizooties*, **16**, 45–56
- Macdonald, D.W. and Bacon, P.J. (1980) To control rabies: vaccinate foxes. *New Scientist*, **87**, 640–645
- MacEwen, E.G. (1990) Spontaneous tumors in dogs and cats: Models for the study of cancer biology and treatment. *Cancer and Metastasis Reviews*, **9**, 125–136
- Machin, D., Campbell, M.J., Fayers, P.M. and Pinol, A.P.Y. (1997) *Sample Size Tables for Clinical Studies*, 2nd edn. Blackwell Scientific Publications, Oxford
- Mackay, D.K.J. (1996) Differentiating infection from vaccination in foot-and-mouth disease. *The Veterinary Quarterly*, **20**, Suppl. 2, S2–S5
- Mackintosh, C.G., Schollum, L.M., Harris, R.E., Blackmore, D.K., Willis, A.F., Cook, N.R. and Stoke, J.C.J. (1980) Epidemiology of leptospirosis in dairy farm workers in the Manawatu. Part I: A cross-sectional serological survey and associated occupational factors. *New Zealand Veterinary Journal*, **28**, 245–250
- MacLeay, J.M., Sorum, S.A., Valberg, S.J., Marsh, W.E. and Sorum, M.D. (1999) Epidemiologic analysis of factors influencing exertional rhabdomyolysis in Thoroughbreds. *American Journal of Veterinary Research*, **60**, 1562–1566
- Maclure, M. (1985) Popperian refutation in epidemiology. *American Journal of Epidemiology*, **121**, 343–350
- Maclure, M. and Willett, W.C. (1987) Misinterpretation and misuse of the kappa statistic. *American Journal of Epidemiology*, **126**, 161–169
- MacMahon, B. (1972) Concepts of multiple factors. In: *Multiple Factors in the Causation of Environmentally Induced Disease*. Fogarty International Center Proceedings No. 12. Eds Lee, D.H.K. and Kotin, P., pp. 1–12. Academic Press, New York and London
- MacMahon, B. and Trichopoulos, D. (1996) *Epidemiology: Principles and Methods*, 2nd edn. Little, Brown, Boston
- Macquarrie, J. (1978) *The Humility of God*. SCM Press, London
- Macquarrie, J. (1998) Mascall and Thomism. *Tufton Review*, May 1998, Issue 2, Vol. 1, 1–13
- MacVean, D.W., Monlux, A.W., Anderson, P.S., Silberg, S.L. and Roszel, J.F. (1978) Frequency of canine and feline tumours in a defined population. *Veterinary Pathology*, **15**, 700–715
- Maddy, K.T. (1958) Disseminated coccidioidomycosis of the dog. *Journal of the American Veterinary Medical Association*, **132**, 483–489
- Madec, F. (1988) Multifactorial analysis of return to oestrus and low litter size in the sow. *Acta Veterinaria Scandinavica*, Suppl. 84, 167–169
- Madewell, B.R., Priester, W.A., Gillette, E.L. and Snyder, S.P. (1976) Neoplasms of the nasal passages and paranasal sinuses in domesticated animals as reported by 13 veterinary colleges. *American Journal of Veterinary Research*, **37**, 851–856
- Maes, D.G., Deluyker, H., Verdonck, M., Castryck, F., Miry, C., Vrijens, B., Ducatelle, R. and De Kruif, A. (2001) Non-infectious factors associated with macroscopic and microscopic lung lesions in slaughter pigs from farrow-to-finish herds. *Veterinary Record*, **148**, 41–46
- MAF (1977) *Brucellosis: A Veterinarian's Guide to the Literature*. Ministry of Agriculture and Fisheries, Government Printer, Wellington, New Zealand
- MAF (2000) *Import Risk Analysis: Chicken Meat and Chicken Meat Products; Bernard Matthews Foods Ltd Turkey Meat Preparations from the United Kingdom. Revised Quantitative Risk Assessments of Chicken Meat from the United States: Reassessment of Heat Treatments for Inactivation of Newcastle Disease Virus in Chicken Meat*. Ministry of Agriculture and Forestry, Wellington
- MAFF (1965) *Animal Health: A Centenary 1865–1965*. Her Majesty's Stationery Office, London
- MAFF (1976) *Animal Disease Surveillance in Great Britain*. The Report of a Ministry of Agriculture, Fisheries and Food Working Party, May 1976
- MAFF (1977) *Animal Disease Report*. 1 (2), July 1977. Ministry of Agriculture, Fisheries and Food
- MAFF (1981) *Enzootic Bovine Leukosis: Advice for Herd Owners*. Ministry of Agriculture, Fisheries and Food, Leaflet 773. Her Majesty's Stationery Office, Edinburgh
- MAFF (1983) *Brucellosis: a History of the Disease and its Eradication from Cattle in Great Britain*. Ministry of Agriculture, Fisheries and Food, London

- MAFF (1986) *Foot-and-mouth Disease. Ageing of Lesions*. Reference Book 400. Her Majesty's Stationery Office, London
- MAFF (1987) *Warble Fly*. Ministry of Agriculture, Fisheries and Food, Alnwick
- MAFF (1998) *Quarantine and Rabies – A Reappraisal*. MAFF Publications, London
- MAFF (1999) *Changes to Cattle Eartags*. Her Majesty's Stationery Office, London
- MAFF (2001) Foot and mouth disease 2001 – epidemiological forecasts. MAFF News Release 112/01 23 March. <http://www.defra.gov.uk/news/newsrel/2001/010323a.htm> (Accessed 21st October 2001)
- MAFF/ADAS (1976a) Distribution of cattle in England and Wales (map). Ministry of Agriculture, Fisheries and Food; Agricultural Development and Advisory Service
- MAFF/ADAS (1976b) Distribution of sheep in England and Wales (map). Ministry of Agriculture, Fisheries and Food; Agricultural Advisory and Development Service
- MAFF/ADAS (1976c) Distribution of pigs in England and Wales (map). Ministry of Agriculture, Fisheries and Food; Agricultural Development Advisory Service
- Maguire, D.J. (1991) An overview and definition of GIS. In: *Geographical Information Systems*, Vol. 1, Principles. Eds Maguire, D.J., Goodchild, M.F. and Rhind, D.W., pp. 9–20. Longman Scientific and Technical, Harlow
- Main, D.C.J., Clegg, J., Spatz, A. and Green, L.E. (2000) Repeatability of a lameness scoring system for finishing pigs. *Veterinary Record*, **147**, 574–576
- Mainar-Jaime, R.C. and Vázquez-Boland, J.A. (1998) Factors associated with seroprevalence to *Mycobacterium paratuberculosis* in small-ruminant farms in the Madrid region (Spain). *Preventive Veterinary Medicine*, **34**, 317–327
- Mainar-Jaime, R.C. and Vázquez-Boland, J.A. (1999) Associations of veterinary services and farmer characteristics with the prevalences of brucellosis and border disease in small ruminants in Spain. *Preventive Veterinary Medicine*, **40**, 193–205
- Mainar-Jaime, R.C., Berzal-Herranz, B., Arias, P. and Rojo-Vázquez, F.A. (2001) Epidemiological pattern and risk factors associated with bovine viral diarrhoea virus (BVDV) infection in a non-vaccinated dairy-cattle population from the Asturias region of Spain. *Preventive Veterinary Medicine*, **52**, 63–73
- Máirtín, D.O., Williams, D.H., Griffin, J.M., Dolan, L.A. and Eves, J.A. (1998) The effect of a badger removal programme on the incidence of tuberculosis in an Irish cattle population. *Preventive Veterinary Medicine*, **34**, 47–56
- Malik, R., Hunt, G.B. and Allan, G.S. (1992) Prevalence of mitral valve insufficiency in cavalier King Charles spaniels. *Veterinary Record*, **130**, 302–303
- Mamaev, L.V., Denikina, N.N., Belikov, S.I., Volichikov, V.E., Visser, I.K.G., Fleming, M., Kai, C., Harder, T.C., Liess, B., Osterhaus, A.D.M.E. and Barrett, T. (1995) Characterisation of morbilliviruses isolated from Lake Baikal seals (*Phoca sibirica*). *Veterinary Microbiology*, **40**, 251–259
- Mannelli, A., Mandola, M.L., Pedri, P., Tripoli, M. and Nebbia, P. (2001) Use of spatial statistics and GIS to study the distribution of seropositivity for *Rickettsia conorii* in dogs in Piedmonte (Italy). In: Society for Veterinary Epidemiology and Preventive Medicine, Proceedings, Noordwijkerhout, 28–30 March 2001. Eds Menzies, F.D. and Reid, S.W.J., pp. 92–99
- Mansley, L.M., Dunlop, P.J., Whiteside, S.M. and Smith, R.G.H. (2003) Early dissemination of foot-and-mouth disease virus through sheep marketing in February 2001. *Veterinary Record*, **153**, 45–50
- Manson, F.J. and Leaver, J.D. (1988) The influence of concentrate amount on locomotion and clinical lameness in dairy cattle. *Animal Production*, **47**, 185–190
- Mantel, N. (1963) Chi-square tests with one degree of freedom: extension of the Mantel–Haenszel procedure. *Journal of the American Statistical Association*, **58**, 690–700
- Mantel, N. (1967) The detection of disease clustering and a generalized regression approach. *Cancer Research*, **27**, 209–220
- Mantel, N. and Haenszel, W. (1959) Statistical aspects of the analysis of data from retrospective studies of disease. *Journal of the National Cancer Institute*, **22**, 719–748
- Marabelli, R. (2003) The role of official Veterinary Services in dealing with new social challenges: animal health and protection, food safety and the environment. *Revue Scientifique et Technique, Office International des Epizooties*, **22**, 363–371
- Marangon, S., Martini, M., Dalla Pozza, M. and Ferreira Neto, J. (1998) A case-control study on bovine tuberculosis in the Veneto Region (Italy). *Preventive Veterinary Medicine*, **34**, 87–95
- Marchevsky, N., Held, J.R. and Garcia-Carrillio, C. (1989) Probability of introducing diseases because of false negative test results. *American Journal of Epidemiology*, **130**, 611–614
- Marek, J. (1907) Multiple Nervenentzündung (Polyneuritis) bei Hühnern. *Deutsch Tierärztliche Wochenschrift*, **15**, 417–421 (in German)
- Marennikova, S.S., Maltseva, N.N., Korneeva, V.I. and Garanina, N.M. (1977) Outbreak of pox disease among *Carnivora (Felidae)* and *Edentata*. *Journal of Infectious Diseases*, **135**, 358–366
- Margawani, K.R. and Robertson, I.D. (1995) A survey of urban pet ownership in Bali. *Veterinary Record*, **137**, 486–488
- María, G.A., Villarroel, M., Chacón, G. and Gebresenbet, G. (2004) Scoring system for evaluating stress to cattle of commercial loading and unloading. *Veterinary Record*, **154**, 818–821
- Mariner, J.C. (1996) The world without rinderpest: outreach to marginalized communities. In: *The World without Rinderpest*. FAO Animal Health and Production Paper No. 129, pp. 97–107. Food and Agriculture Organization of the United Nations, Rome
- Mariner, J.C. (2000) *Manual on Participatory Epidemiology: Methods for the Collection of Action-Oriented Epidemiological Intelligence*. FAO Animal Health Manual No. 10. Food and Agriculture Organization of the United Nations, Rome
- Mariner, J.C. and Roeder, P.L. (2003) Use of participatory epidemiology in studies of lineage 2 rinderpest virus in East Africa. *Veterinary Record*, **152**, 641–647
- Mariner, J.C., Araba, A. and Makungu, S. (2002) Consultancy on the dynamics of CBPP endemism and the development of effective control/eradication strategies for pastoral communities. Pan African Programme for the Control of Epizootics, Community-based Animal Health Participatory Epidemiology Unit, Final Data Collection Report



- Markusfeld, O. (1985) Relationship between overfeeding, metritis and ketosis in high yielding dairy cows. *Veterinary Record*, **116**, 489–491
- Markusfeld, O. (1986) The association of displaced abomasum with various preparturient factors in dairy cows. *Preventive Veterinary Medicine*, **4**, 173–183
- Markusfeld, O. (1987) Inactive ovaries in high-yielding dairy cows before service: aetiology and effect on conception. *Veterinary Record*, **121**, 149–153
- Markusfeld, O. (1990) Risk recurrence of eight periparturient and reproductive traits in dairy cows. *Preventive Veterinary Medicine*, **9**, 279–286
- Marmor, M., Willeberg, P., Glickman, L.T., Priester, W.A., Cypess, R.H. and Hurvitz, A.L. (1982) Epizootiologic patterns of diabetes mellitus in dogs. *American Journal of Veterinary Research*, **43**, 465–471
- Marques, F.F.C., Buckland, S.T., Goffin, D., Dixon, C.E., Borchers, D.L., Mayle, B.A. and Peace, A.J. (2001) Estimating deer abundance from line transect surveys of dung: sika deer in southern Scotland. *Journal of Applied Ecology*, **38**, 349–365
- Marr, C.M., Jeffcott, L.B., Mair, T.S. and Muir, W.W. (Eds) (2003) Evidence-based medicine: clinical evidence and the evolution of equine evidence-based medicine. *Equine Veterinary Journal*, **35**, 331–424
- Marsh, W.E., Dijkhuizen, A.A. and Morris, R.S. (1987) An economic comparison of four culling decision rules for reproductive failure in United States dairy herds using DairyORACLE. *Journal of Dairy Science*, **70**, 1274–1280
- Marsh, W.E., Damrongwatanapokin, T., Lartz, K. and Morrison, R.B. (1991) The use of a geographical information system in an epidemiological study of pseudorabies (Aujeszky's disease) in Minnesota swine herds. *Preventive Veterinary Medicine*, **11**, 249–254
- Marsh, W.E., Nimis, G.A., Jourdan, T.J., Landucci, A.M., Udomprasert, P. and Williamson, N.E. (1993) DairyCHAMP: a computerized health and management program for use in epidemiological studies. *Preventive Veterinary Medicine*, **16**, 55–56
- Marteniuk, J.V., Carleton, C.L., Lloyd, J.W. and Shea, M.E. (1998) Association of sex of fetus, sire, month of conception, or year of foaling with duration of gestation in Standardbred mares. *Journal of the American Veterinary Medical Association*, **212**, 1743–1745
- Martikainen, P., Bartley, M. and Lahelma, E. (2002) Psychosocial determinants of health in social epidemiology. *International Journal of Epidemiology*, **31**, 1091–1093
- Martin, B., Mainland, D.D. and Green, M.A. (1982) VIRUS: A computer program for herd health and productivity. *Veterinary Record*, **110**, 446–448
- Martin, C.M. (1964) Interactions of hydrocarbon carcinogens with viruses and nucleic acids in vivo and in vitro. *Progress in Experimental Tumor Research*, **5**, 134–156
- Martin, M., Mathias, E. and McCorkle, C.M. (2001) *Ethnoveterinary Medicine*. ITDG Publishing, London
- Martin, P.M., Cotard, M., Mialott, J.-P., Andre, F. and Raynaud, J.-P. (1984) Animal models for hormone-dependent human breast cancer. Relationship between steroid receptor profiles in canine and feline mammary tumours and survival rate. *Cancer Chemotherapy and Pharmacology*, **12**, 13–17
- Martin, S.W. (1977) The evaluation of tests. *Canadian Journal of Comparative Medicine*, **41**, 19–25
- Martin, S.W. (1988) The interpretation of laboratory results. In: Lessard, P.R. and Perry, B.D. (Eds) Investigation of disease outbreaks and impaired productivity. *The Veterinary Clinics of North America: Food Animal Practice*, **4** (1), 61–78
- Martin, S.W. and Bonnett, B. (1987) Clinical epidemiology. *Canadian Veterinary Journal*, **28**, 318–325
- Martin, S.W., Aziz, S.A., Sandals, W.C.D. and Curtis, R.A. (1982a) The association between clinical disease, production and culling in Holstein-Friesian cows. *Canadian Journal of Animal Science*, **62**, 622–640
- Martin, S.W., Meek, A.H., Davis, D.G., Johnson, J.A. and Curtis, R.A. (1982b) Factors associated with mortality and treatment costs in feedlot calves: the Bruce County beef project, years 1978, 1979, 1980. *Canadian Journal of Comparative Medicine*, **46**, 341–349
- Martin, S.W., Meek, A.H. and Willeberg, P. (1987) *Veterinary Epidemiology: Principles and Methods*. Iowa State University Press, Ames
- Martin, S.W., Shoukri, M. and Thoburn, M. (1992) Evaluating the test status of herds based on tests applied to individuals. *Preventive Veterinary Medicine*, **14**, 33–43
- Martin, S.W., Eves, J.A., Dolan, L.A., Hammond, R.F., Griffin, J.M., Collins, J.D. and Shoukri, M.M. (1997) The association between bovine tuberculosis status of herds in the East Offaly Project Area, and the distance to badger setts, 1988–1993. *Preventive Veterinary Medicine*, **31**, 113–125
- Martin, S.W., Harland, R.J., Bateman, K.G. and Nagy, É. (1998) The association of titers to *Haemophilus somnus*, and other putative pathogens, with the occurrence of bovine respiratory disease and weight gain in feedlot calves. *Canadian Journal of Veterinary Research*, **62**, 262–267
- Martin, S.W., Nagy, É., Armstrong, D. and Rosendal, S. (1999) The associations of viral and mycoplasmal antibody titers with respiratory disease and weight gain in feedlot calves. *Canadian Veterinary Journal*, **40**, 560–570
- Martin, W., Lissemore, K. and Kelton, D. (1990) Animal health monitoring systems in Canada. In: Society for Veterinary Epidemiology and Preventive Medicine, Proceedings, Belfast, 4–6 April 1990. Ed. Thrusfield, M.V., pp. 62–69
- Martin, W.B. and Aitken, I.D. (Eds) (1999) *Diseases of Sheep*, 3rd edn. Blackwell Science, Oxford
- Martin, W.B., Martin, B., Hag, D. and Lauder, I.M. (1966) Bovine ulcerative mammillitis caused by a herpes virus. *Veterinary Record*, **78**, 494–497
- Martina, B.E.E., Jensen, T.H., van de Bildt, M.W.G., Harder, T.C. and Osterhaus, A.D.M.E. (2002) Variations in the severity of phocid herpesvirus type 1 infections with age in grey seals and harbour seals. *Veterinary Record*, **150**, 572–575
- Martrenchar, A., Boilletot, E., Huonnic, D. and Pol, F. (2002) Risk factors for foot-pad dermatitis in chicken and turkey broilers in France. *Preventive Veterinary Medicine*, **52**, 213–226
- Marubini, E. and Valsecchi, M.G. (1995) *Analysing Survival Data from Clinical Trials and Observational Studies*. John Wiley, Chichester
- Maslakov, V.I. (1968) On the problem of the elimination of communicable diseases. *Zeitschrift für Mikrobiologie, Epidemiologie und Immunologie*, **45**, 118–122



- Mason, I.S. (1995) Pruritus. In: *Handbook of Small Animal Dermatology*. Eds Moriello, K.A. and Mason, I.S., pp. 65–73. Pergamon, Oxford
- Mason, J.W. (1971) A re-evaluation of the concept of 'non-specificity' in stress theory. *Journal of Psychiatric Research*, **8**, 323–333
- Mason, J.W., Wool, M.S., Mougey, E.H., Wherry, F.E., Collins, D.R. and Taylor, E.D. (1968) Psychological vs nutritional factors in the effects of 'fasting' on hormonal balance. *Psychosomatic Medicine*, **30**, 554–555
- Mateu-de-Antonio, E.M., Martin, M. and Soler, M. (1993) Use of indirect enzyme-linked immunosorbent assay with hot saline solution extracts of a variant (M-) strain of *Brucella canis* for diagnosis of brucellosis in dogs. *American Journal of Veterinary Research*, **54**, 1043–1046
- Mathijssen, A. (Ed.) (1997) *The Origins of Veterinary Schools in Europe – a Comparative Review*. Veterinair Historisch Genootschap, Utrecht
- Matthews, J.N.S., Altman, D.G., Campbell, M.J. and Royston, P. (1990) Analysis of serial measurements in medical research. *British Medical Journal*, **300**, 230–236
- Matthews, J.R. (1995) *Quantification and the Quest for Medical Certainty*. Princeton University Press, Princeton
- Matthews, S.A. (1989) GIS methodology and spatial analysis: the potential epidemiological study. In: First National Conference and Exhibition, the Association for Geographical Information, Birmingham, UK. Conference papers, **6** (4), 1–6
- Matumoto, M. (1969) Mechanisms of perpetuation of animal viruses in nature. *Bacteriological Reviews*, **33**, 404–418
- Maudlin, I., Holmes, P.H. and Miles, M.A. (Eds) (2004) *The Trypanosomiasis*. CAB Publishing, Wallingford
- Maurice, H., Nielen, M., Frankena, K., Vyt, P. and Koenen, F. (2002) Studying an emerging pig disease, encephalomyocarditis, by means of a case-control study; mission impossible? In: Society for Preventive Epidemiology and Preventive Medicine, Proceedings, Cambridge, 3–5 April 2002, Eds Menzies, F.D. and Reid, S.W.J., pp. 111–119
- Maxwell, J.A. (1992) Understanding and validity in qualitative research. *Harvard Educational Review*, **62** (3), 279–300
- May, H.G. and Tittsler, R.P. (1925) Tracheo-laryngitis in poultry. *Journal of the American Veterinary Medical Association*, **67**, 229–231
- May, R.M. and Anderson, R.M. (1979) Population biology of infectious diseases. *Nature*, **280**, 455–461
- May, R.M. and Lloyd, A.L. (2001) Infection dynamics on scale-free networks. *Physical Review E*, **64**, 066112-1–066112-4
- Mayer, S.J. (1992) Stratospheric ozone depletion and animal health. *Veterinary Record*, **131**, 120–122
- Mayle, B.A., Peace, A.J. and Gill, R.M.A. (1999) *How Many Deer? A Field Guide to Estimating Deer Population Size*. Forestry Commission, Edinburgh
- McArthur, A.J. (1991) Thermal interaction between animal and microclimate: specification of a 'standard environmental temperature' for animals outdoors. *Journal of Theoretical Biology*, **148**, 331–343
- McCallum, H.I. and Dobson, A.P. (1995) Detecting disease and parasite threats to endangered species and ecosystems. *Trends in Ecology and Evolution*, **10**, 190–194
- McCallum, H.J.F. (1985) Stress and postcapture myopathy in red deer. In: *Biology of Deer Production*. Proceedings of an International Conference, Dunedin, New Zealand, 13–18 February 1983. Eds Fennessy, P.F. and Drew, K.R., pp. 65–72. Bulletin 22. The Royal Society of New Zealand, Wellington
- McCarthy, H.E., Proudman, C.J. and French, N.P. (2001) Epidemiology of equine grass sickness: a literature review (1909–1999). *Veterinary Record*, **149**, 293–300
- McCarthy, J.J., Canziani, O.F., Leary, N.A., Dokken, D.J. and White, F. (Eds) (2001) *Climate Change 2001: Impacts, Adaptation, and Vulnerability*. Cambridge University Press, Cambridge
- McCarthy, H.E., French, N.P., Edwards, G.B., Miler, K. and Proudman, C.J. (2004a) Why are certain premises at increased risk of equine grass sickness? A matched case-control study. *Equine Veterinary Journal*, **36**, 130–134
- McCarthy, H.E., French, N.P., Edwards, G.B., Poxton, I.R., Kelly, D.F., Payne-Johnson, C.E., Miler, K. and Proudman, C.J. (2004b) Equine grass sickness is associated with low antibody levels to *Clostridium botulinum*: a matched case-control study. *Equine Veterinary Journal*, **36**, 123–129
- McCaughy, W.J. (1992) Residues: sample selection. In: Society for Veterinary Epidemiology and Preventive Medicine, Proceedings, Edinburgh, 1–3 April, 1992. Ed. Thrusfield, M.V., pp. 13–23
- McCauley, E.H. (1985) Hog cholera in Honduras. Evaluation of the economic and technical aspects of the impact on production and consequences of vaccination programs; and report of 1985 owner survey results, February–April 1985. College of Veterinary Medicine, Department of Large Animal Clinical Sciences, University of Minnesota
- McCauley, E.H., Majid, A.A., Tayeb, A. and Bushara, H.O. (1983a) Clinical diagnosis of schistosomiasis in Sudanese cattle. *Tropical Animal Health and Production*, **15**, 129–136
- McCauley, E.H., Tayeb, A. and Majid, A.A. (1983b) Owner survey of schistosomiasis mortality in Sudanese cattle. *Tropical Animal Health and Production*, **15**, 227–233
- McChesney, A.E., England, J.J. and Rich, L.J. (1973) Adenoviral infection in foals. *Journal of the American Veterinary Medical Association*, **162**, 545–549
- McClintock, P.M. (1988) *The Economic Contribution of the British Equine Industry*. British Horse Society, Stoneleigh
- McClure, J.J. (1988) Equine disease association studies: a clinician's perspective. *Animal Genetics*, **19**, 409–415
- McCluskey, B.J., Mumford, E.L., Salman, M.D. and Traub-Dargatz, J.J. (2002) Use of sentinel herds to study the epidemiology of vesicular stomatitis virus in the State of Colorado. In: *The Domestic Animal/Wildlife Interface: Issues for Disease Control, Conservation, Sustainable Food Production, and Emerging Diseases*. *Annals of the New York Academy of Sciences*, Vol. 969, Eds Gibbs, E.P.J. and Bokma, B.H., pp. 205–209. The New York Academy of Sciences, New York
- McConway, K.J., Jones, M.C. and Taylor, P.C. (1999) *Statistical Modelling using GENSTAT®*. Arnold/The Open University, London
- McCorkle, C.M., Mathias, E. and Van Veen, T.W.S. (1996) *Ethnoveterinary Research and Development*. ITDG Publishing, London
- McCormick, J.B. (1998) Epidemiology of emerging/re-emerging antimicrobial-resistant bacterial pathogens. *Current Opinion in Microbiology*, **1**, 125–129

- McCracken, J.A., Pretty, J.N. and Conway, G.R. (1988) *An Introduction to Rapid Rural Appraisal for Agricultural Development*. International Institute for Environment and Development, London
- McCrea, C.T. and Head, K.W. (1978) Sheep tumours in north-east Yorkshire. I. Prevalence on seven moorland farms. *British Veterinary Journal*, **134**, 454–461
- McCrea, C.T. and Head, K.W. (1981) Sheep tumours in north-east Yorkshire. II. Experimental production of tumours. *British Veterinary Journal*, **137**, 21–30
- McDermott, J.J., Deng, K.A., Jayatileka, T.N. and El Jack, M.A. (1987) A cross-sectional cattle disease study in Kongor Rural Council, Southern Sudan. I. Prevalence estimates and age, sex and breed associations for brucellosis and contagious bovine pleuropneumonia. *Preventive Veterinary Medicine*, **5**, 111–123
- McDermott, J.J., Martin, S.W. and Allen, O.B. (1994a) Health and productivity of beef breeding bulls in Ontario. *Preventive Veterinary Medicine*, **18**, 99–113
- McDermott, J.J., Allen, O.B., Martin, S.W., Leslie, K.E., Meek, A.H. and Etherington, W.G. (1994b) Reproductive performance of Ontario beef breeding herds. *Preventive Veterinary Medicine*, **18**, 115–127
- McDougall, S. (2001) Effects of periparturient diseases and conditions on the reproductive performance of New Zealand dairy cows. *New Zealand Veterinary Journal*, **49**, 60–67
- McDougall, S. (2003) Management factors associated with the incidence of clinical mastitis over the non-lactation period and bulk tank somatic cell count during the subsequent lactation. *New Zealand Veterinary Journal*, **51**, 63–72
- McElvaine, M.D., McDowell, R.M., Fite, R.W. and Miller, L. (1993) An assessment of the risk of foreign animal disease introduction into the United States of America through garbage from Alaskan cruise ships. *Revue Scientifique et Technique, Office International des Epizooties*, **12**, 1065–1174
- McFerran, J.B. and McNulty, M.S. (Eds) (1993) *Virus Infections of Vertebrates* Vol. 4. *Virus Infections of Birds*. Elsevier, Amsterdam
- McFerran, J.B., McNulty, M.S., McKillip, E., Conner, T.J., McCracken, R.M., Collins, D.S. and Allan, G.M. (1980) Isolation and serological studies with infectious bursal disease viruses from fowl, turkey and duck: demonstration of a second serotype. *Avian Pathology*, **9**, 395–404
- McGreevy, P.D., French, N.P. and Nicol, C.J. (1995) The prevalence of abnormal behaviours in dressage, eventing and endurance horses in relation to stabling. *Veterinary Record*, **137**, 36–37
- McIlroy, S.G., Goodall, E.A., Rainey, J. and McMurray, C.H. (1988) A computerised management and disease information retrieval system for profitable broiler production. *Agricultural Systems*, **27**, 11–22
- McInerney, J.P. (1988) The economic analysis of livestock disease: the developing framework. *Acta Veterinaria Scandinavica*, Suppl. 84, 66–74
- McInerney, J.P. (1991) Economic aspects of the animal welfare issue. In: Society for Veterinary Epidemiology and Preventive Medicine, Proceedings, London, 17–19 April 1991. Ed. Thrusfield, M.V., pp. 83–91
- McInerney, J.P. (1996) Old economics for new problems – livestock disease: Presidential Address. *Journal of Agricultural Economics*, **47**, 295–314
- McInerney, J.P., Howe, K.S. and Schepers, J.A. (1992) A framework for the economic analysis of disease in farm livestock. *Preventive Veterinary Medicine*, **13**, 137–154
- McKay, B., McCallum, S. and Morris, R.S. (1988) An expert system program for diagnosing reproductive problems in seasonal dairy herds. *Acta Veterinaria Scandinavica*, Suppl. 84, 480–482
- McKiernan, B.C., Smith, A.R. and Kissel, M. (1984) Bacterial isolates from the lower trachea of clinically healthy dogs. *Journal of the American Animal Hospital Association*, **20**, 139–142
- McKinnell, R.G. and Ellis, V.L. (1972) Epidemiology of the frog renal tumour and the significance of tumour nuclear transplantation studies to a viral aetiology of the tumour – a review. In: *Oncogenesis and Herpesviruses*. Proceedings of a symposium held at Christ's College, Cambridge, 20–25 June 1971. Eds Biggs, P.M., de-The, G. and Payne, L.N. IARC Scientific Publications No. 2, pp. 183–197. International Agency for Research on Cancer, Lyon
- McLaughlan, J.D. and Henderson, W.M. (1947) The occurrence of foot-and-mouth disease in the hedgehog under natural conditions. *Journal of Hygiene, Cambridge*, **45**, 474–479
- McLeod, A. and Tyler, L. (1991) Steps in the implementation of a microcomputer approach to the management of animal disease information. *Revue Scientifique et Technique, Office International des Epizooties*, **10**, 25–49
- McMichael, A.J. and Haines, A. (1997) Global climate change: the potential effects on health. *British Medical Journal*, **315**, 805–809
- McNab, W.B., Jacobs, R.M. and Smith, H.E. (1994) A serological survey for bovine immunodeficiency-like virus in Ontario dairy cattle and association between test results, production records and management practices. *Canadian Journal of Veterinary Research*, **58**, 36–41
- McNeil, P.H., Rhodes, A.P. and Willis, B.H. (1984) *A Flock Health and Productivity Service for New Zealand*. Report of a trial involving ten farms in the Dannevirke area, November 1979–June 1983. Veterinary Services Council, New Zealand
- McNeill, W.H. (1977) *Plagues and Peoples*. Blackwell, Oxford
- McNutt, S.H., Murray, C. and Purwin, P. (1929) Swine pox. *Journal of the American Veterinary Medical Association*, **74**, 752–761
- McPherson, K., Vessey, M.P., Neil, A., Doll, R., Jones, L. and Roberts, M. (1987) Early oral contraceptive use and breast cancer: results of another case-control study. *British Journal of Cancer*, **56**, 653–660
- McTaggart, H.S., Laing, A.H., Imlah, P., Head, K.W. and Brownlie, S.E. (1979) The genetics of hereditary lymphosarcoma in pigs. *Veterinary Record*, **105**, 36
- Mead, G.C. (2000) Prospects for 'competitive exclusion' treatment to control Salmonellas and other foodborne pathogens in poultry. *The Veterinary Journal*, **159**, 111–123
- Meah, M.N. and Lewis, G.A. (2000) *Veterinary Surveillance in England and Wales – A Review*. Ministry of Agriculture, Fisheries and Food Publications, London
- Medawar, P.B. (1969) *Induction and Intuition in Scientific Thought*. Methuen, London

- Medawar, P.B. (1979) *Advice to a Young Scientist*. Basic Books, New York
- Medley, G.F. (2003) The design of test and clearance programmes. In: Society for Veterinary Epidemiology and Preventive Medicine, Proceedings, Warwick, 31 March–2 April 2003. Eds Reid, S.W.J. and Menzies, F.D., pp. 60–71
- Meeusen, E.N.T. and Maddox, J.F. (1999) Progress and expectations for helminth vaccines. *Advances in Veterinary Medicine*, **41**, 241–256
- Mehta, C.R. and Patel, N.R. (1983) A network algorithm for performing Fisher's exact test in  $r \times c$  contingency tables. *Journal of the American Statistical Association*, **78**, 327–434
- Mehta, C.R., Patel, N.R. and Gray, R. (1985) Computing an exact confidence interval for the common odds ratio in several  $2 \times 2$  contingency tables. *Journal of the American Statistical Association*, **80**, 969–973
- Meinert, C.L. (1989) Meta-analysis: science or religion? *Controlled Clinical Trials*, **10**, 257S–263S
- Meinert, C.L. and Tonascia, S. (1986) *Clinical Trials: Design, Conduct, and Analysis*. Oxford University Press, New York
- Meischke, H.R.C., Ramsey, W.R. and Shaw, F.D. (1974) The effect of horns on bruising in cattle. *Australian Veterinary Journal*, **50**, 432–434
- Mellaart, J.C. (1967) *Catal Huyuk*. McGraw-Hill, New York
- Mellado, M. and Reyes, C. (1994) Associations between periparturient disorders and reproductive efficiency in Holstein cows in northern Mexico. *Preventive Veterinary Medicine*, **19**, 203–212
- Mellor, D.J., Innocent, G.T., McEwen, S.A., Reilly, W.J., Taylor, D.J., Steele, W.B., Gunn, G.T., Ternent, H.E. and Reid, S.W.J. (2004) A semi-quantitative risk assessment model for contamination of beef carcasses with *Escherichia coli* 0157. In: *Food Safety Assurance and Veterinary Public Health. Volume 2. Food Safety Assurance and Veterinary Public Health*. Eds Smulders, F.J.M. and Collins, J.D., pp. 386–388. Wageningen Academic, Wageningen
- Mellor, P.S., Jennings, D.M., Wilkinson, P.J. and Boorman, J.P.T. (1985) *Culicoides imicola*: a bluetongue virus vector in Spain and Portugal. *Veterinary Record*, **116**, 589–590
- Melzack, R. (1983) *Pain Measurement and Assessment*. Raven Press, New York
- Melzack, R. (1987) The short-form McGill pain questionnaire. *Pain*, **30**, 191–197
- Menzies, F.D., Goodall, E.A., McLoughlin, M.F. and Wheatley, S. (1992) Computerised monitoring of disease and production in farmed Atlantic salmon (*Salmo salar*). In: Society for Veterinary Epidemiology and Preventive Medicine, Denary Proceedings, Edinburgh, 1–3 April 1992. Ed. Thrusfield, M.V., pp. 138–147
- Mepham, B. (2001) Foot and mouth disease and British agriculture: ethics in a crisis. *Journal of Agricultural and Environmental Ethics*, **14**, 339–347
- Merriam, C.H. (1893) *The Geographic Distribution of Life in North America*. Smithsonian Institute Annual Report, pp. 365–415
- Merry, D.L. and Kolar, J.R. (1984) A comparative study of four rabies vaccines. *Veterinary Medicine and Small Animal Clinician*, **79**, 661–664
- Mettenleiter, T.C. (2005) *Qualitative risk assessment of the introduction of avian influenza virus to Germany: outbreaks caused by the highly pathogenic avian influenza (HPAI) virus in Turkey, Romania and Russia as well as influenza H5 antibody detection in Greece*. Friedrich Loeffler Institute, Federal Research Institute for Animal Health. Insel Riems. [http://www.germanembassy.org.au/en/economy/Risikobewertung\\_Influenza\\_19-10-05-en.pdf](http://www.germanembassy.org.au/en/economy/Risikobewertung_Influenza_19-10-05-en.pdf) (Accessed 24 January 2006)
- Meuten, D.J. (Ed.) (2002) *Tumors in Domestic Animals*, 4th edn. Iowa State Press, Ames
- Meyers, P.J., Bonnett, B.N., Hearn, P. and McKee, S.L. (1991) Epidemiological approach to studying reproductive performance on equine breeding farms. In: Proceedings of the Sixth International Symposium on Veterinary Epidemiology and Economics, Ottawa, 12–16 August 1991. Ed. Martin, S.W., pp. 488–490
- Michel, J.-F., Dray, S., de La Rocque, S., Desquesnes, M., Solano, P., De Wispelaere, G. and Cuisance, D. (2002) Modelling bovine trypanosomosis spatial distribution by GIS in an agro-pastoral zone of Burkina Faso. *Preventive Veterinary Medicine*, **56**, 5–18
- Michell, A.R. (Ed.) (1993) *The Advancement of Veterinary Science. The Bicentenary Symposium Series. Volume 1: Veterinary Medicine beyond 2000*. CAB International, Wallingford
- Miettinen, O.S. (1970) Matching and design efficiency in retrospective studies. *American Journal of Epidemiology*, **91**, 111–118
- Miettinen, O.S. (1972) Components of the crude risk ratio. *American Journal of Epidemiology*, **96**, 168–172
- Miettinen, O.S. (1974) Confounding and effect-modification. *American Journal of Epidemiology*, **100**, 350–353
- Miettinen, O.S. (1976) Estimability and estimation in case-referent studies. *American Journal of Epidemiology*, **103**, 226–235
- Miettinen, P.V.A. and Setälä, J.J. (1993) Relationships between subclinical ketosis, milk production and fertility in Finnish dairy cattle. *Preventive Veterinary Medicine*, **17**, 1–8
- Milgrom, J. (1992) Food and faith: the ethical foundations of the Biblical diet laws. *Bible Review*, December 1992, pp. 5–10
- Milian-Suazo, F., Erb, H.N. and Smith, R.D. (1988) Descriptive epidemiology of culling in dairy cows from 34 herds in New York State. *Preventive Veterinary Medicine*, **6**, 243–251
- Milian-Suazo, F., Erb, H.N. and Smith, R.D. (1989) Risk factors for reason-specific culling of dairy cows. *Preventive Veterinary Medicine*, **7**, 19–29
- Mill, J.M. and Ward, W.R. (1994) Lameness in dairy cows and farmers' knowledge, training and awareness. *Veterinary Record*, **134**, 162–164
- Mill, J.S. (1868) *A System of Logic, Ratiocinative and Inductive: being a connected view of the principles of evidence and the methods of scientific investigation*, 7th edn. Longmans, Green, Reader, and Dyer, London
- Millar, R. and Francis, J. (1974) The relation of clinical and bacteriological findings to fertility in thoroughbred mares. *Australian Veterinary Journal*, **50**, 351–355
- Miller, D.R., Rosenberg, L., Kaufman, D.W., Stolley, P., Washauer, M.F. and Shapiro, S. (1989) Breast cancer before age 45 and oral contraceptives. *American Journal of Epidemiology*, **129**, 269–280
- Miller, N.J. (1955) Infectious necrotic rhinotracheitis of cattle. *Journal of the American Veterinary Medical Association*, **126**, 463–467

- Miller, S.A., Hohenhaus, A.E. and Hale, A.S. (2004) Case-control study of blood type, breed, sex, and bacteremia in dogs with immune-mediated hemolytic anemia. *Journal of the American Veterinary Medical Association*, **224**, 232–235
- Miller, W.M. (1976) A state-transition model of epidemic foot and mouth disease. In: *New techniques in veterinary epidemiology and economics*. Proceedings of a Symposium, Reading, 12–17 July 1976. Eds Ellis, P.R., Shaw, A.P.M. and Stephens, A.J., pp. 56–60
- Mills, D., Kunoli, H., Keen, N.T. and Mayama, S. (Eds) (1995) *Molecular Aspects of Pathogenicity and Resistance*. APS Press, St Paul
- Milne, A. (1950) The ecology of the sheep tick, *Ixodes ricinus* (L.). Spatial distribution. *Parasitology*, **41**, 189–207
- Mims, C.A., Nash, A. and Stephen, J. (2000) *Mims' Pathogenesis of Infectious Disease*, 5th edn. Academic Press, London
- Misdorp, W. (1987) The impact of pathology on the study and treatment of cancer. In: *Veterinary Cancer Medicine*, 2nd edn. Eds Theilen, G.H. and Madewell, B.R., pp. 53–70. Lea and Febiger, Philadelphia
- Misdorp, W. (1991) Progestagens and mammary tumours in dogs and cats. *Acta Endocrinologica*, **125**, Suppl. 1, 27–31
- Mishan, E.J. (1976) *Elements of Cost-Benefit Analysis*. George Allen and Unwin, London
- Miura, Y., Hayashi, S., Ishihara, T., Inaba, Y., Omori, T. and Matumoto, M. (1974) Neutralizing antibody against Akabane virus in precolostral sera from calves with congenital arthrogryposis-hydranencephaly syndrome. Brief report. *Archiv für die Gesamte Virusforschung*, **46**, 377–380
- Miura, Y., Kubo, M., Goto, Y. and Kono, K. (1990) Hydranencephaly-cerebellar hypoplasia in a newborn calf after infection of its dam with Chuzon virus. *Japanese Journal of Veterinary Science*, **52**, 689–694
- Moberg, G.P. (Ed.) (1985) *Animal Stress*. American Physiological Society, Bethesda
- Moberg, G.P. and Mench, J.A. (2000) *The Biology of Animal Stress: Basic Principles and Implications for Animal Welfare*. CAB International, Wallingford
- Mochabo, K.O.M., Kitale, P.M., Gathura, P.B., Ogara, W.O., Catley, A., Eregae, E.M. and Kaitho, T.D. (2005) Community perceptions of important camel diseases in Lapur Division of Turkana District, Kenya. *Tropical Animal Health and Production*, **37**, 187–204
- Moe, L., Bredal, W.P. and Glatte, E. (2001) *Hundetelling I Norge (Census of dogs in Norway)*. Norwegian School of Veterinary Science, Oslo (in Norwegian and English)
- Mohammed, H.O. (1990a) Factors associated with the risk of developing osteochondrosis in horses: a case-control study. *Preventive Veterinary Medicine*, **10**, 63–71
- Mohammed, H.O. (1990b) A multivariate indexing system for hygiene in relation to the risk of *Mycoplasma gallisepticum* infection in chickens. *Preventive Veterinary Medicine*, **9**, 75–83
- Mohammed, H.O., Hill, T. and Lowe, J. (1991a) Risk factors associated with injuries in thoroughbred horses. *Equine Veterinary Journal*, **23**, 445–448
- Mohammed, H.O., Oltenacu, P.A. and Erb, H.N. (1991b) A simple multivariate index for scaling breeding management variables in relation to diseases in dairy herds. In: Proceedings of the Sixth International Symposium on Veterinary Epidemiology and Economics, Ottawa, 12–16 August 1991. Ed. Martin, S.W., pp. 292–294
- Mohammed, H.O., Hill, T. and Lowe, J. (1992a) The risk of severity of limb injuries in racing Thoroughbred horses. *Cornell Veterinarian*, **82**, 331–341
- Mohammed, H.O., Rebhun, W.C. and Antczak, D.F. (1992b) Factors associated with the risk of developing sarcoid tumours in horses. *Equine Veterinary Journal*, **24**, 165–168 (Correspondence: (1993), **25**, 169)
- Mohammed, H.O., Cummings, J.F., Divers, T.J., Valentine, B., de Lahunta, A., Summers, B., Farrow, B.R.H., Trembicki-Graves, K. and Mauskopf, A. (1993) Risk factors associated with equine motor neuron disease – a possible model for human MND. *Neurology*, **43**, 966–971
- Molony, V. (1997) Comments on Anand and Craig (Letter). *Pain*, **70**, 293
- Monaghan, M.L.M. and Hannan, J. (1983) Abattoir survey of bovine kidney disease. *Veterinary Record*, **113**, 55–57
- Monath, T.P., Newhouse, V.F., Kemp, G.E., Setzer, H.W. and Cacciapuoti, A. (1974) Lassa virus isolation from *Mastomys natalensis* rodents during an epidemic in Sierra Leone. *Science*, **185**, 263–265
- Mongeau, J.D., Truscott, R.B., Ferguson, A.E. and Connell, M.C. (1959) Virus hepatitis in turkeys. *Avian Diseases*, **4**, 388–396
- Montgomery, R.D., Stein, G., Stotts, V.D. and Settle, F.H. (1979) The 1978 epornitic of avian cholera on the Chesapeake Bay. *Avian Diseases*, **23**, 966–978
- Montgomery, R.E. (1917) On a tick-borne gastro-enteritis of sheep and goats occurring in British East Africa. *Journal of Comparative Pathology and Therapeutics*, **30**, 28–57
- Montgomery, R.E. (1921) On a form of swine fever occurring in British East Africa (Kenya Colony). *Journal of Comparative Pathology and Therapeutics*, **34**, 159–191, 247–262
- Moolgavar, S.H. (1986) Carcinogenesis modelling: from molecular biology to epidemiology. *Annual Review of Public Health*, **7**, 151–169
- Moore, B. (1957) Observations pointing to the conjunctiva as a portal of entry in salmonella infections of guinea-pigs. *Journal of Hygiene, Cambridge*, **55**, 414–433
- Moore, M. (Ed.) (1999) *Manual of Companion Animal Nutrition and Feeding*. British Small Animal Veterinary Association, Quedgeley
- Moorhouse, P.D. and Hugh-Jones, M.E. (1981) Serum banks. *The Veterinary Bulletin*, **51**, 277–290
- Moorhouse, P.D. and Hugh-Jones, M.E. (1983) The results of retesting bovine sera stored at  $-18^{\circ}\text{C}$  for twenty years, with lessons for future serum banks. In: Proceedings of the Third International Symposium on Veterinary Epidemiology and Economics. Arlington, Virginia, 6–10 September 1982, pp. 44–51. Veterinary Medicine Publishing Company, Edwardsville
- Morand, S. (1996) Biodiversity of parasites in relation to their life-cycles. In: *Aspects of the Genesis and Maintenance of Biological Diversity*. Eds Hochberg, M.E., Clobert, J. and Barbault, R., pp. 243–260. Oxford University Press, Oxford
- Morand, S., Robert, F. and Connors, V.A. (1995) Complexity in parasite life cycles: population biology of cestodes in fish. *Journal of Animal Ecology*, **64**, 256–264
- Morant, S.V. (1984) Factors affecting reproductive performance including the importance and effect of problem

- cows. In: *Dairy Cow Fertility*. Proceedings of a joint British Veterinary Association and British Society of Animal Production conference, Bristol University, 26–28 June 1984. Eds Eddy R.G. and Ducker M.J., pp. 15–23. British Veterinary Association, London
- Morgan, J.P., Bahr, A., Franti, C.E. and Barley, C.S. (1993) Lumbosacral transitional vertebrae as a predisposing cause of cauda equina syndrome in German Shepherd dogs: 161 cases (1987–1990). *Journal of the American Veterinary Medical Association*, **202**, 1877–1882
- Morgan, J.P., Wind, A. and Davidson, A.P. (2000) *Hereditary Bone and Joint Diseases in the Dog*. Schlütersche, Hanover
- Morgan, K.L. and Tuppen, A.T.A. (1988) Sheep health, productivity, and the IBM PC. In: *The Research and Academic Users' Guide to the IBM Personal Computer*. Ed. Barnetson, P., pp. 147–153. Oxford University Press, Oxford
- Morgan, M.G. and Henrion, M. (1990) *Uncertainty: a Guide to Dealing with Uncertainty in Quantitative Risk and Policy Analysis*. Cambridge University Press, Cambridge
- Moriello, K.A. and Mason, I.S. (1995) *Handbook of Small Animal Dermatology*. Pergamon, Oxford
- Morley, F.H.W., Watt, B.R., Grant, I.McL. and Galloway, D.B. (1983) A flock health and production program for sheep. In: Proceedings of the Third International Symposium on Veterinary Epidemiology and Economics. Arlington, Virginia, 6–10 September 1982, pp. 186–194. Veterinary Medical Publishing Company, Edwardsville
- Morley, P.S., Townsend, H.G.G., Bogdan, J.R. and Haines, D.M. (2000) Risk factors for disease associated with influenza virus infections during three epidemics in horses. *Journal of the American Veterinary Medical Association*, **4**, 545–550
- Morley, R.S. (1988) National Animal Health Information System, Agriculture Canada. *Revue Scientifique et Technique, Office International des Epizooties*, **7**, 577–581
- Morley, R.S. (Coordinator) (1993) Risk analysis, animal health and trade. *Revue Scientifique et Technique, Office International des Epizooties*, **12**, 1001–1362
- Morley, R.S. (1993a) A model for the assessment of the animal disease risks associated with the importation of animals and animal products. *Revue Scientifique et Technique, Office International des Epizooties*, **12**, 1055–1092
- Morley, R.S. and Hugh-Jones, M.E. (1989) The effect of management and ecological factors on the epidemiology of anaplasmosis in the Red River Plains and south-east areas of Louisiana. *Veterinary Research Communications*, **13**, 359–369
- Morris, D.D., Moore, J.N. and Ward, S. (1989) Comparison of age, sex, breed, history and management in 229 horses with colic. *Equine Veterinary Journal*, Suppl. 7, 129–132
- Morris, J. (Ed.) (1976) *Domesday Book*. 34 vols. Phillimore, Chichester. (Originally published at Winchester in 1086 as the *Liber de Wintonia*)
- Morris, J.G., Rogers, Q.R. and Fascetti, A.J. (2005) Nutrition of healthy dogs and cats in various stages of adult life. In: *Textbook of Veterinary Internal Medicine. Diseases of the Dog and Cat*, 6th edn. Vol. 1. Eds Ettinger, S.J. and Feldman, E.C., pp. 555–560. Elsevier/Saunders, St Louis
- Morris, M.P. and Fletcher, O.J. (1988) Estimate of economic impact of fowl cholera in turkeys in Georgia in 1986. *Avian Diseases*, **32**, 718–721
- Morris, R.S. (1969) Assessing the economic value of veterinary services to primary industries. *Australian Veterinary Journal*, **45**, 295–300
- Morris, R.S. (1982) New techniques in veterinary epidemiology – providing workable answers to complex problems. In: *Epidemiology in Animal Health*. Proceedings of a symposium held at the British Veterinary Association's Centenary Congress, Reading, 22–25 September 1982, pp. 1–16. Society for Veterinary Epidemiology and Preventive Medicine
- Morris, R.S. and Dijkhuizen, A.A. (Eds) (1997) *Animal Health Economics: Principles and Applications*. Postgraduate Foundation in Veterinary Science, University of Sydney, Sydney
- Morris, R.S., Sanson, R.L. and Stern, M.W. (1992) EpiMAN – a decision support system for managing a foot-and-mouth disease epidemic. In: Dutch Society for Veterinary Epidemiology and Economy. Proceedings, 5, Wageningen, 9 December 1992. Eds Frankena, K. and van der Hoofd, C.M., pp. 1–35
- Morris, R.S., Sanson, R.L., McKenzie, J.S. and Marsh, W.E. (1993) Decision support systems in animal health. In: Society for Veterinary Epidemiology and Preventive Medicine, Proceedings, Exeter, 31 March–2 April 1993. Ed. Thrusfield, M.V., pp. 188–199
- Morris, R.S., Wilesmith, J.W., Stern, M.W., Sanson, R.L. and Stevenson, M.A. (2001) Predictive spatial modelling of alternative control strategies for the foot-and-mouth disease epidemic in Great Britain, 2001. *Veterinary Record*, **149**, 137–144
- Morrow, D.A. (1980) Examination schedule for a dairy reproductive health programme. In: *Current Therapy in Theriogenology*, Ed. Morrow, D.A., pp. 549–562. W.B. Saunders, Philadelphia
- Morse, S.S. (1995) Factors in the emergence of infectious diseases. *Emerging Infectious Diseases*, **1**, 7–15
- Mortensen, S. and Madsen, K. (1992) The occurrence of PRRS in Denmark. *American Association of Swine Practitioners Newsletter*, **4** (4), 48
- Mortensen, S., Stryhn, H., Søgaard, R., Boklund, A., Stärk, K.D.C., Christensen, J. and Willeberg, P. (2002) Risk factors for infection of sow herds with porcine reproductive and respiratory syndrome (PRRS) virus. *Preventive Veterinary Medicine*, **53**, 83–101
- Morton, D. (1992) Docking of dogs: practical and ethical aspects. *Veterinary Record*, **131**, 301–306
- Morton, N.E. (1982) *Outline of Genetic Epidemiology*. Karger, New York
- Moss, N., Lean, I.J., Reid, S.W.J. and Hodgson, D.R. (2002) Risk factors for repeat-breeder syndrome in New South Wales dairy cows. *Preventive Veterinary Medicine*, **54**, 91–103
- Moss, R. (Coordinator) (1994) Animal welfare and veterinary services. *Revue Scientifique et Technique, Office International des Epizooties*, **13**, 1–302
- Mossel, D.A.A. (1989) Adequate protection of the public against food-transmitted diseases of microbial aetiology. Achievements and challenges, half a century after the introduction of the Prescott–Meyer–Wilson strategy of active intervention. *International Journal of Food Microbiology*, **9**, 271–194

- Moulder, J.W. (1974) Intracellular parasitism: life in an extreme environment. *Journal of Infectious Diseases*, **130**, 300–306
- Moulton, J.E., Taylor, D.O.N., Dorn, C.R. and Andersen, A.C. (1970) Canine mammary tumors. *Pathologia Veterinaria*, **7**, 289–320
- Mousing, J. (1988) The Danish Pig Health Scheme: a questionnaire survey and analysis of swine producers' attitudes and willingness to pay. *Preventive Veterinary Medicine*, **6**, 157–170
- Mousing, J., Lybye, H., Barfod, K., Meyling, A., Ronsholt, L. and Willeberg, P. (1990) Chronic pleuritis in pigs for slaughter: an epidemiological study of infections and rearing system-related risk factors. *Preventive Veterinary Medicine*, **9**, 107–119
- Mousing, J., Mortensen, S., Ewald, C. and Christensen, L.S. (1991) Epidemiological and meteorological aspects of Aujeszky's disease in Denmark and Northern Germany. In: Society for Veterinary Epidemiology and Preventive Medicine, Proceedings, London, 17–19 April 1991, Ed. Thrusfield, M.V., pp. 18–26
- Mouttotou, N. and Green, L.E. (1999) Incidence of foot and skin lesions in nursing piglets and their association with behavioural activities. *Veterinary Record*, **145**, 160–165
- Mouttotou, N., Hatchell, F.M. and Green, L.E. (1998) Adventitious bursitis of the hock in finishing pigs: prevalence, distribution and association with floor type and foot lesions. *Veterinary Record*, **142**, 109–114
- Mouttotou, N., Hatchell, F.M. and Green, L.E. (1999a) Prevalence and risk factors associated with adventitious bursitis in live growing and finishing pigs in south-west England. *Preventive Veterinary Medicine*, **39**, 39–52
- Mouttotou, N., Hatchell, F.M. and Green, L.E. (1999b) The prevalence and risk factors associated with forelimb skin abrasions and sole bruising in preweaning piglets. *Preventive Veterinary Medicine*, **39**, 231–245
- Moxley, J.E., Kennedy, B.W., Downey, B.R. and Bowman, J.S.T. (1978) Survey of milking hygiene practices and their relationships to somatic cell counts and milk production. *Journal of Dairy Science*, **61**, 1637–1644
- MRC (1938) *Epidemics in Schools. An Analysis of the Data Collected during the First Five Years of a Statistical Inquiry by the Schools Epidemic Committee*. Medical Research Council Special Report Series. No. 227. His Majesty's Stationery Office, London
- Mtambo, M.M.A., Nash, A.S., Blewett, D.A., Smith, H.V. and Wright, S. (1991) Cryptosporidium infection in cats: prevalence of infection in domestic and feral cats in the Glasgow area. *Veterinary Record*, **129**, 502–504
- Muench, H. (1959) *Catalytic Models in Epidemiology*. Harvard University Press, Cambridge, Massachusetts
- Mugunieri, G.L., Irungu, P. and Omiti, J.M. (2004) Performance of community-based animal health workers in the delivery of livestock health services. *Tropical Animal Health and Production*, **36**, 523–535
- Muirhead, M.R. (1976) Veterinary problems of intensive pig husbandry. *Veterinary Record*, **99**, 288–292
- Muirhead, M.R. (1978) Intensive pig production: studies in preventive medicine. Fellowship Thesis, Royal College of Veterinary Surgeons
- Muirhead, M.R. (1980) The pig advisory visit in preventive medicine. *Veterinary Record*, **106**, 170–173
- Mukasa-Mugerwa, E., Said, A.N., Lahlou-Kassi, A., Sherington, J. and Mutiga, E.R. (1994) Birth weight as a risk factor for perinatal lamb mortality, and the effects of stage of pregnant ewe supplementation and gestation weight gain in Ethiopian Menz sheep. *Preventive Veterinary Medicine*, **19**, 45–46
- Mulder, C.A.T., Bonnett, B.N., Martin, S.W., Lissemore, K. and Page, P.D. (1994) The usefulness of the computerized medical records of one practice for research into pregnancy loss in dairy cows. *Preventive Veterinary Medicine*, **21**, 43–63
- Mulhern, F.J., Mott, L.O., Shahan, M.S. and Anderson, R.G. (1962) Eradication of animal diseases. In: *After a Hundred Years*, The Yearbook of Agriculture 1962, pp. 313–320. US Government Printing Office, Washington
- Müller, W.W. (1991) New areas of oral fox vaccination in Europe, 1991. *Rabies Bulletin Europe*, **15** (3), 11–12. WHO Collaborating Centre for Rabies Surveillance and Research, Tübingen
- Mulvihill, J.J. and Priester, W.A. (1973) Congenital heart disease in dogs: epidemiologic similarities to man. *Teratology*, **7**, 73–78
- Münch, R. (2003) Robert Koch. *Microbes and Infection*, **5**, 79–74
- Muñoz-Zanzi, C.A., Hietala, S.K., Thurmond, M.C. and Johnson, W.O. (2003) Quantification, risk factors, and health impact of natural congenital infection with bovine viral diarrhoea virus in dairy calves. *American Journal of Veterinary Research*, **64**, 358–365
- Munro, H.M.C. and Thrusfield, M.V. (2001a) 'Battered pets': features that raise suspicion of non-accidental injury. *Journal of Small Animal Practice*, **42**, 218–226
- Munro, H.M.C. and Thrusfield, M.V. (2001b) 'Battered pets': non-accidental physical injuries found in dogs and cats. *Journal of Small Animal Practice*, **42**, 279–290
- Munro, H.M.C. and Thrusfield, M.V. (2001c) 'Battered pets': Munchausen syndrome by proxy (factitious illness by proxy). *Journal of Small Animal Practice*, **42**, 385–389
- Munro, H.M.C. and Thrusfield, M.V. (2001d) 'Battered pets': sexual abuse. *Journal of Small Animal Practice*, **42**, 333–337
- Munroe, F.A., Dohoo, I.R., McNab, W.B. and Spangler, L. (1999) Risk factors for the between-herd spread of *Mycobacterium bovis* in Canadian cattle and cervids between 1985 and 1994. *Preventive Veterinary Medicine*, **41**, 119–133
- Munson, L. and Cook, R.A. (1993) Monitoring, investigation and surveillance of diseases in captive wildlife. *Journal of Zoo and Wildlife Medicine*, **24**, 281–290
- Murphy, A.M. and Dobson, H. (2002) Predisposition, subsequent fertility, and mortality of cows with uterine prolapse. *Veterinary Record*, **151**, 733–735
- Murphy, B.R. and Webster, R.G. (1990) Orthomyxoviruses. In: *Virology*, Vol. 1. Eds Fields, B.N. and Knipe, D.M., pp. 1091–1152. Raven Press, New York
- Murray, A., Moriarty, K.M. and Scott, D.B. (1989) A cloned DNA probe for the detection of *Mycobacterium paratuberculosis*. *New Zealand Veterinary Journal*, **37**, 47–50
- Murray, J. (1968) Some aspects of ovicaprid and pig breeding in neolithic Europe. In: *Studies in Ancient Europe. Essays Presented to Stuart Piggott*. Eds Coles, J.M. and Simpson, D.D.A., pp. 71–81. Leicester University Press, Leicester

- Murray, J.K., Singer, E.R., Saxby, F. and French, N.P. (2004a) Factors influencing risk of injury to horses falling during eventing. *Veterinary Record*, **154**, 207–208
- Murray, J.K., Singer, E.R., Morgan, K.L., Proudman, C.J. and French, N.P. (2004b) Towards reducing injury to horse and rider in eventing: A case-control study. In: Society for Veterinary Epidemiology and Preventive Medicine, Proceedings, Martigny, Switzerland, 24–26 March 2004. Eds Reid, S.W.J., Menzies, F.D. and Russell, A.M., pp. 50–61
- Murray, N., MacDiarmid, S.C., Wooldridge, M., Gummow, B., Morley, R.S., Weber, S.E., Giovannini, A. and Wilson, D. (2004c) *Handbook on Import Risk Analysis for Animals & Animal Products, Volume I. Introduction and qualitative risk analysis*. Office International des Epizooties, Paris
- Murray, N., MacDiarmid, S.C., Wooldridge, M., Gummow, B., Morley, R.S., Weber, S.E., Giovannini, A. and Wilson, D. (2004d) *Handbook on Import Risk Analysis for Animals & Animal Products, Volume II. Quantitative risk analysis*. Office International des Epizooties, Paris
- Murray, K., Selleck, P., Hooper, P., Hyatt, A., Gould, A., Gleeson, L., Westbury, H., Wiley, L., Selvey, L., Rodwell, B. and Ketterer, P. (1995) A morbillivirus that caused fatal disease in horses and humans. *Science*, **268**, 94–97
- Murray, M.J., Schusser, G.F., Pipers, F.S. and Gross, S.J. (1996) Factors associated with gastric lesions in Thoroughbred racehorses. *Equine Veterinary Journal*, **28**, 368–374
- Murray, N. (2002) *Import Risk Analysis: Animals and Animal Products*. Ministry of Agriculture and Forestry, Wellington
- Murray, R.D., Downham, D.Y., Demirhan, I. and Carter, S.D. (2002) Some relationships between spirochaete infections and digital dermatitis in four UK dairy herds. *Research in Veterinary Science*, **73**, 223–230
- Mussman, H.C., McCallon, W.R. and Otte, E. (1980) Planning and implementation of animal disease control programs in developing countries. In: *Veterinary Epidemiology and Economics*. Proceedings of the second international symposium, Canberra, 4–11 May 1979. Eds Geering, W.A., Roe, R.T. and Chapman, L.A., pp. 551–557. Australian Government Publishing Service, Canberra
- Myers, J.H. (1988) Can a general hypothesis explain population cycles of forest Lepidoptera? *Advances in Ecological Research*, Vol. 18. Eds Begon, M., Fitter, A.H., Ford, E.D. and Macfadyen, A., pp. 179–242. Academic Press, London
- Nakayachi, K. (1998) How do people evaluate risk reduction when they are told zero risk is impossible? *Risk Analysis*, **18**, 235–242
- Nam, J. (1995) Confidence limits for the ratio of two binomial proportions based on likelihood scores: non-iterative method. *Biometrics Journal*, **37**, 375–379
- NAMP (2004) National Arbovirus Monitoring Program. <http://www.namp.com.au>. (Accessed 8 November 2004)
- Nardelli, L., Lodetti, E., Gualandi, G.L., Burrows, R., Goodridge, D., Brown, F. and Cartwright, B. (1968) A foot-and-mouth disease syndrome in pigs caused by an enterovirus. *Nature*, **219**, 1275–1276
- Nash, D., Mostashari, F., Fine, A., Miller, J.D., O'Leary, D., Murray, K., Huang, A., Rosenberg, A., Greenberg, A., Sherman, M., Wong, S. and Layton, M. (2001) The outbreak of West Nile virus infection in the New York City area in 1999. *New England Journal of Medicine*, **344**, 1807–1814
- Nash, M.L., Hungerford, L.L., Nash, T.G. and Zinn, G.M. (1995) Epidemiology and economics of clinical listeriosis in a sheep flock. *Preventive Veterinary Medicine*, **24**, 147–156
- Nasser, R. and Mosier, J.E. (1980) Canine population dynamics: a study of the Manhattan, Kansas, canine population. *American Journal of Veterinary Research*, **41**, 1798–1803
- Nasser, R. and Mosier, J.E. (1982) Feline population dynamics: a study of the Manhattan, Kansas, feline population. *American Journal of Veterinary Research*, **43**, 167–170
- Nasser, R., Mosier, J.E. and Williams, L.W. (1984) Study of the canine and feline populations in the Greater Las Vegas area. *American Journal of Veterinary Research*, **45**, 282–287
- Naylor, C.D. (1989) Meta-analysis of controlled clinical trials. *Journal of Rheumatology*, **16**, 424–426
- NCAHP (2004) National Center for Animal Health Programs: Swine Brucellosis Surveillance Standards. <http://www.aphis.usda.gov/vs/naahps/surveillance/brucellasuis.html> (Accessed 7 November 2004)
- NDFAS (2004) The National Dairy Farm Assured Scheme. <http://www.ndfas.org.uk> (Accessed 11 March 2004)
- Neaton, J.D., Duchene, A.G., Svendsen, K.H. and Wentworth, D. (1990) Examination of the efficiency of some quality assurance methods commonly employed in clinical trials. *Statistics in Medicine*, **9**, 115–124
- Nebbia, C. (2001) Biotransformation enzymes as determinants of xenobiotic toxicity in domestic animals. *The Veterinary Journal*, **161**, 238–252
- Neitz, W.O. (1948) Immunological studies on bluetongue in sheep. *Onderstepoort Journal of Veterinary Science*, **23**, 93–135
- Nelson, A.W. and White, L.K. (1990) Medical Records. In: *Clinical Textbook for Veterinary Technicians*, 2nd edn. Ed. McCurnin, D.M., pp. 43–55. W.B. Saunders, Philadelphia
- Newcombe, H.B. (1964) Session VII discussion In: *Second International Conference on Congenital Malformations*. Papers and Discussions Presented at the Second International Conference on Congenital Malformations, New York City, 14–19 July 1963, pp. 345–349. International Medical Congress, New York
- Newell, K.W., Ross, A.D. and Renner, R.M. (1984) Phenoxy and picolinic acid herbicides and small intestinal adenocarcinoma in sheep. *Lancet*, **ii**, 1301–1305
- Newton, J.R., Wood, J.L.N. and Chanter, N. (2003) A case control study of factors and infections associated with clinically apparent respiratory disease in UK Thoroughbred racehorses. *Preventive Veterinary Medicine*, **60**, 107–132
- Newton, J.R., Hedderson, E.J., Adams, V.J., McGorum, B.C., Proudman, C.J. and Wood, J.L.N. (2004) An epidemiological study of risk factors associated with the recurrence of equine grass sickness (dysautonomia) on previously affected premises. *Equine Veterinary Journal*, **36**, 105–112
- Nicholas, F.W. (1987) *Veterinary Genetics*. Oxford University Press, Oxford
- Nicholas, F.W. (2003) *Introduction to Veterinary Genetics*, 2nd edn. Blackwell Publishing, Oxford
- Nicholls, T.J., Barton, M.G. and Anderson, B.P. (1981) An outbreak of mastitis in dairy cows due to *Pseudomonas*



- aeruginosa* contamination of dry-cow therapy at manufacture. *Veterinary Record*, **108**, 93–96
- Nicod, F., Coche, B., Desjouis, G. and Benet, J.J. (1991) Foot-and-mouth disease vaccine-related accidents in France in 1985: retrospective study by practitioners. In: Proceedings of the Sixth International Symposium on Veterinary Epidemiology and Economics, Ottawa, 12–16 August 1991. Ed. Martin, S.W., pp. 323–326
- Niezen, J.H., Charleston, W.A.G., Hodgson, J., Mackay, A.D. and Leatherwick, D.M. (1996) Controlling internal parasites in grazing ruminants without recourse to anthelmintics: approaches, experiences and prospects. *International Journal for Parasitology*, **26**, 983–992
- Nightingale, P. and Martin, P. (2004) The myth of the biotech revolution. *Trends in Biotechnology*, **22**, 564–569
- Niskanen, M. and Thrusfield, M.V. (1998) Associations between age, parity, hormonal therapy, breed, and pyometra in Finnish Dogs. *Veterinary Record*, **143**, 493–498
- Noack, H. (1987) Concepts of health and health promotion. In: *Measurement in Health Promotion and Protection*. Eds Abelin, T., Brzezinski, Z.J. and Carstairs, V.D.L., pp. 5–28. World Health Organization Regional Office for Europe, Copenhagen
- Nokes, J.D. (1992) Microparasites: viruses and bacteria. In: *Natural Enemies: the Population Biology of Predators, Parasites and Diseases*. Ed. Crawley, M.J., pp. 349–374. Blackwell Scientific Publications, Oxford
- Noordhuizen, J.P.T.M. (2000) Preventive medicine practice and quality assurance through HACCP. In: Society for Veterinary Epidemiology and Preventive Medicine, Proceedings, Edinburgh, 29–31 March 2000. Eds Thrusfield, M.V. and Goodall, E.A., pp. 37–45
- Noordhuizen, J.P.T.M. and Buurman, J. (1984) Veterinary automated management and production control programme for dairy herds (VAMPP). The application of MUMPS for data processing. *The Veterinary Quarterly*, **6**, 62–77
- Noordhuizen, J.P.T.M. and Dufour, B. (2001) Monitoring and surveillance systems (MOSS): design and operationalization. In: *Application of Quantitative Methods in Veterinary Epidemiology*, revised reprint. Eds Noordhuizen, J.P.T.M., Frankena, K., Thrusfield, M.V. and Graat, E.A.M., pp. 367–381. Wageningen Pers, Wageningen
- Noordhuizen, J.P.T.M., Frankena, K., Ploeger, H. and Nell, T. (Eds) (1993) *Field Trial and Error*. Proceedings of the international seminar with workshops on the design, conduct and interpretation of field trials, Bergen Dal, Netherlands, 27–28 April 1993. Epidecon, Wageningen
- Noordhuizen, J.P.T.M. and Frankena, K. (1999) Epidemiology and quality assurance: applications at farm level. *Preventive Veterinary Medicine*, **39**, 93–110
- Nordenstam, T. and Tornebohm, H. (1979) Research, ethics and development. *Zeitschrift für Allgemeine Wissenschaftstheorie*, **10**, 54–66
- Norström, M., Skjerve, E. and Jarp, J. (2000) Risk factors for epidemic respiratory disease in Norwegian cattle herds. *Preventive Veterinary Medicine*, **44**, 87–96
- Norton-Griffiths, M. (1978) *Counting Animals*, 2nd edn. African Wildlife Leadership Foundation, Nairobi
- Nørrung, B. (2006) Risk assessment of *Campylobacter* in poultry. In: *Integrated Food Safety and Veterinary Public Health*. Buncic, A., pp. 365–370. CABI, Wallingford
- Notturmo, M. (1999) *Science and the Open Society: The Future of Karl Popper's Philosophy*. Central European University Press, Budapest
- Nunn, F., Cave, T.A., Knottenbelt, C. and Poxton, I.R. (2004) Association between Key-Gaskell syndrome and infection by *Clostridium botulinum* type C/D. *Veterinary Record*, **155**, 111–115
- Nurmi, E. (1988) Modern methods of public health practice: exclusion of food-borne pathogens. *Acta Veterinaria Scandinavica*, Suppl. 84, 49–56
- Nyaga, P.N.N. (1975) Epidemiology of equine influenza: risk by age, breed and sex. MPVM Thesis. University of California, Davis
- O'Brien, D.J., Kaneene, J.B., Getis, A., Lloyd, J.W., Rip, M.R. and Leader, R.W. (1999) Spatial and temporal distribution of selected canine cancers in Michigan, USA, 1964–1994. *Preventive Veterinary Medicine*, **42**, 1–15
- Obuchowski, N.A. (1998) Sample size calculations in studies of test accuracy. *Statistics in Medicine*, **7**, 371–392
- O'Connor, A., Wayne Martin, S., Nagy, E., Menzies, P. and Harland, R. (2001a) The relationship between the occurrence of undifferentiated bovine respiratory disease and titer changes to *Haemophilus somnus* and *Mannheimia haemolytica* at 3 Ontario feedlots. *The Canadian Journal of Veterinary Research*, **65**, 143–150
- O'Connor, A., Wayne Martin, S., Nagy, E., Menzies, P. and Harland, R. (2001b) The relationship between the occurrence of undifferentiated bovine respiratory disease and titer changes to bovine coronavirus and bovine viral diarrhoea in 3 Ontario feedlots. *The Canadian Journal of Veterinary Research*, **65**, 137–142
- Odend'hal, S. (1983) *The Geographical Distribution of Animal Viral Diseases*. Academic Press, New York and London
- O'Driscoll, J.G., Troy, P.T. and Geoghegan, F.J. (1977) An epidemic of venereal infection in Thoroughbreds. *Veterinary Record*, **101**, 359–360
- Ogundipe, G.A.T., Oluokun, S.B. and Esuroso, G.G. (1989) The development and efficiency of the national animal health information system in Nigeria. *Preventive Veterinary Medicine*, **7**, 121–135
- OIE (1987) *Procedures for Immediate and Monthly Reporting of Significant Disease Outbreaks to the Office International des Epizooties. Guidelines*. Office International des Epizooties, Paris
- OIE (1992) *International Animal Health Code: Mammals, Birds and Bees*, 6th edn. Office International des Epizooties, Paris
- OIE (1993) Biotechnology applied to the diagnosis of animal diseases. *Revue Scientifique et Technique, Office International des Epizooties*, **12**, 1–672
- OIE (1997) *International Animal Health Code. Special Edition*. Office International des Epizooties, Paris
- OIE (1998) Genetic resistance to animal diseases. *Revue Scientifique et Technique, Office International des Epizooties*, **17**, 1–329
- OIE (2002) *International Animal Health Code: Mammals, Birds and Bees*, 11th edn. Office International des Epizooties, Paris
- OIE (2003) Rinderpest in Kenya. *Office International des Epizooties, Disease Information*, Vol. 16, No. 43
- OIE (2004) *Handbook on Import Risk Analysis for Animals and Animal Products*. 2 vols. Office International des Epizooties, Paris



- Olafson, P., MacCallum, A.D. and Fox, F.H. (1946) An apparently new transmissible disease of cattle. *Cornell Veterinarian*, **36**, 205–213
- Oldstone, M.B. (1998) Viral persistence: mechanisms and consequences. *Current Opinion in Microbiology*, **1**, 438–441
- Ollerenshaw, C.B. (1966) The approach to forecasting the incidence of fascioliasis over England and Wales, 1958–1962. *Agricultural Meteorology*, **3** (1/2), 35–54
- Ollerenshaw, C.B. and Rowlands, W.T. (1959) A method of forecasting the incidence of fascioliasis in Anglesey. *Veterinary Record*, **71**, 591–598
- Olson, N.O. (1950) A respiratory disease (bronchitis) of quail caused by a virus. *Proceedings of the United States Livestock Sanitary Association*, **54**, 171–174
- Olsson, H., Moller, T.R. and Ronstan, J. (1989) Oral contraceptive use and breast cancer among premenopausal women: final report from a study in Southern Sweden. *Journal of the National Cancer Institute*, **81**, 1000–1004
- Oltenu, P.A., Bendixen, P.H., Vilson, B. and Ekesbo, I. (1988) Evaluation of the tramped teats–clinical mastitis disease complex. Risk factors and interrelationships with other diseases. In: *Environment and Animal Health*. Proceedings of the 6th International Congress on Animal Hygiene, 14–17 June 1988, Skara, Sweden, Vol. 1. Ed. I. Ekesbo, pp. 46–50, Swedish University of Agricultural Sciences, Skara
- Oltenu, P.A., Frick, P. and Lindhe, B. (1990) Epidemiological study of several clinical diseases, reproductive performance and culling in primiparous Swedish cattle. *Preventive Veterinary Medicine*, **9**, 59–74
- Omer, M.K., Skjerve, E., Woldehiwet, Z. and Holstad, G. (2000) Risk factors for *Brucella* spp. infection in dairy cattle farms in Asmara, State of Eritrea. *Preventive Veterinary Medicine*, **46**, 257–265
- Omori, T., Inaba, Y., Morimoto, T., Tanaka, Y., Ishitani, R., Kurogi, H., Munakata, K., Matsuda, K. and Matumoto, M. (1969) Ibaraki virus, an agent of epizootic disease of cattle resembling bluetongue. I. Epidemiologic, clinical and pathologic observations and experimental transmission to calves. *Japanese Journal of Microbiology*, **13**, 139–157
- Opit, L.J. (1987) How should information on health care be generated and used? *World Health Forum*, **8**, 409–417. (Discussion: 417–438)
- Oppenheim, A.N. (1992) *Questionnaire Design, Interviewing and Attitude Measurement*. Pinter, London
- Orr, M.B. and Chalmers, M. (1988) A field study of the association between periodontal disease and body condition in sheep. *New Zealand Veterinary Journal*, **36**, 171–172
- Oscar, T. (1998) The development of a risk assessment model for use in the poultry industry. *Journal of Food Safety*, **18**, 371–381
- Østerås, O. and Edge, V.L. (2000) Factors prior to dry period associated with high and low levels of cow milk somatic cell counts in next lactation. *Acta Veterinaria Scandinavica*, **41**, 63–77
- Osteras, O. and Lund, A. (1988a) Epidemiological analyses of the associations between bovine udder health and housing. *Preventive Veterinary Medicine*, **6**, 79–90
- Osteras, O. and Lund, A. (1988b) Epidemiological analyses of the associations between bovine udder health and milking machine and milking management. *Preventive Veterinary Medicine*, **6**, 91–108
- Osterhaus, A. (Ed.) (1994) *Virus Infections of Vertebrates, Vol. 5. Virus Infections of Rodents and Lagomorphs*. Elsevier, Amsterdam
- Osterhaus, A., van de Bilt, M., Vedder, L., Martina, B., Niesters, H., Kotomatas, S. et al. (1998) Monk seal mortality: virus or toxin? *Vaccine*, **16**, 979–981
- Osterhaus, A.D.M.E. and Vedder, E.J. (1988) Identification of virus causing recent seal deaths. *Nature*, **335**, 20
- Otake, S., Dee, S.A., Rossow, K.D., Joo, H.S., Deen, J., Molitor, T.W. and Pijoan, C. (2002) Transmission of porcine reproductive and respiratory syndrome virus by needles. *Veterinary Record*, **150**, 114–115
- Ott, S.L., Johnson, R. and Wells, S.J. (2003) Association between bovine-leukosis virus seroprevalence and herd-level productivity on US dairy farms. *Preventive Veterinary Medicine*, **61**, 249–262
- Otte, M.J. and Gumm, I.D. (1997) Intra-cluster correlation coefficients of 20 infections calculated from the results of cluster-sample surveys. *Preventive Veterinary Medicine*, **31**, 147–150
- Ouelett, B.L., Romeder, J.M. and Lance, J.M. (1979) Premature mortality attributable to smoking and hazardous drinking in Canada. *American Journal of Epidemiology*, **109**, 451–463
- Overgaauw, P.A.M. (1996) Effect of a government educational campaign in the Netherlands on awareness of *Toxocara* and toxocarosis. *Preventive Veterinary Medicine*, **28**, 165–174
- Owen, J.M. (1985) Preventive medicine in stud and stable. In: *Society for Veterinary Epidemiology and Preventive Medicine, Proceedings, Reading, 27–29 March 1985*. Ed. Thrusfield, M.V., pp. 56–60
- Owen, M. (1989) *SPC and Continuous Improvement*. IFS Publications/Springer-Verlag, Berlin
- Oxford English Dictionary (1971) *The Compact Edition of the Oxford English Dictionary*, 2 vols. Oxford University Press, Oxford
- Oxford, J.S. (1985) Biochemical techniques for the genetic and phenotypic analysis of viruses: 'Molecular Epidemiology'. *Journal of Hygiene, Cambridge*, **94**, 1–7
- Page, E.S. (1961) Cumulative sum charts. *Technometrics*, **3**, 1–9
- Page, S., Davenport, M. and Hewitt, A. (1991) *The GATT Uruguay Round: Effects on Developing Countries*. Overseas Development Institute, London
- Pancieria, D.L., Thomas, C.B., Eicker, S.W. and Atkins, C.E. (1990) Epizootiologic patterns of diabetes mellitus in cats: 333 cases (1980–1986). *Journal of the American Veterinary Medical Association*, **197**, 1504–1508
- Pang, J., Modlin, J. and Yolken, R. (1992) Use of modified nucleotides and uracil-DNA glycosylase (UNG) for the control of contamination in the PCR-based amplification of RNA. *Molecular and Cellular Probes*, **6**, 251–256
- Panthier, R. (1968) Épidémiologie du virus West Nile. Étude d'un foyer en Camargue. I. Introduction. *Annales de l'Institut Pasteur*, **114**, 518–520
- Pappaioanou, M. (2004) Veterinary medicine protecting and promoting the public's health and well-being. *Preventive Veterinary Medicine*, **62**, 153–163

- Pappaioanou, M., Schwabe, C.W. and Polydorou, K. (1984) Epidemiological analysis of the Cyprus anti-echinococcosis campaign I. The prevalence of *Echinococcus granulosus* in Cypriot village dogs, the first dog-test period of the campaign, June–December, 1972. *Preventive Veterinary Medicine*, **3**, 159–180
- Pappalardo, B.L., Correa, M.T., York, C.C., Peat, C.Y. and Breitschwerdt, E.B. (1997) Epidemiologic evaluation of the risk factors associated with exposure and seroreactivity to *Bartonella vinsonii* in dogs. *American Journal of Veterinary Research*, **58**, 467–471
- Paraf, A. and Peltre, G. (1991) *Immunoassays in Food and Agriculture*. Kluwer Academic Publishers, Dordrecht
- Parente, E.J., Richardson, D.W. and Spencer, P. (1993) Basal sesamoid fractures in horses: 57 cases (1980–91). *Journal of the American Veterinary Medical Association*, **202**, 1293–1297
- Park, P. (1989) What is participatory research? A theoretical and methodological perspective. In: *Voices of Change: Participatory Research in the United States and Canada*. Eds Park, P., Brydon-Miller, M., Hall, B. and Jackson, T., pp. 1–19. Bergin and Garvey, Westport
- Park, Y.G., Gordon, J.G., Bech-Nielsen, S. and Slemonds, R.D. (1992) Factors for seropositivity to leptospirosis in horses. *Preventive Veterinary Medicine*, **13**, 121–127
- Parker, G.A., Stedham, M.A. and Van Dellen, A. (1977) Myocarditis of probable viral origin in chickens. *Avian Diseases*, **21**, 123–132
- Parkin, T.D.H., Clegg, P.D., French, N.P., Proudman, C.J., Riggs, C.M., Singer, E.R., Webbon, P.M. and Morgan, K.L. (2003) Analysis of horse race videos to identify risk factors for fatal distal limb fracture. In: Society for Veterinary Epidemiology and Preventive Medicine, Proceedings, 31 March–2 April 2003, Warwick. Eds Reid, S.W.J. and Menzies, F.D., pp. 132–143
- Parkin, T.D.H., Clegg, P.D., French, N.P., Proudman, C.J., Riggs, C.M., Singer, E.R., Webbon, P.M. and Morgan, K.L. (2004) Risk of fatal distal limb fractures among thoroughbreds involved in the five types of racing in the United Kingdom. *Veterinary Record*, **154**, 493–497
- Parsons, J.H. (1982) Funding of control measures. In: *The Control of Infectious Diseases in Farm Animals*. British Veterinary Association Trust Project on the future of animal health control, London, pp. 58–62
- Pascoe, P.J., McDonnell, W.N., Trim, C.M. and van Gorder, J. (1983) Mortality rates and associated factors in equine colic operations – a retrospective study of 341 operations. *Canadian Veterinary Journal*, **24**, 76–85
- Paston-Williams, S. (1993) *The Art of Dining. A History of Cooking and Eating*. The National Trust, London
- Pastoret, P.-P. and Brochier, B. (1998) Epidemiology and elimination of rabies in Western Europe. *The Veterinary Journal*, **156**, 83–90
- Pastoret, P.-P., Thiry, E., Brochier, B., Schwers, A., Thomas, I. and Dubuisson, J. (1988) Diseases of wild animals transmissible to domestic animals. *Revue Scientifique et Technique, Office International des Epizooties*, **7**, 705–736
- Pastoret, P.-P., Blancou, J., Vannier, P. and Verschuere, C. (Eds) (1997) *Veterinary Vaccinology*. Elsevier, Amsterdam
- Paterson, A.D. (1995) Problems encountered in the practical implementation of geographical information systems (GIS) in veterinary epidemiology. In: Society for Veterinary Epidemiology and Preventive Medicine, Proceedings, Reading, 29–31 March 1995. Ed. Goodall, E.A., pp. 162–171
- Paterson, A.D., Otte, M.J., Slingenbergh, J., Wint, W. and Rogers, D. (2000) The application of GIS and remote sensing based modelling techniques, for use in the economic and epidemiological assessment of disease control interventions, at a regional or national level. In: Society for Veterinary Epidemiology and Preventive Medicine, Proceedings, Edinburgh, 29–31 March 2000. Eds Thrusfield, M.V. and Goodall, E.A., pp. 172–182
- Paton, G. and Gettinby, G. (1983) The control of a parasitic nematode population in sheep represented by a discrete time network with stochastic inputs. *Proceedings of the Royal Irish Academy*, **83B**, 267–280
- Paton, G. and Gettinby, G. (1985) Comparing control strategies for parasitic gastro-enteritis in lambs grazed on previously contaminated pasture: a network modelling approach. *Preventive Veterinary Medicine*, **3**, 301–310
- Paton, G., Thomas, R.J. and Waller, P.J. (1984) A prediction model for parasitic gastro-enteritis in lambs. *International Journal of Parasitology*, **14**, 439–445
- Patronek, G.J., Glickman, L.T., Beck, A.M., McCabe, G.P. and Ecker, C. (1996a) Risk factors for relinquishment of dogs to an animal shelter. *Journal of the American Veterinary Association*, **209**, 572–581
- Patronek, G.J., Glickman, L.T., Beck, A.M., McCabe, G.P. and Ecker, C. (1996b) Risk factors for relinquishment of cats to an animal shelter. *Journal of the American Veterinary Association*, **209**, 582–588
- Patterson, D.F. (1968) Epidemiologic and genetic studies of congenital heart disease in the dog. *Circulation Research*, **23**, 171–202
- Patterson, D.F. (1980) A catalog of genetic disorders of the dog. In: *Current Veterinary Therapy VII. Small Animal Practice*. Ed. Kirk, R.W., pp. 82–103. W.B. Saunders, Philadelphia
- Patterson, D.F. (1993) Understanding and controlling inherited diseases in dogs and cats. *Tijdschrift voor Diergeneeskunde*, **118**, Suppl. 1, 235–275
- Patterson, D.F. and Medway, W. (1966) Hereditary diseases of the dog. *Journal of the American Veterinary Medical Association*, **149**, 1741–1754
- Patterson, D.F., Pyle, R.L., Buchanan, J.W., Trautveter, E. and Abt, D.A. (1971) Hereditary patent ductus arteriosus and its sequelae in the dog. *Circulation Research*, **29**, 1–13
- Patterson, D.F., Haskins, M.E. and Jezyk, P.F. (1982) Models of human genetic disease in domestic animals. In: *Advances in Human Genetics*, **12**. Eds Harris, H. and Hirschhorn, K., pp. 263–339. Plenum Press, New York and London
- Patz, J.A. and Lindsay, S.W. (1999) New challenges, new tools: the impact of climate change on infectious diseases. *Current Opinion in Microbiology*, **2**, 445–451
- Patz, J.A., Epstein, P.R., Burke T.A. and Balbus J.M. (1996) Global climate change and emerging infectious diseases. *Journal of the American Medical Association*, **275**, 218–223
- Patz, J.A., Graczyk, T.K., Geller, N. and Vittor, A.Y. (2000) Effects of environmental change on emerging parasitic diseases. *International Journal of Parasitology*, **30**, 1395–1405
- Paul, J.R. and White, C. (Eds) (1973) *Serological Epidemiology*. Academic Press, New York and London

- Pavlovsky, E.N. (1964) *Prirodnaya Ochagovost' Transmissivnykh Boleznay v Svyazi s Landshaftnoy Epidemiologiy Zoonoprozozo*. Translated as *Natural Nidality of Transmissible Disease with Special Reference to the Landscape Epidemiology of Zoonanthroponoses*. F.K. Plous (Translator), Ed. N.D. Levine, 1966. University of Illinois Press, Urbana
- Payne, A.M. (1963) Basic concepts of eradication. *American Review of Respiratory Diseases*, **88**, 449–455
- Payne, J.M., Dew, S.M., Manston, R. and Faulks, M. (1970) The use of a metabolic profile test in dairy herds. *Veterinary Record*, **87**, 150–158
- Payne, L.N. (1982) Breeding resistant stock. In: *The Control of Infectious Diseases in Farm Animals*. British Veterinary Association Trust Project on the future of animal health control, London, pp. 37–42
- Pearce, D.W. (1971) *Cost-Benefit Analysis*. The Macmillan Press Limited, London
- Pearce, D.W. and Sturmeay, S.G. (1966) Private and social costs and benefits: a note on terminology. *Economic Journal*, March 1966, pp. 152–158
- Pearl, J. (2000) *Causality: Models, Reasoning and Inference*. Cambridge University Press, New York
- Pearson, J.K.L., Greer, D.O., Spence, B.K., McParland, P.J., McKinley, D.L., Dunlop, W.L. and Acheson, A.W. (1972) Factors involved in mastitis control: a comparative study between high and low incidence herds. *Veterinary Record*, **91**, 615–624
- Pearson, K. (1911) *The Grammar of Science. Part 1. – Physical*, revised 3rd edn. Adam and Charles Black, London
- Pearson, R.A. (1983) Prevention of foot lesions in broiler breeder hens kept in individual cages. *British Poultry Science*, **24**, 183–190
- Pease, M. (1947) How long do poultry breeding stock live? *Agriculture*, **54**, 265–266
- Pedgley, D.E. (1983) Windborne spread of insect-transmitted diseases of animals and man. *Philosophical Transactions of the Royal Society of London. Series B*, **302**, 463–470
- Peeler, E.J., Otte, M.J. and Esslemont, R.J. (1994) Interrelationships of peri-parturient diseases in dairy cows. *Veterinary Record*, **134**, 129–132
- Peeler, E.J., Green, M.J., Fitzpatrick, J.L. and Green, L.E. (2002) Study of clinical mastitis in British dairy herds with bulk milk somatic cell counts less than 150,000 cells/ml. *Veterinary Record*, **151**, 170–176
- Peeler, E.J., Green, M.J., Fitzpatrick, J.L. and Green, L.E. (2003) The association between quarter somatic-cell counts and clinical mastitis in three British dairy herds. *Preventive Veterinary Medicine*, **59**, 169–180
- Peloso, J.G., Murdy, G.D. and Cohen, N.D. (1994) Prevalence of, and factors associated with, musculoskeletal racing injuries of Thoroughbreds. *Journal of the American Veterinary Medical Association*, **204**, 620–626
- Pendergrass, T.W. and Hayes, H.M. (1975) Cryptorchism and related defects in dogs: epidemiologic comparisons with man. *Teratology*, **12**, 51–56
- Penny, R.H.C., Cameron, R.D.A., Johnson, S., Kenyon, P.J., Smith, H.A., Bell, A.W.P., Cole, J.P.L. and Taylor, J. (1980) Foot rot of pigs: the influence of biotin supplementation on foot lesions in sows. *Veterinary Record*, **107**, 350–351
- Penrose, R. (2004) *The Road to Reality: A Complete Guide to the Laws of the Universe*. Jonathan Cape, London
- Pensaert, M.B. (Ed.) (1989) *Virus Infections of Vertebrates, Vol. 2, Virus Infections of Porcines*. Elsevier, Amsterdam
- Peraino, C., Fry, R.J.M. and Staffeldt, E. (1977) Effects of varying the onset and duration of exposure to phenobarbital on its enhancement of 2-acetylaminofluorene-induced hepatic tumorigenesis. *Cancer Research*, **37**, 3623–3627
- Peralta, E.A., Carpenter, T.E. and Farver, T.B. (1982) The application of time series analysis to determine the pattern of foot-and-mouth disease in cattle in Paraguay. *Preventive Veterinary Medicine*, **1**, 27–36
- Perera, F.P. and Weinstein, I.B. (1982) Molecular epidemiology and carcinogen-DNA adduct detection: new approaches to studies of human cancer causation. *Journal of Chronic Diseases*, **35**, 581–600
- Perry, B.D. and McCauley, E.H. (1984) Owner interview surveys as a basis for estimating animal productivity and disease impact in developing countries. In: *Society for Veterinary Epidemiology and Preventive Medicine, Proceedings*, Edinburgh, 10–11 July 1984. Ed. Thrusfield, M.V., pp. 54–62
- Perry, B.D., Matthewman, R.W., Eicher, E. and Snacken, M. (1983) An evaluation of the efficacy of a questionnaire survey by comparison with data from sentinel herds. In: *Proceedings of the Third International Symposium on Veterinary Epidemiology and Economics*. Arlington, Virginia, 6–10 September 1982, p. 667. Veterinary Medical Publishing Company, Edwardsville
- Perry, B.D., Mwanauma, B., Schels, H.F., Eicher, E. and Zaman, M.R. (1984a) A study of health and productivity in traditionally managed cattle in Zambia. *Preventive Veterinary Medicine*, **2**, 633–653
- Perry, B.D., Palmer, J.E., Birch, J.B., Magnusson, R.A., Morris, D. and Troutt, H.F. (1984b) Epidemiological characterization of an acute equine diarrhoea syndrome: the case-control approach. In: *Society for Veterinary Epidemiology and Preventive Medicine, Proceedings*, Edinburgh, 10–11 July 1984. Ed. Thrusfield, M.V., pp. 148–153
- Perry, B.D., Palmer, J.E., Troutt, H.F., Birch, J.B., Morris, D., Ehrich, M. and Rikihisa, Y. (1986) A case-control study of Potomac horse fever. *Preventive Veterinary Medicine*, **4**, 69–82
- Perry, B.D., Lessard, P., Norval, R.A.I., Kundert, K. and Kruska, R. (1990) Climate, vegetation and the distribution of *Rhipicephalus appendiculatus* in Africa. *Parasitology Today*, **6**, 100–104
- Persing, D.H., Smith, T.F., Tenover, F.C. and White, T.J. (Eds) (1993) *Diagnostic Molecular Microbiology. Principles and Applications*. American Society for Microbiology, Washington, DC
- Peters, A.R., Martinez, T.A. and Cook, A.J.C. (2000) A meta-analysis of studies of the effect of GnRH 11–14 days after insemination on pregnancy rates in cattle. *Theriogenology*, **54**, 1317–1326
- Peters, J.A. (1969) Canine mastocytoma: excess risk as related to ancestry. *Journal of the National Cancer Institute*, **42**, 435–443
- Peterse, D.J. and Antonisse, W. (1981) Genetic aspects of feet soundness in cattle. *Livestock Production Science*, **8**, 253–261
- Petersen, G.R., Weis, D. and Van Der Valk, P.C. (1992) Vaccinations against *Mycoplasma hyopneumoniae* in swine. *Pig Veterinary Journal*, **28**, 35–39

- Petersen, G.V. (1983) The effect of swimming lambs and subsequent resting periods on the ultimate pH of meat. *Meat Science*, **9**, 237–246
- Peterson, E.H. and Hymas, T.A. (1951) Antibiotics in the treatment of an unfamiliar turkey disease. *Poultry Science*, **30**, 466–468
- Peto, R. (1977) Epidemiology, multistage models and short-term mutagenicity tests. In: *Origins of Human Cancer*. Eds Hiatt, H.H., Watson, J.D. and Winsten, J.A., pp. 1403–1429. Cold Spring Harbor Laboratory, New York
- Peto, R. (1978) Clinical trial methodology. *Biomedicine Special*, 24–36
- Peto, R. (1987) In: Discussion of Light, R.J. (1987) Accumulating evidence from independent studies: what we can win and what we can lose. *Statistics in Medicine*, **6**, 221–231
- Petrie, A. and Watson, P. (1999) *Statistics for Veterinary and Animal Science*. Blackwell Science, Oxford
- Pfeiffer, D.U. (1996) Survey data collection methods – questionnaires and interviews. In: *Primary Animal Health Activities in Southern Africa*. Proceedings of an International Seminar held in Mzuzu, Malawi, 26 February–8 March 1996. Eds Zimmerman, W., Pfeiffer, D.U. and Zessin, K.-H., pp. 159–169. Deutsche Stiftung für internationale Entwicklung (DSE) and Zentralstelle für Ernährung Landwirtschaft (ZEL), Feldafing
- Pfeiffer, D.U. (2000) Spatial analysis – a new challenge for veterinary epidemiologists. In: Society for Veterinary Epidemiology and Preventive Medicine, Proceedings, Edinburgh, 29–31 March 2000. Eds Thrusfield, M.V. and Goodall, E.A., pp. 86–106
- Pfeiffer, D. (2004) Science, epidemiological models and decision making. *The Veterinary Journal*, **167**, 123–124
- Pfeiffer, D., Cortes, C.E., Otte, E. and Morris, R.S. (1988) Management factors affecting the prevalence of brucellosis in traditionally managed cattle herds in Northern Colombia. *Acta Veterinaria Scandinavica*, Suppl. 84, 133–135
- Pfeiffer, D.U. and Hugh-Jones, M.E. (2002) Geographical information systems as a tool in epidemiological assessment and wildlife disease management. *Revue Scientifique et Technique, Office International des Epizooties*, **21**, 91–99
- Pfeiffer, D.U., Morris, R.S., Harris, A., Jockson, R. and Paterson, B. (1991) The epidemiology of bovine tuberculosis in the common brushtail possum. In: Proceedings of the Sixth International Symposium on Veterinary Epidemiology and Economics, Ottawa, 12–16 August 1991. Ed. Martin, S.W., pp. 430–433
- Pharo, H.J. (1983) DAISY – Health and fertility monitoring for dairy herds. In: Society for Veterinary Epidemiology and Preventive Medicine, Proceedings, Southampton, 12–13 April 1983. Ed. Thrusfield, M.V., pp. 37–44
- Pharo, H.J. (1999) *Import Risk Analysis. Imported Seropositive Animals: Assurance Provided by Serological Tests*. Ministry of Agriculture and Forestry, Wellington
- Pharo, H.J. (2001) *Import Risk Analysis. Avian Paramyxovirus Type 1 in Hens' Hatching Eggs*. Ministry of Agriculture and Forestry, Wellington
- Pharo, H.J. (2002) Foot-and-mouth disease: an assessment of the risks facing New Zealand. *New Zealand Veterinary Journal*, **50**, 46–55
- Pharo H.J. (2002a) Determination of the acceptable level of risk of introduction of FMD virus in passenger luggage following the UK outbreak in 2001. Proceedings of Australian College of Veterinary Scientists (Veterinary Epidemiology chapter) College Science Week, Gold Coast Australia, 1–6 July 2002. The Australian College of Veterinary Scientists, Building 3 Garden City Office Park, 2404 Logan Road, Eight Mile Plains QLD 4113, Australia. <http://www.biosecurity.govt.nz/pests-diseases/animals/risk/paper-acceptable-risk-fmd.pdf> (Accessed 29th June 2006)
- Pharo, H.J. (2004) Acceptable risk in animal biosecurity import risk analysis – the limits of rationalism. *Public Sector*, **27** (4), 8–14
- Pharo, H.J., Esslemont, R.J. and Putt, S.N.H. (1984) Assessing the benefits and costs of a computerised information system in dairy herd management. In: Society for Veterinary Epidemiology and Preventive Medicine. Proceedings, Edinburgh 10–11 July 1984. Ed. Thrusfield, M.V., pp. 80–89
- Philander, S.G.H. (1990) *El Niño, La Niña and the Southern Oscillation*. Academic Press, San Diego
- Phillipson, D.W. and Reynolds, A. (1996) B.I.E.A. excavation at Axum, northern Ethiopia 1995. *Azania*, **31**, 99–147
- Physick-Sheard, P.W. (1986a) Career profile of the Canadian Standardbred I. Influence of age, gait and sex upon chances of racing. *Canadian Journal of Veterinary Research*, **50**, 449–456
- Physick-Sheard, P.W. (1986b) Career profile of the Canadian Standardbred II. Influence of age, gait and sex upon number of races, money won and race times. *Canadian Journal of Veterinary Research*, **50**, 457–470
- Physick-Sheard, P.W. and Russell, M. (1986) Career profile of the Canadian Standardbred III. Influence of temporary absence from racing and season. *Canadian Journal of Veterinary Research*, **50**, 471–478
- Piantadosi, S., Byar, D.P. and Green, S.B. (1988) The ecological fallacy. *American Journal of Epidemiology*, **127**, 893–904
- Pierrepoint, C.G. (1985) Possible benefits to veterinary medicine of considering dogs as a model for human cancer. *Journal of Small Animal Practice*, **26**, 43–47
- Pierrepoint, C.G., Thomas, S. and Eaton, C.L. (1984) Hormones and cancer. In: *Progress in Cancer Research and Therapy*, Vol. 31. Eds Bresciani, F., King, R.J.B., Lippman, M.E., Namer, M. and Raynaud, J.-P., pp. 357–365. Raven Press, New York
- PigCHAMP (2004a) PigCHAMP knowledge software. <http://www.pigchamp.com/> (Accessed 29 March 2004)
- PigCHAMP (2004b) Breeding herd summary data, US, 2003. <http://www.fbcom.net/swinedata/production.html> (Accessed 16 March 2004)
- Pike, M.C. and Casagrande, J.T. (1979) Re: Cost considerations and sample size requirements in cohort and case-control studies (letter). *American Journal of Epidemiology*, **110**, 100–102
- Pike, M.C. and Smith, P.G. (1968) Disease clustering: a generalization of Knox's approach to the detection of space-time interactions. *Biometrics*, **24**, 541–556
- Pilchard, E.I. (1985) Standardized nomenclature of veterinary medicine: Taking the next step. *Journal of the American Veterinary Medical Association*, **187**, 798–799

- Pilliner, S. (1992) *Horse Nutrition and Feeding*. Blackwell Scientific Publications, Oxford
- Pinchbeck, G.L., Clegg, P.D., Proudman, C.J., Morgan, K.L. and French, N.P. (2002a) Horse falls in National Hunt Racing in the UK: risk factors and sources of variation. In: Society for Veterinary Epidemiology and Preventive Medicine, Proceedings, Cambridge, 3–5 April 2002, Eds Menzies, F.D. and Reid, S.W.J., pp. 84–95
- Pinchbeck, G.L., Clegg, P.D., Proudman, C.J., Morgan, K.L., Wood, J.L.N. and French, N.P. (2002b) Risk factors and sources of variation in the horse falls in steeplechase racing in the UK. *Preventive Veterinary Medicine*, **55**, 179–192
- Pinchbeck, G.L., Clegg, P.D., Proudman, C.J., Morgan, K.L. and French, N.P. (2003) Case-control study to investigate risk factors for horse falls in hurdle racing in England and Wales. *Veterinary Record*, **152**, 583–587
- Pinchbeck, G.L., Clegg, P.D., Proudman, C.J., Morgan, K.L. and French, N.P. (2004a) Case-control investigation of the factors affecting the risk of horses falling during steeplechase racing in the UK. *Veterinary Record*, **155**, 11–15
- Pinchbeck, G.L., Clegg, P.D., Proudman, C.J., Morgan, K.L. and French, N.P. (2004b) Whip use and race progress are associated with horse falls in hurdle and steeplechase racing in the UK. *Equine Veterinary Journal*, **36**, 384–389
- Pinney, M.E. (1981) How I learned to live with the computer. *Veterinary Record*, **109**, 431–432
- Pinto, R.C. and Blair, J.A. (1993) *Reasoning: A Practical Guide*. Prentice Hall, Englewood Cliffs
- Pisano, R.G. and Storer, T.I. (1948) Burrows and feeding of the Norway rat. *Journal of Mammalogy*, **29**, 374–383
- Pivnick, H. and Nurmi, E. (1982) The Nurmi concept and its role in the control of *Salmonellae* in poultry. In: *Developments in Food Microbiology – 1*. Ed. Davies, R., pp. 41–70. Applied Science Publishers, Barking
- Plackett, P. and Alton, G.G. (1975) A mechanism for prozone formation in the complement fixation test for bovine brucellosis. *Australian Veterinary Journal*, **52**, 136–140
- Pleguezuelo, R.H., Pérez, J.G. and Rambaud, S.C. (2003) A note on the reasonableness of PERT hypotheses. *Operations Research Letters*, **31**, 60–62
- Plowright, W. (1998) Professional Commitment to the Success of the Global Rinderpest Eradication Campaign. Technical Consultation on the Global Rinderpest Eradication Programme, FAO, Rome, 28–30 September 1998
- Plowright, R.C. and Paloheimo, J.E. (1977) A theoretical study of population dynamics in the sheep tick. *Theoretical Population Biology*, **12**, 286–297
- Plowright, W., Ferris, R.D. and Scott, G.R. (1960) Blue wildebeest and the aetiological agent of bovine malignant catarrhal fever. *Nature, London*, **188**, 1167–1169
- Plowright, W., Perry, C.T. and Greig, A. (1974) Sexual transmission of African swine fever virus in the tick, *Ornithodoros moubata porcinus*, Walton. *Research in Veterinary Science*, **17**, 106–113
- Pocock, S.J. (1977) Group sequential methods in the design and analysis of clinical trials. *Biometrika*, **64**, 191–199
- Pocock, S.J. (1983) *Clinical Trials: A Practical Approach*. John Wiley and Sons, Chichester and New York
- Pocock, S.J. and Hughes, M.D. (1990) Estimation issues in clinical trials and overviews. *Statistics in Medicine*, **9**, 657–671
- Podberscek, A.L. and Serpell, J.A. (1997) Aggressive behaviour in English cocker spaniels and the personality of their owners. *Veterinary Record*, **141**, 73–76
- Pointon, A. and Hueston, W.D. (1990) The National Animal Health Monitoring System (NAHMS): evolution of an animal health information database system in the USA. In: Society for Veterinary Epidemiology and Preventive Medicine, Proceedings, Belfast, 4–6 April 1990. Ed. Thrusfield, M.V., pp. 70–82
- Pointon, A.M. (1989) *Campylobacter* associated intestinal pathology in pigs. *Australian Veterinary Journal*, **66**, 90–91
- Pointon, A.M., Heap, P. and McCloud, P. (1985) Enzootic pneumonia of pigs in South Australia – factors relating to incidence of disease. *Australian Veterinary Journal*, **62**, 98–101
- Polack, E.W., King, J.M., Cummings, J.F., Mohammed, H.O., Birch, M. and Cronin, T. (2000) Concentrations of trace minerals in the spinal cord of horses with equine motor neuron disease. *American Journal of Veterinary Research*, **61**, 609–611
- Pollard, J.C., Littlejohn, R.P., Johnstone, P., Laas, F.J., Corson, I.D. and Suttie, J.M. (1992) Behavioural and heart rate responses to velvet antler removal in red deer. *New Zealand Veterinary Journal*, **40**, 65–61
- Pollitzer, R. and Meyer, K.F. (1961) The ecology of plague. In: *Studies in Disease Ecology*. Ed. May, J.M., pp. 433–510. Hafner Publishing, New York
- Polydorou, K. (1980) The epizootiology, diagnosis and control of bluetongue. *Bulletin de l'Office International des Epizooties*, **92**, 557–565
- Polzer, J. and Slater, M.R. (1996) Age, breed, sex and seasonality as risk factors for equine laminitis. *Preventive Veterinary Medicine*, **29**, 179–184
- Polzin, D.J., Lund, E., Walter, P. and Klausner, J. (2000) From journal to patient: evidence-based medicine. In: *Kirk's Current Veterinary Therapy XIII*, Ed. Bonagura J.D., pp. 2–8. W.B. Saunders, Philadelphia
- Pomeroy, B.S. and Fenstermacher, R. (1937) Haemorrhagic enteritis in turkeys. *Poultry Science*, **16**, 378–382
- Pommier, P., Keita, A., Pagot, E. and Flochlay, A. (2000) Field efficacy of a *Mycoplasma hyopneumoniae* vaccine in the control of enzootic pneumonia in swine. *Revue de Médecine Vétérinaire*, **151**, 835–840
- Poortinga, E.W. and Hungerford, L.L. (1998) A case-control study of acute ibuprofen toxicity in dogs. *Preventive Veterinary Medicine*, **35**, 115–124
- Poppensiek, G.C., Budd, D.E. and Scholtens, R.G. (1966) *A Historical Survey of Animal-Disease Morbidity and Mortality Reporting*. National Academy of Sciences, Washington, DC. Publication No. 1346
- Popper, K.R. (1959) *Logik der Forschung*. (English translation: *The Logic of Scientific Discovery*. Transl. Popper, K.R., Freed, J. and Freed, L. Hutchison, London)
- Porter, P. (1979) Hazards of recycling enteropathogens (letter). *Veterinary Record*, **105**, 515–516
- Porter, T.M. (1995) *Trust in Numbers: the Pursuit of Objectivity in Science and Public Life*. Princeton University Press, Princeton
- Pötzsch, C.J., Lewis, K.L., Nicol, C.J. and Green, L.E. (2001) Multivariate techniques used in a cross-sectional study of feather pecking and vent pecking in laying hens in altern-

- ative systems. In: Society for Veterinary Epidemiology and Preventive Medicine, Proceedings, Noordwijkerhout, The Netherlands, 28–30 March 2001, Eds Menzies, F.D. and Reid, S.W.J., pp. 153–164
- Pouillot, R. and Gerbier, G. (2001) 'TAGS', a program for the evaluation of diagnostic tests in the absence of a gold standard. In: Society for Veterinary Epidemiology and Preventive Medicine, Proceedings, Noordwijkerhout, 28–30 March 2001. Eds Menzies, F.D. and Reid, S.W.J., pp. 37–48
- Pouillot, R., Gerbier, G. and Gardner, I.A. (2002) 'Tags', a program for the evaluation of test accuracy in the absence of a gold standard. *Preventive Veterinary Medicine*, **53**, 67–81
- Pouilly, F., Viel, J.F., Mialot, J.P., Sanaa, M., Humblot, P., Ducrot, C. and Grimard, B. (1994) Risk factors for post-partum anoestrus in Charolais beef cows in France. *Preventive Veterinary Medicine*, **18**, 305–314
- Poulin, R. (1994) Meta-analysis of parasite-induced behavioural changes. *Animal Behaviour*, **48**, 137–146
- Poulin, R. (1995) 'Adaptive' changes in behaviour of parasitized animals: a critical review. *International Journal of Parasitology*, **25**, 1371–1383
- Poulin, R. (1998) *Evolutionary Ecology of Parasites*. Chapman and Hall, London
- Poulin, R. and Chappell, L.H. (Eds) (2002) Parasites in marinesystems. *Parasitology*, **124**, Suppl. 2002, 81–207
- Powell, D.G. (1985) International movement of horses and its influence on the spread of infection. In: Society for Veterinary Epidemiology and Preventive Medicine. Proceedings, Reading, 27–29 March 1985. Ed. Thrusfield, M.V., pp. 90–94
- Prabhakaran, P., Soman, M., Iyer, R.P. and Abraham, J. (1980) Common disease conditions among cattle slaughtered in Trichur municipal slaughterhouse, a preliminary study. *Kerala Journal of Veterinary Science*, **11**, 159–163
- Pratt, D.J., Greenway, P.J. and Gwynne, M.D. (1966) A classification of East African rangeland, with an appendix on terminology. *Journal of Applied Ecology*, **3**, 369–382
- Pretty, J.N. (1995) Participatory learning for sustainable agriculture. *World Development*, **23**, 1247–1263
- Priester, W.A. (1964) *Standard Nomenclature of Veterinary Diseases and Operations*. USHEW/PHS National Cancer Institute, Bethesda, Md. (1st edition revised 1966, 2nd (abridged) edition 1975)
- Priester, W.A. (1967) Canine lymphoma: relative risk in the boxer breed. *Journal of the National Cancer Institute*, **39**, 833–845
- Priester, W.A. (1971) *Coding Supplement to Standard Nomenclature of Veterinary Diseases and Operations*. USHEW/PHS National Cancer Institute, Bethesda, Md. Revised 1977
- Priester, W.A. (1972a) Congenital ocular defects in cattle, horses, cats and dogs. *Journal of the American Veterinary Medical Association*, **160**, 1504–1511
- Priester, W.A. (1972b) Sex, size and breed as risk factors in canine patellar dislocation. *Journal of the American Veterinary Medical Association*, **160**, 740–742
- Priester, W.A. (1973) Skin tumors in domestic animals. Data from 12 United States and Canadian colleges of veterinary medicine. *Journal of the National Cancer Institute*, **50**, 457–466
- Priester, W.A. (1974a) Canine progressive retinal atrophy: occurrence by age, breed and sex. *American Journal of Veterinary Research*, **35**, 571–574
- Priester, W.A. (1974b) Data from eleven United States and Canadian colleges of Veterinary Medicine on pancreatic carcinoma in domestic animals. *Cancer Research*, **34**, 1372–1375
- Priester, W.A. (1974c) Pancreatic islet cell tumors in domestic animals. Data from 11 colleges of veterinary medicine in the United States and Canada. *Journal of the National Cancer Institute*, **53**, 227–229
- Priester, W.A. (1975) Collecting and using veterinary clinical data. In: *Animal Disease Monitoring*. Eds Ingram, D.G., Mitchell, W.F. and Martin, S.W., pp. 119–128. Charles C. Thomas, Springfield
- Priester, W.A. (1976a) Canine intervertebral disc disease: occurrence by age, breed, and sex among 8117 cases. *Theriogenology*, **6**, 293–303
- Priester, W.A. (1976b) Hepatic angiosarcomas in dogs: an excessive frequency as compared with man. *Journal of the National Cancer Institute*, **57**, 451–453
- Priester, W.A. and Hayes, H.M. (1973) Feline leukemia after feline infectious anaemia. *Journal of the National Cancer Institute*, **51**, 289–291
- Priester, W.A. and Mantel, N. (1971) Occurrence of tumours in domestic animals. Data from twelve United States and Canadian colleges of Veterinary Medicine. *Journal of the National Cancer Institute*, **47**, 1333–1344
- Priester, W.A. and McKay, F.W. (1980) *The Occurrence of Tumours in Domestic Animals*. National Cancer Institute Monograph Number 54. United States Department of Health and Human Services. National Cancer Institute, Bethesda
- Priester, W.A. and Mulvihill, J.J. (1972) Canine hip dysplasia: relative risk by sex, size and breed, and comparative aspects. *Journal of the American Veterinary Medical Association*, **160**, 735–739
- Priester, W.A., Glass, A.G. and Waggoner, N.S. (1970) Congenital defects in domesticated animals: general considerations. *American Journal of Veterinary Research*, **31**, 1871–1879
- Pritchard, D.G., Carpenter, G.A., Morzaria, S.P., Harkness, J.W., Ritchards, M.S. and Brewer, J.I. (1981) Effect of air filtration on respiratory disease in intensively housed veal calves. *Veterinary Record*, **109**, 5–9
- Pritchard, D.G., Edwards, S., Morzaria, S.P., Andrews, A.H., Peters, A.R. and Gilmour, N.J.L. (1983) Case-control studies in the evaluation of serological data from respiratory disease outbreaks in cattle. In: Society for Veterinary Epidemiology and Preventive Medicine. Proceedings, Southampton, 12–13 April 1983. Ed. Thrusfield, M.V., pp. 131–138
- Pritchard, D.G., Little, T.W.A., Wrathall, A.E. and Jones, P. (1985) Epidemiology of leptospirosis in relation to reproductive disease in pigs. *The Pig Veterinary Society Proceedings*, **12**, 65–82
- Pritchard, D.G., Allsup, T.N., Pennycott, T.W., Palmer, N.M.A., Woolley, J.C. and Richards, M.S. (1989) Analysis of risk factors for infection of cattle herds with *Leptospira interrogans* serovar *hardjo*. In: Society for Veterinary Epidemiology and Preventive Medicine, Proceedings, Exeter, 12–14 April 1989. Ed. Rowlands, G.J., pp. 130–138
- Pritchard, W.R. (1986) Veterinary education for the 21st century. *Journal of the American Veterinary Medical Association*, **189**, 172–177

- Pritchard, W.R. (Ed.) (1989) *Current Status and Future Directions for Veterinary Medicine*. Pew National Veterinary Education Program Report. Duke University, Durham, North Carolina
- Prothro, R.M. (1977) Disease and mobility: a neglected factor in epidemiology. *International Journal of Epidemiology*, **6**, 259–267
- Proudman, C.J. (1992) A two year, prospective survey of equine colic in general practice. *Equine Veterinary Journal*, **24**, 90–93
- Proudman, C.J. and Edwards, G.B. (1992) Validation of a centrifugation/flotation technique for the diagnosis of equine cestodiasis. *Veterinary Record*, **131**, 71–72
- Prymak, C., McKee, L.J., Goldschmidt, M.H. and Glickman, L.T. (1988) Epidemiologic, clinical, pathologic and prognostic characteristics of splenic haemangiosarcoma and splenic haematoma in dogs: 217 cases (1985). *Journal of the American Veterinary Medical Association*, **193**, 706–712
- Pugsley, S.L. (1981) The veterinary computer system at London zoo. In: *A Computerised Veterinary Clinical Data Base*. Proceedings of a symposium, Edinburgh, 30 September 1981. Ed. Thrusfield, M.V., p. 55. Department of Animal Health, Royal (Dick) School of Veterinary Studies, Edinburgh
- Purdey, M. (2000) Ecosystems supporting clusters of sporadic TSEs demonstrate excesses of the radical-generating divalent cation manganese and deficiencies of antioxidant co-factors Co, Se, Fe, Zn – does a foreign cation substitution at prion protein's Cu domain initiate TSE? *Medical Hypotheses*, **54**, 278–306
- Queensberry, C.P. and Hurst, D.C. (1964) Large sample simultaneous confidence intervals for multinomial proportions. *Technometrics*, **6**, 191–195
- Quetelet, L.A.J. (1835) *Sur l'homme et le développement de ses facultés*. Translated as *A Treatise on Man and the Development of His Faculties*. Transl. Knox, R. (1962). Burt Franklin, New York
- Quinn, P.J. (1991) Disinfection and disease prevention in veterinary medicine. In: *Disinfection, Sterilization and Preservation*, 4th edn. Ed. Block, S.S., pp. 846–870. Lea and Febiger, London and Philadelphia
- Quinn, P.J., Markey, B.K., Carter, M.E., Donnelly, W.J.C. and Leonard, F.C. (2002) *Veterinary Microbiology and Microbial Disease*. Blackwell Science, Oxford
- Radostits, O.M., Gay, C.C., Blood, D.C. and Hinchcliff, K.W. (1999) *Veterinary Medicine*, 9th edn W.B. Saunders, London
- Ragan, V.E. (2002) The Animal and Plant Inspection Service (APHIS) Brucellosis Eradication Programme in the United States. *Veterinary Microbiology*, **90**, 11–18
- Raghavan, M., Knapp, D.W., Dawson, M.H., Bonney, P.L. and Glickman, L.T. (2004) Topical flea and tick pesticides and the risk of transitional cell carcinoma of the urinary bladder in Scottish Terriers. *Journal of the American Veterinary Medical Association*, **225**, 389–394
- Ragland, W.L., Keown, G.H. and Spencer, G.R. (1970) Equine sarcoid. *Equine Veterinary Journal*, **2**, 2–11
- Rahko, T. (1968) A statistical study of tumours in dogs. *Acta Veterinaria Scandinavica*, **9**, 328–349
- Rajala, P.J. and Gröhn, Y.T. (1998) Disease occurrence and risk factor analysis in Finnish Ayrshire cows. *Acta Veterinaria Scandinavica*, **39**, 1–13
- Ramsey, F.K. and Chivers, W.H. (1953) Mucosal disease of cattle. *North American Veterinarian*, **34**, 629–633
- Rand, E.K. (1928) *Founders of the Middle Ages*. Harvard University Press, Cambridge
- Randall, A., Hillier, A., Cole, L.K., Kwochka, K.W., Needham, G. and Wassom, D.L. (2003) Quantitation of house dust mites and house dust mite allergens in the microenvironment of dogs. *American Journal of Veterinary Research*, **64**, 1580–1588
- Randolph, S. (1994) Population dynamics and density-dependent seasonal mortality indices of the tick *Rhipicephalus appendiculatus* in eastern and southern Africa. *Medical and Veterinary Entomology*, **8**, 351–368
- Ransohoff, D.F. and Feinstein, A.R. (1978) Problems of spectrum bias in evaluating the efficacy of diagnostic tests. *New England Journal of Medicine*, **299**, 926–930
- Rapoport, E. and Shimshony, A. (1997) Health hazards to the small ruminant population of the Middle East posed by the trade of sheep and goat meat. *Revue Scientifique et Technique, Office International des Epizooties*, **16**, 57–64
- Ratcliffe, H. (1850) *Observations on the mortality and sickness existing among Friendly Societies: particularised for various trades, occupations, and localities, with a series of tables, shewing the value of annuities, sick gift, assurance for death, and contributions to be paid equivalent thereto: calculated from the experience of the members composing the Manchester Unity of the Independent Order of Odd Fellows*. George Falkener, Manchester. Reprinted in *Mortality in Mid 19th Century Britain*. Introduced by Wall, R. (1974). Gregg International, Amersham
- Ratcliffe, P.R. (1987) Red deer population changes and the independent assessment of population size. *Symposia of the Zoological Society of London*, **58**, 153–165
- Rattenborg, E.E. and Agger, J.F. (1991) Disease and mortality in the European hare (*Lepus europaeus* Pallas) population in Denmark 1932–1985. In: Proceedings of the Sixth International Symposium on Veterinary Epidemiology and Economics, Ottawa, 12–16 August 1991. Ed. Martin, S.W., pp. 437–439
- Rawlings, P., Pro, M.J., Pena, I., Ortega, M.D. and Capela, R. (1997) Spatial and seasonal distribution of *Culicoides imicola* in Iberia in relation to the transmission of African horse sickness virus. *Medical and Veterinary Entomology*, **11**, 49–57
- Read, R.A., Wood, J.L.N. and Lakhani, K.H. (1998) Pectinate ligament dysplasia (PLD) and glaucoma in flat coated retrievers. I. Objectives, technique and results of a PLD survey. *Veterinary Ophthalmology*, **1**, 85–90
- Redmill, F. (2002) Risk analysis – a subjective process. *Engineering Management Journal*, **12**, 91–96
- Reece, R.L. and Beddome, V.D. (1983) Causes of culling and mortality in three flocks of broiler chickens in Victoria during 1979. *Veterinary Record*, **112**, 450–452
- Rees, W.G.H. and Davies, G. (1992) Legislation for health. In: *Livestock Health and Welfare*. Ed. Moss, R., pp. 118–159. Longman Scientific and Technical, Harlow
- Reeve-Johnson, L. (1998) Use of disease models in the development and evaluation of therapeutic trials. *Veterinary Record*, **142**, 638–642
- Reeves, M.J., Gay, J.M., Hilbert, B.J. and Morris, R.S. (1989) Association of age, sex and breed factors in acute equine



- colic: a retrospective study of 320 cases admitted to a veterinary teaching hospital in the USA. *Preventive Veterinary Medicine*, **7**, 149–160
- Reeves, M.J., Salman, M.D. and Smith, G. (1996a) Repeatability of equine health and management information obtained via a telephone questionnaire. *Preventive Veterinary Medicine*, **26**, 347–351
- Reeves, M.J., Salman, M.D. and Smith, G. (1996b) Risk factors for equine acute abdominal disease (colic): results from a multi-center case-control study. *Preventive Veterinary Medicine*, **26**, 285–301
- Refrégier-Petton, J., Rose, N., Denis, M. and Salvat, G. (2001) Risk factors for *Campylobacter* spp. contamination in French broiler-chicken flocks at the end of the rearing period. *Preventive Veterinary Medicine*, **50**, 89–100
- Reid, H.W. (2002) FMD in a parturient sheep flock (Letter). *Veterinary Record*, **150**, 791
- Reid, J. and Nolan, A.M. (1991) A comparison of the post-operative analgesic and sedative effects of flunixin and papaveretum in the dog. *Journal of Small Animal Practice*, **32**, 603–608
- Reid, R.S., Kruska, R.L., Deichmann, U., Thornton, P.K. and Leak, S.G.A. (2000) Human population growth and the extinction of the tsetse fly. *Agriculture Ecosystems and Environment*, **77**, 227–236
- Reid, S.W.J. and Gettinby, G. (1994) Modelling the equine sarcoid. In: Society for Veterinary Epidemiology and Preventive Medicine, Proceedings, Belfast, 13–15 April 1994. Ed. Thrusfield, M.V., pp. 167–173
- Reid, S.W.J. and Peterson, M.M. (2000) Methods of estimating canine longevity. *Veterinary Record*, **147**, 630–631
- Reid, S.W.J., Gettinby, G., Fowler, J.N. and Ikin, P. (1994) Epidemiological observations on sarcoids in a population of donkeys (*Equus asinus*). *Veterinary Record*, **134**, 207–211
- Reif, J.S. (1976) Seasonality, natality and herd immunity in feline panleukopenia. *American Journal of Epidemiology*, **103**, 81–87
- Reif, J.S. (1983) Ecologic factors and disease. In: *Textbook of Veterinary Internal Medicine. Volume 1. Diseases of the Dog and Cat*, 2nd edn. Ed. Ettinger, S.J., pp. 147–173. W.B. Saunders, Philadelphia
- Reif, J.S. and Brodey, R.S. (1969) The relationship between cryptorchidism and canine testicular neoplasia. *Journal of the American Veterinary Medical Association*, **155**, 2005–2010
- Reif, J.S. and Cohen, D. (1970) Canine pulmonary disease. II. Retrospective radiographic analysis of pulmonary disease in rural and urban dogs. *Archives of Environmental Health*, **20**, 684–689
- Reif, J.S. and Cohen, D. (1971) The environmental distribution of canine respiratory tract neoplasms. *Archives of Environmental Health*, **22**, 136–140
- Reif, J.S. and Cohen, D. (1979) Canine pulmonary disease: a spontaneous model for environmental epidemiology. In: *Animals as Monitors of Environmental Pollutants*, pp. 241–250. National Academy of Sciences, Washington, DC
- Reif, J.S., Maguire, T.G., Kenney, R.M. and Brodey, R.S. (1979) A cohort study of canine testicular neoplasia. *Journal of the American Veterinary Medical Association*, **175**, 719–723
- Reif, J.S., Schweitzer, D.J., Ferguson, S.W. and Benjamin, S.A. (1983) Canine neoplasia and exposure to uranium mill tailings in Mesa County, Colorado. In: *Epidemiology Applied to Health Physics*. Proceedings of the 16th Midyear Topical Meeting of the Health Physics Society, Albuquerque, New Mexico, 9–13 January, 1983, pp. 461–469. Rio Grande Chapter of the Health Physics Society
- Reif, J.S., Dunn, K., Ogilvie, G.K. and Harris, C.K. (1992) Passive smoking and canine lung cancer. *American Journal of Epidemiology*, **135**, 234–239
- Reif, J.S., Lower, K.S. and Ogilvie, G.K. (1995) Residential exposure to magnetic fields and risk of canine lymphoma. *American Journal of Epidemiology*, **141**, 352–359
- Reilly, W.J. (1996) Verotoxigenic *Escherichia coli* O157 in Scotland. In: Society for Veterinary Epidemiology and Preventive Medicine, Proceedings, Glasgow, 27–29 March 1996. Eds Thrusfield, M.V. and Goodall, E.A., pp. 60–71
- Reinharz, S. (1983) Quoted by Kelly, L. (1988) *Surviving Sexual Violence*. Polity Press, Cambridge
- Reisner, I.R., Erb, H.N. and Houpt, K.A. (1994) Risk factors for behavior-related euthanasia among dominant-aggressive dogs: 110 cases (1989–1992). *Journal of the American Veterinary Medical Association*, **205**, 855–863
- Renn, O. (1992) Concepts of risk: a classification. In: *Social Theories of Risk*. Eds Krimsky, S. and Golding, D., pp. 53–79. Praeger, Westport
- Rentería Evangelista, T.B. and De Anda J.H. (1996) Tuberculosis in dairy calves: risk of *Mycobacterium* spp. exposure associated with management of colostrum and milk. *Preventive Veterinary Medicine*, **27**, 23–27
- Report (1983) *Risk Assessment: A Study Group Report*. The Royal Society, London
- Report (1990) Potential use of live viral and bacterial vectors for vaccines. *Vaccine*, **8**, 425–437
- Report (1992) *Risk Analysis, Perception and Management. Report of a Royal Society Study Group*. Royal Society, London
- Report (2000) *An Epidemiological Investigation into Bovine Tuberculosis*. Second Report of the Independent Scientific Group on Cattle TB. MAFF Publications, London
- Reutlinger, S. (1970) *Techniques for Project Appraisal under Uncertainty*. World Bank Staff Occasional Paper No. 10, Washington, DC
- Reviriego, F.J., Moreno, M.A. and Domínguez, L. (2000) Risk factors for brucellosis seroprevalence of sheep and goat flocks in Spain. *Preventive Veterinary Medicine*, **44**, 167–173
- Reynal, J. (1873) *Traité de Police Sanitaire des Animaux Domestiques*. Asselin, Paris
- Reynolds, D.J., Morgan, J.H., Chanter, N., Jones, P.W., Bridger, J.C., Debney, T.G. and Bunch, K.J. (1986) Microbiology of calf diarrhoea in southern Britain. *Veterinary Record*, **119**, 34–39
- Rhodes, J.K., Pelzer, K.D., Johnson, Y.J. and Russek-Cohen, E. (2003) Comparison of culling rates among dairy cows grouped on the basis of serologic status for bovine leukemia virus. *Journal of the American Veterinary Medical Association*, **223**, 229–231
- Ribble, C.S. (1989) Principles of implementing and marketing bovine health management programs. In: *Proceedings of the American Association of Bovine Practitioners*, **21**, 27–33
- Ribelin, W.E. and Bailey, W.S. (1958) Oesophageal sarcomas associated with *Spirocirca lupi* infection in the dog. *Cancer*, **11**, 1242–1246
- Ribó, O., Korn, C., Meloni, U., Cropper, M., De Winne, P. and Cuypers, M. (2001) IDEA: a large-scale project on



- electronic identification of livestock. *Revue Scientifique et Technique, Office International des Epizooties*, **20**, 426–436
- Rice, D., Hancock, D. and Besser, T.E. (2003) Faecal culture of wild animals for *Escherichia coli* 0157:H7. *Veterinary Record*, **152**, 82–83
- Richards, H.G., McNeil, P.E., Thompson, H. and Reid, S.W.J. (2001) An epidemiological analysis of a canine-biopsies database compiled by a diagnostic histopathology service. *Preventive Veterinary Medicine*, **51**, 125–136
- Richards, M. (1954) *The Laws of Hywel Dda (The Book of Blegywryd)*. The University of Liverpool Press, Liverpool
- Ricketts, S.W. and Alonso, S. (1991) The effect of age and parity on the development of equine chronic endometrial disease. *Equine Veterinary Journal*, **23**, 189–192
- Rideout, B.A., Rotstein, D., Oaks, J.L., Sandfort, C., Hall, C., Richman, L., Scott, D.P., Garber, R., Stalis, I. and Jenny, J.P. (1997) An adenovirus outbreak in captive Aplomado falcons (*Falco femoralis septentrionalis*) causing high morbidity and mortality. Proceedings of the American Association of Zoo Veterinarians, Annual Conference, Houston, Texas, 29–30 October 1997, pp. 45–46
- Rifkin, S.B., Llewondo-Hundt, G. and Draper, A.K. (1998) *Review of Participatory Approaches in Health Promotion and Planning*. Health Education Council/London School of Hygiene and Tropical Medicine, London
- Riggenbach, C. (1988) National animal health information system in Switzerland. *Revue Scientifique et Technique, Office International des Epizooties*, **7**, 503–507
- Rikihisa, Y. and Perry, B.D. (1985) Causative ehrlichial organisms in Potomac horse fever. *Infection and Immunity*, **49**, 513–517
- Ristow, L.E., Silva, L.G.C., Fóscolo, C.B. and Silva, A.F. (2002) Comparison of *M. hyopneumoniae* vaccines and the influence of maternal antibodies. In: Proceedings of the 17th Congress of the International Pig Veterinary Society Congress, 2–5 June 2002, Ames, Iowa. Volume 2: Poster Presentations, p. 330
- Rivas, A.L., Smith, S.D., Sullivan, P.J., Gardner, B., Aparicio, J.P., Hoogesteijn, A.L. and Castillo-Chávez, C. (2003) Identification of geographic factors associated with early spread of foot-and-mouth disease. *American Journal of Veterinary Research*, **64**, 1519–1527
- Robert, F., Renaud, F., Mathieu, F. and Gabrion, C. (1988) Importance of the paratenic host in the biology of *Bothriocephalus gregarius* (Cestoda, Pseudophyllidea), a parasite of turbot. *International Journal for Parasitology*, **18**, 611–621
- Roberts, D.F. (1985) A definition of genetic epidemiology. In: *Diseases of Complex Aetiology in Small Populations: Ethnic Differences and Research Approaches*. Proceedings of a Symposium on Genetic Epidemiology in an Anthropological Context, Victoria, British Columbia, 18 and 19 August 1983. Eds Chakraborty, R. and Szathmary, E.J.E., pp. 9–20. Alan R. Liss, New York
- Roberts, D.S. (1969) Synergic mechanisms in certain mixed infections. *Journal of Infectious Diseases*, **120**, 720–724
- Roberts, L., Lawson, G.H.K., Rowland, A.C. and Laing, A.H. (1979) Porcine intestinal adenomatosis and its detection in a closed pig herd. *Veterinary Record*, **104**, 366–368
- Robertson, F.J. (1971) Brucellosis: a possible symptomless carrier. *Veterinary Record*, **88**, 313–314
- Robertson, I.D. (1999) The influence of diet and other factors on owner-perceived obesity in privately owned cats from metropolitan Perth, Western Australia. *Preventive Veterinary Medicine*, **40**, 75–85
- Robinson, L.E., Miranda, M.E., Miranda, N.L. and Childs, J.E. (1996) Evaluation of a canine rabies vaccination campaign and characterization of owned-dog populations in the Philippines. *Southeast Asian Journal of Tropical Medicine and Public Health*, **27**, 250–256
- Robinson, R.A., Kobluk, C., Clanton, C., Martin, F., Gordon, B., Ames, T., Trent, M. and Ruth, G. (1988) Epidemiological studies of musculoskeletal racing and training injuries in thoroughbred horses, Minnesota, U.S.A. *Acta Veterinaria Scandinavica*, Suppl. 84, 340–341
- Robinson, W.S. (1950) Ecological correlations and the behavior of individuals. *American Sociological Review*, **15**, 351–357
- Rochlitz, I. (2003a) Study of factors that may predispose domestic cats to road traffic accidents: part 1. *Veterinary Record*, **153**, 549–553
- Rochlitz, I. (2003b) Study of factors that may predispose domestic cats to road traffic accidents: part 2. *Veterinary Record*, **153**, 585–588
- Roder, J.D. (2001) *Veterinary Toxicology*. Butterworth-Heinemann, Boston
- Rodrigues, L. and Kirkwood, B.R. (1990) Case-control designs in the study of common diseases: updates on the demise of the rare disease assumption and the choice of sampling scheme for controls. *International Journal of Epidemiology*, **19**, 205–213
- Rodríguez-Buenfil, J.C., Alvarez-Fleites, M., Alzina-Lopez, A., Arjona-Torres, M.G., Segura-Correa, J.C. and Villegas-Pérez, S. (2002) Risk factors for Aujeszky's disease in pig herds and detection of field virus antibodies in fattening pigs in the state of Yucatan, Mexico. *Preventive Veterinary Medicine*, **53**, 205–213
- Rodríguez-Lainz, A., Hird, D.W., Carpenter, T.E. and Read, D.H. (1996) Case-control study of papillomatous digital dermatitis in southern California dairy farms. *Preventive Veterinary Medicine*, **28**, 117–131
- Rodríguez-Lainz, A., Hird, D.W., Kass, P.H. and Brooks, D.L. (1997) Incidence and risk factors for bumblefoot (pododermatitis) in rehabilitated raptors. *Preventive Veterinary Medicine*, **31**, 175–184
- Roe, R.T. (1980) Features of the Australian National Animal Disease Information System. In: *Veterinary Epidemiology and Economics*. Proceedings of the Second International Symposium, Canberra, 7–11 May 1979. Eds Geering, W.A., Roe, R.T. and Chapman, L.A., pp. 26–34. Australian Government Publishing Service, Canberra
- Roeder, P.L. and Taylor, W.P. (2002) Rinderpest. *Veterinary Clinics of North America, Food Animal Practice*, **18**, 515–547
- Rogan, W.J. and Gladen, B. (1978) Estimating prevalence from the results of a screening test. *American Journal of Epidemiology*, **107**, 71–76
- Rogers, D.J. (1991) Satellite imagery: tsetse and trypanosomiasis in Africa. *Preventive Veterinary Medicine*, **11**, 201–220
- Rohani, P., Green, C.J., Mantilla-Beniers, N.B. and Grenfell, B.T. (2003) Ecological interference between fatal diseases. *Nature*, **422**, 885–888
- Roitt, I.M. (1994) *Essential Immunology*, 8th edn. Blackwell Scientific Publications, Oxford

- Rolfe, D.C. (1986) The development of an animal disease information system. In: Proceedings of the Fourth International Symposium on Veterinary Epidemiology and Economics, Singapore, 18–22 November 1985, pp. 362–364
- Romagnano, A. (1999) Examination and preventive medicine protocols in psittacines. *The Veterinary Clinics of North America, Exotic Animal Practice*, **2**, 333–355
- Romero, J.J., Perez, E., Dolz, G. and Frankena, K. (2002) Factors associated with *Neospora caninum* serostatus in cattle of 20 specialised Costa Rican dairy herds. *Preventive Veterinary Medicine*, **53**, 263–273
- Roneus, B., Anderson, A.-M. and Ekman, S. (1997) Racing performance in Standardbred Trotters with chronic synovitis after partial arthroscopic synovectomy in the meta-carpophalangeal, metatarsophalangeal and inter-carpal (midcarpal) joints. *Acta Veterinaria Scandinavica*, **38**, 87–95
- Rooney, J.R. (1982) The relationship of season of the year to lameness and breakdown in thoroughbred racehorses. *Journal of Equine Veterinary Science*, **2**, 174–176
- Roos, L.L., Sharp, S.M. and Wajda, A. (1989) Assessing data quality: a computerized approach. *Social Science Medicine*, **28**, 175–182
- Roper, T.J., Garnett, B.T. and Delahay, R.J. (2003) Visits to farm buildings and cattle troughs by badgers (*Meles meles*); a potential route for transmission of bovine tuberculosis (*Mycobacterium bovis*) between badgers and cattle. *Cattle Practice*, **11**, 9–12
- Rose, N., Beaudreau, F., Drouin, P., Toux, J.Y., Rose, V. and Colin, P. (1999) Risk factors for *Salmonella enterica* subsp. *Enterica* contamination in French broiler-chicken flocks at the end of the rearing period. *Preventive Veterinary Medicine*, **39**, 265–277
- Rose, N., Larour, G., Le Diguierher, G., Eveno, E., Jolly, J.P., Blanchard, P., Oger, A., Le Dimna, M., Jestin, A. and Madec, F. (2003) Risk factors for porcine post-weaning multisystemic wasting syndrome (PMWS) in 149 French farrow-to-finish herds. *Preventive Veterinary Medicine*, **61**, 209–225
- Rosen, G. (Translator) (1938) *Jacob Henle: On Miasmata and Contagia. (Van den Miasmen und Kontagien)*. Johns Hopkins Press, Baltimore. (Reprinted from the *Bulletin of the Institute of the History of Medicine*, **VI** (8), October 1938)
- Rosenberg, F.J., Astudillo, V.M. and Goic, R. (1980) Regional strategies for the control of foot-and-mouth disease – an ecological outlook. In: *Veterinary Epidemiology and Economics*. Proceedings of the Second International Symposium, Canberra, 7–11 May 1979. Eds Geering, W.A., Roe, R.T. and Chapman, L.A., pp. 587–596
- Rosenquist, H., Nielsen, N.L., Sommer, H.M., Nørrung, B. and Christensen, B.B. (2003) Quantitative risk assessment of human campylobacteriosis associated with thermophilic *Campylobacter* species in chickens. *International Journal of Food Microbiology*, **83**, 87–103
- Rosenthal, R. (1979) The 'file drawer problem' and tolerance for null results. *Psychological Bulletin*, **85**, 185–193
- Roslow, S. and Roslow, L. (1972) Unlisted phone subscribers are different. *Journal of Advertising Research*, **12**, 35–38
- Rosqvist, R., Skurnik, M. and Wolf-Watz, H. (1988) Increased virulence of *Yersinia pseudotuberculosis* by independent mutations. *Nature*, **334**, 522–526
- Ross, J., Tittensor, A.M., Fox, A.P. and Sanders, M.F. (1989) Myxomatosis in farmland rabbit populations in England and Wales. *Epidemiology and Infection*, **103**, 333–357
- Ross, J.G. (1978) Stormont 'wet-day' fluke forecasting. In: *Weather and Parasitic Animal Disease*. Ed. Gibson, T.E., pp. 4–20. World Meteorological Organization Technical Note No. 159
- Ross, W.A. and Kaneene, J.B. (1996) An individual-animal-level prospective study of risk factors associated with the occurrence of lameness in the Michigan (USA) equine population. *Preventive Veterinary Medicine*, **29**, 59–75
- Ross, W.A., Kaneene, J.B. and Gardiner, J.C. (1998) Survival analysis of risk factors associated with the occurrence of lameness in a Michigan horse population. *American Journal of Veterinary Research*, **59**, 23–29
- Rossano, M.G., Kaneene, J.B., Marteniuk, J.V., Banks, B.D., Schott II, H.C. and Mansfield, L.S. (2003) A herd-level analysis of risk factors for antibodies to *Sarcocystis neurona* in Michigan equids. *Preventive Veterinary Medicine*, **57**, 7–13
- Roth, H.H., Keymer, I.F. and Appleby, E.C. (1973) Computerised data recording from captive and free-living wild animals. *International Zoo Yearbook*, **13**, 252–257
- Rothman, K.J. (1975) A pictorial representation of confounding in epidemiologic studies. *Journal of Chronic Diseases*, **28**, 101–108
- Rothman, K.J. (1976) Causes. *American Journal of Epidemiology*, **104**, 587–592
- Rothman, K.J. and Greenland, S. (1998) *Modern Epidemiology*, 2nd edn. Lippincott-Raven, Philadelphia
- Roudebush, P. (1984) Canine cough knowledge coupler. In: Proceedings of the Second Symposium on Computer Applications in Veterinary Medicine, College of Veterinary Medicine, Mississippi State University, 23–25 May 1984, pp. 127–129
- Roueché, B. (1991) *The Medical Detectives*. Truman Talley Books/Plume, New York
- Rowe, W.D. (1977) *An Anatomy of Risk*. John Wiley, New York
- Rowlands, G.J. and Booth, J.M. (1989) Methods of analysis of disease incidence data in a survey of bovine clinical mastitis. In: Society for Veterinary Epidemiology and Preventive Medicine, Proceedings, Exeter, 12–14 April 1989. Ed. Rowlands, G.J., pp. 25–36
- Rowlands, G.J., Russell, A.M. and Williams, L.A. (1983) Effects of season, herd size, management system and veterinary practice on the lameness incidence in dairy cattle. *Veterinary Record*, **113**, 441–445
- Rowlands, G.J., Lucey, S. and Russell, A.M. (1986) Susceptibility to disease in the dairy cow and its relationship with occurrences of other diseases in the current or preceding lactation. *Preventive Veterinary Medicine*, **4**, 223–234
- Roy, J.H.B. (1980) *The Calf. Studies in the Agricultural and Food Sciences*, 4th edn. Butterworths, London and Boston
- Rubarth, S. (1947) An acute virus disease with liver lesion in dogs (Hepatitis contagiosa canis) a pathologico-anatomical and etiological investigation. *Acta pathologica et microbiologica scandinavica*, **69**, (Suppl.), 1–222
- Ruble, R.P. and Hird, D.W. (1993) Congenital abnormalities in immature dogs from a pet store: 253 cases (1987–1988).

- Journal of the American Veterinary Medicine Association*, **202**, 633–636
- Rudman, R. and Keiper, R.R. (1991) The body condition score of feral ponies on Assateague Island. *Equine Veterinary Journal*, **23**, 453–456
- Rueg, P.L. (2001) Health and production management in dairy herds. In: *Herd Health: Food Animal Production Medicine*, 3rd edn. Ed. Radostits, O.M., pp. 211–254. W.B. Saunders, Philadelphia
- Rugbjerg, H., Proschowsky, H.F., Ersbøll, A.K. and Lund, J.D. (2003) Risk factors associated with interdog aggression and shooting phobias among purebred dogs in Denmark. *Preventive Veterinary Medicine*, **58**, 85–100
- Rupp, R., Beaudeau, F. and Boichard, D. (2000) Relationship between milk somatic-cell counts in the first lactation and clinical mastitis occurrence in the second lactation of French Holstein cows. *Preventive Veterinary Medicine*, **46**, 99–111
- Ruppanner, R. (1972) Measurement of disease in animal populations based on interviews. *Journal of the American Veterinary Medical Association*, **161**, 1033–1038
- Rushen, J. (1986) Some problems with the physiological concept of 'stress'. *Australian Veterinary Journal*, **63**, 359–361
- Russel, A. (1985) Nutrition of the pregnant ewe. In *Practice*, **7**, 23–28
- Russel, A. (1991) Body condition scoring of sheep. In: *Sheep and Goat Practice*, Ed. Boden, E., pp. 3–10. Baillière Tindall, London
- Russell, A.M. and Rowlands, G.J. (1983) COSREEL: Computerised recording system for herd health information management. *Veterinary Record*, **112**, 189–193
- Russell, A.M., Rowlands, G.J., Shaw, S.R. and Weaver, A.D. (1982) Survey of lameness in British dairy cattle. *Veterinary Record*, **111**, 155–160
- Rutter, J.M. (1982) Diseases caused by mixed agents and factors. In: *The Control of Infectious Diseases in Farm Animals*, pp. 5–10. British Veterinary Association Trust Project on the future of animal health control, London
- Ryan, T.J. and Yates, E.M. (1994) The New Zealand national livestock database. In: Proceedings of the 7th International Symposium on Veterinary Epidemiology and Economics, Nairobi, 15–19 August 1994. Eds Rowlands, G.J., Kyule, M.N. and Perry, B.D. *The Kenya Veterinarian*, **18** (2), 325–327
- Sackett, D.L. (1979) Bias in analytic research. *Journal of Chronic Diseases*, **32**, 51–68
- Sackett, D.L., Haynes, R.B., Guyatt, G.H. and Tugwell, P. (1991) *Clinical Epidemiology: a Basic Science for Clinical Medicine*, 2nd edn. Little, Brown and Company, Boston
- Sackett, D.L., Straus, S.E., Richardson, W.S., Rosenberg, W. and Haynes, R.B. (2000) *Evidence-Based Medicine: How to Practice and Teach EBM*, 2nd edn. Churchill Livingstone, Edinburgh
- Sacks, H.S., Berrier, J., Reitman, D., Ancone-Berk, V.A. and Chalmers, T.C. (1987) Meta-analysis of controlled clinical trials. *New England Journal of Medicine*, **316**, 450–455
- Sacks, J.J., Sinclair, L., Gilchrist, J., Golab, G.C. and Lockwood, R. (2000) Breeds of dogs involved in fatal human attacks in the United States between 1979 and 1998. *Journal of the American Veterinary Medical Association*, **217**, 836–840
- Sahai, H. and Kurshid, A. (1995) *Statistics in Epidemiology, Methods and Applications*. CRC Press, Boca Raton
- Saito, M., Muñana, K.R., Sharp, N.J.H. and Olby, N.J. (2001) Risk factors for development of status epilepticus in dogs with idiopathic epilepsy and effects of status epilepticus on outcome and survival time: 32 cases (1990–1996). *Journal of the American Veterinary Medical Association*, **219**, 618–623
- Sakamoto, K. and Yoshida, K. (2002) Recent outbreaks of foot and mouth disease in countries of east Asia. *Revue Scientifique et Technique, Office International des Epizooties*, **21**, 459–463
- Sallander, M., Hedhammar, Å., Rindgren, M. and Lindberg, J.E. (2001) Demographic data of a population of insured Swedish dogs measured in a questionnaire study. *Acta Veterinaria Scandinavica*, **42**, 71–80
- Salman, M.D. (2004) Controlling emerging diseases in the 21st century. *Preventive Veterinary Medicine*, **62**, 177–184
- Salman, M.D., Reif, J.S., Rupp, L. and Aaronson, M.J. (1990) Chlorinated hydrocarbon insecticides in Colorado beef cattle – a pilot environmental monitoring system. *Journal of Toxicology and Environmental Health*, **31**, 125–132
- Saloniemi, H. and Roine, K. (1981) Incidence of some metabolic diseases in dairy cows. *Nordisk Veterinærmedicin*, **33**, 289–296
- Saloniemi, H., Grohn, Y.T. and Erb, H.N. (1988) Epidemiology of reproductive disorders in Finnish Ayrshire dairy cattle. In: *Environment and Animal Health*. Proceedings of the 6th International Congress on Animal Hygiene, 14–17 June 1988, Skara, Sweden, Vol. 1. Ed. Ekesbo, I., pp. 56–59
- Salt, J. (1994) The epidemiological significance of foot and mouth disease virus carriers: a review. In: Society for Veterinary Epidemiology and Preventive Medicine, Proceedings, Belfast, 13–15 April 1994. Ed. Thrusfield, M.V., pp. 71–84
- Samsa, G.P. (1996) Sampling distributions of  $p_{\text{pos}}$  and  $p_{\text{neg}}$ . *Journal of Clinical Epidemiology*, **49**, 917–919
- Samuel, A.T. and Knowles, N.J. (2001) Foot-and-mouth disease type O viruses exhibit genetically and geographically distinct evolutionary lineages (topotypes). *Journal of General Virology*, **82**, 609–621
- Samuels, M.L. (1989) *Statistics for the Life Sciences*. Deller Publishing, San Francisco
- Sandals, W.C.D., Curtis, R.A., Cote, J.F. and Martin, S.W. (1979) The effect of retained placenta and metritis complex on reproductive performance in dairy cattle: a case-control study. *Canadian Veterinary Journal*, **20**, 131–135
- Sandberg, M., Bergsjø, B., Hofshagen, M., Skjerve, E. and Kruse, H. (2002) Risk factors for *Campylobacter* infection in Norwegian cats and dogs. *Preventive Veterinary Medicine*, **55**, 241–253
- Sanderson, M.W. and Dargatz, D.A. (2000) Risk factors for high herd level calf morbidity risk from birth to weaning in beef herds in the USA. *Preventive Veterinary Medicine*, **44**, 97–106
- Sandman, P.M. (1987) Risk communication: facing public outrage. *EPA Journal*, **13** (9), 21–22
- Sangaré, O., Bastos, A.D.S., Ventner, E.H. and Vosloo, W. (2004) A first molecular epidemiological study of SAT-2

- type foot-and-mouth disease viruses in West Africa. *Epidemiology and Infection*, **132**, 525–532
- Sanson, R.L. (1994) The epidemiology of foot-and-mouth disease: implications for New Zealand. *New Zealand Veterinary Journal*, **42**, 41–53
- Sanson, R.L. and Pearson, A. (1997) AgriBase – a national spatial farm database. In: Proceedings of the 8th International Symposium on Veterinary Epidemiology and Economics, Paris, July 1997. *Epidémiologie et Santé Animale*, **31–32**, Vol. 2, pp. 12.16.1–12.16.3
- Sanson, R.L., Pfeiffer, D.U. and Morris, R.S. (1991a) Geographic information systems: their applications in animal disease control. *Revue Scientifique et Technique, Office International des Epizooties*, **10**, 179–195
- Sanson, R.L., Liberona, H. and Morris, R.S. (1991b) The use of a geographical information system in the management of a foot-and-mouth disease epidemic. *Preventive Veterinary Medicine*, **11**, 309–313
- Sanson, R.L., Morris, R.S. and Stern, M.W. (1999) EpiMAN-FMD a decision support system for managing epidemics of vesicular disease. *Revue Scientifique et Technique, Office International des Epizooties*, **18**, 593–605
- Sanson, R.L., Brooks, H.V. and Horner, G.W. (2000) An epidemiological study of the spread of rabbit haemorrhagic disease virus amongst previously non-exposed rabbit populations in the North Island of New Zealand. *New Zealand Veterinary Journal*, **48**, 105–110
- Sard, D.M. (1979) *Dealing with Data: The Practical Use of Numerical Information*. British Veterinary Association Publications, London
- Sargeant, A.B., Allen, S.H. and Hastings, J.O. (1987) Spatial relations between sympatric coyotes and red foxes in North Dakota. *Journal of Wildlife Management*, **51**, 285–293
- Sargeant, J.M. and Martin, S.W. (1998) The dependence of kappa on attribute prevalence when assessing the repeatability of questionnaire data. *Preventive Veterinary Medicine*, **34**, 115–123
- Sartwell, P.E. (1950) The distribution of incubation periods of infectious disease. *American Journal of Hygiene*, **51**, 310–318
- Sartwell, P.E. (1966) The incubation period and the dynamics of infectious disease. *American Journal of Epidemiology*, **83**, 204–216
- Sartwell, P.E. (1973) *Preventive Medicine and Public Health*. Appleton, Century Crofts, New York
- Sasaki, M. (1991) Eradication of rinderpest – a review. In: *South Asia Rinderpest Eradication Campaign*. Proceedings of the Regional Expert Consultation on Rinderpest Eradication in South Asia, Bangkok, Thailand, 5–8 June 1990. RAPA Publication 1991/8, pp. 67–77. Food and Agriculture Organization, Bangkok
- Saville, W.J., Reed, S.M., Morley, P.S., Granstrom, D.E., Kohn, C.W., Hinchcliff, K.W. and Wittum, T.E. (2000) Analysis of risk factors for the development of equine protozoal myeloencephalitis in horses. *Journal of the American Veterinary Medical Association*, **8**, 1174–1180
- Savini, G., Robertson, I.D. and Dunsmore, J.D. (1994) Risk factors associated with the occurrence of sarcocystosis in Western Australia; results of a postal survey. *Preventive Veterinary Medicine*, **19**, 137–144
- Scarff, D.H. and Lloyd, D.H. (1992) Double blind, placebo-controlled, crossover study of evening primrose oil in the treatment of canine atopy. *Veterinary Record*, **131**, 97–99
- Scarlett, J.M., Moise, N.S. and Rayl, J. (1988) Feline hyperthyroidism: a descriptive and case-control study. *Preventive Veterinary Medicine*, **6**, 295–309
- Scarlett, J.M., Saidla, J.E. and Pollock, R.V.H. (1994) Source of acquisition as a risk factor for disease and death in pups. *Journal of the American Veterinary Medical Association*, **204**, 1906–1913
- Schaberg, D.R., Power, G., Betzold, J. and Forbes, B.A. (1985) Conjugative R plasmids in antimicrobial resistance of *Staphylococcus aureus* causing nosocomial infections. *Journal of Infectious Diseases*, **152**, 43–49
- Schachter, J., Sugg, N. and Sung, M. (1978) Psittacosis: the reservoir persists. *Journal of Infectious Diseases*, **137**, 44–49
- Schalk, A.F. and Hawn, M.C. (1931) An apparently new respiratory disease of baby chicks. *Journal of the American Veterinary Medical Association*, **78**, 413–422
- Scheaffer, R.L., Mendenhall, W. and Ott, L. (1979) *Elementary Survey Sampling*, 2nd edn. Duxbury Press, Belmont
- Schepers, J.A. (1990) Data requirements and objectives for economic analyses of disease in farm livestock. In: *Society for Veterinary Epidemiology and Preventive Medicine, Proceedings, Belfast, 4–6 April 1990*. Ed. Thrusfield, M.V., pp. 120–132
- Scherer, W.F., Moyer, J.T., Izumi, T., Gresser, I. and McCown, J. (1959) Ecologic studies of Japanese encephalitis virus in Japan. VI. Swine infection. *American Journal of Tropical Medicine and Hygiene*, **8**, 698–706
- Schlesselman, J.J. (1982) *Case-Control Studies: Design, Conduct, Analysis*. Oxford University Press, New York
- Schmelzer, L.L. and Tabershaw, I.R. (1968) Exposure factors in occupational coccidioidomycosis. *American Journal of Public Health*, **58**, 107–113
- Schmitz, O.J. and Nudds, T.D. (1993) Parasite-mediated competition in deer and moose: How strong is the effect of a meningeal worm on moose? *Ecological Applications*, **4**, 91–103
- Schneider, R. (1970) Comparison of age, sex, and incidence rates in human and canine breast cancer. *Cancer*, **26**, 419–426
- Schneider, R. (1975) Observations on overpopulation of dogs and cats. *Journal of the American Veterinary Medical Association*, **167**, 281–284
- Schneider, R. (1976) Epidemiologic studies of cancer in man and animals sharing the same environment. In: *Prevention and Detection of Cancer. Vol. 2. Part I Etiology: prevention methods*. Proceedings of the 3rd International Symposium on the Detection and Prevention of Cancer, New York, 26 April–1 May 1976. Ed. Nieburgs, H.E., pp. 1377–1387. Marcel Dekker, New York
- Schneider, R. (1983) Comparison of age- and sex-specific incidence rate patterns of the leukemia complex in the cat and dog. *Journal of the National Cancer Institute*, **70**, 971–977
- Schneider, R. and Vaida, M.L. (1975) Survey of canine and feline populations: Alameda and Contra Costa Counties, California, 1970. *Journal of the American Veterinary Medical Association*, **166**, 481–486
- Schneider, R., Dorn, C.R. and Taylor, D.O.N. (1969) Factors influencing canine mammary cancer development and

- postsurgical survival. *Journal of the National Cancer Institute*, **43**, 1249–1261
- Schneiderman, M.A. (1980) The uncertain risks we run: hazardous materials. In: *Societal Risk Assessment: How Safe is Enough?* Eds Schwing, R.C. and Albers, A., pp. 19–37 (Discussion: pp. 38–41). Plenum Press, New York
- Schnurrenberger, P.R., Kangilaski, E., Berg, L.E. and Bashe, W.J. (1961) Characteristics of a rural Ohio dog population. *Veterinary Medicine*, **56**, 519–523
- Schofield, F.W. (1949) Virus enteritis in mink. *North American Veterinarian*, **30**, 651–654
- Schouten, J.M., Bouwknegt, M., van de Giessen, A.W., Frankena, K. and Graat, E.A.M. (2001) Risk factor analysis of *Escherichia coli* 0157 on Dutch Dairy Farms: preliminary results. In: Society for Veterinary Epidemiology and Preventive Medicine, Proceedings, Noordwijkerhout, The Netherlands, 29–30 March 2001, Eds Menzies, F.D. and Reid, S.W.J., pp. 202–210
- Schouten, J.M., Bouwknegt, M., van de Giessen, A.W., Frankena, K., De Jong, M.C.M. and Graat, E.A.M. (2004) Prevalence estimation and risk factors for *Escherichia coli* 0157 on Dutch dairy farms. *Preventive Veterinary Medicine*, **64**, 49–61
- Schrader-Frechette, K.S. (1991) *Risk and Rationality: Philosophical Foundations for Populist Reforms*. University of California Press, Berkeley
- Schrag, S.J. and Wiener, P. (1995) Emerging infectious diseases: what are the relative roles of ecology and evolution? *Trends in Ecology and Evolution*, **10**, 319–324
- Schukken, Y.H., Erb, H.N. and Smith, R.D. (1988) The relationship between mastitis and retained placenta in a commercial population of Holstein dairy cows. *Preventive Veterinary Medicine*, **5**, 181–190
- Schukken, Y.H., Erb, H.N., White, M.E., Schwager, S.J. and Scholl, D.T. (1990) A review of statistical techniques to evaluate space-time clustering in disease occurrence. In: Society for Veterinary Epidemiology and Preventive Medicine, Proceedings, Belfast, 4–6 April 1990. Ed. Thrusfield, M.V., pp. 167–178
- Schultz, R.D. (Ed.) (1999) *Veterinary Vaccines and Diagnostics. Advances in Veterinary Medicine*, Vol. 41. Academic Press, San Diego
- Schwabe, A.E. and Hall, S.J.G. (1989) Dystocia in nine British breeds of cattle and its relationship to the dimensions of the dam and calf. *Veterinary Record*, **125**, 636–639
- Schwabe, C. (1982) The current epidemiological revolution in veterinary medicine. Part 1. *Preventive Veterinary Medicine*, **1**, 5–15
- Schwabe, C.W. (1980a) Animal disease control. Part I. Developments prior to 1960. *Sudan Journal of Veterinary Science and Animal Husbandry*, **21**, 43–54
- Schwabe, C.W. (1980b) Animal disease control. Part II. Newer methods, with possibility for their application in the Sudan. *Sudan Journal of Veterinary Science and Animal Husbandry*, **21**, 55–65
- Schwabe, C.W. (1984) *Veterinary Medicine and Human Health*, 3rd edn. Williams and Wilkins, Baltimore and London
- Schwabe, C.W., Riemann, H. and Franti, C. (1977) *Epidemiology in Veterinary Practice*. Lea and Febiger, Philadelphia
- Scott, G.R. (1964) Rinderpest. *Advances in Veterinary Science*, **9**, 113–224
- Scott, G.R. (1981) Rinderpest. In: *Infectious Diseases of Wild Mammals*, 2nd edn. Eds. Davis, J.W., Karstad, L.H. and Trainer D.O., pp. 18–30. Iowa State University Press, Ames
- Scott, G.R. (1996) The history of rinderpest in Britain: Part One: 809–1799. *State Veterinary Journal*, **6** (4), 8–10
- Scott, G.R. (1997) The history of rinderpest in Britain: Part Two: 1800 to date. *State Veterinary Journal*, **7** (1), 9–13
- Scott, H.M., Soskolne, C.L., Lissemore, K.D., Martin, S.W., Shoukri, M.M., Coppock, R.W. and Guidotti, T.L. (2003a) Associations between air emissions from sour gas processing plants and indices of cow retainment and survival in dairy herds in Alberta. *Canadian Journal of Veterinary Research*, **67**, 1–11
- Scott, H.M., Soskolne, C.L., Martin, S.W., Basarab, J.A., Coppock, R.W., Guidotti, T.L. and Lissemore, K.D. (2003b) Lack of associations between air emissions from sour-gas processing plants and beef cow-calf herd health and productivity in Alberta, Canada. *Preventive Veterinary Medicine*, **57**, 35–68
- Scott, P.R. (2001) Health and production management in sheep flocks. In: *Herd Health: Food Animal Production Medicine*, 3rd edn. Ed. Radostits, O.M., pp. 765–844. W.B. Saunders, Philadelphia
- Scott, R.J. (1981) Zoonoses in the abattoir. In: *Advances in Veterinary Public Health*, Vol. 2. Ed. Senevirata, P., pp. 68–82. Australian College of Veterinary Scientists, Brisbane
- Scudamore, J.M. (1984) The international cattle trade problems and control of disease. *British Veterinary Journal*, **140**, 413–429
- Scudamore, J.M. (1995) GATT and the principles of risk assessment as they apply to trade. In: Society for Veterinary Epidemiology and Preventive Medicine, Proceedings, Reading, 29–31 March 1995. Ed. Goodall, E.A., pp. 34–39
- Scudamore, J.M. (2000) Surveillance – past, present and future. In: Society for Veterinary Epidemiology and Preventive Medicine, Proceedings, Edinburgh, 29–31 March 2000, Eds Thrusfield, M.V. and Goodall, E.A., pp. xi–xx
- Scudamore, J.M. (2004) FMD – differentiating vaccinated from infected animals. *The Veterinary Journal*, **167**, 3–4
- Seahorn, J.L., Slovis, N.M., Reimer, J.M., Carey, V.J., Donahue, J.G. and Cohen, N.D. (2003) Case-control study of factors associated with fibrinous pericarditis among horses in central Kentucky during spring 2001. *Journal of the American Veterinary Medical Association*, **223**, 832–838
- Searcy-Bernal, R., Gardner, I.A. and Hird, D.W. (1994) Effects of and factors associated with umbilical hernias in a swine herd. *Journal of the American Veterinary Medical Association*, **204**, 1660–1664
- Seber, G.A.F. (1973) *The Estimation of Animal Abundance*. Hafner Press, New York
- Seifi, H., Nowrouzian, I. and Zakarian, B. (1995) Risk factors associated with bovine urinary bladder tumors in Iran. *Preventive Veterinary Medicine*, **22**, 55–60
- Selby, L.A., Corwin, R.M. and Hayes, H.M. (1980) Risk factors associated with canine heartworm infection. *Journal of the American Veterinary Medical Association*, **176**, 33–35
- Selby, L.A., Edmonds, L.D. and Hyde, L.D. (1976) Epidemiological field studies of animal populations. *Canadian Journal of Comparative Medicine*, **40**, 135–141

- Selby, L.A., Edmonds, L.D., Parke, D.W., Stewart, R.W., Marienfeld, C.J. and Heidlage, W.F. (1973) Use of mailed questionnaire data in a study of swine congenital malformations. *Canadian Journal of Comparative Medicine*, **37**, 413–417
- Selikoff, I.J., Hammond, E.C. and Seidman, H. (1979) Mortality experience of insulation workers in the United States and Canada, 1943–1976. *Annals of the New York Academy of Sciences*, **330**, 91–116
- Sellers, R.F. (1971) Quantitative aspects of the spread of foot and mouth disease. *Veterinary Bulletin*, **41**, 431–439
- Sellers, R.F. (1982) Eradication – local and national. In: *The Control of Infectious Diseases in Farm Animals*, pp. 18–21. British Veterinary Association Trust Project on the Future of Animal Health Control, London
- Sellers, R.F. and Forman, A.J. (1973) The Hampshire epidemic of foot and mouth disease, 1967. *Journal of Hygiene, Cambridge*, **71**, 15–34
- Sellers, R.F. and Gloster, J. (1980) The Northumberland epidemic of foot-and-mouth disease, 1966. *Journal of Hygiene, Cambridge*, **85**, 129–140
- Sellers, R.F. and Maarouf, A.R. (1990) Trajectory analysis of winds and vesicular stomatitis virus in North America, 1982–85. *Epidemiology and Infection*, **104**, 313–328
- Sellers, R.F., Pedgley, D.E. and Tucker, M.R. (1978) Possible windborne spread of bluetongue to Portugal, June–July, 1956. *Journal of Hygiene, Cambridge*, **81**, 189–196
- Selvin, H.C. (1958) Durkheim's 'Suicide' and problems of empirical research. *American Journal of Sociology*, **63**, 607–619
- Selye, H. (1946) The general adaptation syndrome and the diseases of adaptation. *Journal of Clinical Endocrinology*, **6**, 117–230
- Sembrat, R.F. (1975) The acute abdomen in the horse. Epidemiological considerations. *Archives of the American College of Veterinary Surgeons*, **4** (2), 34–39
- Senior, J.M., Pinchbeck, G.L., Dugdale, A.H.A. and Clegg, P.D. (2004) Retrospective study of the risk factors and prevalence of colic in horses after orthopaedic surgery. *Veterinary Record*, **155**, 321–325
- Senn, S. (1993) *Cross-over Trials in Clinical Research*. John Wiley, Chichester and New York
- Sergeant, E.S.G., Marshall, D.J., Eamens, G.J., Kearns, C. and Whittington, R.J. (2003) Evaluation of an absorbed ELISA and an agar-gel immuno-diffusion test for ovine paratuberculosis in sheep in Australia. *Preventive Veterinary Medicine*, **61**, 235–248
- Service, M.W. (1989) Irrigation: boon or bane. In: *Demography and Vector-Borne Diseases*. Ed. Service, M.W., pp. 237–254. CRC Press, Boca Raton
- Setbon, M., Rande, J., Fischler, C. and Flahault, A. (2005) Risk perception of the 'Mad Cow Disease' in France: determinants and consequences. *Risk Analysis*, **25**, 813–826
- Sewell, M.M.H. and Brocklesby, D.W. (Eds) (1990) *Handbook on Animal Diseases in the Tropics*, 4th edn. Baillière Tindall, London
- Shafer, G. (1996) *The Art of Causal Conjecture*. MIT Press, Cambridge, Massachusetts
- Shane, S.M., Gyimah, J.E., Harrington, K.S. and Snider, T.G. (1985) Etiology and pathogenesis of necrotic enteritis. *Veterinary Research Communications*, **9**, 269–287
- Shapiro, S.H. (1997) Confounding by indication? *Epidemiology*, **8**, 110–111
- Sharma, S.K. (1978) Studies on FMD virus in sheep with special reference to distribution of the virus and carrier status. *Veterinary Research Bulletin*, **1**, 156–157
- Shewhart, W.A. (1931) *The Economic Control of the Quality of the Manufactured Product*. Macmillan, New York
- Shirima, G.M., Kazwala, R.R. and Kambarage, D.M. (2003) Prevalence of bovine tuberculosis in cattle in different farming systems in the eastern zone of Tanzania. *Preventive Veterinary Medicine*, **57**, 167–172
- Shope, R.E. (1931) Swine influenza. III. Filtration experiment and etiology. *Journal of Experimental Medicine*, **54**, 373–385
- Short, C.E. (Ed.) (1987) *Principles and Practice of Veterinary Anesthesia*. Williams and Wilkins, Baltimore
- Short, N. (2002) The use of information and communication technology in veterinary education. *Research in Veterinary Science*, **72**, 1–6
- Shott, S. (1985) Statistics in veterinary research. *Journal of the American Veterinary Medical Association*, **187**, 138–141
- Shumway, R.H. and Stoffer, D.S. (2000) *Time Series and its Applications*. Springer, New York
- Shuster, J. (1992) *Practical Handbook of Sample Size Guidelines for Clinical Trials*. CRC Press, Boca Raton
- Siegel, S. and Castellan, N.J. (1988) *Nonparametric Statistics for the Behavioral Sciences*, 2nd edn. McGraw-Hill, New York
- Sigurdsson, B. (1954) Maedi, a slow progressive pneumonia of sheep: an epizootiological and pathological study. *British Veterinary Journal*, **110**, 255–270
- Sillero-Zubiri, C., King, A.A. and MacDonald, D.W. (1996) Rabies and mortality in Ethiopian wolves (*Canis simensis*). *Journal of Wildlife Diseases*, **32**, 80–86
- Sim, J. and Wright, C.C. (2005) The kappa statistic in reliability studies: use, interpretation, and sample size requirements. *Physical Therapy*, **85**, 257–268
- Simmons, A. and Cuthbertson, J.C. (1985) Time series analysis of ovine pneumonia using Scottish slaughterhouse data. In: *Society for Veterinary Epidemiology and Preventive Medicine, Proceedings, Reading, 27–29 March 1985*. Ed. Thrusfield, M.V., pp. 130–141
- Simpson, B.H. and Wright, D.F. (1980) The use of questionnaires to assess the importance of clinical disease in sheep. In: *Veterinary Epidemiology and Economics. Proceedings of the Second International Symposium, Canberra, 7–11 May 1979*. Eds. Geering, W.A., Roe, R.T. and Chapman, L.A., pp. 97–105. Australian Government Publishing Service, Canberra
- Simpson, G.G. (1951) *Horses: The Story of the Horse Family in the Modern World through Sixty Million Years of History*. Oxford University Press, New York
- Simpson, V.R. (2002) Wild animals as reservoirs of infectious diseases in the UK. *The Veterinary Journal*, **163**, 128–146
- Sinclair, A.R.E. and Norton-Griffiths, M. (Eds) (1979) *Serengeti: Dynamics of an Ecosystem*. University of Chicago Press, Chicago
- Sinclair, I.J., Tarry, D.W. and Wassall, D.A. (1989) Serological survey of the incidence of *Hypoderma bovis* in cattle in 1988. *Veterinary Record*, **124**, 243–244
- Singer, E.R., Saxby, F. and French, N.P. (2003) A retrospective case-control study of horse falls in the sport of horse

- trials and three-day eventing. *Equine Veterinary Journal*, **35**, 139–145
- Singer, P. (2000) *Writings on an Ethical Life*. Fourth Estate, London
- Singer, R.S., Case, J.T., Carpenter, T.E., Walker, R.L. and Hirsh, D.C. (1998) Assessment of spatial and temporal clustering of ampicillin and tetracyclin-resistant strains of *Pasteurella multocida* and *P. haemolytica* isolated from cattle in California. *Journal of the American Veterinary Medical Association*, **212**, 1001–1005
- Singh, K.P.R., Khorshed, M.P. and Anderson, C.R. (1964) Transmission of Kyasanur Forest Disease virus by *Haemaphysalis turturis*, *Haemaphysalis papuana kinmeari* and *Haemaphysalis minuta*. *Indian Journal of Medical Research*, **52**, 566–573
- Singleton, W.B. (1993) Companion animal medicine: future outlook. In: *The Advancement of Veterinary Science. The Bicentenary Symposium Series. Volume 1: Veterinary Medicine beyond 2000*. Ed. Michell, A.R., pp. 249–263. CAB International, Wallingford
- Sinnecker, H. (1976) *General Epidemiology*. Transl. Walker, N. John Wiley, London
- Sjöberg, L. (2001) Political decisions and public risk perception. *Reliability Engineering and System Safety*, **72**, 115–123
- Skjerve, E., Waldeland, H., Nesbakken, T. and Kapperud, G. (1998) Risk factors for the presence of antibodies to *Toxoplasma gondii* in Norwegian slaughter lambs. *Preventive Veterinary Medicine*, **35**, 219–227
- Slater, M. (1997) How good are data from questionnaires: a review of measuring reliability. In: Proceedings of the 8th International Symposium on Veterinary Epidemiology and Economics, Paris, July 1997. *Epidémiologie et Santé Animale*, **31–32**, Volume 2, pp. 12.09.1–12.09.3
- Slater, M.R. (1996a) Methods and issues in conducting breed-specific canine health surveys. *Preventive Veterinary Medicine*, **28**, 69–79
- Slater, M.R. (1996b) Nutritional epidemiology in small animal medicine. In: Society for Veterinary Epidemiology and Preventive Medicine, Proceedings, Glasgow, 27–29 March 1996. Eds Thrusfield, M.V. and Goodall, E.A., pp. 117–126
- Slater, M.R. (2001) The role of veterinary epidemiology in the study of free-roaming dogs and cats. *Preventive Veterinary Medicine*, **48**, 273–286
- Slater, M.R., Scarlett, J.M. and Erb, H.N. (1991) A comparison of five strategies for selecting control groups: a canine osteochondritis dissecans example. *Preventive Veterinary Medicine*, **10**, 319–326
- Slater, M.R., Scarlett, J.M., Donoghue, S. and Erb, H.N. (1992) The repeatability and validity of a telephone questionnaire on diet and exercise in dogs. *Preventive Veterinary Medicine*, **13**, 77–91
- Slater, M.R., Hood, D.M. and Carter, G.K. (1995) Descriptive epidemiological study of equine laminitis. *Equine Veterinary Journal*, **27**, 364–367
- Slettbakk, T., Jorstad, A., Farver, T.B. and Hird, D.W. (1990) Impact of milking characteristics and teat morphology on somatic cell counts in first-lactation Norwegian cattle. *Preventive Veterinary Medicine*, **8**, 253–267
- Slim, H. and Thomson, P. (1994) Ways of listening: the art of collecting testimony. In: *Listening for A Change*, Eds. Bennet, O. and Cross, N., pp. 61–94. New Society Publishers, Philadelphia
- Slocombe, J.O.D. (1975) Surveillance for parasitism in domestic animals. In: *Animal Disease Monitoring*. Eds Ingram, D.G., Mitchell, W.F. and Martin, S.W., pp. 129–135. Charles C. Thomas, Springfield
- Slovic, P. (2000) *The Perception of Risk*. Earthscan, London
- Sluyter, F.J.H. (2001) Traceability of Equidae: a population in motion. *Revue Scientifique et Technique, Office International des Epizooties*, **20**, 500–509
- Smith, A. (1776) *An Inquiry into the Nature and Causes of the Wealth of Nations*. W. Strahan & T. Cadell, London
- Smith, A.H. and Bates, M.N. (1992) Confidence limit analyses should replace power calculations in the interpretation of epidemiologic studies. *Epidemiology*, **3**, 449–452
- Smith, C.V. (1964) Some evidence for the windborne spread of fowl pest. *Meteorological Magazine*, **93**, 257–263
- Smith, D.R., Fedorka-Cray, P.J., Mohan, R., Brock, K.V., Wittum, T.E., Morley, P.S., Hoblet, K.H. and Saif, L.J. (1998a) Evaluation of cow-level risk factors for the development of winter dysentery in dairy cattle. *American Journal of Veterinary Research*, **59**, 986–993
- Smith, D.R., Fedorka-Cray, P.J., Mohan, R., Brock, K.V., Wittum, T.E., Morley, P.S., Hoblet, K.H. and Saif, L.J. (1998b) Epidemiological herd-level assessment for causative agents and risk factors for winter dysentery in dairy cattle. *American Journal of Veterinary Research*, **59**, 994–1001
- Smith, E.J., Kelly, J.M. and Whitaker, D.A. (1983) Health and fertility data recorded by members of the Dairy Herd Health and Productivity Service. In: Society for Veterinary Epidemiology and Preventive Medicine, Proceedings, Southampton, 12–13 April 1983. Ed. Thrusfield, M.V., pp. 8–12
- Smith, G. (1984) Density-dependent mechanisms in the regulation of *Fasciola hepatica* populations in sheep. *Parasitology*, **88**, 449–461
- Smith, K.A., Kruth, S., Hammermueller, J., Gyles, C. and Wilson, J.B. (1998) A case-control study of verocytotoxigenic *Escherichia coli* infection in cats with diarrhea. *Canadian Journal of Veterinary Research*, **62**, 87–92
- Smith, K.G.V. (Ed.) (1973) *Insects and Other Arthropods of Medical Importance*. The Trustees of the British Museum (Natural History), London
- Smith, L.P. and Hugh-Jones, M.E. (1969) The weather factor in foot-and-mouth disease epidemics. *Nature*, **223**, 712–715
- Smith, M.R.W., Stevens, K.B., Durham, A.E. and Marr, C.M. (2003) Equine hepatic disease: the effect of patient- and case-specific variables on risk and prognosis. *Equine Veterinary Journal*, **35**, 549–552
- Smith, R.A., Stokka, G.L., Radostits, O.M. and Griffin, D. (2001) Health and production management in beef feedlots. In: *Herd Health: Food Animal Production Medicine*, 3rd edn. Ed. Radostits, O.M., pp. 581–633, W.B. Saunders, Philadelphia
- Smith, R.D. (1988) Veterinary clinical research: a survey of study designs and clinical issues appearing in a practice journal. *Journal of Veterinary Medical Education*, **15** (1), 2–7
- Smith, R.D. (2005) *Veterinary Clinical Epidemiology*. 3rd edn. CRC Press, Boca Raton



- Smith, W.D. (1999) Prospects for vaccines of helminth parasites for grazing ruminants. *International Journal of Parasitology*, **29**, 17–24
- Smith, W.J. (1981) Rectal prolapse in swine. *The Pig Veterinary Society Proceedings*, **7**, 68–72
- Smithcors, J.F. (1957) *Evolution of the Veterinary Art*. Veterinary Medicine Publishing Company, Kansas
- Smulders, F.J.M. and Collins, J.D. (Eds) (2002) *Food Safety Assurance and Veterinary Public Health. Vol. 1. Food Safety Assurance in the Pre-harvest Phase*. Wageningen Academic, Wageningen
- Smulders, F.J.M. and Collins, J.D. (Eds) (2004) *Food Safety Assurance and Veterinary Public Health. Vol. 2. Safety Assurance During Food Processing*. Wageningen Academic, Wageningen
- Smyth, J.A., Fitzpatrick, D.A. and Ellis, W.A. (1999) Stillbirth/Perinatal weak calf syndrome: a study of calves infected with *Leptospira*. *Veterinary Record*, **145**, 539–542
- Snary, E.L., Kelly, L.A., Davison, H.C., Teale, C.J. and Wooldridge, M. (2004) Antimicrobial resistance: a microbial risk assessment perspective. *Journal of Antimicrobial Chemotherapy*, **53**, 906–917
- Snedecor, G.W. and Cochran, W.G. (1989) *Statistical Methods*, 8th edn. Iowa State University Press, Ames
- Snell, J.L. (1987) *Introduction to Probability*. Random House, New York
- Snodgrass, D.R. (1974) Studies on bovine petechial fever and tick-borne fever. PhD Thesis. University of Edinburgh
- Snodgrass, D.R., Terzolo, H.R., Sherwood, D., Campbell, I., Menzies, J.D. and Synge, B.A. (1986) Aetiology of diarrhoea in young calves. *Veterinary Record*, **119**, 31–34
- SNOMED (2004) *Systematized Nomenclature of Human and Veterinary Medicine*. <http://www.snomed.com> (Accessed 5 February 2004)
- Snow, J. (1855) *On the Mode of Communication of Cholera*, 2nd edn. Churchill, London. Reproduced in *Snow on Cholera*. Commonwealth Fund, New York, 1936. Reprinted by Hafner, New York, 1965
- Snyder, L. and Champness, W. (1997) *Molecular Genetics of Bacteria*. ASM Press, Washington, DC
- Sokol, D.K. (2002) From anonymity to notoriety. Historical problems associated with outbreaks of emerging infectious diseases: a case study: Ebola haemorrhagic fever. MSc Thesis, University of Oxford
- Solis-Calderon, J.J., Segura-Correa, V.M., Segura-Correa, J.C. and Alvarado-Islas, A. (2003) Seroprevalence of and risk factors for infectious bovine rhinotracheitis in beef cattle herds of Yucatan, Mexico. *Preventive Veterinary Medicine*, **57**, 199–208
- Soll, M.D. and Knight, D.H. (1995) Proceedings of the Heartworm Symposium '95, Auburn, Alabama, 31 March–2 April 1995. (endpaper) American Heartworm Society, Batavia
- Solorio-Rivera, J.L., Rodríguez-Vivas, R.I., Pérez-Gutierrez, E. and Wagner, G. (1999) Management factors associated with *Babesia bovis* seroprevalence in cattle from eastern Yucatán, Mexico. *Preventive Veterinary Medicine*, **40**, 261–269
- Solymosi, N., Reiczigel, J., Berke, O., Harnos, A., Szigeti, S., Fodor, L., Szigeti, G. and Bódis, K. (2004) Spatial risk assessment of herd serostatus of Aujeszky's disease in a county in Hungary. *Preventive Veterinary Medicine*, **65**, 9–16
- Somvanshi, R. (1991) Horn cancer in Indian cattle. *Veterinary Bulletin*, **61**, 901–911
- Sonnenschein, E., Glickman, L.T., McKee, L. and Goldschmidt, M. (1987) Nutritional risk factors for spontaneous breast cancer in pet dogs: a case-control study. *American Journal of Epidemiology*, **126**, 736
- Sonnenschein, E.G., Glickman, L.T., Goldschmidt, M.H. and McKee, L.J. (1991) Body conformation, diet, and risk of breast cancer in pet dogs: a case-control study. *American Journal of Epidemiology*, **133**, 694–703
- Sørensen, J.H., Mackay, D.J., Jensen, C.O. and Donaldson, A.I. (2000) An integrated model to predict the atmospheric spread of foot-and-mouth disease virus. *Epidemiology and Infection*, **124**, 577–590
- Sørensen, J.T. and Enevoldsen, C. (1992) Modelling the dynamics of the health-production complex in livestock herds: a review. *Preventive Veterinary Medicine*, **13**, 287–297
- Sørensen, K.J., Madsen, K.G., Madsen, E.S., Salt, J.S., Nqindi, J. and Mackay, D.K.J. (1998) Differentiation of infection from vaccination in foot-and-mouth disease by the detection of antibodies to the non-structural proteins 3D, 3AB and 3ABC in ELISA using antigens expressed in baculovirus. *Archives of Virology*, **143**, 1461–1476
- Sorensen, M.A., Buss, M.S. and Tyler, J.W. (1995) Accuracy of microchip identification in dogs and cats. *Journal of the American Veterinary Medical Association*, **207**, 766–767
- Soulsby, E.J.L. (1982) *Helminths, Arthropods and Protozoa of Domestic Animals*, 7th edn. Baillière Tindall, London
- Southwood, T.R.E. (1978) *Ecological Methods with Particular Reference to the Study of Insect Populations*, 2nd edn. Chapman and Hall, London
- Spain, C.V., Scarlett, J.M. and Houpt, K.A. (2004a) Long-term risks and benefits of early-age gonadectomy in cats. *Journal of the American Veterinary Medical Association*, **224**, 372–379
- Spain, C.V., Scarlett, J.M. and Houpt, K.A. (2004b) Long-term risks and benefits of early-age gonadectomy in dogs. *Journal of the American Veterinary Medical Association*, **224**, 380–387
- Spangler, E., Dohoo, I.R., Kendall, O. and Hurnik, D. (1991) Influence of pre-slaughter processing factors in the development of pale, soft and exudative pork. In: Proceedings of the Sixth International Symposium on Veterinary Epidemiology and Economics, Ottawa, 12–16 August 1991. Ed. Martin, S.W., pp. 422–424
- Sparkes, A.H., Gruffydd-Jones, T.J., Shaw, S.W., Wright, A.I. and Stokes, C.R. (1993) Epidemiological and diagnostic features of canine and feline dermatophytosis in the United Kingdom from 1956 to 1991. *Veterinary Record*, **133**, 57–61
- Speare, D.J., MacNair, N. and Hammell, K.L. (1995) Demonstration of tank effect on growth indices of juvenile rainbow trout (*Oncorhynchus mykiss*) during an ad libitum feed trial. *American Journal of Veterinary Research*, **56**, 1372–1379
- Spearman, C. (1908) The method of 'right and wrong' cases ('constant stimuli') without Gauss's formulae. *British Journal of Psychology*, **2**, 227–242
- Spedding, C. (2000) *Animal Welfare*. Earthscan Publications, London
- Spedding, C.R.W. (1988) *An Introduction to Agricultural Systems*, 2nd edn. Elsevier Applied Science, London



- Speiser, D. von (1982) Daniel Bernoulli (1700–1782). *Helvetica Physica Acta*, **55**, 504–523
- Spencer, J.E. and Thomas, W.L. (1978) *Introducing Cultural Geography*. John Wiley, New York
- Spinage, C.A. (2003) *Cattle Plague: A History*. Kluwer Academic/Plenum Publishers, New York
- Spinu, I. and Biberi-Moroianu, S. (1969) Theoretical and practical problems concerning the eradication of communicable diseases. *Archives Roumaines de Pathologie Experimentale et de Microbiologie*, **28**, 725–742
- Spire, M.F. (1990) Cow / calf production records: justification, gathering and interpretation. In: Proceedings of the 23rd Annual Convention of the American Association of Bovine Practitioners, Indianapolis, Indiana, 13–16 September 1990, pp. 93–95
- Sprague, R.H. and Carlson, E.D. (1982) *Building Effective Decision Support Systems*. Prentice Hall, Englewood Cliffs
- Srebrnik, N. and Appleby, E.C. (1991) Breed prevalence and sites of haemangioma and haemangiosarcoma in dogs. *Veterinary Record*, **129**, 408–409
- Srinand, S., Ames, T.R., Maheswaran, S.K. and King, V.L. (1995) Efficacy of various vaccines against pneumonic pasteurellosis in cattle: a meta-analysis. *Preventive Veterinary Medicine*, **25**, 7–17
- Stallbaumer, M. and Skrzynecki, E. (1987) The use of discriminant analysis in a case-control study of coccidiosis in European broiler flocks. In: Society for Veterinary Epidemiology and Preventive Medicine, Proceedings, Solihull, 1–3 April 1987. Ed. Thrusfield, M.V., pp. 108–117
- Stallbaumer, M.F. (1983) The prevalence of *Cysticercus tenuicollis* in slaughtered sheep in Britain. In: Society for Veterinary Epidemiology and Preventive Medicine, Proceedings, Southampton, 12–13 April 1983. Ed. Thrusfield, M.V., pp. 124–130
- Stanford, K., Stitt, J., Kellar, J.A. and McAllister, T.A. (2001) Traceability in cattle and small ruminants. *Revue Scientifique et Technique, Office International des Epizooties*, **20**, 510–522
- Stangle, D.K. and Berry, D.A. (Eds) (2000) *Meta-analysis in Medicine and Health Policy*. Marcel Dekker, New York
- Stansfield, S.A. (2002) Commentary: The problem with stress: minds, hearts and disease. *International Journal of Epidemiology*, **31**, 1113–1116
- Stärk, K.D.C., Morris, R.S., Benard, H.J. and Stern, M.W. (1998) EpiMAN-SF: a decision support system for managing swine fever epidemics. *Revue Scientifique et Technique, Office International des Epizooties*, **17**, 682–690
- Stärk, K.D.C. (2000) The epidemiological investigation of environmental risk factors for respiratory diseases in pigs – a literature review. *The Veterinary Journal*, **159**, 37–56
- Stark, D.A. and Anderson, N.G. (1990) A case-control study of *Nocardia* mastitis in Ontario dairy herds. *Canadian Veterinary Journal*, **31**, 197–201
- Stärk, K.D.C., Pfeiffer, D.U. and Morris, R.S. (1998) Risk factors for respiratory diseases in New Zealand pig herds. *New Zealand Veterinary Journal*, **46**, 3–10
- Stärk, K.D.C., Vicari, A. and Nicolet, J. (1994) Contagious bovine pleuropneumonia (CBPP) surveillance in Switzerland: a pilot study. In: Society for Veterinary Epidemiology and Preventive Medicine, Proceedings, Belfast, 13–15 April 1994. Ed. Thrusfield, M.V., pp. 96–103
- Stärk, K.D.C., Frei, P.P., Frei-Stäheli, C., Pfeiffer, D.U. and Audigé, L. (1996) A health profile of Swiss dairy cows. In: Society for Veterinary Epidemiology and Preventive Medicine, Proceedings, Glasgow, 27–29 March 1996, Eds Thrusfield, M.V. and Goodall, E.A., pp. 86–93
- Starr, C. (1969) Social benefit versus technological risk. *Science*, **165**, 1232–1238
- Starr, C. (2003) The precautionary principle versus risk analysis. *Risk Analysis*, **23**, 1–3
- Stationery Office (1997) *The Pennington Group. Report on the Circumstances Leading to the 1996 Outbreak of Infection with E. coli O157 in Central Scotland, The Implications for Food Safety and Lessons to be Learned*. The Stationery Office, Edinburgh
- Staubach, C., Tackmann, K., Löschner, U., Mix, H., Busse, W., Thulke, H.-H., Terroto, B.M. and Conraths, F.J. (1998) Geographic information system-aided analysis of factors potentially influencing *Echinococcus multilocularis* infections in foxes. In: Society for Veterinary Epidemiology and Preventive Medicine, Proceedings, Ennis, 25–27 March 1998. Eds Thrusfield, M.V. and Goodall, E.A., pp. 40–47
- Stear, M.J. and Bishop, S.C. (1999) Breeding for resistance to nematode infection in cattle. *Cattle Practice*, **7**, 189–191
- Stedman, T.L. (1989) *Stedman's Medical Dictionary*, 25th edn. Williams and Wilkins, Baltimore
- Steenholdt, C. and Hernandez, J. (2004) Risk factors for umbilical hernia in Holstein heifers during first two months after birth. *Journal of the American Veterinary Medical Association*, **224**, 1487–1490
- Steere, A.C., Malawista, S.E., Snyderman, D.R., Shope, R.E., Andiman, W.A., Ross, M.R. and Steele, F.M. (1977) Lyme arthritis. An epidemic of oligoarticular arthritis in children and adults in three Connecticut communities. *Arthritis and Rheumatism*, **20**, 7–17
- Stege, H., Jensen, T.K., Møller, K., Bækbo, P. and Jorsal, S.E. (2001) Risk factors for intestinal pathogens in Danish finishing pig herds. *Preventive Veterinary Medicine*, **50**, 153–164
- Stege, H., Bager, F., Jacobsen, E. and Thouggaard, A. (2003) VETSTAT – the Danish system for surveillance of the veterinary use of drugs for production animals. *Preventive Veterinary Medicine*, **57**, 105–115
- Stein, T., Molitor, T., Joo, H.S. and Leman, A.D. (1982) Porcine parvovirus infection and its control. *The Pig Veterinary Society Proceedings*, **9**, 158–167
- Stein, T.E. (1988) Problem-oriented population medicine in swine breeding herds. *Compendium on Continuing Education for the Practising Veterinarian*, **10**, 871–879
- Stein, T.E., Dijkhuizen, A., D'Allaire, S. and Morris, R.S. (1990) Sow culling and mortality in commercial swine breeding herds. *Preventive Veterinary Medicine*, **9**, 85–94
- Stephen, J.O., White, N.A., McCormick, W.H., Cowles, R.R. and Corley, K.T.T. (2003) Risk factors and prevalence of injuries in horses during various types of steeplechase races. *Journal of the American Veterinary Medical Association*, **223**, 1788–1790
- Stephen, L.E. (1980) An index for coding and recording veterinary diseases and pathological states, according to body system(s) involved and aetiology or indicated cause. In: *Veterinary Epidemiology and Economics*. Proceedings of the Second International Symposium, Canberra, 7–11 May 1979. Eds Geering, W.A., Roe, R.T. and Chapman,

- L.A., pp. 247–249. Australian Government Publishing Service, Canberra
- Sternbach, G. (2003) The history of anthrax. *Journal of Emergency Medicine*, **24**, 463–467
- Sterning, M. and Lundeheim, N. (1996) Some factors influencing pregnancy rate and subsequent litter size in primiparous sows. *Acta Veterinaria Scandinavica*, **36**, 353–365
- Stevens, S.S. (1946) On the theory of scales and measurement. *Science*, **103**, 667–680
- Stevenson, M.A., Wilesmith, J.W., Ryan, J.B.M., Morris, R.S., Lockhart, J.W., Lin, D. and Jackson, R. (2000) Temporal aspects of the epidemic of bovine spongiform encephalopathy in Great Britain: individual animal-associated risk factors for the disease. *Veterinary Record*, **147**, 349–354
- Stewart, G.T. (1968) Limitations of the germ theory. *The Lancet*, **1**, 1077–1081
- Stewart, I. (1992) Risky business. In: *The New Scientist: Inside Science*. Ed. Fifield, R., pp. 329–342. Penguin Books, Harmondsworth
- Steyn, P.F. and Wittum, T.B. (1993) Radiographic, epidemiologic, and clinical aspects of simultaneous pleural and peritoneal effusions in dogs and cats: 48 cases (1982–1991). *Journal of the American Veterinary Medical Association*, **202**, 307–312
- Stigler, S.M. (1986) *The History of Statistics: The Measurement of Uncertainty before 1900*. The Belknap Press of Harvard University Press, Cambridge
- Stiglitz, J.E. (2006) *Making Globalization Work*. Allen Lane, London
- Stirling, A. (2001) The precautionary principle in science and technology. In: *Reinterpreting the Precautionary Principle*. Eds O'Riordan, T., Cameron, J. and Jordan, A., pp. 61–94. Cameron May, London
- Stites, D.P., Rodgers, R.P.C., Folds, J.D. and Schmitz, J. (1997) Clinical laboratory methods for detection of antigens and antibodies. In: *Medical Immunology*, 9th edn. Eds Stites, D.P., Terr, A.I. and Parslow, T.G., pp. 211–253. Appleton and Lange, Stamford
- Stites, D.P., Stobo, J.D., Fundenberg, H.H. and Wells, J.V. (1982) *Basic and Clinical Immunology*, 4th edn. Lange Medical Publications, Los Altos
- Stock, J.M. and Holmes, J.C. (1988) Functional relationships and microhabitat distributions of helminths of grebes (Podicipedidae): the evidence for interactive communities. *Journal of Parasitology*, **74**, 214–227
- Stone, D.J.W. and Thrusfield, M.V. (1989) A small animal clinical and epidemiological relational database. *Preventive Veterinary Medicine*, **7**, 289–302
- Storrs, M.J., Courvalin, P. and Foster, T.J. (1988) Genetic analysis of gentamycin resistance in methicillin and gentamycin resistant strains of *Staphylococcus aureus* isolated in Dublin hospitals. *Antimicrobial Agents and Chemotherapy*, **32**, 1174–1181
- Strawson, G. (1989) *The Secret Connexion: Causation, Realism and David Hume*. Clarendon Press, Oxford
- Stringer, L. and Thrusfield, M. (2001) Foot-and-mouth disease Scotland 2001. Serosurveillance to demonstrate freedom from disease. Report of the Ayr Animal Health Office Epidemiology Unit, September 2001. MAFF/DEFRA (unpublished)
- Strogatz, S.H. (2001) Exploring complex networks. *Nature*, **410**, 268–276
- Stuart, R.D. (1946) Canine leptospirosis in Glasgow. *Veterinary Record*, **58**, 131–132
- Stuart-Harris, C.H. and Schild, G.C. (1976) *Influenza, the Viruses and the Disease*. Edward Arnold, London
- Studdert, M.J. (Ed.) (1996) *Virus Infections of Vertebrates, Vol. 6. Virus Infections of Equines*. Elsevier, New York
- Suarez, D.L. (2000) Evolution of avian influenza viruses. *Veterinary Microbiology*, **74**, 15–27
- Suazo, F.M., Escalera, A.M.A. and Torres, R.M.G. (2003) A review of *M. bovis* BCG protection against TB in cattle and other animal species. *Preventive Veterinary Medicine*, **58**, 1–13
- Sugden, R. and Williams, A. (1978) *The Principles of Practical Cost-Benefit Analysis*. Oxford University Press, London
- Sukura, A., Gröhn, Y.T., Junntila, J. and Palolahti, T. (1992) Association between feline immunodeficiency virus antibodies and host characteristics in Finnish cats. *Acta Veterinaria Scandinavica*, **33**, 325–334
- Summers, M. (1961) *The Vampire in Europe*. University Books, New York
- Summers, M. (1994) *The History of Witchcraft*. Senate, London
- Sundrum, A. (2001) Organic livestock farming: a critical review. *Livestock Production Science*, **67**, 207–215
- Sung, H.-T. (1992) Disease reporting systems in Taiwan. *R.O.C. Office International des Epizooties Quarterly Epidemiology Report (Asian and Pacific Region)*, **1**, 40–44
- Susser, M. (1977) Judgment and causal inference: criteria in epidemiologic studies. *American Journal of Epidemiology*, **105**, 1–15
- Sutmoller, P. and Gaggero, A. (1965) Foot and mouth disease carriers. *Veterinary Record*, **77**, 968–969
- Sutmoller, P. and Olascoaga, R.C. (2002) Unapparent foot and mouth disease infection (sub-clinical infection and carriers): implications for control. *Revue Scientifique et Technique, Office International des Epizooties*, **21**, 519–529
- Sutmoller, P. and Wrathall, A.E. (1995) *Quantitative Assessment of the Risk of Disease Transmission by Bovine Embryo Transfer*. Scientific and Technical Monograph Series No. 17. Pan American Foot-and-Mouth Disease Centre, Pan American Health Organization, Rio de Janeiro
- Sutmoller, P. and Wrathall, A.E. (1997) The risks of disease transmission by embryo transfer in cattle. *Revue Scientifique et Technique, Office International des Epizooties*, **16**, 226–239
- Sutmoller, P., McVicar, J.W. and Cottral, G.E. (1968) The epizootiological importance of foot-and-mouth disease carriers. *Archiv für die gesamte Virusforschung*, **23**, 227–235
- Sutmoller, P., Barteling, S.S., Olascoaga, R.C. and Sumption, K.J. (2003) Control and eradication of foot-and-mouth disease. *Virus Research*, **91**, 101–144
- SVS (1982) Effect of the drought of 1976 on the health of cattle, sheep and other farm livestock in England and Wales. *Veterinary Record*, **111**, 407–411
- Swenson, L., Audell, L. and Hedhammar, Å. (1997a) Prevalence and inheritance of and selection for elbow arthrosis in Bernese Mountain Dogs and Rottweilers in Sweden and benefit:cost analysis of a screening and control program. *Journal of the American Veterinary Medical Association*, **210**, 207–214

- Swenson, L., Audell, L. and Hedhammar, Å. (1997b) Prevalence and inheritance of and selection for hip dysplasia in seven breeds of dogs in Sweden and benefit:cost analysis of a screening and control program. *Journal of the American Veterinary Medical Association*, **210**, 215–221
- Swift, J. (1988) *Major Issues in Pastoral Development with Special Emphasis on selected African countries*. Food and Agriculture Organization of the United Nations, Rome
- Swift, J., Toulmin, C. and Chatting, S. (1990) *Providing Services for Nomadic People: A Review of the Literature and Annotated Bibliography*. UNICEF Staff Working Paper No. 8, UNICEF, New York
- Sykes, A.R. and Coop, R.L. (2001) Interaction between nutrition and gastrointestinal parasitism in sheep. *New Zealand Veterinary Journal*, **49**, 222–226
- Synge, B.A., Clark, A.M., Moar, J.A.E., Nicolson, J.T., Nettleton, P.G.F. and Herring, J.A. (1999) The control of bovine virus diarrhoea virus in Shetland. *Veterinary Microbiology*, **64**, 223–229
- Tadich, N., Kruze, J., Locher, G. and Green, L.E. (2003) Risk factors associated with BMSCC greater than 200 000 cells/ml in dairy herds in Southern Chile. *Preventive Veterinary Medicine*, **58**, 15–24
- Tamba, M., Calabrese, R., Finelli, E. and Cordioli, P. (2002) Risk factors for Aujeszky's-disease seropositivity of swine herds of a region of northern Italy. *Preventive Veterinary Medicine*, **54**, 203–212
- Tambi, E.N., Maina, O.W., Mukhebi, A.W. and Randolph, T.F. (1999) Economic impact assessment of rinderpest control in Africa. *Revue Scientifique et Technique, Office International des Epizooties*, **18**, 458–477
- Tanaka, J. (1992) Outline of animal health information processing in Japan. *Office International des Epizooties Quarterly Epidemiology Report (Asian and Pacific Region)*, **1**, 36–39
- Tannahill, R. (1968) *The Fine Art of Food*. The Folio Society, London
- Tansley, A.G. (1935) The use and abuse of vegetational concepts and terms. *Ecology*, **16**, 284–307
- Tasker, S., Binns, S.H., Day, M.J., Gruffydd-Jones, T.J., Harbour, D.A., Helps, C.R., Jensen, W.A., Oliver, C.S. and Lappin, M.R. (2003) Use of a PCR assay to assess the prevalence and risk factors for *Mycoplasma haemofelis* and 'Candidatus Mycoplasma haemominutum' in cats in the United Kingdom. *Veterinary Record*, **152**, 193–198
- Tatem, A.J., Capela, R., Pena, I., Mellor, P.S., Baylis, M., Purse, B.V. and Rogers, D.J. (2003) Prediction of *Culicoides*-borne disease risk in Europe and North Africa using satellite imagery. In: Society for Veterinary Epidemiology and Preventive Medicine, Proceedings, Warwick, 31 March–2 April 2003. Eds Reid, S.W.J. and Menzies, F.D., pp. 253–264
- Taylor, K.C. (2002) Environmental impacts of the foot and mouth disease outbreak in Great Britain in 2001: the use of risk analysis to manage the risks in the countryside. *Revue Scientifique et Technique, Office International des Epizooties*, **21**, 797–813
- Taylor, N. (2003) Review of the use of models in informing disease control policy development and adjustment. A report to DEFRA. <http://www.defra.gov.uk/science/Publications/2003/UseofModelsInDiseaseControlPolicy.pdf> (Accessed 20 August 2003)
- Taylor, R. (1967) Causation. In: *The Encyclopedia of Philosophy*, Vol. 2. Ed. Edwards, P. Macmillan Company and the Free Press, New York
- Taylor, W.P. and Marshall, I.E. (1975) Adaptation studies with Ross River virus: retention of field level virulence. *Journal of General Virology*, **28**, 73–83
- Teal, C.J. (2002) Antimicrobial resistance and the food chain. *Journal of Applied Microbiology Symposium Supplement*, **92**, 85S–89S
- Teclaw, R., Mendlein, J., Garbe, P. and Mariolis, P. (1992) Characteristics of pet populations and households in the Purdue Comparative Oncology Program catchment area, 1988. *Journal of the American Veterinary Medical Association*, **201**, 1725–1729
- Tedor, J. and Reif, J.S. (1978) Natal patterns among registered dogs in the United States. *Journal of the American Veterinary Medical Association*, **172**, 1179–1185
- Tefera, M. (2004) Recent evidence of animal exploitation in the Axumite epoch, 1st–5th centuries AD. *Tropical Animal Health and Production*, **36**, 105–116
- Thacker, S.B. and Birkhead, G.S. (2002) Surveillance. In: *Field Epidemiology*, Ed. Gregg, M.B., 2nd edn, pp. 26–50. Oxford University Press, New York
- The Economist* (2002) The race to computerise biology. *The Economist Technology Quarterly*, 16 December, pp. 20–22
- The Royal Society (1992) *Risk: Analysis, Perception and Management*. The Royal Society, London
- The Times* (1983) Running dogs banned. *The Times*, 13 October, p. 6
- Theis, J.H., Kass, P.H. and Stevens, F. (1998) Effects of drought and chemoprophylaxis on heartworm transmission in domestic dogs in California (1983–1991). In: *Recent Advances in Heartworm Disease: Symposium '98*, Tampa, Florida, 1–3 May 1998. Ed. Seward, R.L., pp. 37–50. American Heartworm Society, Batavia
- Theodorou, M.K. and France, J. (Eds) (2000) *Feeding Systems and Feed Evaluation Models*. CAB Publishing, Wallingford
- Theyse, L.F.H., van de Brom, W.E. and van Sluijs, F.J. (1998) Small size of food particles and age as risk factors for gastric dilatation volvulus in great danes. *Veterinary Record*, **143**, 48–50
- Thiermann, A.B. (2005) Globalization, international trade and animal health: the new roles of OIE. *Preventive Veterinary Medicine*, **67**, 101–108
- Thobokwe, G. and Heuer, C. (2004) Incidence of abortion and association with putative causes in dairy herds in New Zealand. *New Zealand Veterinary Journal*, **52** (2), 90–94
- Thomas, A.D. and Reid, N.R. (1944) Rinderpest in game. A description of an outbreak and an attempt at limiting its spread by means of a bush fence. *Onderspoort Journal of Veterinary Science and Animal Industry*, **20**, 7–20
- Thomas, A.D. and Maré, C.v.E. (1945) Knopvelsiekte. *Journal of the South African Veterinary Medical Association*, **16**, 36–43
- Thomas, C.B., Willeberg, P. and Jasper, D.E. (1981) Case-control study of bovine mycoplasmal mastitis in California. *American Journal of Veterinary Research*, **42**, 511–515
- Thomas, C.B., Jasper, D.E. and Willeberg, P. (1982) Clinical bovine mycoplasmal mastitis. An epidemiologic study of factors associated with problem herds. *Acta Veterinaria Scandinavica*, **23**, 53–64

- Thomas, D.R. (1989) Simultaneous confidence intervals for proportions under cluster sampling. *Survey Methodology*, **18**, 187–201
- Thomas, L. and Krebs, C.J. (1997) A review of statistical power analysis software. *Bulletin of the Ecological Society of America*, **78**, 126–139
- Thompson, D., Muriel, P., Russell, D., Osborne, P., Bromley, A., Rowland, M., Creigh-Tyte, S. and Brown, C. (2002) Economic costs of the foot and mouth disease outbreak in the United Kingdom in 2001. *Revue Scientifique et Technique, Office International des Epizooties*, **21**, 675–687
- Thompson, E.T. and Hayden, A.C. (1961) *Standard Nomenclature of Diseases and Operations*, 5th edn. McGraw-Hill, New York
- Thompson, W.D. (1991) Effect modification and the limits of biological inference. *Journal of Clinical Epidemiology*, **44**, 221–232
- Thomson, G.R. (1996) The role of carriers in the transmission of foot and mouth disease. In: Conference Proceedings of the 64th General Session of Office International des Epizooties, pp. 87–103
- Thorburn, M.A., Carpenter, T.E., Jasper, D.E. and Thomas, C.B. (1983) The use of the log-linear model to evaluate the effects of three herd factors on *Streptococcus agalactiae* mastitis occurrence in California, 1977. *Preventive Veterinary Medicine*, **1**, 243–256
- Thorne, E.T. and Williams, E.S. (1988) Disease and endangered species: the black-footed ferret as a recent example. *Conservation Biology*, **2**, 66–74
- Thorns, C.J. and Morris, J.A. (1983) The immune spectrum of *Mycobacterium bovis* infection in some mammalian species: a review. *Veterinary Bulletin*, **53**, 543–550
- Thornton, P.D. and Waterman-Pearson, A.E. (1997) Castration in young lambs produces changes in mechanical nociceptive threshold responses and behaviour as assessed by a dynamic and interactive visual analogue scale. *Journal of Veterinary Anaesthesia*, **24**, 41
- Thornton, P.D. and Waterman-Pearson, A.E. (1999) Quantification of the pain and distress responses to castration in young lambs. *Research in Veterinary Science*, **66**, 107–118
- Thrusfield, M.V. (1983a) Recording and manipulating clinical data. *Journal of Small Animal Practice*, **24**, 703–717
- Thrusfield, M.V. (1983b) Application of computer technology to the collection, analysis and use of veterinary data. *Veterinary Record*, **112**, 538–543
- Thrusfield, M.V. (1985a) How to use a knowledge of epidemiology in practice. In: *The Pig Veterinary Society Proceedings*, **12**, 25–37
- Thrusfield, M.V. (1985b) Data recording in general practice. *In Practice*, **7**, 128–138
- Thrusfield, M.V. (1985c) Association between urinary incontinence and spaying in bitches. *Veterinary Record*, **116**, 695
- Thrusfield, M.V. (1989) Demographic characteristics of the canine and feline populations of the UK in 1986. *Journal of Small Animal Practice*, **30**, 76–80
- Thrusfield, M. (1991) A computerised small animal practice health management system with a centralised data-analysis facility. In: Proceedings of the Sixth International Symposium on Veterinary Epidemiology and Economics, Ottawa, 12–16 August 1991. Ed. Martin, S.W., pp. 459–461
- Thrusfield, M.V. (1992) Canine kennel cough: a review. In: *The Veterinary Annual*, Vol. 32. Eds Raw, M.-E. and Parkinson, T.J., pp. 1–12. Blackwell Science, Oxford
- Thrusfield, M. (1993) Quantitative approaches to veterinary epidemiology. In: *The Advancement of Veterinary Science. The Bicentenary Symposium Series. Vol. 1: Veterinary Medicine beyond 2000*. Ed. Michell, A.R., pp. 121–142. CAB International, Wallingford
- Thrusfield, M. (2001) Introduction to epidemiology. In: *Application of Quantitative Methods in Veterinary Epidemiology*, revised reprint. Eds Noordhuizen, J.P.T.M., Frankena, K., Thrusfield, M.V. and Graat, E.A.M., pp. 3–11. Wageningen Pers, Wageningen
- Thrusfield, M. (2006) *Potential Biological Health Risks in the Handling and Processing of Animal Carcasses for Taxidermy: a Qualitative Risk Assessment*. The Department of Natural Sciences, National Museums of Scotland, Edinburgh
- Thrusfield, M.V., Aitken, C.G.G. and Darke, P.G.G. (1985) Observations on breed and sex in relation to canine heart valve incompetence. *Journal of Small Animal Practice*, **26**, 709–717
- Thrusfield, M.V., Aitken, C.G.G. and Muirhead, R.H. (1989a) A field investigation of kennel cough. Efficacy of vaccination. *Journal of Small Animal Practice*, **30**, 550–560
- Thrusfield, M.V., Mullineaux, E., MacTaggart, D.C. and Trinder, N.J. (1989b) Some epidemiological observations on canine testicular tumours. In: Society for Veterinary Epidemiology and Preventive Medicine, Proceedings, Exeter, 12–14 April 1989. Ed. Rowlands, G.J., pp. 98–109
- Thrusfield, M.V., Holt, P.E. and Muirhead, R.H. (1998) Acquired urinary incontinence in bitches: its incidence and relationship to neutering practices. *Journal of Small Animal Practice*, **39**, 559–566
- Thrusfield, M., Ortega, C., de Blas, I., Noordhuizen, J.P. and Frankena, K. (2001) WINEPISCOPE 2.0 Improved epidemiological software for veterinary medicine. *Veterinary Record*, **148**, 567–572
- Thrusfield, M., Mansley, L., Dunlop, P., Taylor, J., Pawson, A. and Stringer, L. (2005a) The foot-and-mouth disease epidemic in Dumfries and Galloway, 2001. 1: Characteristics and control. *Veterinary Record*, **156**, 229–252
- Thrusfield, M., Mansley, L., Dunlop, P., Pawson, A. and Taylor, J. (2005b) The foot-and-mouth disease epidemic in Dumfries and Galloway, 2001. 2: Serosurveillance, and efficiency and effectiveness of control procedures after the national ban on animal movements. *Veterinary Record*, **156**, 269–278
- Thulke, H.-H., Grimm, V., Müller, M.S., Staubach, C., Tischendorf, L., Wissel, C. and Jeltsch, F. (1999) From pattern to practice: a scaling-down strategy for spatially explicit modelling illustrated by the spread and control of rabies. *Ecological Modelling*, **117**, 179–202
- Thumchai, R., Lulich, J., Osborne, C.A., King, V.L., Lund, E.M., Marsh, W.E., Ulrich, L.K., Koehler, L.A. and Bird, K.A. (1996) Epizootiologic evaluation of urolithiasis in cats: 3498 cases (1982–1992). *Journal of the American Veterinary Medical Association*, **208**, 547–551
- Thurber, E.T., Bass, E.P. and Beckenhauer, W.H. (1977) Field trial evaluation of a reo-coronavirus calf diarrhea vaccine. *Canadian Journal of Comparative Medicine*, **41**, 131–146

- Thurmond, M.C. and Hietala, S.K. (1997) Effect of congenitally acquired *Neospora caninum* infection on risk of abortion and subsequent abortions in dairy cattle. *American Journal of Veterinary Research*, **58**, 1381–1385
- Tidholm, A. (1997) Retrospective study of congenital heart defects in 151 dogs. *Journal of Small Animal Practice*, **38**, 94–98
- Timbs, D.V. (1980) The New Zealand national bovine serum bank. In: *Veterinary Epidemiology and Economics*, Proceedings of the Second International Symposium, Canberra, 7–11 May 1979. Eds Geering, W.A., Roe, R.T. and Chapman, L.A., pp. 76–80. Australian Government Publishing Service, Canberra
- Timoney, J.F., Gillespie, J.H., Scott, F.W. and Balough, J.E. (1988) *Hagan and Bruner's Microbiology and Infectious Diseases of Domesticated Animals*, 8th edn. Comstock Publishing Associates, Ithaca
- Tinker, M.K., White, N.A., Lessard, P., Thatcher, C.D., Pelzer, K.D., Davis, B. and Carmel, D.K. (1997) Prospective study of equine colic risk factors. *Equine Veterinary Journal*, **29**, 454–458
- Tinline, R. (1970) Lee wave hypothesis for the initial pattern of spread during the 1967–68 foot-and-mouth disease epizootic. *Nature*, **227**, 860–862
- Tinline, R. (1972) A simulation study of the 1967–68 foot-and-mouth epizootic in Great Britain. PhD Thesis. University of Bristol
- Tizard, I. (1990) Risks associated with use of live vaccines. *Journal of the American Veterinary Medical Association*, **196**, 1851–1858
- Tizard, I.R. (2000) *Veterinary Immunology: An Introduction*, 6th edn. W.B. Saunders, Philadelphia and London
- Tjalma, R.A. (1966) Canine bone sarcoma: estimation of relative risk as a function of body size. *Journal of the National Cancer Institute*, **36**, 1137–1150
- Tjalma, R.A. (1968) Implications of animal cancers to human neoplasia: epidemiologic considerations. *International Journal of Cancer*, **3**, 1–6
- Tjalma, R.A., Priester, W.A., Adelstein, E.H. and Vander Zwaag, R. (1964) Clinical records systems and data retrieval function in veterinary medicine: a proposal for system data programming. *Journal of the American Veterinary Medical Association*, **145**, 1189–1197
- Tobias, K.M. and Rohrbach, B.W. (2003) Association of breed with the diagnosis of congenital portosystemic shunts in dogs: 2400 cases (1980–2002). *Journal of the American Veterinary Medical Association*, **223**, 1636–1639
- Toma, B., Vaillancourt, J.-P., Dufour, B., Eloit, M., Moutou, F., Marsh, W., Bénét, J.-J., Sanaa, M. and Michel, P. (Eds) (1999) *Dictionary of Veterinary Epidemiology*. Iowa State University Press, Ames
- Toma, B., Moutou, F., Dufour, B. and Durand, B. (2002) Ring vaccination against foot and mouth disease. *Comparative Immunology, Microbiology and Infectious Diseases*, **25**, 365–372
- Topley, W.W.C. (1942) The biology of epidemics. *Proceedings of the Royal Society of London*, **130**, 337–359
- Tornor, W. (1927) Eine veterinärpolizeiliche Verordnung Friedrich Wilhelms I von Preußen aus dem Jahr 1716 zur Bekämpfung des 'Sterbens unter dem Horne-Viehe'. *Tierärztliche Rundschau*, **33**, 345–346
- Torres-Anjel, M.J. and Tshikuka, J.G. (1988) The micro-epidemiology of the animal acquired immunodeficiency syndromes (AIDS) in the context of human AIDS (HAIDS). In: *Environment and Animal Health*. Proceedings of the Sixth International Congress on Animal Hygiene, Skara, Sweden, Vol. 2. Ed. Ekesbo, I., pp. 745–749. Swedish University of Agricultural Sciences, Report No. 21
- Toth, T. (1969) Studies of an agent causing mortality among ducklings immune to duck virus hepatitis. *Avian Diseases*, **13**, 834–846
- Townley, J. (1827) *The Reasons of the Laws of Moses: from the 'More Nevochim' of Maimonides, with Notes, Dissertations, and a Life of the Author*. Longman, Rees, Orme, Brown and Green, London
- Townsend, H.G.G., Morley, P.S. and Haines, D.M. (1991) Risk factors associated with upper respiratory tract disease during an outbreak of influenza. In: Proceedings of the Sixth International Symposium on Veterinary Epidemiology and Economics, Ottawa, 12–16 August 1991. Ed. Martin, S.W., pp. 479–481
- Tranter, W.P., Morris, R.S., Dohoo, I.R. and Williamson, N.B. (1993) A case-control study of lameness in dairy cows. *Preventive Veterinary Medicine*, **15**, 191–203
- Traum, J. (1936) Vesicular exanthema of swine. *Journal of the American Veterinary Medical Association*, **88**, 316–334
- Travis, C.C. (1987) Interspecies extrapolations in risk analysis. *Toxicology*, **47**, 3–13
- Trehwella, W.R. and Anderson, R.M. (1983) Modelling bovine tuberculosis in badgers. In: Society for Veterinary Epidemiology and Preventive Medicine, Proceedings, Southampton, 12–13 April 1983. Ed. Thrusfield, M.V., pp. 78–84
- Tribe, H.T. (1980) Prospects for the biological control of plant-parasitic nematodes. *Parasitology*, **81**, 619–639
- Trotter, W. (1930) Observation and experiment and their use in the medical sciences. *British Medical Journal*, **ii**, 129–134
- Trotter, W. (1932) *Art and Science in Medicine* (Quoted by Himsworth, 1970)
- Trotz-Williams, L.A. and Trees, A.J. (2003) Systematic review of the distribution of the major vector-borne parasitic infections in dogs and cats in Europe. *Veterinary Record*, **152**, 97–105
- Trust, T.J. (1986) Pathogenesis of infectious diseases of fish. *Annual Review of Microbiology*, **40**, 479–502
- Tryfos, P. (1996) *Sampling Methods for Applied Research*. John Wiley, New York
- Tukey, J.W. (1977) *Exploratory Data Analysis*. Addison-Wesley Publishing, Philippines
- Tuohimaa, P., Tenkanen, L., Ahonen, M., Lumme, S., Jellum, E., Hallmans, G., Stattin, P., Harvei, S., Hakulinen, T., Luostarinen, T., Dillner, J., Lehtinen, M. and Hakama, M. (2004) Both high and low levels of blood vitamin D are associated with a higher prostate cancer risk: a longitudinal, nested case-control study in the Nordic countries. *International Journal of Cancer*, **108**, 104–108
- Tuovinen, V.K., Grohn, Y.T., Straw, B.E. and Boyd, D. (1992) Feeder unit environmental factors associated with partial carcass condemnations in market swine. *Preventive Veterinary Medicine*, **12**, 175–195
- Turkson, P.K. (2003) Profile of veterinarians and veterinary practice in Ghana. *Tropical Animal Health and Production*, **35**, 321–340

- Turkson, P.K. and Brownie, C.F. (1999) Perceived constraints to privatization of delivery of veterinary services in Ghana. *Tropical Animal Health and Production*, **31**, 103–114
- Turkson, P.K., Antiri, Y.K. and Baffuor-Awuah, O. (2004) Risk factors for kid mortality in West African Dwarf goats under an intensive management system in Ghana. *Tropical Animal Health and Production*, **36**, 353–364
- Turnbull, J.F., Corsin, F., Mohan, C.V., Thakur, P.C., Padiyar, P.A., Madhusudhan, M., Hao, N.V. and Morgan, K.L. (2003) An epidemiological study of white spot disease in shrimp farms of Karnataka, India. In: Society for Veterinary Epidemiology and Preventive Medicine, Proceedings, 31 March–2 April 2003, Eds Reid, S.W.J. and Menzies, F.D., pp. 232–242
- Turner, A.S. (2002) The sheep as a model for osteoporosis in humans. *The Veterinary Journal*, **163**, 232–239
- Turner, T.A., Kneller, S.K., Badertscher, R.R. and Stowater, J.L. (1987) Radiographic changes in the navicular bones of normal horses. In: Proceedings of the 32nd Annual Convention of the American Association of Equine Practitioners, Nashville, 29 November–3 December 1986, pp. 309–314
- Tversky, A. and Kahneman, D. (1981) The framing of decisions and the psychology of choice. *Science*, **211**, 453–458
- Tyler, L. (1991) PARC sero-monitoring: survey design, implementation and the analysis, presentation and use of results. In: *The Sero-monitoring of Rinderpest throughout Africa. Phase One*. Proceedings of a Final Research Co-ordination Meeting of the FAO/IAEA/SIDA/OAU/BAR/PARC Co-ordinated Research Programme, Bingerville, Cote d'Ivoire, 19–23 November 1990. IAEA-TECDOC-623, pp. 67–79. International Atomic Energy Agency, Vienna
- Tyndale-Biscoe, H. (1994) The CRC for biological control of vertebrate pest populations: fertility control of wildlife for conservation. *Pacific Conservation Biology*, **1**, 160–162
- Tyson, J.D. (2002) FMD in a parturient sheep flock. (Letter) *Veterinary Record*, **151**, 127
- Ubbink, G.J., van de Broek, J., Hazewinkel, H.A.W. and Rothuizen, J. (1998a) Risk estimates for dichotomous genetic disease traits based on a study of relatedness in purebred dog populations. *Veterinary Record*, **142**, 328–331
- Ubbink, G.J., van de Broek, J., Hazewinkel, H.A.W. and Rothuizen, J. (1998b) Cluster analysis of the genetic heterogeneity and disease distributions in purebred dog populations. *Veterinary Record*, **142**, 209–213
- Udomprasert, P. and Williamson, N.B. (1990) The DairyCHAMP program: a computerised recording system for dairy herds. *Veterinary Record*, **127**, 256–262
- Uhaa, I.J., Mandel, E.J., Whiteway, R. and Fishbein, D.B. (1992) Rabies surveillance in the United States during 1990. *Journal of the American Veterinary Medical Association*, **200**, 920–929
- Uhaa, I.J., Riemann, H.P., Thurmond, M.C. and Franti, C.E. (1990a) A cross-sectional study of bluetongue virus and *Mycoplasma bovis* infections in dairy cattle: I. The association between a positive antibody response and production efficiency. *Veterinary Research Communications*, **14**, 461–470
- Uhaa, I.J., Riemann, H.P., Thurmond, M.C. and Franti, C.E. (1990b) A cross-sectional study of bluetongue virus and *Mycoplasma bovis* infections in dairy cattle: II. The association between a positive antibody response and reproduction performance. *Veterinary Research Communications*, **14**, 471–480
- Uhlhorn, H. and Carlsten, J. (1999) Retrospective study of subchondral sclerosis and lucency in the third carpal bone of Standardbred trotters. *Equine Veterinary Journal*, **31**, 500–505
- UK National Case-control Study Group (1989) Oral contraceptive use and breast cancer risk in young women. *Lancet*, **i**, 973–982
- UKILGRA (1996) *United Kingdom Interdepartmental Liaison Group on Risk Assessment, Use of Risk Assessment Within Government Departments*. Quoted by Redmill (2002)
- Uphoff, N. (1992) *Learning from Gal Oya: Possibilities for Participatory Development and Post-Newtonian Science*. Cornell University Press, New York
- Urquhart, G.M. (1980) Application of immunity in the control of parasitic disease. *Veterinary Parasitology*, **6**, 217–239
- Urquhart, G.M., Armour, J., Duncan, J.L., Dunn, A.M. and Jennings, F.W. (1996) *Veterinary Parasitology*, 2nd edn. Blackwell Science, Oxford
- USDA (1998) Composition of the US equine population. Centers for Epidemiology and Animal Health, United States Department of Agriculture, Fort Collins, Colorado. <http://www.aphis.usda.gov/vs/ceah/cahm/Equine/eq98comp.pdf> (Accessed 14 March 2003)
- USDHHC (2000) *Healthy People 2010*. United States Department of Health and Human Services, Public Health Service, Washington, DC
- USGS (2004) US Geological Survey. West Nile Virus Maps <http://westnilemaps.usgs.gov/historical.html> (Accessed 5 November 2004)
- Vach, W. and Blettner, M. (1991) Biased estimation of the odds ratio in case-control studies due to the use of ad hoc methods of correcting for missing values of confounding variables. *American Journal of Epidemiology*, **134**, 895–907. Correction: (1994), **140**, 789
- Vågsholm, I., Djupvik, H.O., Willumsen, F.V., Tveit, A.M. and Tangen, K. (1994) Infectious salmon anaemia (IS) epidemiology in Norway. *Preventive Veterinary Medicine*, **19**, 277–290
- Vail, D.M. and MacEwen, E.G. (2000) Spontaneously occurring tumors of companion animals as models for human cancer. *Cancer Investigation*, **18**, 781–792
- Vail, D.M., Withrow, S.J., Schwarz, P.D. and Powers, B.E. (1990) Perianal adenocarcinoma in the canine male: a retrospective study of 41 cases. *Journal of the American Animal Hospital Association*, **26**, 329–334
- Vaillancourt, J.-P., Martineau, G., Morrow, M., Marsh, W. and Robinson, A. (1991) Construction of questionnaires and their use in veterinary medicine. In: Society for Veterinary Epidemiology and Preventive Medicine, Proceedings, London, 17–19 April 1991. Ed. Thrusfield, M.V., pp. 94–106
- Valde, J.P., Hird, D.W., Thurmond, M.C. and Østerås, O. (1997) Comparison of ketosis, clinical mastitis, somatic cell count, and reproductive performance between free stall and tie stall barns in Norwegian dairy herds with automatic feeding. *Acta Veterinaria Scandinavica*, **38**, 181–192
- Valensin, A. (1972) Satan in the Old Testament. In: *Soundings in Satanism*. Ed. Sheed, F.J., pp. 105–120. Mowbrays, Oxford

- Vallat, B. (2001) Traceability of animals and animal products. *Revue Scientifique et Technique, Office International des Epizooties*, **20**, 359–361
- Valle, P.S., Martin, S.W., Tremblay, R. and Bateman, K. (1999) Factors associated with being a bovine-virus diarrhoea (BVD) seropositive dairy herd in the Møre and Romsdal County of Norway. *Preventive Veterinary Medicine*, **40**, 165–177
- Valle, P.S., Skjerve, E., Martin, S.W., Larssen, R.B., Østerås, O. and Nyberg, O. (2000) A cost benefit evaluation of the Norwegian bovine virus diarrhoea control and eradication program. Proceedings of the Ninth International Symposium on Veterinary Epidemiology and Economics, Breckenbridge, Colorado. Abstract ID 511
- Van Bekkum, J.G. (1973) The carrier state and foot-and-mouth disease. In: Proceedings of the Second International Conference on Foot-and-mouth disease. Ed. Pollard, M., pp. 45–50. Gustav Stern Foundation, New York
- Van Buiten, A., Westers, P. and Colenbrander, B. (2003) Male, female and management risk factors for non-return to service in Dutch mares. *Preventive Veterinary Medicine*, **61**, 17–26
- Van de Braak, A.E., van't Klooster, A. Th. and Malestein, A. (1987) Influence of a deficient supply of magnesium during the dry period on the rate of calcium mobilisation by dairy cows at parturition. *Research in Veterinary Science*, **42**, 101–108
- Van den Bergh, J.C.J.M., Button, K.J., Nijkamp, P., Pepping, G.C., Baaijens, S.R., Greco, S., Jongma, S.M., Kerr, J., Matarazzo, B. and Munda, G. (1997) *Meta-Analysis in Environmental Economics*. Kluwer Academic Publishers, Dordrecht
- Van den Broek, A.H.M., Thrusfield, M.V., Dobbie, G.R. and Ellis, W.A. (1991) A serological and bacteriological survey of leptospiral infection in dogs in Edinburgh and Glasgow. *Journal of Small Animal Practice*, **32**, 118–124
- Van den Geer, D., Schukken, Y.H., Grommers, F.J. and Brand, A. (1988) A matched case-control study of clinical mastitis in Holstein-Friesian dairy cows. In: *Environment and Animal Health*. Proceedings of the Sixth International Congress on Animal Hygiene, 14–17 June 1988, Skara, Sweden, Vol. 1. Ed. Ekesbo, I., pp. 60–64
- Van Der Fels-Klerx, I.H.J., Goossens, L.H.J., Saatkamp, H.W. and Horst, S.H.S. (2002) Elicitation of quantitative data from a heterogeneous expert panel: formal process and application in animal health. *Risk Analysis*, **22**, 67–81
- Van Eck, J.H.H., Davelaar, F.G., Van den Heuvel-Plesman, T.A.M., Van Kol, N., Kouwenhoven, B. and Guldie, F.H.M. (1976) Dropped egg production, soft shelled and shell-less eggs associated with appearance of precipitins to adenovirus in flocks of laying fowl. *Avian Pathology*, **5**, 261–272
- Van-Ham, M. (1994) Israel animal health monitoring system. In: Proceedings of the Seventh International Symposium on Veterinary Epidemiology and Economics, Nairobi, 15–19 August 1994. Eds Rowlands, G.J., Kyule, M.N. and Perry, B.D. *The Kenya Veterinarian*, **18** (2), 41–43
- Van Nes, A., De Jong, M.C.M., Buijtel, J.A.A.M. and Verheijden, J.H.M. (1998) Implications derived from a mathematical model for eradication of pseudorabies virus. *Preventive Veterinary Medicine*, **33**, 39–58
- Van Schaik, G., Nielen, M. and Dijkhuizen, A.A. (2001) Biosecurity on dairy farms: the economic benefits. In: Society for Veterinary Epidemiology and Preventive Medicine, Proceedings, Noordwijkerhout, 28–30 March 2001. Eds Menzies, F.D. and Reid, S.W.J., pp. 175–184
- Van Schaik, G., Schukken, Y.H., Nielen, M., Dijkhuizen, A.A., Barkema, H.W. and Benedictus, G. (2002) Probability of and risk factors for introduction of infectious diseases into Dutch SPF dairy farms: a cohort study. *Preventive Veterinary Medicine*, **54**, 279–289
- Van Velden, D.J.J., Meyer, J.D., Oliver, J., Gear, J.H.S. and McIntosh, B. (1977) Rift Valley fever affecting humans in South Africa. *South African Medical Journal*, **51**, 867–871
- Van Weeren, P.R., Knaap, J. and Firth, E.C. (2003) Influence of liver copper status of mare and newborn foal on the development of osteochondrotic lesions. *Equine Veterinary Journal*, **35**, 67–71
- Vandegraaff, R. (1980) The use of discriminant analysis in a case-control study of salmonellosis in East Gippsland dairy herds. In: *Veterinary Epidemiology and Economics*. Proceedings of the Second International Symposium, Canberra, 7–11 May 1979. Eds Geering, W.A., Roe, R.T. and Chapman, L.A., pp. 258–263. Australian Government Publishing Service, Canberra
- Vanhamme, L., Pays, E., McCulloch, R. and Barry, J.D. (2001) An update on antigenic variation in African trypanosomes. *Trends in Parasitology*, **17**, 338–343
- Van-Lawick-Goodall, J. (1971) *In the Shadow of Man*. William Collins, Glasgow
- Vanopdenbosch, E. and Wellemans, G. (1990) Bovine birna type virus: a new etiological agent of neonatal calf diarrhoea? *Vlaams Diergeneeskundig Tijdschrift*, **59**, 137–140
- Vecchio, T.J. (1966) Predictive value of a single diagnostic test in unselected populations. *New England Journal of Medicine*, **274**, 1171–1173
- Veling, J., Wilpshaar, H., Frankena, K., Bartels, C. and Barkema, H.W. (2002) Risk factors for clinical *Salmonella enterica* subsp. *enterica* serovar Typhimurium infection on Dutch dairy farms. *Preventive Veterinary Medicine*, **54**, 157–168
- Verberne, L.R.M. and Mirck, M.H. (1976) A practical health programme for prevention of parasitic and infectious diseases in horses and ponies. *Equine Veterinary Journal*, **8**, 123–125
- Verdier, K., de, Öhagen, P. and Alenius, S. (2003) No effect of a homeopathic preparation on neonatal calf diarrhoea in a randomised double-blind, placebo-controlled trial. *Acta Veterinaria Scandinavica*, **44**, 97–101
- Verge, J. and Cristoforoni, N. (1928) La gastro-énerite infectieuse des chats est elle due à un virus filtrable? *Compte Rendus des Séances de la Société de Biologie*, **99**, 312–314
- Verheyen, K.L.P., Newton, J.R. and Wood, J.L.N. (2003) A case-control study investigating factors associated with pelvic and tibial stress fractures in Thoroughbred racehorses in training. In: Society for Veterinary Epidemiology and Preventive Medicine, Proceedings, Warwick, 31 March–2 April 2003, Eds Reid, S.W.J. and Menzies, F.D., pp. 119–131
- Verster, A., Imes, G.D.J. and Smit, J.P.J. (1975) Helminths recovered from the bontbok *Damaliscus dorcas dorcas* (Pallas, 1766). *Onderspoort Journal of Veterinary Research*, **42**, 29–32



- Vigre, H., Chriél, M., Hesselholt, M., Falk-Rønne, J. and Ersbøll, A.K. (2002) Risk factors for the hazard of lameness in Danish Standardbred trotters. *Preventive Veterinary Medicine*, **56**, 105–117
- Visser, I.J.R., Ingh, T.S.G.A.M., van den, Kruijf, J.M., Tielen, M.J.M., Urlings, H.A.P. and Gruys, E. (1988) Atrofische rhinitis: beoordeling van de lengtedoorsnede van varkenskoppen aan de slachtlijn ter bepaling van voorkomen en mate van concha-atrofie. (Atrophic rhinitis: the use of longitudinal sections of pigs' heads in the diagnosis of atrophy of the turbinate bones at the slaughter line.) *Tijdschrift voor Diergeneeskunde*, **113**, 1345–1355 (in Dutch)
- Vizard, A.L., Anderson, G.A. and Gasser, R.B. (1990) Determination of the optimum cut-off value of a diagnostic test. *Preventive Veterinary Medicine*, **10**, 137–143
- VMDB (2004) Veterinary Medical Database. <http://www.vmdb.org> (Accessed 13 October 2004)
- Vögeli, P., Kuhn, B., Kühne, R., Obrist, R., Stranziger, G., Huang, S.C., Hu, Z.L., Hasler-Rapacz, J. and Paracz, J. (1992) Evidence for linkage between the swine L blood group and the loci specifying the receptors mediating adhesion of K88 *Escherichia coli* pilus antigens. *Animal Genetics*, **23**, 19–29
- Voigt, D.R. and Earle, B.D. (1983) Avoidance of coyotes by red fox families. *Journal of Wildlife Management*, **47**, 852–857
- Voisin, C., Tonnel, A.B., Lahoute, C., Robin, H., Lebas, J. and Aerts, C. (1983) Bird fanciers lung: studies of bronchiolar lavage and correlations with inhalation provocation tests. *Lung*, **159**, 17–22
- Vollmer, F. (1999) *Agent Causality*. Kluwer Academic Publishers, Dordrecht
- Vordermeier, H.M., Cockle, P.J., Whelan, A.O., Rhodes, S., Chambers, M.A., Clifford, D., Huygen, K., Tascon, R., Lowrie, D., Colston, M.J. and Hewinson, R.G. (2000) Effective DNA vaccination of cattle with mycobacterial antigens MPB83 and MBP70 does not compromise the specificity of the comparative intradermal tuberculin skin test. *Vaccine*, **19**, 1246–1255
- Vordermeier, H.M., Lowrie, D.B. and Hewinson, R.G. (2003) Improved immunogenicity of DNA vaccination with mycobacterial HSP65 against bovine tuberculosis by protein boosting. *Veterinary Microbiology*, **93**, 349–359
- Vose, D. (2000) *Risk Analysis: A Quantitative Guide*, 2nd edn. John Wiley, Chichester
- Vraa-Andersen, L. (1991) Analysis of risk factors related to infection with *Actinobacillus pleuropneumoniae* and *Mycoplasma hyopneumoniae* in swine. In: Proceedings of the Sixth International Symposium on Veterinary Epidemiology and Economics, Ottawa, 12–16 August 1991. Ed. Martin, S.W., pp. 419–422
- VTCHIP (2003) *Vermont Cattle Health Improvement Project*. Vermont Department of Agriculture, 116 State Street, Drawer 20, Montpelier, VT 05620-2901, US. <http://www.vermontagriculture.com/vtchip.htm> (Accessed 4th July 2006)
- Waage, S. (2000) Influence of new infection with bovine virus diarrhoea virus on udder health in Norwegian dairy cows. *Preventive Veterinary Medicine*, **43**, 123–135
- Wachendörfer, G. and Frost, J.W. (1992) Epidemiology of red fox rabies: a review. In: *Wildlife Rabies Control*. Eds Bögel, K., Meslin, F.X. and Kaplan, M., pp. 19–31. Wells Medical, Tunbridge Wells
- Wagener, J.S., Sobonya, R., Minnich, L. and Taussig, L.M. (1984) Role of canine parainfluenza virus and *Bordetella bronchiseptica* in kennel cough. *American Journal of Veterinary Research*, **45**, 1862–1866
- Wahlström, H., Elvander, M., Engvall, A. and Vågsholm, I. (2002) Risk of introduction of BSE into Sweden by import of cattle from the United Kingdom. *Preventive Veterinary Medicine*, **54**, 131–140
- Waksberg, J. (1978) Sampling methods for random digit dialing. *Journal of the American Statistical Association*, **73**, 40–46
- Walden, A. (2003) Dr Louis Pasteur. *Primary Care Update for Ob/Gyns*, **10**, 68–70
- Waldner, C.L., Ribble, C.S. and Janzen, E.D. (1998) Evaluation of the impact of a natural gas leak from a pipeline on productivity of beef cattle. *Journal of the American Veterinary Medical Association*, **212**, 41–48
- Waldner, C.L., Ribble, C.S., Janzen, E.D. and Campbell, J.R. (2001a) Associations between oil- and gas-well sites, processing facilities, flaring, and beef cattle reproduction and calf mortality in western Canada. *Preventive Veterinary Medicine*, **50**, 1–17
- Waldner, C.L., Ribble, C.S., Janzen, E.D. and Campbell, J.R. (2001b) Associations between total sulfation, hydrogen sulfide deposition, and beef-cattle breeding outcomes in western Canada. *Preventive Veterinary Medicine*, **50**, 19–33
- Walett Darvelid, A. and Linde-Forsberg, C. (1994) Dystocia in the bitch: a retrospective study of 1002 cases. *Journal of Small Animal Practice*, **35**, 402–407
- Waller, P.J. (1992) Prospects for biological control of nematode parasites of ruminants. *New Zealand Veterinary Journal*, **40**, 1–3
- Wallgren, P., Löfstedt, M. and Heldmer, E. (1998) Strategic vaccination against *Mycoplasma hyopneumoniae* to avoid marketing contagious animals from multiplying herds. In: Proceedings of the 15th Congress of the International Pig Veterinary Society, 5–9 July 1998. Volume II: Oral Presentations, p. 149
- Walter, S.D. (1977) Determination of significant relative risks and optimal sampling procedures in prospective and retrospective comparative studies of various sizes. *American Journal of Epidemiology*, **105**, 387–397
- Walters, J.R. (1978) Problems associated with the movement and marketing of weaners. *The Pig Veterinary Society Proceedings*, **3**, 37–44
- Waltner-Toews, D. (1983) Questionnaire design and administration. In: Proceedings of the Third International Symposium on Veterinary Epidemiology and Economics. Arlington, Virginia, 6–10 September, 1982, pp. 31–37. Veterinary Medical Publishing Company, Edwardsville
- Waltner-Toews, D., Martin, S.W. and Meek, A.H. (1986a) Dairy calf management, morbidity and mortality in Ontario Holstein herds. II. Age and seasonal patterns. *Preventive Veterinary Medicine*, **4**, 125–135
- Waltner-Toews, D., Martin, S.W. and Meek, A.H. (1986b) Dairy calf management, morbidity and mortality in Ontario Holstein herds. III Association of management with morbidity. *Preventive Veterinary Medicine*, **4**, 137–158



- Waltner-Toews, D., Martin, S.W. and Meek, A.H. (1986c) Estimating disease prevalence using a test with no false positives. In: Proceedings of the 4th International Symposium on Veterinary Epidemiology and Economics. Singapore, 18–22 November 1985, pp. 414–415. Singapore Veterinary Association
- Waltner-Toews, D., Mondesire, R. and Menzies, P. (1991) The seroprevalence of *Toxoplasma gondii* in Ontario sheep flocks. *Canadian Veterinary Journal*, **32**, 734–737
- Wang, C.Y., Chiu, C.W., Pamukcu, A.M. and Bryan, G.T. (1976) Identification of carcinogenic tannin isolated from bracken fern (*Pteridium aquilinum*). *Journal of the National Cancer Institute*, **56**, 33–36
- Wansbrough, D. (2004) Deciding what the biosecurity system should deliver. *Biosecurity*, **54**, 4–5
- Warble, A. (1994) Veterinary Medical Data Base (VMDB) update. *American Veterinary Computer Society Newsletter*, September–October 1994, pp. 8–10
- Ward, K.A., Nancarrow, C.D., Byrne, C.R., Shanahan, C.M., Murray, J.D., Leish, Z., Townrow, C., Rigby, N.W., Wilson, B.W. and Hunt, C.L.H. (1990) The potential of transgenic animals for improved agricultural productivity. *Revue Scientifique et Technique, Office International des Epizooties*, **9**, 847–864
- Ward, M.P. (1991) Bluetongue virus infection in cattle in Queensland: a retrospective study of climatic factors. In: Proceedings of the Sixth International Symposium on Veterinary Epidemiology and Economics, Ottawa, 12–16 August 1991, Ed. Martin, S.W., pp. 230–234
- Ward, M.P. (2000) Forecasting blowfly strike in Queensland sheep flocks. *Veterinary Parasitology*, **92**, 309–317
- Ward, M.P. (2001) Use of interpolated climatic parameters to predict risk of blowfly strike in Queensland sheep flocks. *Preventive Veterinary Medicine*, **49**, 115–124
- Ward, M.P. (2002) Seasonality of canine leptospirosis in the United States and Canada and its association with rainfall. *Preventive Veterinary Medicine*, **56**, 203–213
- Ward, M.P. and Armstrong, T.F. (2000) Time–space clustering of reported blowfly strike in Queensland sheep flocks. *Preventive Veterinary Medicine*, **41**, 195–202
- Ward, M.P. and Carpenter, T.E. (2000a) Analysis of time–space clustering in veterinary epidemiology. *Preventive Veterinary Medicine*, **43**, 225–237
- Ward, M.P. and Carpenter, T.E. (2000b) Techniques for analysis of disease clustering space and time in veterinary epidemiology. *Preventive Veterinary Medicine*, **45**, 257–284
- Ward, M.P. and Perez, A.M. (2004) Association between soil type and paratuberculosis in cattle herds. *American Journal of Veterinary Research*, **65**, 10–14
- Ward, M.P. and Thurmond, M.C. (1995) Climatic factors associated with risk of seroconversion of cattle to bluetongue viruses in Queensland. *Preventive Veterinary Medicine*, **24**, 129–136
- Ward, M.P., Glickman, L.T. and Guptill, L.F. (2002a) Prevalence of and risk factors for leptospirosis among dogs in the United States and Canada: 677 cases (1970–1998). *Journal of the American Veterinary Medical Association*, **220**, 53–58
- Ward, W.R., Hughes, J.W., Faull, W.B., Cripps, P.J., Sutherland, J.P. and Sutherst, J.E. (2002b) Observational study of temperature, moisture, pH and bacteria in straw bedding, and faecal consistency, cleanliness and mastitis in cows in four dairy herds. *Veterinary Record*, **151**, 199–206
- Warnick, L.D., Crofton, L.M., Pelzer, K.D. and Hawkins, M.J. (2001) Risk factors for clinical salmonellosis in Virginia, USA cattle herds. *Preventive Veterinary Medicine*, **49**, 259–275
- Wassell, T.R. and Esslemont, R.J. (1992) Survey of the operation of dairy herd health schemes by veterinary practices in the United Kingdom. *Veterinary Record*, **130**, 260–263
- Wassink, G.J., Grogono-Thomas, R., Moore, L.J. and Green L.E. (2003) Risk factors associated with the prevalence of footrot in sheep from 1999 to 2000. *Veterinary Record*, **152**, 351–358
- Wassink, G.J., Grogono-Thomas, R., Moore, L.J. and Green, L.E. (2004) Risk factors associated with the prevalence of interdigital dermatitis in sheep from 1999 to 2000. *Veterinary Record*, **154**, 551–555
- Waters, A.J., Nicol, C.J. and French, N.P. (2002) Factors influencing the development of stereotypic and redirected behaviours in young horses: findings of a four year prospective epidemiological study. *Equine Veterinary Journal*, **34**, 572–579
- Wathes, C.M. (1987) Airborne microorganisms in pig and poultry houses. In: *Environmental Aspects of Respiratory Disease in Intensive Pig and Poultry Houses, Including Implications for Human Health*. Proceedings of a meeting, Aberdeen, 29–30 October 1986. Eds Bruce, J.M. and Sommer, M., pp. 57–71. Commission of the European Communities, Luxembourg. Report EUR 10820 EN
- Wathes, C.M. (1989) Ventilation of stables. *Farm Buildings and Engineering*, **6**, 21–25
- Wathes, C.M. (1994) Air and surface hygiene. In: *Livestock Housing*. Eds. Wathes, C.M. and Charles, D.R., pp. 123–148. CAB International, Wallingford
- Wathes, C.M., Jones, C.D.R. and Webster, A.J.F. (1983) Ventilation, air hygiene and animal health. *Veterinary Record*, **113**, 554–559
- Wathes, C.M., Zaidan, W.A.R., Pearson, G.R., Hinton, M. and Todd, J.N. (1988) Aerosol infection of calves and mice with *Salmonella typhimurium*. *Veterinary Record*, **123**, 590–594
- Watson, J.C. (1982) Food hygiene. Methods of linking meat inspection findings with disease on the farm and in human populations. In: *Epidemiology in Animal Health*. Proceedings of a symposium held at the British Veterinary Association's Centenary Congress, Reading, 22–25 September 1982, pp. 131–140. Society for Veterinary Epidemiology and Preventive Medicine
- Watt, G.E.L. (1980) An approach to determining the prevalence of liver fluke in a large region. In: *Veterinary Epidemiology and Economics*. Proceedings of the Second International Symposium, Canberra, 7–11 May 1979. Eds Geering, W.A., Roe, R.T. and Chapman, L.A., pp. 152–155. Australian Government Publishing Service, Canberra
- Way, M.J. (1977) Pest and disease status in mixed stands vs. monocultures; the relevance of ecosystem stability. In: *Origins of Pest, Parasite, Disease and Weed Problems*. 18th Symposium of the British Ecological Society, Bangor, 12–14 April 1976. Eds Cherrett, J.M. and Sagar, G.R., pp. 127–138. Blackwell Scientific Publications, Oxford
- Wayne, R.K. and Ostrander, E.A. (2004) Out of the dog house: the emergence of the canine genome. *Heredity*, **92**, 273–274

- Weatherall, J.A.C. and Haskey, J.C. (1976) Surveillance of malformations. *British Medical Bulletin*, **32**, 39–44
- Weaver, A.D. (1983) Survey with follow-up of 67 dogs with testicular sertoli cell tumours. *Veterinary Record*, **113**, 105–107
- Webb, C.R. and Sauter-Louis, C. (2002) Investigations into the contact structure of the British sheep population. In: Proceedings of the Society for Veterinary Epidemiology and Preventive Medicine, Cambridge, 3–5 April 2002. Eds Menzies, F.D. and Reid, S.W.J., pp. 10–20
- Webb, J.S., Thornton, I., Thompson, M., Howarth, R.J. and Lowenstein, P.L. (1978) *The Wolfston Geochemical Atlas of England and Wales*. Oxford University Press, London
- Weber, M. (1958) *Gesammelte Politischen Schriften*, 2nd edn. J.C.B. Mohr, Tubingen
- Weber, M.F., van Roermund, H.J.W., Assink, H.B.J. and Stegman, J.A. (2004) Rate and structure of cattle transfers between cattle herds considered to be free of paratuberculosis. In: Proceedings of the Society for Veterinary Epidemiology and Preventive Medicine, Martigny, 24–28 March 2004. Eds Reid, S.J.W., Menzies, F.D. and Russell, A.M., pp. 216–225
- Webster, A.J.F. (1981) Weather and infectious disease in cattle. *Veterinary Record*, **108**, 183–187
- Webster, A.J.F. (1982) Improvements of environment, husbandry and feeding. In: *The Control of Infectious Diseases in Farm Animals*. British Veterinary Association Trust Project on the future of animal health control, London, pp. 28–35
- Webster, A.J.F. (2001) Farm animal welfare: the five freedoms and the free market. *The Veterinary Journal*, **161**, 229–237
- Webster, A.J.F. (2002) Effects of housing practices on the development of foot lesions in dairy heifers in early lactation. *Veterinary Record*, **151**, 9–12
- Webster, R.G. (1993) Influenza. In: *Emerging Viruses*, Ed. Morse, S.S., pp. 37–45. Oxford University Press, New York
- Webster, R.G., Bean, W.J., Gorman, O.T., Chambers, T.M. and Kawaoka, Y. (1992) Evolution and ecology of influenza A viruses. *Microbiological Reviews*, **56** (1), 152–179
- Weed, D.L. (1986) On the logic of causal inference. *American Journal of Epidemiology*, **123**, 965–979
- Weigel, R.M., Austin, C.C., Siegel, A.M., Biehl, L.G. and Taft, A.C. (1992) Risk factors associated with the seroprevalence of pseudorabies virus in Illinois swine herds. *Preventive Veterinary Medicine*, **12**, 1–13
- Weijer, K. and Hart, A.A.M. (1983) Prognostic factors in feline mammary carcinoma. *Journal of the National Cancer Institute*, **70**, 709–716
- Weinberg, C.R. (1993) Toward a clearer definition of confounding. *American Journal of Epidemiology*, **137**, 1–8
- Weinberg, R.A. (1983) A molecular basis of cancer. *Scientific American*, **249** (5), 102–116
- Weingart, P. (1999) Scientific expertise and political accountability: paradoxes of science in politics. *Science and Public Policy*, **26**, 151–161
- Weinstein, M.C. and Fineberg, H.V. (1980) *Clinical Decision Analysis*. W.B. Saunders, Philadelphia
- Wells, D.J. and Wells, K.E. (2002) Gene transfer studies in animals: what do they really tell us about the prospects for gene therapy in DMD? *Neuromuscular Disorders*, **12**, S11–S22
- Wells, G.A.H., Scott, A.C., Johnson, C.T., Cuning, R.F., Hancock, R.D., Jeffrey, M., Dawson, M. and Bradley, R. (1987) A novel progressive spongiform encephalopathy in cattle. *Veterinary Record*, **121**, 419–420
- Wells, S.J. and Wagner, B.A. (2000) Herd-level risk factors for infection with *Mycobacterium paratuberculosis* in US dairies and association between familiarity of the herd manager with the disease or prior diagnosis of the disease in that herd and use of preventive measures. *Journal of the American Veterinary Medical Association*, **216**, 1450–1457
- Wells, S.J., Trent, A.M., Marsh, W.E., McGovern, P.G. and Robinson, R.A. (1993a) Individual cow risk factors for clinical lameness in lactating dairy cows. *Preventive Veterinary Medicine*, **17**, 95–109
- Wells, S.J., Trent, A.M., Marsh, W.E. and Robinson, R.A. (1993b) Prevalence and severity of lameness in lactating dairy cows in a sample of Minnesota and Wisconsin herds. *Journal of the American Veterinary Medical Association*, **202**, 78–82
- Wells, S.J., Trent, A.M., Collier, R.J. and Cole, W.J. (1995) Effect of long-term administration of a prolonged release formulation of bovine somatotrophin (sometribove) on clinical lameness in dairy cows. *American Journal of Veterinary Research*, **56**, 992–996
- Wells, S.J., Dargatz, D.A. and Ott, S.L. (1996) Factors associated with mortality to 21 days of life in dairy heifers in the United States. *Preventive Veterinary Medicine*, **29**, 9–19
- Welsh, E.M., Gettinby, G. and Nolan, A.M. (1993) Comparison of a visual analogue scale and a numerical rating scale for assessment of lameness, using sheep as a model. *American Journal of Veterinary Research*, **54**, 976–983
- West, D.M., Bruère, A.N. and Ridler, A.L. (2002) *The Sheep: Health, Disease and Production*, 2nd edn. Veterinary Continuing Education, Massey University, Palmerston North, New Zealand
- West, G.P. (1972) *Rabies in Animals and Man*. David and Charles, Newton Abbot
- West, G.P. (Ed.) (1995) *Black's Veterinary Dictionary*, 18th edn. A & C Black, London
- Westwood, C.T., Bramley, E. and Lean, I.J. (2003) Review of the relationship between nutrition and lameness in pasture-fed dairy cattle. *New Zealand Veterinary Journal*, **51**, 208–218
- Wetherill, G.B. (1969) *Sampling Inspection and Quality Control*. Methuen, London
- Whipple, D.L., Bolin, C.A., Davis, A.J., Jarnagin, J.L., Johnson, D.C., Nabors, R.S., Payeur, J.B., Saari, D.A., Wilson, A.J. and Wolf, M.M. (1995) Comparison of the sensitivity of the caudal fold skin test and a commercial  $\gamma$ -interferon assay for diagnosis of bovine tuberculosis. *American Journal of Veterinary Research*, **56**, 415–419
- Whitaker, D.A. (2000) Use and interpretation of metabolic profiles. In: *The Health of Dairy Cattle*. Ed. Andrews, A.H., pp. 89–107. Blackwell Science, Oxford
- Whitaker, D.A. and Kelly, J.M. (1982) Incidence of clinical and subclinical hypomagnesaemia in dairy cows in England and Wales. *Veterinary Record*, **110**, 450–451
- Whitaker, D.A., Kelly, J.M. and Smith, E.J. (1983) Incidence of lameness in dairy cows. *Veterinary Record*, **113**, 60–62

- Whitaker, D.A., Kelly, J.M. and Smith, S. (2000) Disposal and disease rates in 340 British dairy herds. *Veterinary Record*, **146**, 363–367
- Whitaker, D.A., Macrae, A.I. and Burrough, P. (2004) Disposal and disease rates in British dairy herds between April 1998 and March 2002. *Veterinary Record*, **155**, 43–47
- White, F. (1983) *The Vegetation of Africa – A Descriptive Memoir to Accompany the UNESCO/AETFAT/UNSO Vegetation Map of Africa*. United Nations Educational, Scientific and Cultural Organization, Paris
- White, M.E. and Vellake, E. (1980) A coding system for veterinary clinical signs. *Cornell Veterinarian*, **70**, 160–182
- White, N.A. and Lessard, P. (1986) Risk factors and clinical signs associated with cases of equine colic. In: Proceedings of the 32nd Annual Convention of the American Association of Equine Practitioners, Nashville, Tennessee, 29 November–3 December 1986, pp. 637–644
- Whitehair, J.G., Vasseur, P.B. and Willits, N.H. (1993) Epidemiology of cranial cruciate ligament rupture in dogs. *Journal of the American Veterinary Medical Association*, **203**, 1016–1019
- Whitehead, J. (1993) Sample size calculations for ordered categorical data. *Statistics in Medicine*, **12**, 2257–2272
- Whiteley, L.O., Maheswaran, S.K., Weiss, D.J., Ames, T.R. and Kannan, M.S. (1992) *Pasteurella haemolytica* A1 bovine respiratory disease: pathogenesis. *Journal of Veterinary Internal Medicine*, **6**, 11–22
- Whiteside, A. (Ed.) (1998) *Implications of AIDS for Demography and Policy in South Africa*. University of Natal Press, Pietermaritzburg
- Whitlock, R.H., Wells, S.J., Sweeney, R.W. and Van Tiem, J. (2000) ELISA and fecal culture for paratuberculosis (Johne's disease): sensitivity and specificity of each method. *Veterinary Microbiology*, **77**, 387–398
- Whittaker, M. (1960) The supernatural in the Roman Empire. *Church Quarterly Review*, **161**, 185–199
- Whittington, R. (2003) Emerging diseases in Australia. *Commonwealth Veterinary Association News*, **19** (2), 51–60
- WHO (1959) *Immunological and Haematological Surveys*. Report of a study group. World Health Organization Technical Report Series No. 181
- WHO (1970) *Multipurpose Serological Surveys and WHO Serum Reference Banks*. Report of a World Health Organization scientific group. World Health Organization Technical Report Series No. 454
- WHO (1978) Proposals for the nomenclature of salivarian trypanosomes and for the nomenclature of reference collections. *Bulletin of the World Health Organization*, **56**, 467–480
- WHO (1993) *Evaluation of Certain Veterinary Drug Residues in Food*, Fortieth report of the Joint FAO/WHO Expert Committee on Food Additives. World Health Organization Technical Report Series No. 832. World Health Organization, Geneva
- WHO (1996) *Emerging Foodborne Diseases*. WHO Fact Sheet No. 124. World Health Organization, Geneva
- WHO (2003) *Basic Documents*, 44th edn. World Health Organization, Geneva
- Wierup, M. (1983) The Swedish canine parvovirus epidemic – an epidemiological study in a dog population of defined size. *Preventive Veterinary Medicine*, **1**, 273–288
- Wierup, M., Wold-Troell, M., Nurmi, E. and Hakkinen, M. (1988) Epidemiological evaluation of the Salmonella-controlling effect of a nationwide use of a competitive exclusion culture in poultry. *Poultry Science*, **67**, 1026–1033
- Wigley, P. (2004) Genetic resistance to *Salmonella* infection in domestic animals. *Research in Veterinary Science*, **76**, 165–169
- Wilesmith, J.W. (1993) BSE: epidemiological approaches, trials and tribulations. *Preventive Veterinary Medicine*, **18**, 33–42
- Wilesmith, J.W. and Clifton-Hadley, R.S. (1991) Observations from an epidemiological study of tuberculosis in a naturally infected badger population. In: Proceedings of the Society for Veterinary Epidemiology and Preventive Medicine, London, 17–19 April 1991, Ed. Thrusfield, M.V., pp. 133–144
- Wilesmith, J.W. and Gitter, M. (1986) Epidemiology of ovine listeriosis in Great Britain. *Veterinary Record*, **119**, 467–470
- Wilesmith, J.W. and Ryan, J.B.M. (1992) Bovine spongiform encephalopathy: recent observations on the age-specific incidences. *Veterinary Record*, **130**, 491–492
- Wilesmith, J.W., Little, T.W.A., Thompson, H.V. and Swan, C. (1982) Bovine tuberculosis in domestic and wild mammals in an area of Dorset. I. Tuberculosis in cattle. *Journal of Hygiene, Cambridge*, **89**, 195–210
- Wilesmith, J.W., Francis, P.G. and Wilson, C.D. (1986) Incidence of clinical mastitis in a cohort of British dairy herds. *Veterinary Record*, **118**, 199–204
- Wilesmith, J.W., Wells, G.A.H., Cranwell, M.P. and Ryan, J.B.M. (1988) Bovine spongiform encephalopathy: epidemiological studies. *Veterinary Record*, **123**, 638–644
- Wilesmith, J.W., Wells, G.A.H., Ryan, J.B.M., Gavier-Widen, D. and Simmons, M.M. (1997) A cohort study to examine maternally-associated risk factors for bovine spongiform encephalopathy. *Veterinary Record*, **141**, 239–243
- Wilkinson, P.J. (1984) The persistence of African swine fever in Africa and the Mediterranean. *Preventive Veterinary Medicine*, **2**, 71–82
- Will, R.G. (1997) A new variant of Creutzfeldt–Jakob disease in the UK. In: Proceedings of the Society for Veterinary Epidemiology and Preventive Medicine, Chester, 9–11 April 1997. Eds Goodall, E.A. and Thrusfield, M.V., pp. 85–88
- Willcox, A.W. (2002) Mummies and molecules: molecular biology meets paleopathology. *Clinical Microbiology Newsletter*, **24**, 57–60
- Willeberg, P. (1975a) A case-control study of some fundamental determinants in the epidemiology of the feline urological syndrome. *Nordisk Veterinærmedicin*, **27**, 1–14
- Willeberg, P. (1975b) Diets and the feline urological syndrome, a retrospective case-control study. *Nordisk Veterinærmedicin*, **27**, 15–19
- Willeberg, P. (1975c) Outdoor activity level as a factor in the feline urological syndrome. *Nordisk Veterinærmedicin*, **27**, 523–524
- Willeberg, P. (1976) Interaction effects of epidemiologic factors in the feline urological syndrome. *Nordisk Veterinærmedicin*, **28**, 193–200
- Willeberg, P. (1977) Animal disease information processing: epidemiologic analyses of the feline urological syndrome. *Acta Veterinaria Scandinavica*, **18**, Suppl. 64, 1–48

- Willeberg, P. (1979) The Danish swine slaughter inspection data bank and some epidemiological applications. In: *Proceedings of an International Symposium on Animal Health and Disease Data Banks*, 4–6 December 1978, pp. 133–145. United States Department of Agriculture, Washington, DC. Miscellaneous Publication Number 1381
- Willeberg, P. (1980a) Abattoir surveillance in Denmark. *The Pig Veterinary Society Proceedings*, **6**, 43–54
- Willeberg, P. (1980b) The analysis and interpretation of epidemiological data. In: *Veterinary Epidemiology and Economics*. Proceedings of the Second International Symposium, Canberra, 7–11 May 1979. Eds Geering, W.A., Roe, R.T. and Chapman, L.A., pp. 185–198. Australian Government Publishing Service, Canberra
- Willeberg, P. (1981) Epidemiology of the feline urological syndrome. *Advances in Veterinary Science*, **25**, 311–344
- Willeberg, P. (1986) Epidemiologic use of routinely collected veterinary data: risks and benefits. In: *Proceedings of the Fourth International Symposium on Veterinary Epidemiology and Economics*, Singapore, 18–22 November 1985, pp. 40–45
- Willeberg, P. (1991) Animal welfare studies: epidemiological considerations. In: *Proceedings of the Society for Veterinary Epidemiology and Preventive Medicine*, London, 17–19 April 1991. Ed. Thrusfield, M.V., pp. 76–82
- Willeberg, P. (1992) Disease Monitoring in Denmark. In: *Minnesota Swine Conference for Veterinarians*. High-Health Strategies, College of Veterinary Medicine, University of Minnesota. *Veterinary Continuing Education and Extension, USA*, **19**, 95–101
- Willeberg, P. (1993) Bovine somatotropin and clinical mastitis: epidemiological analysis of the welfare risk. *Livestock Production Science*, **36**, 55–66
- Willeberg, P. (1997) Epidemiology and animal welfare. In: *Proceedings of the Eighth International Symposium on Veterinary Epidemiology and Economics*, Paris, July 1997. *Epidémiologie et Santé Animale*, **31–32**, Vol. 1, pp. iii–vii
- Willeberg, P. and Priester, W.A. (1976) Feline urological syndrome: association with some time, space, and individual patient factors. *American Journal of Veterinary Research*, **37**, 975–978
- Willeberg, P., Gerbola, M.-A., Madsen, A., Mandrup, M., Nielsen, E.K., Riemann, H.P. and Aalund, O. (1978) A retrospective study of respiratory disease in a cohort of bacon pigs: I Clinico-epidemiological analyses. *Nordisk Veterinærmedicin*, **30**, 513–525
- Willeberg, P., Grymer, J. and Hesselholt, M. (1982) Left displacement at the abomasum: relationship to age and medical history. *Nordisk Veterinærmedicin*, **34**, 404–411
- Willeberg, P., Gerbola, M.-A., Kirkegaard Petersen, B. and Andersen, J.B. (1984) The Danish pig health scheme; nationwide computer-based abattoir surveillance and follow-up at the herd level. *Preventive Veterinary Medicine*, **3**, 79–91
- Willeberg, P., Gardner, I.A., Mortensen, S. and Mousing, J. (1994) Models of herd size effects in swine diseases. In: *Proceedings of the Seventh International Symposium on Veterinary Epidemiology and Economics*, Nairobi, 15–19 August 1994. Eds Rowlands, G.J., Kyule, M.N. and Perry, B.D. *The Kenya Veterinarian*, **18** (2), 189–191
- Willems, R.J.L., Top, J., van den Braak, N., van Belkum, A., Endtz, H., Mevius, D., Stobberingh, E., van den Bogaard, A. and van Embden, J.D.A. (2000) Host specificity of vancomycin-resistant *Enterococcus faecium*. *Journal of Infectious Diseases*, **182**, 816–823
- Willemsse, T. (1986) Atopic skin disease: a review and a reconsideration of diagnostic criteria. *Journal of Small Animal Practice*, **27**, 771–778
- Willett, W. (1990) *Nutritional Epidemiology*. Oxford University Press, New York
- Willetts, N. and Cobon, G. (1993) Antiparasite vaccines. In: *Vaccines for Veterinary Applications*. Ed. Peters, R., pp. 259–294. Butterworth-Heinemann, Oxford
- Williams, E.S. and Barker, I.K. (Eds) (2001) *Infectious Diseases of Wild Mammals*, 3rd edn. Manson Publishing, London
- Williams, E.S. and Young, S. (1980) Chronic wasting disease of captive mule deer: a spongiform encephalopathy. *Journal of Wildlife Diseases*, **16**, 89–98
- Williams, E.S., Thorne, E.T., Appel, M.J.G. and Belitsky D.W. (1988) Canine distemper in black footed ferrets (*Mustela nigripes*) from Wyoming. *Journal of Wildlife Diseases*, **24**, 385–398
- Williams, E.S., Yuill, T., Artois, M., Fisher, J. and Haigh, S.A. (2002) Emerging infectious diseases. *Revue Scientifique et Technique, Office International des Epizooties*, **21**, 139–157
- Williams, G.W. (1984) Time-space clustering of disease. In: *Statistical Methods for Cancer Studies*. Ed. Cornell, R.G., pp. 167–227. Marcel Dekker, New York and Basel
- Williams, M.E. and Esslemont, R.J. (1993) A decision support system using milk progesterone tests to improve fertility in commercial dairy herds. *Veterinary Record*, **132**, 503–506
- Williams, P.C.W. and Ward, W.R. (1989a) Development of a coding system for recording clinical findings in farm animal practice. *Veterinary Record*, **124**, 118–122
- Williams, P.C.W. and Ward, W.R. (1989b) Development of a microcomputer system for recording veterinary visits, preparing accounts, and as an aid to herd fertility and health schemes. *Veterinary Record*, **124**, 265–268
- Williams, R.J. and Martinez, N.D. (2000) Simple rules yield complex food webs. *Nature*, **404**, 180–183
- Williamson, L. (1995) Preventative health care. In: *The Horse: Diseases and Clinical Management*. Eds Kobluk, C.N., Ames, T.R. and Geor, R.J., pp. 83–90. W.B. Saunders, Philadelphia
- Williamson, M.H. and Wilson, R.A. (1978) The use of mathematical models for predicting the incidence of fascioliasis. In: *Weather and Parasitic Animal Disease*. Ed. Gibson, T.E., pp. 39–48. World Meteorological Organization Technical Note No. 159
- Williamson, N.B. (1980) The economic efficiency of a veterinary preventive medicine and management program in Victorian dairy herds. *Australian Veterinary Journal*, **56**, 1–9
- Williamson, N.B. (1987) Evaluating herd reproductive status. *Proceedings of the American Association of Bovine Practitioners*, **19**, 117–121
- Williamson, N.B. (1993) The economics of preventive veterinary medicine schemes in sheep and cattle. In: *The William Dick Bicentenary Proceedings*. The University of Edinburgh, 7–10 July 1993, pp. 13–16. Royal (Dick) School of Veterinary Studies, University of Edinburgh
- Wilson, C.D. and Richards, M.S. (1980) A survey of mastitis in the British dairy herd. *Veterinary Record*, **106**, 431–435

- Wilson, C.D., Richards, M.S., Stevenson, F.J. and Davies, G. (1983) *The National Mastitis Survey. A Survey of Udder Infection and Related Factors in the British Dairy Herd 1977*. Ministry of Agriculture, Fisheries and Food Booklet 2433
- Wilson, D.W. and Beers, P.T. (2001) Global trade requirements and compliance with World Trade Organization agreements: the role of tracing animals and animal products. *Revue Scientifique et Technique, Office International des Epizooties*, **20**, 379–384
- Wilson, E.B. (1927) Probable inference, the law of succession, and statistical inference. *Journal of the American Statistical Association*, **22**, 209–212
- Wilson, G.P., Hayes, H.M. and Casey, H.W. (1979) Canine urethral cancer. *Journal of the American Animal Hospital Association*, **15**, 741–744
- Wilson, J.B., McEwen, S.A., Clarke, R.C., Leslie, K.E., Waltner-Toews, D. and Gyles, C.L. (1993) Risk factors for bovine infection with verocytotoxigenic *Escherichia coli* in Ontario, Canada. *Preventive Veterinary Medicine*, **16**, 159–170
- Wilson, J.M. (1996) Animal models of human disease for gene therapy. *Journal of Clinical Investigation*, **97**, 1138–1141
- Wilson, S.M. (1993) Application of nucleic acid-based technologies to the diagnosis and detection of disease. *Transactions of the Royal Society of Tropical Medicine and Hygiene*, **87**, 609–611
- Wilson, T.M. and Howes, B. (1980) An epizootic of bovine tuberculosis in Barbados, West Indies. Proceedings of the Second International Symposium of Veterinary Laboratory Diagnosticians, 24–26 June 1980, Lucerne, Switzerland, Vol. 1, pp. 136–144
- Wilton, J.W., Van Vleck, L.D., Everett, R.W., Guthrie, R.S. and Roberts, S.J. (1972) Genetic and environmental aspects of udder infections. *Journal of Dairy Science*, **55**, 183–193
- Wineland, N.E. and Dargatz, D.A. (1998) The National Animal Health Monitoring System: a source of on-farm information. *Veterinary Clinics of North America, Food Animal Practice*, **14**, 127–139
- Winkler, W.G. (1975) Fox rabies. In: *The Natural History of Rabies*, Vol. 2. Ed. Baer, G.M., pp. 3–22. Academic Press, New York
- Winslow, C.-E.A. (1934) The epidemiology of Noah Webster. *Transactions of the Connecticut Academy of Arts and Sciences*, **32**, 21–109
- Wise, J.K. and Yang, J.-J. (1992) Demographic and employment shifts of US veterinarians, 1980 to 1990. *Journal of the American Veterinary Medical Association*, **201**, 684–687
- Withrow, S.J. (2001) Why worry about cancer in pets? In: *Small Animal Clinical Oncology*, 3rd edn. Eds Withrow, S.J. and MacEwan, E.G., pp. 1–3. W.B. Saunders, Philadelphia
- Witowski, J.A. and Parish, L.C. (2002) The story of anthrax from antiquity to the present: a biological weapon of nature and humans. *Clinics in Dermatology*, **20**, 336–342
- Wittes, J. (2002) Sample size calculations for randomised controlled trials. *Epidemiologic Reviews*, **24**, 39–53
- Wittmann, E.J. and Baylis, M. (2000) Climate change: effects on *Culicoides*-transmitted viruses and implications for the UK. *The Veterinary Journal*, **160**, 107–117
- Wittum, T.E., King, M.E. and Salman, M.D. (1991) Determinants of health and performance of calves in Colorado beef herds. In: Proceedings of the Sixth International Symposium on Veterinary Epidemiology and Economics, Ottawa, 12–16 August 1991. Ed. Martin, S.W., pp. 336–338
- Wittum, T.E., Salman, M.D., King, M.E., Mortimer, R.G., Odde, K.G. and Morris, D.L. (1994a) Individual animal and maternal risk factors for morbidity and mortality of neonatal beef calves in Colorado, USA. *Preventive Veterinary Medicine*, **19**, 1–13
- Wittum, T.E., Salman, M.D., King, M.E., Mortimer, R.G., Odde, K.G. and Morris, D.L. (1994b) The influence of neonatal health on weaning weight in Colorado, USA beef calves. *Preventive Veterinary Medicine*, **19**, 15–25
- Witz, J. (1998) One hundred years ago: the discovery of the filterability of viruses. *Biology of the Cell*, **90**, 257–258
- Wlaschitz, S. (2004) Grass sickness: a literature review. *Wiener Tierärztliche Monatsschrift*, **91**, 14–22 (in German; English abstract)
- Wojciechowski, K.J. (1991) Global strategies for rinderpest eradication. In: *South Asia Rinderpest Eradication Campaign*. Proceedings of the Regional Expert Consultation on Rinderpest Eradication in South Asia, Bangkok, Thailand, 5–8 June 1990. RAPA Publication 1991/8, pp. 78–90. Food and Agriculture Organization, Bangkok
- Woldehiwet, Z. and Ristic, M. (Eds) (1993) *Rickettsial and Chlamydial Diseases of Domestic Animals*. Pergamon Press, Oxford
- Wolf, F.M. (1986) *Meta-Analysis: Quantitative Methods for Research Synthesis*. Sage Publications, Beverly Hills
- Wong, W.T. and Lee, M.K.C. (1985) Some observations on the population and natal patterns among purebred dogs in Malaysia. *Journal of Small Animal Practice*, **26**, 111–119
- Wood, B., Washino, R., Beck, L., Hibbard, K., Pitcairn, M., Roberts, D., Rejmankova, E., Paris, J., Hacker, C., Salute, J., Sebesta, P. and Legters, L. (1991) Distinguishing high and low anopheline-producing rice fields using remote sensing and GIS technologies. *Preventive Veterinary Medicine*, **11**, 277–288
- Wood, E.N. (1978) The incidence of stillborn piglets associated with high atmospheric carbon monoxide levels. *The Pig Veterinary Society Proceedings*, **3**, 117–118
- Wood, J.L.N. and Lakhani, K.H. (1997) Prevalence and prevention of deafness in the Dalmatian – assessing the effect of parental hearing status and gender using ordinary logistic and generalized random litter effect models. *Veterinary Journal*, **154**, 121–133
- Wood, J.L.N. and Lakhani, K.H. (1998) Deafness in Dalmatians: Does sex matter? *Preventive Veterinary Medicine*, **36**, 39–50
- Wood, J.L.N. and Lakhani, K.H. (2003a) Effect of month of birth on hip dysplasia in Labrador retrievers and Gordon setters. *Veterinary Record*, **152**, 69–72
- Wood, J.L.N. and Lakhani, K.H. (2003b) Hip dysplasia in Labrador retrievers: the effects of age at scoring. *Veterinary Record*, **152**, 37–40
- Wood, J.L.N., Doxey, D.L. and Milne, E.M. (1994) Preliminary analysis of a matched case-control study of grass sickness in the United Kingdom. In: Proceedings of the Society for Veterinary Epidemiology and Preventive Medicine, Belfast, 13–15 April 1994. Ed. Thrusfield, M.V., pp. 155–166
- Wood, J.L.N., Milne, E.M. and Doxey, D.L. (1998) A case-

- control study of grass sickness (equine dysautonomia) in the United Kingdom. *Veterinary Journal*, **156**, 7–14
- Wood, J.L.N., Lakhani, K.H., Mason, I.K. and Barnett, K.C. (2001a) Relationship of the degree of goniodysgenesis and other ocular measurements to glaucoma in Great Danes. *American Journal of Veterinary Research*, **62**, 1493–1499
- Wood, J.L.N., Eastment, J., Lakhani, K.H., Harkins, L. and Rogers, K. (2001b) Modelling a retrospective study of death on racecourses. In: Society for Veterinary Epidemiology and Preventive Medicine, Proceedings, Noordwijkerhout, The Netherlands, 28–30 March 2001, Eds Menzies, F.D. and Reid, S.W.J., pp. 115–126
- Wood, J.L.N., Lakhani, K.H. and Rogers, K. (2002) Heritability and epidemiology of canine hip-dysplasia score and its components in Labrador retrievers in the United Kingdom. *Preventive Veterinary Medicine*, **55**, 95–108
- Wood, J.L.N., Lakhani, K.H. and Henley, W.E. (2004) An epidemiological approach to prevention and control of three common heritable diseases in canine pedigree breeds in the United Kingdom. *The Veterinary Journal*, **168**, 14–27
- Wood, J.L.N., Kelly, L., Cardwell, J.M. and Park, A.W. (2005) Quantitative assessment of the risks of reducing the routine swabbing requirements for the detection of *Taylorella equigenitalis*. *Veterinary Record*, **157**, 41–46
- Woodford, M.H. (1993) International disease implications for wildlife translocation. *Journal of Zoo and Wildlife Medicine*, **24**, 265–270
- Woodruff, A.W. (1976) Toxocarasis as a public health problem. *Environmental Health*, **84**, 29–31
- Woodward, R.H. and Goldsmith, P.L. (1964) *Cumulative Sum Techniques*. Imperial Chemical Industries Mathematical and Statistical Techniques for Industry Monograph No. 3. Oliver and Boyd, Edinburgh
- Woolcock, J.B. (1991) Microbial interactions in health and disease. In: *Microbiology of Animals and Animal Products*. World Animal Science, Vol. A6. Ed. Woolcock, J.B., pp. 61–76. Elsevier, Amsterdam
- Worldridge, M., Hartnett, E., Cox, A. and Seaman, M. (2006) Quantitative risk assessment case study: smuggled meats as disease vectors. *Revue Scientifique et Technique, Office International des Epizooties*, **25**, 105–117
- Worldridge, M.J.A., Hoinville, L.J. and Wilesmith, J.W. (1992) A scrapie survey by postal questionnaire: aims, problems and results. In: Society for Veterinary Epidemiology and Preventive Medicine, Denary Proceedings, Edinburgh, 1–3 April 1992. Ed. Thrusfield, M.V., pp. 78–89
- Woolf, B. (1955) On estimating the relation between blood group and disease. *Annals of Human Genetics*, **19**, 251–253
- Worthington, R.W. (1982) Serology as an aid to diagnosis: uses and abuses. *New Zealand Veterinary Journal*, **30**, 93–97
- Wrathall, A.E. (1975) *Reproductive Disorders in Pigs*. Review Series No. 11 of the Commonwealth Bureau of Animal Health. Commonwealth Agricultural Bureaux, Farnham Royal
- Wrathall, A.E. (1997) Risks of transmitting scrapie and bovine spongiform encephalopathy by semen and embryos. *Revue Scientifique et Technique, Office International des Epizooties*, **16**, 240–264
- Wrathall, A.E. and Hebert, C.N. (1982) Monitoring reproductive performance in the pig herd. *The Pig Veterinary Society Proceedings*, **9**, 136–148
- Wratten, S.D., Mead-Briggs, M., Gettinby, G., Ericsson, G. and Baggott, D.G. (1993) An evaluation of the potential effects of ivermectin on the decomposition of cattle dung pats. *Veterinary Record*, **133**, 365–371
- Wray, C. and Woodward, M.J. (1990) Biotechnology and veterinary science. *Revue Scientifique et Technique, Office International des Epizooties*, **9**, 779–794
- Wright, S. (1959) Genetics and hierarchy of biological sciences. *Science, New York*, **130**, 959–965
- Wright, W.C. (1930) *Fracastorius: Contagion, Contagious Diseases and their Treatment*. G.P. Putnam's Sons, New York
- Wynder, E.L. (1985) Applied epidemiology. *American Journal of Epidemiology*, **121**, 781–782
- Wynne, S.G. (1998) Studies on use of homeopathy in animals. *Journal of the American Veterinary Medical Association*, **212**, 719–724
- Wynne-Edwards, V.C. (1962) *Animal Dispersion in Relation to Social Behaviour*. Oliver and Boyd, Edinburgh
- Xae, J.L., Dial, G.D., Marsh, W.E. and Davies, P.R. (1994) Multiple manifestations of season on reproductive performance of commercial swine. *Journal of the American Veterinary Medical Association*, **204**, 1486–1489
- Xu, Z.Z., Burton, L.J. and Macmillan, K.L. (1996) Reproductive performance of lactating dairy cows following oestrus synchronisation with progesterone, oestradiol and prostaglandin. *New Zealand Veterinary Journal*, **44**, 99–104
- Yamaguchi, S., Imada, T. and Kawamura, H. (1979) Characterization of a picornavirus isolated from broiler chicks. *Avian Diseases*, **23**, 571–581
- Yamane, I., Kamata, A., Sugiura, K., Hamaoka, T., Murakami, Y., Shirai, J. and Nanba, K. (1997) An epidemiological analysis of foot and mouth disease outbreak in Taiwan using geographic information system. *Journal of the Japan Veterinary Medical Association*, **50**, 583–586 (in Japanese; English abstract)
- Yapi, C.V., Boylan, W.J. and Robinson, R.A. (1990) Factors associated with causes of preweaning lamb mortality. *Preventive Veterinary Medicine*, **10**, 145–152
- Yates, D., Hayes, G., Heffernan, M. and Beynon, R. (2003) Incidence of cryptorchidism in dogs and cats. *Veterinary Record*, **152**, 502–504
- Yates, F. (1981) *Sampling Methods for Censuses and Surveys*, 4th edn. Charles Griffin, London and High Wycombe
- Yates, W.D.G. (1982) Interaction between viruses in bovine respiratory diseases. A review of infectious bovine rhinotracheitis, shipping fever pneumonia and viral bacterial synergism in respiratory diseases in cattle. *Canadian Journal of Comparative Medicine*, **46**, 341–349
- Yekutieli, P. (1980) *Eradication of Infectious Disease – A Critical Study*. Contributions to Epidemiology and Biostatistics, Vol. 2. S. Karger, Basel
- Yerushalmy, J. and Palmer, C.E. (1959) On the methodology of investigations of etiologic factors in chronic diseases. *Journal of Chronic Diseases*, **10**, 27–40
- Yilma, J.M. and Malone, J.B. (1998) A geographic information system forecast model for strategic control of fasciolosis in Ethiopia. *Veterinary Parasitology*, **78**, 103–127
- Yoon, H.-Y., Yoon, C.-S., Jeong, S.-W., Kim, T.-J., Park, S.-Y., Chung, B.-H., Choi, Y.-M. and Lee, W.-C. (2002)

- Prevalence and relative risk of canine dirofilariosis among dogs in Seoul, South Korea. *Veterinary Record*, **151**, 576–577
- Yoon, J.W., Kim, C.M., Pak, C.Y. and McArthur, R.G. (1987) Effects of environmental factors on the development of insulin-dependent diabetes mellitus. *Clinical and Investigative Medicine*, **10**, 457–469
- Yorke, J.A. and London, W.P. (1973) Recurrent outbreaks of measles, chickenpox and mumps. II. Systematic differences in contact rates and stochastic effects. *American Journal of Epidemiology*, **98**, 469–482
- Yoshida, N., Miyamoto, T., Fukusho, N.S. and Tajima, M. (1977) Properties of paramyxovirus isolated from budgerigars with an acute fatal disease. *Journal of the Japanese Veterinary Medical Association*, **30**, 599–603
- Young, G.B., Lee, G.J., Waddington, D., Sales, D.I., Bradley, J.S. and Spooner, R.L. (1983) Cutting wastage in dairy cows in East Anglia. *Veterinary Record*, **113**, 107–111
- Young, L.E. and Wood, J.L.N. (2000) Effect of age and training on murmurs of atrioventricular valvular regurgitation in young Thoroughbreds. *Equine Veterinary Journal*, **32**, 195–199
- Yuasa, N., Taniguchi, T. and Yashida, I. (1979) Isolation and some characteristics of an agent inducing anaemia in chicks. *Avian Diseases*, **23**, 366–385
- Yusuf, S., Held, P. and Furberg, C. (1991) Update of effects of calcium antagonists in myocardial infarction or angina in light of the second Danish verapamil infarction trials (DAVIT-II) and other recent studies. *American Journal of Cardiology*, **67**, 1295–1297
- Zak, O. and Sande, M.A. (Eds) (1999) *Handbook of Animal Models of Infection*. Academic Press, San Diego
- Zambon, M. (1998) Laboratory diagnosis of influenza. In: *Textbook of Influenza*. Eds Nicholson, K.G., Webster, R.G. and Hay, A.K., pp. 291–313. Blackwell Science, Oxford
- Zambon, M. and Joseph, C. (2001) *The PHLS Plan for Pandemic Influenza*. Public Health Laboratory Service, London
- Zar, J.H. (1996) *Biostatistical Analysis*, 3rd edn. Prentice Hall, New Jersey
- Zarkovich, S.S. (1966) *Quality of Statistical Data*. Food and Agriculture Organization of the United Nations, Rome
- Zecconi, A., Piccinini, R. and Fox, L.K. (2003) Epidemiologic study of intramammary infections with *Staphylococcus aureus* during a control program in nine commercial dairy herds. *Journal of the American Veterinary Medical Association*, **223**, 684–688
- Zelen, M. (1969) Play the winner rule and the controlled clinical trial. *Journal of the American Statistical Association*, **64**, 131–146
- Zelen, M. (1974) The randomization and stratification of patients to clinical trials. *Journal of Chronic Diseases*, **27**, 365–375
- Zetterquist, P. (1972) *A Clinical and Genetic Study of Congenital Heart Defects*. Institute for Medical Genetics, University of Uppsala, Sweden
- Zlotogora, J. (1998) Recessive or dominant? Reclassification in the molecular age. *Clinical Genetics*, **53**, 423–425
- Zuckerman, Lord (1980) *Badgers, Cattle and Tuberculosis*. Report to the Right Honourable Peter Walker. Her Majesty's Stationery Office, London
- Zukowski, S.H., Hill, J.M., Jones, F.W. and Malone, J.B. (1991) Development and validation of a soil-based geographic information system model of habitat of *Fossaria bulimoides*, a snail intermediate host of *Fasciola hepatica*. *Preventive Veterinary Medicine*, **11**, 221–227

# Index

---

- A**  
Abattoirs, as sources of data, 174  
Abomasal bloat, 478  
Abomasal mucosal hyperplasia, 39  
Abortive reaction, in infections, 85  
Abuse (non-accidental injury),  
  animal, 19, 190, 463  
  child, 19  
  sexual, 19  
Accredited herd schemes, 378  
Accuracy,  
  definition, 159, 407  
  diagnostic, *see* Area under the curve  
  of serological tests, 312–313  
Actinobacillosis, 23, 41  
*Actinobacillus lignieresii*, *see* Actinobacillosis  
Action levels,  
  in control charts, 225  
  in health and productivity schemes, 370  
Active data collection, 170–171, 179, 205, 396  
Active surveillance, *see* Surveillance  
Adjusted (standardized) measures of disease occurrence,  
  for age, 64  
  calculation, 63–64  
  confidence interval, 223  
  for lifespan, 332, 334–336  
*Aedes* spp., 131  
Aetiological fraction, *see* Attributable proportion  
African horse sickness, 83, 388  
African swine fever, 47, 104, 106, 229, 313  
*Age of Enlightenment*, *see* 'Enlightenment, The'  
Age,  
  comparison of human and animal, 334–336  
  as a determinant, 79  
Age-specific rates, 61, 336  
Agreement,  
  of diagnostic tests, 160, 327–328  
  method of, 43  
Agricultural organizations, as sources of data, 176  
Aggregate-level testing, 323  
AIDS, 28, 106  
  as a population regulator, 121  
ALOHA model, 108  
ANADIS, 208  
Anaemia, 111  
Analogy, method of, 44  
Analytical epidemiology, 25  
Anaplasmosis, 470  
Animacula, 4  
Animal abuse, *see* Abuse  
Animal plagues,  
  as current problems, 11  
  dates of occurrence, 6–7  
Animal Productivity and Health Information Network, *see* APHIN  
Animal rights, 19  
Animal welfare, 19–20  
Animals, domestication, 1–2  
Animal-cemetery records, 50  
Animal-time at risk, 54  
Animism, 2  
ANIMO, 172  
Anthrax,  
  in cattle in England, 66  
  as a plague, 4, 6  
Anthropology, knowledge of, in disease control, 397  
Anthropurgic ecosystems, 130  
Antibodies, 407  
  blocking, 313  
  comparison of levels, 309–311  
  half-life, 308  
  methods of expressing amounts of, 306–308  
  prevalence, 308–309  
  *see also* Serological epidemiology  
Antigenic variation, 82–85  
Antigens, 407  
APHIN, 208, 209–210  
Apsyrtus, 5  
Aquinas, St Thomas, 34  
Arabian medicine, 5  
Area incidence ratio, 62  
Area under the curve, 322  
Argument from caprice, 41  
Aristotle, 34  
Arithmetic mean titre, 306  
'Armchair epidemiology', 27, 28  
ARPANET, 203  
Arthropods, transmission of infection in, 100, 101  
Asbestos, as a carcinogen, 333  
Association, 38–40, 407  
  demonstrating, 247–265  
  non-statistical, 38  
  statistical, 38–40  
  types of, 38–40  
  *see also* Observational studies; Sampling; Statistics  
Asymptotic (large sample) methods, 220  
Atrophic rhinitis, 93, 327–328, 476  
Attack rate, 56  
Attested herd schemes, *see* Accredited herd schemes  
Attributable proportion, 273–274  
Attributable rate, *see* Attributable risk  
Attributable risk, 272–273



- AUC, *see* Area under the curve  
 Aujeszky's disease,  
   airborne transmission, 109  
   determinants, 476  
 Aurochs, 2  
 Australia,  
   control of screw-worm fly in,  
     365–366  
   fascioliasis in, 68  
 Australian National Animal Disease  
   Information System, *see*  
   ANADIS  
 Authority, role of, in accepting a  
   hypothesis, 36  
 Autochthonous ecosystems, 130  
 Ayurvedic medicine, 4
- B**  
*Babesia* spp., 81, 158  
 Badgers,  
   density of setts, 67  
   mortality in, 463  
   tuberculosis, 14, 343  
 Balance of nature, 120  
   disease control and, 397  
 Bar charts, 65  
 Basic reproductive number (basic  
   reproduction ratio, basic  
   reproductive rate), 138, 354  
 Bates, Thomas, 5  
 Bats, rabies in, 39  
 Bayes, Thomas, *see* Bayesian inference  
 Bayesian inference, 35, 248  
 Beef cattle, health and productivity  
   schemes, 375–378  
 Behaviour,  
   as a determinant, 80, 103  
 Beijerinck, Martinus, 4  
 Benefit:cost ratio, 365, 370  
 Bernoulli,  
   Daniel, 10, 340  
   Jakob, 10  
 Beta-pert distribution, 316  
 Bhutan, Kingdom of, sampling in, 231  
 Bias,  
   confounding, 40, 160, 277–280  
   definition, 160  
   'diplomatic', 186  
   dry-season, 186  
   interviewer, 160, 194  
   measurement, 160  
   misclassification, 160, 276–277, 278  
   person, 186  
   project, 186  
   publication, 301  
   selection, 160, 276  
   spatial, 186  
   spectrum, 317  
   *see also* Observational studies  
 Bills of Mortality, *see* Graunt, John  
 Binomial distribution, 218
- Biocenosis, 130  
 Biological markers, 27  
 Biomes, 117–120  
*Biomphalaria glabrata*, 124  
 Biosecurity, 389, 399, 407  
 Biotopes, 130  
 Birds, psittacine, preventive medicine  
   in, 379  
 Birth rates, 62  
 Black Death, 47, 121  
 Bladder cancer,  
   in dogs, 333, 465  
   in humans, 333  
 'Blanket' slaughter (culling), 386  
 Blinding, in clinical trials, 294–295  
 Blocking antibodies, 313  
 Blood flukes, 104  
 'Blood splashing', 24  
 Blowfly strike, 476  
 Bluetongue,  
   eradication, 385  
   transmission, 100, 110  
 Bone sarcoma, 465  
*Boophilus microplus*, 81  
 Bootstrap estimates, 223–224  
*Bordetella* spp., 83, 466  
 Borna disease, 464  
 Bovine ephemeral fever virus, 100  
 Bovine hypomagnesaemia, 42, 472  
 Bovine petechial fever, 44  
 Bovine spongiform encephalopathy,  
   12, 16, 31, 43, 262, 471  
 Bovine tuberculosis, 14  
   role of badgers, 14, 46, 343, 475  
 Bovine virus diarrhoea,  
   control, 330, 378, 398  
   determinants, 471  
   latent infection, 87  
 'Box and whisker' plots, 224  
 Breast cancer, *see* Tumours, mammary  
 Breed societies, as sources of data, 177  
 Breslow–Day test for homogeneity,  
   280  
 Browser, computer software, 203  
*Brucella abortus*, transmission, 99, 103  
*Brucella suis*, 177  
 Brucellosis,  
   control and eradication, 378, 398  
   determinants of, 471  
   genetic resistance, 391  
   screening tests, 317–318  
 BSE, *see* Bovine spongiform  
   encephalopathy  
 Buddhist medicine, 4  
 Budgerigars, goitre in, 61  
 Bumblefoot, *see* Pododermatitis
- C**  
 Caesarian section, 471  
 Calculus, differential, models using,  
   341–345
- California Animal Neoplasm  
   Registry, 332  
 Calorific energy flow, 129  
*Campylobacter* spp., 18, 471, 477  
 Cancer,  
   animal models, 332–336  
   cause, 95–97  
   induction, 95–96  
   initiation by viruses, 96  
   specific cancers, *see* Tumours  
 Cancer eye, 24  
*Candidatus* spp., 464  
 Candidate genes, 390  
 Canine distemper, 35, 75, 98, 107, 131,  
   158, 386  
 Canine infectious tracheobronchitis,  
   285–288, 466  
 Canine parvovirus infection, sentinels  
   for, 170  
 Capture–release–recapture sampling,  
   population enumeration by,  
   50–52  
 Carbon monoxide poisoning, 43  
 Carcinogenesis, 96  
 Carcinogens, 96  
 Carriers,  
   convalescent, 86  
   of foot-and-mouth disease, 86  
   incubatory, 86  
 Case fatality, 58  
 Case–control studies, *see*  
   Observational studies  
 Caseous lymphadenitis, 478  
 Casuistry, 34  
 Cats,  
   blood pressure, 464  
   coat colour,  
     skin cancer, 82  
   conjunctivitis, 38  
   diarrhoea, 464  
   dysautonomia, 464  
   dystokia, 464  
   fibrosarcoma, 464  
   health schemes, 379  
   hyperthyroidism, 464  
   infectious anaemia, 464  
   leukaemia, 464  
   observational studies in, 463–464  
   panleucopenia, 110, 145  
   road traffic accidents, 464  
   urological syndrome/urolithiasis,  
     94, 275–276, 464  
   *see also* specific diseases of cats  
 Cattle cultures, 2  
 Cattle Health Scheme (UK), 379  
 Cattle,  
   abortion, 470  
   anaplasmosis, 110  
   anthrax, 4, 6, 66  
   beef, health and productivity  
     schemes, 375–378

- Cattle (*cont'd*)  
 bluetongue, 100, 110, 385  
 bovine virus diarrhoea virus, 87,  
 330, 378, 398, 471  
 copper deficiency, 65  
*Cryptosporidium* infection, 471  
 dairy, health and productivity  
 schemes, 370–372  
 disease eradication in, 392  
 displaced abomasum, 471  
 dystokia, 472  
 enzootic bovine leucosis, 277  
 ephemeral fever virus, 100  
 foot-and-mouth disease, 36, 48–49,  
 72, 240, 386, 393  
*Haemonchus contortus* infection, 39  
 hypomagnesaemia, 42, 145, 472  
 infertility, 472  
 Johne's disease, 242, 330, 472  
 keratoconjunctivitis, 104  
 ketosis, 472  
 Kikuyu grass poisoning, 44  
 lameness, 473  
 laminitis, 473  
 leptospirosis, 473  
 leucosis, 54  
 malignant catarrhal fever, 24, 184  
 mannosidosis, 391  
 mastitis,  
 control, 361–363, 371, 389  
 determinants, 473  
 metabolic profiles, 372  
 metritis, 474  
 milk fever, *see* parturient paresis  
 observational studies in, 470–476  
 optimum feeding, 372  
 paratuberculosis, *see* Johne's  
 disease  
 parturient paresis, 474  
 petechial fever, 44  
 protoporphyria, 391  
 pruritus, pyrexia, haemorrhagic  
 syndrome, 474  
 respiratory disease, 475  
 retained placenta, 475  
 rhinotracheitis virus, 89  
 size of herds, 52  
 squamous cell carcinoma of the eye,  
 24, 43, 61  
 Texas fever, 384  
 ticks, 111, 134  
 trypanosomiasis,  
 determinants, 475  
 eradication, 384  
 tolerance, 391  
 tuberculosis, 475  
 uterine prolapse, 476  
 winter dysentery, 476  
 world productivity, 15  
*see also* specific diseases of cattle  
 Cauda equina syndrome, 465
- Causal hypotheses, formulation,  
 42–45  
 Causal inference, 35–36  
 Causal models, 40–42  
 Causal reasoning,  
 in comparative studies, 338–339  
 method of agreement, 43  
 method of analogy, 44  
 method of concomitant variation,  
 43–44  
 method of difference, 43  
 Causal theories, 34–35  
 Causality, 34–45  
 Cause of disease, 2–4, 37–38  
 Cause(s),  
 direct, 39  
 efficient, 34  
 final, 34  
 formal, 34  
 indirect, 39  
 material, 34  
 necessary, 41  
 sufficient, 40  
 Censoring, 58  
 Censuses, 28, 53, 228  
 Centiles, 216  
 Certification schemes, as sources of  
 data, 177  
 Chain-binomial models, 140  
 Check digits, 167  
 Chemodectomas, 465  
 Chemotherapy, therapeutic and  
 prophylactic, 387  
 CHESS, 208, 369  
 Chile, rabies in, 150  
 Chiron, 2  
 Chi-squared ( $\chi^2$ ) distribution, 431  
 Chi-squared ( $\chi^2$ ) test, 258–259  
 Chi-squared ( $\chi^2$ ) test for trend,  
 261–263  
 Chlamydiosis, 172  
 Chlorinated hydrocarbon poisoning,  
 in foxes, 47  
 Cholera, 9, 44, 338, 356  
 Choroplethic maps, 69  
 Chromosomal disorders, 78  
 Chronic disease epidemiology, 28  
 Chronic pulmonary disease, 337  
 Chrysoloras, Manuel, 34  
*Chrysomia bezziana*,  
 control, cost–benefit analysis of,  
 365–366  
 spread, 106  
 Classification, of disease, 156–157  
 Climate,  
 change, 89  
 classification, 88–90  
 as a determinant, 88–90  
 effects, 117–118  
 importance, 116  
 population dispersal and, 121
- Clinical epidemiology, 26  
 Clinical infection, 85–86  
 Clinical trials, 289–304  
 categories, 289–290  
 community, 291  
 confirmatory, 291  
 definition, 289  
 efficacy, 292–293  
 equivalence, 291  
 exploratory, 291  
 open, 290  
 open label, 295  
 meta-analysis, 300–304  
 multicentre, 291  
 non-inferiority, 291  
 protocol, 292  
 randomized controlled, 290–299  
 admission criteria, 294  
 blinding, 294–295  
 compliance, 298–299  
 exclusion criteria, 294  
 experimental population, 294  
 experimental unit, 293–294  
 follow-up, 298  
 primary hypothesis, 291–292  
 protocol, 292  
 randomization, 295–296  
 block, 295  
 simple, 295  
 sample size determination,  
 297–298  
 stratification, 295  
 superiority, 291  
 termination, 299  
 types,  
 cross-over, 296  
 factorial, 297  
 parallel group (standard), 296  
 sequential, 296–297  
 uncontrolled, 290
- Coat colour, disease and, 82  
 Co-carcinogens, 96  
 Coccidioidomycosis, 118, 119  
 Coccidiosis, 478  
*Code of Hammurabi*, 172  
 Codes, *see* Data, codes and coding;  
 Questionnaires  
 Cohort studies, *see* Observational  
 studies  
 Coitus, infection via, 106  
 Colic, 468  
 Colisepticaemia, 93  
 Colorado tick fever, 102  
 Commensals, 408  
 Commercial livestock enterprises, as  
 sources of data, 176  
 Companion animal medicine, future  
 of, 402  
 Companion animals,  
 demographic studies, 51  
 health schemes, 379–383

- Comparative epidemiology, 28, 331–339
- Comparison of groups, 247–265  
three or more samples, 250, 251  
two samples,  
means, 252–254  
medians, 254–258  
proportions, 258–262  
*see also* Association; Observational studies
- Competition, ecological, 120
- Competitive exclusion, principle of, *see* Interference, epidemiological
- Complete-subject analysis, 196
- Compliance, in clinical trials, 298–299
- Composite measurement scales, 155–156
- Computational epidemiology, 26
- Computers, 198–201
- Computing, changing approaches, 201–204
- Concomitant variation, method of, 43–45
- Concordance, 327
- Confidence interval,  
definition, 220  
of specific parameter, *see*  
appropriate parameter
- Confidence limits, *see* Confidence interval
- Conformation, of hosts, as a determinant, 81–82
- Confounding, 40, 277–280
- Congenital defects, 463
- Conjugation, 82–83
- Connectance (connectivity), of networks, 127
- Conservation medicine, 32
- Constants, 412
- Construct validity, 155, 292
- Contagion, 4
- Contagious bovine pleuropneumonia, 6–7, 11
- Contagious spatial pattern, 150
- Contagium animatum, 4
- Contagium vivum fluidum, 4
- Content validity, *see* Construct validity
- Contiguous populations, 50–52
- Contiguous slaughter (culling), 386
- Control of disease, 384–403  
definition, 384  
economic assessment, 361–367  
strategies, 385–393
- Convenience sampling, 230
- Convergent evolution, 117
- Copper deficiency, 65
- Copper poisoning, chronic, 400–401
- Correlation, 263–264  
coefficient, 452
- Cost:benefit ratio, *see* Benefit:cost ratio
- Cost–benefit analysis, *see* Economics of disease, social cost–benefit analysis
- Cowpox, 23
- Coxiella burnetii*, 103, 306
- Critical knowledge, 35
- Cross-over trials, 296
- Cross-reactions, 312
- Cross-sectional studies, *see* Observational studies
- Cross-sectional surveys, 29
- Cruciate ligament, rupture of, 465
- Crude measures of disease occurrence, 61
- Cryptorchidism, 63, 465
- Cryptosporidium* spp., 18, 471
- Culicoides* spp., 110, 385
- Cullen, William, *see* *Synopsis Nosologiae Methodicae*
- Cumulative incidence, *see* Incidence
- Cumulative mortality, *see* Mortality
- Cusum charts, 226–227
- Cut-off points, in diagnostic tests, 314
- Cyclic neutropenia, *see* Gray collie syndrome
- Cyclical trends in disease, 144–145
- Cystic ovaries, 471
- Cysticercus bovis*, 388
- Cysticercus pisiformis*, 99
- Cysticercus tenuicollis*, 175, 478
- Cytoecetes ondiri*, *see* Bovine petechial fever
- D**
- d’Azyr, Felix Vicq, 10
- Dairy health,  
national schemes, 378–379  
optimum feeding, 372  
private schemes, 370–372
- Dairy herds, metabolic profiles, 372
- DairyCHAMP, 208
- DairyORACLE, 210
- DAISY, 208, 210
- Dampening-down (suppressive) vaccination, 386
- Dangerous contacts, in infectious disease outbreaks, 399
- Danish swine slaughter inspection data bank, 208
- Darwin, Charles, 116, 123
- Data,  
accuracy, 159, 312–313  
diagnostic, 322  
case-specific, 196  
categorical, 152  
classification, 152–156  
codes and coding, 161–167  
alpha, 163  
alphanumeric, 164–165  
check digits, 167
- choice, 165–166
- components, 162
- consecutive, 162–163
- consistency, 166
- error detection, 166–167
- ‘finger trouble’, 166–167
- hierarchic, 162–163
- numeric, 162–163
- structure, 162
- symbols, 165
- collection,  
co-operation, 171–172  
cost, 172  
traceability, 172–173
- definition of, 152
- interpretative, 158
- measurements, 153–156  
bias, 160–161  
composite, 155–156  
continuous, 152–153  
discrete, 152–153  
interval, 153  
nominal, 153  
ordinal, 154  
ratio, 153  
visual analogue, 153–155
- numerical presentation, 214–227
- observational, 158
- record-specific, 196
- sources, 173–179
- quality, 174, 195–196
- Databases,  
approach to data storage, 201–203  
database management systems, 202  
definition, 196  
examples, 207–213  
macroscale systems, 205  
mesoscale systems, 205  
microscale systems, 204  
models of,  
hierarchic model, 196–197  
network model, 197  
record model, 196  
relational model, 197
- Day books, as sources of data, 197
- DBMS, *see* Databases, database management systems
- DCS, 211–213
- de Candole, Alphonse Pyrame, 117
- de Lacrois, Francois Bossier, *see* *Nosologia Methodica*
- Death rate, 58
- Decision boundaries, in control charts, 225
- Decision support systems, *see* Recording schemes
- Deduction, 35
- Deer,  
Health Scheme (UK), 378  
population-size determination, 52
- Degrees of freedom, 220

- Delphi conference, 355
- Demographic base maps, 67
- Demographic studies, in dogs and cats, 51
- Demography, 49
- De Moivre, Abraham, 340
- Demonic theory of disease, 2–3
- Density curve, 217
- Density function, 217
- Density models, 341
- Dermacentor andersoni*, 102
- Dermatitis interdigitalis, *see* Interdigital dermatitis
- Dermatophilosis, 81
- Dermatophytosis, 463
- Descartes, René, 35
- Descriptive epidemiology, 25
- Design effect, 245
- Determinants of disease, 75–97
  - age, 79
  - associated with host, agent and environment, 75–76
  - biological interaction, 93–94
  - breed, 80–81
  - classification, 75–77
  - climate,
    - macroclimate, 88–90
    - microclimate, 90
  - coat colour, 82
  - diet, 91
  - environment, 88–92
    - improvement of, in disease control, 389
  - genetic,
    - in agents, 82–84
    - in hosts, 80
  - global warming, 89
  - hormonal, 79–80
  - host, 78–82
  - housing, 90
  - husbandry, 90–91
  - interaction between, 92–97
  - intrinsic and extrinsic, 75
  - location, 88
  - management, 91
  - microbial colonization of host, 87–88
  - observational studies of, 463–479
    - 'occupational', 91
  - primary and secondary, 75
  - sex, 79–80
  - size and conformation, 81–82
  - social and ethological, 80
  - species, 80–81
  - statistical interaction, 94–95
  - stress, 91–92
- Deterministic models, 341
- Diabetes mellitus, 464
- Diagnosis,
  - bias, 160–161
  - criteria, 157–158
- diagnostic tests,
  - accuracy, 312–313, 322
  - aggregate- (herd-) level, 323
  - agreement between, 327–328
  - area under the curve, 322
  - in import risk assessment, 325–326
  - interpretation, serological, 311–313
  - likelihood ratios, 318–321
  - multiple testing,
    - negative-herd retesting, 325
    - parallel testing, 323–324
    - serial testing, 324–325
  - positive and negative results, 312–313
  - predictive value, 316–318
    - confidence intervals for, 317
  - reliability, 160, 195, 328–329
  - repeatability, 160, 329
  - reproducibility, 329
  - ROC curves, 321–323
  - sensitivity and specificity, 313–316
    - confidence intervals for, 315–316
    - relationship between, 314
  - validity of technique, 313–316
    - guidelines for establishing, 327
  - Youden's index, 31
    - confidence intervals for, 316
    - performance related, 17
- Dictyocaulus viviparus*, 402
- Diet, as a determinant, 91
- Difference, method of, 43
- Digital haemorrhages, 471
- Digitising tablet, 70, 199
- Dinka, 2
- Diphyllbothrium* spp., 99
- Direct adjustment, *see* Adjusted (standardized) measures of disease occurrence
- Discounting, 364–365
- Disease,
  - adjusted (standardized) measures, 63–64
  - animals' niches relating to, 124–126
  - assessment of cost, 361–367
  - cause(s),
    - causal associations, 38–40
      - see also* Association
    - causal postulates, 37–38
  - changing concepts, 2–4
  - direct, 39–40
  - enabling factors, 41
  - Evans' rules, 37–38
  - formulating hypotheses, 42–45
  - indirect, 39–40
  - Koch's postulates, 37
  - models, 40–42
  - necessary, 41
  - non-statistical association, 38
    - place and, 42–43
    - precipitating factors, 41
    - predisposing factors, 41
    - reinforcing factors, 41
    - risk factors, 39
    - risk indicators, 39
    - risk markers, 39
    - statistical association, 38–40
    - sufficient, 40
  - classification, 156–157
  - control, 25, 384–402
    - balance of nature and, 397
    - biological vectors, 388
    - biosecurity, 389
    - cause, maintenance and transmission and, 394
    - chemotherapy, 387
    - compensation and, 397
    - cost–benefit analysis, 363–367
    - definitions, 384
    - diagnosis and, 395
    - ecological consequences, 397
    - environment, husbandry and feeding, 389
    - factors in, 393–398
    - finance of, 397–398
    - fomites, disinfection of, 388
    - genetic improvement, 389
    - grazing, 388
    - host–parasite relationship in, 395
    - host range in, 394
    - legislation, 397
    - minimal disease methods, 392
    - movement of hosts, 387–388
    - niche filling, 389
    - planning and monitoring, 25
    - producers' opinion, 396
    - public health considerations, 397
    - public opinion, 396–397
    - quarantine, 385
    - replacement stock in, 396
    - selecting campaigns,
      - economic criteria, 361–363
      - technical criteria, 398
    - slaughtering, 385, 392–393
    - strategies, 385–393
    - surveillance, 396
    - uncertainty in, 365
    - vaccination, 386–387, 392–393
    - veterinary infrastructure and, 395
  - determinants of, *see* Determinants of disease
  - diagnosis, 157–158, 311–327
  - ecology, *see* Ecology
  - economics of, *see* Economics
  - eradication, 384–385
    - see also* Disease, control of
  - multifactorial, 16, 37, 40–42, 75–77, 92–97
  - natural history, 24, 121–135

- Disease (*cont'd*)  
 nomenclature, 156–157  
 non-infectious, 15  
 occurrence,  
   describing, 46–73  
   measures of, 53–65  
 patterns of, 137–151  
 population regulation by, 121–122  
 reporting, *see* Databases, examples  
   of; Monitoring, Surveillance  
 seasonal trends, 144–145  
 serological diagnosis, 305–313  
 spatial distribution, 65–72, 150–151  
 temporal distribution, 53–65  
 temporal trends,  
   detection, 144–150, 225–227  
   regression analysis, 148–150  
   rolling (moving) averages,  
     147–148  
   time-space clustering, 151  
   of unknown origin, 15–16
- Disinfection, 112, 388
- Dispersal, 121
- Displaced abomasum, 471
- Dissemination rate, 138
- Distance sampling, *see* Sampling
- Distemper, *see* Canine distemper
- Distribution maps, 68–69
- Divination, 3
- Divine cause of disease, 3
- 'Doctrine of Signatures', 3
- Dogs,  
 age conversion to human age  
   equivalent, 334–336  
 aggression, 464  
 bartonellosis, 464  
 bronchiectasis, 465  
 cauda equina syndrome, 465  
 cryptorchidism, 63, 464  
 cyclic neutropenia, 389  
 deafness, 82, 465  
 domestication, 2  
 dysautonomia, 465  
 epilepsy and epileptiform seizures,  
   339  
 gastro-intestinal ulceration, 465  
 glaucoma, 465  
 haemophilia, 80  
 health schemes, 379–380  
 heart disease, 81, 465  
 heartworm, 68, 119, 466  
 hip dysplasia, 466  
 hypospadias, 466  
 intervertebral disc disease, 466  
 leptospirosis, 466  
 lung disease, 333, 337, 466  
 mammary tumours, 334, 466  
 mastocytomas, 466  
 observational studies in, 464–467  
 oral tumours, 466  
 osteochondritis dissecans, 466  
 pancreatitis, 466  
 parvovirus infection, 47, 81, 466  
 progressive retinal atrophy, 390,  
   467  
 prostatic hyperplasia, 467  
 pyometra, 283, 467  
 testicular neoplasia, 467  
 urinary incontinence, 259, 467  
 urolithiasis, 467  
*see also* specific diseases of dogs
- Domesday survey, livestock census  
 in, 53
- Domestic animals,  
 demography, 49–53  
 domestication, 1–2
- Drift, antigenic,  
 in influenza viruses, 83  
 in trypanosomes, 83
- Droplet,  
 expiratory, 105  
 nuclei, 107
- Ductus diverticulum, 336–337
- Dysautonomia,  
 canine, 464  
 feline, 15, 156, 464
- Dystokia,  
 cats, 464  
 cows, 472
- E**
- Echinococcosis, 396
- Echinococcus granulosus*, 128
- Eclipse phase, 101
- Ecological climax, 131
- Ecological fallacy, 269
- Ecological health, 32
- Ecological interfaces, 131
- Ecological mosaics, 131–132
- Ecological studies, 269
- Ecology,  
 consequences of disease control on,  
   397  
 definition, 116  
 of disease, 24
- Econometrics, 357
- Economics of disease, 357–367  
 assessment of cost, 361–363  
 nature of decisions, 357–358  
 partial farm budgets, 363–364  
 social cost-benefit analysis,  
   364–367  
   benefit:cost ratio, 365  
   criteria for selecting a control  
     campaign, 365  
   in dairy herd health schemes,  
     370  
   discounting, 364–365  
   example, 365–366  
   internal and external costs and  
     benefits, 364  
   internal rate of return, 365  
   net present value, 365  
   principles, 364  
   problems, 366–367  
   shadow prices, 365
- Ecosystems, 24, 130–132  
 anthropurgic, 130  
 autochthonous, 130  
 definition, 130  
 synanthropic, 130
- Ectopic ureter, 465
- Ectromelia, 26
- Effect size, 302
- Effective contact, 102–103
- Effectiveness, in clinical trials, 289
- Efficacy, in clinical trials, 289, 292–293
- Efficiency frontier, 361
- Effusions, pleural and peritoneal, 463
- Einstein, Albert, 354
- Elbow,  
 arthritis, 465  
 dysplasia, 465
- Elementary unit, 229
- Elimination of disease, 385
- El Niño, 89
- Elton, Charles, *see* Pyramid of  
 numbers
- Embryo, transmission of infection to,  
 110
- Emergency vaccination, 386
- Emergent/emerging diseases, 11, 12,  
 13, 133, 134
- Empirical models, 345–346
- Employment of veterinarians, 17
- Enabling factors, 41
- Endemic disease occurrence, 46
- Endemic pulsations, 144
- Endogenous determinants, *see*  
 Intrinsic determinants
- Endogenous pathogens, 88
- Endometritis, 472
- '*Enlightenment, The*', 10, 35
- Enteric disease, 92
- Entropion, congenital, 478
- Environment,  
 as a determinant, 88–92  
 importance of, 16, 37
- Environmental epidemiology, 28
- Environmental mastitis, 76
- Environmental resistance, 120
- Enzootic bovine leucosis, 54, 106, 177,  
 277, 385
- Enzootic pneumonia, 272, 476
- Epidemics,  
 common source, 139–140  
 definition, 22, 46–47  
 epidemic curves, 137–144  
 epidemic disease occurrence, 46–47  
 epidemic waves, 142–144  
 point source, 130  
 propagating, 139–140  
 Reed-Frost model, 140–142

- 'Epidemiologic' versus  
'epidemiological', 22
- Epidemiological interference, *see*  
Interference, epidemiological
- Epidemiological investigation, types  
of, 25–28
- Epidemiological rates, 61–64
- Epidemiological ratios, 62, 333
- Epidemiological unit, 229
- Epidemiology,  
analytical, 25  
'armchair', 27  
chronic disease, 28  
clinical, 26  
comparative, 331–339  
components, 28–32  
computational, 26  
definitions, 22–23  
descriptive, 25  
environmental, 28  
experimental, 25–26  
field, 27  
genetic, 26  
macro-, 28  
micro-, 28  
molecular, 27–28  
nutritional, 28  
participatory, 27, 179–186  
psychosocial, 28  
qualitative, 28  
quantitative, 28–32  
role, 1, 33  
scope, 22–33  
'shoe-leather', 27  
social, 28  
subclinical, 28  
theoretical, 26  
types, 25–28  
uses, 23–25
- Epileptiform seizures, 339
- EpiMAN, 210–211
- Epistemology, 34
- Epizootics, 22
- Epizootiology, 22
- Epornitics, 22
- Equine influenza,  
antigenic types, 311  
as a plague, 6–7
- Equine motor neuron disease, 150,  
469
- Equine parasitic mange, 8
- Eradication of disease, *see also* Disease,  
control of  
definition, 384  
early examples, 8  
strategies, 385–393
- Error detection, in coding, 166–167
- Escherichia coli*, 16, 18, 81, 93, 158, 387,  
472
- Estimated dissemination rate, 139
- Ethnoveterinary medicine, 27
- European Union,  
rabies control in, 385  
trade and, 20, 357
- Evans, Alfred, *see* Evans' rules
- Evans' rules, 37–38
- Evasion, of disease, 3
- Evidence-based medicine, 26
- Evolution, convergent, 117
- Exogenous determinants, *see* extrinsic  
determinants
- Exogenous pathogens, 88
- Exorcism, 3
- Experiential analysis, 35
- Experimental (induced) models, 331,  
332
- Experimental epidemiology, 25–26
- Experimental science, versus  
observational science, 31
- Expert systems, 26, 211
- Exponential decay, models of, 341, 345
- Exponential function, 412
- External costs and benefits  
(externalities), 364
- External validity, 294
- Extrinsic determinants, 75
- Extrinsic incubation period, 101
- F**
- Factorial-design trials, 297
- Factorials, 413
- Faecal–oral transmission cycle, 103
- FAIDS, 28
- Farming, spread of in Europe, 2
- Farms,  
hygiene, 76  
profiles, 369  
records, as sources of data, 176–177
- Farr, William, 10, 168, 340
- Fasciola hepatica*, *see* Fascioliasis
- Fascioliasis,  
in Australia, 68–70  
control, 388  
models, 346
- Feather picking, 478
- Feline dysautonomia, 15, 156, 464
- Feline leukaemia,  
determinants, 464  
latent infection, 87  
spatial clustering, 150
- Feline panleucopenia, seasonal  
variation in, 145
- Feline urolithiasis, *see* Feline  
urological syndrome
- Feline urological syndrome, 30,  
275–276, 464
- Feral animal organizations, as sources  
of data, 177
- Ferret, preventive medicine in, 379
- Fertex* index, 371
- Fertility rates, 62
- Fetal death rate, 62
- Fetal death ratio, 62
- Fibrosarcoma, 464
- Field epidemiology, 27, 399
- Field trials, *see* Clinical trials
- File Transfer Protocol, *see* FTP
- Finagle's Laws, 206
- 'Finger trouble', 166
- 'Fingerprinting', nucleic acid, 27
- 'Fire-brigade' treatment, 17, 368
- Fisher's exact test, 259–260
- Fitzherbert, John, 5
- Fixed-effects model, in clinical trials,  
302
- Five-point summary, 217
- Fleas, host–parasite relationships, 114
- Fluke, life-cycle of, 129  
*see also* Fascioliasis
- Fomites,  
definition, 100  
disinfection, 112, 388
- Food chains,  
definition, 127  
relationship between predator and  
prey, 129–130  
trophic levels, 127
- Food, competition for, 120
- Food poisoning, 42, 140
- Food quality, 18–19
- Food webs, 127–128  
animal size and, 127
- Foot-and-mouth disease,  
airborne spread, 107–109  
carrier state, 86–87  
cyclical trend in, 149  
determinants, 472  
epidemics in the UK, 12, 48  
eradication, 385  
neighbourhood analysis, 71  
nucleotide sequencing, 27, 84–85  
outbreaks,  
definition of, 49  
in the UK, 12, 48  
in Paraguay, 149  
as a plague, 6–7  
post-epidemic serosurveillance, 72,  
240  
serotypes, 84  
survival, 103, 112  
topotypes, 84  
vaccination, 386, 393
- Foot rot, 93, 292–293, 478
- Forecasting systems, for fluke, 346
- Foxes,  
chlorinated hydrocarbon poisoning  
in, 47  
movement of, 123  
rabies in, 123, 132, 137, 343–344
- Fracastorius, Hieronymous  
(Fracastoro, Girolamo), 4
- Free-roaming populations, 50
- Frequency polygon, 215

- Frequentist statistics, 248  
 Friedrich William, King of Prussia, 172  
 Frosch, Paul, 4  
 FTP, 203  
 Fucosidosis, 391  
 FUS, *see* Feline urological syndrome
- G**
- Galen, Claudius, 4  
 Galileo, (Galilei, Galileo), 35  
 Gastroenteritis, of pigs, 145  
 Gause, Georgyi Frantsevitch, 120, 123  
 Gaussian plume model, 108  
 General adaptation syndrome, *see* Stress  
 Generality, of a theory, 354  
 Generation time, 101  
 Genes, role of in disease pathogenesis, 27  
 Gene-modified models, 331  
 Genetic determinants, in the host, 78–80  
 in infectious agents, 82–84  
 Genetic diseases, animal models of, 336–337  
 Genetic epidemiology, 26  
 Genetic improvement, in disease control, 389–392  
 selective breeding, 391  
 transgenic biology, 391  
 Genetic reassortment, 83  
 Genetic screening, 389–392  
 candidate genes, 390  
 linked markers, 390  
 Genotype, *see* Genetic determinants  
 Geographic base maps, 67–69  
 Geographical information systems, 69–73  
 Geometric mean titre, 306  
 Gill disease, bacterial, in trout, 479  
 GIS, *see* Geographical information systems  
 Glanders, 8, 384  
 Global surveillance, *see* Surveillance  
 Global warming, as a determinant, 89  
 Goats, domestication of, 2  
 Goitre, 61  
 ‘Gold standard’, in diagnostic tests, 315  
 Gompertz’s Law, 335  
 Government veterinary organizations, as sources of data, 173  
 Grass sickness, 15, 24, 468  
 Graunt, John, 10, 340  
 Gray collie syndrome, 389  
 Grazing, and disease control, 388  
 Grebes, parasites in, 126
- Greek medicine, 3–4, 402  
 ‘Greenhouse effect’, *see* Global warming  
 Gross margin analysis, 363  
 Group (herd) effects, in clinical trials, 293  
 Group behaviour, of animals, 122–123
- H**
- Haeckel, Ernst, 116  
 Haemangioma/haemangiosarcoma, 465  
*Haemaphysalis spinigera*, 134  
*Haemobartonella* spp., *see* *Candidatus* spp.  
*Haemonchus contortus*, 39  
 Haemophilia, 80  
 Half-life, of antibodies, 308  
 Halley, Edmund, 10  
 Hardware, computer, 198–200  
 Hares, *Brucella suis* from, 177  
 observational studies in, 468  
 Haygarth, John, 290  
 Healers, primitive, 2  
*Healex* index, 368  
 Health, definition, 19  
 ecological, 32  
 Health schemes, companion animals, birds, 379  
 cats, 379, 381  
 dogs, 379, 380  
 ferrets, 379  
 horses, 379, 382  
 rabbits, 379  
 national schemes, accredited/attested herds, 378  
 health schemes, 378–379  
 private health and productivity schemes, action level, 370  
 components, 369  
 beef cattle, 375–378  
 dairy cattle, 370–372  
 interference level, *see* action level  
 pigs, 372–373  
 sheep, 373–375  
 justification, 370  
 objectives, 368–369  
 structure, 368–370  
 targets, 369–370  
 Heart disease, in dogs, 81, 465  
 Heartwater, risk of introduction into the US, 107  
 Heartworm, 68, 119, 466  
 Hefts, as epidemiological units, 229  
 Hekistotherms, 117
- Helminthiasis, in dogs, 397  
 environment and, 24  
 vaccines against, 302  
 Henle–Koch postulates, *see* Koch’s postulates  
 Hepatitis B, 84  
 Herd effects, *see* Group effects  
 Herd-level testing, *see* Aggregate-level testing  
 Hernias, umbilical and inguinal, 463  
 Herpesvirus, causing malignant catarrhal fever, 24  
 Hierarchic codes, 162–163  
 Hill, Austin Bradford, *see* Hill’s criteria  
 Hill’s criteria, 44–45  
 Hip dysplasia, 466  
 Hippocrates of Cos, 4, 402  
 Histograms, 215  
 Homeopathic remedies, assessment of, 289  
 Home range, 122  
 Homeopathic remedies, assessment of, 289  
 Hookworm, 104  
 Horizontal transmission, 98–110  
 Hormonal determinants, 79–80  
 Horse cultures, 2  
 Horses, abortion, 468  
 azoturia, 468  
 basal sesamoidean fractures, 468  
 behavioural disorders, 468  
 bone spavin, 468  
 colic, 468  
 cryptorchidism, 468  
 endometrial disease, 468  
 ehrlichiosis, 468  
 endoparasitism, 468  
 epiglottitis, 468  
 grass sickness, 15, 24, 468  
 health programmes, 379, 382  
 influenza, 469  
 lameness, 469  
 laminitis, 469  
 motor neuron disease, 150–151, 469  
 navicular disease, 469  
 observational studies in, 468–470  
 osteochondrosis, 469  
 racing injuries and performance, 470  
 sarcoids, 470  
 sweet itch, 470  
*see also* specific diseases of horses  
 Host determinants, 78–82  
 Host–parasite relationship, in disease control, 395  
 Host(s), aberrant, *see* secondary accidental, *see* incidental

- Host(s) (*cont' d*)  
 amplifier, 99  
 dead-end, *see* incidental  
 definitive, 99  
 determinants associated with, 78–82  
 environment within, 111  
 final, 99  
 hibernating, 99  
 incidental, 99  
 infectiousness, 100–101  
 intermediate, 99  
 link, 99  
 maintenance, *see* primary  
 microbial colonization, 87–88  
 natural, *see* primary  
 paratenic, 99  
 primary, 99  
 reservoir, 99–100  
 secondary, 99  
 susceptibility, 100
- Housing, as a determinant, *see* Husbandry
- Husbandry
- Hulme, David, 35
- Humoral pathology, 3
- Humours, of the body, 3–4
- Husbandry, as a determinant, 90
- Huxley, Thomas Henry, 36
- Hybridization, nucleic acid, 27
- Hydatids, in cattle in Kuwait, 65
- Hydropericardium syndrome, 478
- Hyperendemic disease, 46
- Hyperkeratosis, 43
- HyperText, 203
- Hyperthyroidism, 464
- Hypocupraemia, 65
- Hypomagnesaemia, 42, 75, 145, 472
- Hypospadias, 337, 466
- Hypotheses,  
 characteristics, 354  
 definition, 35  
 formulation, 42–45  
 statistical testing of,  
 significance tests, 247–248  
 versus estimation, 249–250
- I**
- Identification, of animals, 50, 172
- Immunity, sterile, 86
- Immunization,  
 history of, 8, 340  
 natural, 386–387
- Immunological status, vertical  
 transmission and, 110
- Immunosuppression, as a microbial  
 maintenance strategy, 113
- Inapparent infection, 85
- Incantation, in disease control, 3
- Incidence,  
 cumulative incidence, 53–54  
 confidence interval, 222  
 incidence rate, 54–56  
 confidence interval, 223
- Incubation period, 101
- Index case, 140
- Indirect adjustment, *see* Adjusted  
 measures of disease  
 occurrence
- Induced models, *see* Experimental  
 models
- Induction,  
 of cancer, 95–96  
 in causal inference, 35
- Infection(s),  
 agents, 82–88  
 antigens on, 311  
 biomes affecting, 117–120  
 classification, 88, 121, 341  
 genotypic changes in, 82–85  
 hazards to, 111–112  
 resistant forms, 113  
 basic reproductive number, 138  
 characteristics of pathogens, 102  
 clinical, 85–86  
 effective contact, 102–103  
 emergent/emerging, 11, 12, 13, 133,  
 134  
 extrinsic incubation period, 101  
 generation time, 101  
 gradient of, 85  
 group types, 77  
 host and vector, 99–100  
 host/parasite relationships,  
 114–115, 395  
 inapparent (silent), 85  
 incubation period, 101  
 latent, 87  
 latent period, 101  
 maintenance of,  
 environment in host, 111  
 external environment, 111–112  
 persistence in host, 113–114  
 'rapidly in, rapidly out' strategy,  
 113  
 resistance and, 113  
 strategies, 112–115  
 mixed, 15, 92  
 novel, 13  
 subclinical, 85  
 transmission, 98–111, 123  
 aerosol, *see* aerial  
 aerial, 105  
 ascending, 110  
 biological, 100  
 characteristics of hosts,  
 100–102  
 coitus, 106  
 contact, 105–106  
 cyclopropagative, 100  
 developmental, 100  
 direct, 99  
 droplet nuclei, 107  
 epidemiological interference in,  
 126  
 factors in, 100–103  
 food webs and, 127–128  
 germinative, 110  
 horizontal, 98–110  
 iatrogenic, 106  
 indirect, 99  
 inhalation, *see* aerial transmission  
 ingestion, 105  
 inoculation, 106  
 lateral, *see* horizontal  
 long-distance, 106–110  
 oral route of, 103  
 at parturition, 110  
 percutaneous, 104  
 propagative, 100  
 respiratory route of, 103–104  
 salivarian, 100  
 stercorarian, 100  
 transovarial, 110–111  
 trans-stadial, 110–111  
 vectors, 100  
 vertical, 110–111  
 via skin, cornea and mucous  
 membranes, 104–105  
 vectors, 100  
 virulence, 82–85
- Infectious disease,  
 complex, 14–15, 92–93  
 diagnosis, 305  
 emergent/emerging, 11, 12, 13, 133,  
 134  
 factors in control, 393–398  
 novel, 13  
 as a regulator of populations,  
 131–132  
*see also* Infection
- Infectious keratoconjunctivitis, 89,  
 104
- Infectious salmon anaemia, 478
- Infectiousness, of hosts, 100–102
- Infectivity, of pathogens, 102
- Infertility, 472
- Influenza viruses,  
 classification, 311  
 serological tests, 159  
*see also* Equine influenza
- Informatics, 408
- Information, definition of, 205
- Information systems, *see* Recording  
 schemes
- Inhalation, infection by, *see* Aerial  
 transmission
- Inheritance,  
 Mendelian, 78, 80  
 multifactorial, 78–79  
 polygenic, 78
- Inhibitors, in serological tests, 313
- 'Inner perfection' of a theory, 354
- Inoculation, infection by, 106



- Instrumental knowledge, 35  
Intangibles, in economics, 304  
Interaction, 92–97  
    biological, 93–94, 408  
    statistical, 94–95, 274–276, 408–409  
Interactive knowledge, 35  
Interactive site segregation, 125  
Interdigital dermatitis, 478  
Interference levels, *see* Action levels  
Interference, epidemiological, 126, 389  
Internal costs and benefits (internalities), 364  
Internal rate of return, 365  
Internal time component, 54  
Internal validity, 294  
Internet, 203–204  
    sites relevant to epidemiology, 418–419  
Interval estimation, 220  
    *see also* specific parameters  
Interval scale of measurement, 154  
Intervertebral disc disease, 466  
Interviews, 191, 194–195  
    semi-structured, 184  
Intracellular parasitism, as a microbial maintenance strategy, 125–126  
Intrinsic determinants, 75  
Intuition, role of, in accepting a hypothesis, 36  
Investigation, epidemiological, types of, 25–28  
Isomorphs, 69  
Isomorphs, 69  
Isoplethic maps, 69  
Iwanowsky (Ivanovsky), Dmitri, 3
- J**  
Jaagziekte, 391  
Jaw tumours, in sheep, 65  
Jenner, Edward, 4, 23  
John's disease, 56, 242, 472  
JP15 campaign, 11
- K**  
K88 antigen, 81, 94  
Kaplan–Meier analysis, 60  
Kappa statistic, 327–328  
Kendall's Threshold Theorem, 137  
Kendall's waves, 142–144  
Kennel cough, *see* Canine infectious tracheobronchitis  
Keratoconjunctivitis, bovine, 89, 104  
    superficial, in dogs, 89  
Ketosis, 39, 471  
Key–Gaskell syndrome, *see* Feline dysautonomia  
Kikuyu grass poisoning, 44  
Kilborne, Fred, 4
- Knacker yards, as sources of data, 175  
Knowledge, critical, 35  
    interactive, 35  
    instrumental, 35  
Koch, Robert, *see* Koch's postulates  
Koch's postulates, 37  
Koppen, Waldimir, 117  
Kuhn, Thomas, 4, 36  
Kyanur Forest disease, 134–135
- L**  
Lameness, in cattle, 473  
    in horses, 469  
Laminitis, in cattle, 473  
    in horses, 479  
Lancisi, Giovanni, 4, 394  
Landscape epidemiology, 132–135  
Laplace, Pierre-Simon, 10  
Laryngeal hemiplegia, 469  
Lassa fever, 100, 144  
Latent infection, 87  
Latent period, 101  
Lateral transmission, *see* Horizontal transmission  
Laws, scientific, 354  
Lebeau's method of lifespan adjustment, 335  
Lee waves, 108  
Leibnitz, Gottfried, 5  
*Leptospira* spp., *see* Leptospirosis  
Leptospirosis, in dairy workers, 44  
    determinants, 466, 469, 473, 476  
    epidemic, 140  
    genetic resistance, 391  
    hosts, 24  
    landscape epidemiology, 133  
    seasonal trends, 145  
Leukaemia, in cats, determinants, 464  
    spatial clustering, 150  
*Liber de Wintonia* (*Book of Winchester*), *see* Domesday survey  
Lice, niches of, 124–125  
Life-cycles, of infectious agents, 98  
    evolution of, 128  
Life-table analysis, 58–60  
Life zones, 117–120  
Lifespan adjustment, 334–336  
Likelihood, 409  
Likelihood ratios, 318–319  
Lind, James, 289  
Linked markers, 390  
*Listeria* spp., *see* Listeriosis  
Listeriosis, 77, 478  
Live birth rate, 62
- Livestock, health schemes, national, 378–379  
    private, 368–378  
    population of Great Britain, 14  
    world populations of, 14  
Livestock numbers, 52  
Livestock medicine, future of, 401–402  
Livestock production, as an economic process, 359–360  
Lobb, Thomas, 4  
Loeffler, Friedrich, 4  
Logarithms, 412  
Logistic model, in ecology, 120  
    in observational studies, 284–288  
Lognormal distribution, 219, 303  
Loiasis, 131  
Longevity, studies of, in animals, 60  
Longitudinal studies, 267  
Longitudinal surveys, 29  
Lorenz, Konrad, 32  
Lotka, Alfred, *see* Lotka–Volterra equations  
Lotka–Volterra equations, 123  
Louis, Pierre-Charles-Alexander, 10  
Louping-ill, 56  
Louse infestations, 124–125  
Lucké's frog virus, 123  
Lucretius Carus, Titus, 4  
Lymphocytic choriomeningitis, 110  
Lysosomal storage disease, 391
- M**  
Macroclimate, *see* Climate  
Macro-epidemiology, 28  
Macroparasites, definition, 121  
    mathematical models, 341  
Maedi-visna, control, 394  
    determinants, 478  
Magnesium, deficiency, 42, 75, 145  
    levels, 42, 75, 145  
Malignant catarrhal fever, 24, 184  
Malignant hyperthermia, *see* Porcine stress syndrome  
Management, as a determinant, 91  
*Mannheimia* spp., *see* *Pasteurella* spp.  
Mannosidosis, 391  
Manpower, veterinary, distribution of, 17  
Mantel–Haenszel procedure, 278–280  
Maps, choroplethic, 69  
    demographic base, 67  
    distribution, 68–69  
    geographic base, 67  
    grid-based, 70

- Maps (*cont'd*)  
 isoplethic, 69  
 participatory, 185  
 point (dot or location), 67–68  
 proportional circle, 69  
 proportional sphere, 69  
 raster-based, 70  
 vector-based, 70
- Marek's disease, 478
- Margin of clinical equivalence, 298
- Marginal analysis, 358
- Marisa cornuarietis*, 124
- Mark sense document reader, 198
- Masking, in clinical trials, *see* Blinding
- Mass screening, 29
- Mastitis,  
 control, 371, 389  
 economic study of, 361–363  
 determinants, 473  
 environmental, 76  
 summer, 93
- Mastocytoma, 466
- Mastomys natalensis*, 100
- Matching, 249, 280, 295
- Maternal mortality ratio, 62
- Mathematics, notation and terms,  
 412–413
- Matrices, models using, 349–351
- Matrix scoring, in participatory  
 epidemiology, 184–185
- McNemar's change test, 260
- Mean, 216  
 arithmetic, 306  
 comparing two means, 252–254  
 geometric, 306
- Measurements, *see* Data, measurements
- Median, 216  
 comparing two medians, 254–258
- Medical records, as sources of data,  
 174, 197–198
- Megatherms, 117
- Mendelian disorders, 78
- Merriam, Clinton Hart, 117
- Mesothelioma, 333, 466
- Mesotherms, 117
- Meta-analysis, 156, 300–304
- Metabolic profiles, 372, 375
- Metaphysical medicine, 3
- Method,  
 of agreement, 43  
 of analogy, 44  
 of concomitant variation, 43–44  
 of difference, 43
- Miasmata (miasmas), 4
- Microchips, in animal identification,  
 50, 172
- Microclimate, *see* Climate
- Micro-epidemiology, 28
- Microparasites,  
 definition, 121  
 mathematical models, 341
- Microtherms, 117
- Military campaigns, spread of disease  
 by, 5, 8
- Milk fever, *see* Parturient paresis
- Milk yields, in productivity schemes,  
 370
- Mill, John Stuart, 41
- Minimal disease methods, 392
- Missing values, in data analysis,  
 196
- Mixed infections, 92–93
- Models, 31  
 biological, 331–339  
 types of, 331–332  
 causal, 40–42  
 mathematical, 340–355  
 types of, 341
- Moduli, 259, 413
- Molecular epidemiology, 27–28
- Monitoring, *see also* Surveillance  
 definition, 30, 168  
 disease, 16  
 environmental carcinogens, 338
- Monte Carlo models, 347–349
- Moraxella bovis*, *see*  
 Keratoconjunctivitis, bovine
- Morbidity,  
 measures of, 53–57  
 true and false changes in, 146
- Mortality,  
 cumulative mortality, 57–58  
 human, 9, 121  
 mortality rate, 58
- Mosquito, in yellow fever,  
 transmission, 131
- Mouse, Lassa virus infection in, 100,  
 144
- Movement, of animals,  
 in control of disease, 387–388  
 as a determinant, 106–107
- Moving averages, *see* Rolling  
 averages
- Multifactorial causes, 40–42
- Multifactorial diseases, 14–15, 75–77,  
 92–93
- Multifactorial inheritance, 78–79
- Mulinomial distribution, 222–223
- Multivariate analysis, 284–288
- Muscle, ecchymoses in, 24
- Mutation, in infectious agents,  
 82–83
- Mycobacterium paratuberculosis*  
 (previously *M. johnei*), *see*  
 Johne's disease
- Mycobacterium tuberculosis*, *see*  
 Tuberculosis; *see also* Badgers,  
 tuberculosis in; Opossums,  
 tuberculosis in
- Mycoplasma* spp., 23, 38  
 determinants, 478
- Myxomatosis, 144
- N**
- Naegleria fowleri*, 82
- NAHMS, *see* National Animal Health  
 Monitoring System
- National Animal Health Monitoring  
 System (US), 208, 209
- National Scrapie Plan (GB), 389–390
- Natural history of disease, 14, 24, 116,  
 209, 394
- Natural law, universe of, 3–4
- Natural models, *see* Spontaneous  
 models
- Nature, balance of, 120
- Navicular disease, 469
- Nebuchadnezzar, 289
- Necrotic enteritis, 478
- Negative (nonreactive) models, 331
- Negative-herd retesting, 325
- Neisseria* spp., 84
- Nematodiriasis, control by natural  
 grazing, 388
- Nematodirus* spp., *see* Nematodiriasis
- Neorickettsia helminthoeca*, 129
- Net Present Value, 365
- Network(s),  
 communications, 202  
 database model, 197  
 general, 127  
 mathematical models using,  
 351–352  
 surveillance, 179, 183
- New Zealand,  
 EpiMAN decision support system,  
 development in, 210  
 leptospirosis in, 44  
 tuberculosis in opossums in, 393,  
 475  
 determinants, 470
- Newcastle disease,  
 determinants, 478  
 outbreaks, 48, 143  
 virulence, 82
- Niches, ecological, 123–124  
 filling, disease control and, 389  
 fundamental, 125  
 realized, 125
- Nidality, 132–133
- Noise, as a determinant, 88
- Nomenclature of disease, 156–157
- Nominal scale of measurement, 153
- Non-parameteric tests, 249
- Nonreactive models, *see* Negative  
 models
- Non-compensating error, 229
- Non-sampling error, 229
- Normal distribution,  
 definition, 217–218  
 approximations, 219–220
- Nosocomial, 132
- Nosocomial infections, 84
- Nosogenic territories, 132

- Nosologia Methodica*, 161  
 Novel infectious diseases, 13  
 Nuer, 3, 184  
 Null hypothesis, 248  
 Nurmi phenomenon, *see* Interference, epidemiological  
 Nuthatches, 124  
 Nutrition, as a determinant, 91  
 Nutritional epidemiology, 28
- O**  
 Obesity, 466  
 Observational studies, 266–288  
   bias, 276–280  
   case-control, 267  
   cohort, 266  
   comparison of types, 268–269  
   confounding, 277–278  
   cross-sectional, 267  
   ecological, 269  
   examples, 463–479  
   longitudinal, 267  
   interaction, 274–276  
   Mantel–Haenszel technique, 278–281  
   matching, 280  
     frequency, 280  
     individual, 280  
   misclassification, 276–277  
   multivariate techniques, 284–288  
     logistic model, 284–288  
   nomenclature, 267  
   parameters estimated in,  
     aetiological fraction, *see*  
       attributable proportion  
     attributable proportion, 273–274  
     attributable risk, 272–273  
     odds ratio, 270–271  
     prevalence ratio, 271  
     rate ratio, *see* relative risk  
     relative odds, *see* odds ratio  
     relative risk, 269–270  
     risk ratio, *see* relative risk  
     *see also* specific parameters  
   power calculation, 282–283  
   prospective, 267  
   retrospective, 267  
   sample size determination,  
     281–282  
   types, 266–267  
   upper confidence limits, 283–284  
 Occam (Ockham), William of, *see*  
   ‘Occam’s razor’  
 ‘Occam’s (Ockham’s) razor’, 37  
 Occupation, as a determinant, 80  
 Odds ratio, 270–271  
   calculation of confidence intervals  
     for, 271–272  
     logarithmic-based method,  
       271–272  
     test-based method, 272  
   calculation of upper confidence  
     limits, 283–284  
   definition, 270  
 Office International des Epizooties, 20,  
   48, 209  
 OIE, *see* Office International des  
   Epizooties  
 Oncogenes, 95  
 Ondiri disease, *see* Bovine petechial  
   fever  
 One-tailed tests, 248–249  
 Opossums, tuberculosis in, 393, 475  
 Opportunistic pathogens, 16, 88  
 Opportunity cost, 358  
 Orbiviruses, antigenic change in, 83  
 Ordinal scale of measurement, 153,  
   293, 307  
 Orf, 479  
*Ornithodoros moubata*, 111  
 Orphan models, 431  
 Origin of Species, *see* Darwin, Charles  
 Osteochondritis, 466  
 Osteochondrosis, 469  
 Osteomalacia, 479  
 Osteosarcoma,  
   in dogs, 81  
   in children, 81  
*Ostertagia* spp., *see* Ostertagiasis  
 Ostertagiasis,  
   control of, by mixed grazing, 388  
   models of, 346–347  
 Outbreak of disease,  
   definition, 48–49  
   investigation, 398–401  
*Oxytrema silicula*, 129  
 Ozone, depletion of, as a determinant,  
   89
- P**  
 Pain, assessment of, 154  
 Pale, soft and exudative pork, 427  
 Pancreatic carcinoma, 463, 466  
 Pancreatitis, 466  
 Pandemics, 47  
 Parallel testing, 323–324  
*Paramecium*, spp., 120  
 Parameter, 215, 412  
 Parametric tests, 249  
 Parasitic mange, 8  
 Parasitism, intracellular, 125–126  
 Paratuberculosis, *see* Johne’s disease  
*Parelaphostrongylus tenuis*, 124  
 Partial farm budgets, 363–364  
 Participatory appraisal, *see*  
   Participatory epidemiology  
 Participatory epidemiology, 27,  
   179–186  
 Participatory mapping, 185  
 Particle:infectivity ratio, 102  
 Parturient paresis, 474  
 Parturition, infection at, 110  
 Parvovirus, canine, 47, 81, 466  
 Passive data collection, 170–171, 179,  
   205  
 Passive surveillance, *see* Surveillance  
 ‘Passports’, horse, 50  
 Pasteur, Louis, 3, 290  
*Pasteurella haemolytica*, 16  
*Pasteurella* spp., in mixed infections, 93  
 Pasteurellosis, 41  
 Patellar dislocation, 466  
 Patent ductus arteriosus, 336–337, 466  
 Pathogenicity, 82  
 Pathogens,  
   characteristics of, 102  
   endogenous, 88  
   exogenous, 88  
   opportunistic, 88  
 PCR, *see* Polymerase chain reaction  
 Pellagra, 289  
 Peptide mapping, 27  
 Percentiles, *see* Centiles  
 Performance-related diagnosis, 17  
 Peritoneal effusions, 463  
 Perkins’ tractors, 290  
 Pet shops, as sources of data, 177  
 Pet-food manufacturers, as sources of  
   data, 177  
 ‘PETS’ travel scheme, 385  
 Pharmaceutical companies, as sources  
   of data, 176  
 Phase variation, 83  
 Pie charts, 224  
 Pig Assurance Scheme (UK), 379  
 Pig Health Scheme (UK), 379  
 PigCHAMP, 208, 374  
 PigORACLE, 210  
 Pigs,  
   adenomatosis, 15  
   atrophic rhinitis, 327–328, 476  
   disease eradication, 392  
   enzootic pneumonia, 272, 278–279,  
     476  
   foot lesions, 90, 91, 476  
   gastric torsion, 91  
   gastroenteritis, 89, 145, 386  
   health and productivity schemes,  
     372–373  
   herd structure, 15  
   leptospirosis, 47, 477  
   lymphosarcoma, 96  
   mortality, 477  
   observational studies, 476–477  
   parvovirus, 17, 77  
   porcine reproductive and  
     respiratory syndrome, 477  
   porcine stress syndrome, 92  
   post-weaning multisystemic  
     wasting syndrome, 477  
   reproductive failure, 77  
   respiratory disease, 271–272,  
     278–279, 476

- Pigs (*cont'd*)  
 stillbirths, 43  
 trichinosis, 477  
 umbilical hernia, 477  
 vaccination, feedback, 386  
*see also* specific diseases in Pigs
- Placebo, 290  
 effect, 290
- Plague(s),  
 biblical, 3  
 definition, 5  
 occurrence, 340
- Plants, relationships between types,  
 126–130
- Plasmids, 83, 84
- Plasmodium* spp., 99
- 'Play the winner' rule, 296
- Pleural effusions, 463
- Pleurisy, in sheep, temporal  
 occurrence, 147–149
- Pleuropneumonia, 6, 23  
 eradication, 8, 384
- Pneumonia,  
 acute bacterial, 56  
 causes, 41  
 enzootic, 272, 278–279, 476  
 in sheep, temporal occurrence,  
 147–149
- Pododermatitis, 478
- Point estimation, 220
- Poisson distribution, 218  
 confidence interval for, 221–222
- Poisson, Siméon-Denis, 218
- Poliovirus immunization, natural, 126
- Pollution, environmental, 337–338
- Polygenic inheritance, 78
- Polymerase chain reaction, 27, 313
- Popper, Karl, 36
- Population(s),  
 competitive exclusion, 123, 389  
 contiguous, 50–52  
 control of, by disease, 121–122  
 control of, implications for disease,  
 123  
 density-dependent competition, 120  
 dispersal, 121  
 distribution, 116–120  
 biomes, 117–120  
 vegetational zones, 116–117  
 experimental, 294  
 group behaviour, 122  
 home range, 122  
 of horses, 50  
 interspecific competition, 123  
 intraspecific competition, 123  
 life zones, 117–119  
 of livestock, 14, 15, 52, 53  
 niches, 120–124  
 predator–prey relationship, 121,  
 129–130  
 pyramids, 79, 127  
 regulation of size, 120–123  
 at risk, 49  
 separated, 52–53  
 serological estimations and  
 comparisons in, 308–311  
 size,  
 competition for food and, 120  
 control by competition, 120  
 estimation of, 50–54  
 logistic equation, 120  
 predation and, 121  
 regulation, 120–123  
 social dominance, 121, 129–130  
 Wynne-Edwards hypothesis,  
 122–123  
 of small animals, 51  
 structure of, 50–53  
 study population, 228  
 surveys of prevalence in, 228–245  
 sympatric species, 124  
 target population, 228  
 of wild animals, 50–52
- Porcine stress syndrome, 92
- PorkCHOP, 210
- Portugal, bluetongue in, 68
- Positivism, 35
- Postcapture myopathy syndrome, 92
- Posterior probability, 35
- Post-test probability, *see* Posterior  
 probability
- Potomac fever, 469
- Pott, Percival, 95
- Poultry,  
 disease eradication, 392  
 observational studies, 477–478  
*see also* specific diseases of poultry
- Poultry Health Scheme (UK), 379
- Poultry slaughterhouses, as sources  
 of data, 173
- Power, statistical,  
 calculation, 282–283  
 definition, 248
- Precipitating factors, 41
- Precision, 159–160, 220  
 of a theory, 354
- Predation, 129–130
- Predators, relation to prey, 121,  
 129–130
- Predictive value, 316–318  
 calculation of confidence intervals  
 for, 317
- Predisposing factors, 41
- Pre-emptive slaughter (culling), 386
- Pregnancy rate, 62
- Premium Cattle Health Scheme  
 (Scotland), 379
- Prepatent period, 101
- Prescriptive screening, 30
- Pre-test probability, *see* Prior  
 probability
- Prevalence ratio, 271
- Prevalence, 53  
 annual, 53  
 calculation of incidence rate from,  
 57  
 confidence intervals for,  
 difference between two samples,  
 261  
 one sample,  
 aggregate-level, 244  
 cluster, 245  
 simple random, 243–244  
 low prevalence, 244  
 small samples, 244  
 stratified, 244–245  
 systematic, 244  
 definition, 53  
 determination of sample size to  
 estimate,  
 difference between two samples,  
 261–262  
 one sample  
 aggregate-level, 241–242  
 cluster, 234–238  
 simple random, 232–234  
 stratified, 234  
 systematic, 234  
 presence of disease, 238–241  
 lifetime, 53  
 period, 53  
 point, 53
- Prevalence models, 341
- Prevalence ratio, 271
- Prevention of disease, 368  
 primary, 384  
 secondary, 384  
 tertiary, 384
- Preventive medicine programmes, 368
- Primary cases, in epidemics, 140
- Primary determinants, 75
- Principle of parsimony, *see* 'Occam's  
 razor'
- Prior probability, 35
- Probability,  
 conditional, 214  
 definition, 214
- Production,  
 as an economic process, 359  
 shortfalls, 370
- Production functions, 359
- Productivity, of cattle, 15
- Professions, characteristics of, 33
- Pro-formas, 198
- Progressive retinal atrophy, 390, 467
- Proportional morbidity rate, 62
- Proportional morbidity ratio, 333
- Proportional piling, in participatory  
 epidemiology, 184–185
- Proportions,  
 confidence interval for,  
 difference between two  
 proportions, 261

- Proportions (*cont'd*)  
  multinomial, proportions,  
  222–223  
  single sample, 221, 243, 315–316  
  sample-size determination,  
  difference between two  
  proportions, 261–262  
  single sample, 232–233  
Prospective studies, 267  
Prospective surveys, 29  
Prostatic hyperplasia, 467  
*Proteus* spp., 84  
Protoporphyrin, 391  
Pruritus, in dogs, 76, 291  
Pruritus, pyrexia, haemorrhagic  
  syndrome, 473  
*Pseudomonas* spp., 84, 106  
Pssitacines, preventive medicine in,  
  379  
Psychosocial epidemiology, 28  
Public health, veterinary, 18  
*Pulex irritans*, 114  
Pulmonary disease, chronic canine,  
  337–338  
Punched cards,  
  feature cards, 198  
  item cards, 198  
Purposive selection, 230  
Pyometra, 283, 467  
Pyramid of numbers, 137
- Q**  
Q fever, 43, 62  
Quantal assay, 307–308  
Quantification,  
  dangers of, 10  
  evolution of, in medicine, 10  
Quantiles, 216  
Quarantine, 5, 106, 385  
Quartiles, 216  
Questionnaires, *see* Surveys  
Quetelet, Adolphe, 10
- R**  
Rabbit haemorrhagic disease, 121  
Rabbit, preventive medicine in, 379  
Rabies,  
  in bats, 39  
  in Chile, 150  
  endemic occurrence, 132  
  eradication, 385  
  in foxes, 101, 123, 137–138, 343–344  
  iatrogenic transmission, 106  
  legal aspects, 397  
  long-term trends, 145  
  in skunks, 69  
  sporadic cases, 47  
  in the US, 69, 145  
Radiation, solar, 89  
Ramazzini, Bernardino, 8  
Random-digit dialling, 229  
Random-effects model, in clinical  
  trials, 302  
Randomization, in clinical trials, 295  
Ranks, *see* Ordinal scale of  
  measurement  
Rapid rural appraisal, *see*  
  Participatory epidemiology  
Rate ratio, *see* Relative risk  
Rates, 61–64  
Ratio scale of measurement, 153  
Ratio(s), 61  
  particle:infectivity, 102  
Rats,  
  leptospirosis and, 130  
  plague and, 4  
  scrub typhus and, 122  
  in synanthropic ecosystems, 130  
Receiver-operating characteristic  
  curve, *see* ROC curve  
Recombination, 83  
Record cards, 198  
Record database model, 196  
Recording schemes,  
  examples, 207–213  
  implementation, 207  
  objectives, 206–207  
  scales of, 204–205  
Redwater, 479  
Reed–Frost model, 140–142, 340  
Reed–Muench titration, 307  
Refinement, definition of, 159  
  of serological tests, 311–312  
‘Refutedness’, of a theory, 354  
Registries, as sources of data,  
  175–176  
Regression analysis, 148–150  
Reinforcing factors, 41  
Related samples, 249  
Relational database model, 197  
Relative odds, *see* Odds ratio  
Relative risk, 269–270  
  calculation of confidence intervals  
  for,  
  logarithmic-based method, 270  
  test-based method, 270  
  calculation of upper confidence  
  limits, 283–284  
  definition, 269–270  
Reliability, 160, 195, 328–329  
Renuus, Vegetus, 5  
Renaissance, The, 47  
Repeat breeder syndrome, 475  
Repeatability, 160, 329  
Reporting systems, *see* Recording  
  schemes  
Reproducibility, 329  
Reproductive failure, in pig herds,  
  77  
Research laboratories, as sources of  
  data, 177  
Residues, antibiotic, 20, 470
- Response rate, in interviews and  
  questionnaires, 191  
Restriction enzyme analysis, 27  
Retained placenta, 475  
Retrospective studies, 267  
Retrospective surveys, 29  
Rhinopneumonitis, 100  
Rhinotracheitis virus, 89  
*Rhipicephalus* spp., 133  
Rickettsiae, 111  
Rimpuf model, 108  
Rinderpest,  
  control, 4, 11, 394  
  economic aspects, 364  
  eradication of, 11  
  sample size determination for,  
  238  
  excretion, 101  
  JP15 campaign, 11  
  military campaigns disseminating,  
  8  
  *Pan-African Campaign*, 14, 238  
  pandemic, 47  
  as a plague, 6–7  
  stimulus for founding veterinary  
  schools, 8  
Ring vaccination, 386  
Risk analysis and assessment, 31,  
  482–502  
  application of diagnostic tests to,  
  325–326  
  microbial, 31  
Risk factors, 39  
Risk indicators, 39  
Risk markers, 39  
Risk ratio, *see* Relative risk  
ROC curve, 321–322  
Rocky Mountain spotted fever, 132  
Rolling (moving) averages, 147–148  
Ross River virus, 102  
Rotaviruses, 103  
Rous, Francis Peyton, 4  
Routes of transmission, of infectious  
  agents, *see* Infection,  
  transmission  
Ruini, Carlo, 5  
Russell, Bertrand, 35, 354
- S**  
Sacrifice, 2  
Salivarian transmission of infection,  
  100  
Salivary cyst, 467  
Salmon poisoning, 128–129  
*Salmonella* spp., *see* Salmonellosis  
Salmonellosis, 42, 88, 132, 389, 475, 477  
Sampling,  
  capture–release–recapture, 50–51  
  in clinical trials, 293–294  
  cluster, 231–232, 234–238, 245  
  convenience, 230

- Sampling (*cont'd*)  
   determination of sample size,  
     232–245, 253–254, 258,  
     261–262, 281–282  
   *see also* appropriate parameter  
   distance, 52  
   error, 228, 410  
   fraction, 229  
   frame, 229  
   imperfect diagnostic tests in, 234,  
     240–241  
   multistage, 232  
   non-probability, 229, 230  
   in observational studies, 266–267,  
     281–282  
   probability, 229, 230–232  
   purposive selection, 230  
   random-digit dialling, 229  
   random numbers, 432–433  
   simple random, 230, 232–234,  
     243–244  
   stratified, 231, 234, 244–245  
   systematic, 230, 234, 244  
   types of, 229–232  
   unit, 229  
   variation, 410  
   with replacement, 240, 432  
   without replacement, 240, 432  
   *see also* Prevalence; Statistics;  
     Surveys  
 Sarcoids, 470  
 Scanning surveillance, *see*  
   Surveillance  
 Scapegoats, 3  
*Schistosoma* spp., *see* Schistosomiasis  
 Schistosomiasis, 124, 128, 171  
 Scholasticism, *see* The Scholastics  
 Scholastics, The, 34  
 Scientific inquiry, role of, in accepting  
   a hypothesis, 36  
 Scientific revolutions, 4–5  
 Scoring schemes/systems, 154–155  
 Scrapie, 113, 389–390, 394  
 Screening, 29–30, 317, 330  
   genetic, 389–390  
   mass, 29  
   prescriptive, 30  
   strategic, 30  
 Screw-worm fly, 106  
   cost–benefit analysis of control of,  
     365–366  
 Scrub typhus, 122, 131  
 Scurvy, early clinical trial, 289  
 Seasonal calendars, in participatory  
   epidemiology, 186  
 Seasonal trends in disease, 144–145  
 Secondary attack rate, 56  
 Secondary cases, in epidemics, 140  
 Selenium, plant uptake by, 116  
 Semi-interquartile range, 217  
 Sensitivity analysis, 348  
 Sensitivity,  
   analytical, 311, 313  
   diagnostic, 158–159, 313–316  
     aggregate-(herd-) level, 323  
     calculation of confidence  
       intervals for, 315–316  
     parallel, 323–324  
     serial, 324–325  
 Sentinels, 170, 333  
 Separated populations, 52–53  
 Sequential-design trials, 296  
 Serial interval, 101  
 Serial measurements, 252  
 Serial testing, 324–325  
 Serological epidemiology,  
   antibody assay,  
     multiple serial dilution, 307–308  
     relative analytical sensitivity of,  
       313  
     single serial dilution, 307  
   Spearman–Kärber titration,  
     307–308  
   titres, 306–307  
     arithmetic mean, 307  
     geometric mean, 307  
   antigenic tolerance, 313  
   definition, 305  
   interpreting tests, 311–313  
   seroconversion, 306  
     calculation of rate of, 309  
   tests, *see* Diagnosis, diagnostic tests  
*Serpulina hyodysenteriae*, 324  
   latent infection in, 87  
 Serum banks,  
   applications, 178  
   collection of serum, 178  
   definition, 177  
   selection bias in, 178  
   as sources of data, 177–178  
 Server, computer, 203  
 Sesamoidean fractures, 467  
 Sex chromosomes, 80  
 Sex, as a determinant, 79–80  
 Sex-influenced inheritance, 80  
 Sex-limited inheritance, 80  
 Sex-linked inheritance, 80  
 Shadow prices, 365  
 Sheep,  
   disease eradication in, 392  
   domestication, 2  
   foot rot, 93  
     efficacy of vaccine against, 293  
   health schemes, 373–375  
   observational studies, 478–479  
   jaw tumours, 65  
   pleurisy, 147–149  
   pneumonia, 147–149  
   *see also* specific diseases of sheep  
 Sheep and Goat Health Scheme (UK),  
   379  
 Sheep pox, introduction of, 8  
 Sheep ticks, populations of, 348–349  
 Shewhart charts, 225–226  
 Shift, in influenza viruses, 83  
 SHIFT veterinary import network,  
   172  
*Shigella* spp., 84  
 Shipping fever, 16, 92  
 Significance,  
   clinical (biological), 250  
   statistical, 250  
   tests, 247–248  
 Silent infection, *see* Inapparent  
   infection  
 Simplicity,  
   of a hypothesis, 37  
   of a theory, 354  
 Simulation models, 345–349  
*Sitta* spp., 124  
 Size, of hosts, as a determinant, 81  
 Skin cancer, coat colour and, 82  
 Skin, infection via, 104  
 Skunks, rabies in, 69  
 Slaughter (culling),  
   as a control measure, 385–386  
   of badgers, tuberculosis and, 14  
 Slow virus diseases, 115  
 Smallpox, 4, 10, 107, 340, 384  
 SMEDI viruses, 77  
 Smith, Theobald, 4  
 Smog, 47  
 Smoking, cause of lung cancer, 44  
 Snails, control of, 124  
 Software, computer, 201  
   veterinary epidemiological  
     packages, 414–417  
 SNOMED, 164–165  
 SNOF, 164  
 SNOVET, 164  
 Snow, John, 44, 356  
 SNVDO, 162  
 Social cost–benefit analysis, *see*  
   Economics of disease  
 Social dominance, 122  
 Social epidemiology, 28  
 Spatial correlation study, 269  
 Spatial distribution of disease, 65–73,  
   150–151  
 Spearman–Kärber titration, 307–308  
 Species, as a determinant, 80–81  
 Specific measures of disease  
   occurrence, 61–63  
 Specificity,  
   analytical, 311  
   diagnostic, 158–159, 311, 313–316  
     aggregate-(herd-) level, 323  
     calculation of confidence  
       intervals for, 315–316  
     parallel, 323–324  
     serial, 324–325  
*Spirocerca lupi*, and oesophageal  
   carcinoma, 96

- Spontaneous (natural) models, 331–332
- Sporadic disease occurrence, 47–48
- Squamous cell carcinoma, in cattle, 24  
in cats, 39, 464
- St Louis encephalitis virus, 170
- Stability, of pathogens, 102
- 'Stamping-out policy', 386, 411  
modified 'stamping-out policy', 411
- Standard deviation, 217
- Standard environmental temperature, 89
- Standard error, definition, 220  
of specific parameter, *see* appropriate parameter
- Standard Nomenclature of Veterinary Diseases and Operations, *see* SNVDO
- Standardized measures of disease occurrence *see* Adjusted measures of disease occurrence
- Standardized morbidity ratio, *see* Adjusted measures of disease occurrence
- Standardized mortality ratio, *see* Adjusted measures of disease occurrence
- Standardized Normal deviate, 217
- Staphylococcus* spp., 472
- Statistical packages, 265, 414–417
- Statistics, *see also* Association; Observational studies; Sampling; Surveys  
asymptotic methods, 220  
basic definitions, 214–215  
binomial distribution, 218  
Normal approximation, 219–220  
centiles, 216  
 $\chi^2$ -distribution, 431  
confidence intervals and limits, 220–223, *see also* specific parameters  
constants, 412  
correlation, 263–264  
correlation coefficient, 462  
degrees of freedom, 220  
descriptive, 215–217  
distributions, 217–220  
errors of inference, 248  
independent and related samples, 249  
interaction, 94–95, 274–276  
interval estimation, 220–221  
*see also* specific parameter  
*kappa* statistic, 327–328  
logistic model, 284–288  
Mantel–Haenszel technique, 278–280  
mean, 216  
measures of position, 216  
measures of spread, 216–217  
median, 216  
multivariate analyses, 264–265, 284–288  
Normal distribution, 217–218  
null hypothesis, 248  
one- and two-tailed tests, 248–249  
parameter, 216  
Poisson distribution, 218  
Normal approximation, 219–220  
power, 248, 282–283  
probability, 214  
quantiles, 216  
quartiles, 216  
random numbers, 432–433  
sample sizes, *see* Sampling, specific parameters  
standard deviation, 217  
standard error, 220  
tests,  $\chi^2$ -test, 258–259  
 $\chi^2$ -test for trend, 262–263  
Fisher's exact test, 259–260  
McNemar's change test, 260  
Wilcoxon–Mann–Whitney test, 254–255  
Wilcoxon signed ranks test, 255–257  
Student's *t*-test, 252  
variables, 381, 214–215  
variance-ratio (*F*) distribution, 480
- Stercorarian transmission of infection, 100
- Sterile immunity, 86
- Stochastic models, 341
- Strangles, 470
- Strategic screening, 30
- Strategic vaccination, 386
- Stratification, in clinical trials, 295  
in observational studies, 278–280  
in surveys, 231
- Streptobacillus* spp., 104
- Streptococcus* spp., 76, 472–473
- Stress, 91–92
- Stressors, *see* Stress
- Student's *t*-distribution, 219, 420
- Student's *t*-test, 252
- Studies, observational, *see* Observational studies
- Subclinical diseases, 85
- Subclinical epidemiology, 28
- Subclinical infection, 85
- Suk, 2
- Summer mastitis, 93
- Suppressive (dampening-down) vaccination, 386
- Surveillance, 168–187  
definition, 168, 169  
goals, 169  
mechanisms, 179, 180–183  
types, active, 170–171  
disease, 170  
epidemiological, 170  
passive, 170–171  
post-authorization drug, 290  
scanning (global), 171  
sentinel, 170  
serological, 170  
syndromic, 171  
targetted, 171
- Survey(s), 28–29, 238–246  
cost, 242  
cross-sectional, 29  
Domesday, 53  
detecting presence of disease, 238–242  
longitudinal, 29  
prevalence, 232–238  
questionnaires, 188–195  
closed questions, 189  
coding, 189  
criteria for success, 195  
design, 189–191  
interviews, 191, 194–195  
mailed and self-completed, 191  
missing values, 196  
presentation and wording, 189  
question structure, 189–191  
response rate, 191  
structure, 188–189  
testing, 195  
types of, 229–232  
*see also* Prevalence; Sampling; Statistics
- Survival, 58–60
- Susceptibility, of hosts, 100
- Sweet itch, 470
- Swine dysentery, 87
- Swine fever, determinants, 477  
eradication, 394
- Sympatric species,
- Synanthropic ecosystems, 130
- Syndrome, definition of, 171
- Synergism, 124  
biological, 94  
statistical, 94
- Synopsis Nosologiae Methodicae*, 161
- Syphacia obvelata*, 46
- Systematized Nomenclature of Veterinary Medicine, *see* SNOVET
- Systematized Nomenclature of Human and Veterinary Medicine, *see* SNOMED
- Systems models, 352

- T**
- Tables, 65
- Tail docking,  
in dogs, 19, 467  
in horses, 19
- Tail-tip necrosis, 475
- Targets, in health schemes, 369–370
- Targeted surveillance, *see* Surveillance
- Taxonomy, microbial, 84–85
- Temporal distribution of disease,  
144–150, 224–227
- Tenacity, role of, in accepting a  
hypothesis, 36
- Territoriality, 122
- Tertiary cases, 56
- 'Test and removal' control strategy,  
385
- 'Testedness', of a theory, 353–354
- Testicular neoplasia, 63, 467
- Texas fever, 4  
eradication of, 384
- Theileriosis, 111
- Theoretical epidemiology, 26
- Theories, 353–354
- 'Theory of Everything', 354
- Threshold levels,  
in diagnostic tests, 306  
in epidemics, 137  
of infectious agents, 102  
of multifactorial traits, 78
- Ticks,  
disease transmission by, 4, 110–111,  
134–135  
in sheep, 348–349
- Time lines, 65
- Time-series analysis, 146–150
- Time trend graphs, 65
- Titre,  
definition, 306  
estimation, 307–308  
logarithmic transformation, 219, 306  
*see also* Serological epidemiology
- Tobacco rattle virus, 84
- Tolerance, immune, 110, 113, 312
- 'Tombstone data', 162
- Topotypes, of foot-and-mouth  
disease, 84
- Toxoplasma gondii*, 113
- Toxoplasmosis, 479
- Traceability, 172–173
- Tracing,  
in infectious disease outbreaks,  
399–400  
systems, 172
- TRACES, 173
- Transduction, 83, 84
- Transference, 3
- Transformation,  
in bacteria, 83, 84  
of eukaryotic cells, 95  
mathematical, 219
- Transgenic biology, 391
- Transmission of disease, *see* Infection,  
transmission
- Treatment of disease, ancient methods  
of, 3
- Trends in disease occurrence,  
spatial, 11, 150–151  
temporal, 144–150  
cyclical, 144–145  
long-term (secular), 145–146  
seasonal, 144–145  
short-term, 144
- Trends in veterinary medicine, 19
- Treponema hyodysenteriae*, *see* *Serpulina*  
*hyodysenteriae*
- Triad, of determinants, 76
- Triangulation, in participatory  
epidemiology, 184
- Trichinella spiralis*, 86, 477
- Trophic levels of food chain, 127
- Trypanosoma* spp., 83, 100
- Trypanosomiasis, 14  
determinants, 475  
eradication, 385  
tolerance, 391  
translocation by cattle, 107
- Tsetse fly, 385
- Tuberculosis,  
bovine, badgers and, 14, 393, 475  
in cattle, 73  
determinants, 475  
eradication, 394  
negative-herd retesting, 325  
in opossums, 393, 475  
in white-tailed deer, 393  
*see also* Badgers
- Tularaemia, landscape epidemiology,  
134
- Tumour registries, as sources of data,  
175
- Tumour-inducing viruses, 95
- Tumours,  
adenocarcinoma, 478  
angiosarcoma, 466  
bladder, 95, 464  
bone, 96, 464  
chemodectoma, 465  
eyelid, 465  
fibrosarcoma, 96, 464  
follicular, 463  
haemangioma/haemangiosarcoma,  
465  
horn, 96  
leukaemia-lymphoma, 463, 466  
mammary, 334, 466, 467  
mastocytoma, 466  
mesothelioma, 333–334, 466  
nasal cavity and paranasal sinuses,  
463  
nervous tissue, 463  
ocular, 474
- oesophageal, 96, 466  
oral and pharyngeal, 466  
pancreatic, 463, 466  
perianal, 467  
prostatic, 467  
renal, 467  
skin, 463  
testicular, 63, 467  
thyroid, 467  
transmissible venereal, 467  
urethral, 467  
various, 463, 466
- Turkeys,  
importation to Europe, 2  
observational studies, 479
- Two-tailed tests, 248–249
- Type I and Type II error, 248
- U**
- Überreiter's syndrome, *see*  
Keratoconjunctivitis,  
superficial, in dogs
- Ultraviolet radiation, as a  
determinant, *see* Solar radiation
- Unapparent infection, *see* Inapparent  
infection
- Uncertainty, in economics, 365
- Uniform Resource Locator, *see* URL
- United Kingdom,  
disease eradication in,  
health schemes in, 392  
national, 378–379  
private, 370–375  
holdings by size of herd, 52  
pig herd structure, 15
- United States,  
heartworm in, 68, 119  
leptospirosis in, 145  
rabies in, 69, 145
- Universal constant, 412
- URL, 203
- USSR, leptospirosis, epidemic in, 140
- Utricularia* spp., 128
- Uveitis, 470
- V**
- Vaccines and vaccination,  
barrier, 386  
early clinical trial of, 290  
efficacy, 292–293  
emergency, 386, 393  
inactive, 386  
live, 386  
natural, 386–387  
new technology, 387  
ring, 386  
strategic, 386  
suppressive (dampening down),  
386, 393  
use in disease control, 386–387,  
392–393



- Vaccines and vaccination (*cont'd*)  
  'vaccinate to live', 393  
  versus slaughter, 392–393
- Validity, 160  
  construct, 155, 292  
  content, 155, 292  
  external, 294  
  internal, 294  
  of mathematical models, 355  
  of questionnaires, 195
- Variables, 38, 214–215
- Variance, 216
- Variance-ratio (*F*) distribution, 480–481
- Variates, 215
- Variolation, 8, 340
- Vectors, types of, 100
- Vegetational physiognomy, 117
- Vegetational zones, 116–117
- Velvet removal, 19
- Vena cava syndrome, 466
- Venezuelan equine encephalitis virus, 170
- Vertical transmission, 110–111
- Veterinarians, employment trends, 17
- Veterinary Investigation Diagnosis Analyses, *see* VIDA II
- Veterinary Medical Data Base, *see* VMDB
- Veterinary Medical Data Program, *see* VMDB
- Veterinary medicine,  
  contemporary, 11–20, 401–402  
  development, 1–20
- Veterinary practices,  
  computerized records in, 174  
  as sources of data, 174
- Veterinary schools,  
  founding of, 8  
  as sources of data, 177
- Vetnet, 211
- VETSTAT, 176
- VIDA II, 210
- Virulence, 26, 82, 102, 411  
  evolution of, in parasites, 128
- Viruses,  
  initiation of cancer by, 96  
  particle-infectivity ratio, 102
- Visual analogue scale, 153–154, 249, 293
- VMDB, 210, 332
- VMDP, *see* VMDB
- Volterra, Vito, *see* Lotka–Volterra equations
- VTVS, 211
- W**
- Wales, pig herd structure in, 15
- Warble fly infestation, 387
- Water buffalo, observational studies in, 479
- 'Web of causation', 42
- Webster, Noah, 4
- White spot disease, 479
- Wilcoxon–Mann–Whitney test, 254–255
- Wilcoxon signed ranks test, 255–257
- William of Occam (Ockham), *see* 'Occam's razor'
- Wind-chill index, 89
- Winter dysentery, 475
- Witches and witchcraft, as causes of disease, 2
- 'Wooden tongue', *see* Actinobacillosis
- Woolf's test for homogeneity, 279
- World Trade Organization, 357
- World Wide Web, 203
- Wynne–Edwards, Vero Copner, *see* 'Wynne–Edwards' hypothesis
- 'Wynne–Edwards' hypothesis, 122–123
- X**
- 'X disease', *see* Hyperkeratosis
- Xerophiles, 117
- Y**
- Yearbooks, as sources of data, 53
- Yellow fever, transmission of, 44, 131, 338
- Yersinia enterocolitica*, 312
- Youatt, William, 3
- Youden's index, 316  
  confidence intervals for, 316
- Z**
- Zoography, 49
- Zoological gardens, as sources of data, 176
- Zoonosis incidence ratio, 62
- Zoonoses, 4, 23, 411



# VETERINARY EPIDEMIOLOGY

THIRD EDITION  
MICHAEL THRUSFIELD

This successful book, now in its third edition, continues to provide a comprehensive introduction to the role of epidemiology in veterinary medicine.

Since the publication of the second edition there has been considerable expansion in the application of veterinary epidemiology: more quantitative methods are available, challenges such as the foot-and-mouth disease epidemic in Europe in 2001 have required epidemiological investigation, and epidemiological analyses have taken on further importance with the emergence of evidence-based veterinary medicine.

In this edition:

- Completely revised and expanded chapters;
- Increased attention given to the principles and concepts of epidemiology, surveillance, and diagnostic-test validation and performance;
- Many examples are drawn from both large and small animal medicine, and from the developing as well as the developed world.
- This paperback edition includes a new section on risk analysis..

*Veterinary Epidemiology* is an invaluable reference source for veterinary general practitioners, government veterinarians, agricultural economists and members of other disciplines interested in animal disease. It will also be essential reading for undergraduate and intermediate-level postgraduate students of epidemiology.

**OTHER BOOKS OF INTEREST:**

**Animal Disease Surveillance and Survey Systems: Methods and Applications**

M D Salman  
9780813810317

**Handbook of Evidence-Based Veterinary Medicine**

P Cockcroft and M Holmes  
9781405108904

**Statistics for Veterinary and Animal Science, Second Edition**

A Petrie and P Watson  
9781405127813



**Blackwell**  
Publishing



Visit us online at  
[www.blackwellpublishing.com](http://www.blackwellpublishing.com)